



**Shenzhen CTA Testing Technology Co., Ltd.**  
 Room 106, Building 1, Yibaolai Industrial Park, Qiaotou Community, Fuhai Street, Bao'an District, Shenzhen, China

**FCC PART 15 SUBPART C TEST REPORT**  
**FCC PART 15.407**

**Report Reference No.....: CTA24061301903**

**FCC ID.....: 2AG7C-BELL5T**

Compiled by

( position+printed name+signature) .: File administrators Jinghua Xiao

Supervised by

( position+printed name+signature) .: Test Engineer Lushan Kong

Approved by

( position+printed name+signature) .: Manager Eric Wang



Date of issue .....: Jun.11, 2024

**Representative Laboratory Name.: Shenzhen CTA Testing Technology Co., Ltd.**

Address .....: Room 106, Building 1, Yibaolai Industrial Park, Qiaotou Community, Fuhai Street, Bao'an District, Shenzhen, China

**Applicant's name.....: Hangzhou Meari Technology Co., Ltd.**

Address .....: Room 604-605, Building 1, No.768 Jianghong Road, Changhe Street, Binjiang District, Hangzhou, Zhejiang, China

**Test specification .....**

Standard.....: **FCC Part 15.407: General technical requirements**

TRF Originator.....: Shenzhen Global Test Service Co.,Ltd.

Master TRF .....: Dated 2014-12

**Shenzhen CTA Testing Technology Co., Ltd. All rights reserved.**

This publication may be reproduced in whole or in part for non-commercial purposes as long as the Shenzhen CTA Testing Technology Co., Ltd. is acknowledged as copyright owner and source of the material. Shenzhen CTA Testing Technology Co., Ltd. takes no responsibility for and will not assume liability for damages resulting from the reader's interpretation of the reproduced material due to its placement and context.

**Test item description .....**

Trade Mark.....: N/A

Manufacturer.....: Hangzhou Meari Technology Co., Ltd.

Model/Type reference.....: Bell 5T

Listed Models.....: Bell 5S, Bell 5F, Bell 8S, Bell 8T, Bell 8F, Bell 9S, Bell 9T, Bell 12S, Bell 12T, WIFICDP10GY, 30828, OSI-DBCAM-AC, EOD1-1002-2K

Operation Frequency.....: From 2412MHz to 2462MHz

Hardware Version.....: BELL5S-T10MB\_F51 REV1\_0

Software Version.....: N/A

Rating.....: DC 5.0V/1.0A by Adapter or AC/DC 12.0V-24.0V

Result.....: **PASS**

# TEST REPORT

<b>Test Report No. :</b> CTA24061301903	Jun.11, 2024
	Date of issue

Equipment under Test : Wireless DoorBell

Model /Type : Bell 5T

Listed model : Bell 5S, Bell 5F, Bell 8S, Bell 8T, Bell 8F, Bell 9S, Bell 9T, Bell 12S, Bell 12T, WIFICDP10GY, 30828, OSI-DBCAM-AC, EOD1-1002-2K

**Applicant** : **Hangzhou Meari Technology Co., Ltd.**

Address : Room 604-605,Building 1,No.768 Jianghong Road,Changhe Street,Binjiang District,Hangzhou,Zhejiang,China

**Manufacturer** : **Hangzhou Meari Technology Co., Ltd.**

Address : 4F of Building 1 and 2-4F of Building 2, No. 91 Chutian Road, Xixing Street, Binjiang District, Hangzhou,Zhejiang,China

<b>Test Result:</b>	<b>PASS</b>
---------------------	-------------

The test report merely corresponds to the test sample.  
It is not permitted to copy extracts of these test result without the written permission of the test laboratory.

## Contents

<b>1.</b>	<b>TEST STANDARDS.....</b>	<b>4</b>
<b>2.</b>	<b>SUMMARY .....</b>	<b>5</b>
2.1.	General Remarks .....	5
2.2.	Product Description .....	5
2.3.	Equipment Under Test .....	6
2.4.	Short description of the Equipment under Test (EUT) .....	6
2.5.	EUT operation mode .....	6
2.6.	Block Diagram of Test Setup.....	7
2.7.	Related Submittal(s) / Grant (s).....	7
2.8.	EUT Exercise Software .....	7
2.9.	Special Accessories .....	7
2.10.	External I/O Cable.....	7
2.11.	Modifications .....	7
<b>3.</b>	<b>TEST ENVIRONMENT.....</b>	<b>8</b>
3.1.	Address of the test laboratory .....	8
3.2.	Test Facility .....	8
3.3.	Environmental conditions .....	8
3.4.	Statement of the measurement uncertainty .....	8
3.5.	Test Description.....	9
3.6.	Equipments Used during the Test.....	11
<b>4.</b>	<b>TEST CONDITIONS AND RESULTS.....</b>	<b>12</b>
4.1.	AC Power Conducted Emission .....	12
4.2.	Radiated Emission.....	15
4.3.	Duty Cycle .....	32
4.4.	Maximum Average Output Power .....	33
4.5.	Power Spectral Density .....	34
4.6.	99% and 6dB Bandwidth .....	35
4.7.	99% and 26dBc Bandwidth .....	36
4.8.	Conducted Spurious Emissions and Band Edge Compliance .....	37
4.9.	Frequency Stability .....	39
4.10.	Antenna Requirement.....	43
<b>5.</b>	<b>TEST SETUP PHOTOS OF THE EUT .....</b>	<b>44</b>
<b>6.</b>	<b>EXTERNAL AND INTERNAL PHOTOS OF THE EUT .....</b>	<b>44</b>

## 1. TEST STANDARDS

The tests were performed according to following standards:

[FCC Rules Part 15.407](#): General technical requirements.

[ANSI C63.10-2020](#): American National Standard for Testing Unlicensed Wireless Devices

[KDB 789033 D02 General U-NII Test Procedures New Rules v02r01](#): UNII, U-NII, U-NII Test Procedures

## 2. SUMMARY

### 2.1. General Remarks

Date of receipt of test sample	:	May.30, 2024
Testing commenced on	:	May.30, 2024
Testing concluded on	:	Jun.11, 2024

### 2.2. Product Description

Product Name	Wireless DoorBell
Trade Mark	N/A
Model/Type reference	Bell 5T
List Models	Bell 5S, Bell 5F, Bell 8S, Bell 8T, Bell 8F, Bell 9S, Bell 9T, Bell 12S, Bell 12T, WIFICDP10GY, 30828, OSI-DBCAM-AC, EOD1-1002-2K
Model Declaration	PCB board, structure and internal of these model(s) are the same, Only the model name different , So no additional models were tested.
Power supply:	DC 5.0V/1.0A by Adapter or AC/DC 12.0V-24.0V
Sample ID	CTA240613019-1# & CTA240613019-2#& CTA240613019-3#
<b>SRD</b>	
Frequency Range	915MHz
Channel Number	1Channel
Modulation Type	OOK
Antenna Description	FPC Antenna, 1.00dBi(Max.)
<b>WIFI(2.4G Band)</b>	
Frequency Range	2412MHz ~ 2462MHz
Channel Spacing	5MHz
Channel Number	11 Channel for 20MHz bandwidth(2412~2462MHz)
Modulation Type	802.11b: DSSS; 802.11g/n: OFDM
<b>WIFI(5.2G/5.3G/5.7G Band)</b>	
Frequency Range	5150MHz ~ 5250MHz, 5250MHz ~ 5350MHz, 5500MHz ~ 5700MHz
Channel Number	4 Channels for 20MHz bandwidth(5180-5240MHz) 4 Channels for 20MHz bandwidth(5260-5320MHz) 11 Channels for 20MHz bandwidth(5500-5700MHz)
Modulation Type	802.11a/n: OFDM
<b>WIFI (5.8G Band)</b>	
Frequency Range	5745MHz ~ 5825MHz
Channel Number	5 channels for 20MHz bandwidth(5745-5825MHz)
Modulation Type	802.11a/n: OFDM
Antenna Description	FPC Antenna, 2.63dBi(Max.) for 2.4G Band and 3.27dBi(Max.) for 5G Band

### 2.3. Equipment Under Test

#### Power supply system utilised

Power supply voltage	:	<input type="radio"/> 230V / 50 Hz	<input type="radio"/> 120V / 60Hz
		<input checked="" type="radio"/> 12 V DC	<input checked="" type="radio"/> 24 V DC
		<input checked="" type="radio"/> Other (specified in blank below)	

#### DC 5.0V

Pre-test at both voltage AC/DC 12V&24V and DC 5V to Adapter, but we only recorded the worst case in this report.( DC 5V to Adapter)

### 2.4. Short description of the Equipment under Test (EUT)

This is a Wireless DoorBell.

For more details, refer to the user’s manual of the EUT.

### 2.5. EUT operation mode

The application provider specific test software to control sample in continuous TX and RX.

Antenna	Chain0 (ANT0)			Chain1 (ANT1)			Simultaneously
Bandwidth Mode	20MHz	40MHz	80MHz	20MHz	40MHz	80MHz	/
IEEE 802.11a	<input checked="" type="checkbox"/>	<input type="checkbox"/>	<input type="checkbox"/>	<input type="checkbox"/>	<input type="checkbox"/>	<input type="checkbox"/>	<input type="checkbox"/>
IEEE 802.11n	<input checked="" type="checkbox"/>	<input type="checkbox"/>	<input type="checkbox"/>	<input type="checkbox"/>	<input type="checkbox"/>	<input type="checkbox"/>	<input type="checkbox"/>

IEEE 802.11a/n20:

UNII-1		UNII-1		UNII-1	
Channel	Frequency (MHz)	Channel	Frequency (MHz)	Channel	Frequency (MHz)
36	5180	38	5190	42	5210
40	5200	46	5230		
44	5220				
48	5240				

U-NI-2A		U-NI-2A		U-NI-2A	
Channel	Frequency (MHz)	Channel	Frequency (MHz)	Channel	Frequency (MHz)
52	5260	54	5270	58	5290
56	5280	62	5310		
60	5300				
64	5320				

U-NI-2C		U-NI-2C		U-NI-2C	
Channel	Frequency (MHz)	Channel	Frequency (MHz)	Channel	Frequency (MHz)
100	5500	102	5510	106	5530
104	5520	110	5550	122	5610
108	5540	118	5590		
112	5560	126	5630		
116	5580	134	5670		
120	5600				
124	5620				
128	5640				
132	5660				
136	5680				
140	5700				

U-NI-3		U-NI-3		U-NI-3	
Channel	Frequency (MHz)	Channel	Frequency (MHz)	Channel	Frequency (MHz)
149	5745	151	5755	155	5775
153	5765	159	5795		
157	5785				
161	5805				
165	5825				

The EUT has been tested under operating condition.

This test was performed with EUT in X, Y, Z position and the worst case was found when EUT in X position.

Worst-case mode and channel used for 9 KHz-1000 MHz radiated emissions was the mode and channel with the highest output power, that was determined to be IEEE 802.11ac VHT20 mode (HCH).

### 2.6. Block Diagram of Test Setup

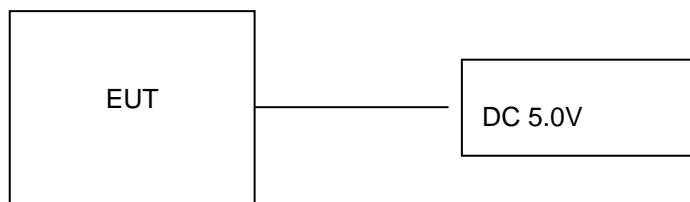

### 2.7. Related Submittal(s) / Grant (s)

This submittal(s) (test report) is intended for **FCC ID: 2AG7C-BELL5T** filing to comply with Section 15.407 of the FCC Part 15, Subpart E Rules.

### 2.8. EUT Exercise Software

The system was configured for testing in a continuous transmits condition and change test channels by software (XCOM V2.2) provided by application.

### 2.9. Special Accessories

Manufacturer	Description	Model	Serial Number	Certificate
SHENZHEN TIANYIN ELECTRONICS CO.,LTD.	Adapter	TPA-46B050100UU	--	SDOC
Zhuzhou Dachuan Electronic Technology Co.,Ltd.	Adapter	DCT07W050100US-C1	--	SDOC

### 2.10. External I/O Cable

I/O Port Description	Quantity	Cable
USB Port	1	1.0M, Unscreened Cable

### 2.11. Modifications

No modifications were implemented to meet testing criteria.

### 3. TEST ENVIRONMENT

#### 3.1. Address of the test laboratory

##### Shenzhen CTA Testing Technology Co., Ltd.

Room 106, Building 1, Yibaolai Industrial Park, Qiaotou Community, Fuhai Street, Bao'an District, Shenzhen, China

#### 3.2. Test Facility

The test facility is recognized, certified, or accredited by the following organizations:

##### **FCC-Registration No.: 517856 Designation Number: CN1318**

Shenzhen CTA Testing Technology Co., Ltd. has been listed on the US Federal Communications Commission list of test facilities recognized to perform electromagnetic emissions measurements.

##### **A2LA-Lab Cert. No.: 6534.01**

Shenzhen CTA Testing Technology Co., Ltd. has been listed by American Association for Laboratory Accreditation to perform electromagnetic emission measurement.

The 3m-Semi anechoic test site fulfils CISPR 16-1-4 according to ANSI C63.10 and CISPR 16-1-4:2010.

#### 3.3. Environmental conditions

During the measurement the environmental conditions were within the listed ranges:

Temperature:	15-35 ° C
Humidity:	30-60 %
Atmospheric pressure:	950-1050mbar

#### 3.4. Statement of the measurement uncertainty

The data and results referenced in this document are true and accurate. The reader is cautioned that there may be errors within the calibration limits of the equipment and facilities. The measurement uncertainty was calculated for all measurements listed in this test report acc. to TR-100028-01 "Electromagnetic compatibility and Radio spectrum Matters (ERM);Uncertainties in the measurement of mobile radio equipment characteristics; Part 1" and TR-100028-02 "Electromagnetic compatibility and Radio spectrum Matters (ERM);Uncertainties in the measurement of mobile radio equipment characteristics; Part 2 " and is documented in the Shenzhen CTA Testing Technology Co., Ltd. quality system acc. to DIN EN ISO/IEC 17025. Furthermore, component and process variability of devices similar to that tested may result in additional deviation. The manufacturer has the sole responsibility of continued compliance of the device.

Hereafter the best measurement capability for Shenzhen CTA Testing Technology Co., Ltd. :

Test	Range	Measurement Uncertainty	Notes
Radiated Emission	9KHz~30MHz	3.02 dB	(1)
Radiated Emission	30~1000MHz	4.06 dB	(1)
Radiated Emission	1~18GHz	5.14 dB	(1)
Radiated Emission	18-40GHz	5.38 dB	(1)
Conducted Disturbance	0.15~30MHz	2.14 dB	(1)
Output Peak power	30MHz~18GHz	0.55 dB	(1)
Power spectral density	/	0.57 dB	(1)
Spectrum bandwidth	/	1.1%	(1)
Radiated spurious emission (30MHz-1GHz)	30~1000MHz	4.10 dB	(1)
Radiated spurious emission (1GHz-18GHz)	1~18GHz	4.32 dB	(1)
Radiated spurious emission (18GHz-40GHz)	18-40GHz	5.54 dB	(1)

This uncertainty represents an expanded uncertainty expressed at approximately the 95% confidence level using a coverage factor of k=2.



### 3.5. Test Description

Applied Standard: FCC Part 15 Subpart E				
FCC Rules	Description of Test	Test Sample	Result	Remark
/	On Time and Duty Cycle	CTA240613019-1#	Compliant	Appendix B Appendix C Appendix D Appendix E
§15.407(a)	Maximum Conducted Output Power	CTA240613019-1#	Compliant	Appendix B Appendix C Appendix D Appendix E
§15.407(a)	Power Spectral Density	CTA240613019-1#	Compliant	Appendix B Appendix C Appendix D Appendix E
§15.407(a)	26dB&6dB Bandwidth and 99% Bandwidth	CTA240613019-1#	Compliant	Appendix B Appendix C Appendix D Appendix E
§15.209, §15.407(b)	Radiated Emissions	CTA240613019-1# CTA240613019-2#	Compliant	Note 1
§15.209, §15.407(b)	Conducted Spurious Emissions and Band Edges Test	CTA240613019-1#	Compliant	Appendix B Appendix C Appendix D Appendix E
§15.209, §15.407(b)	Emissions at Restricted Band	CTA240613019-1#	Compliant	Appendix B Appendix C Appendix D Appendix E
§15.407(g)	Frequency Stability	CTA240613019-1#	Compliant	Note 1
§15.207(a)	AC Mians Line Conducted Emissions	CTA240613019-2#	Compliant	Note 1
§15.203 §15.407(h)	Antenna Requirements	CTA240613019-1#	Compliant	Note 1
§15.407 §2.1091	RF Exposure	/	Compliant	Note 2

Remark:

1. The measurement uncertainty is not included in the test result.
2. NA = Not Applicable; NP = Not Performed
3. Note 1 – Test results inside test report;
4. Note 2 – Test results in other test report (MPE Report).
5. We tested all test mode and recorded worst case in report

Preliminary tests were performed in different data rate to find the worst radiated emission. The data rate shown in the table below is the worst-case rate with respect to the specific test item. Investigation has been done on all the possible configurations for searching the worst cases. The following table is a list of the test modes shown in this test report.

Test Items	Mode	Data Rate
Maximum Peak Conducted Output Power Power Spectral Density 6dB Bandwidth 26dB Bandwidth Radiated Emission 30M~1GHz & Radiated Emission 1GHz~10 <sup>th</sup> Harmonic	802.11a	6 Mbps
	802.11n HT20	MCS0
Band Edge	802.11a	6 Mbps
	802.11n HT20	MCS0

### 3.6. Equipments Used during the Test

Test Equipment	Manufacturer	Model No.	Equipment No.	Calibration Date	Calibration Due Date
LISN	R&S	ENV216	CTA-308	2023/08/02	2024/08/01
LISN	R&S	ENV216	CTA-314	2023/08/02	2024/08/01
EMI Test Receiver	R&S	ESPI	CTA-307	2023/08/02	2024/08/01
EMI Test Receiver	R&S	ESCI	CTA-306	2023/08/02	2024/08/01
Spectrum Analyzer	Agilent	N9020A	CTA-301	2023/08/02	2024/08/01
Spectrum Analyzer	R&S	FSP	CTA-337	2023/08/02	2024/08/01
Vector Signal generator	Agilent	N5182A	CTA-305	2023/08/02	2024/08/01
Analog Signal Generator	R&S	SML03	CTA-304	2023/08/02	2024/08/01
Universal Radio Communication	CMW500	R&S	CTA-302	2023/08/02	2024/08/01
Temperature and humidity meter	Chigo	ZG-7020	CTA-326	2023/08/02	2024/08/01
Ultra-Broadband Antenna	Schwarzbeck	VULB9163	CTA-310	2023/10/17	2024/10/16
Horn Antenna	Schwarzbeck	BBHA 9120D	CTA-309	2023/10/13	2024/10/12
Loop Antenna	Zhinan	ZN30900C	CTA-311	2023/10/17	2024/10/16
Horn Antenna	Beijing Hangwei Dayang	OBH100400	CTA-336	2021/08/07	2024/08/06
Antenna Tower	Suzhou Keletuo electronic Technology Co., LTD	BK-*AT-BS	N/A	N/A	N/A
Amplifier	Schwarzbeck	BBV 9745	CTA-312	2023/08/02	2024/08/01
Amplifier	Taiwan chengyi	EMC051845B	CTA-313	2023/08/02	2024/08/01
Directional coupler	NARDA	4226-10	CTA-303	2023/08/02	2024/08/01
High-Pass Filter	XingBo	XBLBQ-GTA18	CTA-402	2023/08/02	2024/08/01
High-Pass Filter	XingBo	XBLBQ-GTA27	CTA-403	2023/08/02	2024/08/01
Automated filter bank	Tonscend	JS0806-F	CTA-404	2023/08/02	2024/08/01
Power Sensor	Agilent	U2021XA	CTA-405	2023/08/02	2024/08/01
Amplifier	Schwarzbeck	BBV9719	CTA-406	2023/08/02	2024/08/01

Note: The Cal.Interval was one year.

## 4. TEST CONDITIONS AND RESULTS

### 4.1. AC Power Conducted Emission

#### TEST CONFIGURATION

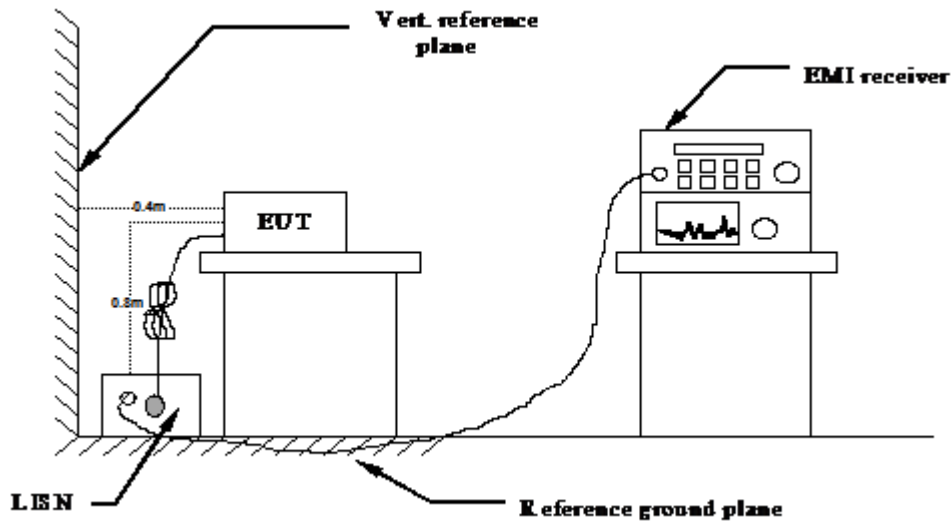

#### TEST PROCEDURE

- 1 The equipment was set up as per the test configuration to simulate typical actual usage per the user's manual. The EUT is a tabletop system, a wooden table with a height of 0.8 meters is used and is placed on the ground plane as per ANSI C63.10-2013.
- 2 Support equipment, if needed, was placed as per ANSI C63.10-2013
- 3 All I/O cables were positioned to simulate typical actual usage as per ANSI C63.10-2013
- 4 All support equipments received AC power from a second LISN, if any.
- 5 The EUT test program was started. Emissions were measured on each current carrying line of the EUT using a spectrum Analyzer / Receiver connected to the LISN powering the EUT. The LISN has two monitoring points: Line 1 (Hot Side) and Line 2 (Neutral Side). Two scans were taken: one with Line 1 connected to Analyzer / Receiver and Line 2 connected to a 50 ohm load; the second scan had Line 1 connected to a 50 ohm load and Line 2 connected to the Analyzer / Receiver.
- 6 Analyzer / Receiver scanned from 150 KHz to 30MHz for emissions in each of the test modes.
- 7 During the above scans, the emissions were maximized by cable manipulation.

#### AC Power Conducted Emission Limit

For intentional device, according to § 15.207(a) AC Power Conducted Emission Limits is as following :

Frequency range (MHz)	Limit (dBuV)	
	Quasi-peak	Average
0.15-0.5	66 to 56*	56 to 46*
0.5-5	56	46
5-30	60	50

\* Decreases with the logarithm of the frequency.

#### DISTURBANCE Calculation

The AC mains conducted disturbance is calculated by adding the 10dB Pulse Limiter and Cable Factor and Duty Cycle Correction Factor (if any) from the measured reading. The basic equation with a sample calculation is as follows:

$$CD \text{ (dBuV)} = RA \text{ (dBuV)} + PL \text{ (dB)} + CL \text{ (dB)}$$

Where CD = Conducted Disturbance	CL = Cable Attenuation Factor (Cable Loss)
RA = Reading Amplitude	PL = 10 dB Pulse Limiter Factor

**TEST RESULTS**

Remark: We measured Conducted Emission at all mode in AC 120V/60Hz, the worst case was recorded .

Temperature	25°C	Humidity	60%
Test Engineer	Lushan Kong	Configurations	IEEE 802.11ac20 HCH

**Adapter: TPA-46B050100UU**

Power supply:	AC 120V/60Hz	Polarization	L
---------------	--------------	--------------	---

Test Graph

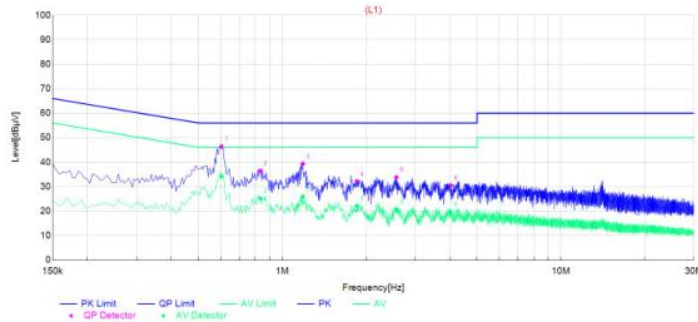

Final Data List

NO.	Frequency	QP Reading	AVG. Reading	Factor	QP Result	AVG. Result	QP Limit	AVG. Limit	QP Margin	AVG. Margin	Line	Remark
1	0.6045	36.22	23.94	10.19	46.41	34.13	56.00	46.00	9.59	11.87	L1	PASS
2	0.834	26.18	14.88	10.24	36.42	25.12	56.00	46.00	19.58	20.88	L1	PASS
3	1.185	29.12	15.66	10.21	39.33	25.87	56.00	46.00	16.67	20.13	L1	PASS
4	1.851	21.91	11.84	10.26	32.17	22.10	56.00	46.00	23.83	23.90	L1	PASS
5	2.5665	23.50	10.36	10.31	33.81	20.67	56.00	46.00	22.19	25.33	L1	PASS
6	4.02	20.09	9.34	10.37	30.46	19.71	56.00	46.00	25.54	26.29	L1	PASS

Note:1. Result (dBµV) = Reading (dBµV) + Factor (dB).

2. Factor (dB) = Cable loss (dB) + LISN Factor (dB).

Power supply:	AC 120V/60Hz	Polarization	N
---------------	--------------	--------------	---

Test Graph

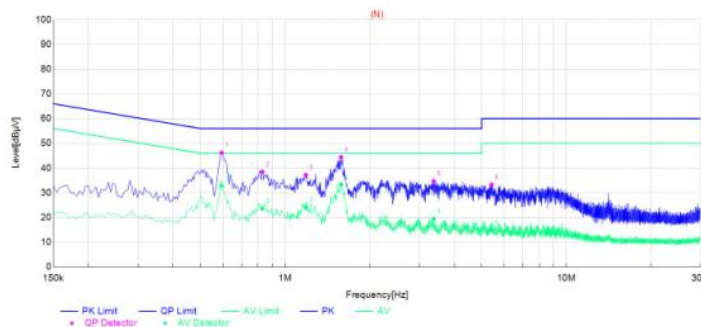

Final Data List

NO.	Frequency	QP Reading	AVG. Reading	Factor	QP Result	AVG. Result	QP Limit	AVG. Limit	QP Margin	AVG. Margin	Line	Remark
1	0.5955	36.00	22.56	10.19	46.19	32.75	56.00	46.00	9.81	13.25	N	PASS
2	0.8295	28.20	13.37	10.24	38.44	23.61	56.00	46.00	17.56	22.39	N	PASS
3	1.185	26.99	13.90	10.21	37.20	24.11	56.00	46.00	18.80	21.89	N	PASS
4	1.581	34.12	23.08	10.24	44.36	33.32	56.00	46.00	11.64	12.68	N	PASS
5	3.3765	24.38	9.08	10.35	34.73	19.43	56.00	46.00	21.27	26.57	N	PASS
6	5.4195	22.84	4.54	10.40	33.24	14.94	60.00	50.00	26.76	35.06	N	PASS

Note:1. Result (dBµV) = Reading (dBµV) + Factor (dB).

2. Factor (dB) = Cable loss (dB) + LISN Factor (dB).

Adapter: DCT07W050100US-C1

Power supply:	AC 120V/60Hz	Polarization	L
---------------	--------------	--------------	---

Test Graph

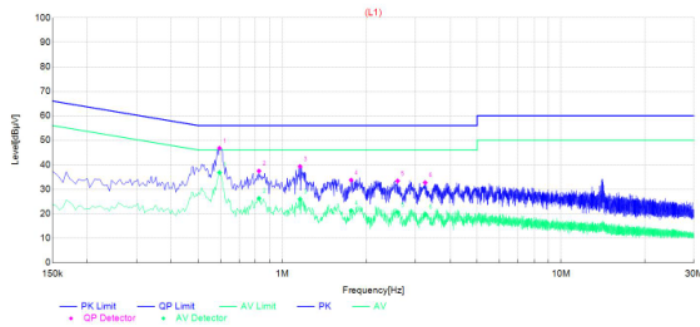

Final Data List

NO.	Frequency	QP	AVG.	Factor	QP	AVG.	QP	AVG.	QP	AVG.	Line	Remark
		Reading	Reading		Result	Result		Limit		Limit		
1	0.5955	36.55	26.60	10.19	46.74	36.79	56.00	46.00	9.26	9.21	L1	PASS
2	0.825	27.19	16.02	10.24	37.43	26.26	56.00	46.00	18.57	19.74	L1	PASS
3	1.158	29.04	15.71	10.21	39.25	25.92	56.00	46.00	16.75	20.08	L1	PASS
4	1.7655	23.47	11.01	10.25	33.72	21.26	56.00	46.00	22.28	24.74	L1	PASS
5	2.5935	23.06	10.28	10.31	33.37	20.59	56.00	46.00	22.63	25.41	L1	PASS
6	3.255	22.32	9.30	10.35	32.67	19.65	56.00	46.00	23.33	26.35	L1	PASS

Note:1. Result (dBμV) = Reading (dBμV) + Factor (dB).

2. Factor (dB) = Cable loss (dB) + LISN Factor (dB).

Power supply:	AC 120V/60Hz	Polarization	N
---------------	--------------	--------------	---

Test Graph

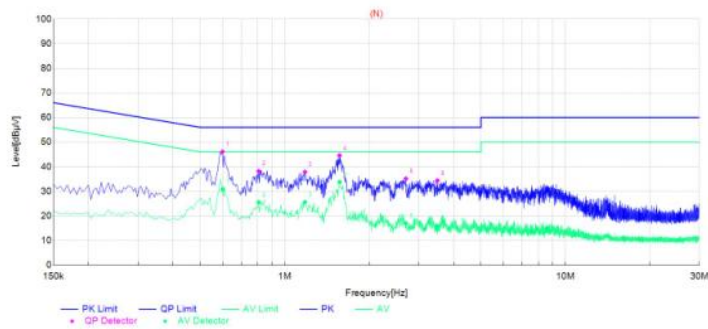

Final Data List

NO.	Frequency	QP	AVG.	Factor	QP	AVG.	QP	AVG.	QP	AVG.	Line	Remark
		Reading	Reading		Result	Result		Limit		Limit		
1	0.6	35.91	20.63	10.19	46.10	30.82	56.00	46.00	9.90	15.18	N	PASS
2	0.807	27.95	15.33	10.25	38.20	25.58	56.00	46.00	17.80	20.42	N	PASS
3	1.1805	27.67	15.42	10.21	37.88	25.63	56.00	46.00	18.12	20.37	N	PASS
4	1.5675	34.31	23.57	10.24	44.55	33.81	56.00	46.00	11.45	12.19	N	PASS
5	2.7015	24.78	6.64	10.32	35.10	16.96	56.00	46.00	20.90	29.04	N	PASS
6	3.498	24.00	5.51	10.35	34.35	15.86	56.00	46.00	21.65	30.14	N	PASS

Note:1. Result (dBμV) = Reading (dBμV) + Factor (dB).

2. Factor (dB) = Cable loss (dB) + LISN Factor (dB).

## 4.2. Radiated Emission

### TEST CONFIGURATION

Frequency range 9 KHz – 30MHz

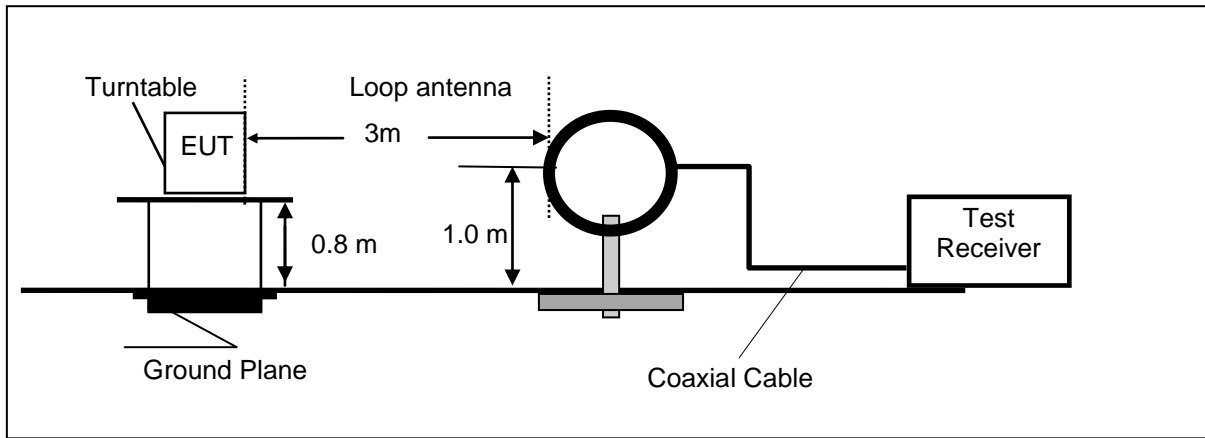

Frequency range 30MHz – 1000MHz

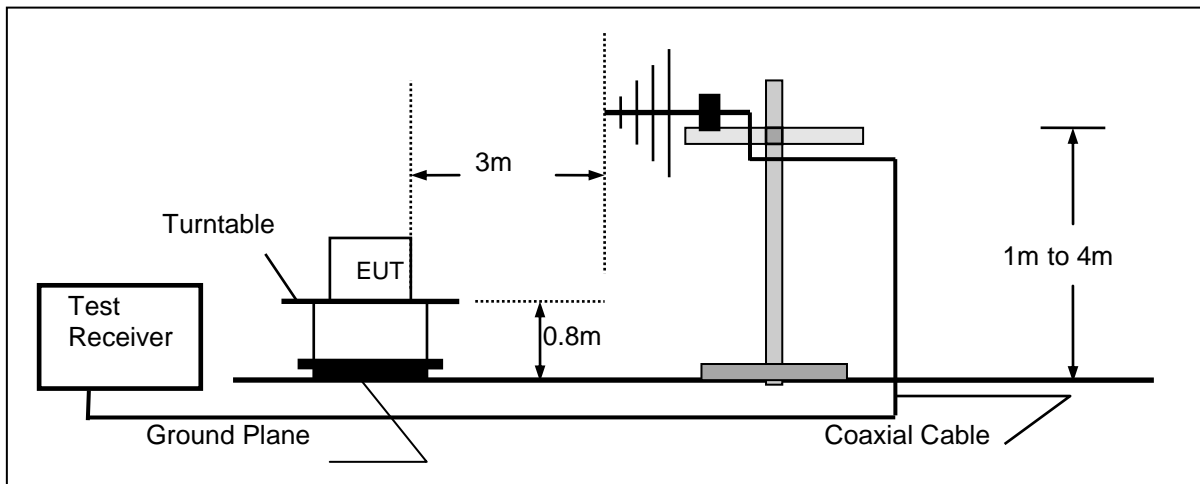

Frequency range above 1GHz

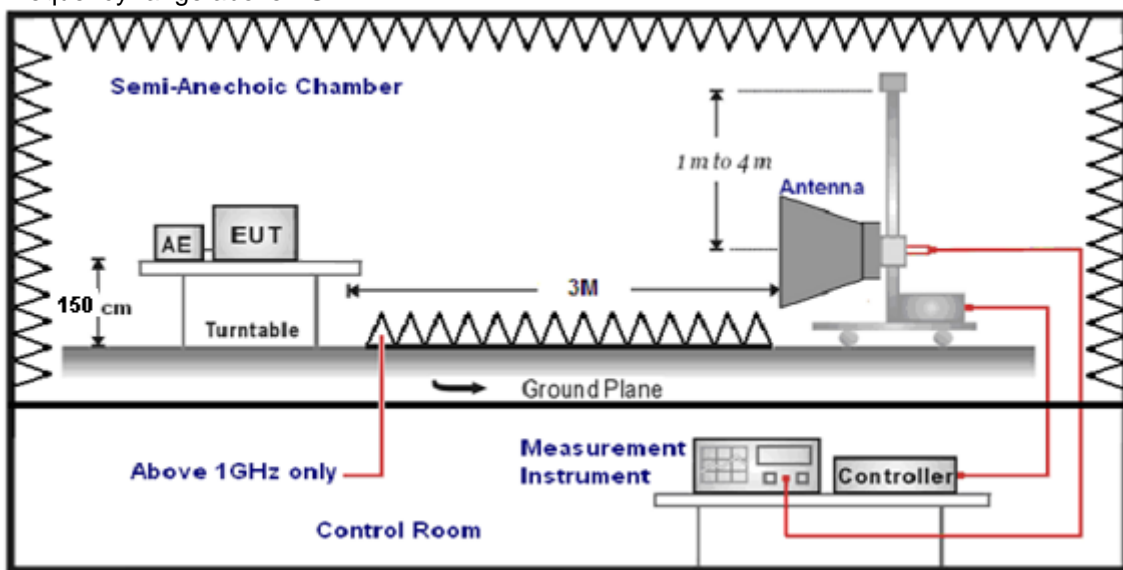

**TEST PROCEDURE**

1. The EUT was placed on a turn table which is 0.8m above ground plane when testing frequency range 9 KHz –1GHz;the EUT was placed on a turn table which is 1.5m above ground plane when testing above 1GHz.
2. Maximum procedure was performed by raising the receiving antenna from 1m to 4m and rotating the turn table from 0° to 360° to acquire the highest emissions from EUT.
3. And also, each emission was to be maximized by changing the polarization of receiving antenna both horizontal and vertical.
4. Repeat above procedures until all frequency measurements have been completed.
5. The EUT minimum operation frequency was 24MHz and maximum operation frequency was 5825MHz.so radiated emission test frequency band from 9KHz to 40GHz.
6. The distance between test antenna and EUT as following table states:

Test Frequency range	Test Antenna Type	Test Distance
9KHz-30MHz	Active Loop Antenna	3
30MHz-1GHz	Ultra-Broadband Antenna	3
1GHz-18GHz	Double Ridged Horn Antenna	3
18GHz-25GHz	Horn Antenna	1

7. Setting test receiver/spectrum as following table states:

Test Frequency range	Test Receiver/Spectrum Setting	Detector
9KHz-150KHz	RBW=200Hz/VBW=3KHz, Sweep time=Auto	QP
150KHz-30MHz	RBW=9KHz/VBW=100KHz, Sweep time=Auto	QP
30MHz-1GHz	RBW=120KHz/VBW=1000KHz, Sweep time=Auto	QP
1GHz-40GHz	Peak Value: RBW=1MHz/VBW=3MHz, Sweep time=Auto Average Value: RBW=1MHz/VBW=10Hz, Sweep time=Auto	Peak

**Field Strength Calculation**

The field strength is calculated by adding the Antenna Factor and Cable Factor and subtracting the Amplifier Gain and Duty Cycle Correction Factor(if any) from the measured reading. The basic equation with a sample calculation is as follows:

**FS = RA + AF + CL - AG**

Where FS = Field Strength	CL = Cable Attenuation Factor (Cable Loss)
RA = Reading Amplitude	AG = Amplifier Gain
AF = Antenna Factor	

Transd=AF +CL-AG



**RADIATION LIMIT**

According to §15.407 (b): Except as shown in paragraph (b)(7) of this section, the maximum emissions outside of the frequency bands of operation shall be attenuated in accordance with the following limits

Frequency (MHz)	EIRP Limit (dBm)	Equivalent Field Strength at 3m (dBµV/m)
5150-5250	-27	68.2
5250-5350	-27	68.2
5470-5725	-27	68.2
5725-5850	-27 (beyond 10MHz of the bandedge)	68.2
	-17 (within 10 MHz of band edge)	78.2

Frequency (MHz)	Distance (Meters)	Radiated (dBµV/m)	Radiated (µV/m)
0.009-0.49	3	$20\log(2400/F(KHz))+40\log(300/3)$	2400/F(KHz)
0.49-1.705	3	$20\log(24000/F(KHz))+ 40\log(30/3)$	24000/F(KHz)
1.705-30	3	$20\log(30)+ 40\log(30/3)$	30
30-88	3	40.0	100
88-216	3	43.5	150
216-960	3	46.0	200
Above 960	3	54.0	500

**TEST RESULTS**

Remark: We measured Radiated Emission at all mode from 9KHz to 25GHz in AC 120V/60Hz and the worst case was recorded.

Temperature	23.4°C	Humidity	54.5%
Test Engineer	Lushan Kong	Configurations	IEEE 802.11ac20 HCH

**For 9 KHz~30MHz**

Freq. (MHz)	Level (dBuV)	Over Limit (dB)	Over Limit (dBuV)	Remark
-	-	-	-	See Note

Note:

The amplitude of spurious emissions which are attenuated by more than 20 dB below the permissible value has no need to be reported.

Distance extrapolation factor =  $40 \log(\text{specific distance} / \text{test distance})$  (dB);

Limit line = specific limits (dBuV) + distance extrapolation factor.

Adapter: TPA-46B050100UU

For 30MHz-1GHz

Horizontal

Test Graph

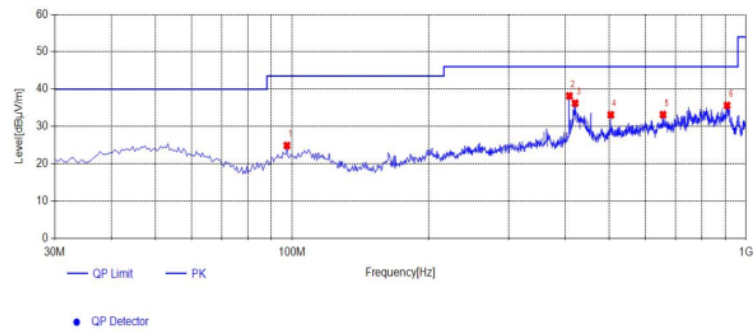

Suspected List

NO.	Frequency [MHz]	Reading [dBµV/m]	Factor [dB]	Result [dBµV/m]	Limit [dBµV/m]	Margin [dB]	Height [cm]	Angle [°]	Detector	Polarity	Remark
1	97.415	29.79	-4.93	24.86	43.50	18.64	100	265	PK	Horizontal	PASS
2	408.3	37.49	0.69	38.18	46.00	7.82	100	282	PK	Horizontal	PASS
3	420.425	35.26	0.96	36.22	46.00	9.78	100	259	PK	Horizontal	PASS
4	503.845	30.74	2.37	33.11	46.00	12.89	100	259	PK	Horizontal	PASS
5	656.62	27.62	5.54	33.16	46.00	12.84	100	2	PK	Horizontal	PASS
6	908.82	27.43	8.19	35.62	46.00	10.38	100	265	PK	Horizontal	PASS

Note:1. Result (dBµV/m) = Reading(dBµV/m) + Factor (dB) .

2. Factor (dB) = Antenna Factor (dB/m) + Cable loss (dB) - Pre Amplifier gain (dB).

Vertical

Test Graph

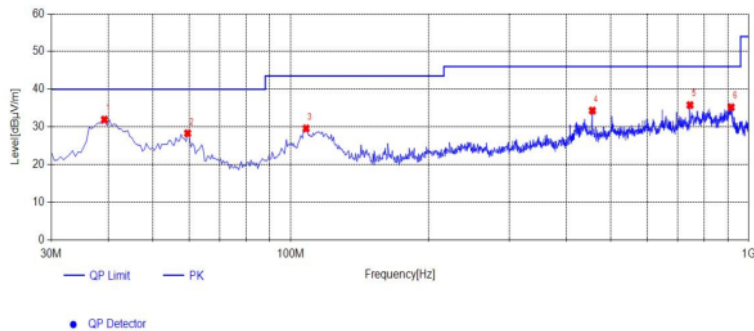

Suspected List

NO.	Frequency [MHz]	Reading [dBµV/m]	Factor [dB]	Result [dBµV/m]	Limit [dBµV/m]	Margin [dB]	Height [cm]	Angle [°]	Detector	Polarity	Remark
1	39.215	36.60	-4.68	31.92	40.00	8.08	100	328	PK	Vertical	PASS
2	59.585	32.78	-4.48	28.30	40.00	11.70	100	137	PK	Vertical	PASS
3	108.085	33.54	-3.97	29.57	43.50	13.93	100	259	PK	Vertical	PASS
4	455.83	33.21	1.11	34.32	46.00	11.68	100	328	PK	Vertical	PASS
5	744.405	29.10	6.69	35.79	46.00	10.21	100	266	PK	Vertical	PASS
6	915.61	26.90	8.30	35.20	46.00	10.80	100	233	PK	Vertical	PASS

Note:1. Result (dBµV/m) = Reading(dBµV/m) + Factor (dB) .

2. Factor (dB) = Antenna Factor (dB/m) + Cable loss (dB) - Pre Amplifier gain (dB).

Adapter: DCT07W050100US-C1

For 30MHz-1GHz

Horizontal

Test Graph

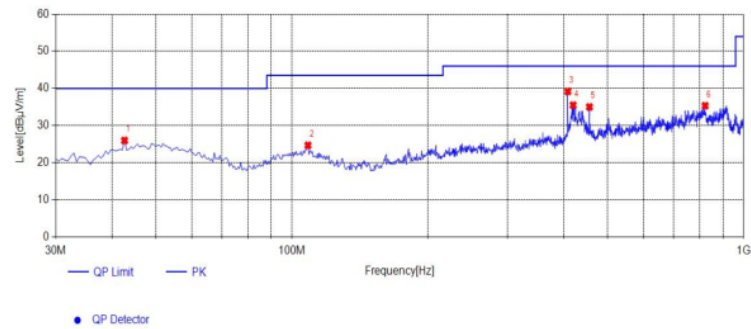

Suspected List

NO.	Frequency [MHz]	Reading [dBµV/m]	Factor [dB]	Result [dBµV/m]	Limit [dBµV/m]	Margin [dB]	Height [cm]	Angle [°]	Detector	Polarity	Remark
1	42.61	29.67	-3.71	25.96	40.00	14.04	100	69	PK	Horizontal	PASS
2	108.57	28.75	-4.09	24.66	43.50	18.84	100	190	PK	Horizontal	PASS
3	408.3	38.50	0.69	39.19	46.00	6.81	100	284	PK	Horizontal	PASS
4	419.455	34.57	0.92	35.49	46.00	10.51	100	242	PK	Horizontal	PASS
5	455.83	33.89	1.11	35.00	46.00	11.00	100	56	PK	Horizontal	PASS
6	822.005	28.18	7.14	35.32	46.00	10.68	100	112	PK	Horizontal	PASS

Note:1. Result (dBµV/m) = Reading(dBµV/m) + Factor (dB) .

2. Factor (dB) = Antenna Factor (dB/m) + Cable loss (dB) - Pre Amplifier gain (dB).

Vertical

Test Graph

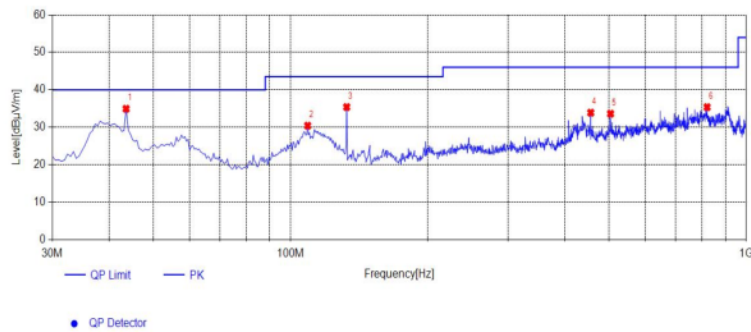

Suspected List

NO.	Frequency [MHz]	Reading [dBµV/m]	Factor [dB]	Result [dBµV/m]	Limit [dBµV/m]	Margin [dB]	Height [cm]	Angle [°]	Detector	Polarity	Remark
1	43.58	38.42	-3.49	34.93	40.00	5.07	100	250	PK	Vertical	PASS
2	109.055	34.64	-4.22	30.42	43.50	13.08	100	303	PK	Vertical	PASS
3	132.82	43.50	-8.11	35.39	43.50	8.11	100	2	PK	Vertical	PASS
4	455.83	32.78	1.11	33.89	46.00	12.11	100	360	PK	Vertical	PASS
5	503.845	31.24	2.37	33.61	46.00	12.39	100	118	PK	Vertical	PASS
6	820.55	28.26	7.11	35.37	46.00	10.63	100	98	PK	Vertical	PASS

Note:1. Result (dBµV/m) = Reading(dBµV/m) + Factor (dB) .

2. Factor (dB) = Antenna Factor (dB/m) + Cable loss (dB) - Pre Amplifier gain (dB).

For Greater than 1GHz

5150-5250MHz:

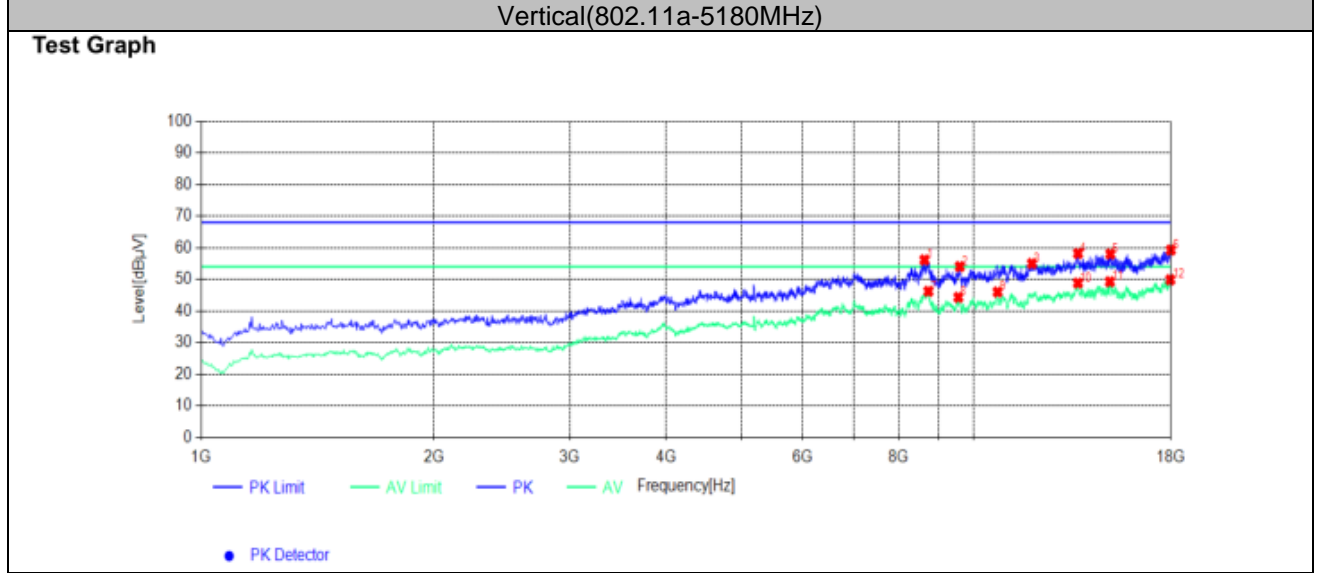
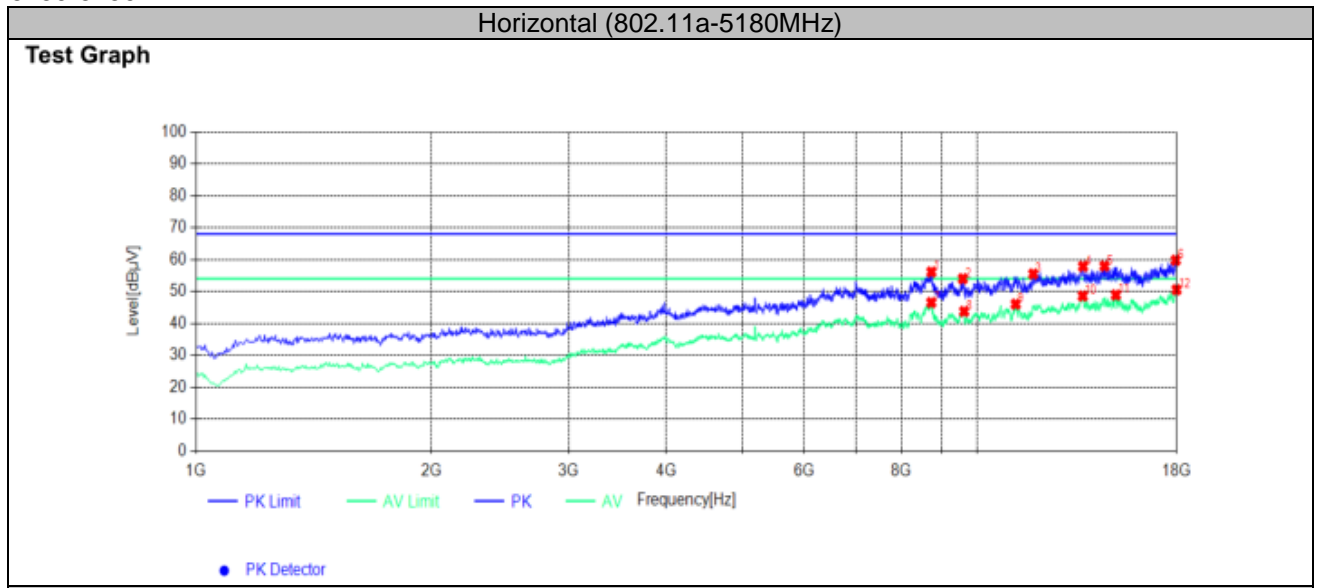

Horizontal (802.11a-5200MHz)

Test Graph

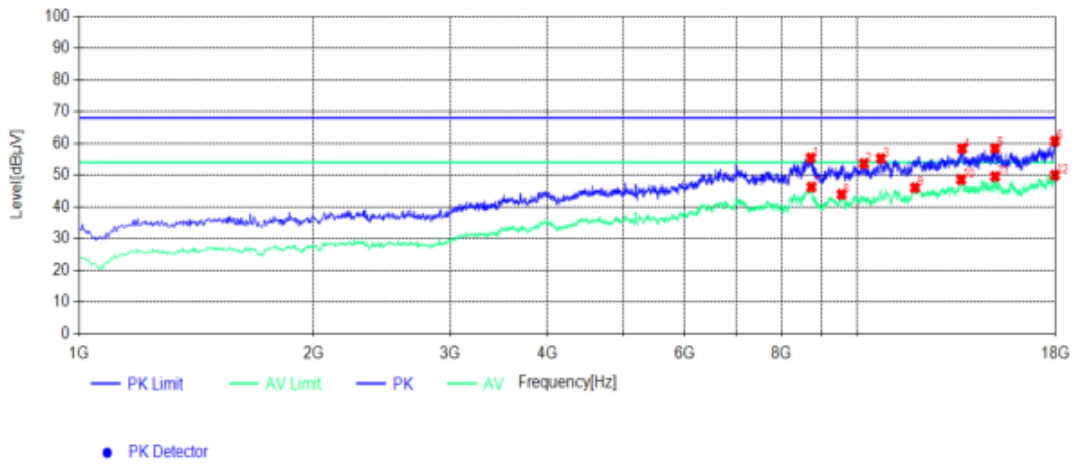

Vertical(802.11a-5200MHz)

Test Graph

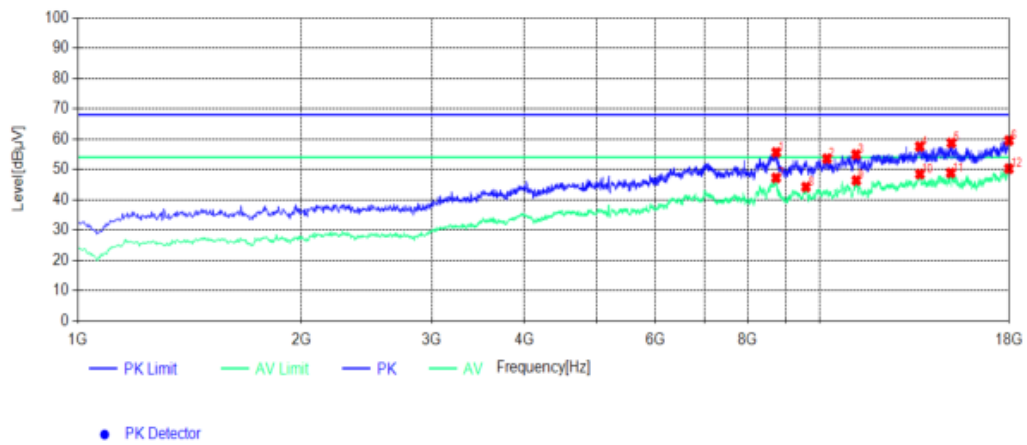

Horizontal (802.11a-5240MHz)

Test Graph

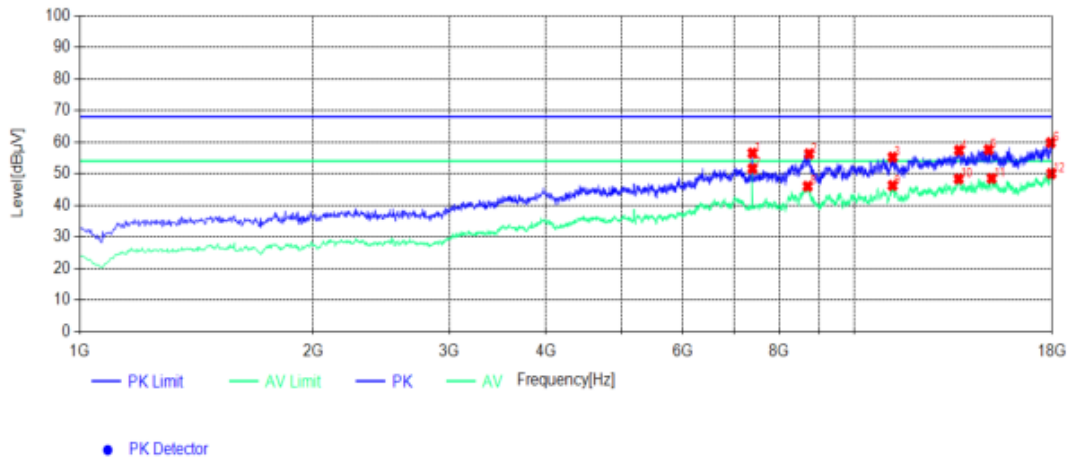

Vertical(802.11a-5240MHz)

Test Graph

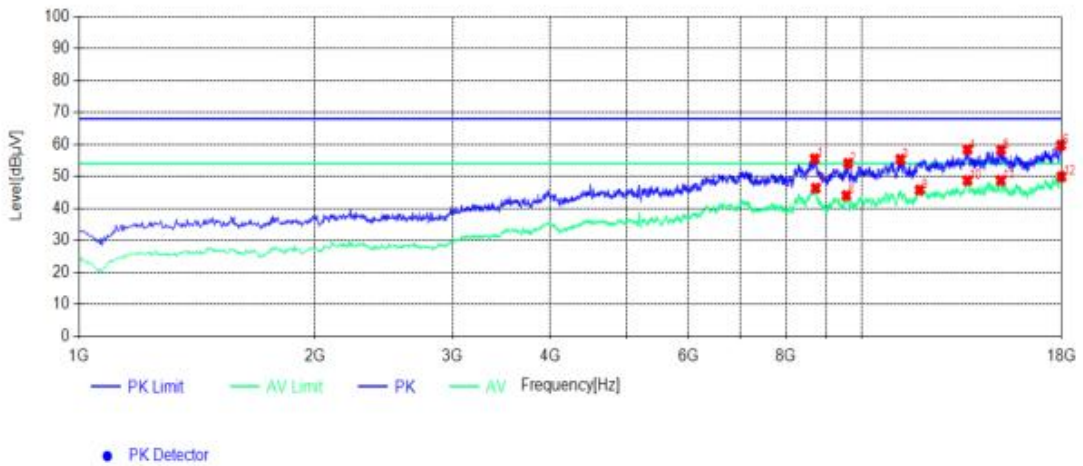

5260-5320MHz:

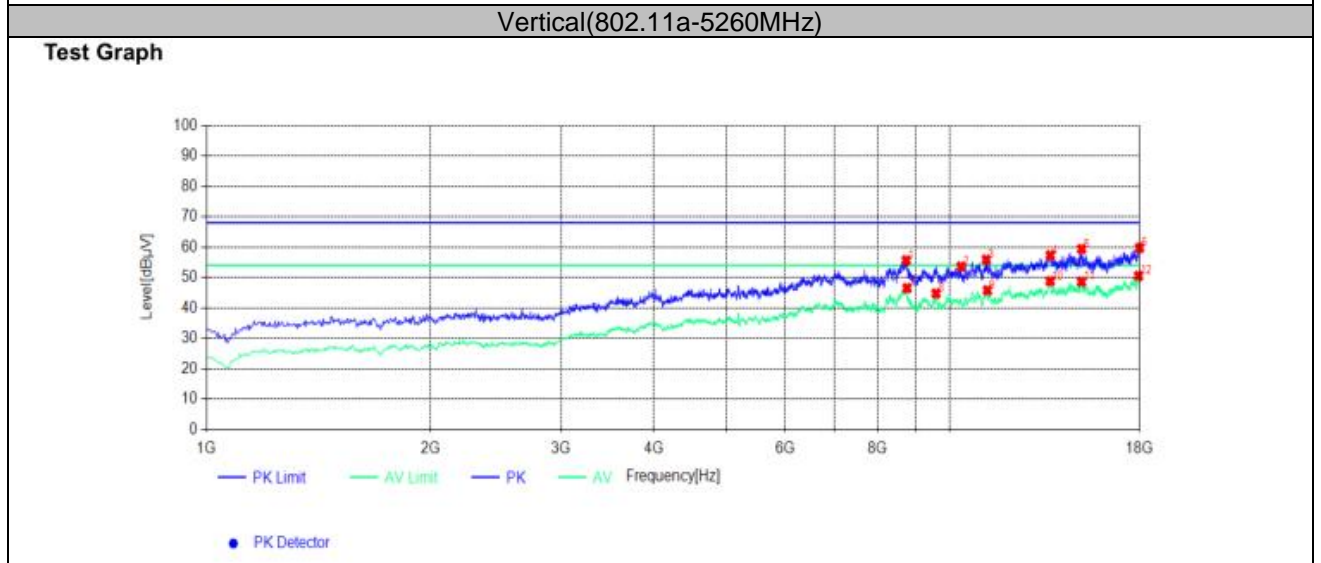
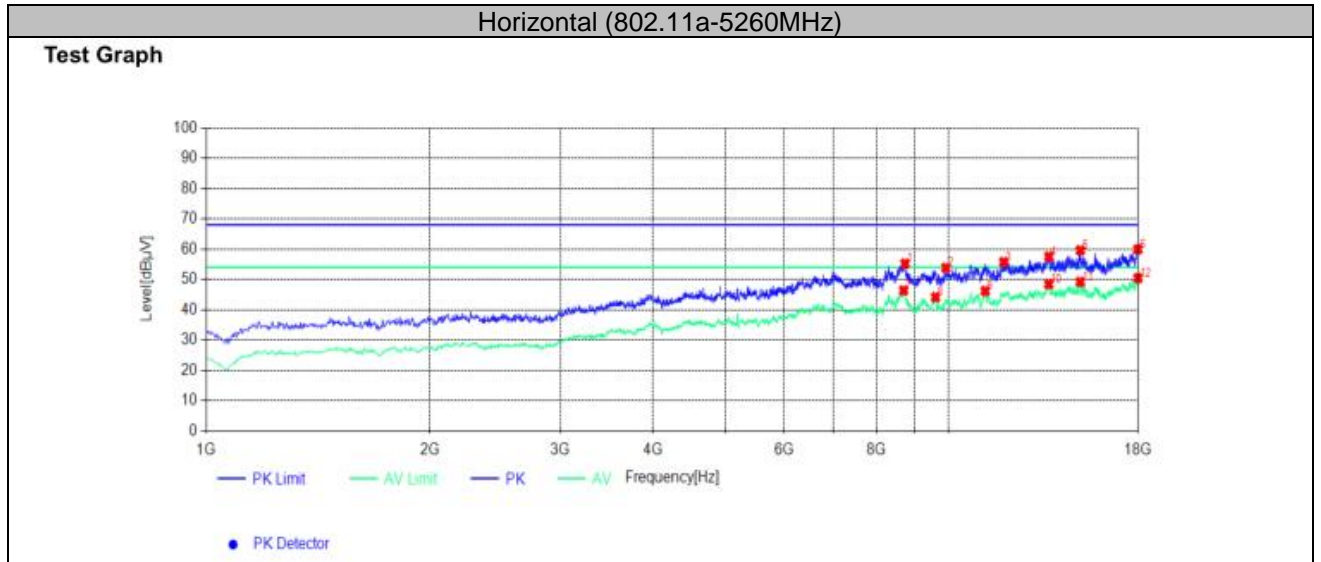

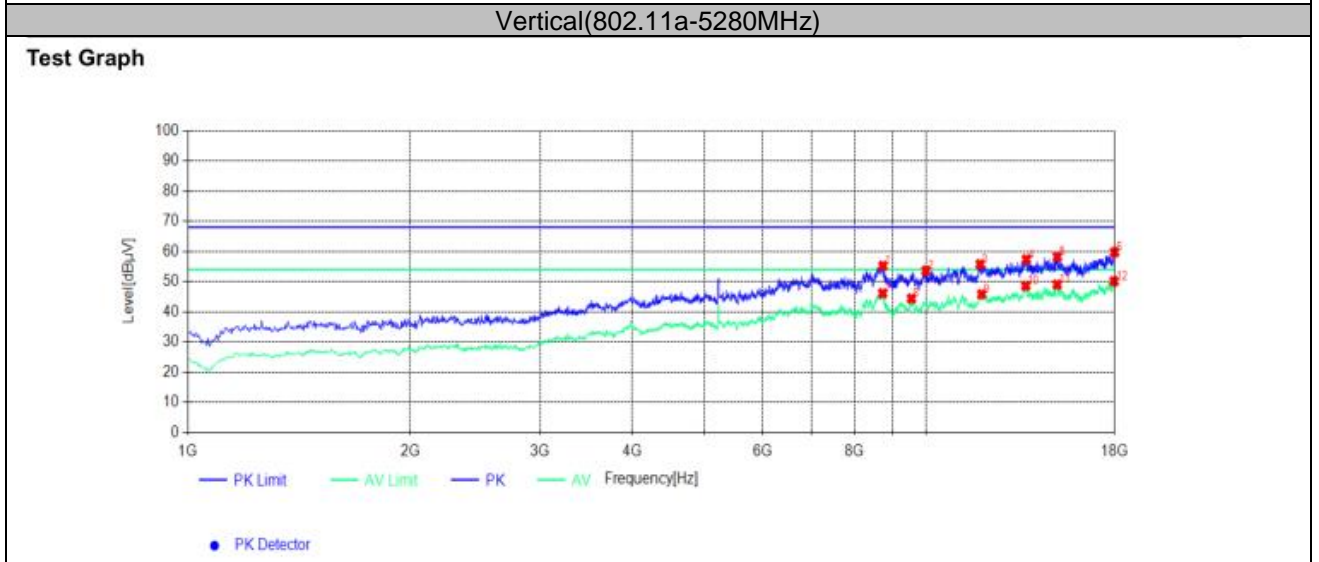
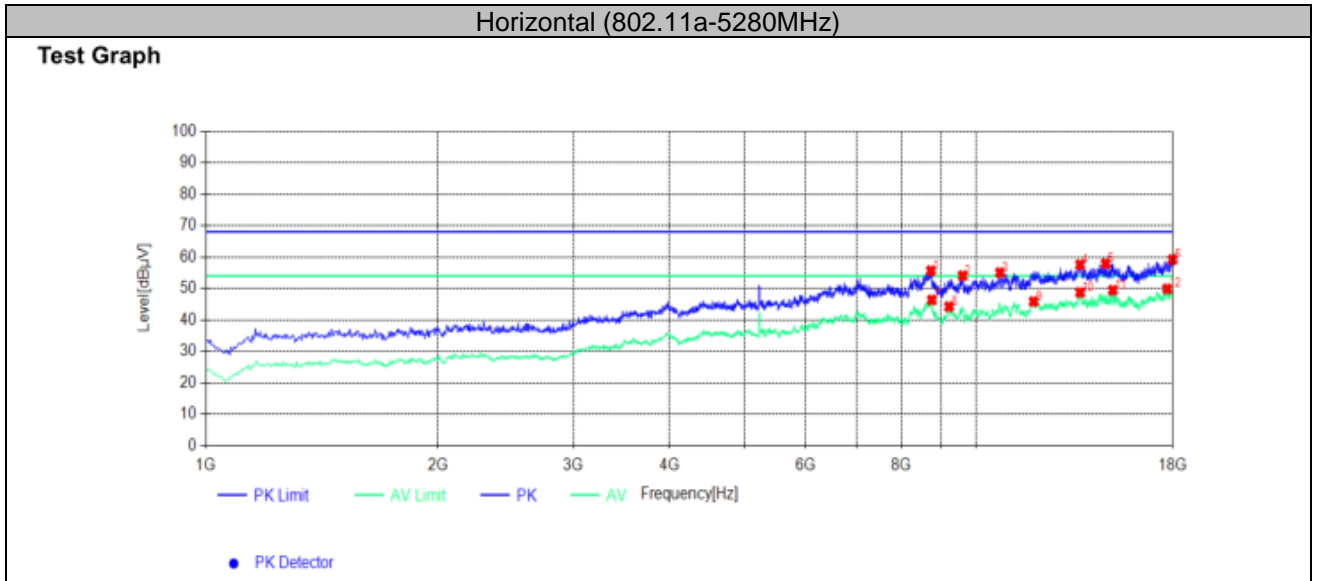



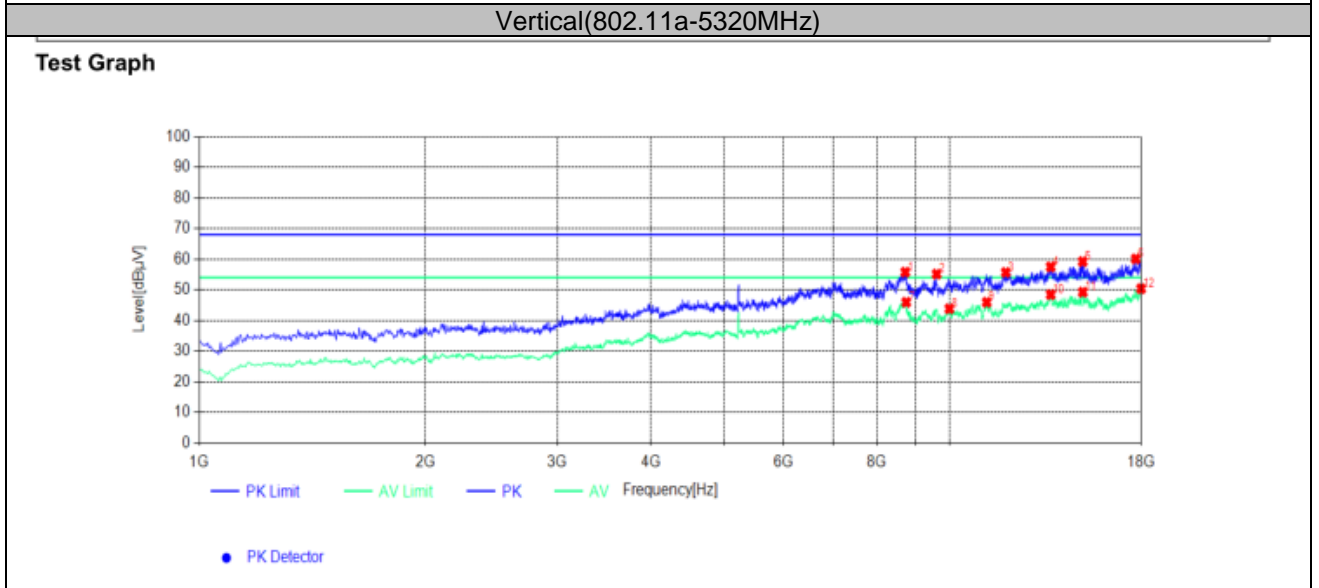
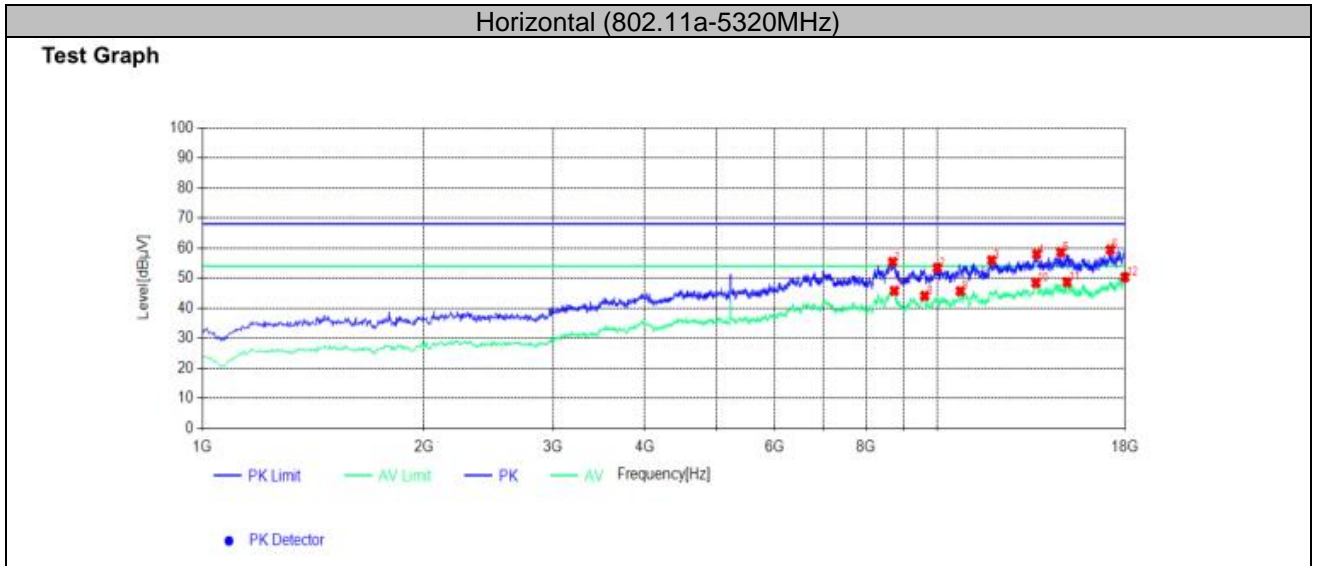

5500-5700MHz:

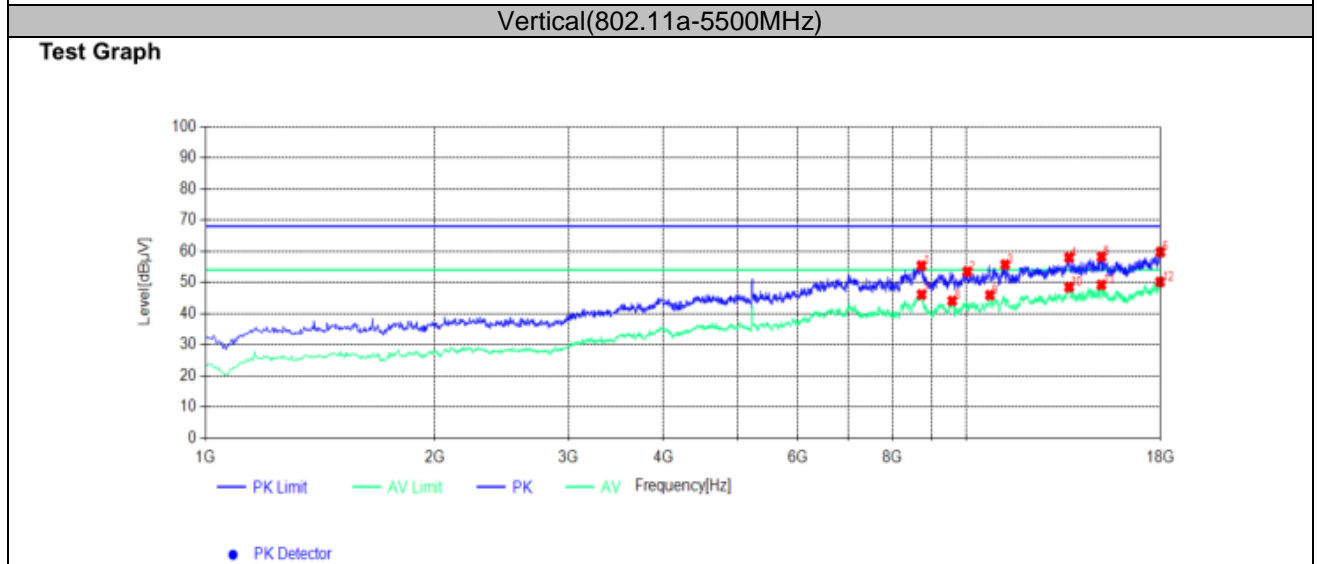
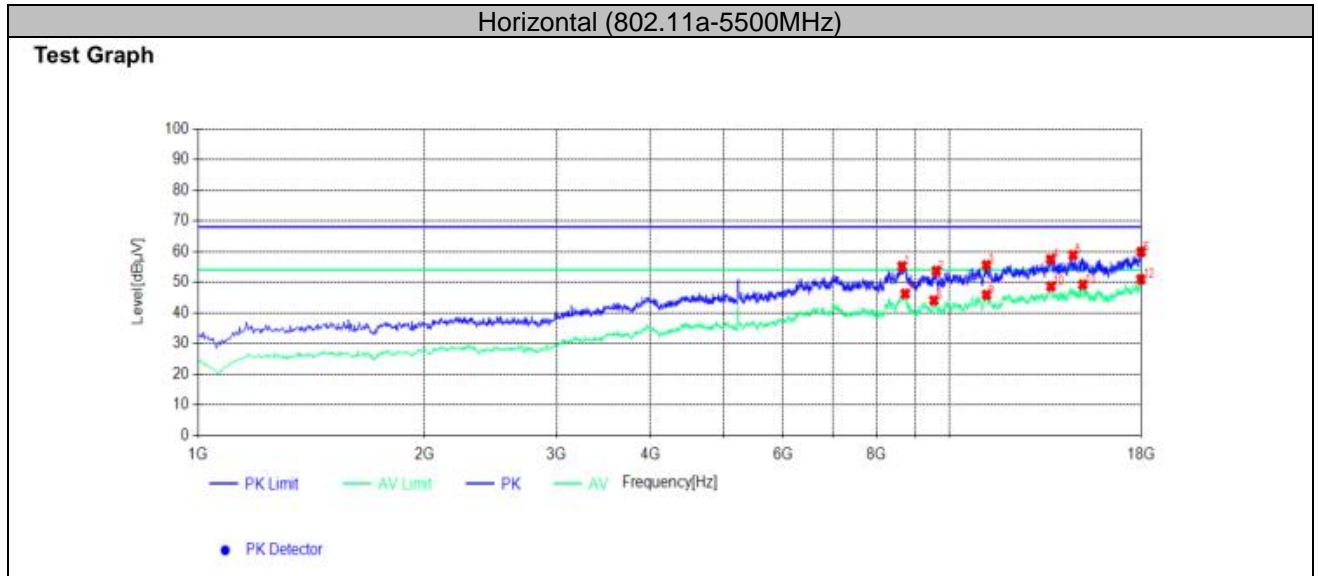

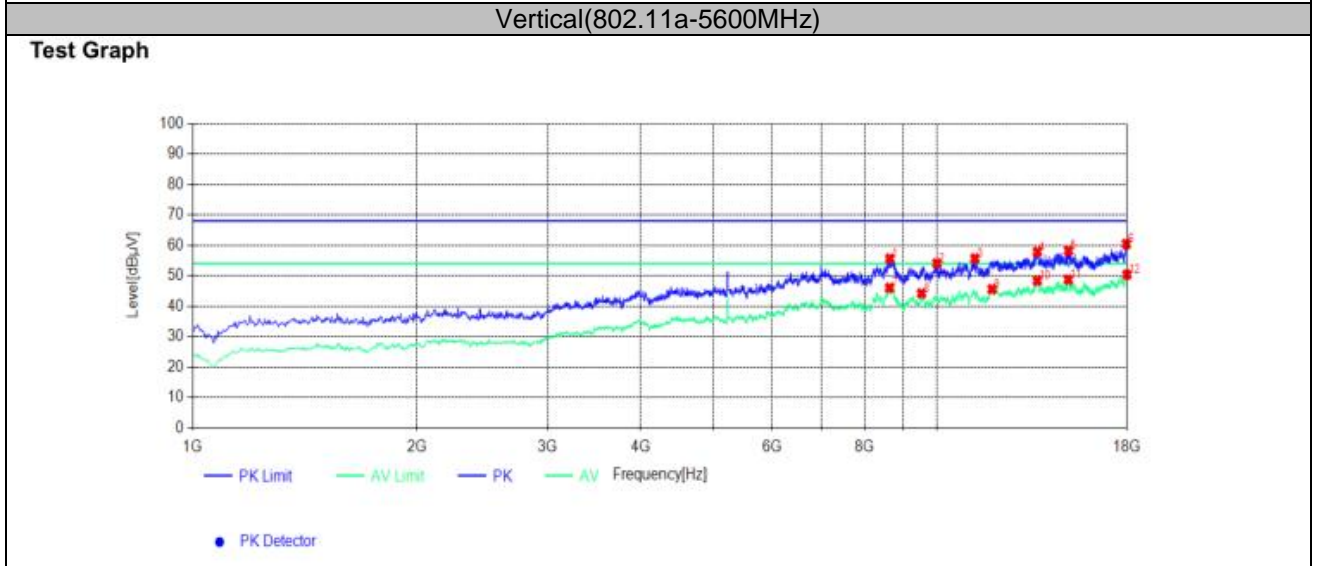
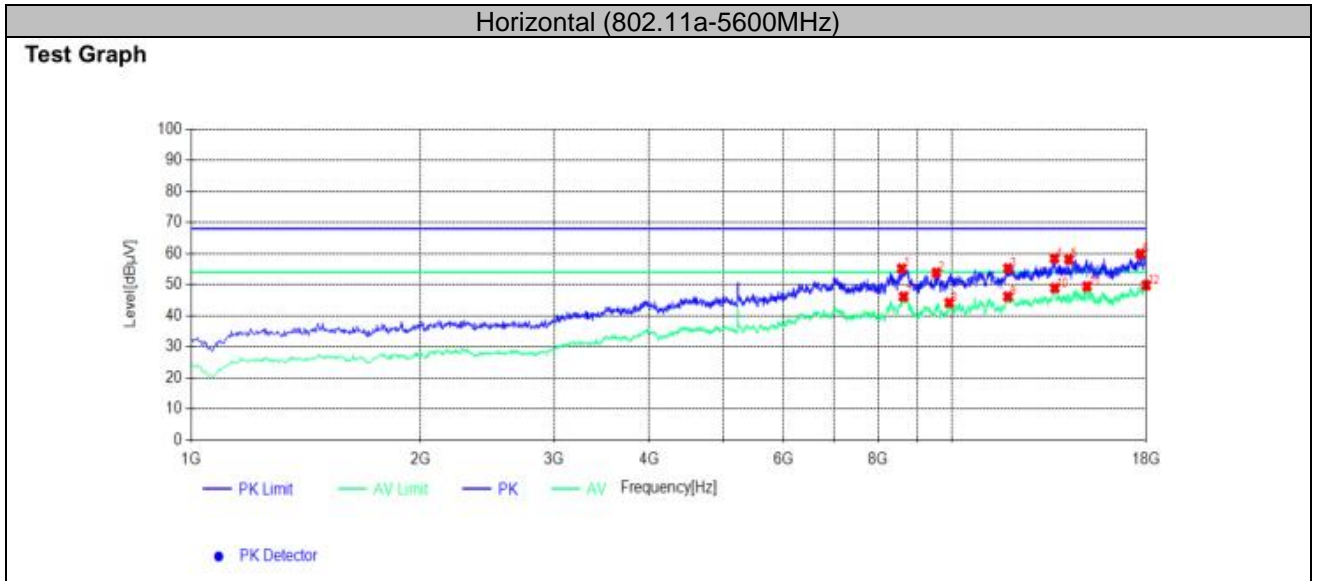

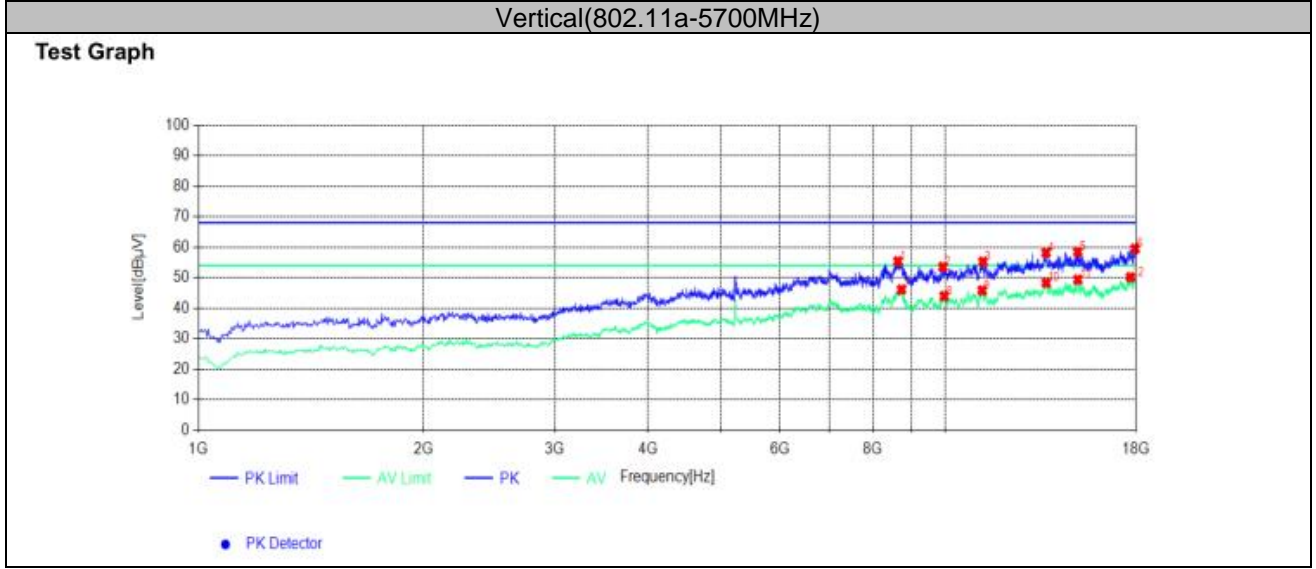
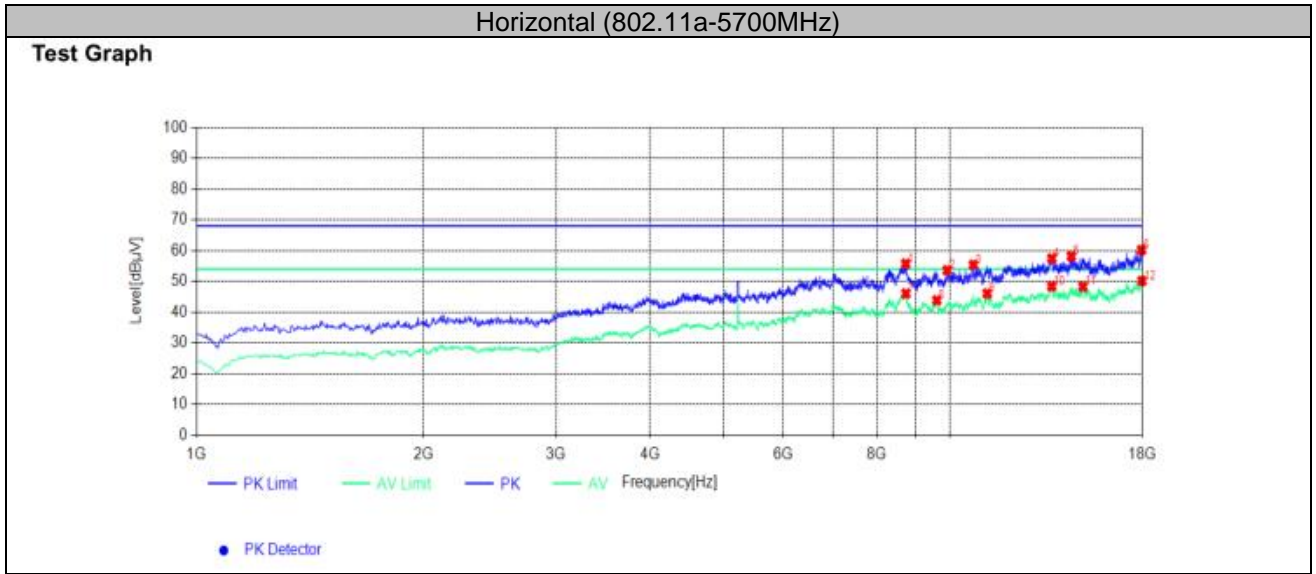

5725-5850MHz:

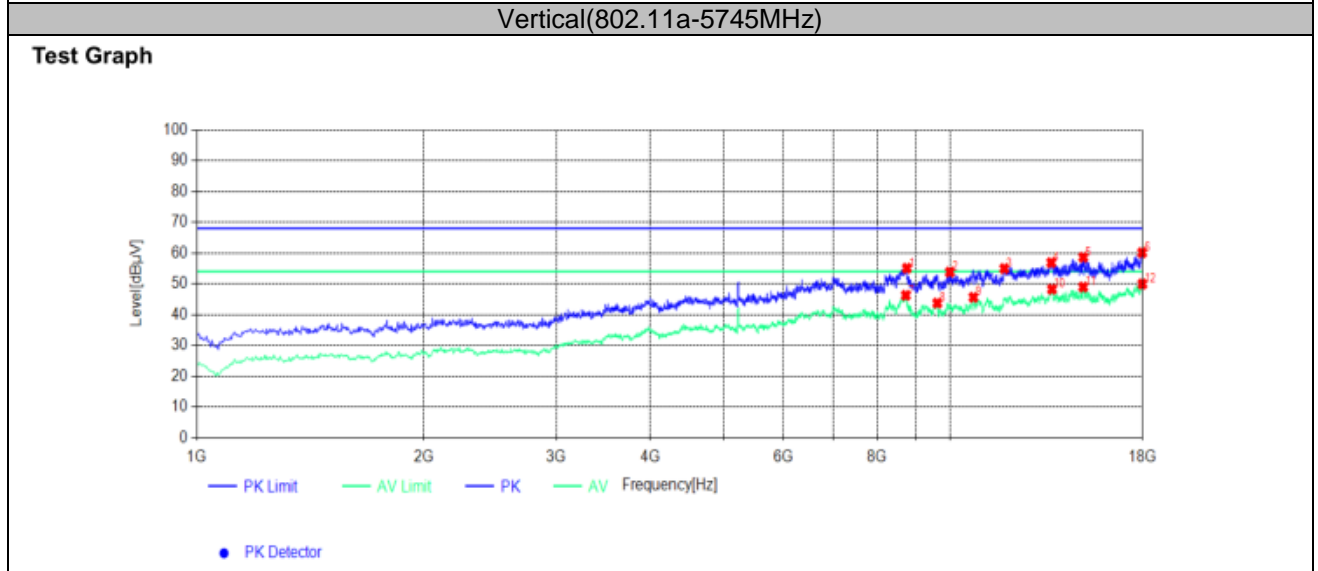
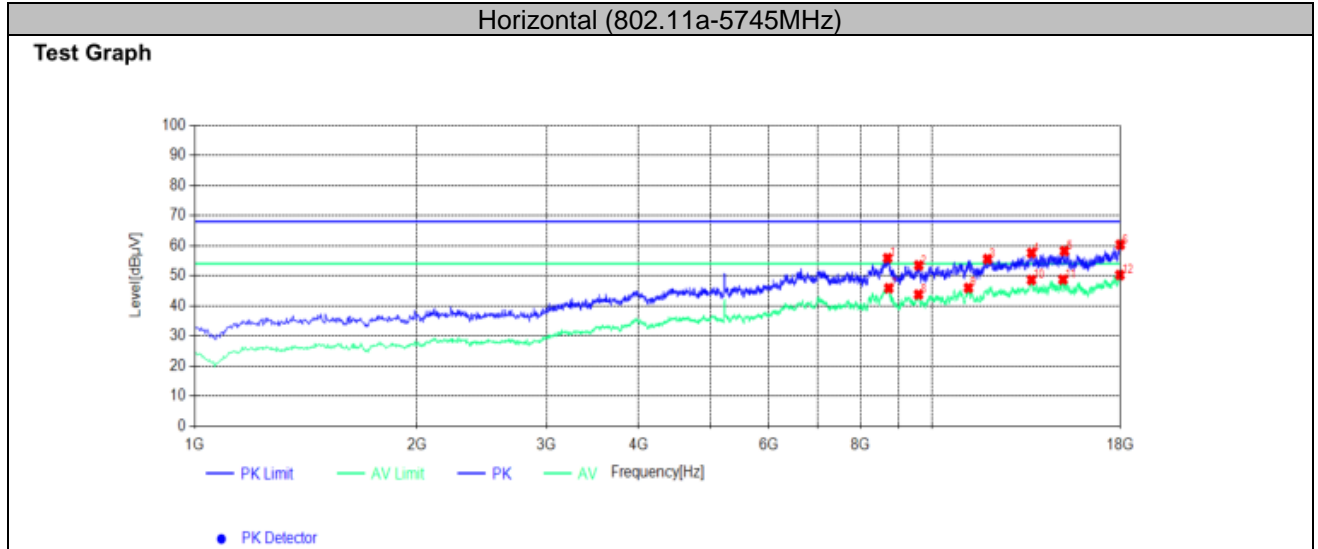

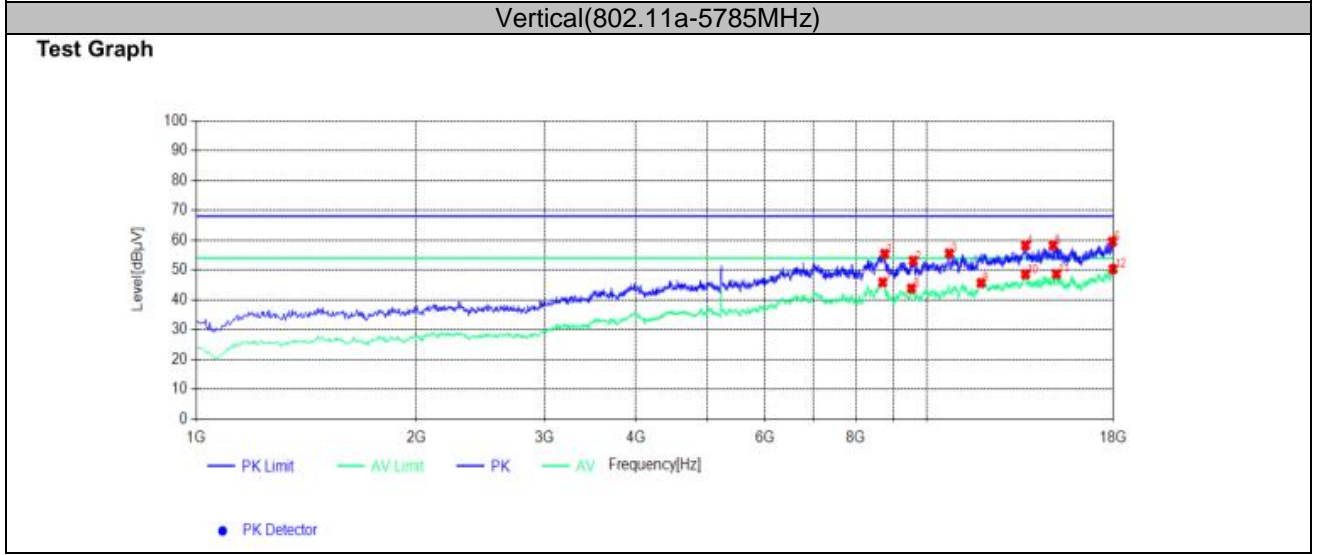
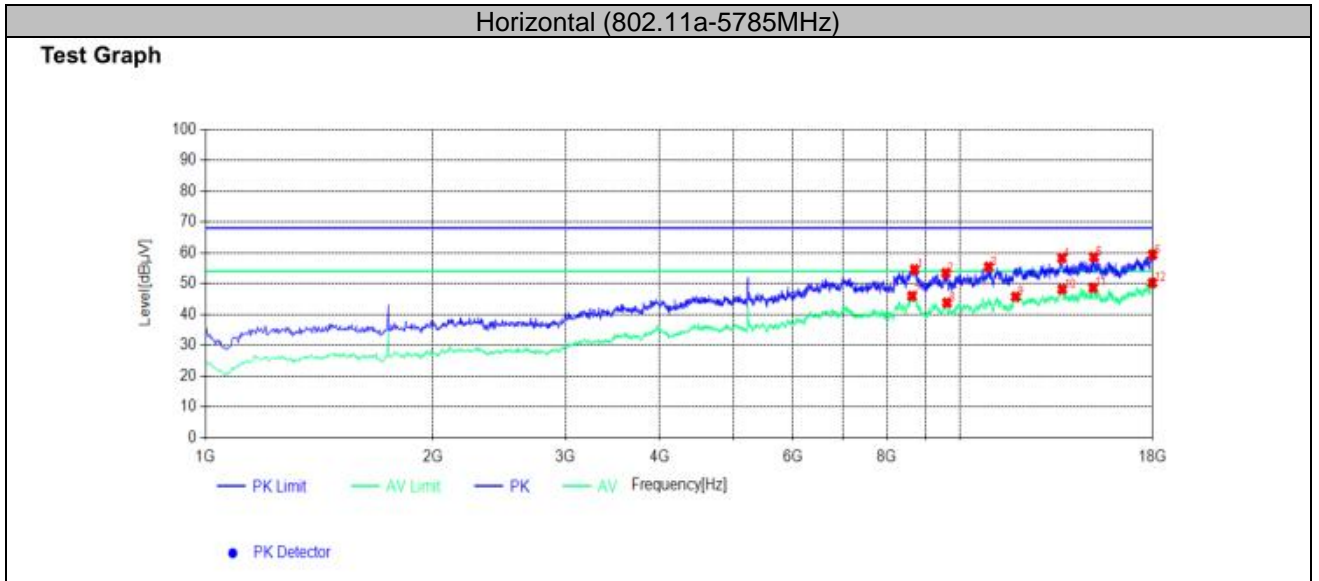

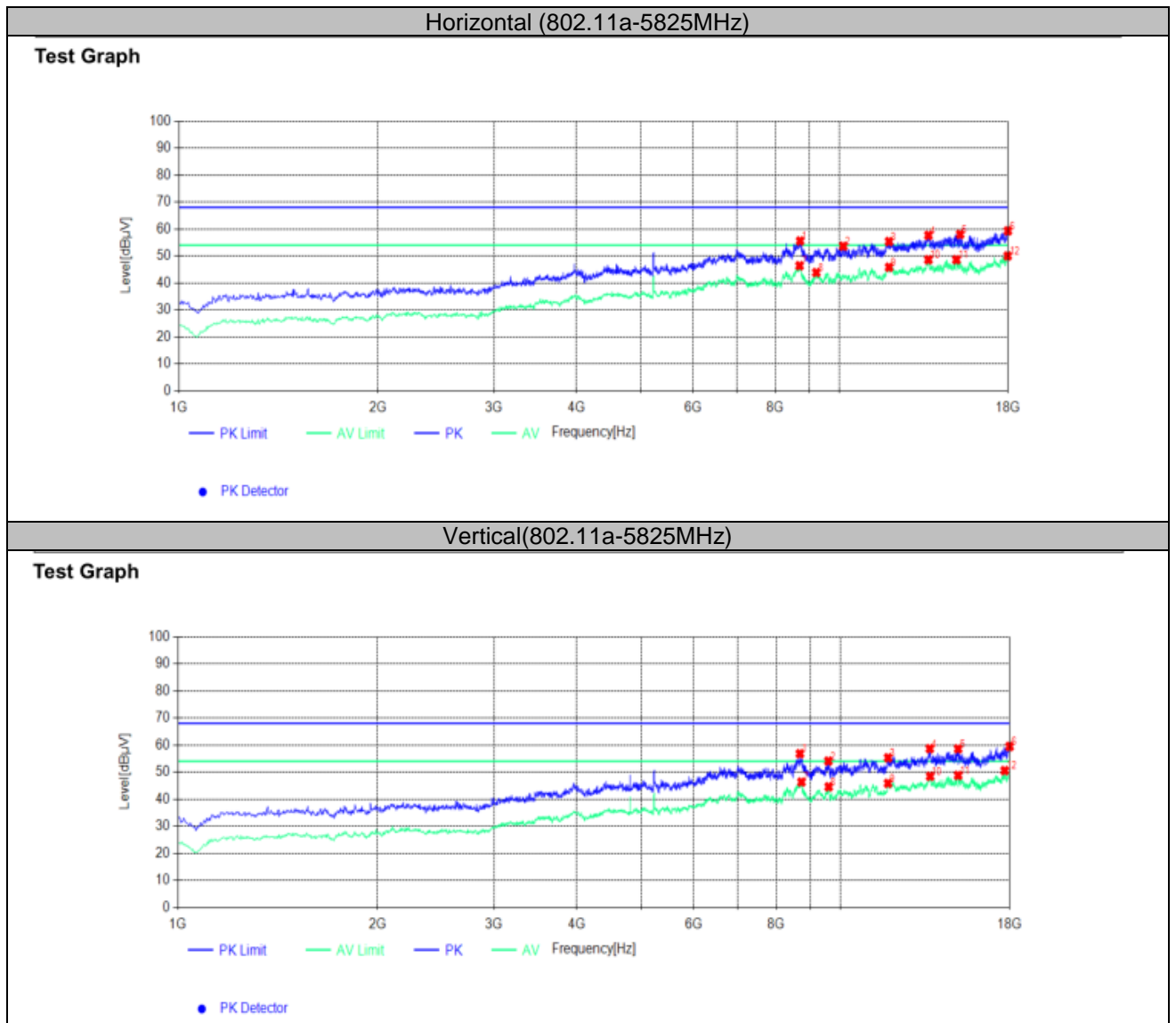

**REMARKS:**

1. Result Level = Read Level + Antenna Factor + Cable loss - PRM Factor.
2. Margin = Result Level - Limit
3. The other emission levels were very low against the limit.
4. Detector AV is setting spectrum/receiver. RBW=1MHz/VBW=10Hz/Sweep time=Auto/Detector=Peak;
5. 18~40GHz at least have 20dB margin. No recording in the test report.
6. Measured used 5GHz band filter to avoid power amplifier overload.

**NOTE: All the modes have been tested and recorded worst mode in the report.**

### 4.3. Duty Cycle

#### TEST CONFIGURATION

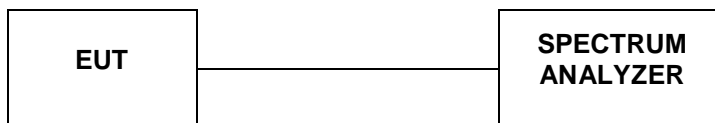

#### TEST PROCEDURE

According to KDB789033 D02 General U-NII Test Procedures New Rules v02r01 Duty Cycle (x), Transmission Duration (T):

- a. A diode detector and an oscilloscope that together have sufficiently short response time to permit accurate measurements of the on and off times of the transmitted signal
- b. The zero-span mode on a spectrum analyzer or EMI receiver, if the response time and spacing between bins on the sweep are sufficient to permit accurate measurements of the on and off times of the transmitted signal. Set the center frequency of the instrument to the center frequency of the transmission. Set  $RBW \geq EBW$  if possible; otherwise, set RBW to the largest available value. Set  $VBW \geq RBW$ . Set detector = peak or average. The zerospan measurement method shall not be used unless both RBW and VBW are  $> 50/T$ , where T is defined in section II.B.1.a), and the number of sweep points across duration T exceeds 100. (For example, if VBW and/or RBW are limited to 3 MHz, then the zero-span method of measuring duty cycle shall not be used if  $T \leq 16.7$  microseconds.)

#### TEST RESULTS

For reporting purpose only.

Please refer to Appendix B.3.

Please refer to Appendix C.3.

Please refer to Appendix D.3.

Please refer to Appendix E.3.



#### 4.4. Maximum Average Output Power

##### TEST CONFIGURATION

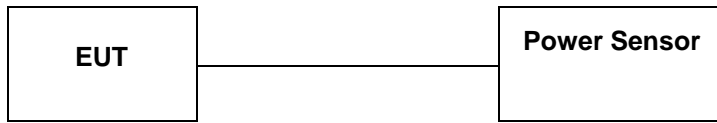

##### TEST PROCEDURE

According to KDB789033 D02 General U-NII Test Procedures New Rules v02r01 Measurement using a Power Meter (PM):

- a. Measurements may be performed using a wideband RF power meter with a thermocouple detector or equivalent if all of the conditions listed below are satisfied
  - 1. The EUT is configured to transmit continuously or to transmit with a constant duty cycle
  - 2. At all times when the EUT is transmitting, it must be transmitting at its maximum power control level.
  - 3. The integration period of the power meter exceeds the repetition period of the transmitted signal by at least a factor of five.
- b. If the transmitter does not transmit continuously, measure the duty cycle, x, of the transmitter output signal as described in section II.B
- c. Measure the average power of the transmitter. This measurement is an average over both the on and off periods of the transmitter.

Adjust the measurement in dBm by adding  $10 \log(1/x)$  where x is the duty cycle (e.g.,  $10 \log(1/0.25)$  if the duty cycle is 25 percent).

##### LIMIT

According to §15.407(a): The maximum output power should be not exceed follow:

Frequency Range (MHz)	Limit
5150-5250	Fixed: 1 Watt (30dBm) Mobile and portable: 250mW (24dBm)
5250-5350	250mW (24dBm)
5470-5725	250mW (24dBm)
5725-5850	1 Watt (30dBm)

Note: The maximum e.i.r.p at any elevation angle above 30 degrees as measured from the horizon must not exceed 125mW(21dBm)

##### TEST RESULTS

For reporting purpose only.

Please refer to Appendix B.4.

Please refer to Appendix C.4.

Please refer to Appendix D.4.

Please refer to Appendix E.4.

### 4.5. Power Spectral Density

#### TEST CONFIGURATION

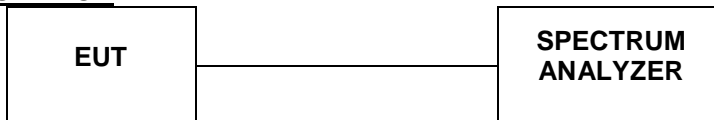

#### TEST PROCEDURE

According to KDB789033 D02 General U-NII Test Procedures New Rules v02r01: The rules requires “maximum power spectral density” measurements where the intent is to measure the maximum value of the time average of the power spectral density measured during a period of continuous transmission

- a. Create an average power spectrum for the EUT operating mode being tested by following the instructions in section II.E.2. for measuring maximum conducted output power using a spectrum analyzer or EMI receiver: select the appropriate test method (SA-1, SA-2, SA-3, or alternatives to each) and apply it up to, but not including, the step labeled, “Compute power...”. (This procedure is required even if the maximum conducted output power measurement was performed using a power meter, method PM.)
- b. Use the peak search function on the instrument to find the peak of the spectrum and record its value.
- c. Make the following adjustments to the peak value of the spectrum, if applicable:
  1. If Method SA-2 or SA-2 Alternative was used, add  $10 \log(1/x)$ , where x is the duty cycle, to the peak of the spectrum.
  2. ) If Method SA-3 Alternative was used and the linear mode was used in step II.E.2.g)(viii), add 1 dB to the final result to compensate for the difference between linear averaging and power averaging.
- d. The result is the Maximum PSD over 1 MHz reference bandwidth.
- e. For devices operating in the bands 5.15-5.25 GHz, 5.25-5.35 GHz, and 5.47-5.725 GHz, the above procedures make use of 1 MHz RBW to satisfy directly the 1 MHz reference bandwidth specified in § 15.407(a)(5). For devices operating in the band 5.725-5.85 GHz, the rules specify a measurement bandwidth of 500 kHz. Many spectrum analyzers do not have 500 kHz RBW, thus a narrower RBW may need to be used. The rules permit the use of a RBWs less than 1 MHz, or 500 kHz, “provided that the measured power is integrated over the full reference bandwidth” to show the total power over the specified measurement bandwidth (i.e., 1 MHz, or 500 kHz). If measurements are performed using a reduced resolution bandwidth (< 1 MHz, or < 500 kHz) and integrated over 1 MHz, or 500 KHz bandwidth, the following adjustments to the procedures apply:
  1. Set  $RBW \geq 1/T$ , where T is defined in section II.B.I.a).
  2. Set  $VBW \geq 3 RBW$ .
  3. If measurement bandwidth of Maximum PSD is specified in 500 kHz, add  $10\log(500\text{kHz}/RBW)$  to the measured result, whereas RBW (< 500 KHz) is the reduced resolution bandwidth of the spectrum analyzer set during measurement.
  4. If measurement bandwidth of Maximum PSD is specified in 1 MHz, add  $10\log(1\text{MHz}/RBW)$  to the measured result, whereas RBW (< 1 MHz) is the reduced resolution bandwidth of spectrum analyzer set during measurement.
  5. Care must be taken to ensure that the measurements are performed during a period of continuous transmission or are corrected upward for duty cycle.

Note: As a practical matter, it is recommended to use reduced RBW of 100 KHz for the sections 5.c) and 5.d) above, since RBW=100 KHz is available on nearly all spectrum analyzers.
- f. Adjust the measurement in dBm by adding  $10 \log(1/x)$  where x is the duty cycle (e.g.,  $10 \log(1/0.25)$  if the duty cycle is 25 percent).

#### LIMIT

According to §15.407(a): The maximum output power should be not exceed follow:

Frequency Range (MHz)	Limit
5150-5250	Other than Mobile and portable:17dBm/MHz Mobile and portable:11dBm/MHz
5250-5350	11dBm/MHz
5470-5725	11dBm/MHz
5725-5850	30dBm/500kHz

#### TEST RESULTS

For reporting purpose only.  
 Please refer to Appendix B.5.  
 Please refer to Appendix C.5.  
 Please refer to Appendix D.5.  
 Please refer to Appendix E.5.

## 4.6. 99% and 6dB Bandwidth

### TEST CONFIGURATION

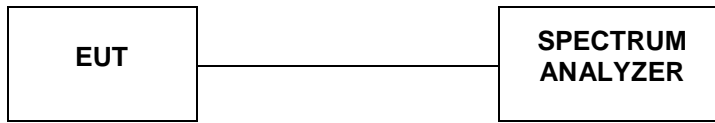

### TEST PROCEDURE

According to KDB789033 D02 General U-NII Test Procedures New Rules v02r01 for one of the following procedures may be used for section 15.407(e) specifies the minimum 6 dB emission bandwidth of at least 500 KHz for the band 5.715-5.85 GHz. The following procedure shall be used for measuring this bandwidth:

- a. Set RBW = 100 kHz.
- b. Set the video bandwidth (VBW)  $\geq 3 \times$  RBW
- c. Detector = Peak.
- d. Trace mode = max hold.
- e. Sweep = auto couple.
- f. Allow the trace to stabilize
- g. Measure the maximum width of the emission that is constrained by the frequencies associated with the two outermost amplitude points (upper and lower frequencies) that are attenuated by 6 dB relative to the maximum level measured in the fundamental emission.

Note: The automatic bandwidth measurement capability of a spectrum analyzer or EMI receiver may be employed if it implements the functionality described above.

### LIMIT

For Section 15.407(e) specifies the minimum 6 dB emission bandwidth of at least 500 KHz for the band 5.715-5.85 GHz

### TEST RESULTS

For reporting purpose only.

Please refer to Appendix E.1.

Please refer to Appendix E.2.

## 4.7. 99% and 26dB Bandwidth

### TEST CONFIGURATION

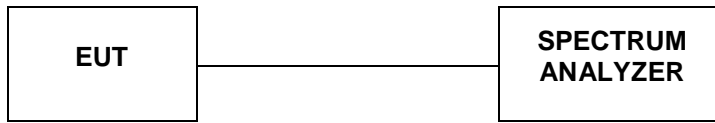

### TEST PROCEDURE

According to KDB789033 D02 General U-NII Test Procedures New Rules v02r01 for one of the following procedures may be used for Emission Bandwidth (EBW) measurement:

- a. Set RBW = 220 kHz/430 kHz /820 kHz (approximately 1% of the emission bandwidth).
- b. Set the video bandwidth (VBW) = 3\* RBW)
- c. Detector = Peak.
- d. Trace mode = max hold.
- e. Sweep = auto couple.
- f. Allow the trace to stabilize
- g. Measure the maximum width of the emission that is 26 dB down from the maximum of the emission. Compare this with the RBW setting of the analyzer. Readjust RBW and repeat measurement as needed until the RBW/EBW ratio is approximately 1%.

Note: The automatic bandwidth measurement capability of a spectrum analyzer or EMI receiver may be employed if it implements the functionality described above.

### LIMIT

No Limits for 26dBc Bandwidth

### TEST RESULTS

For reporting purpose only.

Please refer to Appendix B.1.

Please refer to Appendix B.2.

Please refer to Appendix C.1.

Please refer to Appendix C.2.

Please refer to Appendix D.1.

Please refer to Appendix D.2.

### 4.8. Conducted Spurious Emissions and Band Edge Compliance

#### TEST CONFIGURATION

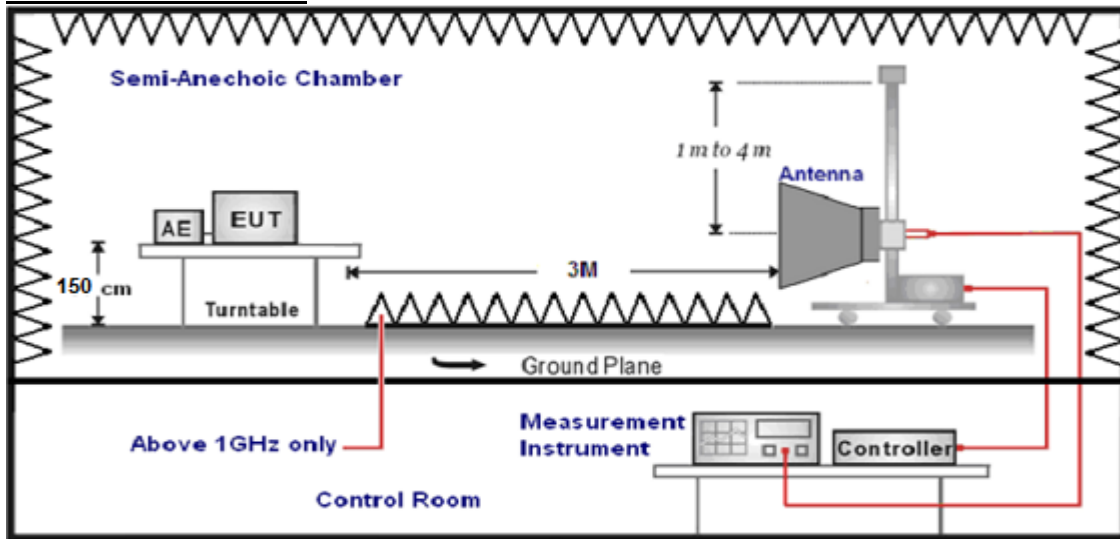

#### LIMIT

20dBc in any 100 kHz bandwidth outside the operating frequency band. In case the emission fall within the restricted band specified on 15.205(a), then the 15.209(a) limit in the table below has to be followed.

Frequency (MHz)	Distance (Meters)	Radiated (dBµV/m)	Radiated (µV/m)
0.009-0.49	3	$20\log(2400/F(KHz))+40\log(300/3)$	$2400/F(KHz)$
0.49-1.705	3	$20\log(24000/F(KHz))+40\log(30/3)$	$24000/F(KHz)$
1.705-30	3	$20\log(30)+40\log(30/3)$	30
30-88	3	40.0	100
88-216	3	43.5	150
216-960	3	46.0	200
Above 960	3	54.0	500

According to §15.407 (b): Except as shown in paragraph (b)(7) of this section, the maximum emissions outside of the frequency bands of operation shall be attenuated in accordance with the following limits

Frequency (MHz)	EIRP Limit (dBm)	Equivalent Field Strength at 3m (dBµV/m)
5150-5250	-27	68.2
5250-5350	-27	68.2
5470-5725	-27	68.2
5725-5850	-27 (beyond 10MHz of the bandedge)	68.2
	-17 (within 10 MHz of band edge)	78.2

#### TEST PROCEDURE

- The EUT was placed on a turn table which is 1.5m above 1GHz.
- Maximum procedure was performed by raising the receiving antenna from 1m to 4m and rotating the turn table from 0° to 360° to acquire the highest emissions from EUT.
- And also, each emission was to be maximized by changing the polarization of receiving antenna both horizontal and vertical.
- Repeat above procedures until all frequency measurements have been completed..
- The distance between test antenna and EUT as following table states:

Test Frequency range	Test Antenna Type	Test Distance
1GHz-18GHz	Double Ridged Horn Antenna	3

- Setting test receiver/spectrum as following table states:

Test Frequency range	Test Receiver/Spectrum Setting	Detector
1GHz-18GHz	Peak Value: RBW=1MHz/VBW=3MHz, Sweep time=Auto Average Value: RBW=1MHz/VBW=10Hz, Sweep time=Auto	Peak

**Field Strength Calculation**

The field strength is calculated by adding the Antenna Factor and Cable Factor and subtracting the Amplifier Gain and Duty Cycle Correction Factor(if any) from the measured reading. The basic equation with a sample calculation is as follows:

$$FS = RA + AF + CL - AG$$

Where FS = Field Strength	CL = Cable Attenuation Factor (Cable Loss)
RA = Reading Amplitude	AG = Amplifier Gain
AF = Antenna Factor	

**TEST RESULTS**

**For Conducted at Restricted Band Measurement**

For reporting purpose only.

Please refer to Appendix B.8.

Please refer to Appendix C.8.

Please refer to Appendix D.8.

Please refer to Appendix E.8.

**For Conducted Band edge Measurement**

For reporting purpose only.

Please refer to Appendix B.6.

Please refer to Appendix C.6.

Please refer to Appendix D.6.

Please refer to Appendix E.6.

**For Conducted Spurious Emissions Measurement**

For reporting purpose only.

Please refer to Appendix B.7.

Please refer to Appendix C.7.

Please refer to Appendix D.7.

Please refer to Appendix E.7.

## 4.9. Frequency Stability

### Standard Applicable

According to FCC §15.407(g) “Manufacturers of U-NII devices are responsible for ensuring frequency stability such that an emission is maintained within the band of operation under all conditions of normal operation as specified in the user manual.”

According to FCC §2.1055(a) “The frequency stability shall be measured with variation of ambient temperature as follows:”

(1) From -30° to + 50° centigrade for all equipment except that specified in paragraphs (a) (2) and (3) of this section.

(2) From -20° to + 50° centigrade for equipment to be licensed for use in the Maritime Services under part 80 of this chapter, except for Class A, B, and S Emergency Position Indicating Radiobeacons (EPIRBS), and equipment to be licensed for use above 952 MHz at operational fixed stations in all services, stations in the Local Television Transmission Service and Point-to-Point Microwave Radio Service under part 21 of this chapter, equipment licensed for use aboard aircraft in the Aviation Services under part 87 of this chapter, and equipment authorized for use in the Family Radio Service under part 95 of this chapter.

(3) From 0° to + 50° centigrade for equipment to be licensed for use in the Radio Broadcast Services under part 73 of this chapter.

### Test Configuration

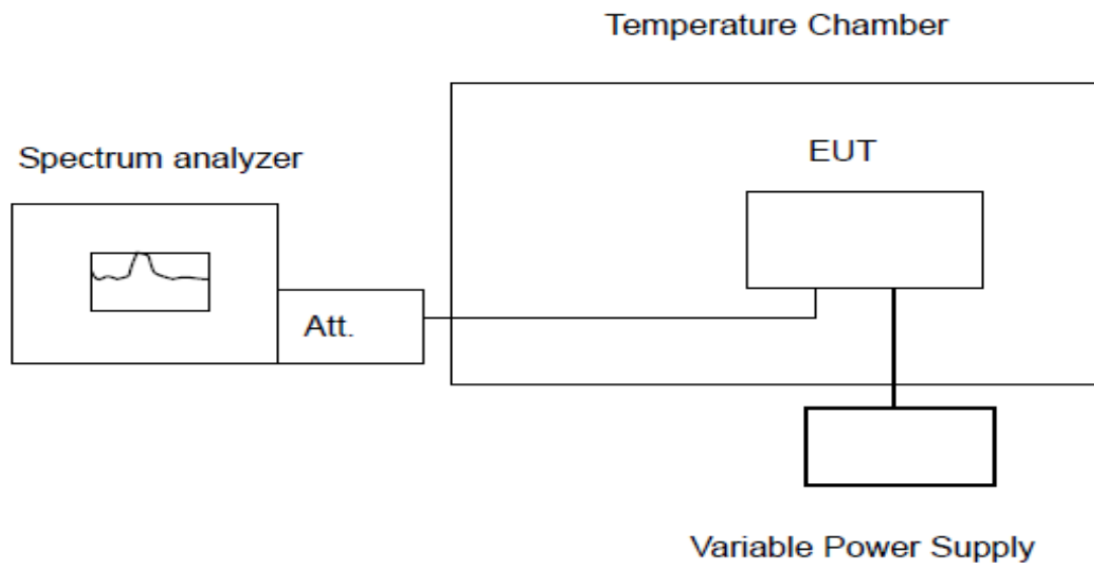

### Test Procedure

The equipment under test was connected to an external AC or DC power supply and input rated voltage. RF output was connected to a frequency counter or spectrum analyzer via feed through attenuators. The EUT was placed inside the temperature chamber. Set the spectrum analyzer RBW low enough to obtain the desired frequency resolution and measure EUT 20 degree operating frequency as reference frequency. Turn EUT off and set the chamber temperature to -30 degree. After the temperature stabilized for approximately 30 minutes recorded the frequency. Repeat step measure with 10 degree increased per stage until the highest temperature of +50 degree reached.

**Test Results**

PASS

Remark:

1. Measured all conditions and recorded worst case.

IEEE 802.11a Mode / 5180 – 5240 MHz / 5180 MHz

Environment Temperature (Degree)	Voltage (V)	Measured Frequency (MHz)	Limit Range (MHz)	Test Results
20	DC 5.5V	5171.596768	5150 – 5250	PASS
20	DC 4.5V	5171.585433	5150 – 5250	PASS
50	DC 5.0V	5171.613552	5150 – 5250	PASS
40	DC 5.0V	5171.525622	5150 – 5250	PASS
30	DC 5.0V	5171.699181	5150 – 5250	PASS
20	DC 5.0V	5171.558986	5150 – 5250	PASS
10	DC 5.0V	5171.528263	5150 – 5250	PASS
0	DC 5.0V	5171.628531	5150 – 5250	PASS
-10	DC 5.0V	5171.639552	5150 – 5250	PASS
-20	DC 5.0V	5171.646674	5150 – 5250	PASS
-30	DC 5.0V	5171.643205	5150 – 5250	PASS

IEEE 802.11a Mode / 5180 – 5240 MHz / 5240 MHz

Environment Temperature (Degree)	Voltage (V)	Measured Frequency (MHz)	Limit Range (MHz)	Test Results
20	DC 5.5V	5248.628681	5150 – 5250	PASS
20	DC 4.5V	5248.694504	5150 – 5250	PASS
50	DC 5.0V	5248.591994	5150 – 5250	PASS
40	DC 5.0V	5248.648907	5150 – 5250	PASS
30	DC 5.0V	5248.599914	5150 – 5250	PASS
20	DC 5.0V	5248.608703	5150 – 5250	PASS
10	DC 5.0V	5248.541775	5150 – 5250	PASS
0	DC 5.0V	5248.665309	5150 – 5250	PASS
-10	DC 5.0V	5248.542942	5150 – 5250	PASS
-20	DC 5.0V	5248.648928	5150 – 5250	PASS
-30	DC 5.0V	5248.538770	5150 – 5250	PASS



IEEE 802.11a Mode / 5260 – 5320 MHz / 5260 MHz

Environment Temperature (Degree)	Voltage (V)	Measured Frequency (MHz)	Limit Range (MHz)	Test Results
20	DC 5.5V	5251.510063	5250 – 5350	PASS
20	DC 4.5V	5251.698409	5250 – 5350	PASS
50	DC 5.0V	5251.664812	5250 – 5350	PASS
40	DC 5.0V	5251.696164	5250 – 5350	PASS
30	DC 5.0V	5251.507440	5250 – 5350	PASS
20	DC 5.0V	5251.617465	5250 – 5350	PASS
10	DC 5.0V	5251.518138	5250 – 5350	PASS
0	DC 5.0V	5251.680616	5250 – 5350	PASS
-10	DC 5.0V	5251.534560	5250 – 5350	PASS
-20	DC 5.0V	5251.647763	5250 – 5350	PASS
-30	DC 5.0V	5251.667836	5250 – 5350	PASS

IEEE 802.11a Mode / 5260 – 5320 MHz / 5320 MHz

Environment Temperature (Degree)	Voltage (V)	Measured Frequency (MHz)	Limit Range (MHz)	Test Results
20	DC 5.5V	5328.689385	5250 – 5350	PASS
20	DC 4.5V	5328.576996	5250 – 5350	PASS
50	DC 5.0V	5328.589455	5250 – 5350	PASS
40	DC 5.0V	5328.557565	5250 – 5350	PASS
30	DC 5.0V	5328.576481	5250 – 5350	PASS
20	DC 5.0V	5328.516315	5250 – 5350	PASS
10	DC 5.0V	5328.558192	5250 – 5350	PASS
0	DC 5.0V	5328.666017	5250 – 5350	PASS
-10	DC 5.0V	5328.601139	5250 – 5350	PASS
-20	DC 5.0V	5328.685737	5250 – 5350	PASS
-30	DC 5.0V	5328.602394	5250 – 5350	PASS

IEEE 802.11a Mode / 5500 – 5700 MHz / 5500 MHz

Environment Temperature (Degree)	Voltage (V)	Measured Frequency (MHz)	Limit Range (MHz)	Test Results
20	DC 5.5V	5491.518626	5470 – 5725	PASS
20	DC 4.5V	5491.687368	5470 – 5725	PASS
50	DC 5.0V	5491.568054	5470 – 5725	PASS
40	DC 5.0V	5491.678989	5470 – 5725	PASS
30	DC 5.0V	5491.587184	5470 – 5725	PASS
20	DC 5.0V	5491.588295	5470 – 5725	PASS
10	DC 5.0V	5491.640466	5470 – 5725	PASS
0	DC 5.0V	5491.670686	5470 – 5725	PASS
-10	DC 5.0V	5491.659592	5470 – 5725	PASS
-20	DC 5.0V	5491.698445	5470 – 5725	PASS
-30	DC 5.0V	5491.583178	5470 – 5725	PASS

## IEEE 802.11a Mode / 5500 – 5700 MHz / 5700 MHz

Environment Temperature (Degree)	Voltage (V)	Measured Frequency (MHz)	Limit Range (MHz)	Test Results
20	DC 5.5V	5708.569591	5470 – 5725	PASS
20	DC 4.5V	5708.523409	5470 – 5725	PASS
50	DC 5.0V	5708.562650	5470 – 5725	PASS
40	DC 5.0V	5708.596422	5470 – 5725	PASS
30	DC 5.0V	5708.515838	5470 – 5725	PASS
20	DC 5.0V	5708.679734	5470 – 5725	PASS
10	DC 5.0V	5708.532268	5470 – 5725	PASS
0	DC 5.0V	5708.693104	5470 – 5725	PASS
-10	DC 5.0V	5708.583408	5470 – 5725	PASS
-20	DC 5.0V	5708.504396	5470 – 5725	PASS
-30	DC 5.0V	5708.572363	5470 – 5725	PASS

## IEEE 802.11a Mode / 5745 – 5825 MHz / 5745 MHz

Environment Temperature (Degree)	Voltage (V)	Measured Frequency (MHz)	Limit Range (MHz)	Test Results
20	DC 5.5V	5736.585746	5725 – 5850	PASS
20	DC 4.5V	5736.518446	5725 – 5850	PASS
50	DC 5.0V	5736.567347	5725 – 5850	PASS
40	DC 5.0V	5736.650978	5725 – 5850	PASS
30	DC 5.0V	5736.525977	5725 – 5850	PASS
20	DC 5.0V	5736.500342	5725 – 5850	PASS
10	DC 5.0V	5736.657553	5725 – 5850	PASS
0	DC 5.0V	5736.502183	5725 – 5850	PASS
-10	DC 5.0V	5736.583747	5725 – 5850	PASS
-20	DC 5.0V	5736.658279	5725 – 5850	PASS
-30	DC 5.0V	5736.657438	5725 – 5850	PASS

## IEEE 802.11a Mode / 5745 – 5825 MHz / 5825 MHz

Environment Temperature (Degree)	Voltage (V)	Measured Frequency (MHz)	Limit Range (MHz)	Test Results
20	DC 5.5V	5833.620929	5725 – 5850	PASS
20	DC 4.5V	5833.557834	5725 – 5850	PASS
50	DC 5.0V	5833.581735	5725 – 5850	PASS
40	DC 5.0V	5833.562902	5725 – 5850	PASS
30	DC 5.0V	5833.519715	5725 – 5850	PASS
20	DC 5.0V	5833.630342	5725 – 5850	PASS
10	DC 5.0V	5833.632394	5725 – 5850	PASS
0	DC 5.0V	5833.679351	5725 – 5850	PASS
-10	DC 5.0V	5833.617369	5725 – 5850	PASS
-20	DC 5.0V	5833.531587	5725 – 5850	PASS
-30	DC 5.0V	5833.681987	5725 – 5850	PASS

## 4.10. Antenna Requirement

### Standard Applicable

For intentional device, according to FCC 47 CFR Section 15.203, an intentional radiator shall be designed to ensure that no antenna other than that furnished by the responsible party shall be used with the device.

And according to FCC 47 CFR Section 15.407 (a), if transmitting antennas of directional gain greater than 6dBi are used, the power shall be reduced by the amount in dB that the directional gain of the antenna exceeds 6dBi.

### **Antenna Information**

The antenna is FPC Aantenna, through the buckle stretched out, The directional gains of antenna used for transmitting is 3.27 dBi.

Reference to the Test Report: **CTA24061301901.**

**5. TEST SETUP PHOTOS OF THE EUT**

Reference to the test report No. CTA24061301901.

**6. EXTERNAL AND INTERNAL PHOTOS OF THE EUT**

Reference to the test report No. CTA24061301901.

.....**End of Report**.....