

Baby Monitor

Baby 2S

ORIGINALITY DESIGN SMART AND BEAUTIFUL



QUICK GUIDE

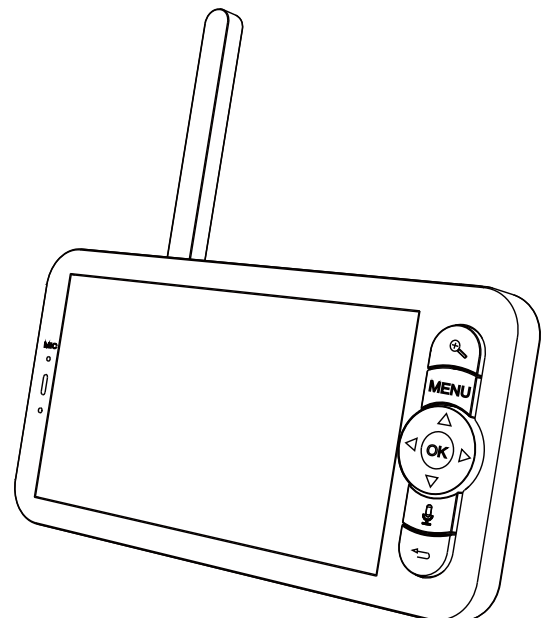
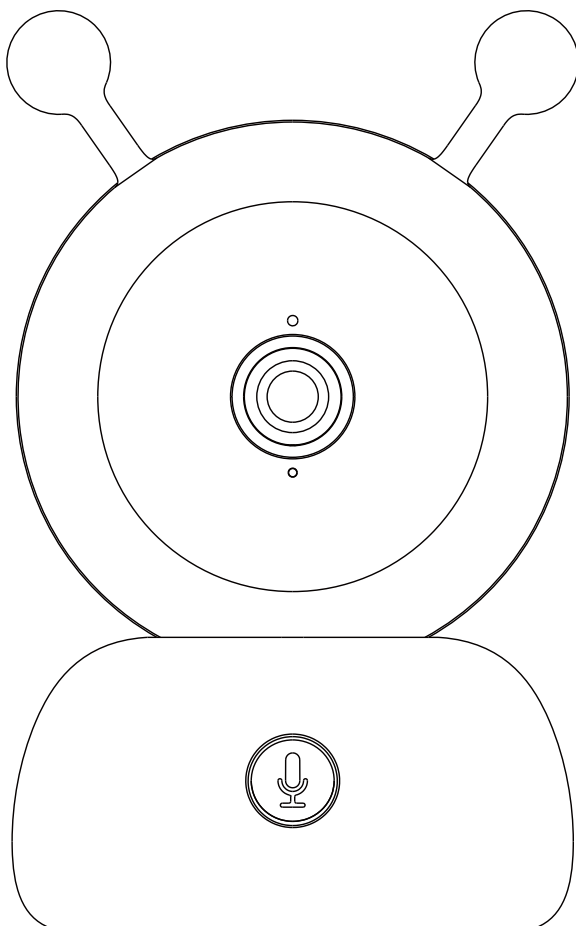

What's in the box

Please consult this checklist for all parts.

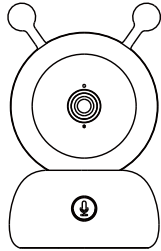

Camera

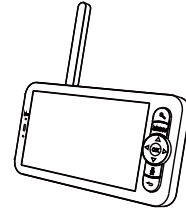

Display

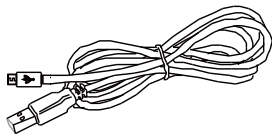

USB cable x 2

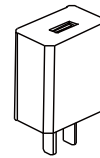

Power adapter x 2

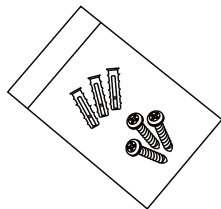

Screws

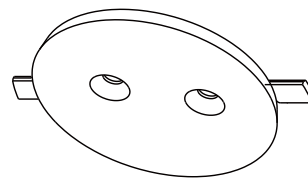

Bracket

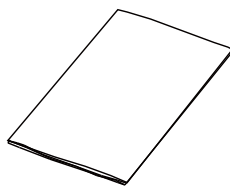

Manual



Reset pin

Description

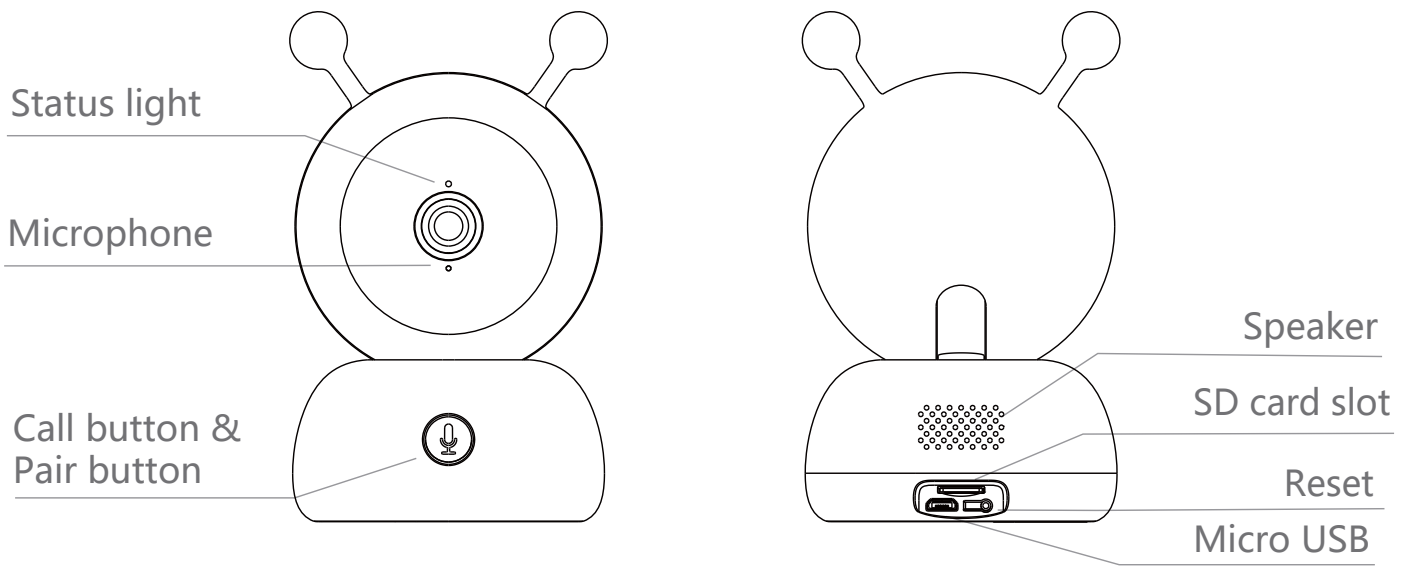

Micro USB	DC 5V/1A
Microphone	Capture sound for your video
SD card slot	Support local SD Card storage (Max.128G)
Status light	<ul style="list-style-type: none"> • Solid red light on: network is malfunctional • Blinking red light: wait for network connection (fast blinking) • Solid blue light on: camera is working correctly
Call/Pairing	Press to make a call; long press to pair
Reset	Press and hold for 5 seconds with pin to reset the camera (if you have modified settings, they will return to factory defaults)

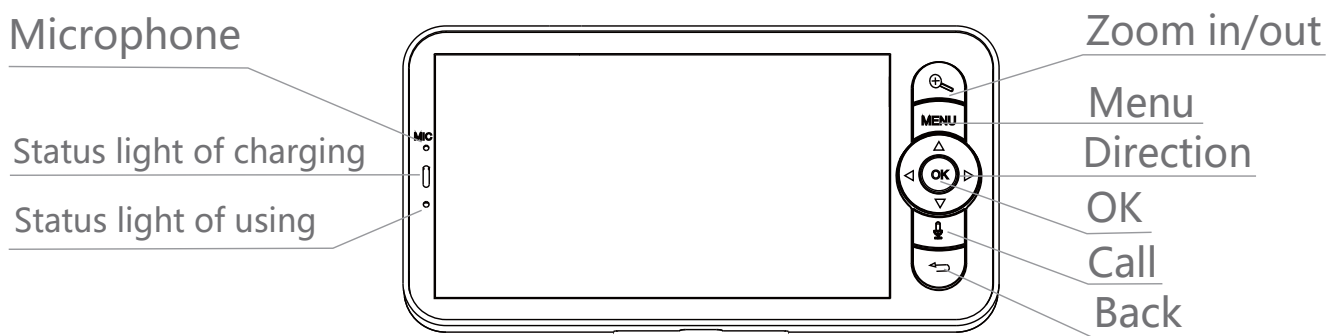

Description

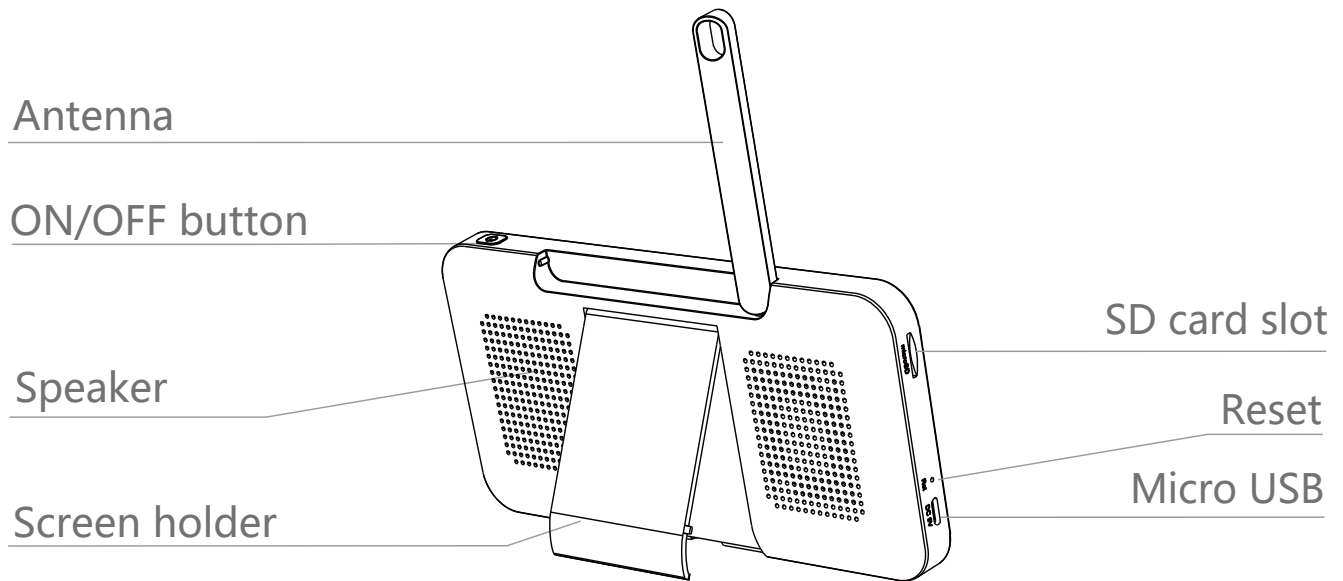

Micro USB DC 5V/1A

Status light of charging

- Orange light: Charging
- Green light: Fully charged

Status light of using

- Yellow light: The display is on
- No light: The display is off

Microphone Capture sound for your video

Antenna Adjust the angle to get better signals

ON/OFF button Long press 5 seconds to turn on and turn off the display

Zoom in/out Zoom the image in 1X, 2X or 4X

Menu

On homepage, press to enter the menu interface;
On homepage, long press to enter the setting interface

Direction Control the rotation directions; select the menu items

OK Confirm

Call Make a call after pressing the button

SD card slot Support local SD Card storage (Max.128G)

Reset Press with pin to reset the display

Back

Press to back up;
On homepage, long press to stop playing music

- 1 Install the camera on a flat surface.

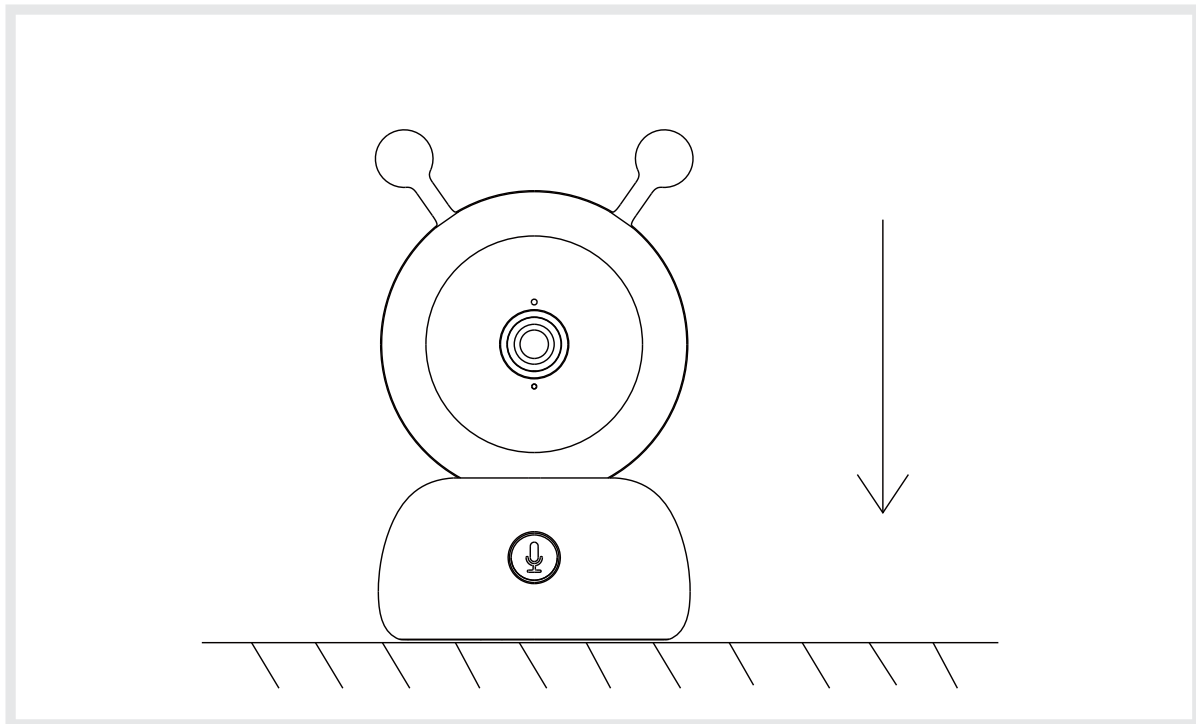

- 2 Or, use the included mounting bracket to fix the camera to a clean surface.

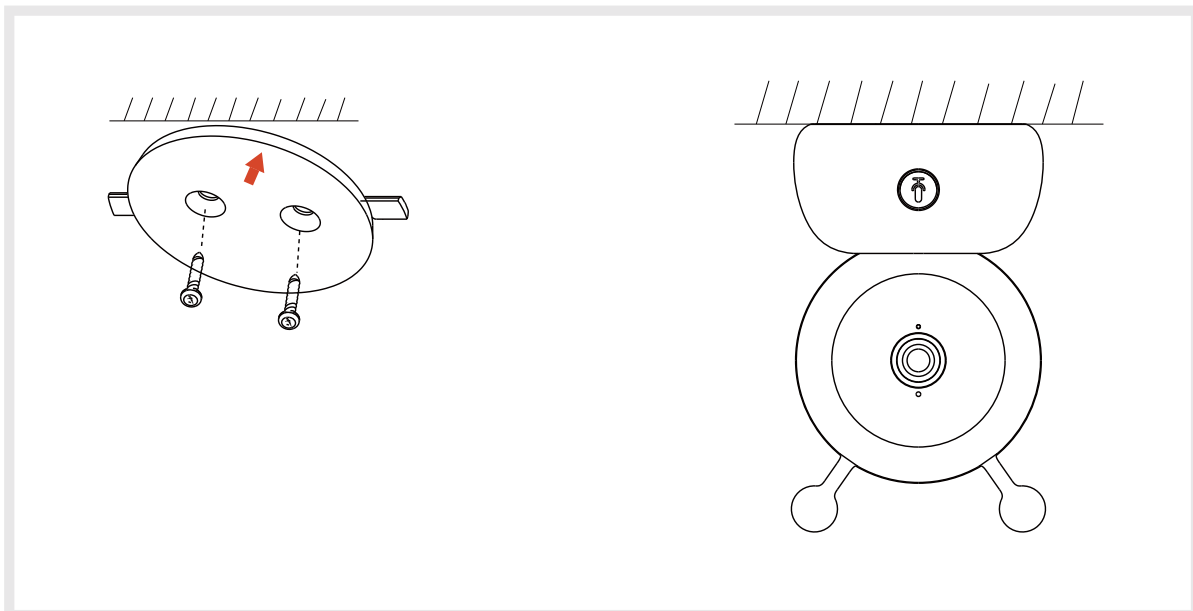

Connect the camera to the display

Power on the camera and the display, and then the camera will connect to the display automatically. The connection is distance limited, so make the distance between the camera and the display is no more than 200m.

- Disconnect the camera to the display:
 1. Press **Menu** button on the display screen, and select  > **Camera Management**.
 2. Long press **OK** button on the display screen to release the binding.



- Reconnect the camera to the display:
 1. Press **Menu** button on the display screen, and select  > **Camera Management**.
 2. Long press the camera pairing button until you hear the prompt tone.
 3. Press **OK** button on the display screen to start pairing.



Connect the camera to the App

The camera can be connected both to the display and the App. Generally, it is connected to the display by default.

Follow the steps below to connect the camera to the App:

1. Make sure the Wi-Fi network is a 2.4 GHz network, as the camera doesn't support 5 GHz Wi-Fi.
2. Download the corresponding App on your phone. Register a new account to log in or log in directly.
3. Reset the camera using a pin until the status light is red in fast blinking. (You have to connect the camera to the App within 2 minutes; otherwise, you have to reset the camera again.)
4. Follow the step instructions on your smart phone to add the display, and scan the QR code with your camera.

Rotate the camera

You can adjust the monitoring angle for a better vision. The direction buttons on the display screen are available when the camera is powered on. Press direction buttons to rotate the camera horizontally and vertically, for a better vision.

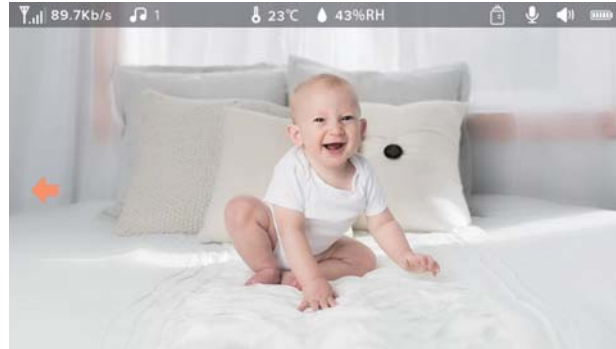



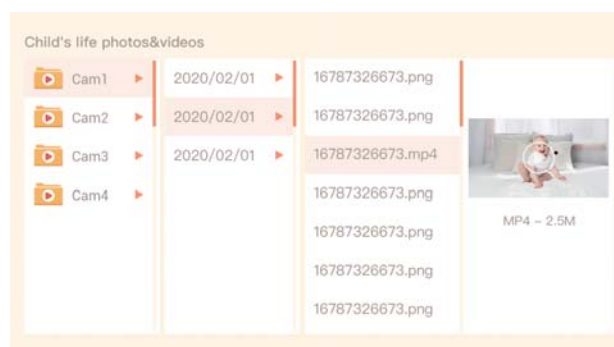



Photo & video

- **Take a photo:**
You can take a photo when you want to capture an interesting scene of your baby.
Press **Menu** button on the display screen, select  and press **OK** to take a photo.
- **Record a video:**
You can record a video when you want to capture a meaningful time of your baby.
Press **Menu** button on the display screen, select  and press **OK** to record a video.
- **View the taken photos and recorded videos:**
 1. Press **Menu** button on the display screen, select  and press **OK** to enter the interface.
 2. Select the camera and date, select the photo or video you want to view, and press **OK** to enter preview mode.
 - * For a video, press **OK** to play or pause in the preview mode.
 - * Press backup button to quit preview or return to main menu.



Play music

You can play music to sooth your baby when baby is crying or sleeping. There are various soft music to select.

Press **Menu** button on the display screen, select  and press **OK** to enter music interface. You can select different music, change the music cycle mode, or adjust the music volume.



Feeding reminder

Remind you to feed your baby, when you are too busy, or when you want to give your baby a regular diet.

1. Press **Menu** button on the display screen, and select  > **Feeding reminder**.
2. Press UP and DOWN direction buttons to select between 4 time options, and press **OK** to start time setting.
3. When start to set up one feeding time, press LEFT and RIGHT direction buttons to change options between hour, minute, second and on/off; and press UP and DOWN direction buttons to change values and select on or off.
4. Press **OK** to save settings.
5. Select on or off to open or close feeding reminders.
You can set up to 4 feeding times one day. And when the set time is up, a feeding alarm will appear on the display screen.

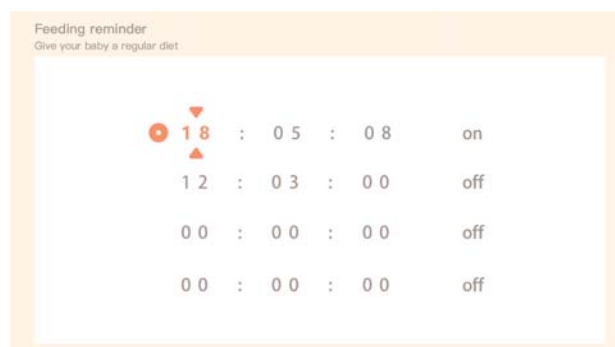

Humiture detection

You can real-time monitor the temperature and humidity of your baby room. When the temperature and humidity are out of range, you can get the alarms immediately, and then take measures.

1. Press **Menu** button on the display screen, and select  > **Humiture detection**.
2. Press UP and DOWN direction buttons to select options between temperature range, humidity range and out of range reminder, and press **OK** to start setting.
3. When start to set up one option, press LEFT and RIGHT direction buttons to change options, and press UP and DOWN direction buttons to change values and units.
4. Press **OK** to save settings.
5. In **Out of range reminder** option, select to turn on or off the alarm when the temperature and humidity are out of range.

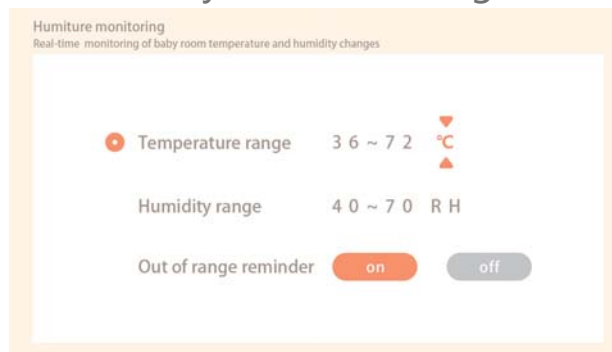



Smart care

You can turn on functions of motion detection, noise detection and cry detection, so that you can know the baby status immediately, no matter you are sleeping, working, cooking and so on.

1. Press **Menu** button on the display screen, and select  > **Smart care**.
2. Press UP and DOWN direction buttons to select options between motion detection, noise detection, cry detection and alarm volume, and press **OK** to start setting.
3. When start to set up one detection mode, press LEFT and RIGHT direction buttons to change options, and press UP and DOWN direction buttons to adjust sensitivity.
 - * You can select different sensitivity according to needs. Low is low sensitivity, and high is high sensitivity.
4. When set up the alarm volume, press LEFT and RIGHT direction buttons to adjust.
5. Press **OK** to save settings.
6. There will be a alarm when the set detection is triggered, press **OK** to stop alarm.





General setting

- Set up brightness:
 1. Press **Menu** button on the display screen, select  and press **OK** to enter the interface.
 2. Press UP and DOWN direction buttons to adjust brightness.
- Set up time:
 1. Press **Menu** button on the display screen, and select  > **Time setting**.
 2. Press direction buttons to change date, time and time displaying mode.
- Set up language:
 1. Press **Menu** button on the display screen, and select  > **Language**.
 2. Select the language you need.
- Set up sleep mode:

You can set up sleep mode to increase standby time.

 1. Press **Menu** button on the display screen, and select  > **Sleep mode**.
 2. Select sleep mode as 1 minute, 5 minutes, 10 minutes, 30 minutes, 60 minutes or off.
- Turn on and off status indicator:

If you turn on the status indicator, you can get the working status of the camera. You can also turn off the status indicator, if you think it will affect your baby's sleep.
- SD card:
 1. Press **Menu** button on the display screen, and select  > **SD card management**. Then you can view the total capacity and remaining capacity of your SD card.
 2. (Optional) You can format the SD card as you needed, but make sure that the important data is backed up.
- Upgrade:

Make sure your camera is connected to a the 2.4 GHz Wi-Fi.
You can upgrade your camera when the upgrade alarm appears. Or Press Menu button on the display screen, and select  > **Device information** to check whether there is a upgrade.
- Low battery alarm:

When the camera is low on battery, the low battery alarm will appear on the display screen. Please charge the display as soon as possible.

Q: The display cannot be previewed properly?

A: Check whether the display has connected to the camera. If not, pair the camera and the display firstly.

Q: Cannot find the pairing button?

A: The pairing button is the call button of the camera. Long press the button for 3 seconds, and follow the step instructions of the display. (To enter the pairing interface of the display, press **Menu** button on the display screen, and select  > **Camera Management.**)

Q: What if the display screen is stuck and it doesn't work while pressing any buttons?

A: Press the reset button of your display the with pin, and then long press the power button of your display to restart it.

Q: Why the camera or the display cannot identify the SD card?

A: Confirm whether the SD card is normally available and the format is FAT32.

Q: Why I can't get the notifications with my cell phone App when I connect the camera to the display?

A: Please confirm that the App has been running on the phone, and the relevant reminder function has been opened; Message notification and authority confirmation in the mobile phone system have been opened.

Pan/Tilt

Rotate your camera by sliding on your smartphone, providing you with a good vision.

Video flip

Flip your video stream up or down for maximum flexibility.

Motion detection

The camera can detect movement, and then the camera will send you push notifications and app alerts.

Crying detection

The camera can detect the crying of your baby, and the camera will send you push notifications and app alerts.

Temperature & humidity detection

The camera can detect the temperature and humidity of the environment, and the camera will send you push notifications and app alerts.

Record

Support 24H continuous recording with high capacity SD storage or Cloud storage.

Daytime & Night

Never miss a moment, even in complete darkness, with powerful night-vision technology.



Daytime



Night

FCC Statement:

Any Changes or modifications not expressly approved by the party responsible for compliance could void the user's authority to operate the equipment.

This device complies with part 15 of the FCC Rules. Operation is subject to the following two conditions:

- (1) This device may not cause harmful interference, and
- (2) this device must accept any interference received, including interference that may cause undesired operation.

FCC Radiation Exposure Statement:

This equipment complies with FCC radiation exposure limits set forth for an uncontrolled environment. This equipment should be installed and operated with minimum distance 20cm between the radiator and your body.

Note: This equipment has been tested and found to comply with the limits for a Class B digital device, pursuant to part 15 of the FCC Rules. These limits are designed to provide reasonable protection against harmful interference in a residential installation. This equipment generates uses and can radiate radio frequency energy and, if not installed and used in accordance with the instructions, may cause harmful interference to radio communications. However, there is no guarantee that interference will not occur in a particular installation. If this equipment does cause harmful interference to radio or television reception, which can be determined by turning the equipment off and on, the user is encouraged to try to correct the interference by one or more of the following measures:

- Reorient or relocate the receiving antenna.
- Increase the separation between the equipment and receiver.
- Connect the equipment into an outlet on a circuit different from that to which the receiver is connected.
- Consult the dealer or an experienced radio/TV technician for help.