

## FCC Test Report

**Report No.:** RF151102C11-1

**FCC ID:** 2AG6R-AN700APIAC

**Test Model:** AN-700-AP-I-AC

**Received Date:** Nov. 02, 2015

**Test Date:** Nov. 13 ~ Dec. 21, 2015

**Issued Date:** Dec. 22, 2015

**Applicant:** Araknis Networks

**Address:** 1800 Continental Blvd. Ste 200, Charlotte, NC 28273, United States

**Issued By:** Bureau Veritas Consumer Products Services (H.K.) Ltd., Taoyuan Branch

**Lab Address:** No. 47-2, 14th Ling, Chia Pau Vil., Lin Kou Dist., New Taipei City, Taiwan, R.O.C.

**Test Location:** No.19, Hwa Ya 2nd Rd., Wen Hwa Vil., Kwei Shan Dist., Taoyuan City 33383, TAIWAN (R.O.C.)



This report is for your exclusive use. Any copying or replication of this report to or for any other person or entity, or use of our name or trademark, is permitted only with our prior written permission. This report sets forth our findings solely with respect to the test samples identified herein. The results set forth in this report are not indicative or representative of the quality or characteristics of the lot from which a test sample was taken or any similar or identical product unless specifically and expressly noted. Our report includes all of the tests requested by you and the results thereof based upon the information that you provided to us. You have 60 days from date of issuance of this report to notify us of any material error or omission caused by our negligence, provided, however, that such notice shall be in writing and shall specifically address the issue you wish to raise. A failure to raise such issue within the prescribed time shall constitute your unqualified acceptance of the completeness of this report, the tests conducted and the correctness of the report contents. Unless specific mention, the uncertainty of measurement has been explicitly taken into account to declare the compliance or non-compliance to the specification. The report must not be used by the client to claim product certification, approval, or endorsement by TAF or any government agencies.



## Table of Contents

<b>Release Control Record</b> .....	<b>4</b>
<b>1 Certificate of Conformity</b> .....	<b>5</b>
<b>2 Summary of Test Results</b> .....	<b>6</b>
2.1 Measurement Uncertainty.....	6
2.2 Modification Record.....	6
<b>3 General Information</b> .....	<b>7</b>
3.1 General Description of EUT.....	7
3.2 Description of Test Modes.....	9
3.2.1 Test Mode Applicability and Tested Channel Detail.....	10
3.3 Duty Cycle of Test Signal.....	12
3.4 Description of Support Units.....	13
3.4.1 Configuration of System under Test.....	13
3.5 General Description of Applied Standards.....	15
<b>4 Test Types and Results</b> .....	<b>16</b>
4.1 Radiated Emission and Bandedge Measurement.....	16
4.1.1 Limits of Radiated Emission and Bandedge Measurement.....	16
4.1.2 Test Instruments.....	17
4.1.3 Test Procedures.....	18
4.1.4 Deviation from Test Standard.....	18
4.1.5 Test Set Up.....	19
4.1.6 EUT Operating Conditions.....	19
4.1.7 Test Results.....	20
4.2 Conducted Emission Measurement.....	40
4.2.1 Limits of Conducted Emission Measurement.....	40
4.2.2 Test Instruments.....	40
4.2.3 Test Procedures.....	41
4.2.4 Deviation from Test Standard.....	41
4.2.5 Test Setup.....	41
4.2.6 EUT Operating Conditions.....	41
4.2.7 Test Results.....	42
4.3 Transmit Power Measurement.....	46
4.3.1 Limits of Transmit Power Measurement.....	46
4.3.2 Test Setup.....	46
4.3.3 Test Instruments.....	46
4.3.4 Test Procedure.....	47
4.3.5 Deviation from Test Standard.....	47
4.3.6 EUT Operating Conditions.....	47
4.3.7 Test Result.....	48
4.4 Peak Power Spectral Density Measurement.....	53
4.4.1 Limits of Peak Power Spectral Density Measurement.....	53
4.4.2 Test Setup.....	53
4.4.3 Test Instruments.....	53
4.4.4 Test Procedures.....	53
4.4.5 Deviation from Test Standard.....	54
4.4.6 EUT Operating Conditions.....	54
4.4.7 Test Results.....	55
4.5 Frequency Stability.....	60
4.5.1 Limits of Frequency Stability Measurement.....	60
4.5.2 Test Setup.....	60
4.5.3 Test Instruments.....	60
4.5.4 Test Procedure.....	60
4.5.5 Deviation from Test Standard.....	60
4.5.6 EUT Operating Condition.....	60



4.5.7 Test Results .....	61
4.6 6dB Bandwidth Measurement .....	62
4.6.1 Limits of 6dB Bandwidth Measurement .....	62
4.6.2 Test Setup .....	62
4.6.3 Test Instruments .....	62
4.6.4 Test Procedure .....	62
4.6.5 Deviation from Test Standard .....	62
4.6.6 EUT Operating Condition .....	62
4.6.7 Test Results .....	63
<b>5 Pictures of Test Arrangements .....</b>	<b>65</b>
<b>Appendix – Information on the Testing Laboratories .....</b>	<b>66</b>



### Release Control Record

Issue No.	Description	Date Issued
RF151102C11-1	Original release.	Dec. 22, 2015

## 1 Certificate of Conformity

**Product:** Araknis Networks 700-series Dual-Band Concurrent Wireless-AC Indoor Access Point

**Brand:** Araknis Networks ®

**Test Model:** AN-700-AP-I-AC

**Sample Status:** Engineering sample

**Applicant:** Araknis Networks

**Test Date:** Nov. 13 ~ Dec. 21, 2015

**Standards:** 47 CFR FCC Part 15, Subpart E (Section 15.407)  
ANSI C63.10:2013

The above equipment has been tested by **Bureau Veritas Consumer Products Services (H.K.) Ltd., Taoyuan Branch**, and found compliance with the requirement of the above standards. The test record, data evaluation & Equipment Under Test (EUT) configurations represented herein are true and accurate accounts of the measurements of the sample's EMC characteristics under the conditions specified in this report.

**Prepared by :** , **Date:** Dec. 22, 2015  
Polly Chien / Specialist

**Approved by :** , **Date:** Dec. 22, 2015  
Ken Liu / Senior Manager

## 2 Summary of Test Results

47 CFR FCC Part 15, Subpart E (Section 15.407)			
FCC Clause	Test Item	Result	Remarks
15.207 15.407(b)(6)	AC Power Conducted Emissions	Pass	Meet the requirement of limit. Minimum passing margin is -13.36dB at 0.32595MHz
15.407(b) (1/2/3/4/6)	Radiated Emissions & Band Edge Measurement	Pass	Meet the requirement of limit. Minimum passing margin is -1.0dB at 5714.00MHz
15.407(a)(1/2 /3)	Max Average Transmit Power	Pass	Meet the requirement of limit.
15.407(a)(1/2 /3)	Peak Power Spectral Density	Pass	Meet the requirement of limit.
15.407(e)	6dB bandwidth	Pass	Meet the requirement of limit. (U-NII-3 Band only)
15.407(g)	Frequency Stability	Pass	Meet the requirement of limit.
15.203	Antenna Requirement	Pass	Antenna connector is IPEX not a standard connector.

### 2.1 Measurement Uncertainty

Where relevant, the following measurement uncertainty levels have been estimated for tests performed on the EUT as specified in CISPR 16-4-2:

Measurement	Frequency	Expanded Uncertainty (k=2) (±)
Conducted Emissions at mains ports0	150kHz ~ 30MHz	2.44 dB
Radiated Emissions up to 1 GHz	30MHz ~ 200MHz	3.86 dB
	200MHz ~1000MHz	3.87 dB
Radiated Emissions above 1 GHz	1GHz ~ 18GHz	2.29 dB
	18GHz ~ 40GHz	2.29 dB

### 2.2 Modification Record

There were no modifications required for compliance.

### 3 General Information

#### 3.1 General Description of EUT

Product	Araknis Networks 700-series Dual-Band Concurrent Wireless-AC Indoor Access Point
Brand	Araknis Networks ®
Test Model	AN-700-AP-I-AC
Status of EUT	Engineering sample
Power Supply Rating	12Vdc from adapter 48Vdc from PoE
Modulation Type	256QAM, 64QAM, 16QAM, QPSK, BPSK for OFDM
Modulation Technology	OFDM
Transfer Rate	802.11a: 54.0/ 48.0/ 36.0/ 24.0/ 18.0/ 12.0/ 9.0/ 6.0Mbps 802.11n: up to 450Mbps 802.11ac: up to 1300Mbps
Operating Frequency	5180 ~ 5240MHz, 5745 ~ 5825MHz
Number of Channel	5180 ~ 5240MHz: 4 for 802.11a, 802.11n (HT20), 802.11ac (VHT20) 2 for 802.11n (HT40), 802.11ac (VHT40) 1 for 802.11ac (VHT80) 5745 ~ 5825MHz: 5 for 802.11a, 802.11n (HT20), 802.11ac (VHT20) 2 for 802.11n (HT40), 802.11ac (VHT40) 1 for 802.11ac (VHT80)
Output Power	5180 ~ 5240MHz: 490.895mW 5745 ~ 5825MHz: 181.476mW
Antenna Type	Refer to note
Antenna Connector	Refer to note
Accessory Device	Adapter
Data Cable Supplied	0.5m RJ45 non-shielded cable w/o core

**Note:**

1. The EUT incorporates a MIMO function. Physically, the EUT provides 3 completed transmitters and 3 receivers.

Modulation Mode	TX Function
802.11a	3TX
802.11n (HT20)	3TX
802.11n (HT40)	3TX
802.11ac (VHT20)	3TX
802.11ac (VHT40)	3TX
802.11ac (VHT80)	3TX

\* The modulation and bandwidth are similar for 802.11n mode for 20MHz/40MHz and 802.11ac mode for 20MHz/40MHz, therefore investigated worst case to representative mode in test report. (Final test mode refer section 3.2.1)

2. The following antennas were provided to the EUT.

Antenna Type	PIFA		
Antenna Connector	IPEX		
Gain (dBi)			
Item	2400-2500 MHz	Item	5150-5870 MHz
Ant. 1	4	Ant. 4	5
Ant. 2	4	Ant. 5	5
Ant. 3	4	Ant. 6	5

3. The EUT consumes power from the following adapter and PoE.

Adapter	
Brand	Powertron Electronics Corp.
Model	PA1024-120HUB200
Input Power	100-240Vac, 50-60Hz, 0.6A
Output Power	12Vdc/ 2.0A, 24W Max
Power Line	DC 1.5m power cable with 1 core attached on adapter

PoE (support unit)	
Brand	EnGenius
Model	EPE-48GR
Rating	48Vdc, 0.8A, 38.4W Max

Adapter of PoE (support unit)	
Brand	Powertron Electronics Corp.
Model	PA1040-480IB080
Input Power	100-240Vac, 50-60Hz 1.5A
Output Power	48Vdc, 0.8A, 38.4W Max
Power Line	DC 1.5m power cable with 1 core attached on adapter



### 3.2 Description of Test Modes

#### For 5180 ~ 5240MHz

4 channels are provided for 802.11a, 802.11n (HT20), 802.11ac (VHT20):

Channel	Frequency	Channel	Frequency
36	5180 MHz	44	5220 MHz
40	5200 MHz	48	5240 MHz

2 channels are provided for 802.11n (HT40), 802.11ac (VHT40):

Channel	Frequency	Channel	Frequency
38	5190 MHz	46	5230 MHz

1 channel is provided for 802.11ac (VHT80):

Channel	Frequency
42	5210MHz

#### For 5745 ~ 5825MHz

5 channels are provided for 802.11a, 802.11n (HT20), 802.11ac (VHT20):

Channel	Frequency	Channel	Frequency
149	5745MHz	161	5805MHz
153	5765MHz	165	5825MHz
157	5785MHz		

2 channels are provided for 802.11n (HT40), 802.11ac (VHT40):

Channel	Frequency	Channel	Frequency
151	5755MHz	159	5795MHz

1 channel is provided for 802.11ac (VHT80):

Channel	Frequency
155	5775MHz

### 3.2.1 Test Mode Applicability and Tested Channel Detail

EUT CONFIGURE MODE	APPLICABLE TO				DESCRIPTION
	RE $\geq$ 1G	RE<1G	PLC	APCM	
A	√	√	√	√	Power from adapter
B	-	√	√	-	Power from PoE

Where **RE $\geq$ 1G**: Radiated Emission above 1GHz & Bandedge Measurement  
**RE<1G**: Radiated Emission below 1GHz  
**PLC**: Power Line Conducted Emission  
**APCM**: Antenna Port Conducted Measurement

**Note:**

1. The EUT had been pre-tested on the positioned of each 3 axis. The worst case was found when positioned on **Z-plane**.
2. "-" means no effect.

#### Radiated Emission Test (Above 1GHz):

- Pre-Scan has been conducted to determine the worst-case mode from all possible combinations between available modulations, data rates and antenna ports (if EUT with antenna diversity architecture).
- Following channel(s) was (were) selected for the final test as listed below.

EUT CONFIGURE MODE	MODE	FREQ. BAND (MHz)	AVAILABLE CHANNEL	TESTED CHANNEL	MODULATION TECHNOLOGY	MODULATION TYPE	DATA RATE (Mbps)
A	802.11a	5180-5240	36 to 48	36, 40, 48	OFDM	BPSK	6.0
A	802.11n (HT20)		36 to 48	36, 40, 48	OFDM	BPSK	7.2
A	802.11n (HT40)		38 to 46	38, 46	OFDM	BPSK	15.0
A	802.11ac (VHT80)		42	42	OFDM	BPSK	97.5
A	802.11a	5745-5825	149 to 165	149, 157, 165	OFDM	BPSK	6.0
A	802.11n (HT20)		149 to 165	149, 157, 165	OFDM	BPSK	7.2
A	802.11n (HT40)		151 to 159	151, 159	OFDM	BPSK	15.0
A	802.11ac (VHT80)		155	155	OFDM	BPSK	97.5

#### Radiated Emission Test (Below 1GHz):

- Pre-Scan has been conducted to determine the worst-case mode from all possible combinations between available modulations, data rates and antenna ports (if EUT with antenna diversity architecture).
- Following channel(s) was (were) selected for the final test as listed below.

EUT CONFIGURE MODE	MODE	FREQ. BAND (MHz)	AVAILABLE CHANNEL	TESTED CHANNEL	MODULATION TECHNOLOGY	MODULATION TYPE	DATA RATE (Mbps)
A, B	802.11n (HT20)	5180-5240	36 to 48	40	OFDM	BPSK	7.2
		5745-5825	149 to 165				

**Power Line Conducted Emission Test:**

- Pre-Scan has been conducted to determine the worst-case mode from all possible combinations between available modulations, data rates and antenna ports (if EUT with antenna diversity architecture).
- Following channel(s) was (were) selected for the final test as listed below.

EUT CONFIGURE MODE	MODE	FREQ. BAND (MHz)	AVAILABLE CHANNEL	TESTED CHANNEL	MODULATION TECHNOLOGY	MODULATION TYPE	DATA RATE (Mbps)
A, B	802.11n (HT20)	5180-5240	36 to 48	40	OFDM	BPSK	7.2
		5745-5825	149 to 165				

**Antenna Port Conducted Measurement:**

- This item includes all test value of each mode, but only includes spectrum plot of worst value of each mode.
- Pre-Scan has been conducted to determine the worst-case mode from all possible combinations between available modulations, data rates and antenna ports (if EUT with antenna diversity architecture).
- Following channel(s) was (were) selected for the final test as listed below.

EUT CONFIGURE MODE	MODE	FREQ. BAND (MHz)	AVAILABLE CHANNEL	TESTED CHANNEL	MODULATION TECHNOLOGY	MODULATION TYPE	DATA RATE (Mbps)
A	802.11a	5180-5240	36 to 48	36, 40, 48	OFDM	BPSK	6.0
A	802.11n (HT20)		36 to 48	36, 40, 48	OFDM	BPSK	7.2
A	802.11n (HT40)		38 to 46	38, 46	OFDM	BPSK	15.0
A	802.11ac (VHT80)		42	42	OFDM	BPSK	97.5
A	802.11a	5745-5825	149 to 165	149, 157, 165	OFDM	BPSK	6.0
A	802.11n (HT20)		149 to 165	149, 157, 165	OFDM	BPSK	7.2
A	802.11n (HT40)		151 to 159	151, 159	OFDM	BPSK	15.0
A	802.11ac (VHT80)		155	155	OFDM	BPSK	97.5

**Test Condition:**

APPLICABLE TO	ENVIRONMENTAL CONDITIONS	INPUT POWER	TESTED BY
RE≥1G	18deg. C, 70%RH	120Vac, 60Hz	Nick Hsu, Jones Chang
RE<1G	18deg. C, 70%RH	120Vac, 60Hz, 48Vdc	Nick Hsu
PLC	25deg. C, 70%RH	120Vac, 60Hz, 48Vdc	Jones Chang
APCM	25deg. C, 60%RH	120Vac, 60Hz	Leo Tsai

### 3.3 Duty Cycle of Test Signal

Duty cycle of test signal is < 98 %, duty factor is required.

802.11a: Duty cycle =  $2.022/2.112 = 0.957$ , Duty factor =  $10 * \log(1/0.957) = 0.19$

802.11n (HT20): Duty cycle =  $1.875/1.950 = 0.962$ , Duty factor =  $10 * \log(1/0.962) = 0.17$

802.11n (HT40): Duty cycle =  $0.927/1.024 = 0.902$ , Duty factor =  $10 * \log(1/0.902) = 0.45$

802.11ac (VHT80): Duty cycle =  $0.455/0.537 = 0.847$ , Duty factor =  $10 * \log(1/0.847) = 0.72$

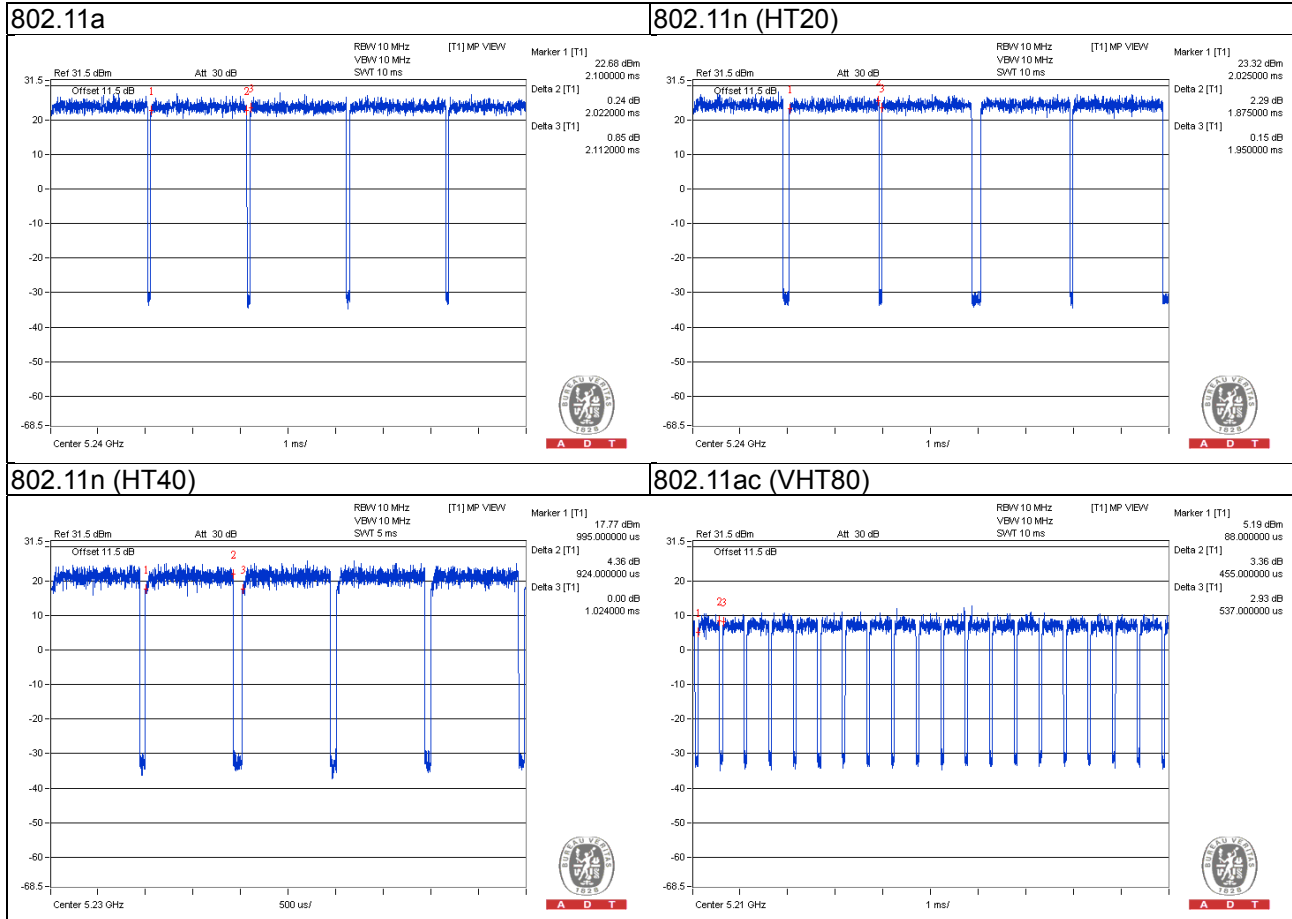

### 3.4 Description of Support Units

The EUT has been tested as an independent unit together with other necessary accessories or support units. The following support units or accessories were used to form a representative test configuration during the tests.

ID	Product	Brand	Model No.	Serial No.	FCC ID	Remarks
A.	Notebook	DELL	E5410	1HC2XM1	FCC DoC Approved	-
B.	PoE	EnGenius	EPE-48GR	NA	NA	Supplied by the manufacturer
C.	Adapter of PoE	Powertron Electronics Corp.	PA1040-480IB080	NA	NA	Supplied by the manufacturer

Note:

1. All power cords of the above support units are non-shielded (1.8m).
2. Items A acted as a communication partner to transfer data.

ID	Descriptions	Qty.	Length (m)	Shielding (Yes/No)	Cores (Qty.)	Remarks
1.	LAN cable	1	5	N	0	-
2.	LAN cable	1	1.8	N	0	-
3.	DC cable	1	1.5	-	1	Attached on adapter of PoE

#### 3.4.1 Configuration of System under Test

<Test Mode A>

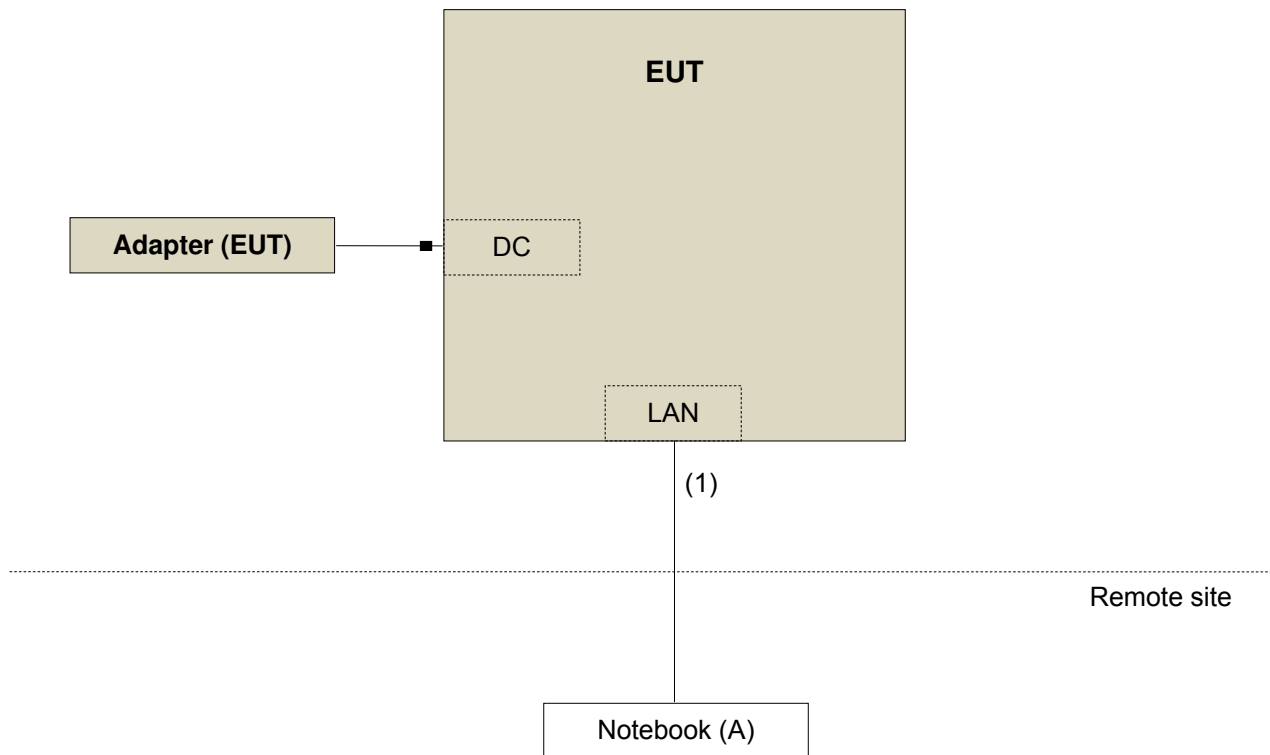

<Test Mode B>

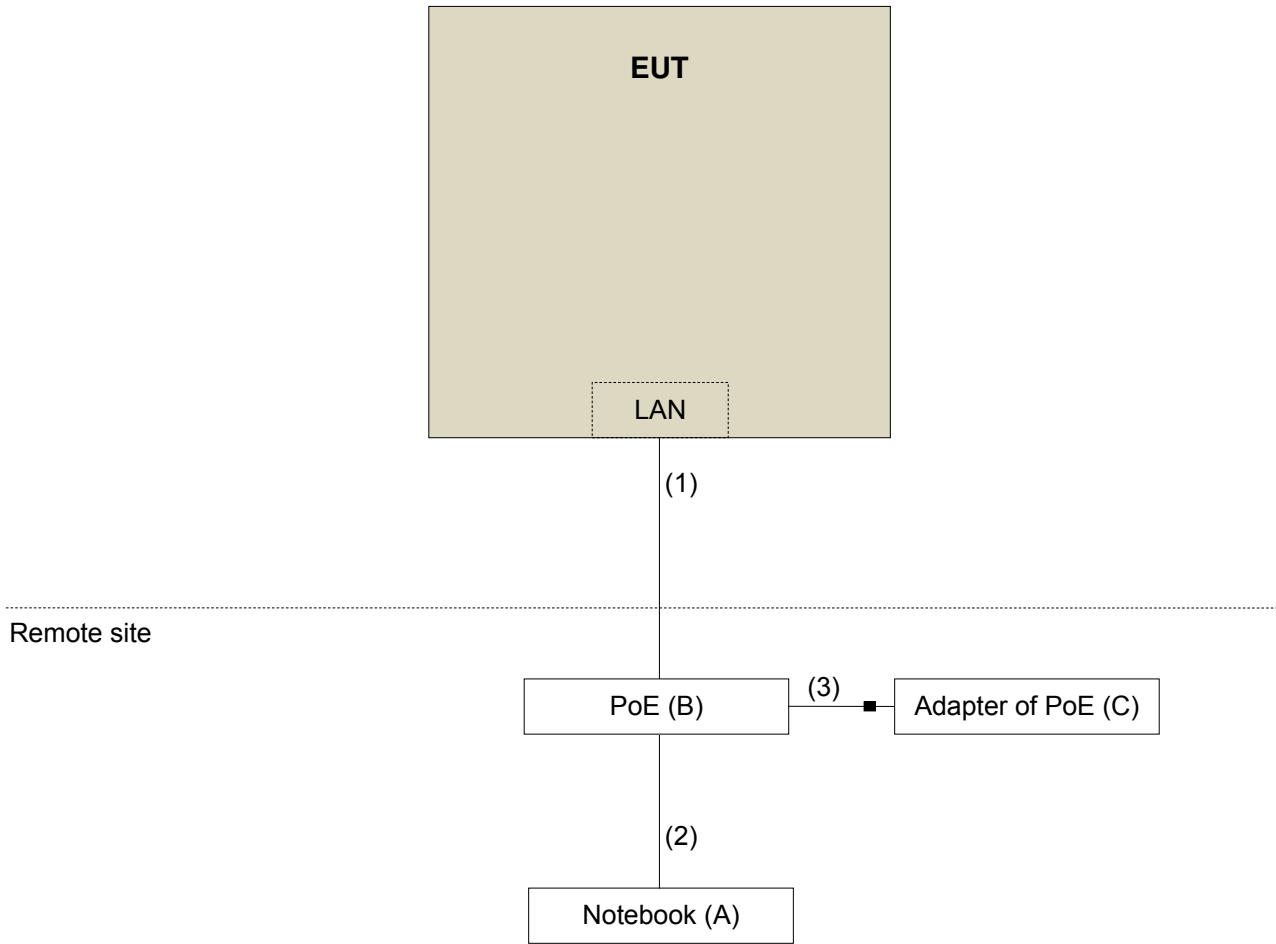

### 3.5 General Description of Applied Standards

The EUT is a RF Product. According to the specifications of the manufacturer, it must comply with the requirements of the following standards:

**FCC Part 15, Subpart E (15.407)**

**789033 D02 General UNII Test Procedures New Rules v01r01**

**662911 D01 Multiple Transmitter Output v02r01**

ANSI C63.10-2013

All test items have been performed and recorded as per the above standards.

Note: The EUT is also considered as a kind of computer peripheral, because the connection to computer is necessary for typical use. It has been verified to comply with the requirements of FCC Part 15, Subpart B, Class B (DoC). The test report has been issued separately.

## 4 Test Types and Results

### 4.1 Radiated Emission and Bandedge Measurement

#### 4.1.1 Limits of Radiated Emission and Bandedge Measurement

Radiated emissions which fall in the restricted bands must comply with the radiated emission limits specified as below table.

Frequencies (MHz)	Field Strength (microvolts/meter)	Measurement Distance (meters)
0.009 ~ 0.490	2400/F(kHz)	300
0.490 ~ 1.705	24000/F(kHz)	30
1.705 ~ 30.0	30	30
30 ~ 88	100	3
88 ~ 216	150	3
216 ~ 960	200	3
Above 960	500	3

**NOTE:**

1. The lower limit shall apply at the transition frequencies.
2. Emission level (dBuV/m) = 20 log Emission level (uV/m).
3. For frequencies above 1000MHz, the field strength limits are based on average detector, however, the peak field strength of any emission shall not exceed the maximum permitted average limits, specified above by more than 20dB under any condition of modulation.

**LIMITS OF UNWANTED EMISSION OUT OF THE RESTRICTED BANDS**

APPLICABLE TO	LIMIT	
789033 D02 General UNII Test Procedures New Rules v01r01	FIELD STRENGTH AT 3m	
	PK:74 (dBµV/m)	AV:54 (dBµV/m)
APPLICABLE TO	EIRP LIMIT	EQUIVALENT FIELD STRENGTH AT 3m
15.407(b)(1)	PK:-27 (dBm/MHz)	PK:68.2 (dBµV/m)
15.407(b)(2)		
15.407(b)(3)		
15.407(b)(4)	PK:-27 (dBm/MHz) <sup>*1</sup> PK:-17 (dBm/MHz) <sup>*2</sup>	PK: 68.2 (dBµV/m) <sup>*1</sup> PK:78.2 (dBµV/m) <sup>*2</sup>

**NOTE:** <sup>\*1</sup> beyond 10MHz of the band edge    <sup>\*2</sup> within 10 MHz of band edge

The following formula is used to convert the equipment isotropic radiated power (eirp) to field strength:

$$E = \frac{1000000 \sqrt{30P}}{3} \text{ } \mu\text{V/m, where P is the eirp (Watts).}$$



#### 4.1.2 Test Instruments

Description & Manufacturer	Model No.	Serial No.	Cal. Date	Cal. Due
Test Receiver ROHDE & SCHWARZ	ESIB7	100187	Apr. 10, 2015	Apr. 09, 2016
Spectrum Analyzer ROHDE & SCHWARZ	FSP40	100041	Sep. 02, 2015	Sep. 01, 2016
BILOG Antenna SCHWARZBECK	VULB9168	9168-160	Feb. 05, 2015	Feb. 04, 2016
HORN Antenna SCHWARZBECK	9120D	209	Feb. 09, 2015	Feb. 08, 2016
HORN Antenna SCHWARZBECK	BBHA 9170	BBHA9170241	Feb. 09, 2015	Feb. 08, 2016
Preamplifier Agilent	8447D	2944A10738	Oct. 18, 2015	Oct. 17, 2016
Preamplifier Agilent	8449B	3008A01964	Aug. 22, 2015	Aug. 21, 2016
RF signal cable HUBER+SUHNER	SUCOFLEX 104	Cable-CH3-03 (214378)	Aug. 22, 2015	Aug. 21, 2016
RF signal cable HUBER+SUHNER	SUCOFLEX 106	Cable-CH3-03 (309224+12738)	Aug. 22, 2015	Aug. 21, 2016
Software BV ADT	ADT_Radiated_ V7.6.15.9.4	NA	NA	NA
Antenna Tower inn-co GmbH	MA 4000	013303	NA	NA
Antenna Tower Controller BV ADT	AT100	AT93021702	NA	NA
Turn Table BV ADT	TT100	TT93021702	NA	NA
Turn Table Controller BV ADT	SC100	SC93021702	NA	NA
High Speed Peak Power Meter	ML2495A	0824011	Jul. 09, 2015	Jul. 08, 2016
Power Sensor	MA2411B	0738171	Jul. 09, 2015	Jul. 08, 2016
WIT Standard Temperature And Humidity Chamber	TH-4S-C	W981030	Jun. 08, 2015	Jun. 07, 2016

- Note:
1. The calibration interval of the above test instruments is 12 months and the calibrations are traceable to NML/ROC and NIST/USA.
  2. The test was performed in HwaYa Chamber 3.
  3. The horn antenna and preamplifier (model: 8449B) are used only for the measurement of emission frequency above 1GHz if tested.
  4. The FCC Site Registration No. is 988962.
  5. The IC Site Registration No. is IC 7450F-3.

#### 4.1.3 Test Procedures

- a. The EUT was placed on the top of a rotating table 0.8 meters (for below 1GHz) / 1.5 meters (for above 1GHz) above the ground at 3 meter chamber room for test. The table was rotated 360 degrees to determine the position of the highest radiation.
- b. The EUT was set 3 meters away from the interference-receiving antenna, which was mounted on the top of a variable-height antenna tower.
- c. The height of antenna is varied from one meter to four meters above the ground to determine the maximum value of the field strength. Both horizontal and vertical polarizations of the antenna are set to make the measurement.
- d. For each suspected emission, the EUT was arranged to its worst case and then the antenna was tuned to heights from 1 meter to 4 meters and the rotatable table was turned from 0 degrees to 360 degrees to find the maximum reading.
- e. The test-receiver system was set to quasi-peak detect function and specified bandwidth with maximum hold mode when the test frequency is below 1 GHz.
- f. The test-receiver system was set to peak and average detect function and specified bandwidth with maximum hold mode when the test frequency is above 1 GHz. If the peak reading value also meets average limit, measurement with the average detector is unnecessary.

**Note:**

1. The resolution bandwidth and video bandwidth of test receiver/spectrum analyzer is 120kHz for Quasi-peak detection (QP) at frequency below 1GHz.
2. The resolution bandwidth of test receiver/spectrum analyzer is 1 MHz and the video bandwidth is 3 MHz for Peak detection (PK) at frequency above 1GHz.
3. The resolution bandwidth of test receiver/spectrum analyzer is 1MHz and the video bandwidth is 3MHz for RMS Average (Duty cycle < 98%) for Average detection (AV) at frequency above 1GHz, then the measurement results was added to a correction factor ( $10 \log(1/\text{duty cycle})$ ).
4. The resolution bandwidth of test receiver/spectrum analyzer is 1MHz and the video bandwidth is 10Hz (Duty cycle  $\geq 98\%$ ) for Average detection (AV) at frequency above 1GHz.
5. All modes of operation were investigated and the worst-case emissions are reported.

#### 4.1.4 Deviation from Test Standard

No deviation.

#### 4.1.5 Test Set Up

##### <Frequency Range below 1GHz>

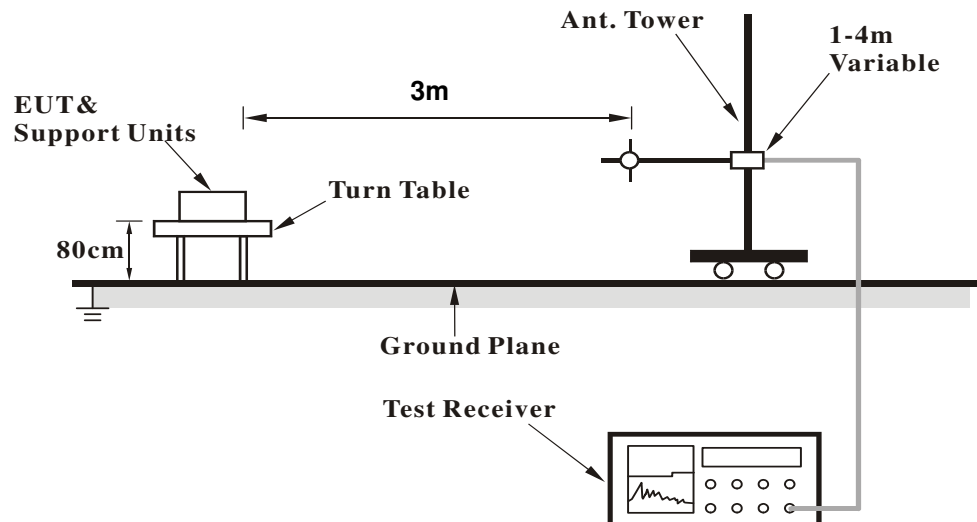

##### <Frequency Range above 1GHz>

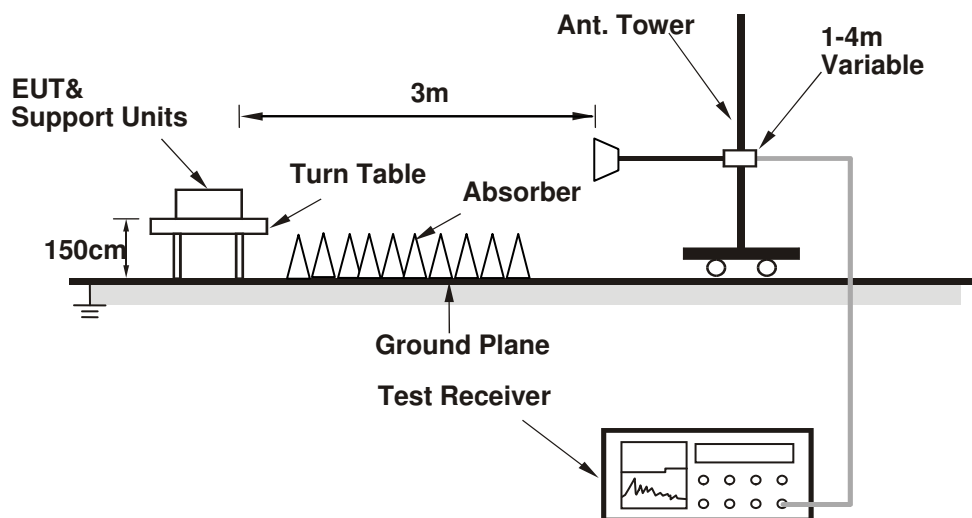

For the actual test configuration, please refer to the attached file (Test Setup Photo)

#### 4.1.6 EUT Operating Conditions

- Placed the EUT on the testing table.
- Prepared notebook to act as communication partner and placed it outside of testing area.
- The communication partner connected with EUT via a RJ45 cable and ran a test program (provided by manufacturer) to enable EUT under transmission condition continuously at specific channel frequency.
- The communication partner sent data to EUT by command "PING".
- The necessary accessories enable the system in full functions.

#### 4.1.7 Test Results

Above 1GHz Worst-Case Data:

802.11a

CHANNEL	TX Channel 36	DETECTOR FUNCTION	Peak (PK)
FREQUENCY RANGE	1GHz ~ 40GHz		Average (AV)

#### ANTENNA POLARITY & TEST DISTANCE: HORIZONTAL AT 3 M

NO.	FREQ. (MHz)	EMISSION LEVEL (dBuV/m)	LIMIT (dBuV/m)	MARGIN (dB)	ANTENNA HEIGHT (m)	TABLE ANGLE (Degree)	RAW VALUE (dBuV)	CORRECTION FACTOR (dB/m)
1	5150.00	67.5 PK	74.0	-6.5	1.28 H	284	61.30	6.20
2	5150.00	52.5 AV	54.0	-1.5	1.28 H	284	46.30	6.20
3	*5180.00	118.9 PK			1.01 H	278	79.40	39.50
4	*5180.00	108.4 AV			1.01 H	278	68.90	39.50
5	10360.00	59.1 PK	74.0	-14.9	1.00 H	340	42.10	17.00
6	10360.00	46.5 AV	54.0	-7.5	1.00 H	340	29.50	17.00

#### ANTENNA POLARITY & TEST DISTANCE: VERTICAL AT 3 M

NO.	FREQ. (MHz)	EMISSION LEVEL (dBuV/m)	LIMIT (dBuV/m)	MARGIN (dB)	ANTENNA HEIGHT (m)	TABLE ANGLE (Degree)	RAW VALUE (dBuV)	CORRECTION FACTOR (dB/m)
1	5150.00	61.5 PK	74.0	-12.5	1.10 V	25	55.30	6.20
2	5150.00	47.4 AV	54.0	-6.6	1.10 V	25	41.20	6.20
3	*5180.00	112.2 PK			1.00 V	30	72.70	39.50
4	*5180.00	102.3 AV			1.00 V	30	62.80	39.50
5	10360.00	58.4 PK	74.0	-15.6	1.62 V	257	41.40	17.00
6	10360.00	45.9 AV	54.0	-8.1	1.62 V	257	28.90	17.00

Remarks:

1. Emission Level(dBuV/m) = Raw Value(dBuV) + Correction Factor(dB/m)
2. Correction Factor(dB/m) = Antenna Factor(dB/m) + Cable Factor(dB)
3. The other emission levels were very low against the limit.
4. Margin value = Emission Level – Limit value
5. " \* ": Fundamental frequency.

CHANNEL	TX Channel 40	DETECTOR FUNCTION	Peak (PK)
FREQUENCY RANGE	1GHz ~ 40GHz		Average (AV)

ANTENNA POLARITY & TEST DISTANCE: HORIZONTAL AT 3 M								
NO.	FREQ. (MHz)	EMISSION LEVEL (dBuV/m)	LIMIT (dBuV/m)	MARGIN (dB)	ANTENNA HEIGHT (m)	TABLE ANGLE (Degree)	RAW VALUE (dBuV)	CORRECTION FACTOR (dB/m)
1	*5200.00	122.6 PK			1.00 H	279	83.00	39.60
2	*5200.00	112.8 AV			1.00 H	279	73.20	39.60
3	10400.00	59.3 PK	74.0	-14.7	1.00 H	238	42.30	17.00
4	10400.00	46.4 AV	54.0	-7.6	1.00 H	238	29.40	17.00
5	15600.00	64.9 PK	74.0	-9.1	1.00 H	154	46.00	18.90
6	15600.00	52.4 AV	54.0	-1.6	1.00 H	154	33.50	18.90
ANTENNA POLARITY & TEST DISTANCE: VERTICAL AT 3 M								
NO.	FREQ. (MHz)	EMISSION LEVEL (dBuV/m)	LIMIT (dBuV/m)	MARGIN (dB)	ANTENNA HEIGHT (m)	TABLE ANGLE (Degree)	RAW VALUE (dBuV)	CORRECTION FACTOR (dB/m)
1	*5200.00	117.1 PK			1.00 V	38	77.50	39.60
2	*5200.00	107.2 AV			1.00 V	38	67.60	39.60
3	10400.00	58.6 PK	74.0	-15.4	1.33 V	266	41.60	17.00
4	10400.00	46.5 AV	54.0	-7.5	1.33 V	266	29.50	17.00
5	15600.00	62.6 PK	74.0	-11.4	1.18 V	113	43.70	18.90
6	15600.00	50.8 AV	54.0	-3.2	1.18 V	113	31.90	18.90

**Remarks:**

1. Emission Level(dBuV/m) = Raw Value(dBuV) + Correction Factor(dB/m)
2. Correction Factor(dB/m) = Antenna Factor(dB/m) + Cable Factor(dB)
3. The other emission levels were very low against the limit.
4. Margin value = Emission Level – Limit value
5. " \* ": Fundamental frequency.

CHANNEL	TX Channel 48	DETECTOR FUNCTION	Peak (PK)
FREQUENCY RANGE	1GHz ~ 40GHz		Average (AV)

**ANTENNA POLARITY & TEST DISTANCE: HORIZONTAL AT 3 M**

NO.	FREQ. (MHz)	EMISSION LEVEL (dBuV/m)	LIMIT (dBuV/m)	MARGIN (dB)	ANTENNA HEIGHT (m)	TABLE ANGLE (Degree)	RAW VALUE (dBuV)	CORRECTION FACTOR (dB/m)
1	*5240.00	123.6 PK			1.00 H	280	84.00	39.60
2	*5240.00	113.1 AV			1.00 H	280	73.50	39.60
3	5350.00	60.6 PK	74.0	-13.4	1.00 H	280	54.20	6.40
4	5350.00	48.3 AV	54.0	-5.7	1.00 H	280	41.90	6.40
5	10480.00	59.6 PK	74.0	-14.4	1.00 H	237	41.60	18.00
6	10480.00	46.5 AV	54.0	-7.5	1.00 H	237	28.50	18.00
7	15720.00	65.2 PK	74.0	-8.8	1.00 H	124	46.70	18.50
8	15720.00	52.3 AV	54.0	-1.7	1.00 H	124	33.80	18.50

**ANTENNA POLARITY & TEST DISTANCE: VERTICAL AT 3 M**

NO.	FREQ. (MHz)	EMISSION LEVEL (dBuV/m)	LIMIT (dBuV/m)	MARGIN (dB)	ANTENNA HEIGHT (m)	TABLE ANGLE (Degree)	RAW VALUE (dBuV)	CORRECTION FACTOR (dB/m)
1	*5240.00	117.3 PK			2.53 V	33	77.70	39.60
2	*5240.00	107.0 AV			2.53 V	33	67.40	39.60
3	5350.00	57.6 PK	74.0	-16.4	1.12 V	330	51.20	6.40
4	5350.00	45.1 AV	54.0	-8.9	1.12 V	330	38.70	6.40
5	10480.00	58.6 PK	74.0	-15.4	2.95 V	330	40.60	18.00
6	10480.00	46.6 AV	54.0	-7.4	2.95 V	330	28.60	18.00
7	15720.00	63.8 PK	74.0	-10.2	1.05 V	338	45.30	18.50
8	15720.00	51.8 AV	54.0	-2.2	1.05 V	338	33.30	18.50

**Remarks:**

1. Emission Level(dBuV/m) = Raw Value(dBuV) + Correction Factor(dB/m)
2. Correction Factor(dB/m) = Antenna Factor(dB/m) + Cable Factor(dB)
3. The other emission levels were very low against the limit.
4. Margin value = Emission Level – Limit value
5. " \* ": Fundamental frequency.

CHANNEL	TX Channel 149	DETECTOR FUNCTION	Peak (PK)
FREQUENCY RANGE	1GHz ~ 40GHz		Average (AV)

**ANTENNA POLARITY & TEST DISTANCE: HORIZONTAL AT 3 M**

NO.	FREQ. (MHz)	EMISSION LEVEL (dBuV/m)	LIMIT (dBuV/m)	MARGIN (dB)	ANTENNA HEIGHT (m)	TABLE ANGLE (Degree)	RAW VALUE (dBuV)	CORRECTION FACTOR (dB/m)
1	#5714.00	63.2 PK	74.0	-10.8	1.11 H	327	56.00	7.20
2	#5714.00	48.7 AV	54.0	-5.3	1.11 H	327	41.50	7.20
3	#5722.00	67.9 PK	78.2	-10.3	1.00 H	318	60.70	7.20
4	#5725.00	58.3 PK	78.2	-19.9	1.00 H	283	51.10	7.20
5	*5745.00	116.5 PK			2.55 H	278	76.10	40.40
6	*5745.00	105.9 AV			2.55 H	278	65.50	40.40
7	11490.00	62.0 PK	74.0	-12.0	2.37 H	327	43.70	18.30
8	11490.00	49.4 AV	54.0	-4.6	2.37 H	327	31.10	18.30

**ANTENNA POLARITY & TEST DISTANCE: VERTICAL AT 3 M**

NO.	FREQ. (MHz)	EMISSION LEVEL (dBuV/m)	LIMIT (dBuV/m)	MARGIN (dB)	ANTENNA HEIGHT (m)	TABLE ANGLE (Degree)	RAW VALUE (dBuV)	CORRECTION FACTOR (dB/m)
1	#5714.00	63.2 PK	74.0	-10.8	2.21 V	328	56.00	7.20
2	#5714.00	49.5 AV	54.0	-4.5	2.21 V	328	42.30	7.20
3	#5722.00	70.5 PK	78.2	-7.7	2.89 V	327	63.30	7.20
4	#5725.00	57.1 PK	78.2	-21.1	2.89 V	323	49.90	7.20
5	*5745.00	114.3 PK			3.93 V	319	73.90	40.40
6	*5745.00	103.6 AV			3.93 V	319	63.20	40.40
7	11490.00	65.3 PK	74.0	-8.7	1.70 V	300	47.00	18.30
8	11490.00	52.7 AV	54.0	-1.3	1.70 V	300	34.40	18.30

**Remarks:**

1. Emission Level(dBuV/m) = Raw Value(dBuV) + Correction Factor(dB/m)
2. Correction Factor(dB/m) = Antenna Factor(dB/m) + Cable Factor(dB)
3. The other emission levels were very low against the limit.
4. Margin value = Emission Level – Limit value
5. " \* ": Fundamental frequency.
6. " # ": The radiated frequency is out of the restricted band.

CHANNEL	TX Channel 157	DETECTOR FUNCTION	Peak (PK)
FREQUENCY RANGE	1GHz ~ 40GHz		Average (AV)

**ANTENNA POLARITY & TEST DISTANCE: HORIZONTAL AT 3 M**

NO.	FREQ. (MHz)	EMISSION LEVEL (dBuV/m)	LIMIT (dBuV/m)	MARGIN (dB)	ANTENNA HEIGHT (m)	TABLE ANGLE (Degree)	RAW VALUE (dBuV)	CORRECTION FACTOR (dB/m)
1	*5785.00	116.7 PK			3.90 H	287	76.20	40.50
2	*5785.00	106.3 AV			3.90 H	287	65.80	40.50
3	11570.00	63.3 PK	74.0	-10.7	1.00 H	8	45.10	18.20
4	11570.00	50.4 AV	54.0	-3.6	1.00 H	8	32.20	18.20

**ANTENNA POLARITY & TEST DISTANCE: VERTICAL AT 3 M**

NO.	FREQ. (MHz)	EMISSION LEVEL (dBuV/m)	LIMIT (dBuV/m)	MARGIN (dB)	ANTENNA HEIGHT (m)	TABLE ANGLE (Degree)	RAW VALUE (dBuV)	CORRECTION FACTOR (dB/m)
1	*5785.00	115.7 PK			3.82 V	328	75.20	40.50
2	*5785.00	104.6 AV			3.82 V	328	64.10	40.50
3	11570.00	65.6 PK	74.0	-8.4	1.73 V	307	47.40	18.20
4	11570.00	52.7 AV	54.0	-1.3	1.73 V	307	34.50	18.20

**Remarks:**

1. Emission Level(dBuV/m) = Raw Value(dBuV) + Correction Factor(dB/m)
2. Correction Factor(dB/m) = Antenna Factor(dB/m) + Cable Factor(dB)
3. The other emission levels were very low against the limit.
4. Margin value = Emission Level – Limit value
5. " \* " : Fundamental frequency.



CHANNEL	TX Channel 165	DETECTOR FUNCTION	Peak (PK)
FREQUENCY RANGE	1GHz ~ 40GHz		Average (AV)

**ANTENNA POLARITY & TEST DISTANCE: HORIZONTAL AT 3 M**

NO.	FREQ. (MHz)	EMISSION LEVEL (dBuV/m)	LIMIT (dBuV/m)	MARGIN (dB)	ANTENNA HEIGHT (m)	TABLE ANGLE (Degree)	RAW VALUE (dBuV)	CORRECTION FACTOR (dB/m)
1	*5825.00	117.3 PK			2.58 H	13	76.80	40.50
2	*5825.00	106.9 AV			2.58 H	13	66.40	40.50
3	#5850.00	49.4 PK	78.2	-28.8	2.35 H	18	41.90	7.50
4	#5852.10	62.2 PK	78.2	-16.0	1.82 H	195	54.60	7.60
5	5860.10	60.1 PK	74.0	-13.9	2.08 H	282	52.50	7.60
6	5860.10	47.1 AV	54.0	-6.9	2.08 H	282	39.50	7.60
7	11570.00	62.4 PK	74.0	-11.6	1.02 H	7	44.20	18.20
8	11570.00	49.9 AV	54.0	-4.1	1.02 H	7	31.70	18.20

**ANTENNA POLARITY & TEST DISTANCE: VERTICAL AT 3 M**

NO.	FREQ. (MHz)	EMISSION LEVEL (dBuV/m)	LIMIT (dBuV/m)	MARGIN (dB)	ANTENNA HEIGHT (m)	TABLE ANGLE (Degree)	RAW VALUE (dBuV)	CORRECTION FACTOR (dB/m)
1	*5825.00	111.2 PK			2.88 V	1	70.70	40.50
2	*5825.00	101.6 AV			2.88 V	1	61.10	40.50
3	#5850.00	46.8 PK	78.2	-31.4	2.86 V	0	39.30	7.50
4	#5852.10	61.3 PK	78.2	-16.9	3.00 V	0	53.70	7.60
5	5860.10	47.8 PK	74.0	-26.2	1.33 V	132	40.20	7.60
6	5860.10	35.8 AV	54.0	-18.2	1.33 V	132	28.20	7.60
7	11650.00	65.8 PK	74.0	-8.2	1.70 V	306	47.10	18.70
8	11650.00	52.9 AV	54.0	-1.1	1.70 V	306	34.20	18.70

**Remarks:**

1. Emission Level(dBuV/m) = Raw Value(dBuV) + Correction Factor(dB/m)
2. Correction Factor(dB/m) = Antenna Factor(dB/m) + Cable Factor(dB)
3. The other emission levels were very low against the limit.
4. Margin value = Emission Level – Limit value
5. " \* ": Fundamental frequency.
6. " # ": The radiated frequency is out of the restricted band.

**802.11n (HT20)**

CHANNEL	TX Channel 36	DETECTOR FUNCTION	Peak (PK)
FREQUENCY RANGE	1GHz ~ 40GHz		Average (AV)

**ANTENNA POLARITY & TEST DISTANCE: HORIZONTAL AT 3 M**

NO.	FREQ. (MHz)	EMISSION LEVEL (dBuV/m)	LIMIT (dBuV/m)	MARGIN (dB)	ANTENNA HEIGHT (m)	TABLE ANGLE (Degree)	RAW VALUE (dBuV)	CORRECTION FACTOR (dB/m)
1	5150.00	64.9 PK	74.0	-9.1	2.18 H	274	58.70	6.20
2	5150.00	52.8 AV	54.0	-1.2	2.18 H	274	46.60	6.20
3	*5180.00	118.6 PK			1.00 H	280	79.10	39.50
4	*5180.00	108.7 AV			1.00 H	280	69.20	39.50
5	#10360.00	58.0 PK	74.0	-16.0	1.23 H	337	41.00	17.00
6	#10360.00	45.9 AV	54.0	-8.1	1.23 H	337	28.90	17.00

**ANTENNA POLARITY & TEST DISTANCE: VERTICAL AT 3 M**

NO.	FREQ. (MHz)	EMISSION LEVEL (dBuV/m)	LIMIT (dBuV/m)	MARGIN (dB)	ANTENNA HEIGHT (m)	TABLE ANGLE (Degree)	RAW VALUE (dBuV)	CORRECTION FACTOR (dB/m)
1	5150.00	56.2 PK	74.0	-17.8	1.15 V	126	50.00	6.20
2	5150.00	45.8 AV	54.0	-8.2	1.15 V	126	39.60	6.20
3	*5180.00	112.0 PK			1.00 V	37	72.50	39.50
4	*5180.00	101.9 AV			1.00 V	37	62.40	39.50
5	#10360.00	59.3 PK	74.0	-14.7	1.90 V	321	42.30	17.00
6	#10360.00	46.9 AV	54.0	-7.1	1.90 V	321	29.90	17.00

**Remarks:**

1. Emission Level(dBuV/m) = Raw Value(dBuV) + Correction Factor(dB/m)
2. Correction Factor(dB/m) = Antenna Factor(dB/m) + Cable Factor(dB)
3. The other emission levels were very low against the limit.
4. Margin value = Emission Level – Limit value
5. " \* ": Fundamental frequency.
6. " # ": The radiated frequency is out of the restricted band.

CHANNEL	TX Channel 40	DETECTOR FUNCTION	Peak (PK)
FREQUENCY RANGE	1GHz ~ 40GHz		Average (AV)

**ANTENNA POLARITY & TEST DISTANCE: HORIZONTAL AT 3 M**

NO.	FREQ. (MHz)	EMISSION LEVEL (dBuV/m)	LIMIT (dBuV/m)	MARGIN (dB)	ANTENNA HEIGHT (m)	TABLE ANGLE (Degree)	RAW VALUE (dBuV)	CORRECTION FACTOR (dB/m)
1	*5200.00	122.9 PK			1.00 H	279	83.30	39.60
2	*5200.00	112.7 AV			1.00 H	279	73.10	39.60
3	10400.00	58.4 PK	74.0	-15.6	1.02 H	337	41.40	17.00
4	10400.00	46.3 AV	54.0	-7.7	1.02 H	337	29.30	17.00
5	15600.00	64.7 PK	74.0	-9.3	1.00 H	151	45.80	18.90
6	15600.00	52.2 AV	54.0	-1.8	1.00 H	151	33.30	18.90

**ANTENNA POLARITY & TEST DISTANCE: VERTICAL AT 3 M**

NO.	FREQ. (MHz)	EMISSION LEVEL (dBuV/m)	LIMIT (dBuV/m)	MARGIN (dB)	ANTENNA HEIGHT (m)	TABLE ANGLE (Degree)	RAW VALUE (dBuV)	CORRECTION FACTOR (dB/m)
1	*5200.00	116.5 PK			1.00 V	37	76.90	39.60
2	*5200.00	106.3 AV			1.00 V	37	66.70	39.60
3	10400.00	58.5 PK	74.0	-15.5	1.56 V	27	41.50	17.00
4	10400.00	46.1 AV	54.0	-7.9	1.56 V	27	29.10	17.00
5	15600.00	62.6 PK	74.0	-11.4	1.37 V	320	43.70	18.90
6	15600.00	50.7 AV	54.0	-3.3	1.37 V	320	31.80	18.90

**Remarks:**

1. Emission Level(dBuV/m) = Raw Value(dBuV) + Correction Factor(dB/m)
2. Correction Factor(dB/m) = Antenna Factor(dB/m) + Cable Factor(dB)
3. The other emission levels were very low against the limit.
4. Margin value = Emission Level – Limit value
5. " \* ": Fundamental frequency.

CHANNEL	TX Channel 48	DETECTOR FUNCTION	Peak (PK)
FREQUENCY RANGE	1GHz ~ 40GHz		Average (AV)

ANTENNA POLARITY & TEST DISTANCE: HORIZONTAL AT 3 M								
NO.	FREQ. (MHz)	EMISSION LEVEL (dBuV/m)	LIMIT (dBuV/m)	MARGIN (dB)	ANTENNA HEIGHT (m)	TABLE ANGLE (Degree)	RAW VALUE (dBuV)	CORRECTION FACTOR (dB/m)
1	*5240.00	122.8 PK			1.00 H	280	83.20	39.60
2	*5240.00	113.3 AV			1.00 H	280	73.70	39.60
3	5400.00	59.8 PK	74.0	-14.2	1.00 H	276	53.40	6.40
4	5400.00	47.4 AV	54.0	-6.6	1.00 H	276	41.00	6.40
5	#10480.00	59.0 PK	74.0	-15.0	1.10 H	235	41.00	18.00
6	#10480.00	47.0 AV	54.0	-7.0	1.10 H	235	29.00	18.00
7	15720.00	64.8 PK	74.0	-9.2	1.00 H	153	46.30	18.50
8	15720.00	52.4 AV	54.0	-1.6	1.00 H	153	33.90	18.50

ANTENNA POLARITY & TEST DISTANCE: VERTICAL AT 3 M								
NO.	FREQ. (MHz)	EMISSION LEVEL (dBuV/m)	LIMIT (dBuV/m)	MARGIN (dB)	ANTENNA HEIGHT (m)	TABLE ANGLE (Degree)	RAW VALUE (dBuV)	CORRECTION FACTOR (dB/m)
1	*5240.00	116.3 PK			2.33 V	36	76.70	39.60
2	*5240.00	106.1 AV			2.33 V	36	66.50	39.60
3	5400.00	57.8 PK	74.0	-16.2	1.92 V	27	51.40	6.40
4	5400.00	45.6 AV	54.0	-8.4	1.92 V	27	39.20	6.40
5	#10480.00	59.8 PK	74.0	-14.2	1.81 V	7	41.80	18.00
6	#10480.00	47.2 AV	54.0	-6.8	1.81 V	7	29.20	18.00
7	15720.00	63.2 PK	74.0	-10.8	1.82 V	331	44.70	18.50
8	15720.00	51.0 AV	54.0	-3.0	1.82 V	331	32.50	18.50

**Remarks:**

1. Emission Level(dBuV/m) = Raw Value(dBuV) + Correction Factor(dB/m)
2. Correction Factor(dB/m) = Antenna Factor(dB/m) + Cable Factor(dB)
3. The other emission levels were very low against the limit.
4. Margin value = Emission Level – Limit value
5. " \* ": Fundamental frequency.
6. " # ": The radiated frequency is out of the restricted band.

CHANNEL	TX Channel 149	DETECTOR FUNCTION	Peak (PK)
FREQUENCY RANGE	1GHz ~ 40GHz		Average (AV)

**ANTENNA POLARITY & TEST DISTANCE: HORIZONTAL AT 3 M**

NO.	FREQ. (MHz)	EMISSION LEVEL (dBuV/m)	LIMIT (dBuV/m)	MARGIN (dB)	ANTENNA HEIGHT (m)	TABLE ANGLE (Degree)	RAW VALUE (dBuV)	CORRECTION FACTOR (dB/m)
1	#5714.00	58.5 PK	74.0	-15.5	1.79 H	359	51.30	7.20
2	#5714.00	46.5 AV	54.0	-7.5	1.79 H	359	39.30	7.20
3	#5722.00	65.8 PK	78.2	-12.4	1.80 H	350	58.60	7.20
4	#5725.00	56.6 PK	78.2	-21.6	1.80 H	350	49.40	7.20
5	*5745.00	114.2 PK			1.88 H	292	73.80	40.40
6	*5745.00	104.7 AV			1.88 H	292	64.30	40.40
7	11490.00	62.2 PK	74.0	-11.8	1.90 H	351	43.90	18.30
8	11490.00	48.5 AV	54.0	-5.5	1.90 H	351	30.20	18.30

**ANTENNA POLARITY & TEST DISTANCE: VERTICAL AT 3 M**

NO.	FREQ. (MHz)	EMISSION LEVEL (dBuV/m)	LIMIT (dBuV/m)	MARGIN (dB)	ANTENNA HEIGHT (m)	TABLE ANGLE (Degree)	RAW VALUE (dBuV)	CORRECTION FACTOR (dB/m)
1	#5714.00	61.9 PK	74.0	-12.1	1.60 V	29	54.70	7.20
2	#5714.00	48.1 AV	54.0	-5.9	1.60 V	29	40.90	7.20
3	#5722.00	66.8 PK	78.2	-11.4	2.18 V	45	59.60	7.20
4	#5725.00	56.8 PK	78.2	-21.4	2.18 V	45	49.60	7.20
5	*5745.00	113.0 PK			2.32 V	326	72.60	40.40
6	*5745.00	102.4 AV			2.32 V	326	62.00	40.40
7	11490.00	65.3 PK	74.0	-8.7	1.73 V	307	47.00	18.30
8	11490.00	52.8 AV	54.0	-1.2	1.73 V	307	34.50	18.30

**Remarks:**

1. Emission Level(dBuV/m) = Raw Value(dBuV) + Correction Factor(dB/m)
2. Correction Factor(dB/m) = Antenna Factor(dB/m) + Cable Factor(dB)
3. The other emission levels were very low against the limit.
4. Margin value = Emission Level – Limit value
5. " \* ": Fundamental frequency.
6. " # ": The radiated frequency is out of the restricted band.

CHANNEL	TX Channel 157	DETECTOR FUNCTION	Peak (PK)
FREQUENCY RANGE	1GHz ~ 40GHz		Average (AV)

**ANTENNA POLARITY & TEST DISTANCE: HORIZONTAL AT 3 M**

NO.	FREQ. (MHz)	EMISSION LEVEL (dBuV/m)	LIMIT (dBuV/m)	MARGIN (dB)	ANTENNA HEIGHT (m)	TABLE ANGLE (Degree)	RAW VALUE (dBuV)	CORRECTION FACTOR (dB/m)
1	*5785.00	116.8 PK			2.19 H	277	76.30	40.50
2	*5785.00	106.4 AV			2.19 H	277	65.90	40.50
3	11570.00	61.7 PK	74.0	-12.3	1.79 H	269	43.50	18.20
4	11570.00	48.5 AV	54.0	-5.5	1.79 H	269	30.30	18.20

**ANTENNA POLARITY & TEST DISTANCE: VERTICAL AT 3 M**

NO.	FREQ. (MHz)	EMISSION LEVEL (dBuV/m)	LIMIT (dBuV/m)	MARGIN (dB)	ANTENNA HEIGHT (m)	TABLE ANGLE (Degree)	RAW VALUE (dBuV)	CORRECTION FACTOR (dB/m)
1	*5785.00	112.1 PK			2.09 V	304	71.60	40.50
2	*5785.00	102.3 AV			2.09 V	304	61.80	40.50
3	11570.00	65.8 PK	74.0	-8.2	1.74 V	306	47.60	18.20
4	11570.00	52.7 AV	54.0	-1.3	1.74 V	306	34.50	18.20

**Remarks:**

1. Emission Level(dBuV/m) = Raw Value(dBuV) + Correction Factor(dB/m)
2. Correction Factor(dB/m) = Antenna Factor(dB/m) + Cable Factor(dB)
3. The other emission levels were very low against the limit.
4. Margin value = Emission Level – Limit value
5. " \* " : Fundamental frequency.

CHANNEL	TX Channel 165	DETECTOR FUNCTION	Peak (PK)
FREQUENCY RANGE	1GHz ~ 40GHz		Average (AV)

**ANTENNA POLARITY & TEST DISTANCE: HORIZONTAL AT 3 M**

NO.	FREQ. (MHz)	EMISSION LEVEL (dBuV/m)	LIMIT (dBuV/m)	MARGIN (dB)	ANTENNA HEIGHT (m)	TABLE ANGLE (Degree)	RAW VALUE (dBuV)	CORRECTION FACTOR (dB/m)
1	*5825.00	115.3 PK			2.01 H	289	74.80	40.50
2	*5825.00	105.2 AV			2.01 H	289	64.70	40.50
3	#5850.00	56.5 PK	78.2	-21.7	1.80 H	280	49.00	7.50
4	#5853.00	76.6 PK	78.2	-1.6	1.80 H	280	69.00	7.60
5	#5861.00	59.1 PK	74.0	-14.9	1.70 H	280	51.50	7.60
6	#5861.00	47.1 AV	54.0	-6.9	1.70 H	280	39.50	7.60
7	11650.00	61.5 PK	74.0	-12.5	1.88 H	340	42.80	18.70
8	11650.00	49.0 AV	54.0	-5.0	1.88 H	340	30.30	18.70

**ANTENNA POLARITY & TEST DISTANCE: VERTICAL AT 3 M**

NO.	FREQ. (MHz)	EMISSION LEVEL (dBuV/m)	LIMIT (dBuV/m)	MARGIN (dB)	ANTENNA HEIGHT (m)	TABLE ANGLE (Degree)	RAW VALUE (dBuV)	CORRECTION FACTOR (dB/m)
1	*5825.00	112.8 PK			2.27 V	301	72.30	40.50
2	*5825.00	102.0 AV			2.27 V	301	61.50	40.50
3	#5850.00	53.8 PK	78.2	-24.4	1.77 V	333	46.30	7.50
4	#5853.00	64.2 PK	78.2	-14.0	1.77 V	333	56.60	7.60
5	#5861.00	58.1 PK	74.0	-15.9	1.75 V	311	50.50	7.60
6	#5861.00	47.2 AV	54.0	-6.8	1.75 V	311	39.60	7.60
7	11650.00	67.4 PK	74.0	-6.6	1.75 V	307	48.70	18.70
8	11650.00	52.9 AV	54.0	-1.1	1.75 V	307	34.20	18.70

**Remarks:**

1. Emission Level(dBuV/m) = Raw Value(dBuV) + Correction Factor(dB/m)
2. Correction Factor(dB/m) = Antenna Factor(dB/m) + Cable Factor(dB)
3. The other emission levels were very low against the limit.
4. Margin value = Emission Level – Limit value
5. " \* ": Fundamental frequency.
6. " # ": The radiated frequency is out of the restricted band.

**802.11n (HT40)**

CHANNEL	TX Channel 38	DETECTOR FUNCTION	Peak (PK)
FREQUENCY RANGE	1GHz ~ 40GHz		Average (AV)

**ANTENNA POLARITY & TEST DISTANCE: HORIZONTAL AT 3 M**

NO.	FREQ. (MHz)	EMISSION LEVEL (dBuV/m)	LIMIT (dBuV/m)	MARGIN (dB)	ANTENNA HEIGHT (m)	TABLE ANGLE (Degree)	RAW VALUE (dBuV)	CORRECTION FACTOR (dB/m)
1	5150.00	65.1 PK	74.0	-8.9	1.00 H	277	58.90	6.20
2	5150.00	52.6 AV	54.0	-1.4	1.00 H	277	46.40	6.20
3	*5190.00	110.8 PK			1.03 H	279	71.30	39.50
4	*5190.00	101.1 AV			1.03 H	279	61.60	39.50
5	#10380.00	58.5 PK	74.0	-15.5	1.38 H	243	41.50	17.00
6	#10380.00	46.4 AV	54.0	-7.6	1.38 H	243	29.40	17.00

**ANTENNA POLARITY & TEST DISTANCE: VERTICAL AT 3 M**

NO.	FREQ. (MHz)	EMISSION LEVEL (dBuV/m)	LIMIT (dBuV/m)	MARGIN (dB)	ANTENNA HEIGHT (m)	TABLE ANGLE (Degree)	RAW VALUE (dBuV)	CORRECTION FACTOR (dB/m)
1	5150.00	59.1 PK	74.0	-14.9	1.03 V	10	52.90	6.20
2	5150.00	47.9 AV	54.0	-6.1	1.03 V	10	41.70	6.20
3	*5190.00	104.2 PK			1.00 V	36	64.70	39.50
4	*5190.00	95.6 AV			1.00 V	36	56.10	39.50
5	#10380.00	58.3 PK	74.0	-15.7	1.37 V	212	41.30	17.00
6	#10380.00	46.2 AV	54.0	-7.8	1.37 V	212	29.20	17.00

**Remarks:**

1. Emission Level(dBuV/m) = Raw Value(dBuV) + Correction Factor(dB/m)
2. Correction Factor(dB/m) = Antenna Factor(dB/m) + Cable Factor(dB)
3. The other emission levels were very low against the limit.
4. Margin value = Emission Level – Limit value
5. " \* ": Fundamental frequency.
6. " # ": The radiated frequency is out of the restricted band.



CHANNEL	TX Channel 46	DETECTOR FUNCTION	Peak (PK)
FREQUENCY RANGE	1GHz ~ 40GHz		Average (AV)

**ANTENNA POLARITY & TEST DISTANCE: HORIZONTAL AT 3 M**

NO.	FREQ. (MHz)	EMISSION LEVEL (dBuV/m)	LIMIT (dBuV/m)	MARGIN (dB)	ANTENNA HEIGHT (m)	TABLE ANGLE (Degree)	RAW VALUE (dBuV)	CORRECTION FACTOR (dB/m)
1	5150.00	61.9 PK	74.0	-12.1	1.00 H	280	55.70	6.20
2	5150.00	49.5 AV	54.0	-4.5	1.00 H	280	43.30	6.20
3	*5230.00	119.2 PK			1.00 H	280	79.60	39.60
4	*5230.00	110.0 AV			1.00 H	280	70.40	39.60
5	#10460.00	58.4 PK	74.0	-15.6	1.44 H	250	40.60	17.80
6	#10460.00	46.5 AV	54.0	-7.5	1.44 H	250	28.70	17.80
7	15690.00	64.1 PK	74.0	-9.9	1.44 H	192	45.40	18.70
8	15690.00	52.2 AV	54.0	-1.8	1.44 H	192	33.50	18.70

**ANTENNA POLARITY & TEST DISTANCE: VERTICAL AT 3 M**

NO.	FREQ. (MHz)	EMISSION LEVEL (dBuV/m)	LIMIT (dBuV/m)	MARGIN (dB)	ANTENNA HEIGHT (m)	TABLE ANGLE (Degree)	RAW VALUE (dBuV)	CORRECTION FACTOR (dB/m)
1	5150.00	57.2 PK	74.0	-16.8	2.42 V	122	51.00	6.20
2	5150.00	45.7 AV	54.0	-8.3	2.42 V	122	39.50	6.20
3	*5230.00	112.5 PK			1.00 V	27	72.90	39.60
4	*5230.00	102.7 AV			1.00 V	27	63.10	39.60
5	#10460.00	58.6 PK	74.0	-15.4	1.67 V	221	40.80	17.80
6	#10460.00	46.7 AV	54.0	-7.3	1.67 V	221	28.90	17.80
7	15690.00	63.0 PK	74.0	-11.0	1.46 V	284	44.30	18.70
8	15690.00	51.4 AV	54.0	-2.6	1.46 V	284	32.70	18.70

**Remarks:**

1. Emission Level(dBuV/m) = Raw Value(dBuV) + Correction Factor(dB/m)
2. Correction Factor(dB/m) = Antenna Factor(dB/m) + Cable Factor(dB)
3. The other emission levels were very low against the limit.
4. Margin value = Emission Level – Limit value
5. " \* ": Fundamental frequency.
6. " # ": The radiated frequency is out of the restricted band.

CHANNEL	TX Channel 151	DETECTOR FUNCTION	Peak (PK)
FREQUENCY RANGE	1GHz ~ 40GHz		Average (AV)

**ANTENNA POLARITY & TEST DISTANCE: HORIZONTAL AT 3 M**

NO.	FREQ. (MHz)	EMISSION LEVEL (dBuV/m)	LIMIT (dBuV/m)	MARGIN (dB)	ANTENNA HEIGHT (m)	TABLE ANGLE (Degree)	RAW VALUE (dBuV)	CORRECTION FACTOR (dB/m)
1	#5714.00	68.8 PK	74.0	-5.2	1.94 H	46	61.60	7.20
2	#5714.00	<b>53.0 AV</b>	<b>54.0</b>	<b>-1.0</b>	<b>1.94 H</b>	<b>46</b>	<b>45.80</b>	<b>7.20</b>
3	#5722.00	69.3 PK	78.2	-8.9	1.76 H	50	62.10	7.20
4	#5725.00	58.5 PK	78.2	-19.7	1.76 H	50	51.30	7.20
5	*5755.00	109.0 PK			1.98 H	293	68.50	40.50
6	*5755.00	99.2 AV			1.98 H	293	58.70	40.50
7	11510.00	60.7 PK	74.0	-13.3	1.84 H	356	42.50	18.20
8	11510.00	47.6 AV	54.0	-6.4	1.84 H	356	29.40	18.20

**ANTENNA POLARITY & TEST DISTANCE: VERTICAL AT 3 M**

NO.	FREQ. (MHz)	EMISSION LEVEL (dBuV/m)	LIMIT (dBuV/m)	MARGIN (dB)	ANTENNA HEIGHT (m)	TABLE ANGLE (Degree)	RAW VALUE (dBuV)	CORRECTION FACTOR (dB/m)
1	#5714.00	59.1 PK	74.0	-14.9	1.60 V	33	51.90	7.20
2	#5714.00	47.0 AV	54.0	-7.0	1.60 V	33	39.80	7.20
3	#5722.00	64.9 PK	78.2	-13.3	1.62 V	52	57.70	7.20
4	#5725.00	56.5 PK	78.2	-21.7	1.62 V	52	49.30	7.20
5	*5755.00	106.4 PK			2.00 V	335	65.90	40.50
6	*5755.00	96.2 AV			2.00 V	335	55.70	40.50
7	11510.00	59.9 PK	74.0	-14.1	1.70 V	301	41.70	18.20
8	11510.00	46.8 AV	54.0	-7.2	1.70 V	301	28.60	18.20

**Remarks:**

1. Emission Level(dBuV/m) = Raw Value(dBuV) + Correction Factor(dB/m)
2. Correction Factor(dB/m) = Antenna Factor(dB/m) + Cable Factor(dB)
3. The other emission levels were very low against the limit.
4. Margin value = Emission Level – Limit value
5. " \* ": Fundamental frequency.
6. " # ": The radiated frequency is out of the restricted band.

CHANNEL	TX Channel 159	DETECTOR FUNCTION	Peak (PK)
FREQUENCY RANGE	1GHz ~ 40GHz		Average (AV)

**ANTENNA POLARITY & TEST DISTANCE: HORIZONTAL AT 3 M**

NO.	FREQ. (MHz)	EMISSION LEVEL (dBuV/m)	LIMIT (dBuV/m)	MARGIN (dB)	ANTENNA HEIGHT (m)	TABLE ANGLE (Degree)	RAW VALUE (dBuV)	CORRECTION FACTOR (dB/m)
1	*5795.00	113.3 PK			2.14 H	10	72.80	40.50
2	*5795.00	102.8 AV			2.14 H	10	62.30	40.50
3	#5850.00	53.9 PK	78.2	-24.3	1.84 H	46	46.40	7.50
4	#5853.00	61.2 PK	78.2	-17.0	1.84 H	46	53.60	7.60
5	#5861.00	61.8 PK	74.0	-12.2	2.10 H	348	54.20	7.60
6	#5861.00	47.3 AV	54.0	-6.7	2.10 H	348	39.70	7.60
7	11590.00	62.1 PK	74.0	-11.9	2.00 H	287	43.80	18.30
8	11590.00	48.6 AV	54.0	-5.4	2.00 H	287	30.30	18.30

**ANTENNA POLARITY & TEST DISTANCE: VERTICAL AT 3 M**

NO.	FREQ. (MHz)	EMISSION LEVEL (dBuV/m)	LIMIT (dBuV/m)	MARGIN (dB)	ANTENNA HEIGHT (m)	TABLE ANGLE (Degree)	RAW VALUE (dBuV)	CORRECTION FACTOR (dB/m)
1	*5795.00	110.2 PK			2.30 V	325	69.70	40.50
2	*5795.00	99.7 AV			2.30 V	325	59.20	40.50
3	#5850.00	49.4 PK	78.2	-28.8	1.84 V	352	41.90	7.50
4	#5853.00	59.7 PK	78.2	-18.5	1.84 V	352	52.10	7.60
5	#5861.00	59.1 PK	74.0	-14.9	2.01 V	19	51.50	7.60
6	#5861.00	46.7 AV	54.0	-7.3	2.01 V	19	39.10	7.60
7	11590.00	64.9 PK	74.0	-9.1	1.71 V	305	46.60	18.30
8	11590.00	52.1 AV	54.0	-1.9	1.71 V	305	33.80	18.30

**Remarks:**

1. Emission Level(dBuV/m) = Raw Value(dBuV) + Correction Factor(dB/m)
2. Correction Factor(dB/m) = Antenna Factor(dB/m) + Cable Factor(dB)
3. The other emission levels were very low against the limit.
4. Margin value = Emission Level – Limit value
5. " \* ": Fundamental frequency.
6. " # ": The radiated frequency is out of the restricted band.

**802.11ac (VHT80)**

CHANNEL	TX Channel 42	DETECTOR FUNCTION	Peak (PK)
FREQUENCY RANGE	1GHz ~ 40GHz		Average (AV)

**ANTENNA POLARITY & TEST DISTANCE: HORIZONTAL AT 3 M**

NO.	FREQ. (MHz)	EMISSION LEVEL (dBuV/m)	LIMIT (dBuV/m)	MARGIN (dB)	ANTENNA HEIGHT (m)	TABLE ANGLE (Degree)	RAW VALUE (dBuV)	CORRECTION FACTOR (dB/m)
1	5150.00	64.7 PK	74.0	-9.3	1.00 H	277	58.50	6.20
2	5150.00	52.7 AV	54.0	-1.3	1.00 H	277	46.50	6.20
3	*5210.00	106.0 PK			1.00 H	277	66.40	39.60
4	*5210.00	96.0 AV			1.00 H	277	56.40	39.60
5	#10420.00	58.2 PK	74.0	-15.8	1.08 H	69	41.00	17.20
6	#10420.00	46.2 AV	54.0	-7.8	1.08 H	69	29.00	17.20

**ANTENNA POLARITY & TEST DISTANCE: VERTICAL AT 3 M**

NO.	FREQ. (MHz)	EMISSION LEVEL (dBuV/m)	LIMIT (dBuV/m)	MARGIN (dB)	ANTENNA HEIGHT (m)	TABLE ANGLE (Degree)	RAW VALUE (dBuV)	CORRECTION FACTOR (dB/m)
1	5150.00	58.8 PK	74.0	-15.2	1.00 V	16	52.60	6.20
2	5150.00	47.6 AV	54.0	-6.4	1.00 V	16	41.40	6.20
3	*5210.00	99.6 PK			1.00 V	24	60.00	39.60
4	*5210.00	88.2 AV			1.00 V	24	48.60	39.60
5	#10420.00	58.0 PK	74.0	-16.0	1.11 V	218	40.80	17.20
6	#10420.00	46.3 AV	54.0	-7.7	1.11 V	218	29.10	17.20

**Remarks:**

1. Emission Level(dBuV/m) = Raw Value(dBuV) + Correction Factor(dB/m)
2. Correction Factor(dB/m) = Antenna Factor(dB/m) + Cable Factor(dB)
3. The other emission levels were very low against the limit.
4. Margin value = Emission Level – Limit value
5. " \* ": Fundamental frequency.
6. " # ": The radiated frequency is out of the restricted band.

CHANNEL	TX Channel 155	DETECTOR FUNCTION	Peak (PK)
FREQUENCY RANGE	1GHz ~ 40GHz		Average (AV)

ANTENNA POLARITY & TEST DISTANCE: HORIZONTAL AT 3 M								
NO.	FREQ. (MHz)	EMISSION LEVEL (dBuV/m)	LIMIT (dBuV/m)	MARGIN (dB)	ANTENNA HEIGHT (m)	TABLE ANGLE (Degree)	RAW VALUE (dBuV)	CORRECTION FACTOR (dB/m)
1	#5714.00	66.9 PK	74.0	-7.1	1.84 H	51	59.70	7.20
2	#5714.00	52.6 AV	54.0	-1.4	1.84 H	51	45.40	7.20
3	#5722.00	73.1 PK	78.2	-5.1	1.96 H	41	65.90	7.20
4	#5725.00	62.7 PK	78.2	-15.5	1.96 H	41	55.50	7.20
5	*5775.00	106.0 PK			1.93 H	42	65.50	40.50
6	*5775.00	94.6 AV			1.93 H	42	54.10	40.50
7	11550.00	59.6 PK	74.0	-14.4	1.69 H	312	41.40	18.20
8	11550.00	46.5 AV	54.0	-7.5	1.69 H	312	28.30	18.20

ANTENNA POLARITY & TEST DISTANCE: VERTICAL AT 3 M								
NO.	FREQ. (MHz)	EMISSION LEVEL (dBuV/m)	LIMIT (dBuV/m)	MARGIN (dB)	ANTENNA HEIGHT (m)	TABLE ANGLE (Degree)	RAW VALUE (dBuV)	CORRECTION FACTOR (dB/m)
1	#5714.00	62.4 PK	74.0	-11.6	1.88 V	298	55.20	7.20
2	#5714.00	47.8 AV	54.0	-6.2	1.88 V	298	40.60	7.20
3	#5722.00	66.5 PK	78.2	-11.7	1.98 V	338	59.30	7.20
4	#5725.00	57.9 PK	78.2	-20.3	1.98 V	338	50.70	7.20
5	*5775.00	100.6 PK			2.31 V	330	60.10	40.50
6	*5775.00	90.1 AV			2.31 V	330	49.60	40.50
7	11550.00	60.7 PK	74.0	-13.3	1.73 V	300	42.50	18.20
8	11550.00	47.6 AV	54.0	-6.4	1.73 V	300	29.40	18.20

**Remarks:**

1. Emission Level(dBuV/m) = Raw Value(dBuV) + Correction Factor(dB/m)
2. Correction Factor(dB/m) = Antenna Factor(dB/m) + Cable Factor(dB)
3. The other emission levels were very low against the limit.
4. Margin value = Emission Level – Limit value
5. " \* ": Fundamental frequency.
6. " # ": The radiated frequency is out of the restricted band.

Below 1GHz Worst-Case Data: 802.11n (HT20)

CHANNEL	TX Channel 40	DETECTOR FUNCTION	Quasi-Peak (QP)
FREQUENCY RANGE	30MHz ~ 1GHz		
TEST MODE	A		

ANTENNA POLARITY & TEST DISTANCE: HORIZONTAL AT 3 M

NO.	FREQ. (MHz)	EMISSION LEVEL (dBuV/m)	LIMIT (dBuV/m)	MARGIN (dB)	ANTENNA HEIGHT (m)	TABLE ANGLE (Degree)	RAW VALUE (dBuV)	CORRECTION FACTOR (dB/m)
1	140.72	36.4 QP	43.5	-7.1	1.00 H	246	50.80	-14.40
2	305.99	41.2 QP	46.0	-4.8	1.00 H	201	53.20	-12.00
3	683.18	42.1 QP	46.0	-3.9	1.00 H	218	46.40	-4.30
4	716.23	43.6 QP	46.0	-2.4	1.00 H	204	47.40	-3.80
5	733.73	43.8 QP	46.0	-2.2	1.00 H	207	47.10	-3.30
6	790.12	41.0 QP	46.0	-5.0	1.00 H	156	43.10	-2.10

ANTENNA POLARITY & TEST DISTANCE: VERTICAL AT 3 M

NO.	FREQ. (MHz)	EMISSION LEVEL (dBuV/m)	LIMIT (dBuV/m)	MARGIN (dB)	ANTENNA HEIGHT (m)	TABLE ANGLE (Degree)	RAW VALUE (dBuV)	CORRECTION FACTOR (dB/m)
1	51.29	35.8 QP	40.0	-4.2	1.00 V	318	50.20	-14.40
2	167.94	35.4 QP	43.5	-8.1	1.00 V	292	49.50	-14.10
3	304.04	40.2 QP	46.0	-5.8	1.50 V	173	52.30	-12.10
4	632.63	40.1 QP	46.0	-5.9	1.50 V	177	45.00	-4.90
5	692.90	44.1 QP	46.0	-1.9	1.50 V	187	48.30	-4.20
6	724.01	43.4 QP	46.0	-2.6	1.50 V	205	47.10	-3.70

Remarks:

1. Emission Level(dBuV/m) = Raw Value(dBuV) + Correction Factor(dB/m)
2. Correction Factor(dB/m) = Antenna Factor(dB/m) + Cable Factor(dB)
3. The other emission levels were very low against the limit.
4. Margin value = Emission Level – Limit value

CHANNEL	TX Channel 40	DETECTOR FUNCTION	Quasi-Peak (QP)
FREQUENCY RANGE	30MHz ~ 1GHz		
TEST MODE	B		

**ANTENNA POLARITY & TEST DISTANCE: HORIZONTAL AT 3 M**

NO.	FREQ. (MHz)	EMISSION LEVEL (dBuV/m)	LIMIT (dBuV/m)	MARGIN (dB)	ANTENNA HEIGHT (m)	TABLE ANGLE (Degree)	RAW VALUE (dBuV)	CORRECTION FACTOR (dB/m)
1	57.12	32.5 QP	40.0	-7.5	2.00 H	182	47.20	-14.70
2	140.72	34.1 QP	43.5	-9.4	2.00 H	99	48.50	-14.40
3	212.66	36.4 QP	43.5	-7.1	1.01 H	223	52.70	-16.30
4	270.99	31.6 QP	46.0	-14.4	1.01 H	105	44.70	-13.10
5	500.42	31.7 QP	46.0	-14.3	1.01 H	57	39.80	-8.10
6	895.11	41.3 QP	46.0	-4.7	2.00 H	194	42.00	-0.70

**ANTENNA POLARITY & TEST DISTANCE: VERTICAL AT 3 M**

NO.	FREQ. (MHz)	EMISSION LEVEL (dBuV/m)	LIMIT (dBuV/m)	MARGIN (dB)	ANTENNA HEIGHT (m)	TABLE ANGLE (Degree)	RAW VALUE (dBuV)	CORRECTION FACTOR (dB/m)
1	61.01	38.8 QP	40.0	-1.2	1.00 V	29	53.90	-15.10
2	138.78	31.7 QP	43.5	-11.8	1.00 V	22	46.20	-14.50
3	212.66	30.7 QP	43.5	-12.8	1.00 V	298	47.00	-16.30
4	284.60	28.2 QP	46.0	-17.8	1.50 V	136	40.70	-12.50
5	500.42	35.1 QP	46.0	-10.9	1.00 V	191	43.20	-8.10
6	899.00	32.5 QP	46.0	-13.5	1.99 V	16	33.00	-0.50

**Remarks:**

1. Emission Level(dBuV/m) = Raw Value(dBuV) + Correction Factor(dB/m)
2. Correction Factor(dB/m) = Antenna Factor(dB/m) + Cable Factor(dB)
3. The other emission levels were very low against the limit.
4. Margin value = Emission Level – Limit value

## 4.2 Conducted Emission Measurement

### 4.2.1 Limits of Conducted Emission Measurement

Frequency (MHz)	Conducted Limit (dBuV)	
	Quasi-peak	Average
0.15 - 0.5	66 - 56	56 - 46
0.50 - 5.0	56	46
5.0 - 30.0	60	50

- Note:** 1. The lower limit shall apply at the transition frequencies.  
 2. The limit decreases in line with the logarithm of the frequency in the range of 0.15 to 0.50MHz.

### 4.2.2 Test Instruments

Description & Manufacturer	Model No.	Serial No.	Cal. Date	Cal. Due
Test Receiver ROHDE & SCHWARZ	ESCI	100424	Oct. 12, 2015	Oct. 11, 2016
RF signal cable (with 10dB PAD) Woken	5D-FB	Cable-cond1-01	Dec. 26, 2014	Dec. 25, 2015
LISN ROHDE & SCHWARZ (EUT)	ESH3-Z5	835239/001	Feb. 26, 2015	Feb. 25, 2016
LISN ROHDE & SCHWARZ (Peripheral)	ESH3-Z5	100311	Jul. 24, 2015	Jul. 23, 2016
Software ADT	BV ADT_Cond_ V7.3.7.3	NA	NA	NA

- Note:** 1. The calibration interval of the above test instruments is 12 months and the calibrations are traceable to NML/ROC and NIST/USA.  
 2. The test was performed in HwaYa Shielded Room 1.  
 3. The VCCI Site Registration No. is C-2040.



### 4.2.3 Test Procedures

- The EUT was placed 0.4 meters from the conducting wall of the shielded room with EUT being connected to the power mains through a line impedance stabilization network (LISN). Other support units were connected to the power mains through another LISN. The two LISNs provide 50 ohm/ 50uH of coupling impedance for the measuring instrument.
- Both lines of the power mains connected to the EUT were checked for maximum conducted interference.
- The frequency range from 150kHz to 30MHz was searched. Emission levels under (Limit - 20dB) was not recorded.

**NOTE:** The resolution bandwidth and video bandwidth of test receiver is 9kHz for quasi-peak detection (QP) and average detection (AV) at frequency 0.15MHz-30MHz.

### 4.2.4 Deviation from Test Standard

No deviation.

### 4.2.5 Test Setup

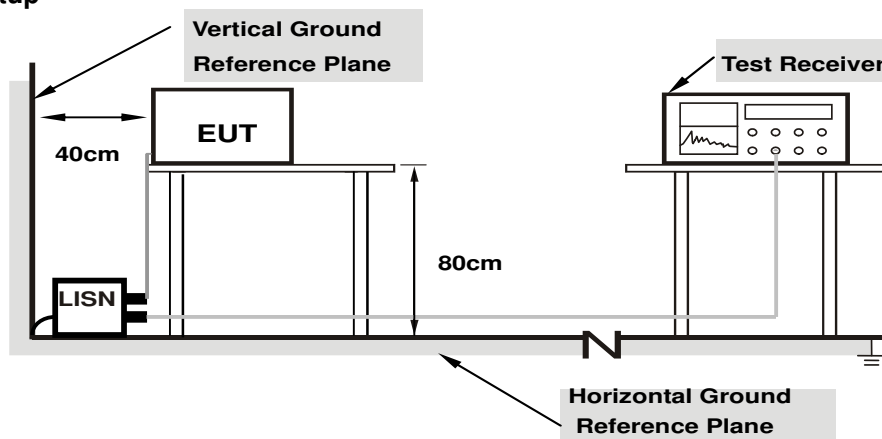

**Note:** 1.Support units were connected to second LISN.

For the actual test configuration, please refer to the attached file (Test Setup Photo).

### 4.2.6 EUT Operating Conditions

Same as 4.1.6.

### 4.2.7 Test Results

Worst-Case Data: 802.11n (HT20)

Phase	Line (L)	Detector Function	Quasi-Peak (QP) / Average (AV)
Test Mode	A		

No	Freq. [MHz]	Corr. Factor (dB)	Reading Value [dB (uV)]		Emission Level [dB (uV)]		Limit [dB (uV)]		Margin (dB)	
			Q.P.	AV.	Q.P.	AV.	Q.P.	AV.	Q.P.	AV.
			1	0.16096	9.86	38.04	24.13	47.90	33.99	65.41
2	0.18910	9.91	36.33	23.81	46.24	33.72	64.08	54.08	-17.84	-20.36
3	0.30294	9.91	25.79	16.70	35.70	26.61	60.16	50.16	-24.46	-23.55
4	3.01994	10.15	16.11	9.20	26.26	19.35	56.00	46.00	-29.74	-26.65
5	7.61810	10.40	15.08	9.89	25.48	20.29	60.00	50.00	-34.52	-29.71
6	17.17023	10.98	5.66	0.10	16.64	11.08	60.00	50.00	-43.36	-38.92

Remarks:

1. Q.P. and AV. are abbreviations of quasi-peak and average individually.
2. The emission levels of other frequencies were very low against the limit.
3. Margin value = Emission level - Limit value
4. Correction factor = Insertion loss + Cable loss
5. Emission Level = Correction Factor + Reading Value.

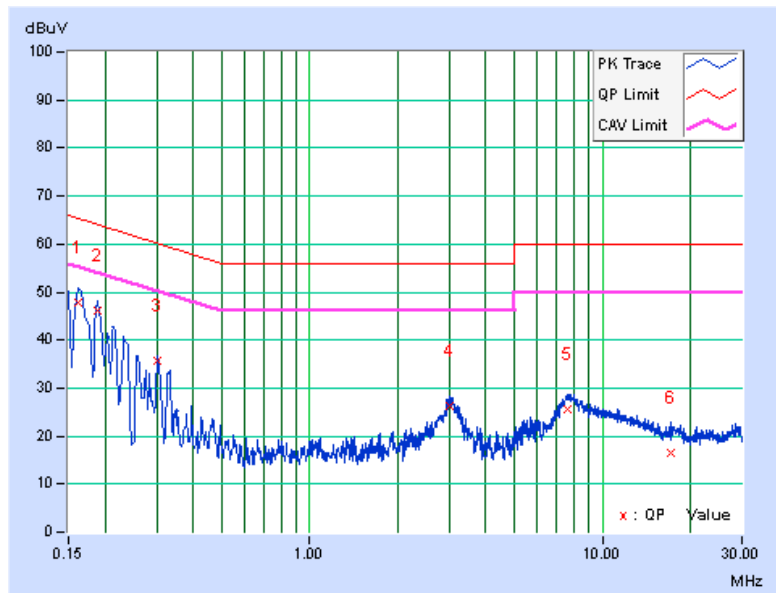

Phase	Neutral (N)	Detector Function	Quasi-Peak (QP) / Average (AV)
Test Mode	A		

No	Freq. [MHz]	Corr. Factor (dB)	Reading Value [dB (uV)]		Emission Level [dB (uV)]		Limit [dB (uV)]		Margin (dB)	
			Q.P.	AV.	Q.P.	AV.	Q.P.	AV.	Q.P.	AV.
			1	0.15000	9.89	39.35	23.60	49.24	33.49	66.00
<b>2</b>	<b>0.32595</b>	<b>10.00</b>	<b>29.27</b>	<b>26.19</b>	<b>39.27</b>	<b>36.19</b>	<b>59.55</b>	<b>49.55</b>	<b>-20.28</b>	<b>-13.36</b>
3	0.41979	9.99	15.91	9.35	25.90	19.34	57.45	47.45	-31.55	-28.11
4	2.96911	10.21	19.46	15.45	29.67	25.66	56.00	46.00	-26.33	-20.34
5	7.44997	10.48	16.28	10.70	26.76	21.18	60.00	50.00	-33.24	-28.82
6	14.99236	10.82	10.16	4.94	20.98	15.76	60.00	50.00	-39.02	-34.24

Remarks:

1. Q.P. and AV. are abbreviations of quasi-peak and average individually.
2. The emission levels of other frequencies were very low against the limit.
3. Margin value = Emission level - Limit value
4. Correction factor = Insertion loss + Cable loss
5. Emission Level = Correction Factor + Reading Value.

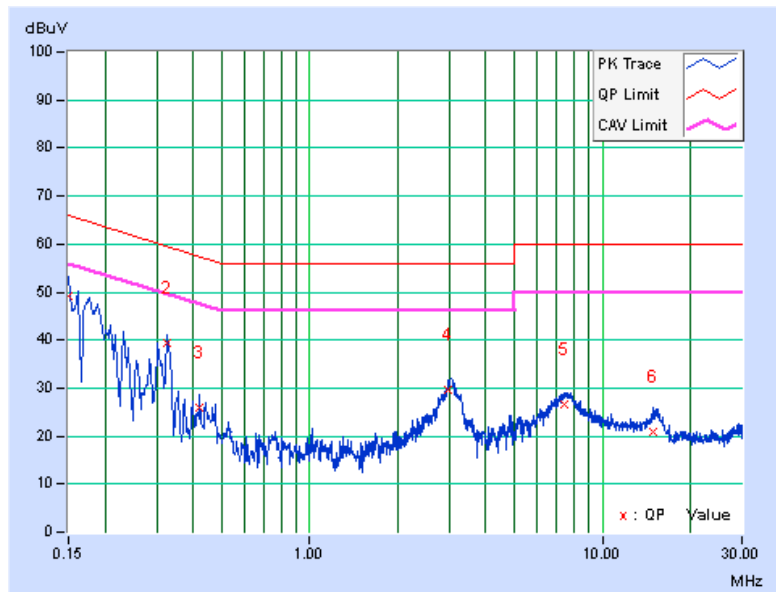

Phase	Line (L)	Detector Function	Quasi-Peak (QP) / Average (AV)
Test Mode	B		

No	Freq. [MHz]	Corr. Factor (dB)	Reading Value [dB (uV)]		Emission Level [dB (uV)]		Limit [dB (uV)]		Margin (dB)	
			Q.P.	AV.	Q.P.	AV.	Q.P.	AV.	Q.P.	AV.
			1	0.15391	9.85	21.14	21.01	30.99	30.86	65.79
2	0.43924	9.91	21.39	7.26	31.30	17.17	57.08	47.08	-25.78	-29.91
3	1.11577	10.04	13.31	1.15	23.35	11.19	56.00	46.00	-32.65	-34.81
4	1.70227	10.08	11.57	0.66	21.65	10.74	56.00	46.00	-34.35	-35.26
5	2.96911	10.14	7.15	-3.07	17.29	7.07	56.00	46.00	-38.71	-38.93
6	19.91505	11.14	8.88	-1.68	20.02	9.46	60.00	50.00	-39.98	-40.54

Remarks:

1. Q.P. and AV. are abbreviations of quasi-peak and average individually.
2. The emission levels of other frequencies were very low against the limit.
3. Margin value = Emission level - Limit value
4. Correction factor = Insertion loss + Cable loss
5. Emission Level = Correction Factor + Reading Value.

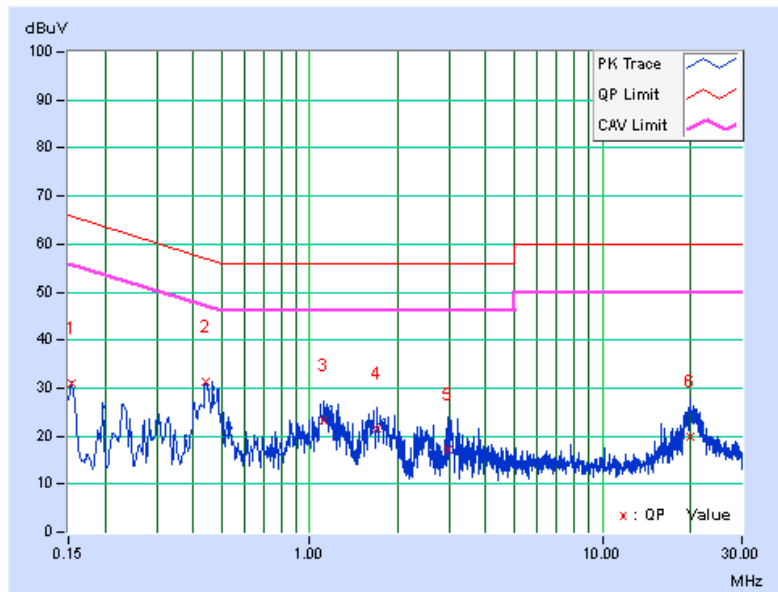

Phase	Neutral (N)	Detector Function	Quasi-Peak (QP) / Average (AV)
Test Mode	B		

No	Freq. [MHz]	Corr. Factor (dB)	Reading Value [dB (uV)]		Emission Level [dB (uV)]		Limit [dB (uV)]		Margin (dB)	
			Q.P.	AV.	Q.P.	AV.	Q.P.	AV.	Q.P.	AV.
			1	0.15391	9.90	21.89	21.33	31.79	31.23	65.79
2	0.26339	10.02	16.15	3.13	26.17	13.15	61.32	51.32	-35.16	-38.18
3	0.45097	9.99	23.93	8.15	33.92	18.14	56.86	46.86	-22.93	-28.71
4	1.07667	10.03	13.50	1.97	23.53	12.00	56.00	46.00	-32.47	-34.00
5	1.83521	10.08	11.95	0.75	22.03	10.83	56.00	46.00	-33.97	-35.17
6	20.95902	11.07	13.93	1.70	25.00	12.77	60.00	50.00	-35.00	-37.23

Remarks:

1. Q.P. and AV. are abbreviations of quasi-peak and average individually.
2. The emission levels of other frequencies were very low against the limit.
3. Margin value = Emission level - Limit value
4. Correction factor = Insertion loss + Cable loss
5. Emission Level = Correction Factor + Reading Value.

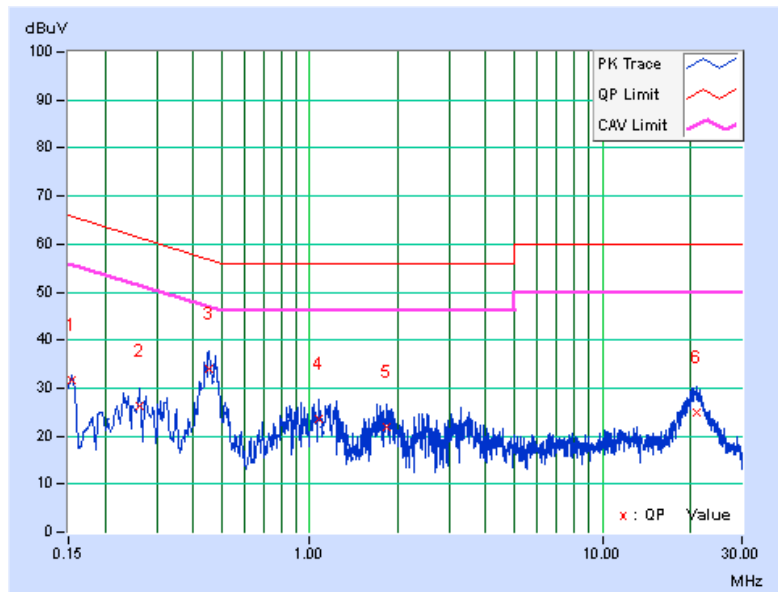

### 4.3 Transmit Power Measurement

#### 4.3.1 Limits of Transmit Power Measurement

Operation Band	EUT Category		LIMIT
U-NII-1		Outdoor Access Point	1 Watt (30 dBm) (Max. e.i.r.p $\leq$ 125mW(21 dBm) at any elevation angle above 30 degrees as measured from the horizon)
		Fixed point-to-point Access Point	1 Watt (30 dBm)
	√	Indoor Access Point	1 Watt (30 dBm)
		Mobile and Portable client device	250mW (24 dBm)
U-NII-2A	---		250mW (24 dBm) or 11 dBm+10 log B*
U-NII-2C	---		250mW (24 dBm) or 11 dBm+10 log B*
U-NII-3	√		1 Watt (30 dBm)

\*B is the 26 dB emission bandwidth in megahertz

Per KDB 662911 Method of conducted output power measurement on IEEE 802.11 devices,

Array Gain = 0 dB (i.e., no array gain) for  $N_{ANT} \leq 4$ ;

Array Gain = 0 dB (i.e., no array gain) for channel widths  $\geq 40$  MHz for any  $N_{ANT}$ ;

Array Gain =  $5 \log(N_{ANT}/N_{SS})$  dB or 3 dB, whichever is less for 20-MHz channel widths with  $N_{ANT} \geq 5$ .

For power measurements on all other devices: Array Gain =  $10 \log(N_{ANT}/N_{SS})$  dB.

#### 4.3.2 Test Setup

For 802.11a, 802.11n (HT20), 802.11n (HT40), 802.11ac (VHT20), 802.11ac (VHT40)

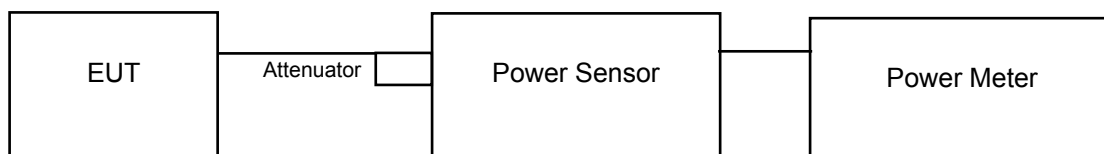

For 802.11ac (VHT80)

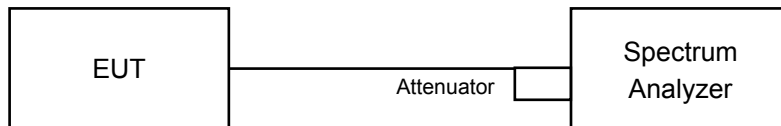

#### 4.3.3 Test Instruments

Refer to section 4.1.2 to get information of above instrument.

#### 4.3.4 Test Procedure

##### For Average Power Measurement

##### For 802.11a, 802.11n (HT20), 802.11n (HT40), 802.11ac (VHT20), 802.11ac (VHT40)

Method PM is used to perform output power measurement, trigger and gating function of wide band power meter is enabled to measure max output power of TX on burst. Duty factor is not added to measured value.

##### For 802.11ac (VHT80)

- a. Set span to encompass the entire 26 dB EBW (or, alternatively, the entire 99% occupied bandwidth) of the signal.
- b. Set sweep trigger to "free run".
- c. Set RBW = 1 MHz.
- d. Set VBW  $\geq$  3 MHz
- e. Number of points in sweep  $\geq$  2 Span / RBW.
- f. Sweep time  $\leq$  (number of points in sweep) \* T
- g. Using emission bandwidth to determine the frequency span for integration the channel bandwidth.
- h. Detector = RMS.
- i. Trace mode = max hold.
- j. Allow max hold to run for at least 60 seconds, or longer as needed to allow the trace to stabilize.

##### For Occupied Bandwidth

The transmitter output was connected to the spectrum analyzer through an attenuator. The bandwidth of the fundamental frequency was measured by spectrum analyzer with resolution bandwidth in the range of 1% to 5% of the anticipated emission bandwidth, and a video bandwidth at least 3x the resolution bandwidth and set the detector to AVERAGE. The width of a frequency band such that, below the lower and above the upper frequency limits, the mean powers emitted are each equal to a specified percentage 0.5 %of the total mean power of a given emission.

#### 4.3.5 Deviation from Test Standard

No deviation.

#### 4.3.6 EUT Operating Conditions

The software provided by client to enable the EUT under transmission condition continuously at lowest, middle and highest channel frequencies individually.

### 4.3.7 Test Result

#### Power Output:

##### 802.11a

Chan.	Freq. (MHz)	Maximum Conducted Power (dBm)			Total Power (mW)	Total Power (dBm)	Power Limit (dBm)	Pass / Fail
		Chain 0	Chain 1	Chain 2				
36	5180	18.94	19.84	18.52	245.847	23.91	30	Pass
40	5200	19.67	21.04	19.29	304.658	24.84	30	Pass
48	5240	19.95	21.60	19.40	330.495	25.19	30	Pass
149	5745	16.65	17.24	16.44	143.259	21.56	30	Pass
157	5785	16.23	17.30	16.71	142.560	21.54	30	Pass
165	5825	16.70	17.41	16.79	149.608	21.75	30	Pass

##### 802.11n (HT20)

Chan.	Freq. (MHz)	Maximum Conducted Power (dBm)			Total Power (mW)	Total Power (dBm)	Power Limit (dBm)	Pass / Fail
		Chain 0	Chain 1	Chain 2				
36	5180	18.84	19.74	18.63	243.695	23.87	30	Pass
40	5200	20.70	22.02	20.33	384.606	25.85	30	Pass
48	5240	20.70	21.91	19.93	371.130	25.70	30	Pass
149	5745	16.52	17.08	16.25	138.095	21.40	30	Pass
157	5785	16.38	17.51	16.17	141.215	21.50	30	Pass
165	5825	16.59	17.12	16.30	139.785	21.45	30	Pass

##### 802.11n (HT40)

Chan.	Freq. (MHz)	Maximum Conducted Power (dBm)			Total Power (mW)	Total Power (dBm)	Power Limit (dBm)	Pass / Fail
		Chain 0	Chain 1	Chain 2				
38	5190	14.40	15.62	14.23	90.502	19.57	30	Pass
46	5230	22.19	22.94	21.09	<b>490.895</b>	26.91	30	Pass
151	5755	14.07	14.75	14.14	81.323	19.10	30	Pass
159	5795	17.70	18.31	17.39	<b>181.476</b>	22.59	30	Pass

##### 802.11ac (VHT80)

Chan.	Freq. (MHz)	Maximum Conducted Power (dBm)			Total Power (mW)	Total Power (dBm)	Power Limit (dBm)	Pass / Fail
		Chain 0	Chain 1	Chain 2				
42	5210	12.16	13.08	11.49	50.861	17.06	30	Pass
155	5775	11.04	11.72	10.72	39.368	15.95	30	Pass



**26dB Bandwidth:**
**802.11a**

Channel	Channel Frequency (MHz)	26dBc Bandwidth (MHz)			Pass / Fail
		Chain 0	Chain 1	Chain 2	
36	5180	22.39	21.55	21.31	Pass
40	5200	21.99	21.98	21.61	Pass
48	5240	22.21	21.85	21.29	Pass

**802.11n (HT20)**

Channel	Channel Frequency (MHz)	26dBc Bandwidth (MHz)			Pass / Fail
		Chain 0	Chain 1	Chain 2	
36	5180	23.44	22.55	22.93	Pass
40	5200	23.12	22.81	22.96	Pass
48	5240	22.22	22.70	23.11	Pass

**802.11n (HT40)**

Channel	Channel Frequency (MHz)	26dBc Bandwidth (MHz)			Pass / Fail
		Chain 0	Chain 1	Chain 2	
38	5190	45.31	45.66	44.86	Pass
46	5230	45.65	45.46	44.93	Pass

**802.11ac (VHT80)**

Channel	Channel Frequency (MHz)	26dBc Bandwidth (MHz)			Pass / Fail
		Chain 0	Chain 1	Chain 2	
42	5210	85.42	86.04	84.79	Pass

Spectrum Plot of Worst Value

802.11a

802.11n (HT20)

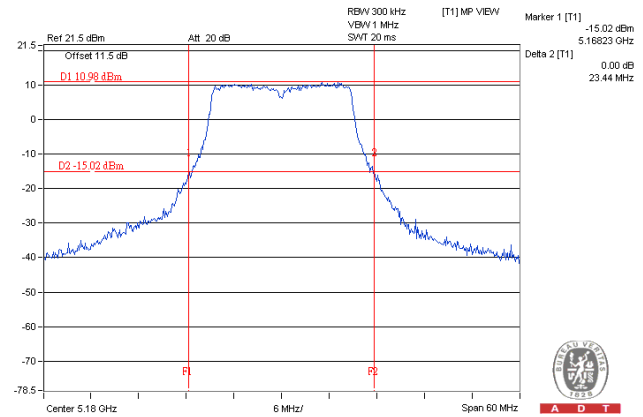
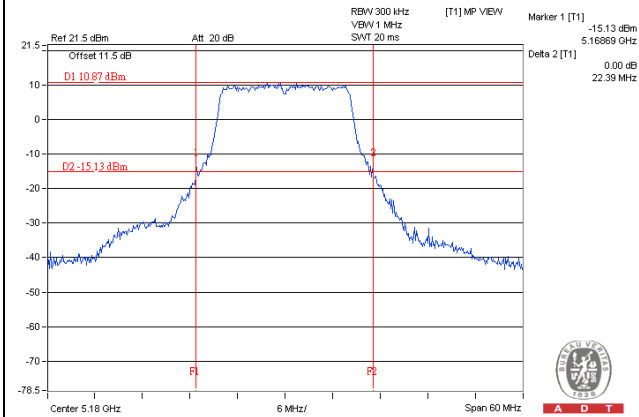

802.11n (HT40)

802.11ac (VHT80)

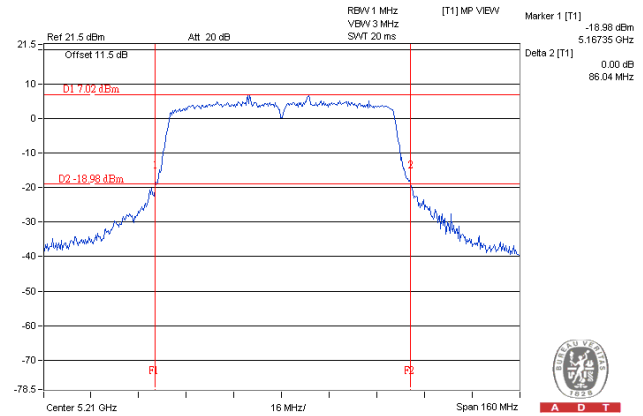
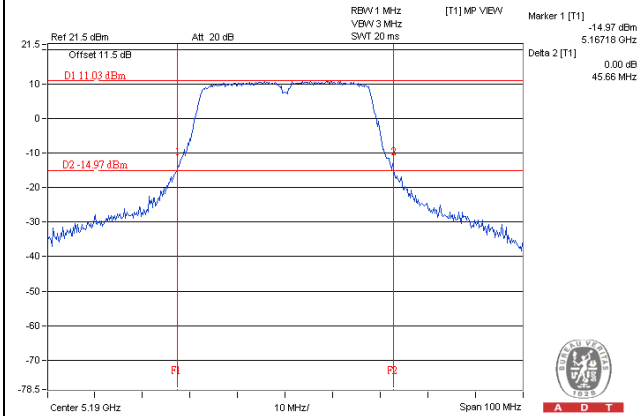

**Occupied Bandwidth:**
**802.11a**

Chan.	Freq. (MHz)	Occupied Bandwidth (MHz)		
		Chain 0	Chain 1	Chain 2
36	5180	16.80	16.68	16.68
40	5200	16.68	16.80	16.68
48	5240	16.80	16.68	16.68
149	5745	16.68	16.68	16.68
157	5785	16.80	16.68	16.68
165	5825	16.80	16.68	16.68

**802.11n (HT20)**

Chan.	Freq. (MHz)	Occupied Bandwidth (MHz)		
		Chain 0	Chain 1	Chain 2
36	5180	18.00	17.88	17.88
40	5200	17.88	17.76	17.88
48	5240	17.88	17.76	18.00
149	5745	17.88	18.00	17.76
157	5785	17.76	17.88	17.76
165	5825	17.88	17.88	18.00

**802.11n (HT40)**

Chan.	Freq. (MHz)	Occupied Bandwidth (MHz)		
		Chain 0	Chain 1	Chain 2
38	5190	36.60	36.60	36.60
46	5230	36.84	36.72	36.72
151	5755	36.60	36.48	36.60
159	5795	36.72	36.60	36.72

**802.11ac (VHT80)**

Chan.	Freq. (MHz)	Occupied Bandwidth (MHz)		
		Chain 0	Chain 1	Chain 2
42	5210	75.60	76.08	75.84
155	5775	75.84	75.84	75.84

**Spectrum Plot of Worst Value**

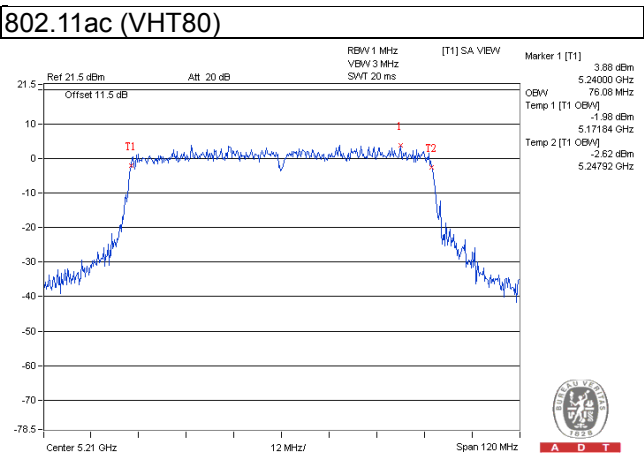
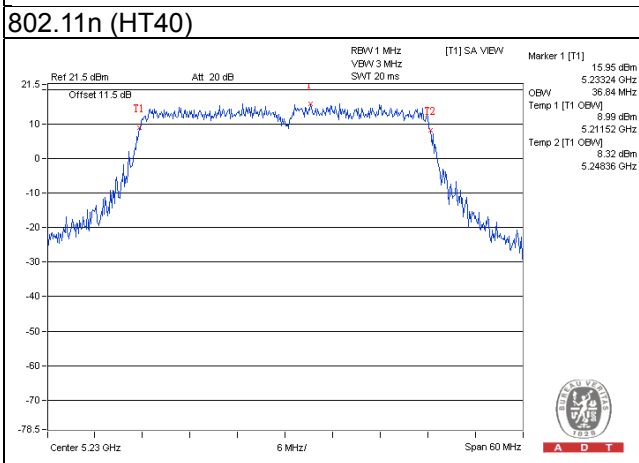
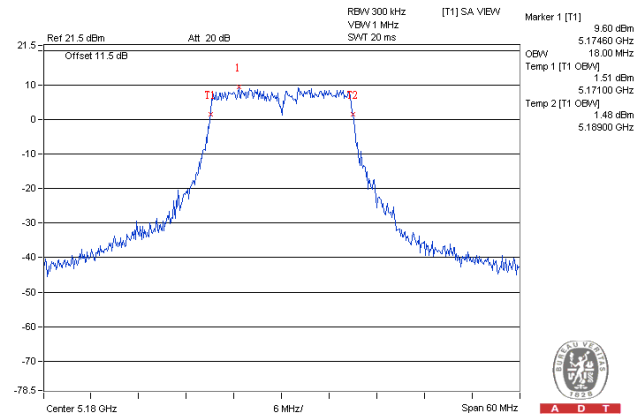
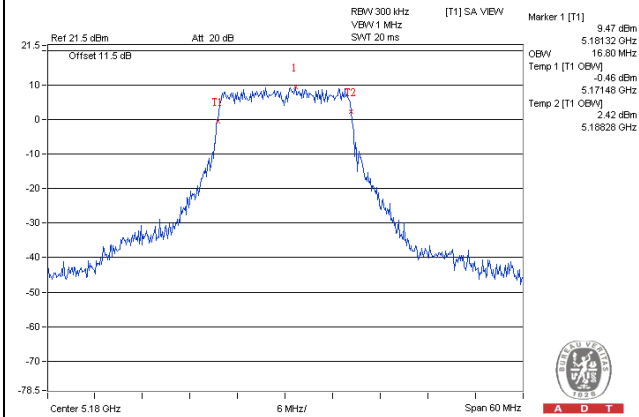

#### 4.4 Peak Power Spectral Density Measurement

##### 4.4.1 Limits of Peak Power Spectral Density Measurement

Operation Band	EUT Category		LIMIT
U-NII-1		Outdoor Access Point	17dBm/ MHz
		Fixed point-to-point Access Point	
	√	Indoor Access Point	11dBm/ MHz
		Mobile and Portable client device	
U-NII-2A	---		11dBm/ MHz
U-NII-2C	---		11dBm/ MHz
U-NII-3	√		30dBm/ 500kHz

##### 4.4.2 Test Setup

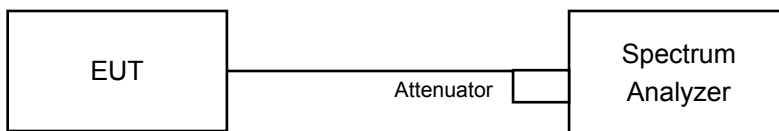

##### 4.4.3 Test Instruments

Refer to section 4.1.2 to get information of above instrument.

##### 4.4.4 Test Procedures

For U-NII-1 band:

Using method SA-2

- Set span to encompass the entire emission bandwidth (EBW) of the signal.
- Set RBW = 1 MHz, Set VBW ≥ 3 MHz, Detector = RMS
- Sweep time = auto, trigger set to “free run”.
- Trace average at least 100 traces in power averaging mode.
- Record the max value and add 10 log (1/duty cycle)

For U-NII-3 band:

- Set span to encompass the entire emission bandwidth (EBW) of the signal.
- Set RBW = 300 kHz, Set VBW ≥ 1 MHz, Detector = RMS
- Use the peak marker function to determine the maximum power level in any 300 kHz band segment within the fundamental EBW.
- Scale the observed power level to an equivalent value in 500 kHz by adjusting (reducing) the measured power by a bandwidth correction factor (BWCF) where  $BWCF = 10\log(500\text{ kHz}/300\text{kHz})$
- Sweep time = auto, trigger set to “free run”.
- Trace average at least 100 traces in power averaging mode.
- Record the max value and add 10 log (1/duty cycle)

#### **4.4.5 Deviation from Test Standard**

No deviation.

#### **4.4.6 EUT Operating Conditions**

Same as Item 4.3.6.

#### 4.4.7 Test Results

For U-NII-1 Band

802.11a

Chan.	Freq. (MHz)	PSD (dBm)			Total PSD w/o Duty Factor (dBm)	Duty Factor	Total PSD with Duty Factor (dBm)	Max. Limit (dBm)	Pass / Fail
		Chain 0	Chain 1	Chain 2					
36	5180	5.44	7.62	6.31	11.32	0.19	11.51	13.23	Pass
40	5200	7.11	8.89	7.42	12.65	0.19	12.84	13.23	Pass
48	5240	7.98	9.24	7.25	13.01	0.19	13.20	13.23	Pass

Note:

- Method 1 of power density measurement of KDB 662911 is using for calculating total power density. Total power density is summing entire spectra across corresponding frequency bins on the various outputs by computer.
- Directional gain =  $5\text{dBi} + 10\log(3) = 9.77\text{dBi} > 6\text{dBi}$ , so the power density limit shall be reduced to  $17 - (9.77 - 6) = 13.23\text{dBm}$ .
- Refer to section 3.3 for duty cycle spectrum plot.

802.11n (HT20)

Chan.	Freq. (MHz)	PSD (dBm)			Total PSD w/o Duty Factor (dBm)	Duty Factor	Total PSD with Duty Factor (dBm)	Max. Limit (dBm)	Pass / Fail
		Chain 0	Chain 1	Chain 2					
36	5180	5.29	7.30	5.71	10.96	0.17	11.13	13.23	Pass
40	5200	7.04	9.52	7.81	13.02	0.17	13.19	13.23	Pass
48	5240	7.00	9.17	7.34	12.71	0.17	12.88	13.23	Pass

Note:

- Method 1 of power density measurement of KDB 662911 is using for calculating total power density. Total power density is summing entire spectra across corresponding frequency bins on the various outputs by computer.
- Directional gain =  $5\text{dBi} + 10\log(3) = 9.77\text{dBi} > 6\text{dBi}$ , so the power density limit shall be reduced to  $17 - (9.77 - 6) = 13.23\text{dBm}$ .
- Refer to section 3.3 for duty cycle spectrum plot.

802.11n (HT40)

Chan.	Freq. (MHz)	PSD (dBm)			Total PSD w/o Duty Factor (dBm)	Duty Factor	Total PSD with Duty Factor (dBm)	Max. Limit (dBm)	Pass / Fail
		Chain 0	Chain 1	Chain 2					
38	5190	-1.72	-0.64	-1.57	3.49	0.45	3.94	13.23	Pass
46	5230	5.77	7.05	5.99	11.08	0.45	11.53	13.23	Pass

Note:

- Method 1 of power density measurement of KDB 662911 is using for calculating total power density. Total power density is summing entire spectra across corresponding frequency bins on the various outputs by computer.
- Directional gain =  $5\text{dBi} + 10\log(3) = 9.77\text{dBi} > 6\text{dBi}$ , so the power density limit shall be reduced to  $17 - (9.77 - 6) = 13.23\text{dBm}$ .
- Refer to section 3.3 for duty cycle spectrum plot.

802.11ac (VHT80)

Chan.	Freq. (MHz)	PSD (dBm)			Total PSD w/o Duty Factor (dBm)	Duty Factor	Total PSD with Duty Factor (dBm)	Max. Limit (dBm)	Pass / Fail
		Chain 0	Chain 1	Chain 2					
42	5210	-8.49	-6.88	-8.14	-3.01	0.72	-2.29	13.23	Pass

Note:

1. Method 1 of power density measurement of KDB 662911 is using for calculating total power density. Total power density is summing entire spectra across corresponding frequency bins on the various outputs by computer.
2. Directional gain = 5dBi + 10log(3) = 9.77dBi > 6dBi , so the power density limit shall be reduced to 17-(9.77-6) =13.23dBm.
3. Refer to section 3.3 for duty cycle spectrum plot.

**Spectrum Plot of Worst Value**

802.11a / Chain 1 / CH 48

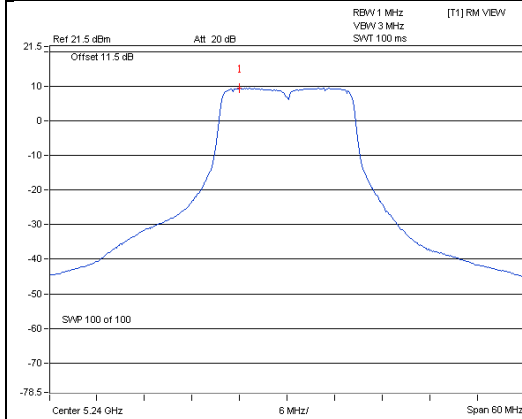

802.11n (HT20) / Chain 1 / CH 40

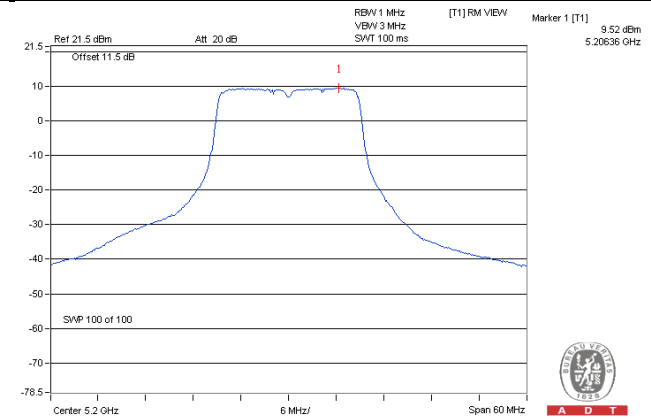

802.11n (HT40) / Chain 1 / CH 46

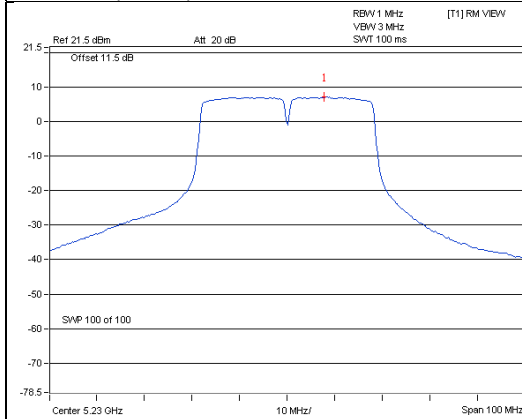

802.11ac (VHT80) / Chain 1 / CH 42

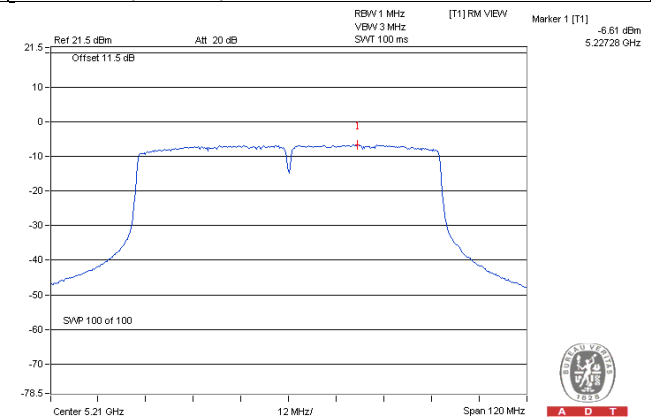



**For U-NII-3 Band**
**802.11a**

TX chain	Chan.	Freq. (MHz)	PSD (dBm /300kHz)	PSD (dBm /500kHz)	10 log (N=3) dB	Duty Factor	Total PSD (dBm /500kHz)	Limit (dBm /500kHz)	Pass /Fail
0	149	5745	-5.17	-2.95	4.77	0.19	2.01	26.23	Pass
	157	5785	-4.81	-2.59	4.77	0.19	2.37	26.23	Pass
	165	5825	-5.26	-3.04	4.77	0.19	1.92	26.23	Pass
1	149	5745	-3.59	-1.37	4.77	0.19	3.59	26.23	Pass
	157	5785	-3.59	-1.37	4.77	0.19	3.59	26.23	Pass
	165	5825	-3.91	-1.69	4.77	0.19	3.27	26.23	Pass
2	149	5745	-4.85	-2.63	4.77	0.19	2.33	26.23	Pass
	157	5785	-5.15	-2.93	4.77	0.19	2.03	26.23	Pass
	165	5825	-4.99	-2.77	4.77	0.19	2.19	26.23	Pass

**Note:**

- Method 1 of power density measurement of KDB 662911 is using for calculating total power density. Total power density is summing entire spectra across corresponding frequency bins on the various outputs by computer.
- Directional gain = 5dBi + 10log(3) = 9.77dBi > 6dBi , so the power density limit shall be reduced to 30-(9.77-6) = 26.23dBm.
- Refer to section 3.3 for duty cycle spectrum plot.

**802.11n (HT20)**

TX chain	Chan.	Freq. (MHz)	PSD (dBm /300kHz)	PSD (dBm /500kHz)	10 log (N=3) dB	Duty Factor	Total PSD (dBm /500kHz)	Limit (dBm /500kHz)	Pass /Fail
0	149	5745	-5.59	-3.37	4.77	0.17	1.57	26.23	Pass
	157	5785	-5.58	-3.36	4.77	0.17	1.58	26.23	Pass
	165	5825	-5.40	-3.18	4.77	0.17	1.76	26.23	Pass
1	149	5745	-4.35	-2.13	4.77	0.17	2.81	26.23	Pass
	157	5785	-4.47	-2.25	4.77	0.17	2.69	26.23	Pass
	165	5825	-4.84	-2.62	4.77	0.17	2.32	26.23	Pass
2	149	5745	-5.16	-2.94	4.77	0.17	2.00	26.23	Pass
	157	5785	-5.95	-3.73	4.77	0.17	1.21	26.23	Pass
	165	5825	-5.54	-3.32	4.77	0.17	1.62	26.23	Pass

**Note:**

- Method 1 of power density measurement of KDB 662911 is using for calculating total power density. Total power density is summing entire spectra across corresponding frequency bins on the various outputs by computer.
- Directional gain = 5dBi + 10log(3) = 9.77dBi > 6dBi , so the power density limit shall be reduced to 30-(9.77-6) = 26.23dBm.
- Refer to section 3.3 for duty cycle spectrum plot.

### 802.11n (HT40)

TX chain	Chan.	Freq. (MHz)	PSD (dBm /300kHz)	PSD (dBm /500kHz)	10 log (N=3) dB	Duty Factor	Total PSD (dBm /500kHz)	Limit (dBm /500kHz)	Pass /Fail
0	151	5755	-11.39	-9.17	4.77	0.45	-3.95	26.23	Pass
	159	5795	-7.64	-5.42	4.77	0.45	-0.20	26.23	Pass
1	151	5755	-10.03	-7.81	4.77	0.45	-2.59	26.23	Pass
	159	5795	-6.33	-4.11	4.77	0.45	1.11	26.23	Pass
2	151	5755	-11.39	-9.17	4.77	0.45	-3.95	26.23	Pass
	159	5795	-8.03	-5.81	4.77	0.45	-0.59	26.23	Pass

**Note:**

- Method 1 of power density measurement of KDB 662911 is using for calculating total power density. Total power density is summing entire spectra across corresponding frequency bins on the various outputs by computer.
- Directional gain =  $5\text{dBi} + 10\log(3) = 9.77\text{dBi} > 6\text{dBi}$  , so the power density limit shall be reduced to  $30-(9.77-6) = 26.23\text{dBm}$ .
- Refer to section 3.3 for duty cycle spectrum plot.

### 802.11ac (VHT80)

TX chain	Chan.	Freq. (MHz)	PSD (dBm /300kHz)	PSD (dBm /500kHz)	10 log (N=3) dB	Duty Factor	Total PSD (dBm /500kHz)	Limit (dBm /500kHz)	Pass /Fail
0	155	5775	-18.18	-15.96	4.77	0.72	-10.47	26.23	Pass
1	155	5775	-16.79	-14.57	4.77	0.72	-9.08	26.23	Pass
2	155	5775	-18.51	-16.29	4.77	0.72	-10.80	26.23	Pass

**Note:**

- Method 1 of power density measurement of KDB 662911 is using for calculating total power density. Total power density is summing entire spectra across corresponding frequency bins on the various outputs by computer.
- Directional gain =  $5\text{dBi} + 10\log(3) = 9.77\text{dBi} > 6\text{dBi}$  , so the power density limit shall be reduced to  $30-(9.77-6) = 26.23\text{dBm}$ .
- Refer to section 3.3 for duty cycle spectrum plot.

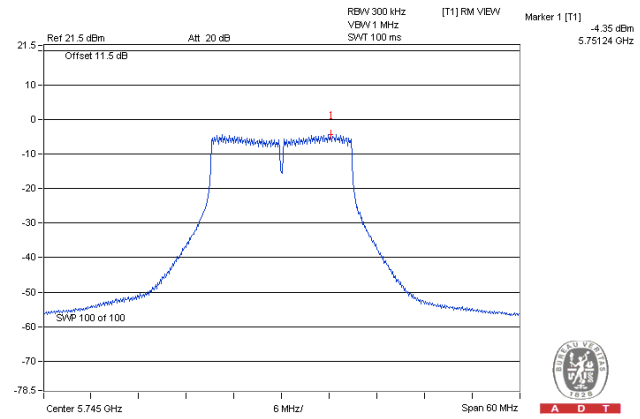
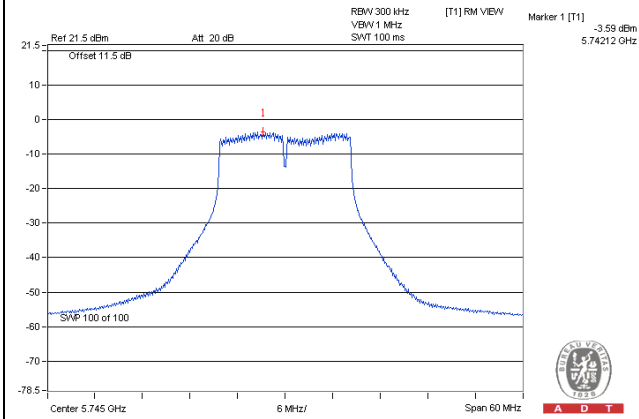
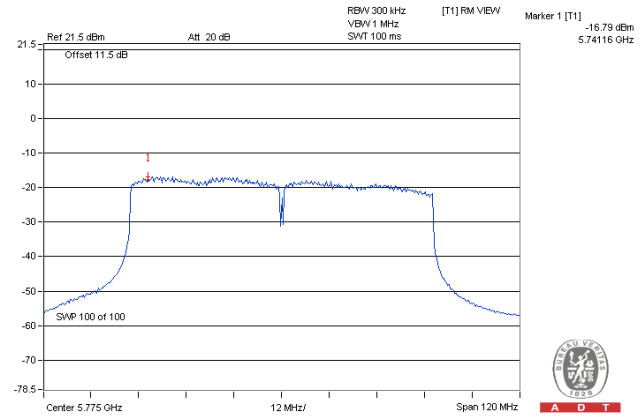
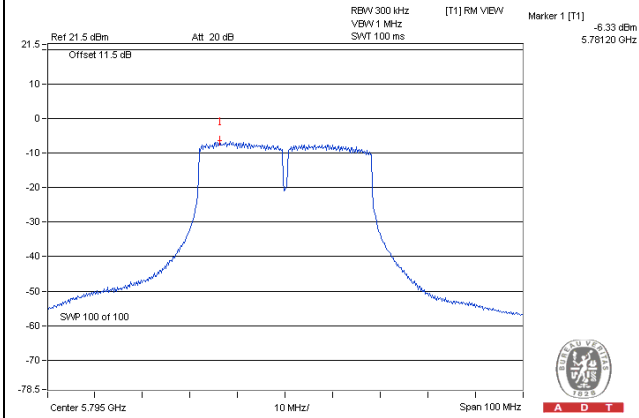
**Spectrum Plot of Worst Value****802.11a****802.11n (HT20)****802.11n (HT40)****802.11ac (VHT80)**

## 4.5 Frequency Stability

### 4.5.1 Limits of Frequency Stability Measurement

The frequency of the carrier signal shall be maintained within band of operation

### 4.5.2 Test Setup

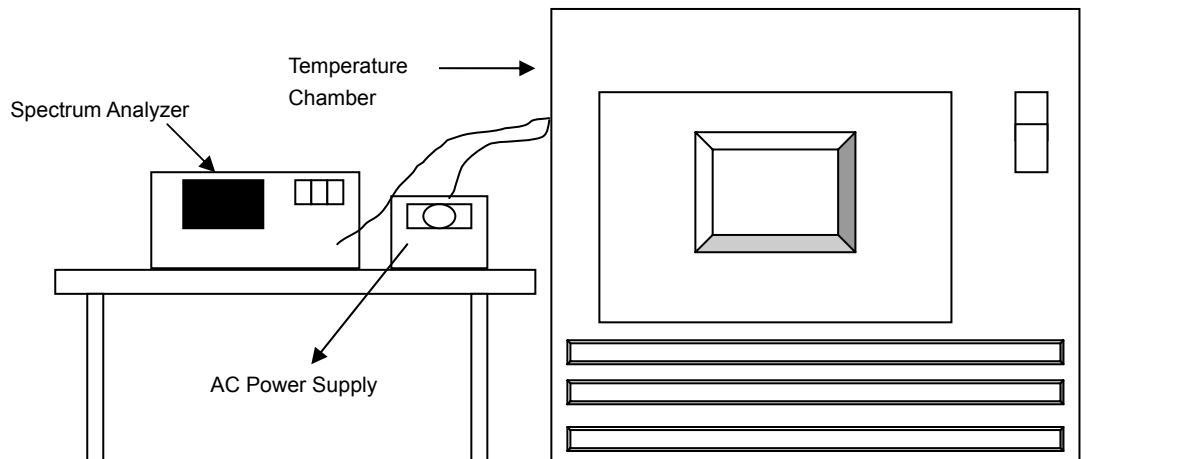

### 4.5.3 Test Instruments

Refer to section 4.1.2 to get information of above instrument.

### 4.5.4 Test Procedure

- a. The EUT was placed inside the environmental test chamber and powered by nominal AC voltage.
- b. Turn the EUT on and couple its output to a spectrum analyzer.
- c. Turn the EUT off and set the chamber to the highest temperature specified.
- d. Allow sufficient time (approximately 30 min) for the temperature of the chamber to stabilize, turn the EUT on and measure the operating frequency after 2, 5, and 10 minutes.
- e. Repeat step 2 and 3 with the temperature chamber set to the lowest temperature.
- f. The test chamber was allowed to stabilize at +20 degree C for a minimum of 30 minutes. The supply voltage was then adjusted on the EUT from 85% to 115% and the frequency record.

### 4.5.5 Deviation from Test Standard

No deviation.

### 4.5.6 EUT Operating Condition

Set the EUT transmit at un-modulation mode to test frequency stability.

#### 4.5.7 Test Results

Frequency Stability Versus Temp.									
Operating Frequency: 5180MHz									
Temp. (°C)	Power Supply (Vac)	0 Minute		2 Minute		5 Minute		10 Minute	
		Measured Frequency (MHz)	Frequency Drift (%)	Measured Frequency (MHz)	Frequency Drift (%)	Measured Frequency (MHz)	Frequency Drift (%)	Measured Frequency (MHz)	Frequency Drift (%)
50	120	5179.9794	-0.00040	5179.9787	-0.00041	5179.9808	-0.00037	5179.9807	-0.00037
40	120	5180.0108	0.00021	5180.0159	0.00031	5180.0158	0.00031	5180.0148	0.00029
30	120	5180.0134	0.00026	5180.0116	0.00022	5180.0128	0.00025	5180.015	0.00029
20	120	5179.9845	-0.00030	5179.9854	-0.00028	5179.9826	-0.00034	5179.981	-0.00037
10	120	5180.0201	0.00039	5180.0215	0.00042	5180.0226	0.00044	5180.0249	0.00048
0	120	5180.0173	0.00033	5180.0189	0.00036	5180.0176	0.00034	5180.0184	0.00036
-10	120	5179.9975	-0.00005	5179.9967	-0.00006	5179.9981	-0.00004	5180.0007	0.00001
-20	120	5179.9956	-0.00008	5179.9949	-0.00010	5179.9966	-0.00007	5179.9972	-0.00005
-30	120	5179.9968	-0.00006	5179.9989	-0.00002	5179.9998	0.00000	5179.9973	-0.00005

Frequency Stability Versus Voltage.									
Operating Frequency: 5180MHz									
Temp. (°C)	Power Supply (Vac)	0 Minute		2 Minute		5 Minute		10 Minute	
		Measured Frequency (MHz)	Frequency Drift (%)	Measured Frequency (MHz)	Frequency Drift (%)	Measured Frequency (MHz)	Frequency Drift (%)	Measured Frequency (MHz)	Frequency Drift (%)
20	138	5179.9854	-0.00028	5179.9852	-0.00029	5179.9834	-0.00032	5179.981	-0.00037
	120	5179.9845	-0.00030	5179.9854	-0.00028	5179.9826	-0.00034	5179.981	-0.00037
	102	5179.9844	-0.00030	5179.9862	-0.00027	5179.9823	-0.00034	5179.9813	-0.00036

## 4.6 6dB Bandwidth Measurement

### 4.6.1 Limits of 6dB Bandwidth Measurement

The minimum of 6dB Bandwidth Measurement is 0.5MHz.

### 4.6.2 Test Setup

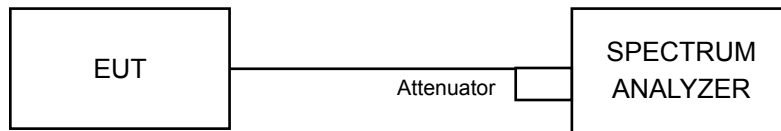

### 4.6.3 Test Instruments

Refer to section 4.1.2 to get information of above instrument.

### 4.6.4 Test Procedure

#### MEASUREMENT PROCEDURE REF

- Set resolution bandwidth (RBW) = 100kHz
- Set the video bandwidth (VBW)  $\geq 3 \times$  RBW, Detector = Peak.
- Trace mode = max hold.
- Sweep = auto couple.
- Measure the maximum width of the emission that is constrained by the frequencies associated with the two amplitude points (upper and lower) that are attenuated by 6 dB relative to the maximum level measured in the fundamental emission

### 4.6.5 Deviation from Test Standard

No deviation.

### 4.6.6 EUT Operating Condition

The software provided by client to enable the EUT under transmission condition continuously at lowest, middle and highest channel frequencies individually.

#### 4.6.7 Test Results

##### 802.11a

Chan.	Freq. (MHz)	6dB Bandwidth (MHz)			Minimum Limit (MHz)	Pass / Fail
		Chain 0	Chain 1	Chain 2		
149	5745	16.51	16.44	16.46	0.5	Pass
157	5785	16.42	16.43	16.47	0.5	Pass
165	5825	16.42	16.43	16.46	0.5	Pass

##### 802.11n (HT20)

Chan.	Freq. (MHz)	6dB Bandwidth (MHz)			Minimum Limit (MHz)	Pass / Fail
		Chain 0	Chain 1	Chain 2		
149	5745	17.66	17.66	17.65	0.5	Pass
157	5785	17.64	17.65	17.65	0.5	Pass
165	5825	17.65	17.64	17.66	0.5	Pass

##### 802.11n (HT40)

Chan.	Freq. (MHz)	6dB Bandwidth (MHz)			Minimum Limit (MHz)	Pass / Fail
		Chain 0	Chain 1	Chain 2		
151	5755	36.17	35.78	36.44	0.5	Pass
159	5795	36.36	35.82	36.39	0.5	Pass

##### 802.11ac (VHT80)

Chan.	Freq. (MHz)	6dB Bandwidth (MHz)			Minimum Limit (MHz)	Pass / Fail
		Chain 0	Chain 1	Chain 2		
155	5775	73.67	73.22	75.92	0.5	Pass

**Spectrum Plot of Worst Value**

**802.11a**

**802.11n (HT20)**

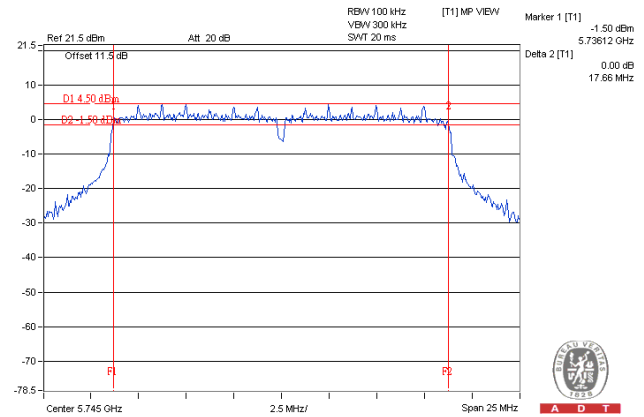
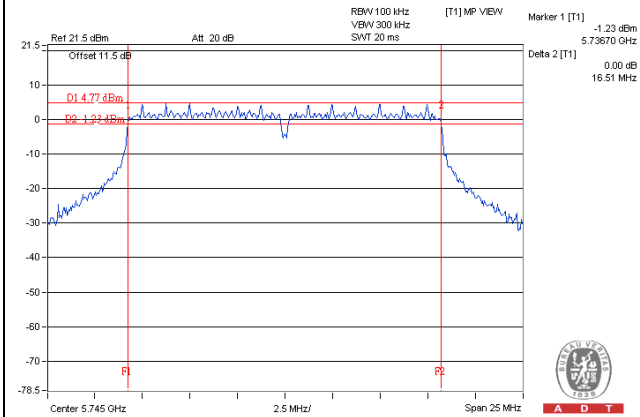

**802.11n (HT40)**

**802.11ac (VHT80)**

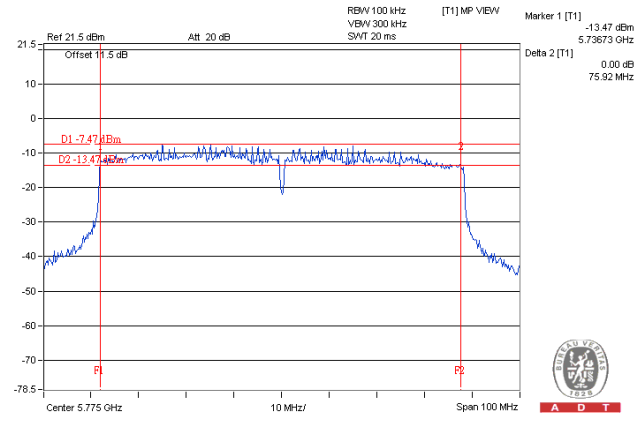
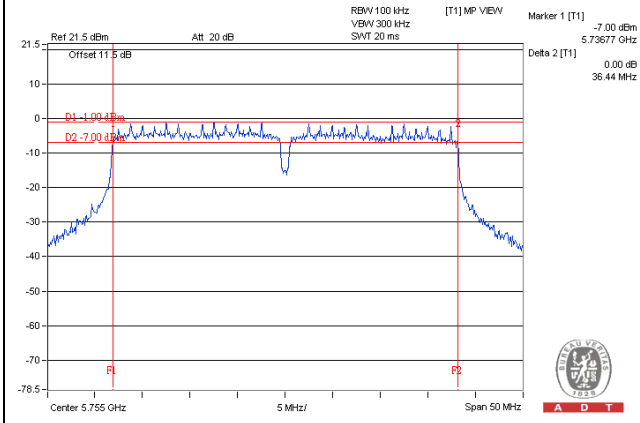



## 5 Pictures of Test Arrangements

Please refer to the attached file (Test Setup Photo).

## Appendix – Information on the Testing Laboratories

We, Bureau Veritas Consumer Products Services (H.K.) Ltd., Taoyuan Branch, were founded in 1988 to provide our best service in EMC, Radio, Telecom and Safety consultation. Our laboratories are accredited and approved according to ISO/IEC 17025.

If you have any comments, please feel free to contact us at the following:

### **Linko EMC/RF Lab**

Tel: 886-2-26052180

Fax: 886-2-26051924

### **Hsin Chu EMC/RF/Telecom Lab**

Tel: 886-3-6668565

Fax: 886-3-6668323

### **Hwa Ya EMC/RF/Safety Lab**

Tel: 886-3-3183232

Fax: 886-3-3270892

**Email:** [service.adt@tw.bureauveritas.com](mailto:service.adt@tw.bureauveritas.com)

**Web Site:** [www.bureauveritas-adt.com](http://www.bureauveritas-adt.com)

The address and road map of all our labs can be found in our web site also.

--- END ---