



# User Guide

Model: APOS A8



This document is the property of LANDI.  
Its content cannot be reproduced or divulged without the company's written approval.

---

## Contents

1. Introduction.....	3
2. Unpacking.....	3
3. Appearance of APOS A8.....	4
4. Use of the terminal.....	5
4.1 Power on/Power off the terminal .....	5
4.2 Reading cards.....	6
4.3 Installing Modules.....	7
4.4 Paper roll.....	8
4.5 Battery .....	9
5. Recommendations.....	11
5.1 Safety .....	11
5.2 Security of your terminal .....	12
5.3 Cleaning of the terminal .....	12
5.4 Transport and storage .....	13
6. Standard.....	13
7. Troubleshooting.....	15

---

# 1. Introduction

Thank you for choosing a Landi payment terminal.

We recommend you to read carefully this user guide: It gives you the necessary information about safety precautions, unpacking, installation, and maintenance of your terminal.

## **WARRANTY/SECURITY**

---



To benefit from the guarantee-related product, and to respect the security, we ask you to use only the power supply delivered in box with the product, entrusting maintenance operations only to an authorized person.

Failure to comply with these instructions will avoid the manufacturer's responsibility.

---

## 2. Unpacking

---



### **ADVICE**

Carefully preserve the packaging of the APOS A8. It must be re-used whenever the terminal is shipped.

---

According to the model, the following items are included in the APOS A8 box (including optional accessories):

- APOS A8 terminal
- Power adapter
- This user guide
- A battery pack



### **CAUTION**

The power adapter provided with your equipment is specially designed for Landi APOS A8 terminal. Do not use any other power supply. The use of a power supply with apparently similar voltage/current characteristics may damage your terminal.

---

### 3. Appearance of APOS A8



1. Contactless landing zone, 2. LCD and touch screen, 3. Smart card reader, 4. Magnetic card reader, 5. Microphone, 6. Easy Loading Printer,

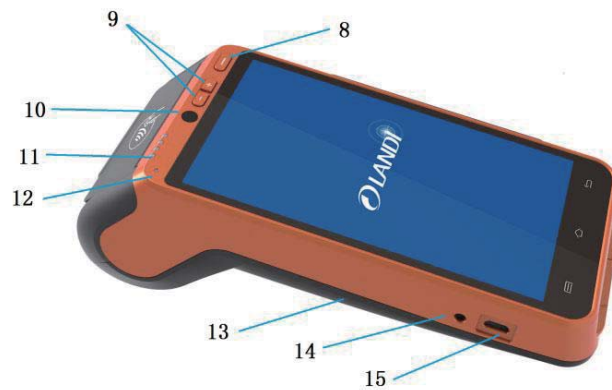

8. Power Key, 9. Volume Keys, 10. Front scanner, 11. LEDs for Contactless Card, 12. Charging LED, 13. Battery cover, 14. Headphone jack, 15. MicroUSB connector

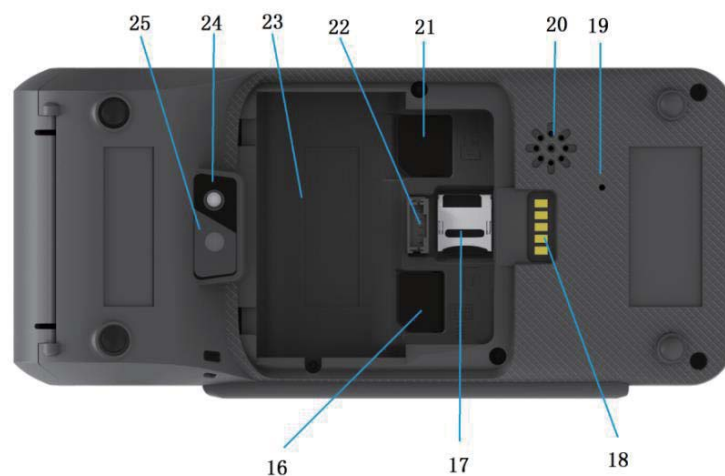

16. SIM card slot, 17. MicroSD slot, 18. Extended interface, 19. Buzzer, 20. Speaker 21. SAM card slots, 22. Battery socket 23. Battery compartment 24. Flash 25. Rear camera

Weight	445g (including battery)
Dimension (L x W x H)	183mm x 84mm x 64mm
Electrical mains network	100-240VAC/50-60Hz

#### Operating conditions

Ambient temperature	-10°C~50°C
Max relative humidity	10%~90%, Non-condensing

#### Storage conditions

Storage temperature	-20°C~70°C
Max relative humidity	5%~90%, Non-condensing

### 3.1 Keypad Function

The terminal has three physical keys in total, a power button and two volume keys. They are placed at the upper right corner of the front casing.



## 4. Use of the terminal



### ADVICE

Before using the terminal, please confirm the roll of paper is in place.

### 4.1 Power on/Power off the terminal

To power on: Make sure the terminal battery is correctly installed and Press <Power> button for about 1s until the display is turned up.

To power off: Press <Power> button for more than 2s until the display show the following figure, select <Power off> then press it.

---

 **Power off**

 **Profile**  
Default

 **Reboot**

 **Airplane mode**  
Airplane mode is OFF

 **Silent mode**  
Sound is ON

If the battery is empty, the terminal automatically shuts off.

Abnormal power off:

When the device works abnormally, for example, it is crashed and no actions menu popped out while pressing the power button, please long-press the power button for 6s, the device will be automatically powered off.

Screen switch operation:

Short-press the power button for about 0.5s, the terminal display will be turned on or off.

## 4.2 Reading cards

### Magnetic stripe card

The card can be read bi-directionally, with the stripe facing the terminal. Use a regular movement in order to ensure a reliable card reading.

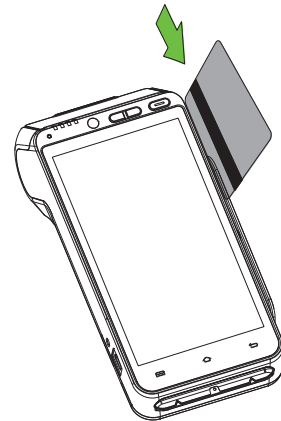

### Smart card

Insert the card horizontally with the metal chip facing upward and leave in position throughout the transaction.

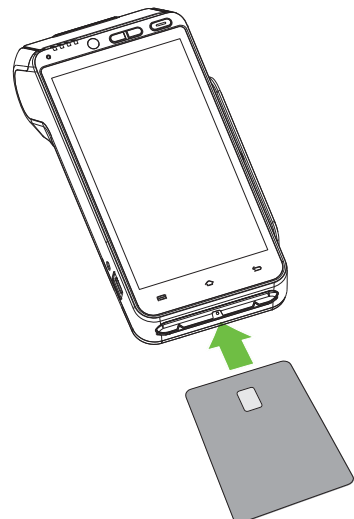

---

## Contactlesscard

Bring the card firmly up to the active zone. Keep the card close to the reader during the transaction.

The front LEDs light up to indicate the transaction process.

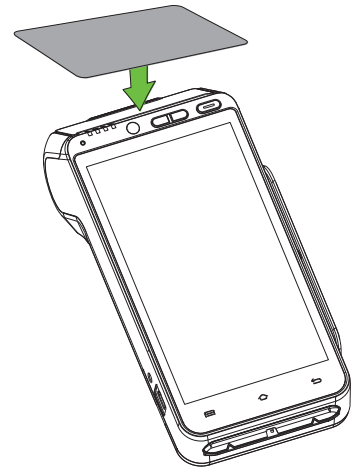

## 4.3 Installing Modules

### 4.3.1 SAM1/SAM2/SIM



---

#### CAUTION:

Switch off the terminal before opening the trapdoor.

---

The SAM/SIM connectors are located inside the terminal, in a closed compartment.

- Turn the terminal and remove the trapdoor.

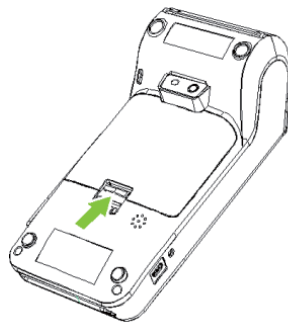

- SAM1, SAM2 and SIM are identified by the engraved marks on the lower housing.
- When introducing a SAM/SIM in its slot, be sure to put the cut corner as indicated on the picture.

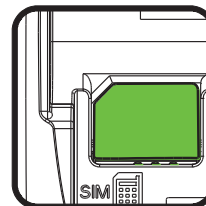
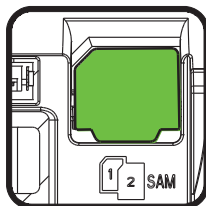
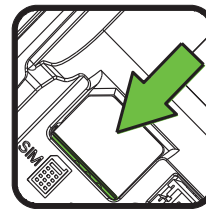
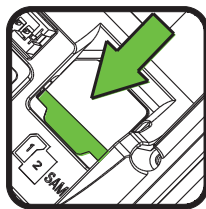

- Close the trapdoor.



## NOTICE

When using only one SAM card, it is recommended to insert SAM1 slot (bottom).



## NOTICE

The appearance of the sockets of SIM card and SAM are the same. The SIM socket has only one slot while the SAM socket has two. Please note it.

### 4.3.2 MicroSD Memory Card



#### CAUTION:

Switch off the terminal before opening the trapdoor.

MicroSD connector is located inside the terminal, in a closed compartment.

- Turn the terminal and remove the trapdoor.
- MicroSD is identified by the engraved marks on the lower housing.
- Push the cover backwards and open it. Insert MicroSD card and then close the cover and pull forwards. Be sure to put the MicroSD contacts downside and the cut corner as indicated on the figure.
- Close the trapdoor.

The terminal supports MicroSD up to 32GB.

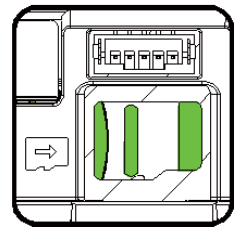
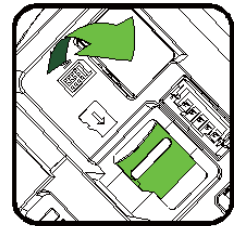

### 4.4 Paper roll

#### 4.4.1 Main characteristics of APOS A8 paper roll

Paper roll characteristics	Precisions
Color	White
Width	58mm
Diameter	40mm
Length	About 18 meters

#### 4.4.2 Installing paper roll

- Open the paper cover by lifting the catch located at the top of APOS A8 and pull the cover to the rear of the terminal.
- Insert the paper roll in the compartment following the directions shown on the below picture.
- Pull the paper up to the top of terminal, maintain the paper and close the cover
- Press simultaneously on both upper corners of the paper flap until it clips into position.



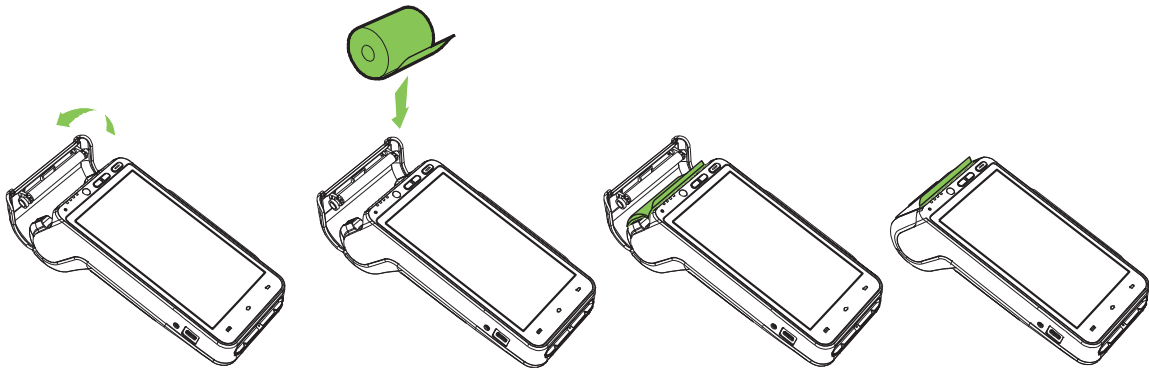

## NOTICE

If you insert a new R40 paper roll, tear off the first length (one complete turn to avoid printing on adhesive footprint).

## 4.5 Battery

### 4.5.1 Installing the battery



#### CAUTION:

Check that the terminal is not connected to the main electric network.

- Turn your terminal and unclip the battery trapdoor by pushing the clips as shown with the arrow on the picture.
- Disengage the trapdoor.
- Take the battery pack included in the box
- Locate the battery pack connector beside the battery compartment
- Plug the battery pack connector according to the connector locating system.
- Place the battery pack in its compartment
- Close the battery trapdoor.

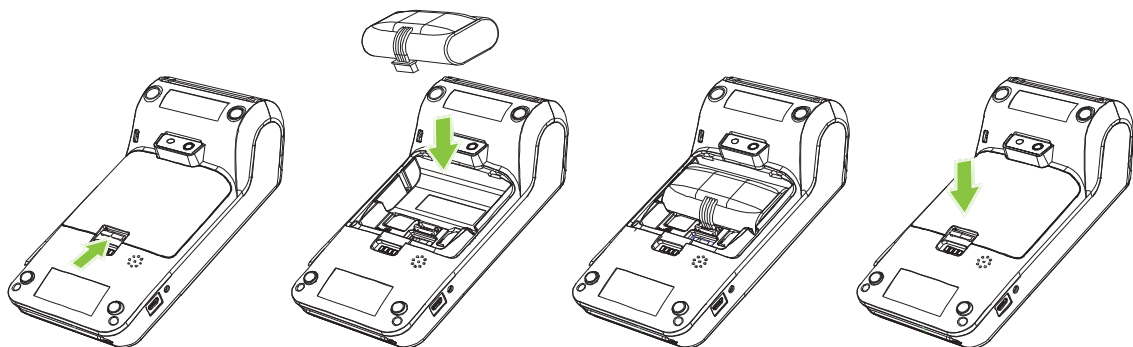

## 4.5.2 Charging the battery

When does the battery need to be charged?

- When used daily, the terminal recharges its battery each time the power adapter is connected. Charging is automatic.

How can the battery be charged?

Using the power adapter

- Connect the power adapter to the terminal micro USB type A connector located on the left side of the terminal.
- Connect the power adapter to the power supply mains network.
- Check if the Red LED at the top of front is lighted. (It means battery charging)

## 4.5.3 Headphone Jack & uUSB

There is a 3.5mm head phone jack and a Micro USB A connector on the left side of the terminal. The connector manages Host and Slave connections.

Note: The Micro USB port only supports charging.

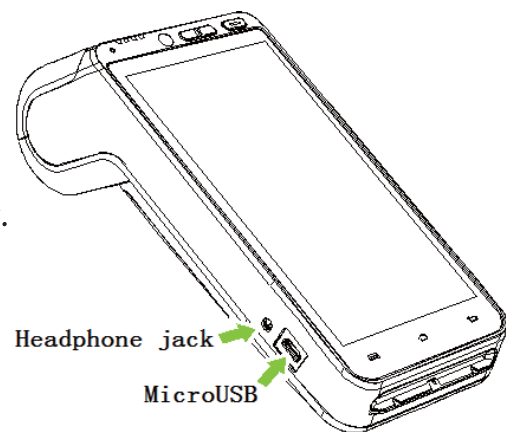

## 4.5.4 Usage of Front Scanner

- The brightness of the mobile phone must be set to the brightest or more than the  $\frac{2}{3}$  of the maximum brightness.
- The screen of the mobile phone must be toward to the front scanning head above the terminal screen and then keep it stationary.
- The screen of the mobile phone must parallel the front scanning head.
- The vertical distance between the screen of the mobile phone and the front scanning head should be 10~30 cm; and 20 cm would be the best.
- The terminal will beep with a successful scanning.

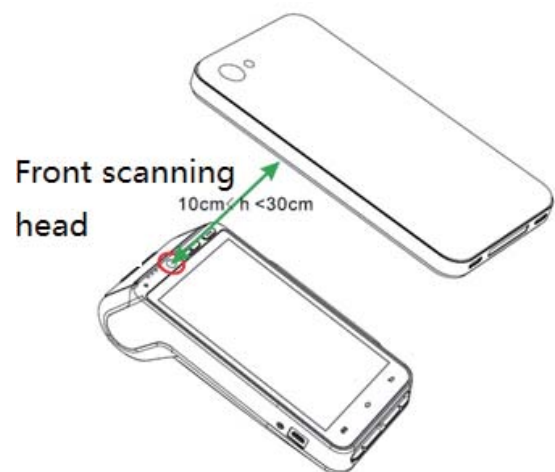

---

## 5. Recommendations

### 5.1 Safety

#### Powering down the APOS A8

Disconnect the APOS A8 power supply block adapter from the electrical mains network.

#### Lithium cell

The APOS A8 is fitted with an internal lithium cell which can only be accessed by a qualified technician.

#### Battery

APOS A8 is fitted with battery specially designed for this terminal.

- Only use the appropriate chargers and batteries listed in the Landi 's catalogue.
- Do not short - circuit the battery.
- Do not attempt to open the battery container.
- Used batteries must be disposed of at the appropriated sites.

The lifespan of battery depends on:

- Features
- Cycle number of charge and discharge
- Use temperature

#### Warning

There is a risk of explosion if the battery is incorrectly replaced or thrown into the fire.

#### Electrical power supply network

Provide an electrical outlet:

- Located near the equipment and easily accessible
- Must meet the standards and regulations in the country of use.
- For type A plug, the protection of the installation must be set to 20 A.

#### SAM1/SAM2/SIM Readers compartment

The trapdoor for battery, SAM1/SAM2/SIM, readers located underneath the terminal, must be in place during the normal operation of the terminal.

#### On airplanes

Your terminal must be switched off by removing the battery pack. Remove the battery from the terminal when on an airplane.

Non-compliance with these safety rules may result in legal action and/or a ban on later access to cellular network services.

---

## Explosion areas

Some regulations restrict the use of radio equipment in chemical plants, fuel depots and any site where blasting is carried out. You are urged to comply with these regulations. The terminal shall be protected by a specially fitted and certified cover enabling use in proximity to a fuel pump.

## Thunderstorm weather

According to some relevant reports, the mobile phone electromagnetic wave is good conductor of lightning. It is much easier to suffer lightning strike when the damp atmosphere form a magnetic conductivity, especially in open areas. Do not use wireless terminals under thunderstorm weather.

## Electronic health appliances

Your terminal is a radio transmitter which may interfere with health appliances, such as hearing aids, pacemaker, hospital equipment, etc.

Your doctor or the equipment manufacturer will be able to provide you with appropriate advice.

## 5.2 Security of your terminal

Your device fulfills current applicable PCI PTS security requirements.

Upon receipt of your terminal you should check for signs of tampering of the equipment. It is strongly advised that these checks are performed regularly after receipt. You should check, for example: that the keypad is firmly in place; that there is no evidence of unusual wires that have been connected to any ports on your terminal or associated equipment, the chip card reader, or any other part of your terminal. Such checks would provide warning of any unauthorized modifications to your terminal, and other suspicious behavior of individuals that have access to your terminal. Your terminal detects any “tampered state”. In this state the terminal will repeatedly flash the message “Warning Detected” and further use of the terminal will not be possible. If you observe the “Warning Detected” message, you should contact the terminal helpdesk immediately.

You are strongly advised to ensure that privileged access to your terminal is only granted to staff that have been independently verified as being trustworthy.

### **CAUTION**



Never ask the customer to divulge their PIN Code. Customers should be advised to ensure that they are not being overlooked when entering their PIN Code.

The terminal must never be put in or left at a location where it could be stolen or replaced with another device.

## 5.3 Cleaning of the terminal

First of all, unplug all the wires from terminal.

Good rules for proper cleaning of the terminal are:

- 
- Use a soft cloth that is very slightly soaked with soapy water to clean the outside of terminal.
  - Do not clean the electrical connections.
  - Do not use in any case, solvents, detergents or abrasive products: Those materials might damage the plastic or electrical contacts.
  - Avoid exposing the terminal to the direct rays of the sun.
  - Do not put anything into the slot of the smart card reader.

## 5.4 Transport and storage

Adopt general transportation mode, and prevent the goods from sunlight, snow, shower and mechanical impact. Transport the devices with care, do not throw it forcibly. Prevent the packaging from extrusion during transportation, to avoid breakage.

The product should be stored in the original packing box. The warehouse is not allowed to have all sorts of harmful gases, inflammable, explosive, corrosive chemical goods, strong mechanical vibration and strong magnetic field. Packing box should be at least 15cm above the ground, and be away from heat, cold, window or air inlet source at least 50cm.

## 6. Standard

### Environment (WEEE, Batteries and packaging)

This product is labeled in accordance with European Directives 2002/96/EC concerning Waste Electrical and Electronic Equipment (WEEE) and 2006/66/EC concerning Batteries and Accumulators. Those provisions are requiring producers and manufacturers to become liable for take-back, treatment and recycling upon end of life of equipment and batteries.

#### BATTERIES

If your product contains batteries, they must be disposed of at appropriate collection points.

#### THE PRODUCT



The crossed-out waste bin stuck on the product or its accessories means that the product belongs to the family of electrical and electronic equipment, and waste batteries must not be thrown away but collected separately and recycled.

Please contact your retailers for more detailed information about the compliance solution in place for disposing of your old product and used batteries.

Packaging waste must also be collected separately to assure a proper disposal and recycling.

In this way you can participate in the re-use and upgrading of Electrical and Electronic Equipment Waste, which can have an effect on the environment and human health.

---

## FCC Warning

Any Changes or modifications not expressly approved by the party responsible for compliance could void the user's authority to operate the equipment.

This device complies with part 15 of the FCC Rules. Operation is subject to the following two conditions: (1) This device may not cause harmful interference, and (2) this device must accept any interference received, including interference that may cause undesired operation.

Note: This equipment has been tested and found to comply with the limits for a Class B digital device, pursuant to part 15 of the FCC Rules. These limits are designed to provide reasonable protection against harmful interference in a residential installation. This equipment generates, uses and can radiate radio frequency energy and, if not installed and used in accordance with the instructions, may cause harmful interference to radio communications. However, there is no guarantee that interference will not occur in a particular installation. If this equipment does cause harmful interference to radio or television reception, which can be determined by turning the equipment off and on, the user is encouraged to try to correct the interference by one or more of the following measures:

- Reorient or relocate the receiving antenna.
- Increase the separation between the equipment and receiver.
- Connect the equipment into an outlet on a circuit different from that to which the receiver is connected.
- Consult the dealer or an experienced radio/TV technician for help.

### Specific Absorption Rate (SAR) information

SAR tests are conducted using standard operating positions accepted by the FCC/ISED with the device transmitting at its highest certified power level in all tested frequency bands, although the SAR is determined at the highest certified power level, the actual SAR level of the device while operating can be well below the maximum value. Before a new product is available for sale to the public, it must be tested and certified to the FCC/ISED that it does not exceed the exposure limit established by the FCC/ISED, tests for each device are performed in positions and locations as required by the FCC/ISED.

For device, this part has been tested and meets the FCC/ISED RF exposure guidelines when used with an accessory designated for this product or when used with an accessory that contains no metal.

For hand hold and body supported operation, this device has been tested and meets the FCC/ISED RF exposure guidelines when used with an accessory designated for this product or when used with an accessory that Contains no metal and that positions the handset a minimum of 0 mm from the body. Non-compliance with the above restrictions may result in violation of RF exposure guidelines.



---

## ISED WARNING:

This device complies with Innovation, Science and Economic Development Canada licence-exempt RSS standard (s). Operation is subject to the following two conditions: (1) this device may not cause interference, and (2) this device must accept any interference, including interference that may cause undesired operation of the device.

Le présent appareil est conforme aux CNR d'Innovation, la science et le développement économique Canada licenciables aux appareils radio exempts de licence.

L'exploitation est autorisée aux deux conditions suivantes:

- (1) l'appareil ne doit pas produire de brouillage, et
- (2) l'utilisateur de l'appareil doit accepter tout brouillage radioélectrique subi, même si le brouillage est susceptible d'en compromettre le fonctionnement.

Under Innovation, Science and Economic Development Canada regulations, this radio transmitter may only operate using an antenna of a type and maximum (or lesser) gain approved for the transmitter by Industry Canada. To reduce potential radio interference to other users, the antenna type and its gain should be so chosen that, the equivalent isotropically radiated power (e.i.r.p.) is not more than that necessary for successful communication.

Conformément à la réglementation d'Innovation, la science et le développement économique Canada, le présent émetteur radio peut fonctionner avec une antenne d'un type et d'un gain maximal (ou inférieur) approuvé pour l'émetteur par Industrie Canada. Dans le but de réduire les risques de brouillage radioélectrique à l'intention des autres utilisateurs, il faut choisir le type d'antenne et son gain de sorte que la puissance isotrope rayonnée équivalente (p.i.r.e.) ne dépasse pas l'intensité nécessaire à l'établissement d'une communication satisfaisante.

Any Changes or modifications not expressly approved by the party responsible for compliance could void the user's authority to operate the equipment.

Tous les changements ou modifications non expressément approuvés par le responsable de la conformité pourraient vider l'utilisateur est habilité à exploiter l'équipement.

## 7. Troubleshooting

Q: The terminal cannot be started.

A: The device might be under low energy status or the program may be damaged.  
Please make sure the power is enough and then restart your device. If it still fails, please contact our customer service department for help.

Q: Printer cannot work.

A: This may be caused by abnormal power supply or incorrect paper installation.  
Check the battery status or the terminal power connection. If the remaining battery power is insufficient for a complete printing operation, the printer will not print the paper.  
Check the printer roller and if the paper dust cover is correctly installed.  
If the problem still exists, please contact our customer service center.

---

Q: Transaction Processing Failure

A: Following reasons are likely to cause transaction failure: damaged magnetic card or smart card SAM card, damaged card reader, improper operation of card swiping, damaged or unconnected, unconnected phone line, etc.

- Try to use more than one magnetic card to test the transaction, to confirm the failure is not caused by magnetic card.
- Make sure card swiping is operated correctly.
- Manually process the transaction instead of card reader. If manual transaction works, the failure may be caused by magnetic card reader.
- Use more than one smart card to test the transaction, to confirm the failure is not caused by smart card. Make sure the SAM card is correctly inserted into the card slot.
- Check if the SIM card is installed correctly and local wireless communication network functions or nor.

If there is still problem, please contact our customer service center.

This Document is Copyright © 2015 by Fujian LANDI Commercial Equipment Co., Ltd. Fujian LANDI retains full copyright ownership, rights and protection in all material contained in this document. The recipient can receive this document on the condition that he will keep the document confidential and will not use its contents in any form or by any means, except as agreed beforehand, without the prior written permission of Fujian LANDI. Moreover, nobody is authorized to place this document at the disposal of any third party without the prior written permission of Fujian LANDI. If such permission is granted, it will be subject to the condition that the recipient ensures that any other recipient of this document, or information contained therein, is held responsible to Fujian LANDI for the confidentiality of that information.

Care has been taken to ensure that the content of this document is as accurate as possible. Fujian Landi however declines any responsibility for inaccurate, incomplete or outdated information. The contents of this document may change from time to time without prior notice, and do not create, specify, modify or replace any new or prior contractual obligations agreed upon in writing between Fujian LANDI and the user.

Fujian LANDI is not responsible for any use of this device, which would be non-consistent with the present document.

All trademarks used in this document remain the property of their rightful owners.

**Fujian LANDI Commercial Equipment Co., Ltd**

Add: Building 17, Section A, Software Park,  
No.89 Software Road, Gulou District, Fuzhou Municipality,  
Fujian Province, P.R.China  
Tel: +86-591-88077077  
Fax: +86-591-88077085  
ZIP: 350003  
<http://www.landicorp.com>

YS01000285