



Model: E850 Wireless POS

User Guide



Fujian LANDI
Commercial Equipment Co.,Ltd

This document is the property of LANDI.

Its content cannot be reproduced or divulged without the company's written approval.

Catalog

<i>Disclaimer</i>	3
<i>Environment Friendly Notice</i>	3
<i>Security Information</i>	3
<i>Standard Compliance</i>	5
<i>Acronym Definitions</i>	6
1 PRODUCT INTRODUCTION	6
1.1 <i>Unpacking Inspection</i>	6
1.2 <i>Appearance and Interface</i>	7
1.2.1 <i>Appearance</i>	7
1.2.2 <i>Interfaces</i>	8
2 PRODUCT TECHNICAL CHARACTERISTICS	9
2.1 <i>Product Technical Parameters</i>	9
2.2 <i>Product Function and Configuration</i>	10
2.3 <i>External Port</i>	10
3 PRODUCT INSTALLATION GUIDE	10
3.1 <i>SAM Card Installation</i>	10
3.2 <i>SIM Card Installation</i>	11
3.3 <i>MicroSD Card Installation</i>	11
3.4 <i>Battery Installation</i>	12
3.5 <i>Installation of Print Paper</i>	12
4 PRODUCT INSTRUCTIONS	12
4.1 <i>Usage of Keys</i>	12
4.2 <i>Power on/off Operation</i>	13
4.3 <i>Magnetic Card Reader</i>	14
4.4 <i>IC Card</i>	14
4.5 <i>RF Card</i>	15
5 PRODUCT MAINTENANCE GUIDE	15
5.1 <i>Magnetic Card Reader and ICCR Maintenance</i>	15
5.2 <i>Printer Maintenance</i>	15
5.3 <i>Disposable/Rechargeable Li-ion Battery Maintenance</i>	15
5.4 <i>Notes of Wireless Communication</i>	16
6 FAQ	16
7 MATTERS NEED ATTENTION	17
8 TRANSPORTATION AND STORAGE	17
9 CUSTOMER SERVICE CENTER	18
NOTE ABOUT AFTER-SALES SERVICE	18
PRODUCT MAINTENANCE.....	18
CONTACT	18

Disclaimer

- Although every effort has been made to ensure the accuracy and completeness, it is acknowledged that there may be errors or omissions in this manual.
- Fujian LANDI reserves the entire copyright of this manual. Fujian LANDI also reserves the right to modify the software, hardware and/or documents of the product without prior declaration.
- Owing to product updating, certain details in this guide may differ slightly from the actual equipment, please take the actual product as the standard. LANDI is in possession of the rights to change the contents of the guide.
- All or any part of this manual shall not be copied, modified, disclosed, or authorized used in any method without Fujian LANDI's prior written consent. Fujian LANDI reserves the right to claim compensation on all direct or indirect loss incurred by the above illegal action.
- Fujian LANDI shall not be liable for any damages, failures and data loss to device or accessories resulting from improper operation not in accordance with the guidance of this manual.

Environment Friendly Notice

The environmental-friendly use period of this product is 10 years under normal working, storage and transport conditions which are defined in the product technical specifications.

You are suggested to return the device (package included) to Landi when it is end of life.

Component	Toxic & Hazardous Substances or Elements					
	Plumbi (Pb)	Hydrargyrum (Hg)	Cadmium (Cd)	Sexavalent chrome (Cr(VI))	Polybrominated biphenyl (PBB)	Polybrominated diphenylether (PBDE)
Casing	○	○	○	○	○	○
Circuit Board	×	○	○	○	○	○
Accessories	×	○	○	○	○	○
Li-ion Battery	×	○	○	○	○	○

This table is based on the provisions of SJ/T 11364.

○: The average content of the poisonous harmful substance or element in the component is below the limit of GB/T 26572 standard.

×: The average content of the poisonous harmful substance or element in the component is above the limit of GB/T 26572 standard.

p.s.:

1. Most components of the device are made of environmental friendly material. Attention is drawn to the fact that certain components made of toxic & hazardous substances or elements, are subjected to global technology which restricts the realization of substitute for the toxic & hazardous substances or elements.
2. The reference environment data (eg. humidity, temperature etc.) is obtained from the test at the normal working and storage conditions required by the device.

Security Information

Rechargeable Lithium Battery Maintenance

Danger

- Improper operation of battery may lead to explosion and fire. Contact the qualified service person to change the battery if in need.
- Do not disassemble or modify the battery.
- Keep the battery far away from the fire. Do not beat and drop.
- Do not put the battery into a liquid or exposed to rain or snow.
- Do not make battery short circuit.
- Keep the battery out of the reach of children.
- When not using the battery, the battery should be stored at room temperature and should be charged to 40% - 50% once a year to prevent battery from discharging.
- Please recycle or deal with the battery in right manner in accordance with local laws and regulations.

Lithium-ion Button Battery

Danger

- Improper operation of battery may lead to explosion and fire.
- Please recycle or deal with the battery in right manner in accordance with local laws and regulations.

Laser statement

Danger

- When using device containing laser component (eg. barcode scanner), do not disassemble the device cover, for it may result in hazardous laser radiation. Do not look directly into the laser beam nor be directly irradiated, to avoid hurts to eyes or skins.

Plastic Bags Statement

Danger

- Place the plastic bags out of reach of children to avoid danger of suffocation.

- The installation and connection of this product must strictly observe the related instructions on the instruction. The devices should be connected to stable electric socket, whose ground wire should be connected to the ground, and the socket should not be in the same circuit with photocopier or air conditioner which is switched often.
- In no event shall LANDI be liable for any data or revenue loss, or consequential, indirect, punitive, special or incidental damages resulting from any reasons.
- Use only specified power supply, to avoid failure caused by mismatching.
- Stop using the device immediately in case of power wire damaged, and notice related customer service department for help in time.
- It should be prohibited that any liquid is fallen onto, or any conductive substances (eg. pin, tack, wire etc) are precipitated into this electrical device; otherwise short circuit may occur to damage the device.
- Do not press the device or place anything onto the device
- Do not vibrate, shake or forcibly beat the device.
- Never place the device in the environment with high temperature, humidity, dust or electromagnetic field.
- Do not plug any part of the device or external devices in power-on status, which may damage the interior circuit. It should be noticed that the switch of the device must be powered off prior to power dump
- To avoid accidental fire, do not use or store any flammable spay, coatings, paintings etc. at the vicinity of the device.
- Shut off the power immediately under malfunction. Please contact our customer service department timely and do not privately open the product for maintenance without permission.
- Li-ion battery is equipped inside the device, for any battery change, only specified model can be used. Wrong model may cause explosion. Please do contact our after-service department for help in case of battery change. Do not dispose of them in municipal waste site.
- The terminal power must be switched off to avoid lightning strike in thunderstorm weather.
- When POS is being attacked (eg. casing is opened), the sensitive information stored inside the device will be erased immediately. To avoid unexpected trouble, please do not open the casing at random.
- When POS is under attack, device LCD screen will prompt the warning, together with beep. In this case, please contact our customer service department for further help.
- If the terminal is tampered (eg. terminal casing is opened etc.), sensitive information stored in the terminal will be erased. To avoid unnecessary trouble, please do not open the casing.
- If the terminal is tampered, the tamper prompt will appear on terminal screen accompanied with alarming sound, in this case, please contact LANDI customer service.
- Power off the terminal in the airplane in accordance with the provisions of civil aviation.
- Usages notes under inflammable, explosive situations:
Take appropriate measures to prevent from possible explosion while using the device with WCDMA or other wireless configurations under flammable and explosive occasions; or, use the device with corresponding explosion-proof label.
- Usages notes under medical occasions:
Device with WCDMA or other wireless configurations may cause interference to some medical electronic equipment. It is not allowed to use such device in the vicinity of patient with pacemakers.

Instruction Symbols



WARNING

This prompt means improper operation may result in device damage.



NOTE

This prompt stands for the important information that should be paid attention to during operation process.

Standard Compliance

1.1 EC standard compliance marking

EC standard compliance marking certifies that the products stipulated below:
E8XX

- Complies with the basic requirements of European Directive 1995/5/CE, known as the <R&TTE Directive> concerning RF equipment and telecommunications terminals with respect to:
 - Health and safety protection of the user and all other persons
 - EMC protection
- Conforms to the following harmonized standards:
 - IEC/EC 60950-1: Electrical safety of data processing equipment including electrical office equipment. Issue Dec. 2001
 - EN55022: Data processing equipment – Radioelectric disturbance characteristics- Limits and measurement methods. Issue 1998/A1 -2000/A2 -2003
 - EN55024: Data processing equipment – Immunity characteristic –Limits and measurement methods. Issue 1998 + A1-2001 +A2 -2003
- Complies with the following specification:
 - ETSI ES 203201: Harmonized basic attachment requirements for Terminals for connection to analogue interfaces of the Telephone Networks.

1.2 Network compatibility declaration

The product: E850

- is in conformity with the following harmonized standards or technical rules:
 - ETSI ES 203201
 - ETSI TR 103000
 - is designed to interwork with the following European analogue Public Switched Telephone Network (PSTN) networks:
 -country list...
- (For other countries, please contact us)



NOTE

Compliance with other foreign standards is verified by a local type approval on request.

1.3 FCC Statement

FCC standard compliance marking certifies that the product stipulated below:
E850

- conforms to the following harmonized standards :
 - part 15 subpart B of the FCC rules

This class (B) digital apparatus complies with Canadian ICES-003.

Information to users:

Changes or modifications not expressly approved by the party responsible for compliance could void the user's authority to operate the equipment.

NOTE: This equipment has been tested and found to comply with the limits for a Class B digital device, pursuant to part 15 of the FCC Rules. These limits are designed to provide reasonable protection against harmful interference in a residential installation. This equipment generates uses and can radiate radio frequency energy and, if not installed and used in accordance with the instruction, may cause harmful interference to radio communications. However, there is no guarantee that interference will not occur in a particular installation. If this equipment does cause harmful interference to radio or television reception which can be determined by turning the equipment off and on, the user is encouraged to try to correct interference by one or more of the following measures:

- Reorient or relocate the receiving antenna.
- Increase the separation between the equipment and receiver.
- Connect the equipment into an outlet on circuit different from that to which the receiver is connected.
- Consult the dealer or an experienced radio/TV technician for help.

This equipment complies with FCC radiation exposure limits set forth for an uncontrolled environment .This transmitter must not be co-located or operating in conjunction with any other antenna or transmitter. Non-compliance with the above restrictions may result in violation of RF exposure guidelines.

This device complies with Part 15 of the FCC Rules. Operation is subject to the following two conditions: (1) this device may not cause harmful interference, and (2) this device must accept any interference received, including interference that may cause undesired operation.

1.4 Electrical and Electronic Equipment Waste

This product is labeled in accordance with European Directives 2002/96/EC concerning Waste Electrical and Electronic Equipment (WEEE) and 2006/66/EC concerning Batteries and Accumulators. Those provisions are requiring producers and manufacturers to become liable for take-back, treatment and recycling upon end of life of equipment and batteries.

BATTERIES

If your product contains batteries, they must be disposed of at appropriate collection points.

THE PRODUCT

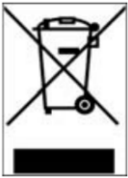

The crossed-out waste bin stuck on the product or its accessories means that the product belongs to the family of electrical and electronic equipment, and waste batteries must not be thrown away but collected separately and recycles.

In this respect, the European regulations ask you to dispose of it selectively:

At sales points in the event of the purchase of similar equipment.

At the collection points made available to you locally (drop-off center, selective collection, etc.)

In this way you can participate in the re-use and upgrading of Electrical and Electronic Equipment Waste, which can have an effect on the environment and human health.

Acronym Definitions

Acronym	Definitions
AC	Alternating Current
BL	Bluetooth
DC	Direct Current
EVDO	Evolution Data Optimized
GPRS	General Packet Radio Service
GPS	Global Positioning System
GSM	Global System for Mobile Communications
IC Card	Integrated Circuit Card
LCD	Liquid Crystal Display
LED	Light Emitting Diode
MicroSD Card	Trans Flash Card
RF Card	Radio Frequency Card
SAM Card	Security Access Module Card
SIM Card	Subscriber Identifying Module Card
USB	Universal Serial Bus
WCDMA	Wideband Code Division Multiple Access
WIFI	Wireless Fidelity

1 Product Introduction

1.1 Unpacking Inspection

Please open the box and check carefully if the terminal and accessories were unpacked or damaged due to transportation. E850 is a device with security characteristic. Any disassembly will probably make it work abnormally.

Open the box:

1. Open and check following items:
 - ✧ Terminal,
 - ✧ External power adapter ,
 - ✧ Battery
 - ✧ Security, warranty and installation guides
2. Open all plastic wrapping of the terminal and other accessories.
3. Tear off the transparent protective film on the LCD screen.
4. Save the shipping carton and packing material for future repacking or terminal movement.





WARNING

E850 is a device with security characteristic. Any disassembly will probably make it work abnormally.

1.2 Appearance and Interface

1.2.1 Appearance



1, LCD display
4, Battery cover

2, Keypad
5, Magnetic card swiping slot

3, IC card slot
6, Printer

1.2.2 Interfaces



1, Battery Compartment
4, MicroSD Card Socket

2, SAM Card Socket
5, Battery Contacts

3, SIM Card socket



1, USB host port and power port

2 Product Technical Characteristics

2.1 Product Technical Parameters

CPU	<ul style="list-style-type: none"> ● ARM Cortex-A9 secure processor
Memory	<ul style="list-style-type: none"> ● FLASH: 256MB ● DRAM: 256MB ● Ext. Memory: MicroSD card, up to 32GB
Display	<ul style="list-style-type: none"> ● 2.8" TFT LCD display with backlight ● 320*240 ● Optional touch screen, ● Support handwritten signature
Keypad	<ul style="list-style-type: none"> ● 21 alphanumeric keys ● Independent power key
MSR Card Reader	<ul style="list-style-type: none"> ● Track 1/2/3, bi-directional reading ● Compatible with ISO-7810 & ISO-7811 & ISO-7813 standards
IC Card Reader	<ul style="list-style-type: none"> ● Compatible with ISO-7810 & ISO-7811 & ISO-7813 standards ● Supports 1.8V, 3V, 5V card
SAM Card Reader	<ul style="list-style-type: none"> ● Support 2 SAM cards
Contactless Card Reader	<ul style="list-style-type: none"> ● Optional built-in contactless card reader; support ISO/IEC 14443 Type A&B, Mifare cards ● Compatible with EMV L1, paypass & paywave standards
Communication	<ul style="list-style-type: none"> ● Optional 3G(WCDMA) wireless communication ● Optional WIFI communication
Acoustic	<ul style="list-style-type: none"> ● Optional acoustic payment
Printer	<ul style="list-style-type: none"> ● Thermal printer, 58mm wide thermal paper ● 40mm- diameter paper roll ● High-speed printer (up to 18 lines/ s)
Word Stock	<ul style="list-style-type: none"> ● Integrated GB18030
Scan	<ul style="list-style-type: none"> ● Optional 1D laser or 1D CCD or 2D barcode reader
Interface	<ul style="list-style-type: none"> ● 1 Micro USB OTG ● Optional phone port
PINPAD	<ul style="list-style-type: none"> ● Integrated PINPAD, supporting multiple master keys and work keys
Encryption and Security	<ul style="list-style-type: none"> ● PCI PTS 4.0 certified; support DES, 3DES, RSA, SHA-1, SHA-256, SHA-512 and AES algorithms ● Support state cryptography algorithm
Multi-application	<ul style="list-style-type: none"> ● Support multi-applications ● Store and run multi-applications in parallel
SDK	<ul style="list-style-type: none"> ● EPT-DEV for WINDOWS; ● Support ANSI C language
Others	<ul style="list-style-type: none"> ● Optional for GPS function ● Optional base port, supporting charging and expandable communication interface
Battery	<ul style="list-style-type: none"> ● Rechargeable li-ion battery, 7.2V/2600mAh
Power Supply	<ul style="list-style-type: none"> ● Power adapter: AC 100V~240V 50~60Hz/0.2A ● Output: 5V/1A
Environmental Characteristics	<ul style="list-style-type: none"> ● Working temperature: -30°C~50°C ● Storage temperature: -20°C~70°C ● Relative humidity: 5%~90%, Non-condensing
Dimension & Weight	<ul style="list-style-type: none"> ● 172mm L × 80mm W × 60mm H ● 375g (incl. battery)

2.2 Product Function and Configuration

E850 is a Point of Sales (POS) product developed based on the 3rd Gen. payment kernel of LANDI. It is configured with ARM Cortex-A9 Core Security Processor to provide powerful processing capabilities and security features; and its 2.8" LCD touch-screen delivers excellent customer experience. SAM/SIM card, contactless card and MSR card read/write as well as various wireless communication modules including 3G, WIFI are all supported. E850 also supports thermal printer, scanning, GPS and terminal extended applications. High-capacity lithium battery which is charged through MicroUSB interface is adopted for E850.

Configuration	Optional Configuration	Function Description
Cards	RF Card	Contactless card reader
Communication	3G WCDMA wireless Communication	Remote wireless communication
	WIFI Communication	Short-distance wireless communication



NOTE

Different products configurations may differ, please contact our marketing department to obtain latest product configuration information.

2.3 External Port

Micro USB port

Micro USB port supports master and slave mode, can also be used as charging port.

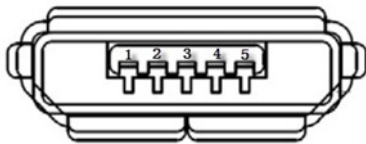

SN	SIGNAL	Function description
1	VBUS	USB Power port, 5.0V
2	D-	Data line, differential signal-
3	D+	Data line, differential signal+
4	ID	ID signal *
5	GND	GND

*ID Signal : If the external cable connector pin corresponding to this signal is grounded, the interface works under Host mode; if the pin is floating, the interface works under Device mode.



WARNING

Please use only the dedicated power adapter for the terminal; otherwise it may cause permanent damage to the terminal or shorten the battery life!

3 Product Installation Guide

3.1 SAM Card Installation

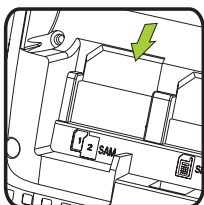

Insert SAM card:

Insert the SAM card gently following arrow direction, until it is completely embedded. The POS terminal is designed with two SAM slots.

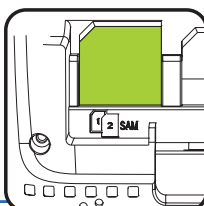

Remove the SAM card:

Press the top of the SAM cards and pull it out slowly.



NOTE

When using only one SAM card, it is recommended to insert SAM1 slot (bottom).

3.2 SIM Card Installation

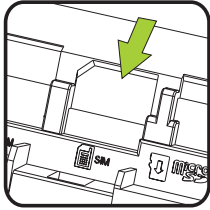

Same procedures as above Chapter 3.1

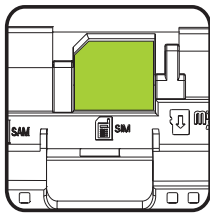



NOTE

The appearance of the sockets of SIM card and SAM is same. Please do pay attention to the SIM card socket position and refer to the installation method as per SAM card.

3.3 MicroSD Card Installation

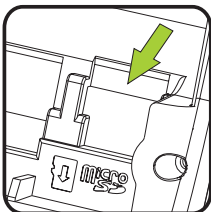

Insert the MicroSD card:

Keep the MicroSD card metal contacts facing down, gently insert it following the arrow direction until the card is completely embedded.

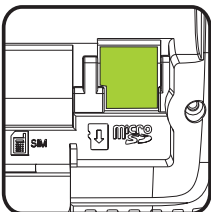

Remove the MicroSD card:

Press the top of the MicroSD card and pull it out slowly.

3.4 Battery Installation

- Open the back cover of device.
- Aim the polarity of the battery to the contact for installation or removal.
- Close the battery cover.

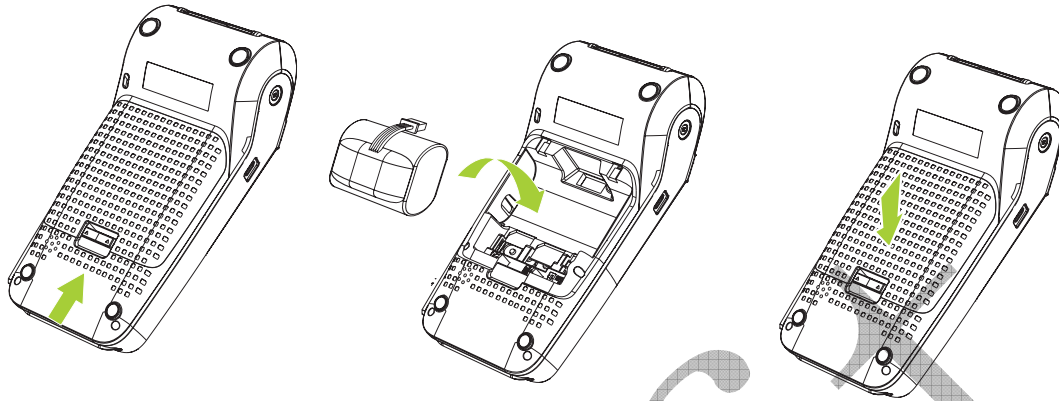



WARNING

E850 POS terminal can only work with battery inside. USB interface input power is used for battery charging only.

3.5 Installation of Print Paper

- Open the printer cover on the top of POS terminal.
- Place the paper roll onto paper box and pull out the paper over the ripper.
- Close the printer cover. Please be noted that the carbon layer side of the printer paper should be faced against the the cover.
- Leave a section of paper out after closing the cover.

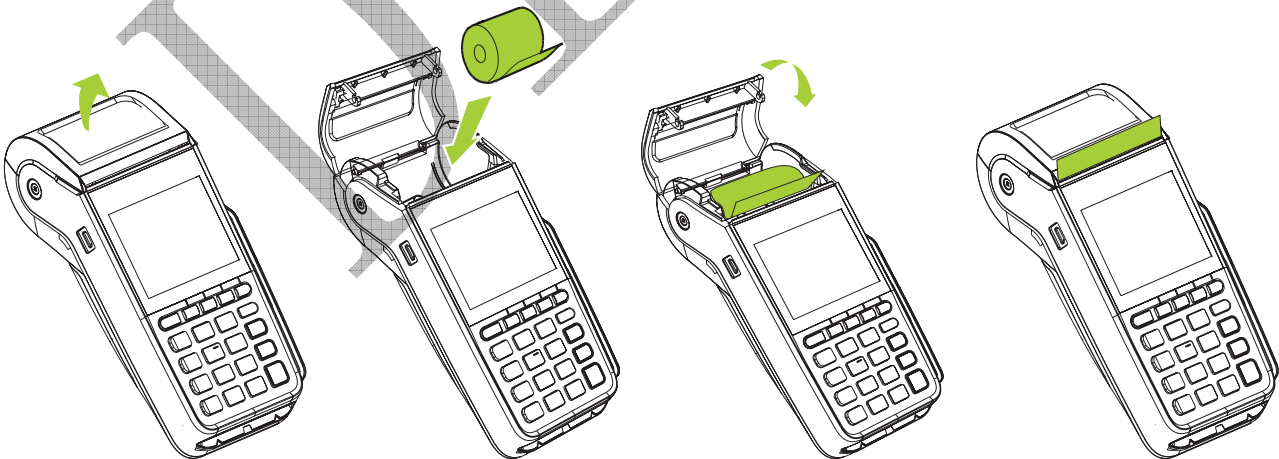

4 Product Instructions

4.1 Usage of Keys

There are 21 keys in total on device keyboard. Key functions described as follows:



F1/◀ : Key reserved for future use/ left arrow key

F2/▲ : Key reserved for future use/ up arrow key

F3/▼ : Key reserved for future use/ down arrow key

F4/▶ : Key reserved for future use/ right arrow key

Menu: Function Key, can be used alone or with other keys, depending on customer needs.

Power: Power button, for switching power or screen display. Details refer to "Switch Operation" instruction.

Cancel: Cancel button. Press this button to cancel the current operation or return to the parent menu.

Clear: Clear button., to delete the latest input.

Enter: Enter button to confirm current operation.

0~9 : Numeric button, to input number from 0 to 9.

Letter: Used for alphanumeric switching.

Character (* #.): Switch character

4.2 Power on/off Operation

Normal power on: Make sure the terminal battery is correctly installed and charged. Press <Power> button for about 1s until the terminal displays the figure below:



Normal power off: Press <Power> button for 2s until the terminal displays the figure below:

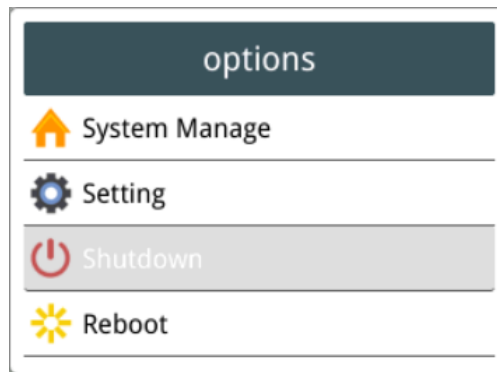

Select "Shutdown" menu using "▲", "▼" arrow keys or "2", "8" and then press <OK> key.

NOTE



Press and hold the power button on the POS terminal under power-on state until "Close POS" menu pops up You can select "Switch Application" to switch between multiple applications or select "Restart" to reset the system under uninterrupted power supply.

Abnormal power off:

When the device works abnormally, for example, it is crashed and no actions menu popped out while pressing the power button, please long-press the power button for 6s, the device will be automatically powered off.

Screen switch operation:

Short-press the power button for about 0.5s, the terminal display will be turned on or off.

4.3 Magnetic Card Reader

The magnetic card can be bi-directionally swiped with the stripe facing inward. Swipe the card at stable and even speed, otherwise it may lead to card reading failure.



4.4 IC Card

The IC card should be horizontally inserted into the card reader with chip side upwards. Make sure the card is completely inside the card reader and prevent the card chip contacts from being damaged or oxidized. Otherwise it may cause transaction failure.

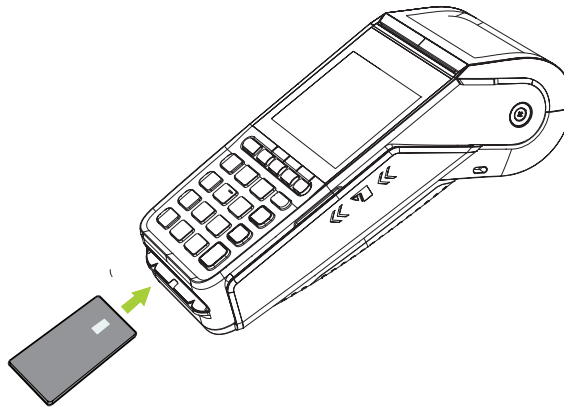

4.5 RF Card

Place the RF card right against the sensing area and remove it until card swiping success prompts. The sensing area of E850 is right above the paper cover.



5 Product Maintenance Guide

5.1 Magnetic Card Reader and ICCR Maintenance

- ◇ Do not attempt to clean the magnetic card reader and IC card reader, for this action may result in damage to the terminal, and that cause warranty invalid.

5.2 Printer Maintenance

- ◇ Do not try to pull up the paper roll under any circumstances.
- ◇ If you need to adjust the typing paper distance, please power off the terminal, and then replace the paper roll with correct operation.
- ◇ Dust or wastepaper remnant in the printer will reduce the efficiency. Please use soft brush to clean it. (Be careful not to scratch the print head).

5.3 Disposable/Rechargeable Li-ion Battery Maintenance

- ◇ The terminal contains disposable li-ion battery to save system information (eg. system time).
- ◇ The terminal is configured with a rechargeable lithium-ion battery for power supply. Do not throw the battery onto the fire or rudely strike the battery when changing the battery, because the above actions may cause battery explosion.
- ◇ Please try to avoid contacting metal object when moving or storing the li-ion battery, or it will cause short circuit or damage to battery or cause fire.
- ◇ Please recycle or deal with the battery in right manner to protect the environment, do not treat it as municipal solid waste.
- ◇ Contact the qualified service person to change the battery when the one-off Li-ion is ineffective.
- ◇ If you want to configure a new li- ion battery, please contact our customer service department for more information.

5.4 Notes of Wireless Communication

1. Usage of WCDMA Functions

The wireless communication feature requires the support from local telecom operators. To use such function, you should obtain the data-enabled SIM/UIM card from local telecom operators. You can then insert this card into E850 card slot; and power the device on to implement corresponding operations. When the LCD display the signal icon, it represents the network is successfully connected. If connection fails, please check:

- ✧ If the device supports WCDMA function;
- ✧ If SIM/UIM card is effective and corresponding data function is opened;
- ✧ If it is within the radio base station network signal coverage;
- ✧ If the power supply is sufficient.

NOTE



WCDMA module supports only 3V SIM cards. Please plug in/out the SIM/UIM card under off state to prevent from damage to the card or terminal.

2. Power of Wireless Communication

The power of RF signal transmission is not fixed, it will be adjusted depending on current network situation, to be radiated with required transmission quality at minimum power.

Following is the maximum transmission power of terminals with various wireless communication standards.

- ✧ In general, transmission power of WCDMA is 0.2W

NOTE



WCDMA module radiation: 50 – 150 μW / CM²;

3. Effects of Wireless Communication Module

There is still no last word about the effects of the WCDMA to human health. But if you are concerned about radiation, please follow the rules as below:

Stay far away from the terminal.

Stay far away from the terminal at the beginning of 1-2s while connected.

Do not dismantle the terminal without permission; otherwise it will cause internal electromagnetic leakage.

4. Electromagnetic Interference

Malfunction may occur to the device under RF energy radiation if there are no electromagnetic protection measures. Please be noted to check if the device in the vicinity has been preventing from electromagnetic.

5. Power off the terminal in the airplane in accordance with the provisions of civil aviation.

6. Usages notes under inflammable, explosive situations

Take appropriate measures to prevent from possible explosion while using the device with wireless communication function under flammable and explosive occasions; or use the device with corresponding explosion-proof label.

7. Usages notes under medical occasions

Device with wireless configurations may cause interference to some medical electronic equipment. It is not allowed to use such device in the vicinity of patient with pacemakers.

8. Usage noted thunderstorm weather

According to some relevant reports, the mobile phone electromagnetic wave is good conductor of lightning. It is much easier to suffer lightning strike when the damp atmosphere form a magnetic conductivity, especially in open areas. Do not use wireless terminals under thunderstorm weather.

6 FAQ

Q: The terminal cannot be started.

A: The device might be under low energy status or the program may be damaged. Please make sure the power is enough and then restart your device. If it still fails, please contact our customer service department for help.

Q: The battery cannot be charged.

A: Please use only the power supply provided by our company. Using wrong type of power supply will probably damage the

battery or lead to malfunction. Make sure the power cable, specified power are well connected with terminal.
If the terminal still cannot work, the battery may be end of life or damaged. Please contact our customer service center.

Q: Printer cannot work.

A: This may be caused by abnormal power supply or incorrect paper installation.

Check the battery status or the terminal power connection. If the remaining battery power is insufficient for a complete printing operation, the printer will not print the paper.

Check the printer roller and if the paper dust cover is correctly installed.

If the problem still exists, please contact our customer service to obtain professional help.

Q: Transaction Processing Failure

A: Following reasons are likely to cause transaction failure: damaged magnetic card or IC card SAM card, damaged card reader, improper operation of card swiping, damaged or unconnected, unconnected phone line, etc.

1, Try to use more than one magnetic card to test the transaction, to confirm the failure is not caused by magnetic card.

2, Make sure card swiping is operated correctly.

3, Manually process the transaction instead of card reader. If manual transaction works, the failure may be caused by magnetic card reader. Please contact our customer service to obtain professional help.

4, If manual transaction fails, please check the phone line and smart card reader.

5, Use more than one smart card to test the transaction, to confirm the failure is not caused by smart card. Make sure the SAM card is correctly inserted into the card slot.

6, Check if the telephone cable is properly connected, and the phone line works or not; or check if the SIM card is installed correctly and local wireless communication network functions or nor. If there is still problem, please contact our customer service to get professional help.

7 Matters Need Attention

- ◇ Please put the POS on a stable surface. Do not put it directly in the sunshine, or in high temperature, moisture or dusty places.
- ◇ Please handle it gently, do not vibrate it.
- ◇ Cut off the power supply before clean, use soft dry cloth to clean it. Cleaning terminals with a clean cloth dipped in one or two drops of neutral detergent to clean, not to use a damp cloth. For difficult to remove the dirt that can be used alcohol or alcoholic washing detergent. Do not use thinner, trichlorethylene or keto solvents, because these chemicals will damage plastic or rubber parts. Cleaning agents must not directly spray or other solution to the keyboard or terminal screen.
- ◇ Do not insert in or pull out the parts when charged, or connectors will damage easily.
- ◇ Do not insert in or pull out IC card in transaction process. .
- ◇ Please cut down the power supply after daily business for energy conservation.
- ◇ Machines should be managed by specific man who is familiar with the operation.
- ◇ Stop operation when there is abnormal phenomenon, stop the power supply and inform the service provider:
 1. Harsh sound in operation.
 2. Pouring water or impurities into machine accidentally.
 3. Bad smell in operation.



WARNING

Terminal is limited to indoor use. Rain or dust resulted in device malfunction is not within the scope of warranty.

8 Transportation and Storage

Adopt general transportation mode, and prevent the goods from sunlight, snow, shower and mechanical impact. Transport the devices with care, do not throw it forcibly. Prevent the packaging from extrusion during transportation, to avoid breakage..

The product should be stored with the original packing box. The warehouse is not allowed to have all sorts of harmful gases, inflammable, explosive, corrosive chemical goods, strong mechanical vibration and strong magnetic field. Packing box should be at least 15cm above the ground, and be away from heat, cold, window or air inlet source at least 50cm.



NOTE

There is transport warning on the package, please comply with the instruction. Otherwise, it may cause damage to terminal.

9 Customer Service Center

Note about After-sales Service

Before asking for customer service, please be noted to back up the data in the terminal. We are not responsible for backing up the data received from our customer service.

Product Maintenance

Please refer to the warranty manual for ways to contact the nearest service point for maintenance and provide a valid proof of purchase invoices. For details, please see the warranty manual.

Contact

Fujian LANDI Commercial Equipment Co., Ltd
Add: No.68 Hongshanyuan Road, Gulou district, Fuzhou.
Mailing Add: Building 23, the 1st Section, Software Garden,
No.89 Software Road, Fuzhou, Fujian, China
Tel: 0591-88077077
Fax: 0591-88077085
ZIP: 350003
Website: <http://www.landicorp.com>

DRAFT