

TEST REPORT

Applicant: Fujian LANDI Commercial Equipment Co.,Ltd.

FCC: Building 17, Section A, Software Park, No. 89 Software Road, Gulou District, Fuzhou Municipality, Fujian Province, China

Address: IC: Building 17, Section A, Software Park, No. 89 Software Road, Gulou District, Fuzhou Municipality, Fujian Province, P.R. 350003 China

Product Name: POS Terminal

FCC ID: 2AG6N-C20SEN

IC: 23725-C20SEN

HVIN: C20SEDN

47 CFR Part 15, Subpart C(15.247)
RSS-247 Issue 3, August 2023

Standard(s): RSS-Gen, Issue 5, February 2021 Amendment 2
ANSI C63.10-2013
KDB 558074 D01 15.247 Meas Guidance v05r02

Report Number: XMDN240206-08079E-RF-00E

Report Date: 2024/4/13

The above device has been tested and found compliant with the requirement of the relative standards by Bay Area Compliance Laboratories Corp. (Dongguan).

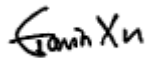

Reviewed By: Gavin Xu
Title: RF Engineer



Approved By: Ivan Cao
Title: EMC Manager

Bay Area Compliance Laboratories Corp. (Dongguan)
No.12, Pulong East 1st Road, Tangxia Town, Dongguan, Guangdong, China

Tel: +86-769-86858888
Fax: +86-769-86858891

www.baclcorp.com.cn

Note: The information marked ▲ is provided by the applicant, the laboratory is not responsible for its authenticity and this information can affect the validity of the result in the test report. Unless otherwise stated the results shown in this test report refer only to the sample(s) tested. This report cannot be reproduced except in full, without prior written approval of the Company. This report is valid only with a valid digital signature. The digital signature may be available only under the Adobe software above version 7.0. This report may contain data that are not covered by the accreditation scope and shall be marked with ★. This report must not be used by the client to claim product certification, approval, or endorsement by NVLAP, NIST, or any agency of the U.S. Government.

CONTENTS

DOCUMENT REVISION HISTORY	4
1. GENERAL INFORMATION	5
1.1 GENERAL DESCRIPTION OF EQUIPMENT UNDER TEST	5
1.2 ACCESSORY INFORMATION	5
1.3 ANTENNA INFORMATION DETAIL▲	5
1.4 EQUIPMENT MODIFICATIONS	5
2. SUMMARY OF TEST RESULTS	6
3. DESCRIPTION OF TEST CONFIGURATION	7
3.1 OPERATION FREQUENCY DETAIL	7
3.2 EUT OPERATION CONDITION	7
3.3 SUPPORT EQUIPMENT LIST AND DETAILS	7
3.4 SUPPORT CABLE LIST AND DETAILS	7
3.5 BLOCK DIAGRAM OF TEST SETUP	8
3.6 TEST FACILITY	9
3.7 MEASUREMENT UNCERTAINTY	9
4. REQUIREMENTS AND TEST PROCEDURES	10
4.1 AC LINE CONDUCTED EMISSIONS	10
4.1.1 Applicable Standard	10
4.1.2 EUT Setup	12
4.1.3 EMI Test Receiver Setup	12
4.1.4 Test Procedure	13
4.1.5 Corrected Amplitude & Margin Calculation	13
4.1.6 Test Result	13
4.2 RADIATED SPURIOUS EMISSIONS	14
4.2.1 Applicable Standard	14
4.2.2 EUT Setup	14
4.2.3 EMI Test Receiver & Spectrum Analyzer Setup	16
4.2.4 Test Procedure	16
4.2.5 Corrected Result & Margin Calculation	16
4.2.6 Test Result	16
4.3 20 DB EMISSION BANDWIDTH	17
4.3.1 Applicable Standard	17
4.3.2 EUT Setup	17
4.3.3 Test Procedure	18
4.3.4 Test Result	18
4.4 99% OCCUPIED BANDWIDTH:	19
4.4.1 Applicable Standard	19
4.4.2 EUT Setup	19
4.4.3 Test Procedure	20
4.4.4 Test Result	20
4.5 CHANNEL SEPARATION	21

4.5.1 Applicable Standard 21

4.5.2 EUT Setup 21

4.5.3 Test Procedure 21

4.5.4 Test Result 21

4.6 NUMBER OF HOPPING FREQUENCY 22

4.6.1 Applicable Standard 22

4.6.2 EUT Setup 22

4.6.3 Test Procedure 22

4.6.4 Test Result 22

4.7 TIME OF OCCUPANCY(DWELL TIME) 23

4.7.1 Applicable Standard 23

4.7.2 EUT Setup 23

4.7.3 Test Procedure 23

4.7.4 Test Result 24

4.8 MAXIMUM CONDUCTED OUTPUT POWER 25

4.8.1 Applicable Standard 25

4.8.2 EUT Setup 25

4.8.3 Test Procedure 25

4.8.4 Test Result 25

4.9 100 KHZ BANDWIDTH OF FREQUENCY BAND EDGE 26

4.9.1 Applicable Standard 26

4.9.2 EUT Setup 26

4.9.3 Test Procedure 26

4.9.4 Test Result 27

4.10 ANTENNA REQUIREMENT 28

4.10.1 Applicable Standard 28

4.10.2 Judgment 28

5. TEST DATA AND RESULTS 29

5.1 AC LINE CONDUCTED EMISSIONS 29

5.2 RADIATED SPURIOUS EMISSIONS 32

5.3 20 DB EMISSION BANDWIDTH: 52

5.4 99% OCCUPIED BANDWIDTH: 55

5.5 CHANNEL SEPARATION: 58

5.6 NUMBER OF HOPPING FREQUENCY: 61

4.7 TIME OF OCCUPANCY(DWELL TIME): 63

5.8 MAXIMUM CONDUCTED OUTPUT POWER: 66

5.9 100 KHZ BANDWIDTH OF FREQUENCY BAND EDGE: 69

APPENDIX A - EUT PHOTOGRAPHS 72

APPENDIX B - TEST SETUP PHOTOGRAPHS 73

APPENDIX C - RF EXPOSURE EVALUATION 74

MAXIMUM PERMISSIBLE EXPOSURE (MPE) 74

Applicable Standard 74

Calculation formula: 74

Calculated Data: 75

EXEMPTION LIMITS FOR ROUTINE EVALUATION-RF EXPOSURE EVALUATION 76

Applicable Standard 76

Calculated Data: 76

DOCUMENT REVISION HISTORY

Revision Number	Report Number	Description of Revision	Date of Revision
1.0	XMDN240206-08079E-RF-00E	Original Report	2024/4/13

1. GENERAL INFORMATION

1.1 General Description of Equipment under Test

EUT Name:	POS Terminal
EUT Model:	C20SE
Operation Frequency:	2402-2480 MHz
Maximum Peak Output Power (Conducted):	8.42dBm
Modulation Type:	GFSK, $\pi/4$ -DQPSK, 8DPSK
Rated Input Voltage:	DC 19V from adapter
Serial Number:	2HP4-1(For RF Conducted Test) 2HP4-4(For AC power line conducted emission and Radiated Spurious Emissions Test)
EUT Received Date:	2024/2/8
EUT Received Status:	Good

1.2 Accessory Information

Accessory Description	Manufacturer	Model	Parameters
Adapter 1#	Unknown	PA-1650-90	Input: AC 100-240V~50/60Hz 1.6A Output: 19V 3.42A

1.3 Antenna Information Detail ▲

Antenna Manufacturer	Antenna Type	input impedance (Ohm)	Frequency Range	Antenna Gain
Shanghai Jersoncom Communication Engineering Co., Ltd	FPC	50	2.4~2.5GHz	5.73 dBi
The design of compliance with §15.203:				
<input checked="" type="checkbox"/> Unit uses a permanently attached antenna.				
<input type="checkbox"/> Unit uses a unique coupling to the intentional radiator.				
<input type="checkbox"/> Unit was professionally installed, and installer shall be responsible for verifying that the correct antenna is employed with the unit.				

1.4 Equipment Modifications

No modifications are made to the EUT during all test items.

2. SUMMARY OF TEST RESULTS

FCC Rules	Description of Test	Result
FCC §15.207(a) RSS-Gen Clause 8.8	AC Line Conducted Emissions	Compliant
FCC §15.205, §15.209, §15.247(d) RSS-Gen Clause 8.10	Radiated Spurious Emissions	Compliant
FCC §15.247(a)(1) RSS-247 Clause 5.1 b)	20 dB Emission Bandwidth	Compliant
RSS-Gen Clause 6.7	99% Occupied Bandwidth	Compliant
FCC §15.247(a)(1) RSS-247 Clause 5.1 b)	Channel Separation	Compliant
FCC §15.247(a)(1)(iii) RSS-247 Clause 5.1 d)	Number Of Hopping Frequency	Compliant
FCC §15.247(a)(1)(iii) RSS-247 Clause 5.1 d)	Time Of Occupancy (dwell time)	Compliant
FCC §15.247(b)(1) RSS-247 Clause 5.4 b)	Maximum Conducted Output Power	Compliant
FCC §15.247(d) RSS-247 Clause 5.5	100 kHz Bandwidth Of Frequency Band Edge	Compliant
FCC §15.203 RSS-Gen Clause 6.8	Antenna Requirement	Compliant
<p>Note 1: For AC line conducted emissions, the maximum output power mode and channel was tested. Note 2: For Radiated Spurious Emissions 9kHz~ 1GHz and 18-25GHz, the maximum output power mode and channel was tested.</p>		

3. DESCRIPTION OF TEST CONFIGURATION

3.1 Operation Frequency Detail

Channel	Frequency (MHz)	Channel	Frequency (MHz)
0	2402	40	2442
1	2403	41	2443
...
...
...	...	78	2480
39	2441	/	/

3.2 EUT Operation Condition

The system was configured for testing in Engineering Mode, which was provided by the manufacturer.

EUT Exercise Software:		CMD		
The software was provided by manufacturer. The maximum power was configured as below, that was provided by the manufacturer▲:				
Test Modes	Power Level Setting			
	Lowest	Middle	Highest	
GFSK	Default	Default	Default	
$\pi/4$ -DQPSK	Default	Default	Default	
8DPSK	Default	Default	Default	

3.3 Support Equipment List and Details

Manufacturer	Description	Model	Serial Number
SanDisk	Micro TF Card	UHS-I-16G	9292DVDSV0XZ
Kingston	USB Flash Disk	32G	EMZBUD21103001
SANDisk	USB Flash Disk	16G	BL201026115 B
SANDisk	USB Flash Disk	16G	BL201026331
D-Link	Router	DGS-1100-08PD	S01Z1H000012
PHILIPS	Keyboard	SPK6234	K234210510743
PHILIPS	Mouse	SPK7214	M214BQ210411115
IPRO	Earphone	Phonenix 5.0s	EMZBEP21103002B
Fujian LANDI Commercial Equipment Co.,Ltd.	Cashbox	Unkown	EZ240214F212

3.4 Support Cable List and Details

Cable Description	Shielding Type	Ferrite Core	Length (m)	From Port	To
DC Cable	No	No	1	Adapter	EUT
RJ45 Cable	No	No	3	Router	EUT
USB Cable	No	No	1.5	Keyboard	EUT
USB Cable	No	No	1.5	Mouse	EUT
Earphone Cable	No	No	1	Earphone	EUT
Cashbox Cable	No	No	1	Cashbox	EUT

3.5 Block Diagram of Test Setup

AC power line conducted emissions:

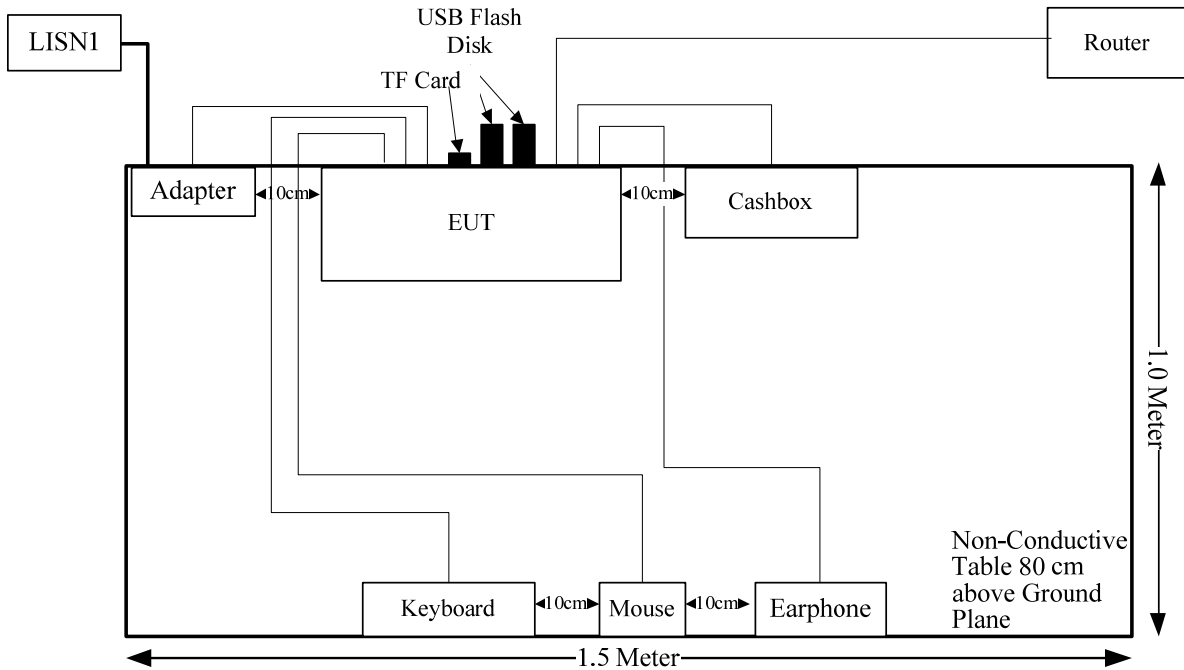

Radiated Spurious Emissions:

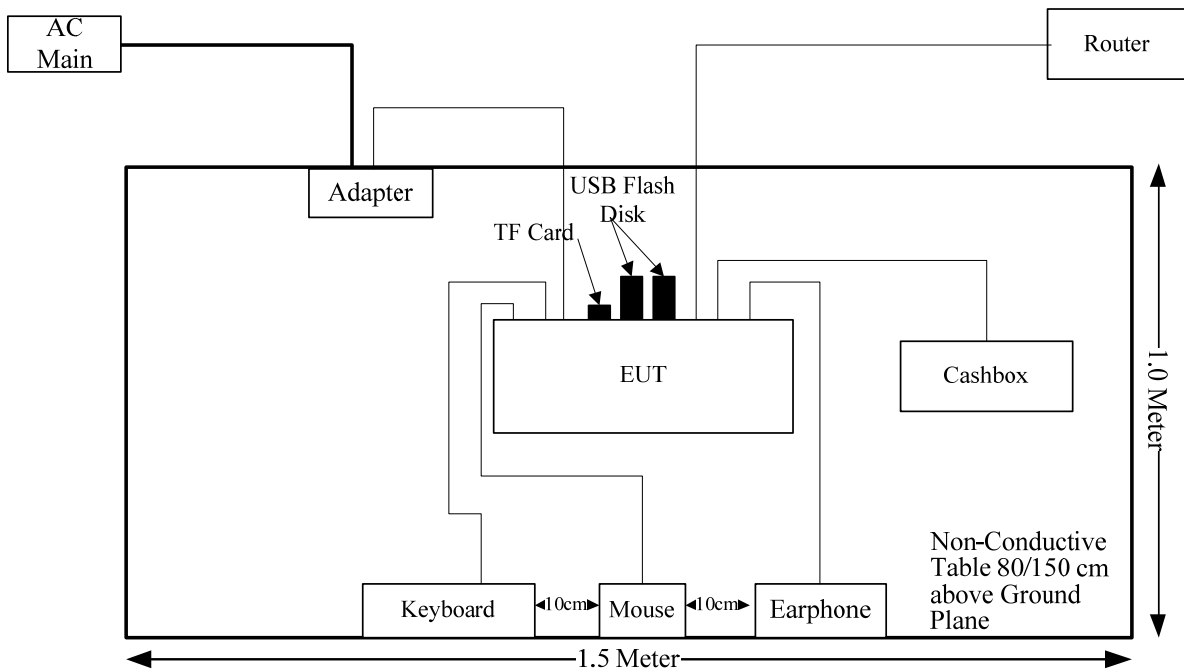

3.6 Test Facility

The Test site used by Bay Area Compliance Laboratories Corp. (Dongguan) to collect test data is located on the No.12, Pulong East 1st Road, Tangxia Town, Dongguan, Guangdong, China.

The lab has been recognized as the FCC accredited lab under the KDB 974614 D01 and is listed in the FCC Public Access Link (PAL) database, FCC Registration No. : 829273, the FCC Designation No. : CN5044.

The lab has been recognized by Innovation, Science and Economic Development Canada to test to Canadian radio equipment requirements, the CAB identifier: CN0022.

3.7 Measurement Uncertainty

Otherwise required by the applicant or Product Regulations, Decision Rule in this report did not consider the uncertainty. The extended uncertainty given in this report is obtained by combining the standard uncertainty times the coverage factor K with the 95% confidence interval.

Parameter	Measurement Uncertainty
Occupied Channel Bandwidth	±5 %
RF output power, conducted	±0.61dB
Power Spectral Density, conducted	±0.61 dB
Unwanted Emissions, radiated	9kHz~30MHz: 3.3dB, 30MHz~200MHz: 4.55 dB, 200MHz~1GHz: 5.92 dB, 1GHz~6GHz: 4.98 dB, 6GHz~18GHz: 5.89 dB, 18GHz~26.5GHz:5.47 dB, 26.5GHz~40GHz:5.63 dB
Unwanted Emissions, conducted	±2.47 dB
Temperature	±1°C
Humidity	±5%
DC and low frequency voltages	±0.4%
Duty Cycle	1%
AC Power Lines Conducted Emission	3.11 dB (150 kHz to 30 MHz)

4. REQUIREMENTS AND TEST PROCEDURES

4.1 AC Line Conducted Emissions

4.1.1 Applicable Standard

FCC§15.207(a).

(a) Except as shown in paragraphs (b) and (c) of this section, for an intentional radiator that is designed to be connected to the public utility (AC) power line, the radio frequency voltage that is conducted back onto the AC power line on any frequency or frequencies, within the band 150 kHz to 30 MHz, shall not exceed the limits in the following table, as measured using a 50 μ H/50 ohms line impedance stabilization network (LISN). Compliance with the provisions of this paragraph shall be based on the measurement of the radio frequency voltage between each power line and ground at the power terminal. The lower limit applies at the boundary between the frequency ranges.

Frequency of emission (MHz)	Conducted limit (dB μ V)	
	Quasi-peak	Average
0.15-0.5	66 to 56*	56 to 46*
0.5-5	56	46
5-30	60	50

*Decreases with the logarithm of the frequency.

(b) The limit shown in paragraph (a) of this section shall not apply to carrier current systems operating as intentional radiators on frequencies below 30 MHz. In lieu thereof, these carrier current systems shall be subject to the following standards:

(1) For carrier current system containing their fundamental emission within the frequency band 535-1705 kHz and intended to be received using a standard AM broadcast receiver: no limit on conducted emissions.

(2) For all other carrier current systems: 1000 μ V within the frequency band 535-1705 kHz, as measured using a 50 μ H/50 ohms LISN.

(3) Carrier current systems operating below 30 MHz are also subject to the radiated emission limits in §15.205, §15.209, §15.221, §15.223, or §15.227, as appropriate.

(c) Measurements to demonstrate compliance with the conducted limits are not required for devices which only employ battery power for operation and which do not operate from the AC power lines or contain provisions for operation while connected to the AC power lines. Devices that include, or make provisions for, the use of battery chargers which permit operating while charging, AC adapters or battery eliminators or that connect to the AC power lines indirectly, obtaining their power through another device which is connected to the AC power lines, shall be tested to demonstrate compliance with the conducted limits.

RSS-Gen Clause 8.8

Unless stated otherwise in the applicable RSS, for radio apparatus that are designed to be connected to the public utility AC power network, the radio frequency voltage that is conducted back onto the AC power line on any frequency or frequencies within the range 150 kHz to 30 MHz shall not exceed the limits in table 4, as measured using a 50 μ H / 50 Ω line impedance stabilization network. This requirement applies for the radio frequency voltage measured between each power line and the ground terminal of each AC power-line mains cable of the EUT. For an EUT that connects to the AC power lines indirectly, through another device, the requirement for compliance with the limits in table 4 shall apply at the terminals of the AC power-line mains cable of a representative support device, while it provides power to the EUT. The lower limit applies at the boundary between the frequency ranges. The device used to power the EUT shall be representative of typical applications.

Table 4 – AC power-line conducted emissions limits

Frequency (MHz)	Conducted limit (dB μ V)	
	Quasi-peak	Average
0.15 - 0.5	66 to 56 ¹	56 to 46 ¹
0.5 – 5	56	46
5 – 30	60	50

Note 1: The level decreases linearly with the logarithm of the frequency.

For an EUT with a permanent or detachable antenna operating between 150 kHz and 30 MHz, the AC power-line conducted emissions must be measured using the following configurations:

- (a) Perform the AC power-line conducted emissions test with the antenna connected to determine compliance with the limits of table 4 outside the transmitter's fundamental emission band.
- (b) Retest with a dummy load instead of the antenna to determine compliance with the limits of table 4 within the transmitter's fundamental emission band. For a detachable antenna, remove the antenna and connect a suitable dummy load to the antenna connector. For a permanent antenna, remove the antenna and terminate the RF output with a dummy load or network that simulates the antenna in the fundamental frequency band.

4.1.2 EUT Setup

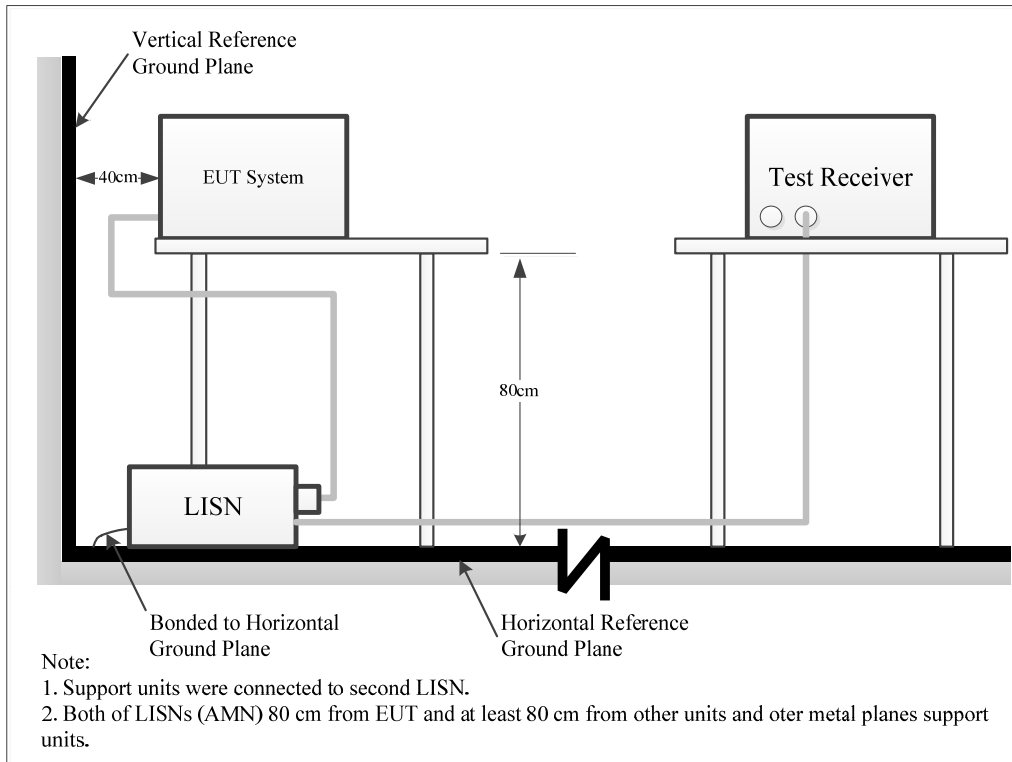

The setup of EUT is according with per ANSI C63.10-2013 measurement procedure. The specification used was with the FCC Part 15.207, RSS-Gen limits.

The spacing between the peripherals was 10 cm.

The adapter or EUT was connected to the main LISN with a 120 V/60 Hz AC power source.

4.1.3 EMI Test Receiver Setup

The EMI test receiver was set to investigate the spectrum from 150 kHz to 30 MHz.

During the conducted emission test, the EMI test receiver was set with the following configurations:

Frequency Range	IF B/W
150 kHz – 30 MHz	9 kHz

4.1.4 Test Procedure

The frequency and amplitude of the six highest ac power-line conducted emissions relative to the limit, measured over all the current-carrying conductors of the EUT power cords, and the operating frequency or frequency to which the EUT is tuned (if appropriate), should be reported, unless such emissions are more than 20 dB below the limit. AC power-line conducted emissions measurements are to be separately carried out only on each of the phase (“hot”) line(s) and (if used) on the neutral line(s), but not on the ground [protective earth] line(s). If less than six emission frequencies are within 20 dB of the limit, then the noise level of the measuring instrument at representative frequencies should be reported. The specific conductor of the power-line cord for each of the reported emissions should be identified. Measure the six highest emissions with respect to the limit on each current-carrying conductor of each power cord associated with the EUT (but not the power cords of associated or peripheral equipment that are part of the test configuration). Then, report the six highest emissions with respect to the limit from among all the measurements identifying the frequency and specific current-carrying conductor identified with the emission. The six highest emissions should be reported for each of the current-carrying conductors, or the six highest emissions may be reported over all the current-carrying conductors.

4.1.5 Corrected Amplitude & Margin Calculation

The basic equation is as follows:

Result = Reading + Factor

Factor = attenuation caused by cable loss + voltage division factor of AMN

The “**Margin**” column of the following data tables indicates the degree of compliance within the applicable limit. The equation for margin calculation is as follows:

Margin = Limit – Result

4.1.6 Test Result

Please refer to section 5.1.

4.2 Radiated Spurious Emissions

4.2.1 Applicable Standard

FCC §15.247 (d);

In any 100 kHz bandwidth outside the frequency band in which the spread spectrum or digitally modulated intentional radiator is operating, the radio frequency power that is produced by the intentional radiator shall be at least 20 dB below that in the 100 kHz bandwidth within the band that contains the highest level of the desired power, based on either an RF conducted or a radiated measurement, provided the transmitter demonstrates compliance with the peak conducted power limits. If the transmitter complies with the conducted power limits based on the use of RMS averaging over a time interval, as permitted under paragraph (b)(3) of this section, the attenuation required under this paragraph shall be 30 dB instead of 20 dB. Attenuation below the general limits specified in §15.209(a) is not required. In addition, radiated emissions which fall in the restricted bands, as defined in §15.205(a), must also comply with the radiated emission limits specified in §15.209(a) (see §15.205(c)).

RSS-247 Clause 5.5

In any 100 kHz bandwidth outside the frequency band in which the spread spectrum or digitally modulated device is operating, the RF power that is produced shall be at least 20 dB below that in the 100 kHz bandwidth within the band that contains the highest level of the desired power, based on either an RF conducted or a radiated measurement, provided that the transmitter demonstrates compliance with the peak conducted power limits. If the transmitter complies with the conducted power limits based on the use of root-mean-square averaging over a time interval, as permitted under section 5.4(d), the attenuation required shall be 30 dB instead of 20 dB. Attenuation below the general field strength limits specified in RSS-Gen is not required

4.2.2 EUT Setup

9kHz~30MHz:

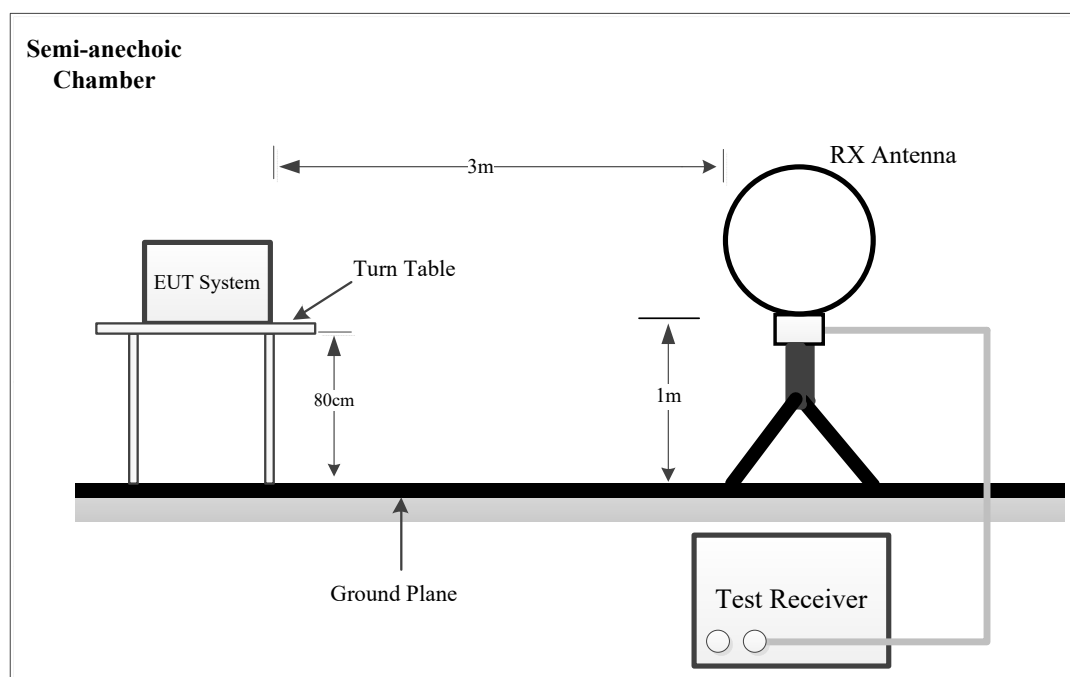

30MHz~1GHz:

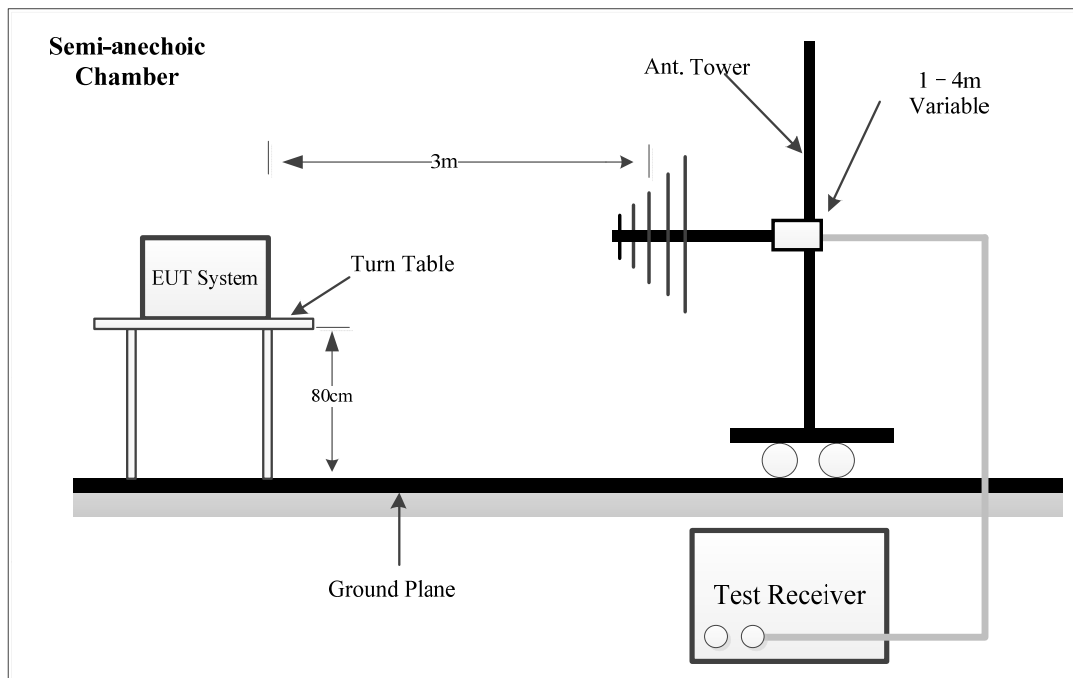

Above 1GHz:

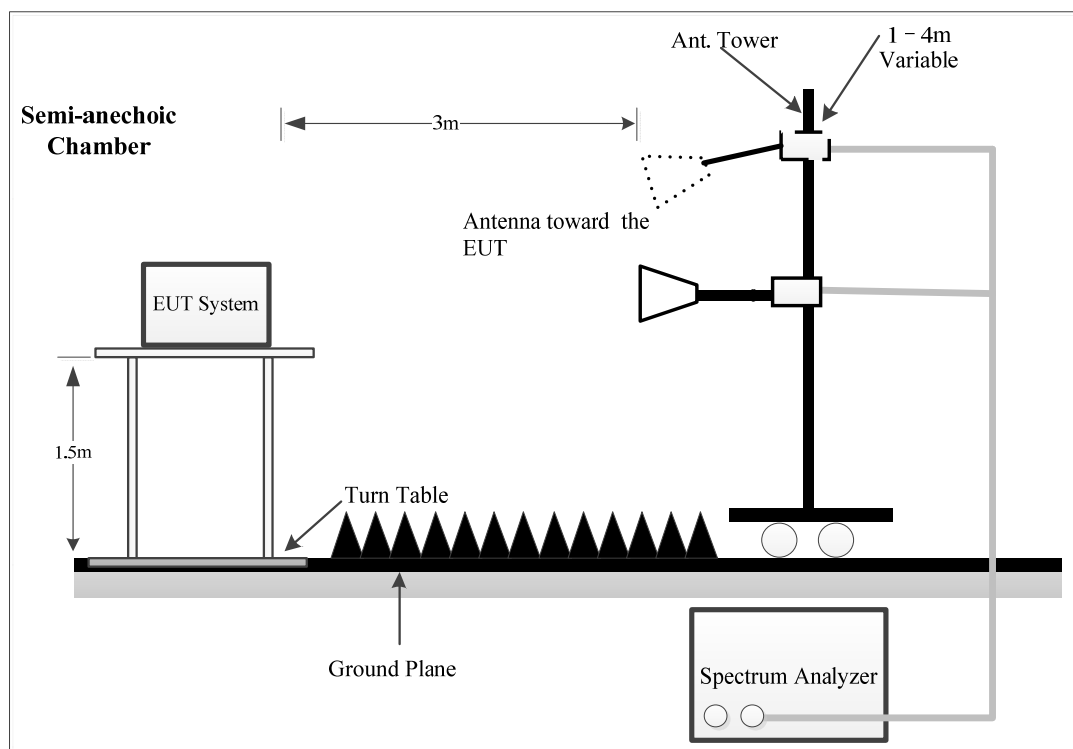

The radiated emissions were performed in the 3 meters distance, using the setup accordance with the ANSI C63.10-2013. The specification used was the FCC 15.209, FCC 15.247 limits & RSS-247, RSS-Gen limits.

The external I/O cables were draped along the test table and formed a bundle 30 to 40 cm long in the middle.

The spacing between the peripherals was 10 cm.

For 9kHz-30MHz test, the lowest height of the magnetic antenna shall be 1 m above the ground and three antenna orientations (parallel, perpendicular, and ground-parallel) shall be measured.

4.2.3 EMI Test Receiver & Spectrum Analyzer Setup

During the radiated emission test, the EMI test receiver & Spectrum Analyzer Setup were set with the following configurations:

Frequency Range	RBW	Video B/W	IF B/W	Measurement
9 kHz – 150 kHz	300 Hz	1 kHz	200 Hz	QP/AV
150 kHz – 30 MHz	9 kHz	30 kHz	9 kHz	QP/AV
30 MHz – 1000 MHz	100 kHz	300 kHz	/	PK
	/	/	120 kHz	QP
Above 1 GHz	1MHz	3 MHz	/	PK
	1MHz	10 Hz	/	AV

If the maximized peak measured value complies with under the QP limit more than 6dB, then it is unnecessary to perform an QP measurement.

If the maximized peak measured value complies with under the Average limit, then it is unnecessary to perform an Average measurement.

4.2.4 Test Procedure

Maximizing procedure was performed on the highest emissions to ensure that the EUT complied with all installation combinations.

Data was recorded in Quasi-peak detection mode for frequency range of 9 kHz-1 GHz except 9-90 kHz, 110-490 kHz, employing an average detector, peak and Average detection modes for frequencies above 1 GHz.

All emissions under the average limit and under the noise floor have not recorded in the report.

4.2.5 Corrected Result & Margin Calculation

The basic equation is as follows:

Result = Reading + Factor

Factor = Antenna Factor + Cable Loss- Amplifier Gain

The “**Margin**” column of the following data tables indicates the degree of compliance within the applicable limit. The equation for margin calculation is as follows:

Margin = Limit – Result

4.2.6 Test Result

Please refer to section 5.2.

4.3 20 dB Emission Bandwidth

4.3.1 Applicable Standard

FCC §15.247 (a)(1)

Frequency hopping systems shall have hopping channel carrier frequencies separated by a minimum of 25 kHz or the 20 dB bandwidth of the hopping channel, whichever is greater. Alternatively, frequency hopping systems operating in the 2400-2483.5 MHz band may have hopping channel carrier frequencies that are separated by 25 kHz or two-thirds of the 20 dB bandwidth of the hopping channel, whichever is greater, provided the systems operate with an output power no greater than 125 mW. The system shall hop to channel frequencies that are selected at the system hopping rate from a pseudo randomly ordered list of hopping frequencies. Each frequency must be used equally on the average by each transmitter. The system receivers shall have input bandwidths that match the hopping channel bandwidths of their corresponding transmitters and shall shift frequencies in synchronization with the transmitted signals.

RSS-247 Clause 5.1 b)

Frequency hopping systems shall have hopping channel carrier frequencies separated by a minimum of 25 kHz or the 20 dB bandwidth of the hopping channel, whichever is greater. Alternatively, frequency hopping systems operating in the 2400-2483.5 MHz band may have hopping channel carrier frequencies that are separated by 25 kHz or two-thirds of the 20 dB bandwidth of the hopping channel, whichever is greater, provided the systems operate with an output power no greater than 125 mW.

4.3.2 EUT Setup

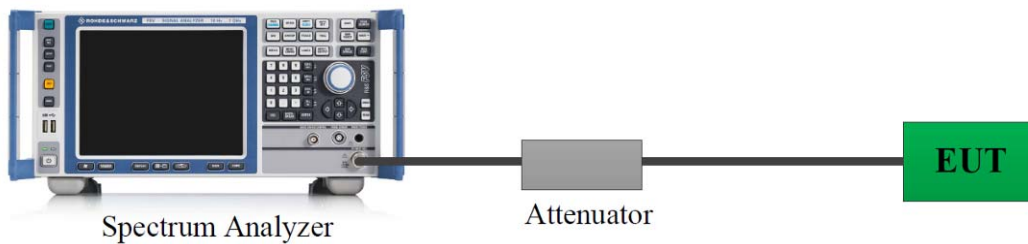

A short RF cable with low cable loss connected to the EUT antenna port, which was provided by manufacturer.

4.3.3 Test Procedure

According to ANSI C63.10-2013 Section 6.9.2

- a) The spectrum analyzer center frequency is set to the nominal EUT channel center frequency. The span range for the EMI receiver or spectrum analyzer shall be between two times and five times the OBW.
- b) The nominal IF filter bandwidth (3 dB RBW) shall be in the range of 1% to 5% of the OBW and video bandwidth (VBW) shall be approximately three times RBW, unless otherwise specified by the applicable requirement.
- c) Set the reference level of the instrument as required, keeping the signal from exceeding the maximum input mixer level for linear operation. In general, the peak of the spectral envelope shall be more than $[10 \log (\text{OBW}/\text{RBW})]$ below the reference level. Specific guidance is given in 4.1.5.2
- d) Steps a) through c) might require iteration to adjust within the specified tolerances.
- e) The dynamic range of the instrument at the selected RBW shall be more than 10 dB below the target “-xx dB down” requirement; that is, if the requirement calls for measuring the -20 dB OBW, the instrument noise floor at the selected RBW shall be at least 30 dB below the reference value.
- f) Set detection mode to peak and trace mode to max hold.
- g) Determine the reference value: Set the EUT to transmit an unmodulated carrier or modulated signal, as applicable. Allow the trace to stabilize. Set the spectrum analyzer marker to the highest level of the displayed trace (this is the reference value).
- h) Determine the “-xx dB down amplitude” using $[(\text{reference value}) - \text{xx}]$. Alternatively, this calculation may be made by using the marker-delta function of the instrument.
- i) If the reference value is determined by an unmodulated carrier, then turn the EUT modulation ON, and either clear the existing trace or start a new trace on the spectrum analyzer and allow the new trace to stabilize. Otherwise, the trace from step g) shall be used for step j).
- j) Place two markers, one at the lowest frequency and the other at the highest frequency of the envelope of the spectral display, such that each marker is at or slightly below the “-xx dB down amplitude” determined in step h). If a marker is below this “-xx dB down amplitude” value, then it shall be as close as possible to this value. The occupied bandwidth is the frequency difference between the two markers. Alternatively, set a marker at the lowest frequency of the envelope of the spectral display, such that the marker is at or slightly below the “-xx dB down amplitude” determined in step h). Reset the marker-delta function and move the marker to the other side of the emission until the delta marker amplitude is at the same level as the reference marker amplitude. The marker-delta frequency reading at this point is the specified emission bandwidth.
- k) The occupied bandwidth shall be reported by providing plot(s) of the measuring instrument display; the plot axes and the scale units per division shall be clearly labeled. Tabular data may be reported in addition to the plot(s).

4.3.4 Test Result

Please refer to section 5.3.

4.4 99% Occupied Bandwidth:

4.4.1 Applicable Standard

RSS-Gen Clause 6.7

The occupied bandwidth or the “99% emission bandwidth” is defined as the frequency range between two points, one above and the other below the carrier frequency, within which 99% of the total transmitted power of the fundamental transmitted emission is contained. The occupied bandwidth shall be reported for all equipment in addition to the specified bandwidth required in the applicable RSSs. In some cases, the “x dB bandwidth” is required, which is defined as the frequency range between two points, one at the lowest frequency below and one at the highest frequency above the carrier frequency, at which the maximum power level of the transmitted emission is attenuated x dB below the maximum in-band power level of the modulated signal, where the two points are on the outskirts of the in-band emission.

The following conditions shall be observed for measuring the occupied bandwidth and x dB bandwidth: The transmitter shall be operated at its maximum carrier power measured under normal test conditions. The span of the spectrum analyzer shall be set large enough to capture all products of the modulation process, including the emission skirts, around the carrier frequency, but small enough to avoid having other emissions (e.g. on adjacent channels) within the span.

The detector of the spectrum analyzer shall be set to “Sample”. However, a peak, or peak hold, may be used in place of the sampling detector since this usually produces a wider bandwidth than the actual bandwidth (worst-case measurement). Use of a peak hold (or “Max Hold”) may be necessary to determine the occupied / x dB bandwidth if the device is not transmitting continuously.

The resolution bandwidth (RBW) shall be in the range of 1% to 5% of the actual occupied / x dB bandwidth and the video bandwidth (VBW) shall not be smaller than three times the RBW value. Video averaging is not permitted.

Note: It may be necessary to repeat the measurement a few times until the RBW and VBW are in compliance with the above requirement.

For the 99% emission bandwidth, the trace data points are recovered and directly summed in linear power level terms. The recovered amplitude data points, beginning at the lowest frequency, are placed in a running sum until 0.5% of the total is reached, and that frequency recorded. The process is repeated for the highest frequency data points (starting at the highest frequency, at the right side of the span, and going down in frequency). This frequency is then recorded. The difference between the two recorded frequencies is the occupied bandwidth (or the 99% emission bandwidth).

4.4.2 EUT Setup

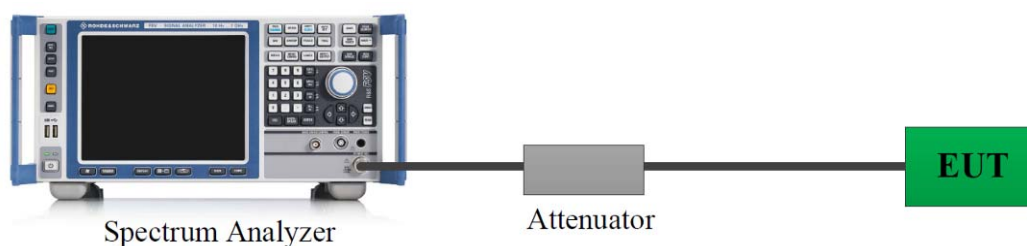

A short RF cable with low cable loss connected to the EUT antenna port, which was provided by manufacturer.

4.4.3 Test Procedure

According to ANSI C63.10-2013 Section 6.9.3

The occupied bandwidth is the frequency bandwidth such that, below its lower and above its upper frequency limits, the mean powers are each equal to 0.5% of the total mean power of the given emission. The following procedure shall be used for measuring 99% power bandwidth:

- a) The instrument center frequency is set to the nominal EUT channel center frequency. The frequency span for the spectrum analyzer shall be between 1.5 times and 5.0 times the OBW.
- b) The nominal IF filter bandwidth (3 dB RBW) shall be in the range of 1% to 5% of the OBW, and VBW shall be approximately three times the RBW, unless otherwise specified by the applicable requirement.
- c) Set the reference level of the instrument as required, keeping the signal from exceeding the maximum input mixer level for linear operation. In general, the peak of the spectral envelope shall be more than $[10 \log (OBW/RBW)]$ below the reference level. Specific guidance is given in 4.1.5.2.
- d) Step a) through step c) might require iteration to adjust within the specified range.
- e) Video averaging is not permitted. Where practical, a sample detection and single sweep mode shall be used. Otherwise, peak detection and max hold mode (until the trace stabilizes) shall be used.
- f) Use the 99% power bandwidth function of the instrument (if available) and report the measured bandwidth.
- g) If the instrument does not have a 99% power bandwidth function, then the trace data points are recovered and directly summed in linear power terms. The recovered amplitude data points, beginning at the lowest frequency, are placed in a running sum until 0.5% of the total is reached; that frequency is recorded as the lower frequency. The process is repeated until 99.5% of the total is reached; that frequency is recorded as the upper frequency. The 99% power bandwidth is the difference between these two frequencies.
- h) The occupied bandwidth shall be reported by providing plot(s) of the measuring instrument display; the plot axes and the scale units per division shall be clearly labeled. Tabular data may be reported in addition to the plot(s).

4.4.4 Test Result

Please refer to section 5.4.

4.5 Channel Separation

4.5.1 Applicable Standard

FCC §15.247 (a)(1)

Frequency hopping systems shall have hopping channel carrier frequencies separated by a minimum of 25 kHz or the 20 dB bandwidth of the hopping channel, whichever is greater. Alternatively, frequency hopping systems operating in the 2400-2483.5 MHz band may have hopping channel carrier frequencies that are separated by 25 kHz or two-thirds of the 20 dB bandwidth of the hopping channel, whichever is greater, provided the systems operate with an output power no greater than 125 mW. The system shall hop to channel frequencies that are selected at the system hopping rate from a pseudo randomly ordered list of hopping frequencies. Each frequency must be used equally on the average by each transmitter. The system receivers shall have input bandwidths that match the hopping channel bandwidths of their corresponding transmitters and shall shift frequencies in synchronization with the transmitted signals.

RSS-247 Clause 5.1 b)

Frequency hopping systems shall have hopping channel carrier frequencies separated by a minimum of 25 kHz or the 20dB bandwidth of the hopping channel, whichever is greater. Alternatively, frequency hopping systems operating in the 2400-2483.50 MHz band may have hopping channel carrier frequencies that are separated by 25 kHz or two-thirds of the 20dB bandwidth of the hopping channel, whichever is greater provided the systems operate with an output power no greater than 125 mW.

4.5.2 EUT Setup

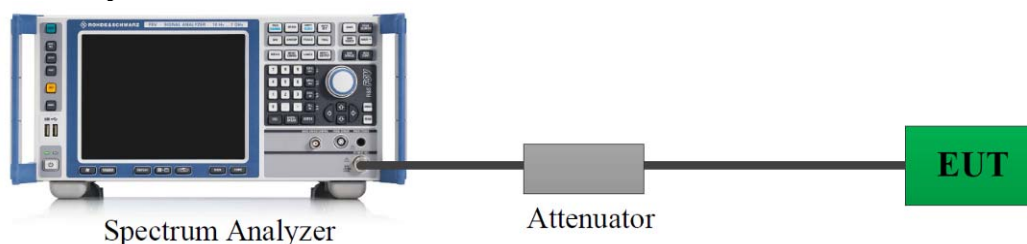

A short RF cable with low cable loss connected to the EUT antenna port, which was provided by manufacturer.

4.5.3 Test Procedure

According to ANSI C63.10-2013 Section 7.8.2

The EUT shall have its hopping function enabled. Use the following spectrum analyzer settings:

- Span: Wide enough to capture the peaks of two adjacent channels.
- RBW: Start with the RBW set to approximately 30% of the channel spacing; adjust as necessary to best identify the center of each individual channel.
- Video (or average) bandwidth (VBW) \geq RBW.
- Sweep: Auto.
- Detector function: Peak.
- Trace: Max hold.
- Allow the trace to stabilize.

Use the marker-delta function to determine the separation between the peaks of the adjacent channels. Compliance of an EUT with the appropriate regulatory limit shall be determined. A plot of the data shall be included in the test report.

4.5.4 Test Result

Please refer to section 5.5.

4.6 Number Of Hopping Frequency

4.6.1 Applicable Standard

FCC §15.247 (a)(1)(iii)

Frequency hopping systems in the 2400–2483.5 MHz band shall use at least 15 channels. The average time of occupancy on any channel shall not be greater than 0.4 seconds within a period of 0.4 seconds multiplied by the number of hopping channels employed. Frequency hopping systems may avoid or suppress transmissions on a particular hopping frequency provided that a minimum of 15 channels are used.

RSS-247 Clause 5.1 d)

Frequency hopping systems in the 2400–2483.5 MHz band shall use at least 15 channels. The average time of occupancy on any channel shall not be greater than 0.4 seconds within a period of 0.4 seconds multiplied by the number of hopping channels employed. Frequency hopping systems may avoid or suppress transmissions on a particular hopping frequency provided that a minimum of 15 channels are used.

4.6.2 EUT Setup

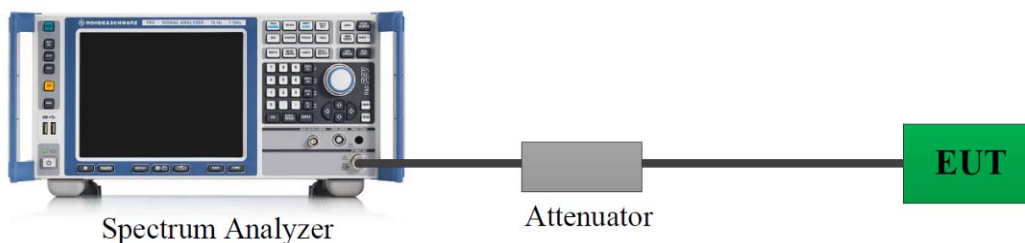

A short RF cable with low cable loss connected to the EUT antenna port, which was provided by manufacturer.

4.6.3 Test Procedure

According to ANSI C63.10-2013 Section 7.8.3

The EUT shall have its hopping function enabled. Use the following spectrum analyzer settings:

- a) Span: The frequency band of operation. Depending on the number of channels the device supports, it may be necessary to divide the frequency range of operation across multiple spans, to allow the individual channels to be clearly seen.
- b) RBW: To identify clearly the individual channels, set the RBW to less than 30% of the channel spacing or the 20 dB bandwidth, whichever is smaller.
- c) VBW \geq RBW.
- d) Sweep: Auto.
- e) Detector function: Peak.
- f) Trace: Max hold.
- g) Allow the trace to stabilize

It might prove necessary to break the span up into subranges to show clearly all of the hopping frequencies. Compliance of an EUT with the appropriate regulatory limit shall be determined for the number of hopping channels. A plot of the data shall be included in the test report.

4.6.4 Test Result

Please refer to section 5.6.

4.7 Time Of Occupancy(Dwell Time)

4.7.1 Applicable Standard

Frequency hopping systems in the 2400-2483.5 MHz shall use at least 15 channels. The average time of occupancy on any channel shall not be greater than 0.4 seconds within a period of 0.4 seconds multiplied by the number of hopping channels employed. Frequency hopping systems may avoid or suppress transmissions on a particular hopping frequency provided that a minimum of 15 channels are used.

RSS-247 Clause 5.1 d)

Frequency hopping systems in the 2400–2483.5 MHz band shall use at least 15 channels. The average time of occupancy on any channel shall not be greater than 0.4 seconds within a period of 0.4 seconds multiplied by the number of hopping channels employed. Frequency hopping systems may avoid or suppress transmissions on a particular hopping frequency provided that a minimum of 15 channels are used.

4.7.2 EUT Setup

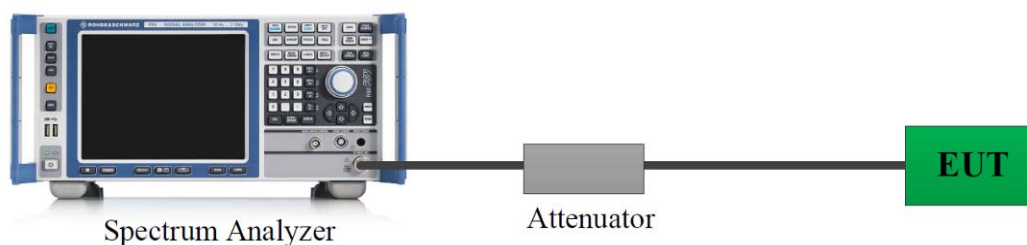

A short RF cable with low cable loss connected to the EUT antenna port, which was provided by manufacturer.

4.7.3 Test Procedure

According to ANSI C63.10-2013 Section 7.8.4

The EUT shall have its hopping function enabled. Use the following spectrum analyzer settings:

- Span: Zero span, centered on a hopping channel.
- RBW shall be \leq channel spacing and where possible RBW should be set $\gg 1 / T$, where T is the expected dwell time per channel.
- Sweep: As necessary to capture the entire dwell time per hopping channel; where possible use a video trigger and trigger delay so that the transmitted signal starts a little to the right of the start of the plot. The trigger level might need slight adjustment to prevent triggering when the system hops on an adjacent channel; a second plot might be needed with a longer sweep time to show two successive hops on a channel.
- Detector function: Peak.
- Trace: Max hold.

Use the marker-delta function to determine the transmit time per hop. If this value varies with different modes of operation (data rate, modulation format, number of hopping channels, etc.), then repeat this test for each variation in transmit time.

Repeat the measurement using a longer sweep time to determine the number of hops over the period specified in the requirements. The sweep time shall be equal to, or less than, the period specified in the requirements. Determine the number of hops over the sweep time and calculate the total number of hops in the period specified in the requirements, using the following equation:

$$\text{(Number of hops in the period specified in the requirements)} = \text{(number of hops on spectrum analyzer)} \times \text{(period specified in the requirements / analyzer sweep time)}$$

The average time of occupancy is calculated from the transmit time per hop multiplied by the number of hops in the period specified in the requirements. If the number of hops in a specific time varies with different modes of operation (data rate, modulation format, number of hopping channels, etc.), then repeat this test for each variation.

The measured transmit time and time between hops shall be consistent with the values described in the operational description for the EUT.

4.7.4 Test Result

Please refer to section 5.7.

4.8 Maximum Conducted Output Power

4.8.1 Applicable Standard

FCC §15.247 (b)(1)

For frequency hopping systems operating in the 2400–2483.5 MHz band employing at least 75 non-overlapping hopping channels, and all frequency hopping systems in the 5725–5850 MHz band: 1 watt. For all other frequency hopping systems in the 2400–2483.5 MHz band: 0.125 watts

According to RSS-247 Clause 5.4 b)

For FHSs operating in the band 2400–2483.5 MHz, the maximum peak conducted output power shall not exceed 1.0 W if the hopset uses 75 or more hopping channels; the maximum peak conducted output power shall not exceed 0.125 W if the hopset uses less than 75 hopping channels. The e.i.r.p. shall not exceed 4 W, except as provided in section 5.4(e).

4.8.2 EUT Setup

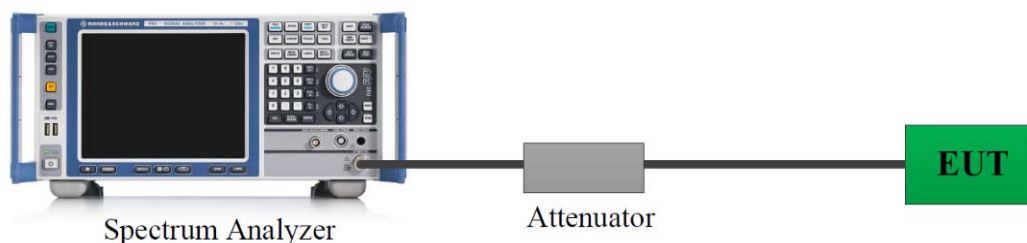

A short RF cable with low cable loss connected to the EUT antenna port, which was provided by manufacturer. The cable loss of this RF cable was offset into the setting of test equipment, which was provided by manufacturer ▲.

4.8.3 Test Procedure

According to ANSI C63.10-2013 Section 7.8.5

This is an RF-conducted test to evaluate maximum peak output power. Use a direct connection between the antenna port of the unlicensed wireless device and the spectrum analyzer, through suitable attenuation, Offset the Insertion loss of the RF cable, DC Block/ Attenuator into the spectrum analyzer. The hopping shall be disabled for this test:

- a) Use the following spectrum analyzer settings:
 - 1) Span: Approximately five times the 20 dB bandwidth, centered on a hopping channel.
 - 2) RBW > 20 dB bandwidth of the emission being measured.
 - 3) VBW \geq RBW.
 - 4) Sweep: Auto.
 - 5) Detector function: Peak.
 - 6) Trace: Max hold.
 - b) Allow trace to stabilize.
 - c) Use the marker-to-peak function to set the marker to the peak of the emission.
 - d) The indicated level is the peak output power, after any corrections for external attenuators and cables.
 - e) A plot of the test results and setup description shall be included in the test report.
- NOTE—A peak responding power meter may be used, where the power meter and sensor system video bandwidth is greater than the occupied bandwidth of the unlicensed wireless device, rather than a spectrum analyzer.

4.8.4 Test Result

Please refer to section 5.8.

4.9 100 kHz Bandwidth Of Frequency Band Edge

4.9.1 Applicable Standard

FCC §15.247 (d);

In any 100 kHz bandwidth outside the frequency band in which the spread spectrum or digitally modulated intentional radiator is operating, the radio frequency power that is produced by the intentional radiator shall be at least 20 dB below that in the 100 kHz bandwidth within the band that contains the highest level of the desired power, based on either an RF conducted or a radiated measurement, provided the transmitter demonstrates compliance with the peak conducted power limits. If the transmitter complies with the conducted power limits based on the use of RMS averaging over a time interval, as permitted under paragraph (b)(3) of this section, the attenuation required under this paragraph shall be 30 dB instead of 20 dB. Attenuation below the general limits specified in §15.209(a) is not required. In addition, radiated emissions which fall in the restricted bands, as defined in §15.205(a), must also comply with the radiated emission limits specified in §15.209(a) (see §15.205(c)).

According to RSS-247 Clause 5.5

In any 100 kHz bandwidth outside the frequency band in which the spread spectrum or digitally modulated device is operating, the RF power that is produced shall be at least 20 dB below that in the 100 kHz bandwidth within the band that contains the highest level of the desired power, based on either an RF conducted or a radiated measurement, provided that the transmitter demonstrates compliance with the peak conducted power limits. If the transmitter complies with the conducted power limits based on the use of root-mean-square averaging over a time interval, as permitted under section 5.4(d), the attenuation required shall be 30 dB instead of 20 dB. Attenuation below the general field strength limits specified in RSS-Gen is not required.

4.9.2 EUT Setup

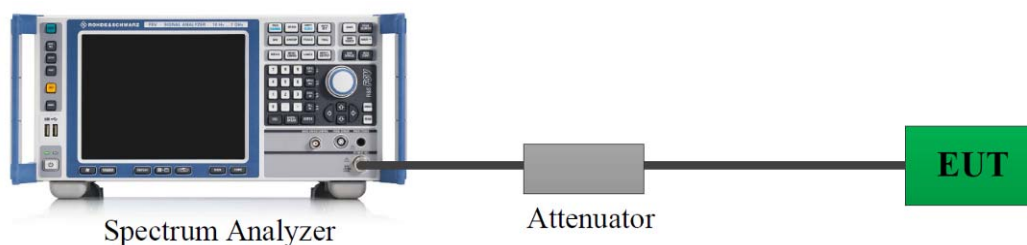

A short RF cable with low cable loss connected to the EUT antenna port, which was provided by manufacturer.

4.9.3 Test Procedure

According to ANSI C63.10-2013 Section 7.8.6

For band-edge measurements, use the band-edge procedure in 6.10. Band-edge measurements shall be tested both on single channels, and with the EUT hopping.

- a) Set the center frequency and span to encompass frequency range to be measured.
- b) Set the RBW = 100 kHz.
- c) Set the VBW $\geq [3 \times \text{RBW}]$.
- d) Detector = peak.
- e) Sweep time = auto couple.
- f) Trace mode = max hold.
- g) Allow trace to fully stabilize.

h) Use the peak marker function to determine the maximum amplitude level. Ensure that the amplitude of all unwanted emissions outside of the authorized frequency band (excluding restricted frequency bands) is attenuated by at least the minimum requirements. Report the three highest emissions relative to the limit.

4.9.4 Test Result

Please refer to section 5.9.

4.10 Antenna Requirement

4.10.1 Applicable Standard

FCC §15.203

An intentional radiator shall be designed to ensure that no antenna other than that furnished by the responsible party shall be used with the device. The use of a permanently attached antenna or of an antenna that uses a unique coupling to the intentional radiator shall be considered sufficient to comply with the provisions of this section. The manufacturer may design the unit so that a broken antenna can be replaced by the user, but the use of a standard antenna jack or electrical connector is prohibited. This requirement does not apply to carrier current devices or to devices operated under the provisions of §§15.211, 15.213, 15.217, 15.219, 15.221, or §15.236. Further, this requirement does not apply to intentional radiators that must be professionally installed, such as perimeter protection systems and some field disturbance sensors, or to other intentional radiators which, in accordance with §15.31(d), must be measured at the installation site. However, the installer shall be responsible for ensuring that the proper antenna is employed so that the limits in this part are not exceeded.

RSS-Gen §6.8

The applicant for equipment certification shall provide a list of all antenna types that may be used with the transmitter, where applicable (i.e. for transmitters with detachable antenna), indicating the maximum permissible antenna gain (in dBi) and the required impedance for each antenna. The test report shall demonstrate the compliance of the transmitter with the limit for maximum equivalent isotropically radiated power (e.i.r.p.) specified in the applicable RSS, when the transmitter is equipped with any antenna type, selected from this list.

For expediting the testing, measurements may be performed using only the antenna with highest gain of each combination of transmitter and antenna type, with the transmitter output power set at the maximum level. However, the transmitter shall comply with the applicable requirements under all operational conditions and when in combination with any type of antenna from the list provided in the test report (and in the notice to be included in the user manual, provided below).

When measurements at the antenna port are used to determine the RF output power, the effective gain of the device's antenna shall be stated, based on a measurement or on data from the antenna's manufacturer.

The test report shall state the RF power, output power setting and spurious emission measurements with each antenna type that is used with the transmitter being tested.

For licence-exempt equipment with detachable antennas, the user manual shall also contain the following notice in a conspicuous location:

This radio transmitter [enter the device's ISED certification number] has been approved by Innovation, Science and Economic Development Canada to operate with the antenna types listed below, with the maximum permissible gain indicated. Antenna types not included in this list that have a gain greater than the maximum gain indicated for any type listed are strictly prohibited for use with this device.

Immediately following the above notice, the manufacturer shall provide a list of all antenna types which can be used with the transmitter, indicating the maximum permissible antenna gain (in dBi) and the required impedance for each antenna type.

4.10.2 Judgment

Compliant. Please refer to the Antenna Information detail in Section 1.3.

5. TEST DATA AND RESULTS

5.1 AC Line Conducted Emissions

Serial Number:	2HP4-4	Test Date:	2024/2/26
Test Site:	CE	Test Mode:	Transmitting
Tester:	Lane Sun	Test Result:	Pass

Environmental Conditions:

Temperature: (°C)	19	Relative Humidity: (%)	46	ATM Pressure: (kPa)	101.7
----------------------	----	------------------------------	----	------------------------	-------

Test Equipment List and Details:

Manufacturer	Description	Model	Serial Number	Calibration Date	Calibration Due Date
R&S	LISN	ENV216	101614	2023/10/18	2024/10/17
MICRO-COAX	Coaxial Cable	C-NJNJ-50	C-0200-01	2023/9/5	2024/9/4
R&S	EMI Test Receiver	ESCI	100035	2023/8/18	2024/8/17
R&S	Test Software	EMC32	V9.10.00	N/A	N/A

* Statement of Traceability: Bay Area Compliance Laboratories Corp. (Dongguan) attests that all calibrations have been performed, traceable to National Primary Standards and International System of Units (SI).

Project No: XMDN240206-08079E-RF
 Test Engineer: Lane Sun
 Test Date: 2024-2-26
 Port: L
 Test Mode: Transmitting
 Power Source: AC 120V/60Hz
 Note: GFSK Low Channel

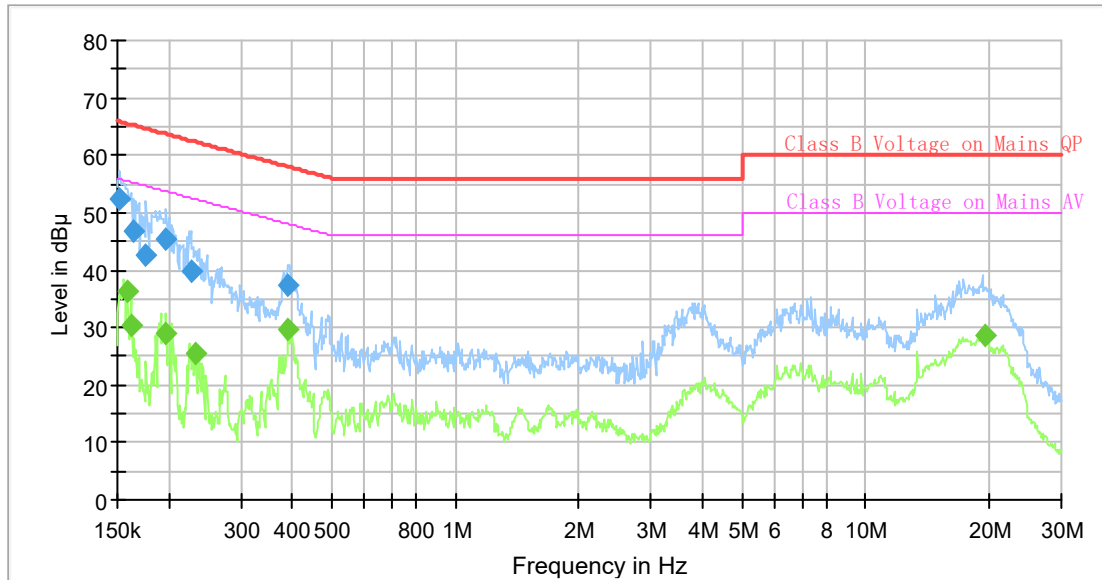

Final Result

Frequency (MHz)	QuasiPeak (dB μV)	Average (dB μV)	Limit (dB μV)	Margin (dB)	Bandwidth (kHz)	Line	Corr. (dB)
0.152261	52.41	---	65.88	13.47	9.000	L1	10.8
0.158459	---	36.47	55.54	19.07	9.000	L1	10.8
0.161652	---	30.37	55.38	25.01	9.000	L1	10.8
0.164089	46.89	---	65.25	18.36	9.000	L1	10.8
0.175956	42.46	---	64.67	22.21	9.000	L1	10.8
0.197344	---	29.09	53.72	24.63	9.000	L1	10.8
0.197344	45.31	---	63.72	18.41	9.000	L1	10.8
0.226921	39.75	---	62.56	22.81	9.000	L1	10.8
0.231493	---	25.57	52.40	26.83	9.000	L1	10.8
0.390819	37.36	---	58.05	20.69	9.000	L1	10.8
0.390819	---	29.52	48.05	18.53	9.000	L1	10.8
19.603499	---	28.53	50.00	21.47	9.000	L1	10.9

Project No: XMDN240206-08079E-RF
 Test Engineer: Lane Sun
 Test Date: 2024-2-26
 Port: N
 Test Mode: Transmitting
 Power Source: AC 120V/60Hz
 Note: GFSK Low Channel

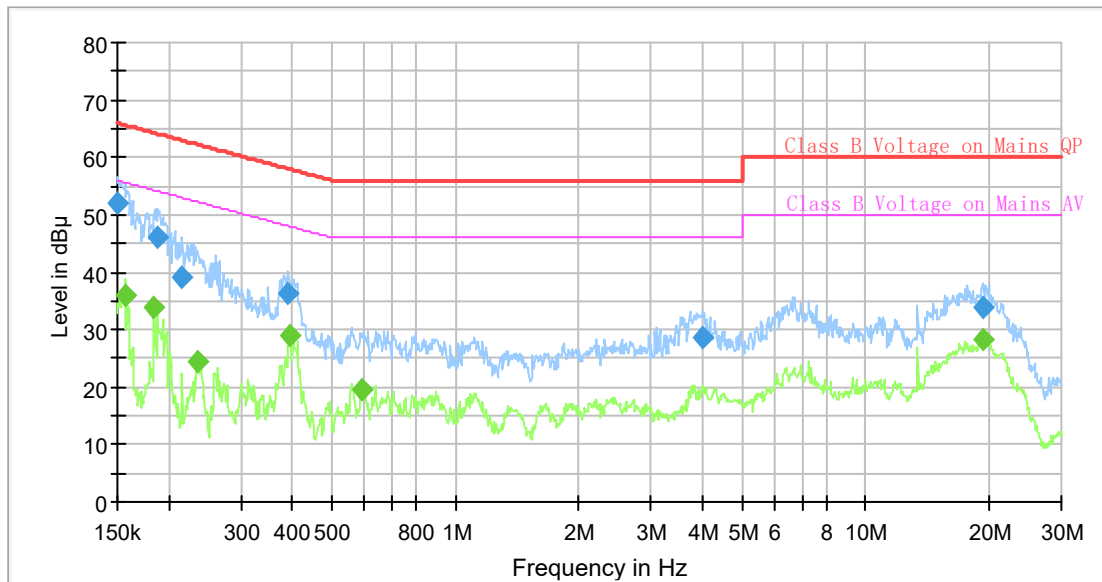

Final Result

Frequency (MHz)	QuasiPeak (dB μV)	Average (dB μV)	Limit (dB μV)	Margin (dB)	Bandwidth (kHz)	Line	Corr. (dB)
0.150750	51.97	---	65.96	13.99	9.000	N	10.9
0.156887	---	36.09	55.63	19.54	9.000	N	10.9
0.184035	---	33.97	54.30	20.33	9.000	N	10.9
0.187743	45.96	---	64.14	18.18	9.000	N	10.9
0.215881	39.11	---	62.98	23.87	9.000	N	10.8
0.236158	---	24.40	52.23	27.83	9.000	N	10.8
0.390819	36.18	---	58.05	21.87	9.000	N	10.8
0.396710	---	28.91	47.92	19.01	9.000	N	10.8
0.594189	---	19.64	46.00	26.36	9.000	N	10.7
4.013525	28.55	---	56.00	27.45	9.000	N	10.9
19.312363	33.88	---	60.00	26.12	9.000	N	10.9
19.408925	---	28.39	50.00	21.61	9.000	N	10.9

5.2 Radiated Spurious Emissions

Serial Number:	2HP4-4	Test Date:	Below 1GHz: 2024/4/9~2024/4/23 Above 1GHz: 2024/3/8
Test Site:	Chamber 10m, Chamber B	Test Mode:	Transmitting
Tester:	Zoo Zou, Bill Yang	Test Result:	Pass

Environmental Conditions:			
Temperature: (°C)	21.2~24.2	Relative Humidity: (%)	60
		ATM Pressure: (kPa)	100.4~100.8

Test Equipment List and Details:

Manufacturer	Description	Model	Serial Number	Calibration Date	Calibration Due Date
9kHz~1000MHz					
EMCO	Passive Loop Antenna	6512	9706-1206	2023/10/21	2026/10/20
Sunol Sciences	Hybrid Antenna	JB3	A060611-1	2023/9/6	2026/9/5
Narda	Coaxial Attenuator	779-6dB	04269	2023/9/6	2026/9/5
Unknown	Coaxial Cable	C-NJNJ-50	C-1000-01	2023/8/1	2024/7/31
Unknown	Coaxial Cable	C-NJNJ-50	C-0400-04	2023/8/1	2024/7/31
Unknown	Coaxial Cable	C-NJNJ-50	C-0530-01	2023/8/1	2024/7/31
Sonoma	Amplifier	310N	185914	2023/8/1	2024/7/31
R&S	EMI Test Receiver	ESCI	101121	2023/10/18	2024/10/17
Farad	Test Software	EZ-EMC	V1.1.4.2	N/A	N/A
Above 1GHz					
ETS-Lindgren	Horn Antenna	3115	000 527 35	2023/9/7	2024/9/6
Ducommun Technologies	Horn Antenna	ARH-4223-02	1007726-02 1304	2023/2/22	2026/2/21
Xinhang Macrowave	Coaxial Cable	XH750A-N/J-SMA/J-10M	20231117004 #0001	2023/11/17	2024/11/16
Xinhang Macrowave	Coaxial Cable	XH360A-2.92/J-2.92/J-6M-A	20231208001 #0001	2023/12/11	2024/12/10
AH	Preamplifier	PAM-0118P	469	2023/8/19	2024/8/18
AH	Preamplifier	PAM-1840VH	191	2023/9/7	2024/9/6
R&S	Spectrum Analyzer	FSV40	101944	2023/10/18	2024/10/17
Audix	Test Software	E3	191218 (V9)	N/A	N/A
E-Microwave	Band Rejection Filter	OBSF-2400-2483.5-S	OE01601525	2023/6/16	2024/6/15
Micro-tronics	High Pass Filter	HPM50111	G217	2023/12/1	2024/11/30

* Statement of Traceability: Bay Area Compliance Laboratories Corp. (Dongguan) attests that all calibrations have been performed, traceable to National Primary Standards and International System of Units (SI).

Test Data:

Please refer to the below table and plots.

1) 9kHz~30MHz

GFSK Low Channel was tested. The amplitude of spurious emissions attenuated more than 20 dB below the permissible value is not required to be report.

2) 30MHz-1GHz

Project No: XMDN240206-08079E-RF
 Test Engineer: Zoo Zou
 Test Date: 2024-4-9
 Polarization: Horizontal
 Test Mode: Transmitting
 Power Source: AC 120V/60Hz
 Note: GFSK Low Channel

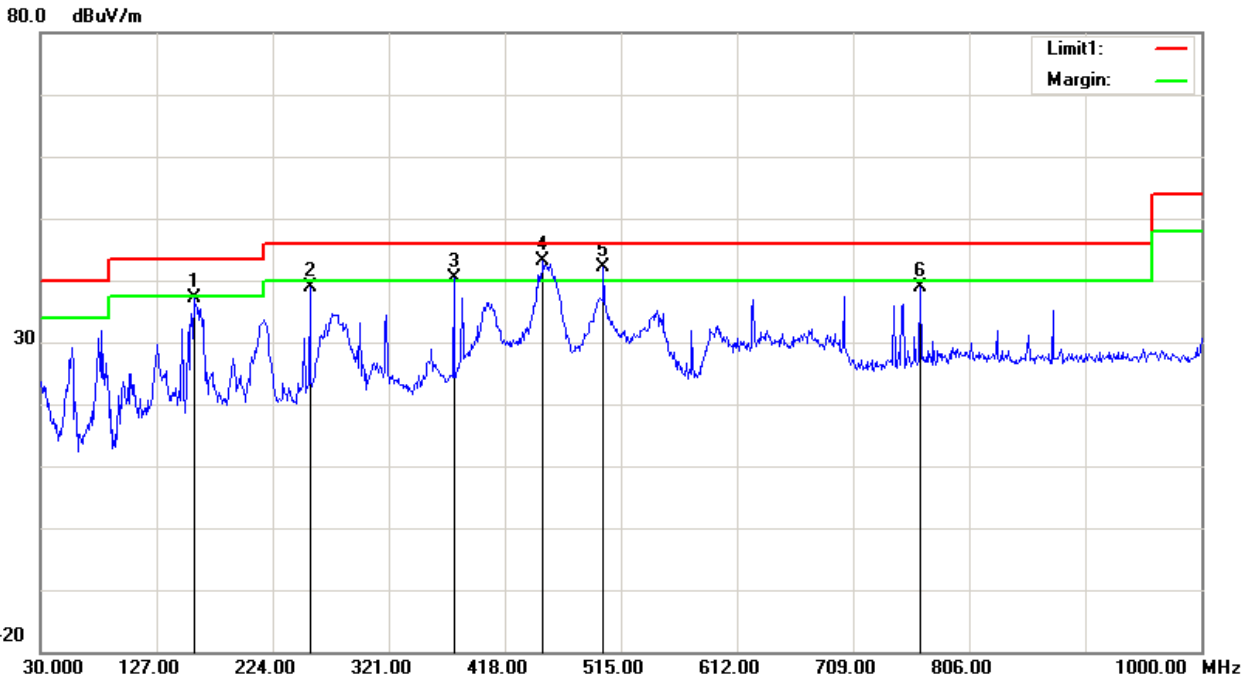

No.	Frequency (MHz)	Reading (dBuV)	Detector	Factor (dB/m)	Result (dBuV/m)	Limit (dBuV/m)	Margin (dB)
1	158.0400	48.21	peak	-11.19	37.02	43.50	6.48
2	255.0400	50.30	peak	-11.37	38.93	46.00	7.07
3	375.3200	48.29	QP	-7.89	40.40	46.00	5.60
4	450.0100	48.67	QP	-5.47	43.20	46.00	2.80
5	500.4500	46.48	QP	-4.28	42.20	46.00	3.80
6	765.2600	38.89	peak	-0.12	38.77	46.00	7.23

Project No: XMDN240206-08079E-RF
 Test Engineer: Zoo Zou
 Test Date: 2024-4-9
 Polarization: Vertical
 Test Mode: Transmitting
 Power Source: AC 120V/60Hz
 Note: GFSK Low Channel

80.0 dBuV/m

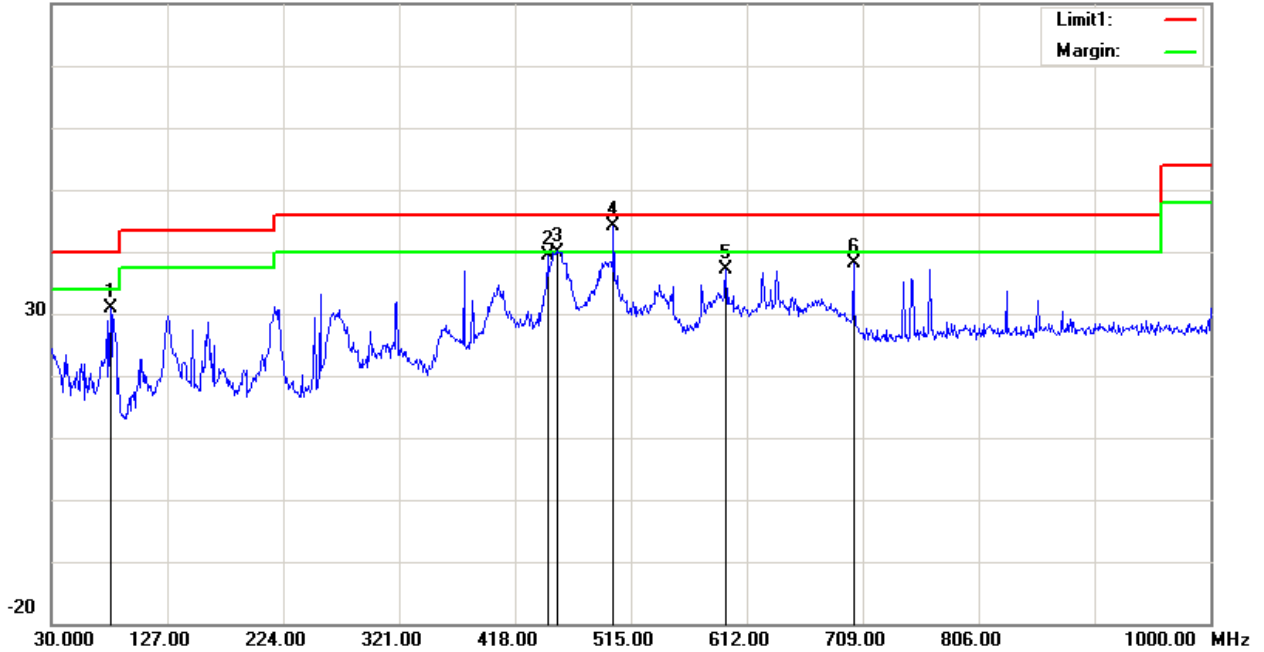

No.	Frequency (MHz)	Reading (dBuV)	Detector	Factor (dB/m)	Result (dBuV/m)	Limit (dBuV/m)	Margin (dB)
1	79.4700	47.26	peak	-16.44	30.82	40.00	9.18
2	445.1600	44.83	peak	-5.53	39.30	46.00	6.70
3	452.9200	45.13	QP	-5.33	39.80	46.00	6.20
4	500.4500	48.38	QP	-4.28	44.10	46.00	1.90
5	594.5400	40.12	peak	-2.97	37.15	46.00	8.85
6	701.2400	39.31	peak	-1.24	38.07	46.00	7.93

3) 1-18GHz:

GFSK, Low Channel, Horizontal

Project No.: XMDN240206-08079E-RF
 Polarization: Horizontal
 Test Mode: Transmitting
 Note: BDR_low channel 2402MHz
 Serial No.: 2HP4-4
 Tester: Bill Yang

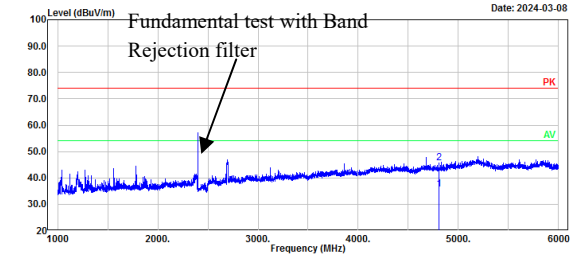

No.	Frequency (MHz)	Reading (dBuV)	Factor (dB/m)	Result (dBuV/m)	Limit (dBuV/m)	Margin (dB)	Detector
1	4804.00	38.70	-3.08	35.62	54.00	18.38	Average
2	4804.00	48.63	-3.08	45.55	74.00	28.45	Peak

GFSK, Low Channel, Vertical

Project No.: XMDN240206-08079E-RF
 Polarization: Vertical
 Test Mode: Transmitting
 Note: BDR_low channel 2402MHz
 Serial No.: 2HP4-4
 Tester: Bill Yang

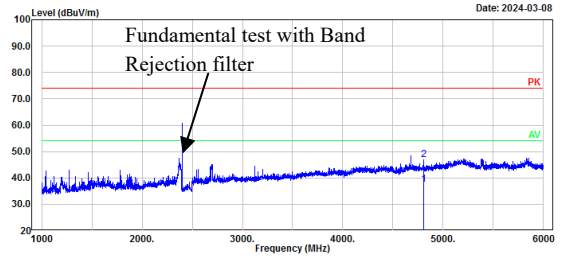

No.	Frequency (MHz)	Reading (dBuV)	Factor (dB/m)	Result (dBuV/m)	Limit (dBuV/m)	Margin (dB)	Detector
1	4804.00	40.56	-3.08	37.48	54.00	16.52	Average
2	4804.00	50.05	-3.08	46.97	74.00	27.03	Peak

Project No.: XMDN240206-08079E-RF
 Polarization: Horizontal
 Test Mode: Transmitting
 Note: BDR_low channel 2402MHz
 Serial No.: 2HP4-4
 Tester: Bill Yang

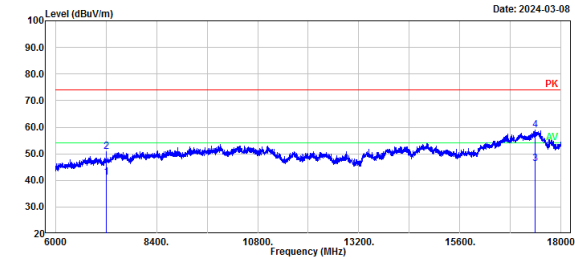

No.	Frequency (MHz)	Reading (dBuV)	Factor (dB/m)	Result (dBuV/m)	Limit (dBuV/m)	Margin (dB)	Detector
1	7206.00	39.63	1.62	41.25	54.00	12.75	Average
2	7206.00	49.05	1.62	50.67	74.00	23.33	Peak
3	17388.00	31.34	14.98	46.32	54.00	7.68	Average
4	17388.00	43.91	14.98	58.89	74.00	15.11	Peak

Project No.: XMDN240206-08079E-RF
 Polarization: Vertical
 Test Mode: Transmitting
 Note: BDR_low channel 2402MHz
 Serial No.: 2HP4-4
 Tester: Bill Yang

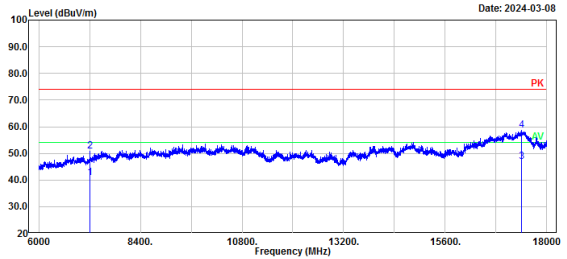

No.	Frequency (MHz)	Reading (dBuV)	Factor (dB/m)	Result (dBuV/m)	Limit (dBuV/m)	Margin (dB)	Detector
1	7206.00	39.34	1.62	40.96	54.00	13.04	Average
2	7206.00	49.04	1.62	50.66	74.00	23.34	Peak
3	17402.40	31.77	15.10	46.87	54.00	7.13	Average
4	17402.40	43.50	15.10	58.60	74.00	15.40	Peak

GFSK, Low Channel, Bandedge, Horizontal

Project No.: XMDN240206-08079E-RF
 Polarization: Horizontal
 Test Mode: Transmitting
 Note: BDR_low channel 2402MHz

Serial No.: ZHP4-4
 Tester: Bill Yang

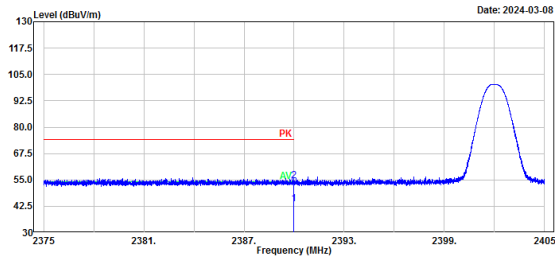

No.	Frequency (MHz)	Reading (dBuV)	Factor (dB/m)	Result (dBuV/m)	Limit (dBuV/m)	Margin (dB)	Detector
1	2390.00	15.01	28.57	43.58	54.00	10.42	Average
2	2390.00	25.80	28.57	54.37	74.00	19.63	Peak

GFSK, Low Channel, Bandedge, Vertical

Project No.: XMDN240206-08079E-RF
 Polarization: Vertical
 Test Mode: Transmitting
 Note: BDR_low channel 2402MHz

Serial No.: ZHP4-4
 Tester: Bill Yang

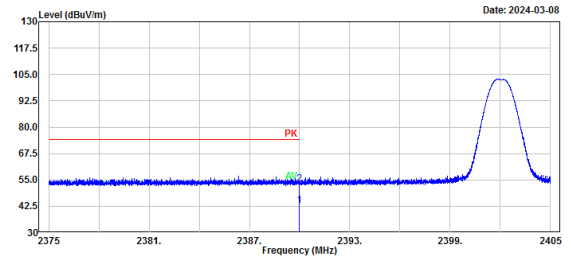

No.	Frequency (MHz)	Reading (dBuV)	Factor (dB/m)	Result (dBuV/m)	Limit (dBuV/m)	Margin (dB)	Detector
1	2390.00	14.23	28.57	42.80	54.00	11.20	Average
2	2390.00	24.49	28.57	53.06	74.00	20.94	Peak

GFSK, Middle Channel, Horizontal

Project No.: XMDN240206-08079E-RF
 Polarization: Horizontal
 Test Mode: Transmitting
 Note: BDR_middle channel 2441MHz

Serial No.: 2HP4-4
 Tester: Bill Yang

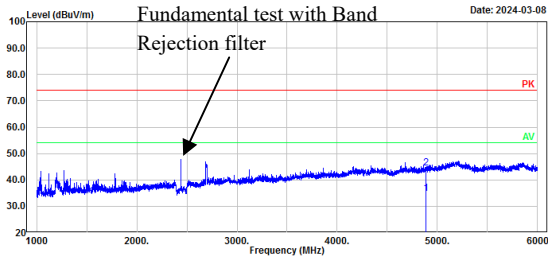

No.	Frequency (MHz)	Reading (dBuV)	Factor (dB/m)	Result (dBuV/m)	Limit (dBuV/m)	Margin (dB)	Detector
1	4882.00	37.58	-2.72	34.86	54.00	19.14	Average
2	4882.00	47.22	-2.72	44.50	74.00	29.50	Peak

GFSK, Middle Channel, Vertical

Project No.: XMDN240206-08079E-RF
 Polarization: Vertical
 Test Mode: Transmitting
 Note: BDR_middle channel 2441MHz

Serial No.: 2HP4-4
 Tester: Bill Yang

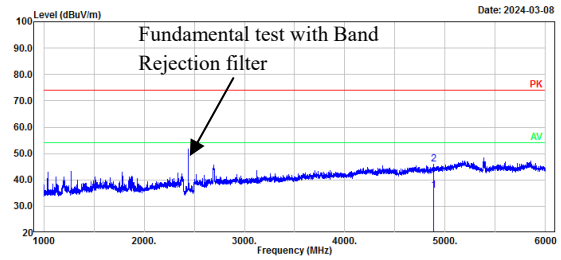

No.	Frequency (MHz)	Reading (dBuV)	Factor (dB/m)	Result (dBuV/m)	Limit (dBuV/m)	Margin (dB)	Detector
1	4882.00	38.69	-2.72	35.97	54.00	18.03	Average
2	4882.00	48.65	-2.72	45.93	74.00	28.07	Peak

Project No.: XMDN240206-08079E-RF
 Polarization: Horizontal
 Test Mode: Transmitting
 Note: BDR_middle channel 2441MHz

Serial No.: 2HP4-4
 Tester: Bill Yang

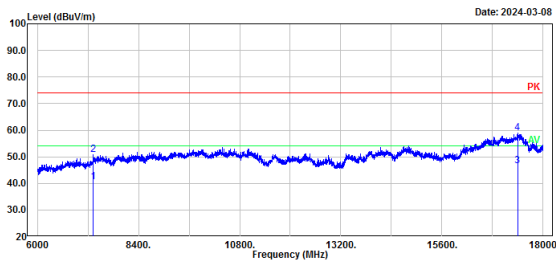

No.	Frequency (MHz)	Reading (dBuV)	Factor (dB/m)	Result (dBuV/m)	Limit (dBuV/m)	Margin (dB)	Detector
1	7323.00	38.40	2.11	40.51	54.00	13.49	Average
2	7323.00	48.56	2.11	50.67	74.00	23.33	Peak
3	17392.80	31.54	15.01	46.55	54.00	7.45	Average
4	17392.80	43.98	15.01	58.99	74.00	15.01	Peak

Project No.: XMDN240206-08079E-RF
 Polarization: Vertical
 Test Mode: Transmitting
 Note: BDR_middle channel 2441MHz

Serial No.: 2HP4-4
 Tester: Bill Yang

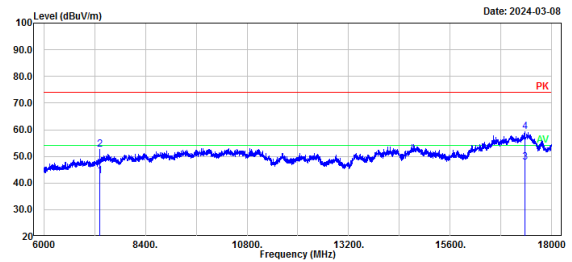

No.	Frequency (MHz)	Reading (dBuV)	Factor (dB/m)	Result (dBuV/m)	Limit (dBuV/m)	Margin (dB)	Detector
1	7323.00	40.68	2.11	42.79	54.00	11.21	Average
2	7323.00	50.47	2.11	52.58	74.00	21.42	Peak
3	17356.80	33.17	14.72	47.89	54.00	6.11	Average
4	17356.80	44.49	14.72	59.21	74.00	14.79	Peak

GFSK, High Channel, Horizontal

Project No.: XMDN240206-08079E-RF
 Polarization: Horizontal
 Test Mode: Transmitting
 Note: BDR_high channel 2480MHz

Serial No.: 2HP4-4
 Tester: Bill Yang

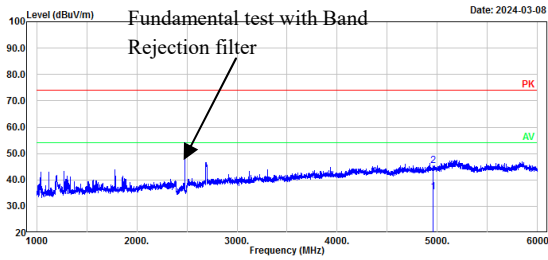

No.	Frequency (MHz)	Reading (dBuV)	Factor (dB/m)	Result (dBuV/m)	Limit (dBuV/m)	Margin (dB)	Detector
1	4960.00	37.66	-2.35	35.31	54.00	18.69	Average
2	4960.00	47.68	-2.35	45.33	74.00	28.67	Peak

GFSK, High Channel, Vertical

Project No.: XMDN240206-08079E-RF
 Polarization: Vertical
 Test Mode: Transmitting
 Note: BDR_high channel 2480MHz

Serial No.: 2HP4-4
 Tester: Bill Yang

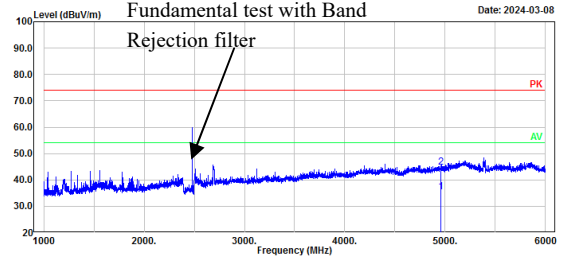

No.	Frequency (MHz)	Reading (dBuV)	Factor (dB/m)	Result (dBuV/m)	Limit (dBuV/m)	Margin (dB)	Detector
1	4960.00	37.87	-2.35	35.52	54.00	18.48	Average
2	4960.00	47.23	-2.35	44.88	74.00	29.12	Peak

Project No.: XMDN240206-08079E-RF
 Polarization: Horizontal
 Test Mode: Transmitting
 Note: BDR_high channel 2480MHz

Serial No.: 2HP4-4
 Tester: Bill Yang

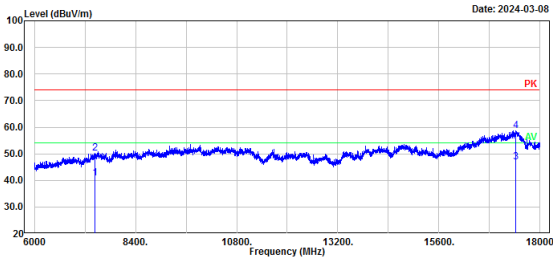

No.	Frequency (MHz)	Reading (dBuV)	Factor (dB/m)	Result (dBuV/m)	Limit (dBuV/m)	Margin (dB)	Detector
1	7440.00	38.22	2.47	40.69	54.00	13.31	Average
2	7440.00	47.70	2.47	50.17	74.00	23.83	Peak
3	17428.80	31.58	15.30	46.88	54.00	7.12	Average
4	17428.80	43.41	15.30	58.71	74.00	15.29	Peak

Project No.: XMDN240206-08079E-RF
 Polarization: Vertical
 Test Mode: Transmitting
 Note: BDR_high channel 2480MHz

Serial No.: 2HP4-4
 Tester: Bill Yang

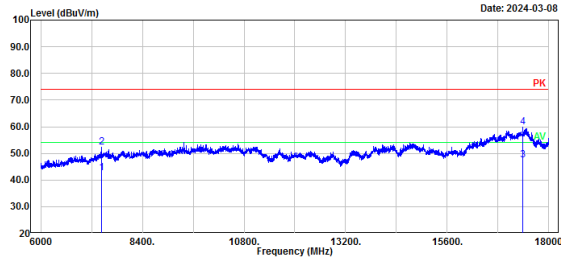

No.	Frequency (MHz)	Reading (dBuV)	Factor (dB/m)	Result (dBuV/m)	Limit (dBuV/m)	Margin (dB)	Detector
1	7440.00	40.11	2.47	42.58	54.00	11.42	Average
2	7440.00	49.94	2.47	52.41	74.00	21.59	Peak
3	17388.00	32.46	14.98	47.44	54.00	6.56	Average
4	17388.00	44.95	14.98	59.93	74.00	14.07	Peak

GFSK, High Channel, Bandedge, Horizontal

Project No.: XMDN240206-08079E-RF
 Polarization: Horizontal
 Test Mode: Transmitting
 Note: BDR_high channel 2480MHz

Serial No.: ZHP4-4
 Tester: Bill Yang

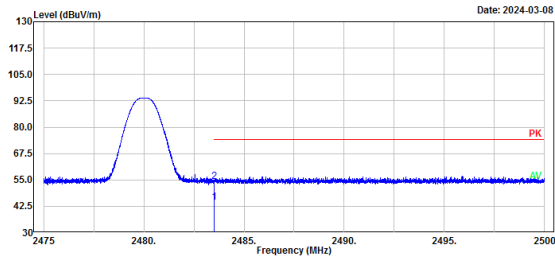

No.	Frequency (MHz)	Reading (dBuV)	Factor (dB/m)	Result (dBuV/m)	Limit (dBuV/m)	Margin (dB)	Detector
1	2483.50	15.23	28.95	44.18	54.00	9.82	Average
2	2483.50	25.11	28.95	54.06	74.00	19.94	Peak

GFSK, High Channel, Bandedge, Vertical

Project No.: XMDN240206-08079E-RF
 Polarization: Vertical
 Test Mode: Transmitting
 Note: BDR_high channel 2480MHz

Serial No.: ZHP4-4
 Tester: Bill Yang

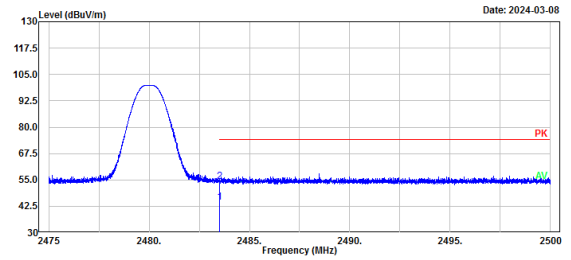

No.	Frequency (MHz)	Reading (dBuV)	Factor (dB/m)	Result (dBuV/m)	Limit (dBuV/m)	Margin (dB)	Detector
1	2483.50	15.22	28.95	44.17	54.00	9.83	Average
2	2483.50	25.09	28.95	54.04	74.00	19.96	Peak

$\pi/4$ -DQPSK, Low Channel, Horizontal

Project No.: XMDN240206-08079E-RF
 Polarization: Horizontal
 Test Mode: Transmitting
 Note: 2EDR_low channel 2402MHz

Serial No.: 2HP4-4
 Tester: Bill Yang

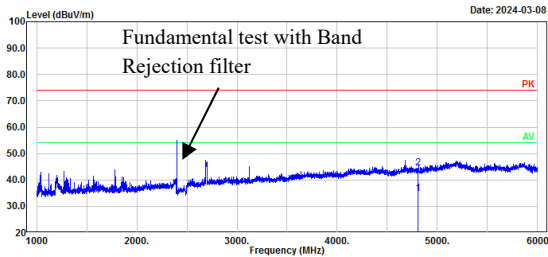

No.	Frequency (MHz)	Reading (dBuV)	Factor (dB/m)	Result (dBuV/m)	Limit (dBuV/m)	Margin (dB)	Detector
1	4804.00	37.85	-3.08	34.77	54.00	19.23	Average
2	4804.00	47.43	-3.08	44.35	74.00	29.65	Peak

$\pi/4$ -DQPSK, Low Channel, Vertical

Project No.: XMDN240206-08079E-RF
 Polarization: Vertical
 Test Mode: Transmitting
 Note: 2EDR_low channel 2402MHz

Serial No.: 2HP4-4
 Tester: Bill Yang

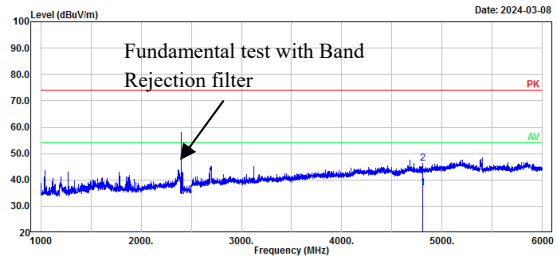

No.	Frequency (MHz)	Reading (dBuV)	Factor (dB/m)	Result (dBuV/m)	Limit (dBuV/m)	Margin (dB)	Detector
1	4804.00	39.88	-3.08	36.80	54.00	17.20	Average
2	4804.00	49.36	-3.08	46.28	74.00	27.72	Peak

Project No.: XMDN240206-08079E-RF
 Polarization: Horizontal
 Test Mode: Transmitting
 Note: 2EDR_low channel 2402MHz

Serial No.: 2HP4-4
 Tester: Bill Yang

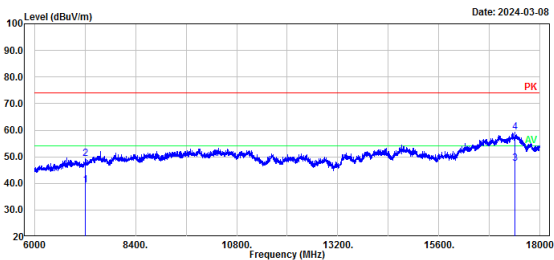

No.	Frequency (MHz)	Reading (dBuV)	Factor (dB/m)	Result (dBuV/m)	Limit (dBuV/m)	Margin (dB)	Detector
1	7206.00	37.73	1.62	39.35	54.00	14.65	Average
2	7206.00	47.55	1.62	49.17	74.00	24.83	Peak
3	17397.60	32.41	15.06	47.47	54.00	6.53	Average
4	17397.60	44.21	15.06	59.27	74.00	14.73	Peak

Project No.: XMDN240206-08079E-RF
 Polarization: Vertical
 Test Mode: Transmitting
 Note: 2EDR_low channel 2402MHz

Serial No.: 2HP4-4
 Tester: Bill Yang

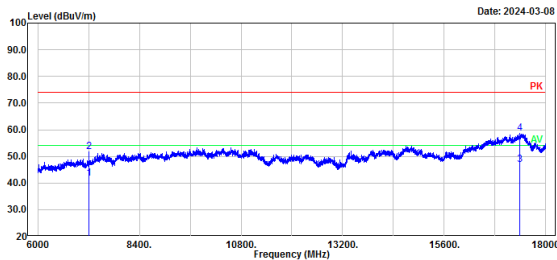

No.	Frequency (MHz)	Reading (dBuV)	Factor (dB/m)	Result (dBuV/m)	Limit (dBuV/m)	Margin (dB)	Detector
1	7206.00	40.22	1.62	41.84	54.00	12.16	Average
2	7206.00	50.11	1.62	51.73	74.00	22.27	Peak
3	17388.00	31.81	14.98	46.79	54.00	7.21	Average
4	17388.00	43.76	14.98	58.74	74.00	15.26	Peak

$\pi/4$ -DQPSK, Low Channel, Bandedge, Horizontal

Project No.: XMDN240206-08079E-RF Serial No.: ZHP4-4
 Polarization: Horizontal Tester: Bill Yang
 Test Mode: Transmitting
 Note: 2EOR_low channel 2402MHz

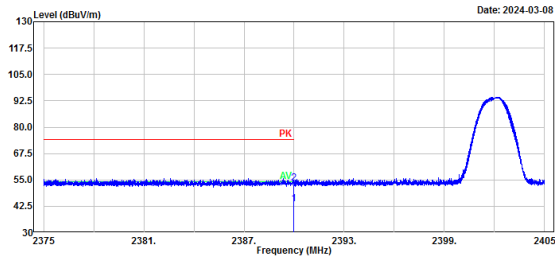

No.	Frequency (MHz)	Reading (dBuV)	Factor (dB/m)	Result (dBuV/m)	Limit (dBuV/m)	Margin (dB)	Detector
1	2390.00	15.11	28.57	43.68	54.00	10.32	Average
2	2390.00	25.00	28.57	53.57	74.00	20.43	Peak

$\pi/4$ -DQPSK, Low Channel, Bandedge, Vertical

Project No.: XMDN240206-08079E-RF Serial No.: ZHP4-4
 Polarization: Vertical Tester: Bill Yang
 Test Mode: Transmitting
 Note: 2EOR_low channel 2402MHz

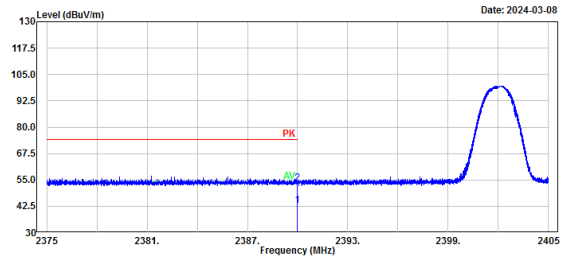

No.	Frequency (MHz)	Reading (dBuV)	Factor (dB/m)	Result (dBuV/m)	Limit (dBuV/m)	Margin (dB)	Detector
1	2390.00	14.36	28.57	42.93	54.00	11.07	Average
2	2390.00	24.79	28.57	53.36	74.00	20.64	Peak

$\pi/4$ -DQPSK, Middle Channel, Horizontal

Project No.: XMDN240206-08079E-RF
 Polarization: Horizontal
 Test Mode: Transmitting
 Note: 2EDR_middle channel 2441MHz
 Serial No.: 2HP4-4
 Tester: Bill Yang

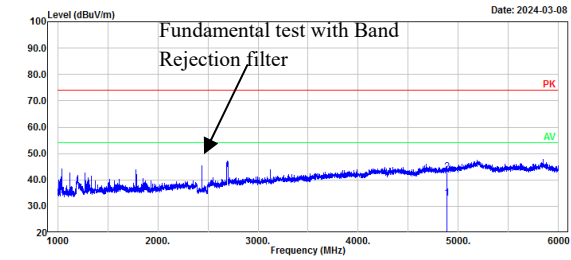

No.	Frequency (MHz)	Reading (dBuV)	Factor (dB/m)	Result (dBuV/m)	Limit (dBuV/m)	Margin (dB)	Detector
1	4882.00	35.84	-2.72	33.12	54.00	20.88	Average
2	4882.00	45.79	-2.72	43.07	74.00	30.93	Peak

$\pi/4$ -DQPSK, Middle Channel, Vertical

Project No.: XMDN240206-08079E-RF
 Polarization: Vertical
 Test Mode: Transmitting
 Note: 2EDR_middle channel 2441MHz
 Serial No.: 2HP4-4
 Tester: Bill Yang

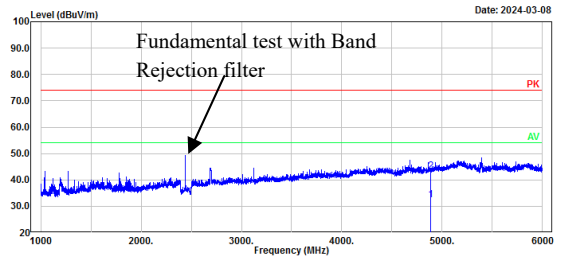

No.	Frequency (MHz)	Reading (dBuV)	Factor (dB/m)	Result (dBuV/m)	Limit (dBuV/m)	Margin (dB)	Detector
1	4882.00	35.12	-2.72	32.40	54.00	21.60	Average
2	4882.00	45.90	-2.72	43.18	74.00	30.82	Peak

Project No.: XMDN240206-08079E-RF
 Polarization: Horizontal
 Test Mode: Transmitting
 Note: 2EDR_middle channel 2441MHz
 Serial No.: 2HP4-4
 Tester: Bill Yang

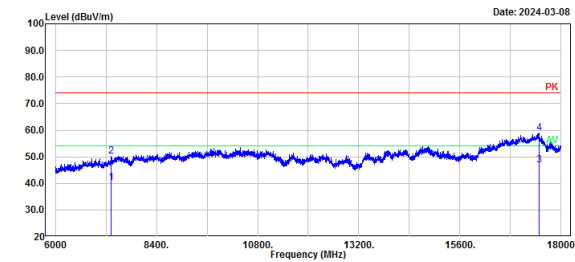

No.	Frequency (MHz)	Reading (dBuV)	Factor (dB/m)	Result (dBuV/m)	Limit (dBuV/m)	Margin (dB)	Detector
1	7323.00	38.23	2.11	40.34	54.00	13.66	Average
2	7323.00	48.21	2.11	50.32	74.00	23.68	Peak
3	17476.80	31.26	15.69	46.95	54.00	7.05	Average
4	17476.80	43.11	15.69	58.80	74.00	15.20	Peak

Project No.: XMDN240206-08079E-RF
 Polarization: Vertical
 Test Mode: Transmitting
 Note: 2EDR_middle channel 2441MHz
 Serial No.: 2HP4-4
 Tester: Bill Yang

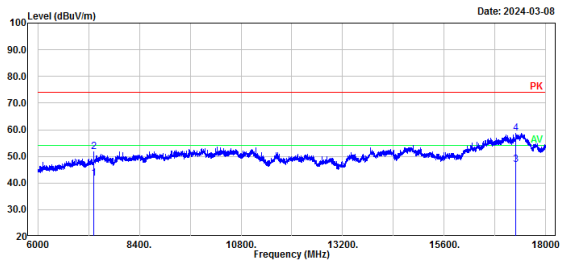

No.	Frequency (MHz)	Reading (dBuV)	Factor (dB/m)	Result (dBuV/m)	Limit (dBuV/m)	Margin (dB)	Detector
1	7323.00	39.54	2.11	41.65	54.00	12.35	Average
2	7323.00	49.53	2.11	51.64	74.00	22.36	Peak
3	17287.20	32.60	14.15	46.75	54.00	7.25	Average
4	17287.20	44.56	14.15	58.71	74.00	15.29	Peak

$\pi/4$ -DQPSK, High Channel, Horizontal

Project No.: XMDN240206-08079E-RF
 Polarization: Horizontal
 Test Mode: Transmitting
 Note: 2EDR_high channel 2480MHz

Serial No.: ZHP4-4
 Tester: Bill Yang

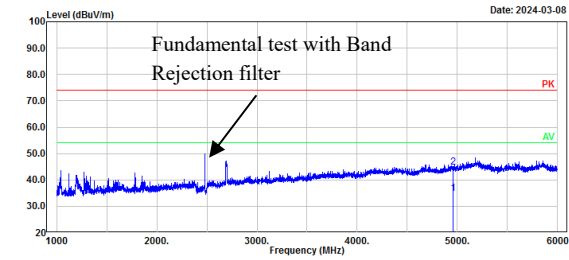

No.	Frequency (MHz)	Reading (dBuV)	Factor (dB/m)	Result (dBuV/m)	Limit (dBuV/m)	Margin (dB)	Detector
1	4960.00	37.17	-2.35	34.82	54.00	19.18	Average
2	4960.00	47.15	-2.35	44.80	74.00	29.20	Peak

$\pi/4$ -DQPSK, High Channel, Vertical

Project No.: XMDN240206-08079E-RF
 Polarization: Vertical
 Test Mode: Transmitting
 Note: 2EDR_high channel 2480MHz

Serial No.: ZHP4-4
 Tester: Bill Yang

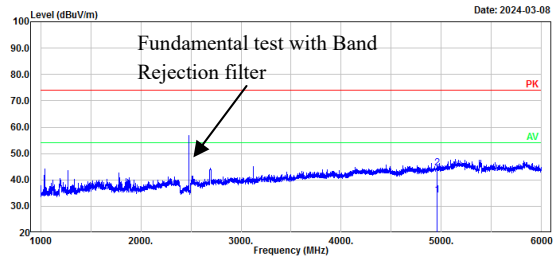

No.	Frequency (MHz)	Reading (dBuV)	Factor (dB/m)	Result (dBuV/m)	Limit (dBuV/m)	Margin (dB)	Detector
1	4960.00	36.44	-2.35	34.09	54.00	19.91	Average
2	4960.00	46.89	-2.35	44.54	74.00	29.46	Peak

Project No.: XMDN240206-08079E-RF
 Polarization: Horizontal
 Test Mode: Transmitting
 Note: 2EDR_high channel 2480MHz

Serial No.: ZHP4-4
 Tester: Bill Yang

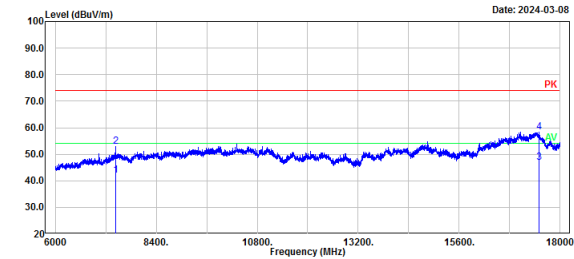

No.	Frequency (MHz)	Reading (dBuV)	Factor (dB/m)	Result (dBuV/m)	Limit (dBuV/m)	Margin (dB)	Detector
1	7440.00	39.54	2.47	42.01	54.00	11.99	Average
2	7440.00	50.31	2.47	52.78	74.00	21.22	Peak
3	17496.00	30.90	15.84	46.74	54.00	7.26	Average
4	17496.00	42.54	15.84	58.38	74.00	15.62	Peak

Project No.: XMDN240206-08079E-RF
 Polarization: Vertical
 Test Mode: Transmitting
 Note: 2EDR_high channel 2480MHz

Serial No.: ZHP4-4
 Tester: Bill Yang

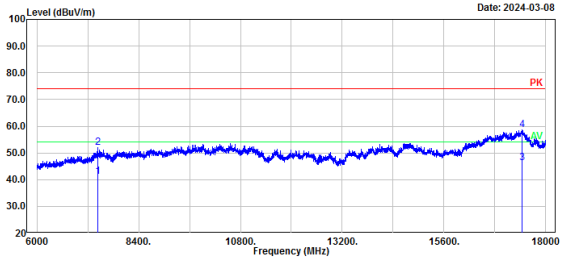

No.	Frequency (MHz)	Reading (dBuV)	Factor (dB/m)	Result (dBuV/m)	Limit (dBuV/m)	Margin (dB)	Detector
1	7440.00	38.65	2.47	41.12	54.00	12.88	Average
2	7440.00	49.42	2.47	51.89	74.00	22.11	Peak
3	17438.40	30.86	15.39	46.25	54.00	7.75	Average
4	17438.40	43.38	15.39	58.77	74.00	15.23	Peak

$\pi/4$ -DQPSK, High Channel, Bandedge, Horizontal

Project No.: XMDN240206-08079E-RF Serial No.: ZHP4-4
 Polarization: Horizontal Tester: Bill Yang
 Test Mode: Transmitting
 Note: 2E0R_high channel 2480MHz

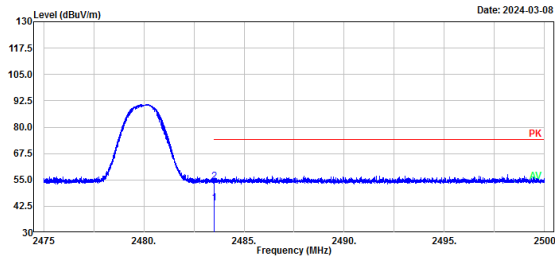

No.	Frequency (MHz)	Reading (dBuV)	Factor (dB/m)	Result (dBuV/m)	Limit (dBuV/m)	Margin (dB)	Detector
1	2483.50	15.11	28.95	44.06	54.00	9.94	Average
2	2483.50	25.22	28.95	54.17	74.00	19.83	Peak

$\pi/4$ -DQPSK, High Channel, Bandedge, Vertical

Project No.: XMDN240206-08079E-RF Serial No.: ZHP4-4
 Polarization: Vertical Tester: Bill Yang
 Test Mode: Transmitting
 Note: 2E0R_high channel 2480MHz

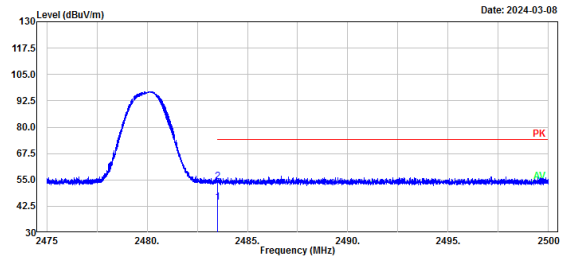

No.	Frequency (MHz)	Reading (dBuV)	Factor (dB/m)	Result (dBuV/m)	Limit (dBuV/m)	Margin (dB)	Detector
1	2483.50	15.21	28.95	44.16	54.00	9.84	Average
2	2483.50	25.30	28.95	54.25	74.00	19.75	Peak

8DPSK, Low Channel, Horizontal

Project No.: XMDN240206-08079E-RF
 Polarization: Horizontal
 Test Mode: Transmitting
 Note: 3EDR_low channel 2402MHz

Serial No.: 2HP4-4
 Tester: Bill Yang

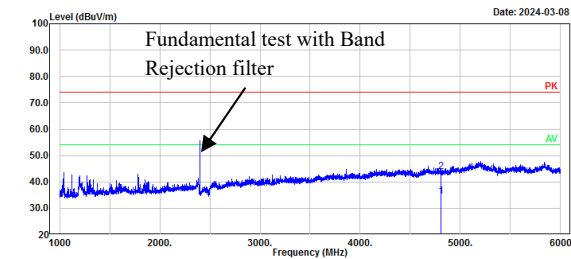

No.	Frequency (MHz)	Reading (dBuV)	Factor (dB/m)	Result (dBuV/m)	Limit (dBuV/m)	Margin (dB)	Detector
1	4804.00	37.69	-3.08	34.61	54.00	19.39	Average
2	4804.00	47.06	-3.08	43.98	74.00	30.02	Peak

8DPSK, Low Channel, Vertical

Project No.: XMDN240206-08079E-RF
 Polarization: Vertical
 Test Mode: Transmitting
 Note: 3EDR_low channel 2402MHz

Serial No.: 2HP4-4
 Tester: Bill Yang

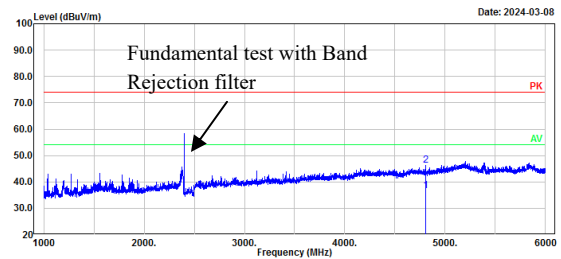

No.	Frequency (MHz)	Reading (dBuV)	Factor (dB/m)	Result (dBuV/m)	Limit (dBuV/m)	Margin (dB)	Detector
1	4804.00	39.79	-3.08	36.71	54.00	17.29	Average
2	4804.00	49.44	-3.08	46.36	74.00	27.64	Peak

Project No.: XMDN240206-08079E-RF
 Polarization: Horizontal
 Test Mode: Transmitting
 Note: 3EDR_low channel 2402MHz

Serial No.: 2HP4-4
 Tester: Bill Yang

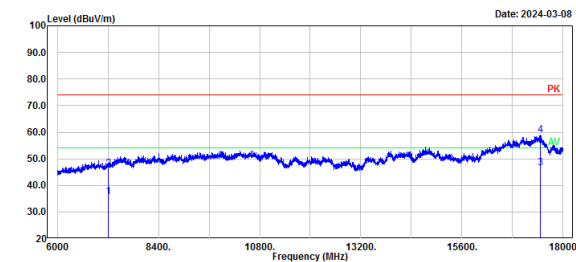

No.	Frequency (MHz)	Reading (dBuV)	Factor (dB/m)	Result (dBuV/m)	Limit (dBuV/m)	Margin (dB)	Detector
1	7206.00	34.21	1.62	35.83	54.00	18.17	Average
2	7206.00	44.76	1.62	46.38	74.00	27.62	Peak
3	17462.40	31.12	15.57	46.69	54.00	7.31	Average
4	17462.40	43.29	15.57	58.86	74.00	15.14	Peak

Project No.: XMDN240206-08079E-RF
 Polarization: Vertical
 Test Mode: Transmitting
 Note: 3EDR_low channel 2402MHz

Serial No.: 2HP4-4
 Tester: Bill Yang

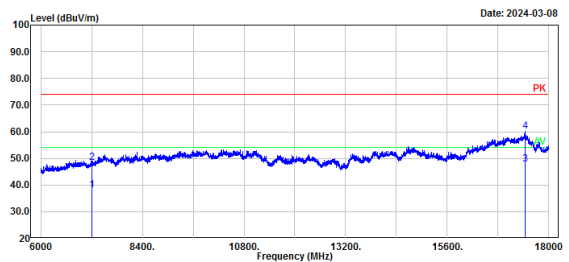

No.	Frequency (MHz)	Reading (dBuV)	Factor (dB/m)	Result (dBuV/m)	Limit (dBuV/m)	Margin (dB)	Detector
1	7206.00	36.64	1.62	38.26	54.00	15.74	Average
2	7206.00	46.84	1.62	48.46	74.00	25.54	Peak
3	17445.60	32.34	15.44	47.78	54.00	6.22	Average
4	17445.60	44.81	15.44	60.25	74.00	13.75	Peak

8DPSK, Low Channel, Bandedge, Horizontal

Project No.: XMDN240206-08079E-RF Serial No.: ZHP4-4
 Polarization: Horizontal Tester: Bill Yang
 Test Mode: Transmitting
 Note: 3EDR_low channel 2402MHz

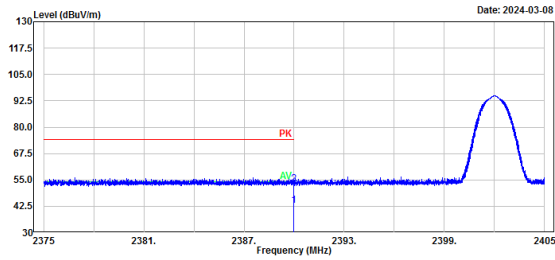

No.	Frequency (MHz)	Reading (dBuV)	Factor (dB/m)	Result (dBuV/m)	Limit (dBuV/m)	Margin (dB)	Detector
1	2390.00	14.36	28.57	42.93	54.00	11.07	Average
2	2390.00	24.55	28.57	53.12	74.00	20.88	Peak

8DPSK, Low Channel, Bandedge, Vertical

Project No.: XMDN240206-08079E-RF Serial No.: ZHP4-4
 Polarization: Vertical Tester: Bill Yang
 Test Mode: Transmitting
 Note: 3EDR_low channel 2402MHz

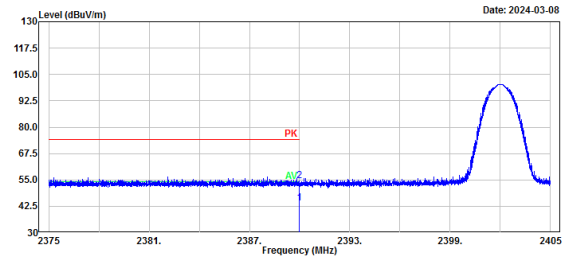

No.	Frequency (MHz)	Reading (dBuV)	Factor (dB/m)	Result (dBuV/m)	Limit (dBuV/m)	Margin (dB)	Detector
1	2390.00	15.21	28.57	43.78	54.00	10.22	Average
2	2390.00	25.99	28.57	54.56	74.00	19.44	Peak

8DPSK, Middle Channel, Horizontal

Project No.: XMDN240206-08079E-RF
 Polarization: Horizontal
 Test Mode: Transmitting
 Note: 3EDR_middle channel 2441MHz

Serial No.: 2HP4-4
 Tester: Bill Yang

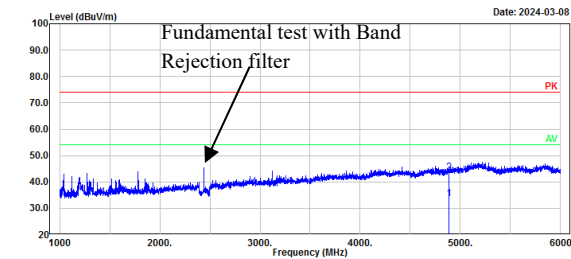

No.	Frequency (MHz)	Reading (dBuV)	Factor (dB/m)	Result (dBuV/m)	Limit (dBuV/m)	Margin (dB)	Detector
1	4882.00	36.41	-2.72	33.69	54.00	20.31	Average
2	4882.00	46.35	-2.72	43.63	74.00	30.37	Peak

8DPSK, Middle Channel, Vertical

Project No.: XMDN240206-08079E-RF
 Polarization: Vertical
 Test Mode: Transmitting
 Note: 3EDR_middle channel 2441MHz

Serial No.: 2HP4-4
 Tester: Bill Yang

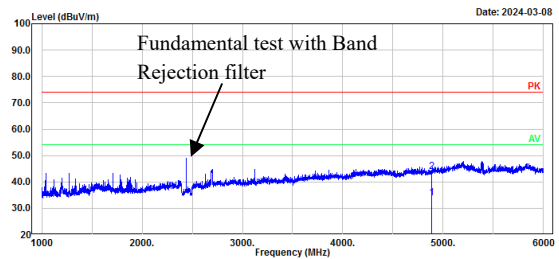

No.	Frequency (MHz)	Reading (dBuV)	Factor (dB/m)	Result (dBuV/m)	Limit (dBuV/m)	Margin (dB)	Detector
1	4882.00	36.59	-2.72	33.87	54.00	20.13	Average
2	4882.00	46.53	-2.72	43.81	74.00	30.19	Peak

Project No.: XMDN240206-08079E-RF
 Polarization: Horizontal
 Test Mode: Transmitting
 Note: 3EDR_middle channel 2441MHz

Serial No.: 2HP4-4
 Tester: Bill Yang

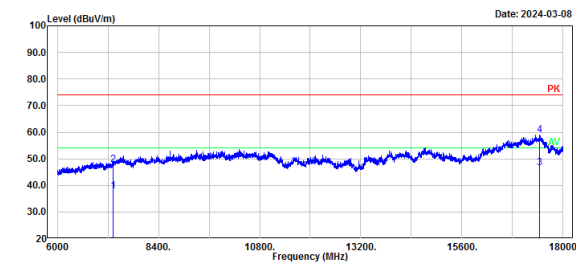

No.	Frequency (MHz)	Reading (dBuV)	Factor (dB/m)	Result (dBuV/m)	Limit (dBuV/m)	Margin (dB)	Detector
1	7323.00	35.77	2.11	37.88	54.00	16.12	Average
2	7323.00	45.72	2.11	47.83	74.00	26.17	Peak
3	17433.60	31.25	15.34	46.59	54.00	7.41	Average
4	17433.60	43.60	15.34	58.94	74.00	15.06	Peak

Project No.: XMDN240206-08079E-RF
 Polarization: Vertical
 Test Mode: Transmitting
 Note: 3EDR_middle channel 2441MHz

Serial No.: 2HP4-4
 Tester: Bill Yang

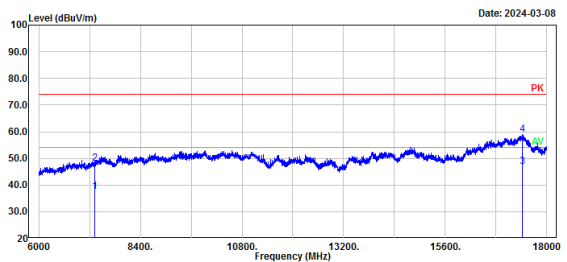

No.	Frequency (MHz)	Reading (dBuV)	Factor (dB/m)	Result (dBuV/m)	Limit (dBuV/m)	Margin (dB)	Detector
1	7323.00	35.35	2.11	37.46	54.00	16.54	Average
2	7323.00	45.84	2.11	47.95	74.00	26.05	Peak
3	17426.40	31.60	15.28	46.88	54.00	7.12	Average
4	17426.40	43.61	15.28	58.89	74.00	15.11	Peak

8DPSK, High Channel, Horizontal

Project No.: XMDN240206-08079E-RF
 Polarization: Horizontal
 Test Mode: Transmitting
 Note: 3EDR_high channel 2480MHz

Serial No.: ZHP4-4
 Tester: Bill Yang

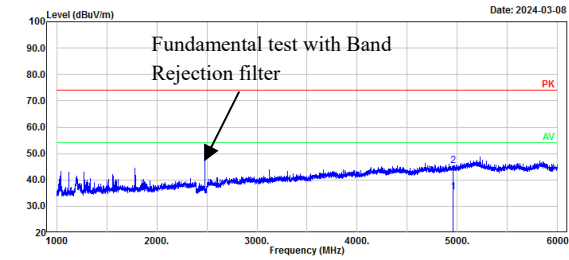

No.	Frequency (MHz)	Reading (dBuV)	Factor (dB/m)	Result (dBuV/m)	Limit (dBuV/m)	Margin (dB)	Detector
1	4960.00	37.69	-2.35	35.34	54.00	18.66	Average
2	4960.00	47.74	-2.35	45.39	74.00	28.61	Peak

8DPSK, High Channel, Vertical

Project No.: XMDN240206-08079E-RF
 Polarization: Vertical
 Test Mode: Transmitting
 Note: 3EDR_high channel 2480MHz

Serial No.: ZHP4-4
 Tester: Bill Yang

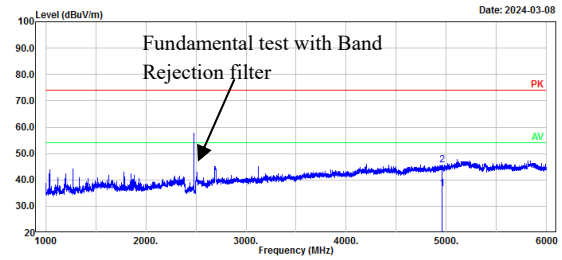

No.	Frequency (MHz)	Reading (dBuV)	Factor (dB/m)	Result (dBuV/m)	Limit (dBuV/m)	Margin (dB)	Detector
1	4960.00	38.87	-2.35	36.52	54.00	17.48	Average
2	4960.00	48.03	-2.35	45.68	74.00	28.32	Peak

Project No.: XMDN240206-08079E-RF
 Polarization: Horizontal
 Test Mode: Transmitting
 Note: 3EDR_high channel 2480MHz

Serial No.: ZHP4-4
 Tester: Bill Yang

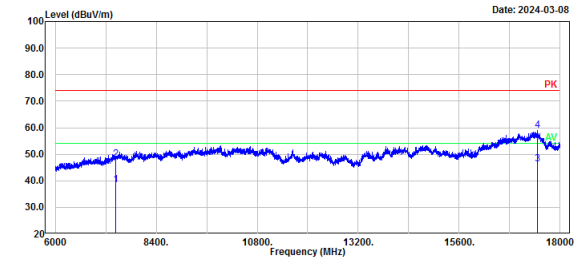

No.	Frequency (MHz)	Reading (dBuV)	Factor (dB/m)	Result (dBuV/m)	Limit (dBuV/m)	Margin (dB)	Detector
1	7440.00	35.94	2.47	38.41	54.00	15.59	Average
2	7440.00	45.65	2.47	48.12	74.00	25.88	Peak
3	17464.80	30.69	15.59	46.28	54.00	7.72	Average
4	17464.80	43.39	15.59	58.98	74.00	15.02	Peak

Project No.: XMDN240206-08079E-RF
 Polarization: Vertical
 Test Mode: Transmitting
 Note: 3EDR_high channel 2480MHz

Serial No.: ZHP4-4
 Tester: Bill Yang

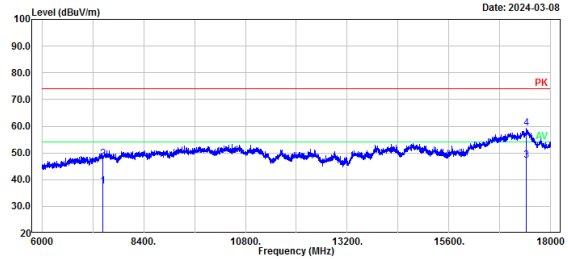

No.	Frequency (MHz)	Reading (dBuV)	Factor (dB/m)	Result (dBuV/m)	Limit (dBuV/m)	Margin (dB)	Detector
1	7440.00	34.89	2.47	37.36	54.00	16.64	Average
2	7440.00	45.26	2.47	47.73	74.00	26.27	Peak
3	17414.40	32.05	15.19	47.24	54.00	6.76	Average
4	17414.40	44.07	15.19	59.26	74.00	14.74	Peak

8DPSK, High Channel, Bandedge, Horizontal

Project No.: XMDN240206-08079E-RF Serial No.: ZHP4-4
 Polarization: Horizontal Tester: Bill Yang
 Test Mode: Transmitting
 Note: 3EDR_high channel 2480MHz

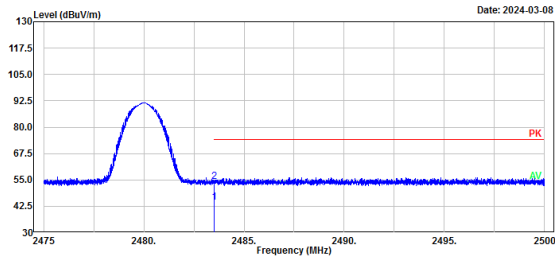

No.	Frequency (MHz)	Reading (dBuV)	Factor (dB/m)	Result (dBuV/m)	Limit (dBuV/m)	Margin (dB)	Detector
1	2483.50	15.21	28.95	44.16	54.00	9.84	Average
2	2483.50	25.31	28.95	54.26	74.00	19.74	Peak

8DPSK, High Channel, Bandedge, Vertical

Project No.: XMDN240206-08079E-RF Serial No.: ZHP4-4
 Polarization: Vertical Tester: Bill Yang
 Test Mode: Transmitting
 Note: 3EDR_high channel 2480MHz

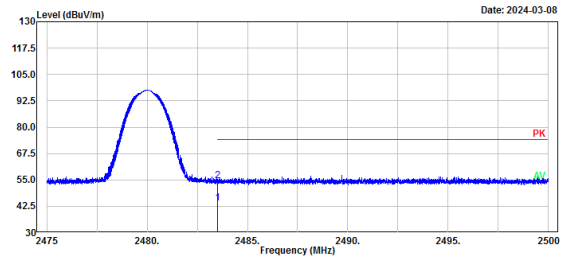

No.	Frequency (MHz)	Reading (dBuV)	Factor (dB/m)	Result (dBuV/m)	Limit (dBuV/m)	Margin (dB)	Detector
1	2483.50	15.07	28.95	44.02	54.00	9.98	Average
2	2483.50	25.51	28.95	54.46	74.00	19.54	Peak

18-25GHz:

No Emission was detected in the range 18-25GHz, test was performed on the mode and channel which with the maximum power.

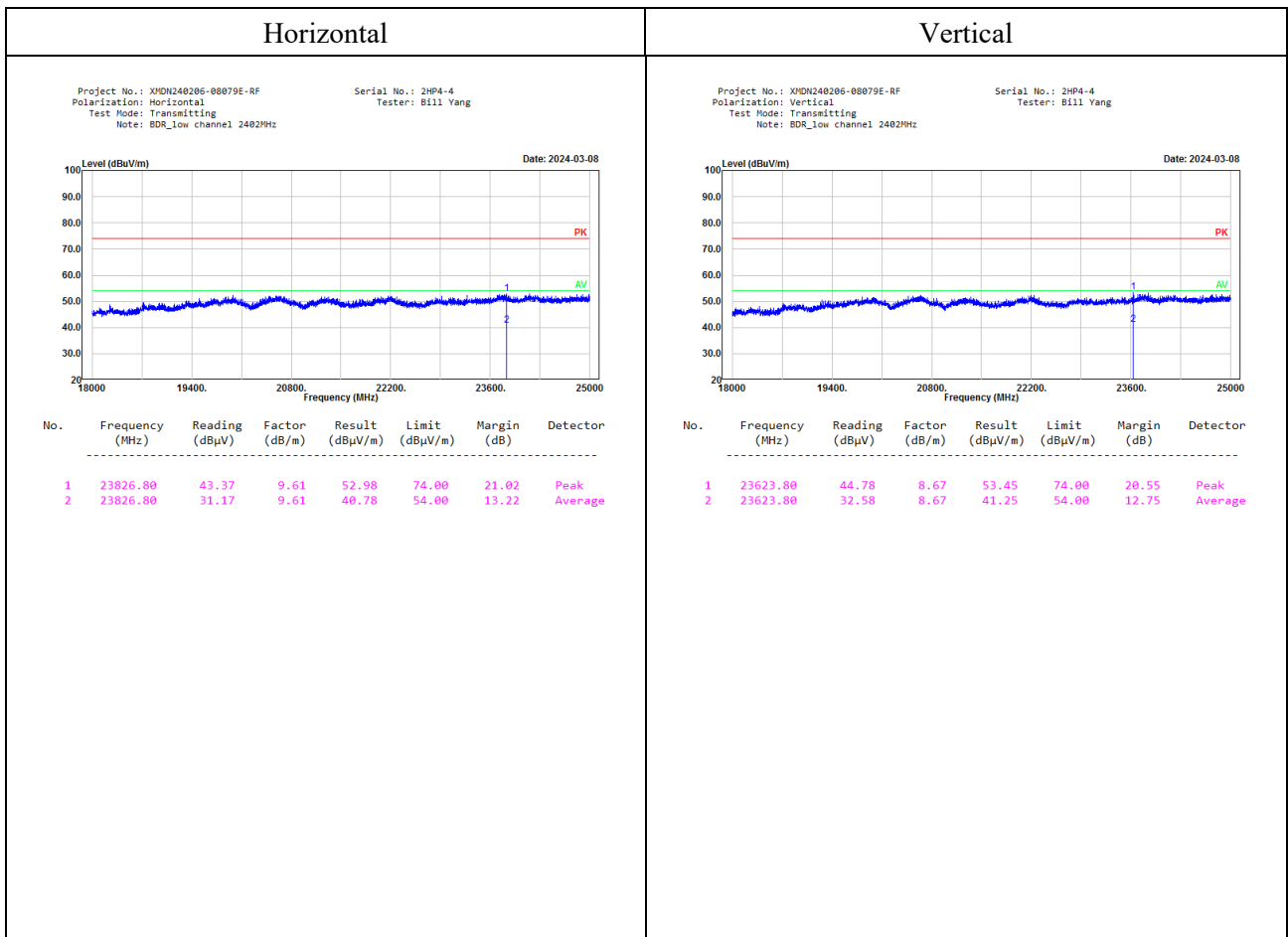

5.3 20 dB Emission Bandwidth:

Serial No.:	2HP4-1	Test Date:	2024/04/09
Test Site:	RF	Test Mode:	Transmitting
Tester:	Stu Song	Test Result:	Pass

Environmental Conditions:

Temperature: (°C)	24.3	Relative Humidity: (%)	53	ATM Pressure: (kPa)	100.8
-----------------------------	------	----------------------------------	----	-------------------------------	-------

Test Equipment List and Details:

Manufacturer	Description	Model	Serial Number	Calibration Date	Calibration Due Date
R&S	Spectrum Analyzer	FSU 26	200160/026	2023/10/18	2024/10/17
Eastsheep	Coaxial Attenuator	5W-N-JK-6G-10dB	F-08-EM503	2023/09/10	2024/09/09

* Statement of Traceability: Bay Area Compliance Laboratories Corp. (Dongguan) attests that all calibrations have been performed, traceable to National Primary Standards and International System of Units (SI).

Test Data:

Mode	Value (MHz)
GFSK_Low	0.950
GFSK_Middle	0.950
GFSK_High	0.944
$\pi/4$ -DQPSK_Low	1.310
$\pi/4$ -DQPSK_Middle	1.307
$\pi/4$ -DQPSK_High	1.310
8DPSK_Low	1.283
8DPSK_Middle	1.283
8DPSK_High	1.283

GFSK_Low

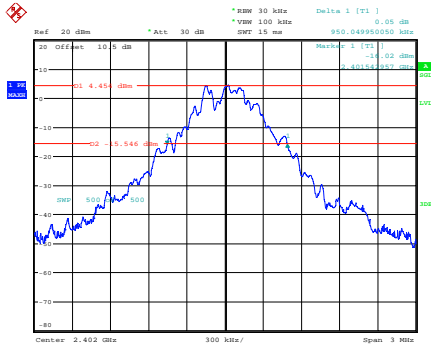

ProjectNo.:XMDN240206-08079E-RF Tester:Stu Song
Date: 9.APR.2024 13:54:20

GFSK_Middle

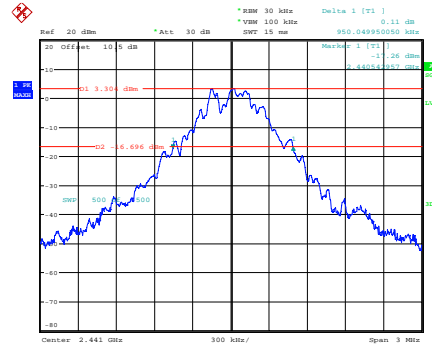

ProjectNo.:XMDN240206-08079E-RF Tester:Stu Song
Date: 9.APR.2024 13:56:42

GFSK_High

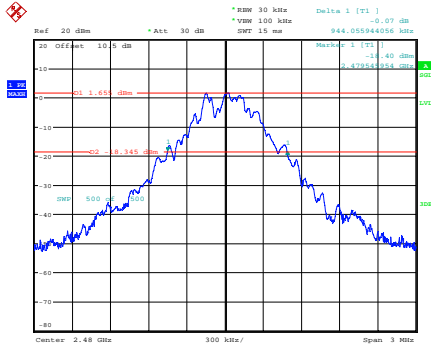

ProjectNo.:XMDN240206-08079E-RF Tester:Stu Song
Date: 9.APR.2024 13:59:02

EDR

$\pi/4$ -DQPSK_Low

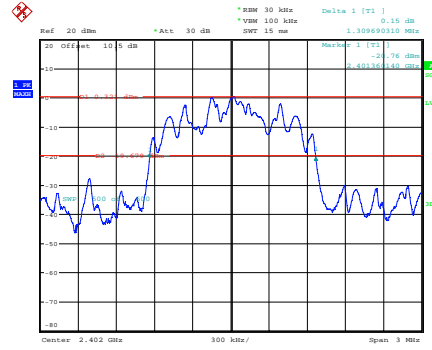

ProjectNo.:XMDN240206-08079E-RF Tester:Stu Song
Date: 9.APR.2024 14:16:53

$\pi/4$ -DQPSK_Middle

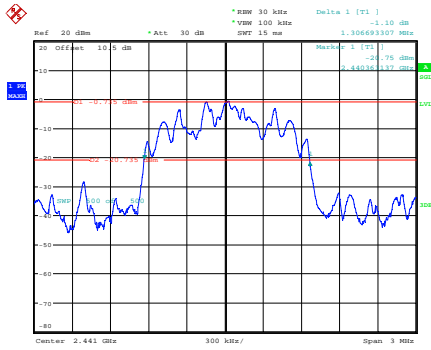

ProjectNo.:XMDN240206-08079E-RF Tester:Stu Song
Date: 9.APR.2024 14:19:24

$\pi/4$ -DQPSK_High

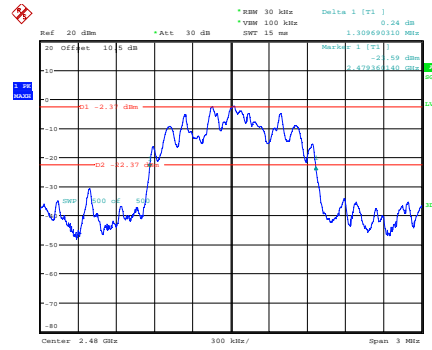

ProjectNo.:XMDN240206-08079E-RF Tester:Stu Song
Date: 9.APR.2024 14:21:42

8DPSK_Low

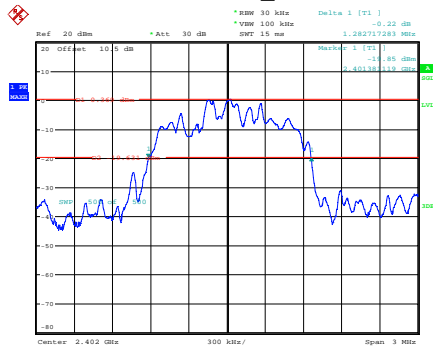

ProjectNo.:XMDN240206-08079E-RF Tester:Stu Song
Date: 9.APR.2024 14:24:04

8DPSK_Middle

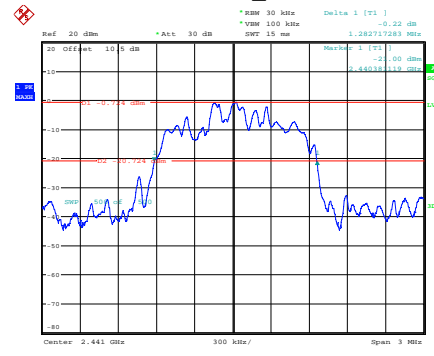

ProjectNo.:XMDN240206-08079E-RF Tester:Stu Song
Date: 9.APR.2024 14:26:27

8DPSK_High

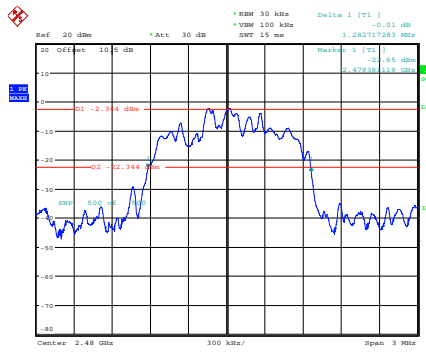

ProjectNo.:XMDN240206-08079E-RF Tester:Stu Song
Date: 9.APR.2024 14:28:52

5.4 99% Occupied Bandwidth:

Serial No.:	2HP4-1	Test Date:	2024/04/09
Test Site:	RF	Test Mode:	Transmitting
Tester:	Stu Song	Test Result:	Pass

Environmental Conditions:

Temperature: (°C)	24.3	Relative Humidity: (%)	53	ATM Pressure: (kPa)	100.8
-----------------------------	------	----------------------------------	----	-------------------------------	-------

Test Equipment List and Details:

Manufacturer	Description	Model	Serial Number	Calibration Date	Calibration Due Date
R&S	Spectrum Analyzer	FSU 26	200160/026	2023/10/18	2024/10/17
Eastsheep	Coaxial Attenuator	5W-N-JK-6G-10dB	F-08-EM503	2023/09/10	2024/09/09

* Statement of Traceability: Bay Area Compliance Laboratories Corp. (Dongguan) attests that all calibrations have been performed, traceable to National Primary Standards and International System of Units (SI).

Test Data:

Mode	99% OBW (MHz)
GFSK_Low	0.861
GFSK_Middle	0.858
GFSK_High	0.852
$\pi/4$ -DQPSK_Low	1.227
$\pi/4$ -DQPSK_Middle	1.227
$\pi/4$ -DQPSK_High	1.224
8DPSK_Low	1.164
8DPSK_Middle	1.167
8DPSK_High	1.164

BDR

GFSK_Low

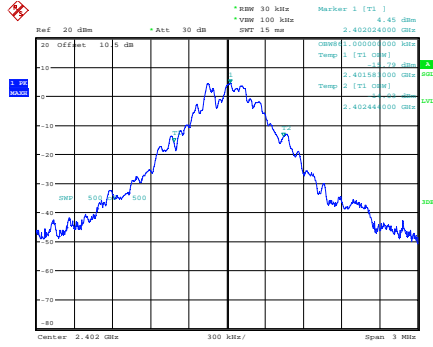

ProjectNo.:XMDN240206-08079E-RF Tester:Stu Song
Date: 9.APR.2024 13:55:19

GFSK_Middle

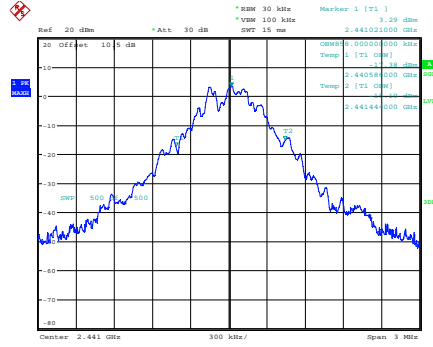

ProjectNo.:XMDN240206-08079E-RF Tester:Stu Song
Date: 9.APR.2024 13:57:37

EDR

GFSK_High

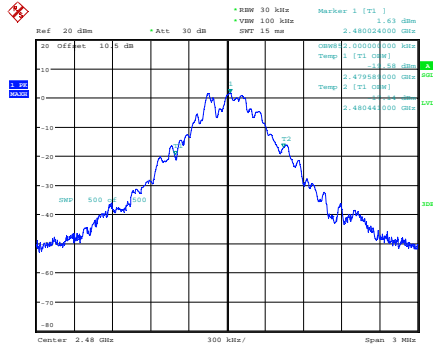

ProjectNo.:XMDN240206-08079E-RF Tester:Stu Song
Date: 9.APR.2024 13:59:58

$\pi/4$ -DQPSK_Low

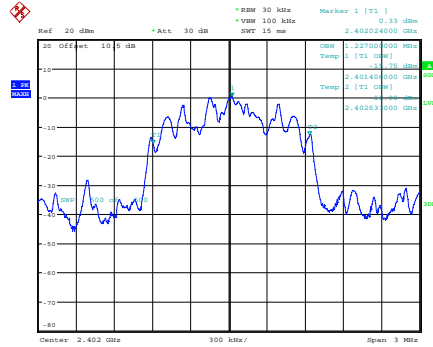

ProjectNo.:XMDN240206-08079E-RF Tester:Stu Song
Date: 9.APR.2024 14:17:51

$\pi/4$ -DQPSK_Middle

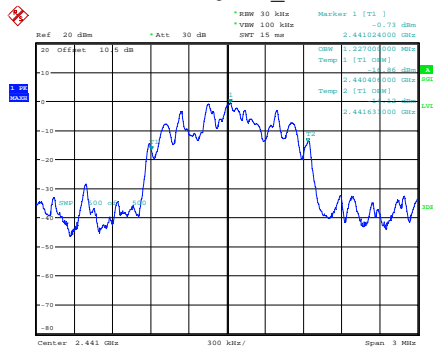

ProjectNo.:XMDN240206-08079E-RF Tester:Stu Song
Date: 9.APR.2024 14:20:20

$\pi/4$ -DQPSK_High

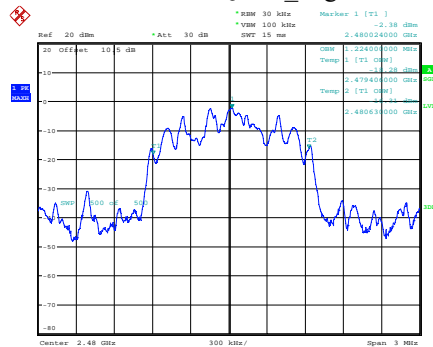

ProjectNo.:XMDN240206-08079E-RF Tester:Stu Song
Date: 9.APR.2024 14:22:38

8DPSK_Low

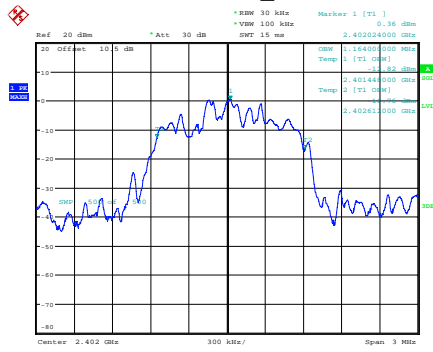

ProjectNo.:XMDN240206-08079E-RF Tester:Stu Song
Date: 9.APR.2024 14:25:04

8DPSK_Middle

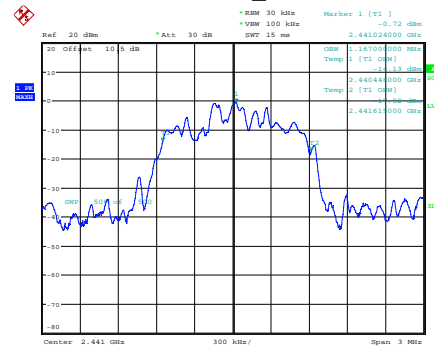

ProjectNo.:XMDN240206-08079E-RF Tester:Stu Song
Date: 9.APR.2024 14:27:23

8DPSK_High

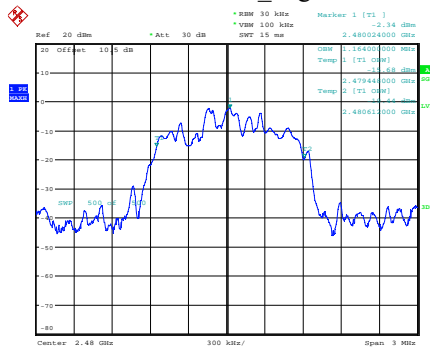

ProjectNo.:XMDN240206-08079E-RF Tester:Stu Song
Date: 9.APR.2024 14:29:47

5.5 Channel Separation:

Serial No.:	2HP4-1	Test Date:	2024/04/09
Test Site:	RF	Test Mode:	Transmitting
Tester:	Stu Song	Test Result:	Pass

Environmental Conditions:

Temperature: (°C)	24.3	Relative Humidity: (%)	53	ATM Pressure: (kPa)	100.8
-----------------------------	------	----------------------------------	----	-------------------------------	-------

Test Equipment List and Details:

Manufacturer	Description	Model	Serial Number	Calibration Date	Calibration Due Date
R&S	Spectrum Analyzer	FSU 26	200160/026	2023/10/18	2024/10/17
Eastsheep	Coaxial Attenuator	5W-N-JK-6G-10dB	F-08-EM503	2023/09/10	2024/09/09

* Statement of Traceability: Bay Area Compliance Laboratories Corp. (Dongguan) attests that all calibrations have been performed, traceable to National Primary Standards and International System of Units (SI).

Test Data:

Mode	Value (MHz)	Limit (MHz)	Result
GFSK_Low	1.001	0.633	Pass
GFSK_Middle	1.001	0.633	Pass
GFSK_High	1.004	0.629	Pass
$\pi/4$ -DQPSK_Low	1.001	0.873	Pass
$\pi/4$ -DQPSK_Middle	1.004	0.871	Pass
$\pi/4$ -DQPSK_High	1.001	0.873	Pass
8DPSK_Low	1.004	0.855	Pass
8DPSK_Middle	1.004	0.855	Pass
8DPSK_High	1.001	0.855	Pass

BDR

GFSK_Low

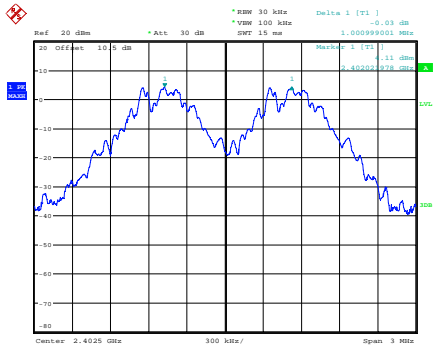

ProjectNo.:XMDN240206-08079E-RP Tester:Stu Song
Date: 9.APR.2024 14:36:30

GFSK_Middle

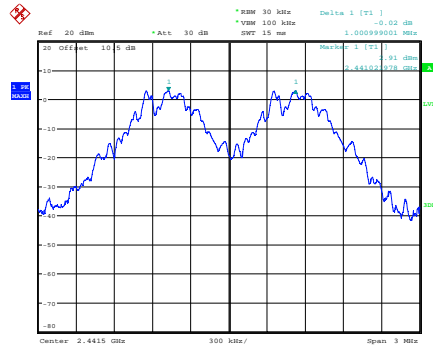

ProjectNo.:XMDN240206-08079E-RP Tester:Stu Song
Date: 9.APR.2024 14:38:21

EDR

GFSK_High

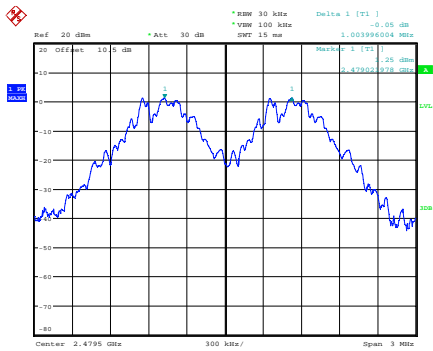

ProjectNo.:XMDN240206-08079E-RP Tester:Stu Song
Date: 9.APR.2024 14:40:48

$\pi/4$ -DQPSK_Low

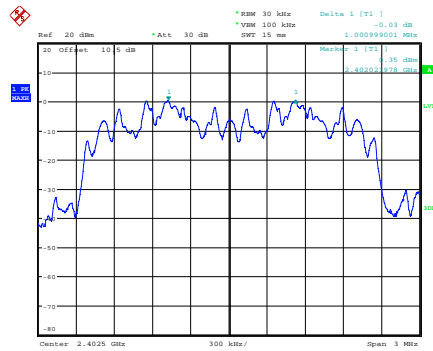

ProjectNo.:XMDN240206-08079E-RP Tester:Stu Song
Date: 9.APR.2024 14:44:37

$\pi/4$ -DQPSK_Middle

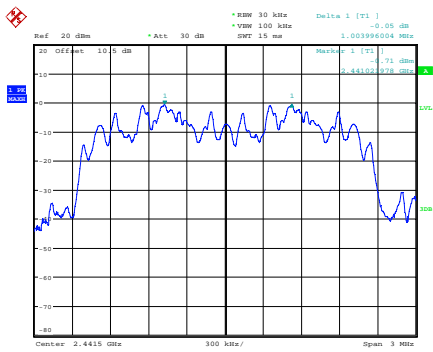

ProjectNo.:XMDN240206-08079E-RP Tester:Stu Song
Date: 9.APR.2024 14:46:34

$\pi/4$ -DQPSK_High

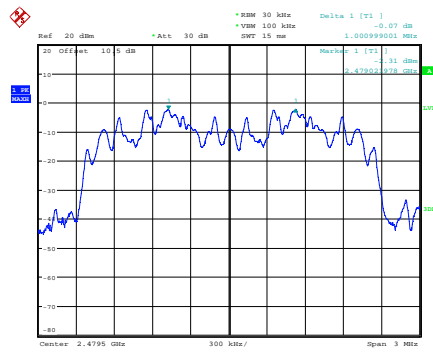

ProjectNo.:XMDN240206-08079E-RP Tester:Stu Song
Date: 9.APR.2024 14:48:33

8DPSK_Low

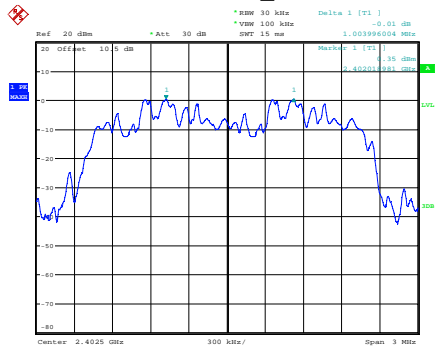

ProjectNo.:XMDN240206-08079E-RF Tester:Stu Song
Date: 9.APR.2024 14:50:23

8DPSK_Middle

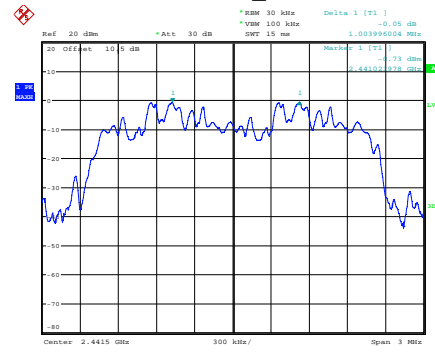

ProjectNo.:XMDN240206-08079E-RF Tester:Stu Song
Date: 9.APR.2024 14:52:03

8DPSK_High

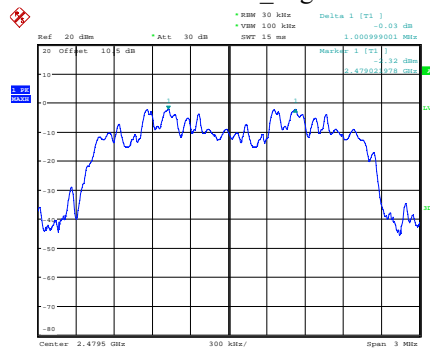

ProjectNo.:XMDN240206-08079E-RF Tester:Stu Song
Date: 9.APR.2024 14:54:07

5.6 Number Of Hopping Frequency:

Serial No.:	2HP4-1	Test Date:	2024/04/09
Test Site:	RF	Test Mode:	Transmitting
Tester:	Stu Song	Test Result:	Pass

Environmental Conditions:

Temperature: (°C)	24.3	Relative Humidity: (%)	53	ATM Pressure: (kPa)	100.8
-----------------------------	------	----------------------------------	----	-------------------------------	-------

Test Equipment List and Details:

Manufacturer	Description	Model	Serial Number	Calibration Date	Calibration Due Date
R&S	Spectrum Analyzer	FSU 26	200160/026	2023/10/18	2024/10/17
Eastsheep	Coaxial Attenuator	5W-N-JK-6G-10dB	F-08-EM503	2023/09/10	2024/09/09

* Statement of Traceability: Bay Area Compliance Laboratories Corp. (Dongguan) attests that all calibrations have been performed, traceable to National Primary Standards and International System of Units (SI).

Test Data:

Mode	Value	Limit	Result
GFSK_Hopping	79	15	Pass
$\pi/4$ -DQPSK_Hopping	79	15	Pass
8DPSK_Hopping	79	15	Pass

BDR

GFSK_Hopping

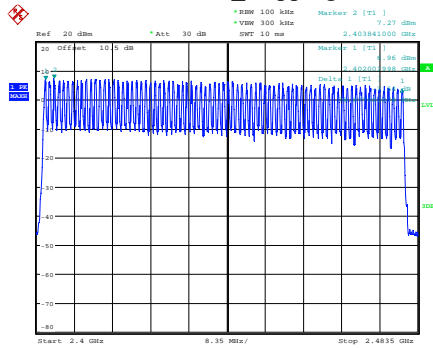

ProjectNo.:XMDN240206-08079E-RP Tester:Stu Song
Date: 9.APR.2024 15:00:27

EDR

$\pi/4$ -DQPSK_Hopping

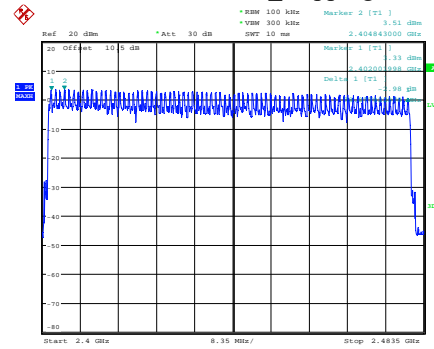

ProjectNo.:XMDN240206-08079E-RP Tester:Stu Song
Date: 9.APR.2024 15:10:17

8DPSK_Hopping

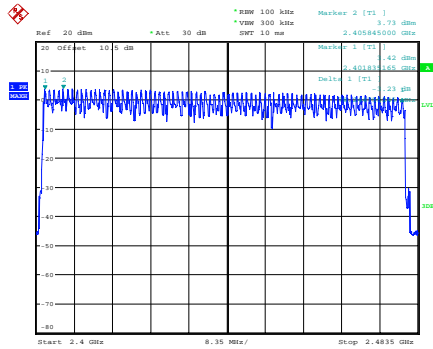

ProjectNo.:XMDN240206-08079E-RP Tester:Stu Song
Date: 9.APR.2024 15:20:34

4.7 Time Of Occupancy(Dwell Time):

Serial No.:	2HP4-1	Test Date:	2024/04/09
Test Site:	RF	Test Mode:	Transmitting
Tester:	Stu Song	Test Result:	Pass

Environmental Conditions:

Temperature: (°C)	24.3	Relative Humidity: (%)	53	ATM Pressure: (kPa)	100.8
-----------------------------	------	----------------------------------	----	-------------------------------	-------

Test Equipment List and Details:

Manufacturer	Description	Model	Serial Number	Calibration Date	Calibration Due Date
R&S	Spectrum Analyzer	FSU 26	200160/026	2023/10/18	2024/10/17
Eastsheep	Coaxial Attenuator	5W-N-JK-6G-10dB	F-08-EM503	2023/09/10	2024/09/09

* Statement of Traceability: Bay Area Compliance Laboratories Corp. (Dongguan) attests that all calibrations have been performed, traceable to National Primary Standards and International System of Units (SI).

Test Data:

Mode	Pulse width (ms)	Dwell time (s)	Limit (s)	Result
GFSK_Hopping_DH1	0.374	0.120	0.400	Pass
GFSK_Hopping_DH3	1.277	0.204	0.400	Pass
GFSK_Hopping_DH5	2.912	0.311	0.400	Pass
π/4-DQPSK_Hopping_2DH1	0.385	0.123	0.400	Pass
π/4-DQPSK_Hopping_2DH3	1.645	0.263	0.400	Pass
π/4-DQPSK_Hopping_2DH5	2.917	0.311	0.400	Pass
8DPSK_Hopping_3DH1	0.385	0.123	0.400	Pass
8DPSK_Hopping_3DH3	1.642	0.263	0.400	Pass
8DPSK_Hopping_3DH5	2.917	0.311	0.400	Pass

Note:

- DH1:Dwell time=Pulse time (ms) × (1600/2/79) ×31.6 s
- DH3:Dwell time=Pulse time (ms) × (1600/4/79) ×31.6 s
- DH5:Dwell time=Pulse time (ms) × (1600/6/79) ×31.6 s
- 2DH1: Dwell time=Pulse time (ms) × (1600/2/79) ×31.6 s
- 2DH3: Dwell time=Pulse time (ms) × (1600/4/79) ×31.6 s
- 2DH5: Dwell time=Pulse time (ms) × (1600/6/79) ×31.6 s
- 3DH1: Dwell time=Pulse time (ms) × (1600/2/79) ×31.6 s
- 3DH3: Dwell time=Pulse time (ms) × (1600/4/79) ×31.6 s
- 3DH5: Dwell time=Pulse time (ms) × (1600/6/79) ×31.6 s

BDR

GFSK_Hopping_DH1

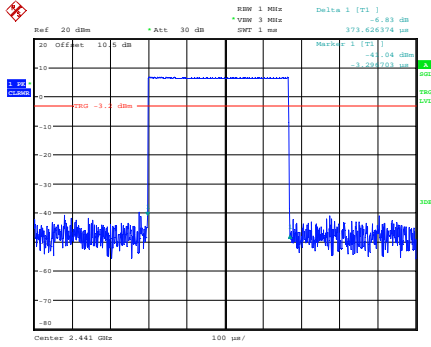

ProjectNo.:XMDN240206-08079E-RF Tester:Stu Song
Date: 9.APR.2024 15:26:01

GFSK_Hopping_DH3

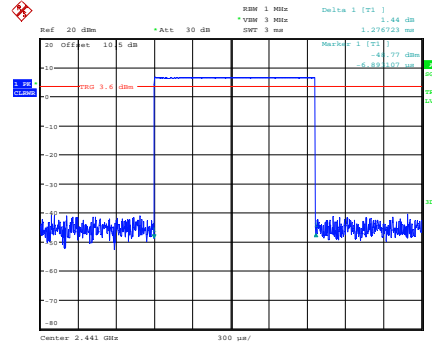

ProjectNo.:XMDN240206-08079E-RF Tester:Stu Song
Date: 9.APR.2024 15:27:20

EDR

GFSK_Hopping_DH5

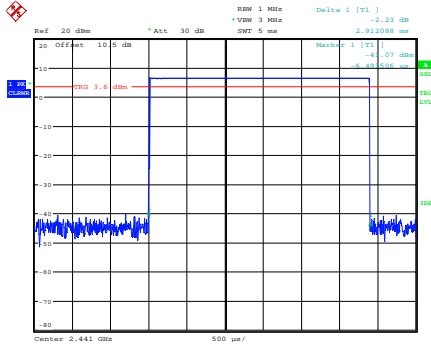

ProjectNo.:XMDN240206-08079E-RF Tester:Stu Song
Date: 9.APR.2024 15:28:24

$\pi/4$ -DQPSK_Hopping_2DH1

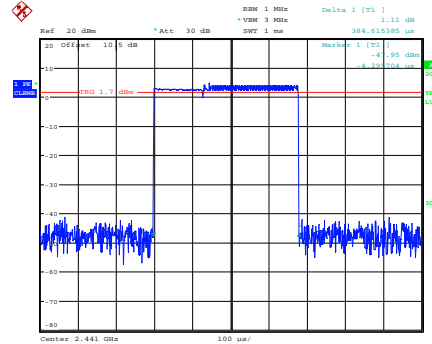

ProjectNo.:XMDN240206-08079E-RF Tester:Stu Song
Date: 9.APR.2024 15:29:19

$\pi/4$ -DQPSK_Hopping_2DH3

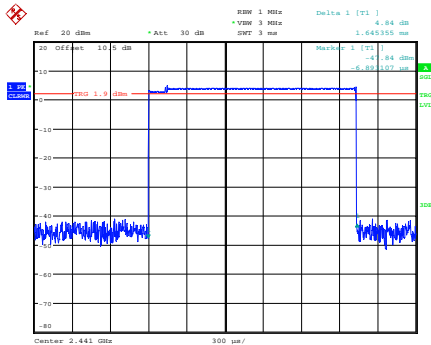

ProjectNo.:XMDN240206-08079E-RF Tester:Stu Song
Date: 9.APR.2024 15:30:17

$\pi/4$ -DQPSK_Hopping_2DH5

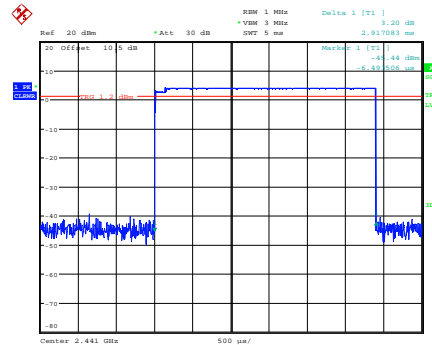

ProjectNo.:XMDN240206-08079E-RF Tester:Stu Song
Date: 9.APR.2024 15:31:33

8DPSK_Hopping_3DH1

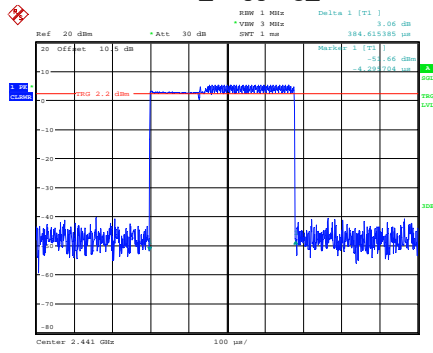

ProjectNo.:XMDN240206-08079E-RF Tester:Stu Song
Date: 9.APR.2024 15:32:34

8DPSK_Hopping_3DH3

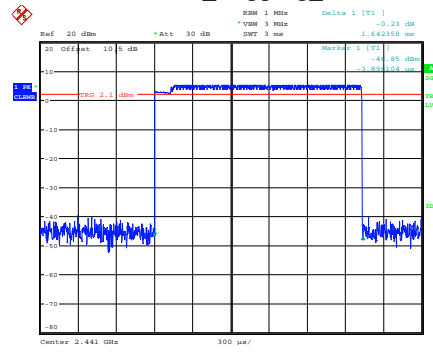

ProjectNo.:XMDN240206-08079E-RF Tester:Stu Song
Date: 9.APR.2024 15:33:13

8DPSK_Hopping_3DH5

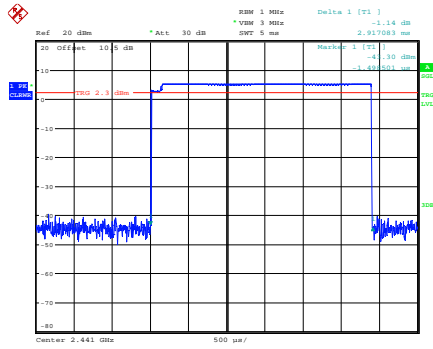

ProjectNo.:XMDN240206-08079E-RF Tester:Stu Song
Date: 9.APR.2024 15:35:32

5.8 Maximum Conducted Output Power:

Serial No.:	2HP4-1	Test Date:	2024/04/09
Test Site:	RF	Test Mode:	Transmitting
Tester:	Stu Song	Test Result:	Pass

Environmental Conditions:

Temperature: (°C)	24.3	Relative Humidity: (%)	53	ATM Pressure: (kPa)	100.8
-----------------------------	------	----------------------------------	----	-------------------------------	-------

Test Equipment List and Details:

Manufacturer	Description	Model	Serial Number	Calibration Date	Calibration Due Date
R&S	Spectrum Analyzer	FSU 26	200160/026	2023/10/18	2024/10/17
Eastsheep	Coaxial Attenuator	5W-N-JK-6G-10dB	F-08-EM503	2023/09/10	2024/09/09

* Statement of Traceability: Bay Area Compliance Laboratories Corp. (Dongguan) attests that all calibrations have been performed, traceable to National Primary Standards and International System of Units (SI).

Test Data:

Mode	Value (dBm)	Limit (dBm)	Result
GFSK_Low	8.42	21.00	Pass
GFSK_Middle	7.28	21.00	Pass
GFSK_High	5.64	21.00	Pass
$\pi/4$ -DQPSK_Low	6.58	21.00	Pass
$\pi/4$ -DQPSK_Middle	5.44	21.00	Pass
$\pi/4$ -DQPSK_High	3.77	21.00	Pass
8DPSK_Low	7.12	21.00	Pass
8DPSK_Middle	5.95	21.00	Pass
8DPSK_High	4.27	21.00	Pass
Maximum EIRP: (dBm)	14.15	EIRP Limit: (dBm)	36.00

GFSK_Low

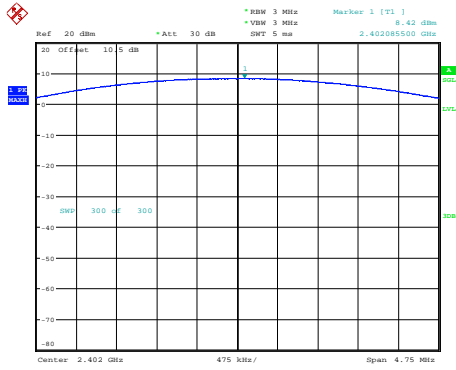

ProjectNo.: XMDN240206-08079E-RF Tester:Stu Song
Date: 9.APR.2024 13:55:42

GFSK_Middle

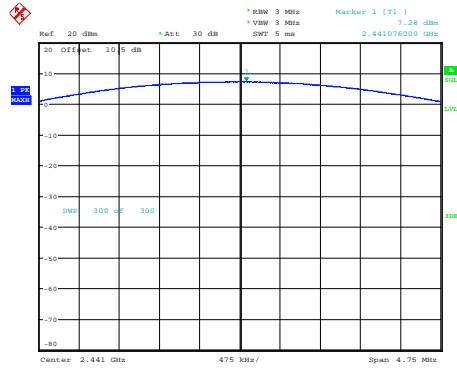

ProjectNo.: XMDN240206-08079E-RF Tester:Stu Song
Date: 9.APR.2024 13:58:01

GFSK_High

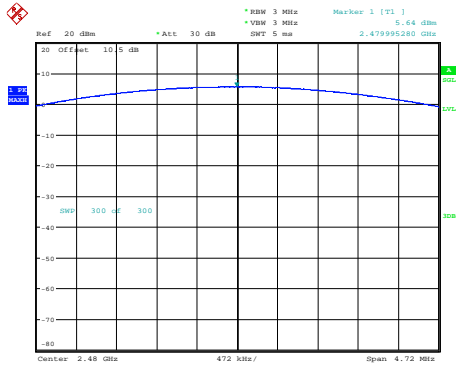

ProjectNo.: XMDN240206-08079E-RF Tester:Stu Song
Date: 9.APR.2024 14:00:21

$\pi/4$ -DQPSK_Low

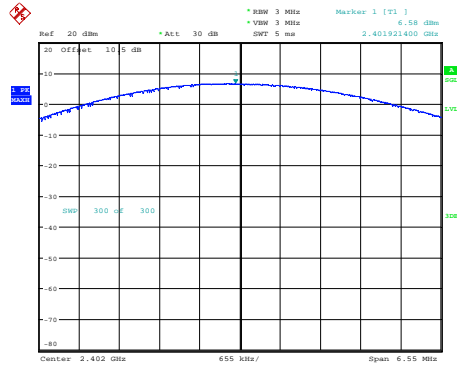

ProjectNo.: XMDN240206-08079E-RF Tester:Stu Song
Date: 9.APR.2024 14:18:14

$\pi/4$ -DQPSK_Middle

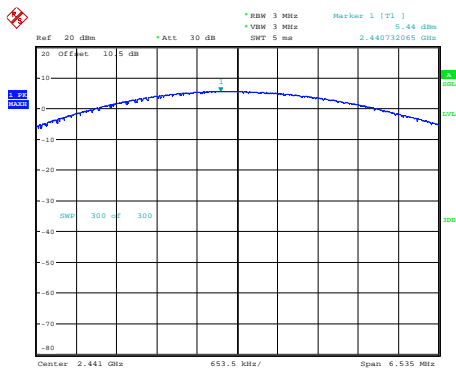

ProjectNo.: XMDN240206-08079E-RF Tester:Stu Song
Date: 9.APR.2024 14:20:42

$\pi/4$ -DQPSK_High

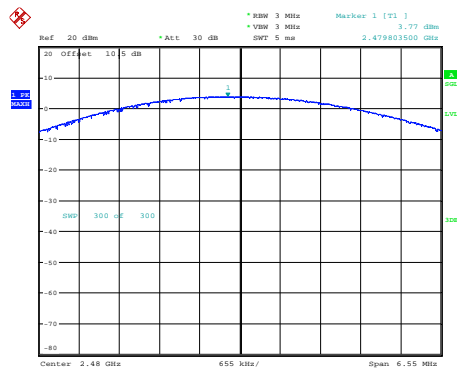

ProjectNo.: XMDN240206-08079E-RF Tester:Stu Song
Date: 9.APR.2024 14:23:00

8DPSK_Low

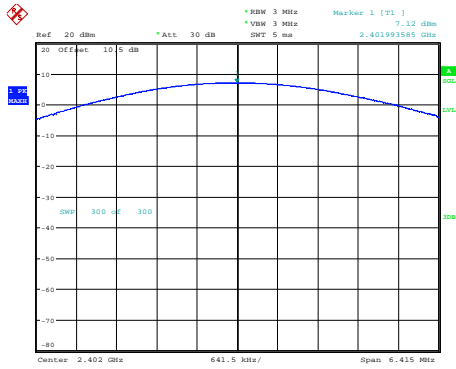

ProjectNo.:XMDN240206-08079E-RF Tester:Stu Song
Date: 9.APR.2024 14:25:26

8DPSK_Middle

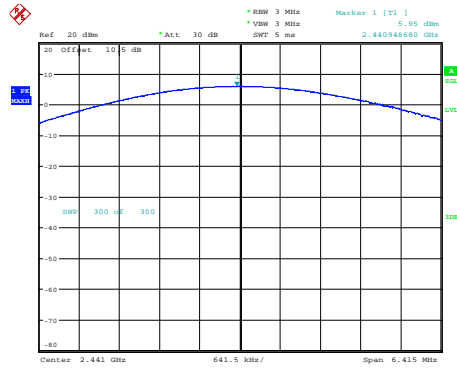

ProjectNo.:XMDN240206-08079E-RF Tester:Stu Song
Date: 9.APR.2024 14:27:46

8DPSK_High

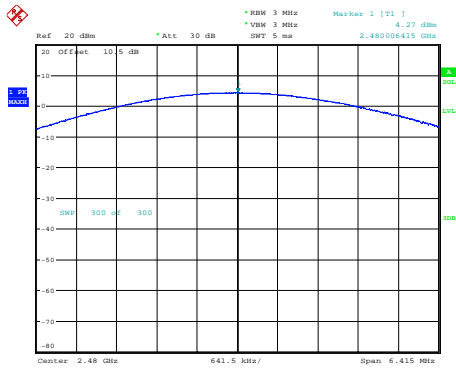

ProjectNo.:XMDN240206-08079E-RF Tester:Stu Song
Date: 9.APR.2024 14:34:12

5.9 100 kHz Bandwidth of Frequency Band Edge:**Test Information:**

Serial No.:	2HP4-1	Test Date:	2024/04/09
Test Site:	RF	Test Mode:	Transmitting
Tester:	Stu Song	Test Result:	Pass

Environmental Conditions:

Temperature: (°C)	24.3	Relative Humidity: (%)	53	ATM Pressure: (kPa)	100.8
-----------------------------	------	----------------------------------	----	-------------------------------	-------

Test Equipment List and Details:

Manufacturer	Description	Model	Serial Number	Calibration Date	Calibration Due Date
R&S	Spectrum Analyzer	FSU 26	200160/026	2023/10/18	2024/10/17
Eastsheep	Coaxial Attenuator	5W-N-JK-6G-10dB	F-08-EM503	2023/09/10	2024/09/09

* *Statement of Traceability: Bay Area Compliance Laboratories Corp. (Dongguan) attests that all calibrations have been performed, traceable to National Primary Standards and International System of Units (SI).*

Test Data:

Please refer to the below plots:

GFSK_Low

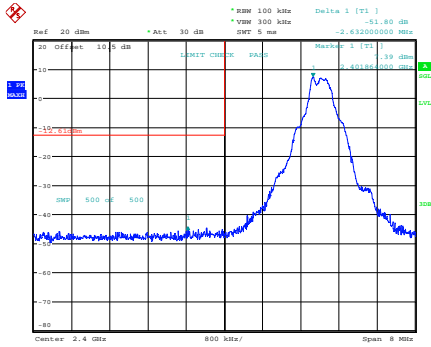

ProjectNo.: XMDN240206-08079E-RF Tester:Stu Song
Date: 9.APR.2024 15:37:18

GFSK_High

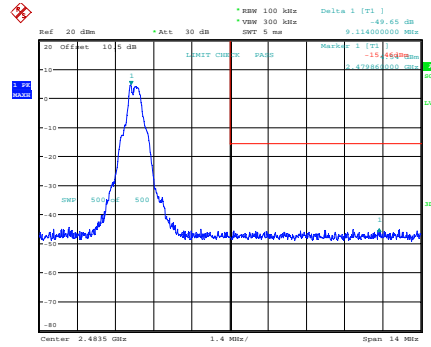

ProjectNo.: XMDN240206-08079E-RF Tester:Stu Song
Date: 9.APR.2024 15:38:23

GFSK_Hopping_Lower

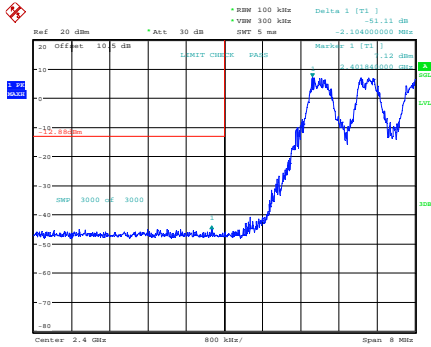

ProjectNo.: XMDN240206-08079E-RF Tester:Stu Song
Date: 9.APR.2024 15:47:29

GFSK_Hopping_Upper

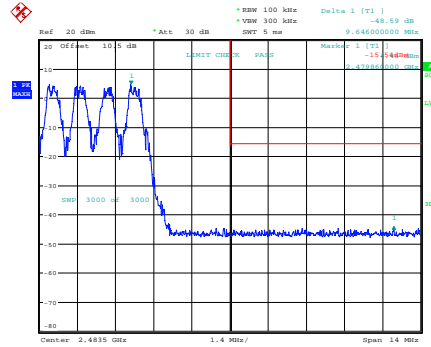

ProjectNo.: XMDN240206-08079E-RF Tester:Stu Song
Date: 9.APR.2024 15:51:13

$\pi/4$ -DQPSK_Low

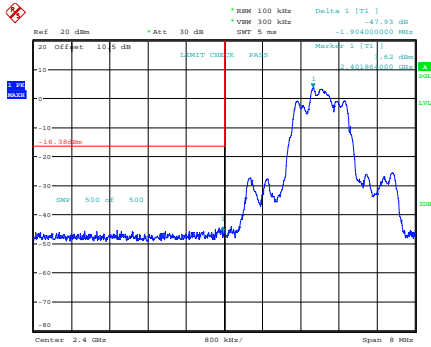

ProjectNo.: XMDN240206-08079E-RF Tester:Stu Song
Date: 9.APR.2024 15:43:53

$\pi/4$ -DQPSK_High

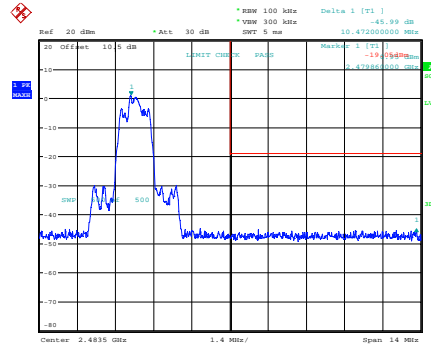

ProjectNo.: XMDN240206-08079E-RF Tester:Stu Song
Date: 9.APR.2024 15:40:32

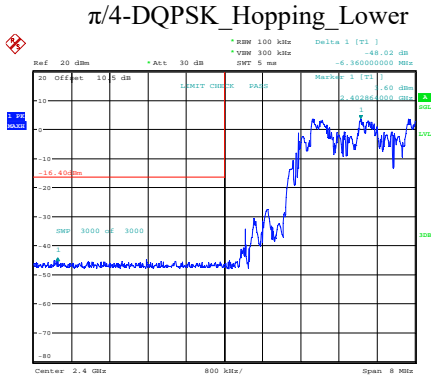

ProjectNo.:XMDN240206-08079E-RF Tester:Stu Song
Date: 9.APR.2024 16:09:16

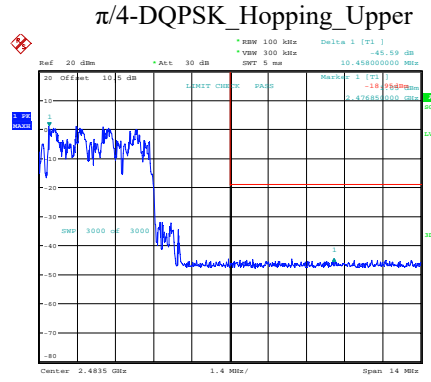

ProjectNo.:XMDN240206-08079E-RF Tester:Stu Song
Date: 9.APR.2024 16:13:14

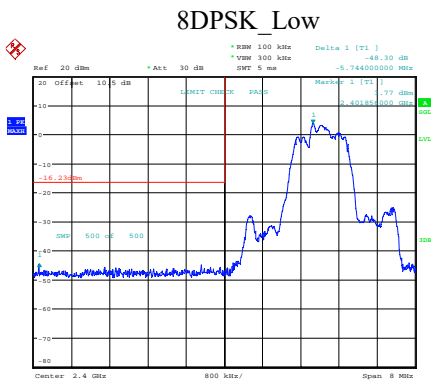

ProjectNo.:XMDN240206-08079E-RF Tester:Stu Song
Date: 9.APR.2024 15:41:29

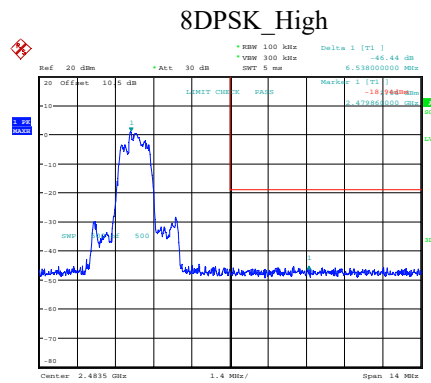

ProjectNo.:XMDN240206-08079E-RF Tester:Stu Song
Date: 9.APR.2024 15:42:35

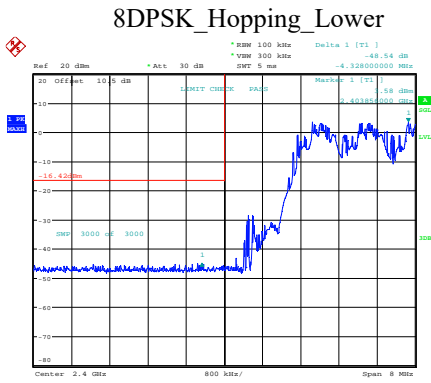

ProjectNo.:XMDN240206-08079E-RF Tester:Stu Song
Date: 9.APR.2024 16:16:11

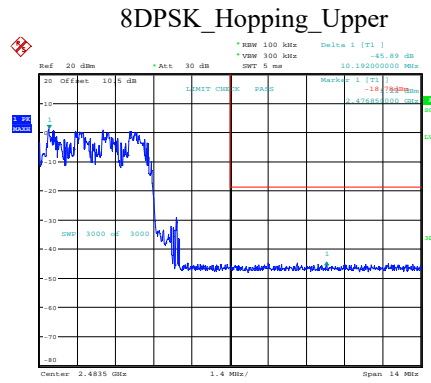

ProjectNo.:XMDN240206-08079E-RF Tester:Stu Song
Date: 9.APR.2024 16:21:04

APPENDIX A - EUT PHOTOGRAPHS

Please refer to the attachment XMDN240206-08079E-RF-EXP EUT external photographs and XMDN240206-08079E-RF-INP EUT internal photographs.

APPENDIX B - TEST SETUP PHOTOGRAPHS

Please refer to the attachment XMDN240206-08079E-RF-00E-TSP test setup photographs.

APPENDIX C - RF EXPOSURE EVALUATION

Maximum Permissible Exposure (MPE)

Applicable Standard

According to subpart §1.1310, systems operating under the provisions of this section shall be operated in a manner that ensures that the public is not exposed to radio frequency energy level in excess of the Commission’s guidelines.

Limits for Maximum Permissible Exposure (MPE) (§1.1310, §2.1091)

(B) Limits for General Population/Uncontrolled Exposure				
Frequency Range (MHz)	Electric Field Strength (V/m)	Magnetic Field Strength (A/m)	Power Density (mW/cm²)	Averaging Time (minutes)
0.3–1.34	614	1.63	*(100)	30
1.34–30	824/f	2.19/f	*(180/f ²)	30
30–300	27.5	0.073	0.2	30
300–1500	/	/	f/1500	30
1500–100,000	/	/	1.0	30

f = frequency in MHz; * = Plane-wave equivalent power density;

According to §1.1310 and §2.1091 RF exposure is calculated.

Calculation formula:

Prediction of power density at the distance of the applicable MPE limit

$S = PG/4\pi R^2$ = power density (in appropriate units, e.g. mW/cm²);

P = power input to the antenna (in appropriate units, e.g., mW);

G = power gain of the antenna in the direction of interest relative to an isotropic radiator, the power gain factor, is normally numeric gain;

R = distance to the center of radiation of the antenna (appropriate units, e.g., cm);

For simultaneously transmit system, the calculated power density should comply with:

$$\sum_i \frac{S_i}{S_{Limit,i}} \leq 1$$

Calculated Data:

Operation Modes	Frequency (MHz)	Antenna Gain		Conducted output power including Tune-up Tolerance		Evaluation Distance (cm)	Power Density (mW/cm ²)	MPE Limit (mW/cm ²)
		(dBi)	(numeric)	(dBm)	(mW)			
WiFi 2.4G	2412-2462	5.73	3.74	24	251.18864	20.00	0.1870	1.0
WiFi 5.2G	5150-5250	4.21	2.64	13	19.95	20.00	0.0105	1.0
WiFi 5.3G	5250-5350	4.21	2.64	12	15.85	20.00	0.0083	1.0
WiFi 5.6G	5470-5725	6.45	4.42	12	15.85	20.00	0.0139	1.0
WiFi 5.8G	5725-5850	5.65	3.67	13	19.95	20.00	0.0146	1.0
Bluetooth	2402-2480	5.73	3.74	9	7.94	20.00	0.0059	1.0
BLE	2402-2480	5.73	3.74	9	7.94	20.00	0.0059	1.0
NFC	13.56	/	/	-44.28	0.00004	20.00	<<0.0001	0.98
NFC field strength is 50.92BμV/m @ 3m = -44.28 dBm(0.00004mW) EIRP. That equal to antenna gain is 0dBi and used the EIRP value as conducted power.								

Note: The Conducted output power including Tune-up Tolerance provided by manufacturer

Simultaneous transmission:

BT, BLE, WiFi can't transmit simultaneously. WiFi/BLE/Bluetooth and NFC can transmit simultaneously:

$$S_{BLE}/S_{limit-BLE} + S_{NFC}/S_{limit-NFC}$$

$$=0.187/1+0.0001/0.98$$

$$=0.187$$

$$< 1.0$$

Result: The device meet FCC MPE at 20 cm distance

Exemption Limits For Routine Evaluation-RF Exposure Evaluation

Applicable Standard

According to RSS-102 § (2.5.2):

RF exposure evaluation is required if the separation distance between the user and/or bystander and the device's radiating element is greater than 20 cm, except when the device operates as follows:

- below 20 MHz and the source-based, time-averaged maximum e.i.r.p. of the device is equal to or less than 1 W (adjusted for tune-up tolerance);
- at or above 20 MHz and below 48 MHz and the source-based, time-averaged maximum e.i.r.p. of the device is equal to or less than $4.49/f^{0.5}$ W (adjusted for tune-up tolerance), where f is in MHz;
- at or above 48 MHz and below 300 MHz and the source-based, time-averaged maximum e.i.r.p. of the device is equal to or less than 0.6 W (adjusted for tune-up tolerance);
- at or above 300 MHz and below 6 GHz and the source-based, time-averaged maximum e.i.r.p. of the device is equal to or less than $1.31 \times 10^{-2} f^{0.6834}$ W (adjusted for tune-up tolerance), where f is in MHz;
- at or above 6 GHz and the source-based, time-averaged maximum e.i.r.p. of the device is equal to or less than 5 W (adjusted for tune-up tolerance).

In these cases, the information contained in the RF exposure technical brief may be limited to information that demonstrates how the e.i.r.p. was derived.

Calculated Data:

Mode	Frequency (MHz)	Antenna Gain	Conducted output power including Tune-up Tolerance	EIRP		Exemption limits (mW)
		(dBi)	(dBm)	(dBm)	(mW)	
WiFi 2.4G	2412-2462	5.73	24	29.73	939.72	2684
WiFi 5.2G	5150-5250	4.21	13	17.21	52.60	4507
WiFi 5.3G	5250-5350	4.21	12	16.21	41.78	4567
WiFi 5.6G	5470-5725	6.45	12	18.45	69.98	4697
WiFi 5.8G	5725-5850	5.65	13	18.65	73.28	4845
Bluetooth	2402-2480	5.73	9	14.73	29.72	2676
BLE	2402-2480	5.73	9	14.73	29.72	2676
NFC	13.56	/	/	-44.28	0.00004	1000

NFC field strength is 50.92BμV/m @ 3m = -44.28 dBm(0.00004mW) EIRP. That equal to antenna gain is 0dBi and used the EIRP value as conducted power.

Note:

1. The Conducted output power including Tune-up Tolerance was provided by manufacturer.
2. BT, BLE, WiFi can't transmit simultaneously. WiFi/BLE/Bluetooth and NFC can transmit simultaneously.

Result: Compliant, the device is compliance exemption from Routine Evaluation Limits –RF exposure Evaluation.

***** END OF REPORT *****