

TEST REPORT

Applicant: Fujian LANDI Commercial Equipment Co.,Ltd.

FCC: Building 17, Section A, Software Park, No. 89 Software Road, Gulou District, Fuzhou Municipality, Fujian Province, China

Address: IC: Building 17, Section A, Software Park, No. 89 Software Road, Gulou District, Fuzhou Municipality, Fujian Province, P.R. 350003 China

Product Name: POS Terminal

FCC ID: 2AG6N-C20SEN

IC: 23725-C20SEN

HVIN: C20SEDN

Standard(s): 47 CFR Part 15, Subpart E(15.407)
RSS-247 Issue 3, August 2023
RSS-Gen, Issue 5, February 2021 Amendment 2
ANSI C63.10-2013
KDB 789033 D02 General U-NII Test Procedures New Rules v02r01

Report Number: XMDN240206-08079E-RF-00F

Report Date: 2024/4/13

The above device has been tested and found compliant with the requirement of the relative standards by Bay Area Compliance Laboratories Corp. (Dongguan).



Reviewed By: Gavin Xu
Title: RF Engineer



Approved By: Ivan Cao
Title: EMC Manager

Bay Area Compliance Laboratories Corp. (Dongguan)
No.12, Pulong East 1st Road, Tangxia Town, Dongguan, Guangdong, China

Tel: +86-769-86858888

Fax: +86-769-86858891

www.baclcorp.com.cn

Note: The information marked ▲ is provided by the applicant, the laboratory is not responsible for its authenticity and this information can affect the validity of the result in the test report. Unless otherwise stated the results shown in this test report refer only to the sample(s) tested. This report cannot be reproduced except in full, without prior written approval of the Company. This report is valid only with a valid digital signature. The digital signature may be available only under the Adobe software above version 7.0. This report may contain data that are not covered by the accreditation scope and shall be marked with ★. This report must not be used by the client to claim product certification, approval, or endorsement by NVLAP, NIST, or any agency of the U.S. Government.

CONTENTS

DOCUMENT REVISION HISTORY	4
1. GENERAL INFORMATION	5
1.1 PRODUCT DESCRIPTION FOR EQUIPMENT UNDER TEST (EUT)	5
1.2 ACCESSORY INFORMATION	5
1.3 ANTENNA INFORMATION DETAIL▲	6
1.4 EQUIPMENT MODIFICATIONS	6
2. SUMMARY OF TEST RESULTS	7
3. DESCRIPTION OF TEST CONFIGURATION	8
3.1 OPERATION FREQUENCY DETAIL	8
3.2 EUT OPERATION CONDITION	9
3.3 SUPPORT EQUIPMENT LIST AND DETAILS	10
3.4 SUPPORT CABLE LIST AND DETAILS	10
3.5 BLOCK DIAGRAM OF TEST SETUP	11
3.6 TEST FACILITY	12
3.7 MEASUREMENT UNCERTAINTY	12
4. REQUIREMENTS AND TEST PROCEDURES	13
4.1 AC LINE CONDUCTED EMISSIONS	13
4.1.1 Applicable Standard	13
4.1.2 EUT Setup	15
4.1.3 EMI Test Receiver Setup	15
4.1.4 Test Procedure	16
4.1.5 Corrected Amplitude & Margin Calculation	16
4.1.6 Test Result	16
4.2 RADIATION SPURIOUS EMISSIONS	17
4.2.1 Applicable Standard	17
4.2.2 EUT Setup	19
4.2.3 EMI Test Receiver & Spectrum Analyzer Setup	20
4.2.4 Test Procedure	21
4.2.5 Corrected Result & Margin Calculation	21
4.2.6 Test Result	21
4.3 26DB ATTENUATED BELOW THE CHANNEL POWER	22
4.3.1 Applicable Standard	22
4.3.2 EUT Setup	22
4.3.3 Test Procedure	22
4.3.4 Test Result	22
4.4 EMISSION BANDWIDTH	23
4.4.1 Applicable Standard	23
4.4.2 EUT Setup	24
4.4.3 Test Procedure	24
4.4.4 Test Result	25
4.5 MAXIMUM CONDUCTED OUTPUT POWER	26

4.5.1 Applicable Standard 26

4.5.2 EUT Setup 27

4.5.3 Test Procedure 27

4.5.4 Test Result 27

4.6 MAXIMUM POWER SPECTRAL DENSITY 28

4.6.1 Applicable Standard 28

4.6.2 EUT Setup 29

4.6.3 Test Procedure 29

4.6.4 Test Result 29

4.7 DUTY CYCLE 30

4.7.1 EUT Setup 30

4.7.2 Test Procedure 30

4.7.3 Judgment 30

4.8 ANTENNA REQUIREMENT 31

4.8.1 Applicable Standard 31

4.8.2 Judgment 31

4.9 ADDITIONAL REQUIREMENT 32

4.9.1 Applicable Standard 32

4.9.2 Judgment 33

5. Test DATA AND RESULTS 34

5.1 AC LINE CONDUCTED EMISSIONS 34

5.2 RADIATION SPURIOUS EMISSIONS 37

5.3 26dB ATTENUATED BELOW THE CHANNEL POWER 158

5.4 EMISSION BANDWIDTH 162

5.5 99% OCCUPIED BANDWIDTH 178

5.6 MAXIMUM CONDUCTED OUTPUT POWER 193

5.7 MAXIMUM POWER SPECTRAL DENSITY 197

5.8 DUTY CYCLE 212

APPENDIX A - EUT PHOTOGRAPHS 215

APPENDIX B - TEST SETUP PHOTOGRAPHS 216

APPENDIX C - RF EXPOSURE EVALUATION 217

MAXIMUM PERMISSIBLE EXPOSURE (MPE) 217

Applicable Standard 217

Calculation formula: 217

Calculated Data: 218

EXEMPTION LIMITS FOR ROUTINE EVALUATION-RF EXPOSURE EVALUATION 219

Applicable Standard 219

Calculated Data: 219

DOCUMENT REVISION HISTORY

Revision Number	Report Number	Description of Revision	Date of Revision
1.0	XMDN240206-08079E-RF-00F	Original Report	2024/4/13

1. GENERAL INFORMATION

1.1 Product Description for Equipment under Test (EUT)

EUT Name:	POS Terminal
EUT Model:	C20SE
Operation Frequency:	5150-5250 MHz: 5180-5240 MHz (802.11a/n ht20/ac vht20/ax he20) 5190-5230 MHz(802.11n ht40/ac vht40/ax he40) 5210 MHz(802.11ac vht80/ax he80) 5250-5350MHz: 5260-5320 MHz (802.11a/n ht20/ac vht20/ax he20) 5270-5310 MHz(802.11n ht40/ac vht40/ax he40) 5290 MHz(802.11ac vht80/ax he80) 5470-5725MHz: 5500-5720 MHz (802.11a/n ht20/ac vht20/ax he20) 5510-5710 MHz(802.11n ht40/ac vht40/ax he40) 5530MHz-5690 MHz(802.11ac vht80/ax he80) 5725-5850MHz 5745-5825 MHz (802.11a/n ht20/ac vht20/ax he20) 5755-5795 MHz(802.11n ht40/ac vht40/ax he40) 5775 MHz(802.11ac vht80/ax he80)
Maximum Average Output Power (Conducted):	12.21 dBm(5150-5250 MHz) 11.44 dBm(5250-5350 MHz) 11.06 dBm(5470-5725 MHz) 12.91 dBm(5725-5850 MHz)
Modulation Type:	802.11a/n/ac:OFDM-BPSK, QPSK, 16QAM, 64QAM,256QAM 802.11ax: OFDMA-BPSK, QPSK, 16QAM, 64QAM,256QAM,1024QAM
Rated Input Voltage:	DC 19V from adapter
Serial Number:	2HP4-1(For RF Conducted Test) 2HP4-4(For AC power line conducted emission and Radiated Spurious Emissions Test)
EUT Received Date:	2024/2/8
EUT Received Status:	Good
Note: 5600-5650 MHz was disabled by software in Canada Market.	

1.2 Accessory Information

Accessory Description	Manufacturer	Model	Parameters
Adapter 1#	Unknown	PA-1650-90	Input: AC 100-240V~50/60Hz 1.6A Output: 19V 3.42A

1.3 Antenna Information Detail ▲

Antenna Manufacturer	Antenna Type	input impedance (Ohm)	Frequency Range	Antenna Gain
Shanghai Jesoncom Communication Engineering Co., Ltd	FPC	50	5.15~5.25GHz	4.21 dBi
			5.25~5.35GHz	4.21 dBi
			5.47~5.725GHz	6.45 dBi
			5.725~5.85GHz	5.65 dBi
The design of compliance with §15.203:				
<input checked="" type="checkbox"/> Unit uses a permanently attached antenna.				
<input type="checkbox"/> Unit uses a unique coupling to the intentional radiator.				
<input type="checkbox"/> Unit was professionally installed, and installer shall be responsible for verifying that the correct antenna is employed with the unit.				

1.4 Equipment Modifications

No modifications are made to the EUT during all test items.

2. SUMMARY OF TEST RESULTS

Standard(s) Section	Test Items	Result
§15.207(a) RSS-Gen Clause 8.8	AC line conducted emissions	Compliant
FCC§15.205& §15.209 &§15.407(b) RSS-247 Clause 6.2	Undesirable Emission& Restricted Bands	Compliant
RSS-247 Clause 6.2.1.2	26dB attenuated below the channel power	Compliant
FCC§15.407(a) (e) RSS-247 Clause 6.2 RSS-Gen Clause 6.7	Emission Bandwidth	Compliant
FCC§15.407(a) RSS-247 Clause 6.2	Maximum Conducted Output Power	Compliant
FCC§15.407 (a) RSS-247 Clause 6.2	Power Spectral Density	Compliant
§15.203 RSS-GEN Clause 6.8	Antenna Requirement	Compliant
RSS-247 Clause 6.4	Additional requirements	Compliant
<p>Note 1: For AC line conducted emissions, the maximum output power mode and channel was tested. Note 2: For Radiated Spurious Emissions 9kHz~ 1GHz and 18-40GHz, the maximum output power mode and channel was tested.</p>		

3. DESCRIPTION OF TEST CONFIGURATION

3.1 Operation Frequency Detail

For 802.11a/n ht20/ac vht20/ax he20:

5150-5250MHz Band		5250-5350 MHz Band		5470-5725 MHz Band		5725-5850MHz Band	
Channel	Frequency (MHz)	Channel	Frequency (MHz)	Channel	Frequency (MHz)	Channel	Frequency (MHz)
36	5180	52	5260	100	5500	149	5745
40	5200	56	5280	104	5520	153	5765
44	5220	60	5300	108	5540	157	5785
48	5240	64	5320	112	5560	161	5805
/	/	/	/	116	5580	165	5825
/	/	/	/	120**	5600	/	/
/	/	/	/	124**	5620	/	/
/	/	/	/	128**	5640	/	/
/	/	/	/	132	5660	/	/
/	/	/	/	136	5680	/	/
/	/	/	/	140	5700	/	/
/	/	/	/	143*	5720	/	/

For 802.11n ht40/ac vh40/ax he40:

5150-5250MHz Band		5250-5350 MHz Band		5470-5725 MHz Band		5725-5850MHz Band	
Channel	Frequency (MHz)	Channel	Frequency (MHz)	Channel	Frequency (MHz)	Channel	Frequency (MHz)
38	5190	54	5270	102	5510	151	5755
46	5230	62	5310	110	5550	159	5795
/	/	/	/	118**	5690	/	/
/	/	/	/	126**	5630	/	/
/	/	/	/	134	5670	/	/
/	/	/	/	142*	5710	/	/

For 802.11ac vht80/ax he80:

5150-5250MHz Band		5250-5350 MHz Band		5470-5725 MHz Band		5725-5850MHz Band	
Channel	Frequency (MHz)	Channel	Frequency (MHz)	Channel	Frequency (MHz)	Channel	Frequency (MHz)
42	5210	58	5290	106	5530	155	5775
/	/	/	/	122**	5610	/	/
/	/	/	/	138*	5690	/	/

Note

*: Additional channels cross the band 5470-5725MHz and 5725-5850 MHz, Conducted output power/ Power Spectral Density/bandwidth test with the additional channel to compliance with stricter limit of the two bands(5470-5725MHz more stricter).

** : Those channels in 5600-5650 MHz are disabled by software in Canada Market.

3.2 EUT Operation Condition

The system was configured for testing in Engineering Mode, which was provided by the manufacturer. The EUT configuration is below:

EUT Exercise Software:		CMD			
The software was provided by manufacturer. The maximum power was configured as below, that was provided by the manufacturer ▲:					
5150-5250 MHz Band:					
Test Modes	Data Rate	Power Level Setting			
		Low Channel	Middle Channel	High Channel	
802.11a	6Mbps	16	16	16	
802.11n ht20	MCS0	16	16	16	
802.11n ht40	MCS0	16	/	16	
802.11ac vht80	MCS0	/	16	/	
802.11ax he20	MCS0	16	16	16	
802.11ax he40	MCS0	16	/	16	
802.11ax he80	MCS0	/	16	/	
5250-5350 MHz Band:					
Test Modes	Data Rate	Power Level Setting			
		Low Channel	Middle Channel	High Channel	
802.11a	6Mbps	16	16	16	
802.11n ht20	MCS0	16	16	16	
802.11n ht40	MCS0	16	/	16	
802.11ac vht80	MCS0	/	16	/	
802.11ax he20	MCS0	16	16	16	
802.11ax he40	MCS0	14	/	14	
802.11ax he80	MCS0	/	14	/	
5470-5725 MHz Band:					
Test Modes	Data Rate	Power Level Setting			
		Low Channel	Middle Channel	High Channel	Cross Channel
802.11a	6Mbps	12	15	16	16
802.11n ht20	MCS0	12	15	16	16
802.11n ht40	MCS0	12	13	16	16
802.11ac vht80	MCS0	14	/	17	18
802.11ax he20	MCS0	10	13	14	14
802.11ax he40	MCS0	10	11	14	14
802.11ax he80	MCS0	12	15	/	15
5725-5850 MHz Band:					
Test Modes	Data Rate	Power Level Setting			
		Low Channel	Middle Channel	High Channel	
802.11a	6Mbps	16	16	16	
802.11n ht20	MCS0	16	16	16	
802.11n ht40	MCS0	17	/	17	
802.11ac vht80	MCS0	/	20	/	
802.11ax he20	MCS0	16	16	16	
802.11ax he40	MCS0	17	/	17	
802.11ax he80	MCS0	/	20	/	
Note:					
1. The above are the worst-case data rates, which are determined for each mode based upon investigations by measuring the average power and PSD across all data rates, bandwidths, and modulations.					
2. The system support 802.11a/n ht20/n ht40/ac vht20/ac vht40/ ac vht80/ax he20/ ax he40/ ax he80, the vht20/vht40 were reduced since the identical parameters with 802.11n ht20 /n ht40.					
3. For 802.11ax mode, the device not support partial RU mode.					

3.3 Support Equipment List and Details

Manufacturer	Description	Model	Serial Number
SanDisk	Micro TF Card	UHS-I-16G	9292DVDSV0XZ
Kingston	USB Flash Disk	32G	EMZBUD21103001
SANDisk	USB Flash Disk	16G	BL201026115 B
SANDisk	USB Flash Disk	16G	BL201026331
D-Link	Router	DGS-1100-08PD	S01Z1H000012
PHILIPS	Keyboard	SPK6234	K234210510743
PHILIPS	Mouse	SPK7214	M214BQ210411115
IPRO	Earphone	Phonenix 5.0s	EMZBEP21103002B
Fujian LANDI Commercial Equipment Co.,Ltd.	Cashbox	Unkown	EZ240214F212

3.4 Support Cable List and Details

Cable Description	Shielding Type	Ferrite Core	Length (m)	From Port	To
DC Cable	No	No	1	Adapter	EUT
RJ45 Cable	No	No	3	Router	EUT
USB Cable	No	No	1.5	Keyboard	EUT
USB Cable	No	No	1.5	Mouse	EUT
Earphone Cable	No	No	1	Earphone	EUT
Cashbox Cable	No	No	1	Cashbox	EUT

3.5 Block Diagram of Test Setup

AC power line conducted emissions:

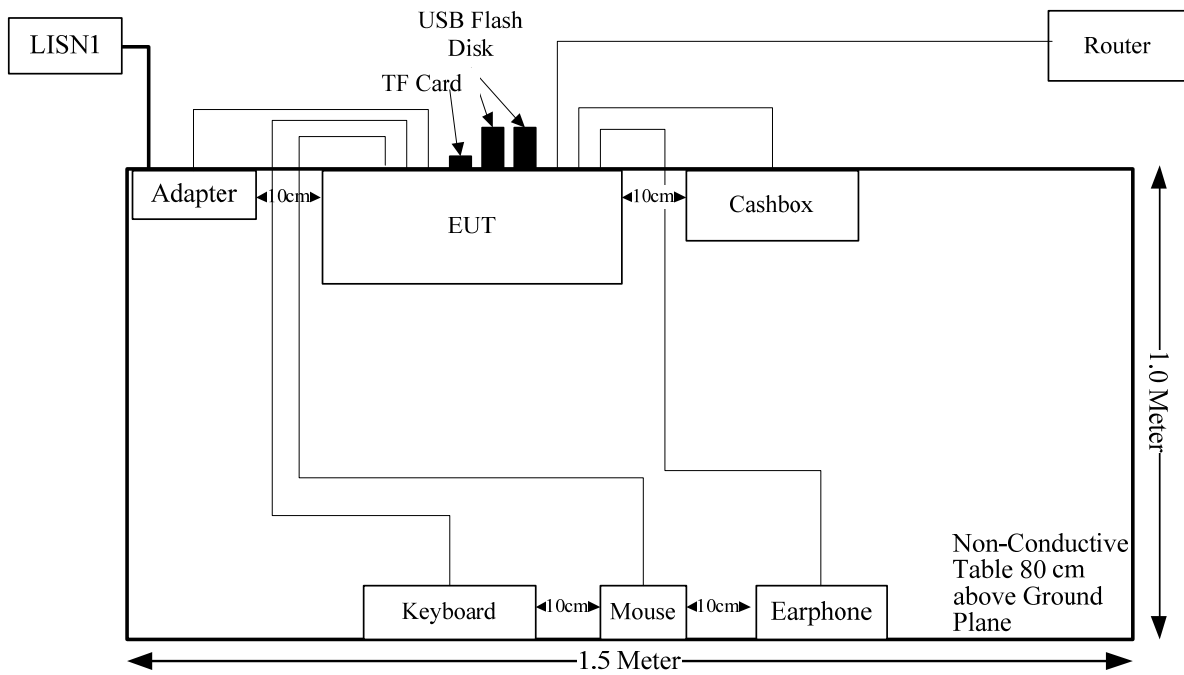

Radiated Spurious Emissions:

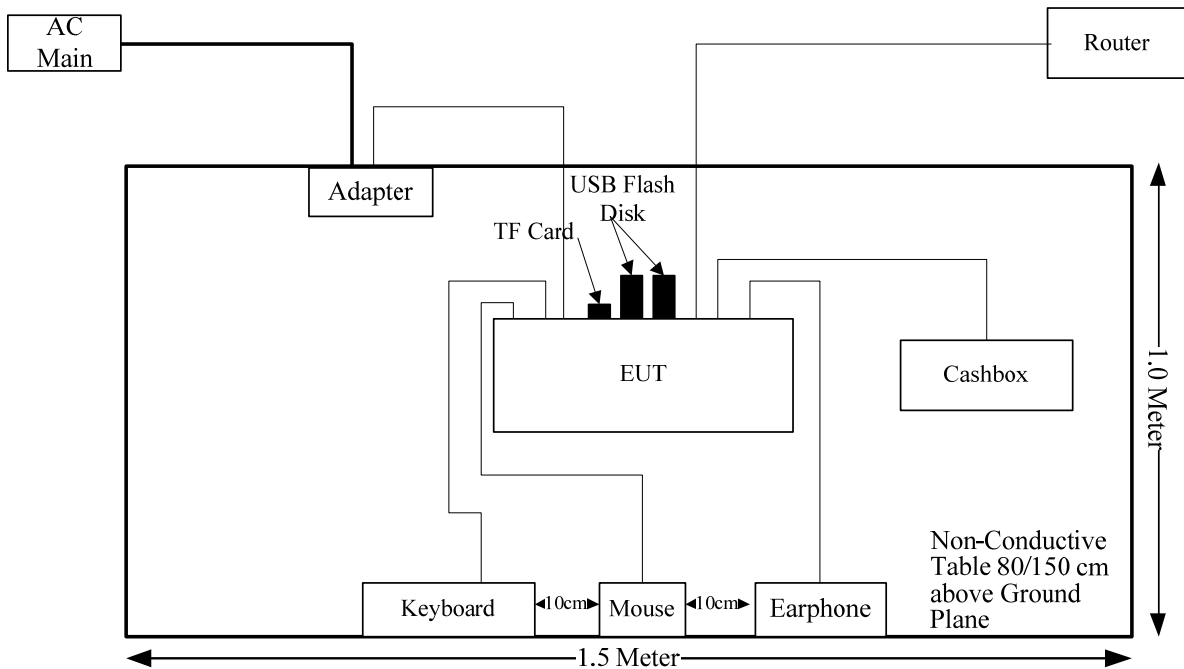

3.6 Test Facility

The Test site used by Bay Area Compliance Laboratories Corp. (Dongguan) to collect test data is located on the No.12, Pulong East 1st Road, Tangxia Town, Dongguan, Guangdong, China.

The lab has been recognized as the FCC accredited lab under the KDB 974614 D01 and is listed in the FCC Public Access Link (PAL) database, FCC Registration No. : 829273, the FCC Designation No. : CN5044.

The lab has been recognized by Innovation, Science and Economic Development Canada to test to Canadian radio equipment requirements, the CAB identifier: CN0022.

3.7 Measurement Uncertainty

Otherwise required by the applicant or Product Regulations, Decision Rule in this report did not consider the uncertainty. The extended uncertainty given in this report is obtained by combining the standard uncertainty times the coverage factor K with the 95% confidence interval.

Parameter	Measurement Uncertainty
Occupied Channel Bandwidth	±5 %
RF output power, conducted	±0.61dB
Power Spectral Density, conducted	±0.61 dB
Unwanted Emissions, radiated	9kHz~30MHz: 3.3dB, 30MHz~200MHz: 4.55 dB, 200MHz~1GHz: 5.92 dB, 1GHz~6GHz: 4.98 dB, 6GHz~18GHz: 5.89 dB, 18GHz~26.5GHz:5.47 dB, 26.5GHz~40GHz:5.63 dB
Unwanted Emissions, conducted	±2.47 dB
Temperature	±1°C
Humidity	±5%
DC and low frequency voltages	±0.4%
Duty Cycle	1%
AC Power Lines Conducted Emission	3.11 dB (150 kHz to 30 MHz)

4. REQUIREMENTS AND TEST PROCEDURES

4.1 AC Line Conducted Emissions

4.1.1 Applicable Standard

FCC§15.207(a).

(a) Except as shown in paragraphs (b) and (c) of this section, for an intentional radiator that is designed to be connected to the public utility (AC) power line, the radio frequency voltage that is conducted back onto the AC power line on any frequency or frequencies, within the band 150 kHz to 30 MHz, shall not exceed the limits in the following table, as measured using a 50 μ H/50 ohms line impedance stabilization network (LISN). Compliance with the provisions of this paragraph shall be based on the measurement of the radio frequency voltage between each power line and ground at the power terminal. The lower limit applies at the boundary between the frequency ranges.

Frequency of emission (MHz)	Conducted limit (dB μ V)	
	Quasi-peak	Average
0.15-0.5	66 to 56*	56 to 46*
0.5-5	56	46
5-30	60	50

*Decreases with the logarithm of the frequency.

(b) The limit shown in paragraph (a) of this section shall not apply to carrier current systems operating as intentional radiators on frequencies below 30 MHz. In lieu thereof, these carrier current systems shall be subject to the following standards:

(1) For carrier current system containing their fundamental emission within the frequency band 535-1705 kHz and intended to be received using a standard AM broadcast receiver: no limit on conducted emissions.

(2) For all other carrier current systems: 1000 μ V within the frequency band 535-1705 kHz, as measured using a 50 μ H/50 ohms LISN.

(3) Carrier current systems operating below 30 MHz are also subject to the radiated emission limits in §15.205, §15.209, §15.221, §15.223, or §15.227, as appropriate.

(c) Measurements to demonstrate compliance with the conducted limits are not required for devices which only employ battery power for operation and which do not operate from the AC power lines or contain provisions for operation while connected to the AC power lines. Devices that include, or make provisions for, the use of battery chargers which permit operating while charging, AC adapters or battery eliminators or that connect to the AC power lines indirectly, obtaining their power through another device which is connected to the AC power lines, shall be tested to demonstrate compliance with the conducted limits.

RSS-Gen Clause 8.8

Unless stated otherwise in the applicable RSS, for radio apparatus that are designed to be connected to the public utility AC power network, the radio frequency voltage that is conducted back onto the AC power line on any frequency or frequencies within the range 150 kHz to 30 MHz shall not exceed the limits in table 4, as measured using a 50 μ H / 50 Ω line impedance stabilization network. This requirement applies for the radio frequency voltage measured between each power line and the ground terminal of each AC power-line mains cable of the EUT. For an EUT that connects to the AC power lines indirectly, through another device, the requirement for compliance with the limits in table 4 shall apply at the terminals of the AC power-line mains cable of a representative support device, while it provides power to the EUT. The lower limit applies at the boundary between the frequency ranges. The device used to power the EUT shall be representative of typical applications.

Table 4 – AC power-line conducted emissions limits

Frequency (MHz)	Conducted limit (dB μ V)	
	Quasi-peak	Average
0.15 - 0.5	66 to 56 ¹	56 to 46 ¹
0.5 – 5	56	46
5 – 30	60	50

Note 1: The level decreases linearly with the logarithm of the frequency.

For an EUT with a permanent or detachable antenna operating between 150 kHz and 30 MHz, the AC power-line conducted emissions must be measured using the following configurations:

- (a) Perform the AC power-line conducted emissions test with the antenna connected to determine compliance with the limits of table 4 outside the transmitter's fundamental emission band.
- (b) Retest with a dummy load instead of the antenna to determine compliance with the limits of table 4 within the transmitter's fundamental emission band. For a detachable antenna, remove the antenna and connect a suitable dummy load to the antenna connector. For a permanent antenna, remove the antenna and terminate the RF output with a dummy load or network that simulates the antenna in the fundamental frequency band.

4.1.2 EUT Setup

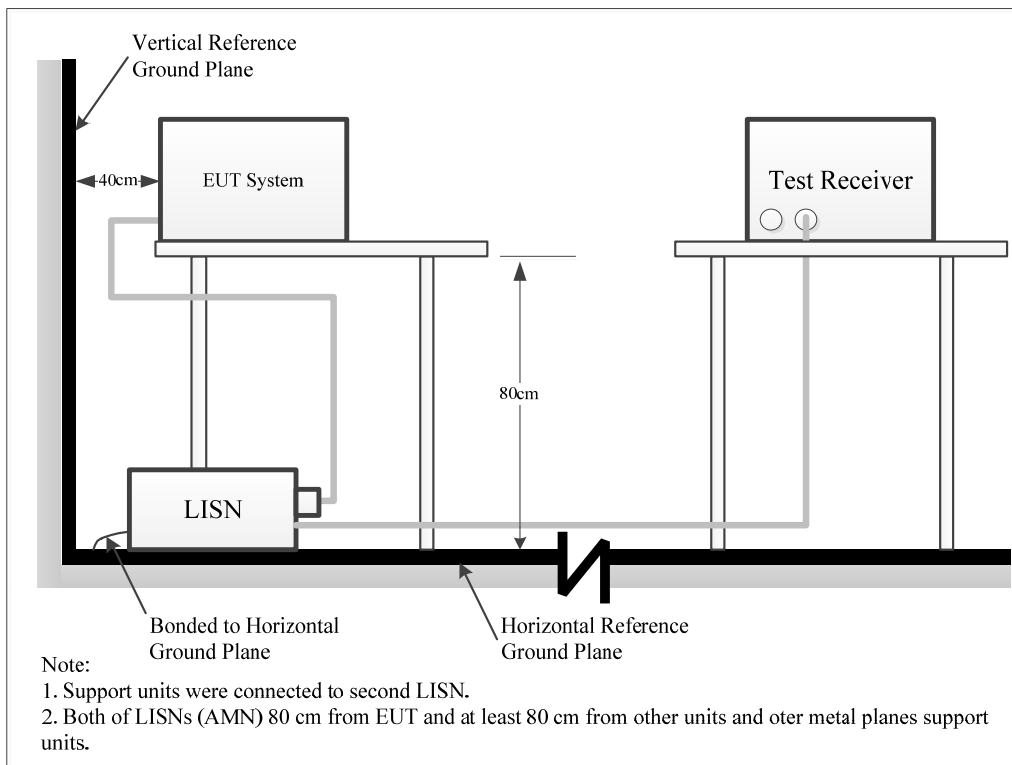

The setup of EUT is according with per ANSI C63.10-2013 measurement procedure. The specification used was with the FCC Part 15.207, RSS-Gen limits.

The spacing between the peripherals was 10 cm.

The adapter or EUT was connected to the main LISN with a 120 V/60 Hz AC power source.

4.1.3 EMI Test Receiver Setup

The EMI test receiver was set to investigate the spectrum from 150 kHz to 30 MHz.

During the conducted emission test, the EMI test receiver was set with the following configurations:

Frequency Range	IF B/W
150 kHz – 30 MHz	9 kHz

4.1.4 Test Procedure

The frequency and amplitude of the six highest ac power-line conducted emissions relative to the limit, measured over all the current-carrying conductors of the EUT power cords, and the operating frequency or frequency to which the EUT is tuned (if appropriate), should be reported, unless such emissions are more than 20 dB below the limit. AC power-line conducted emissions measurements are to be separately carried out only on each of the phase (“hot”) line(s) and (if used) on the neutral line(s), but not on the ground [protective earth] line(s). If less than six emission frequencies are within 20 dB of the limit, then the noise level of the measuring instrument at representative frequencies should be reported. The specific conductor of the power-line cord for each of the reported emissions should be identified. Measure the six highest emissions with respect to the limit on each current-carrying conductor of each power cord associated with the EUT (but not the power cords of associated or peripheral equipment that are part of the test configuration). Then, report the six highest emissions with respect to the limit from among all the measurements identifying the frequency and specific current-carrying conductor identified with the emission. The six highest emissions should be reported for each of the current-carrying conductors, or the six highest emissions may be reported over all the current-carrying conductors.

4.1.5 Corrected Amplitude & Margin Calculation

The basic equation is as follows:

Result = Reading + Factor

Factor = attenuation caused by cable loss + voltage division factor of AMN

The “**Margin**” column of the following data tables indicates the degree of compliance within the applicable limit. The equation for margin calculation is as follows:

Margin = Limit – Result

4.1.6 Test Result

Please refer to section 5.1.

4.2 Radiation Spurious Emissions

4.2.1 Applicable Standard

FCC §15.407 (b);

Undesirable emission limits. Except as shown in paragraph (b)(7) of this section, the maximum emissions outside of the frequency bands of operation shall be attenuated in accordance with the following limits:

- (1) For transmitters operating in the 5.15-5.25 GHz band: All emissions outside of the 5.15-5.35 GHz band shall not exceed an e.i.r.p. of - 27 dBm/MHz.
 - (2) For transmitters operating in the 5.25-5.35 GHz band: All emissions outside of the 5.15-5.35 GHz band shall not exceed an e.i.r.p. of - 27 dBm/MHz.
 - (3) For transmitters operating in the 5.47-5.725 GHz band: All emissions outside of the 5.47-5.725 GHz band shall not exceed an e.i.r.p. of - 27 dBm/MHz.
 - (4) For transmitters operating solely in the 5.725-5.850 GHz band:
 - (i) All emissions shall be limited to a level of - 27 dBm/MHz at 75 MHz or more above or below the band edge increasing linearly to 10 dBm/MHz at 25 MHz above or below the band edge, and from 25 MHz above or below the band edge increasing linearly to a level of 15.6 dBm/MHz at 5 MHz above or below the band edge, and from 5 MHz above or below the band edge increasing linearly to a level of 27 dBm/MHz at the band edge.
 - (ii) Devices certified before March 2, 2017 with antenna gain greater than 10 dBi may demonstrate compliance with the emission limits in § 15.247(d), but manufacturing, marketing and importing of devices certified under this alternative must cease by March 2, 2018. Devices certified before March 2, 2018 with antenna gain of 10 dBi or less may demonstrate compliance with the emission limits in § 15.247(d), but manufacturing, marketing and importing of devices certified under this alternative must cease before March 2, 2020.
 - (8) The emission measurements shall be performed using a minimum resolution bandwidth of 1 MHz. A lower resolution bandwidth may be employed near the band edge, when necessary, provided the measured energy is integrated to show the total power over 1 MHz.
 - (9) Unwanted emissions below 1 GHz must comply with the general field strength limits set forth in § 15.209. Further, any U-NII devices using an AC power line are required to comply also with the conducted limits set forth in § 15.207.
 - (10) The provisions of § 15.205 apply to intentional radiators operating under this section.
 - (11) When measuring the emission limits, the nominal carrier frequency shall be adjusted as close to the upper and lower frequency band edges as the design of the equipment permits.
- (c) The device shall automatically discontinue transmission in case of either absence of information to transmit or operational failure. These provisions are not intended to preclude the transmission of control or signalling information or the use of repetitive codes used by certain digital technologies to complete frame or burst intervals. Applicants shall include in their application for equipment authorization a description of how this requirement is met.

Frequency band 5150-5250 MHz:

RSS-247 Clause 6.2.1.2

For transmitters with operating frequencies in the band 5150-5250 MHz, all emissions outside the band 5150-5350 MHz shall not exceed -27 dBm/MHz e.i.r.p. Any unwanted emissions that fall into the band 5250-5350 MHz shall be attenuated below the channel power by at least 26 dB, when measured using a resolution bandwidth between 1 and 5% of the occupied bandwidth (i.e. 99% bandwidth), above 5250 MHz. The 26 dB bandwidth may fall into the 5250-5350 MHz band; however, if the occupied bandwidth also falls within the 5250-5350 MHz band, the transmission is considered as intentional and the devices shall comply with all requirements in the band 5250-5350 MHz including implementing dynamic frequency selection (DFS) and TPC, on the portion of the emission that resides in the 5250-5350 MHz band.

Frequency band 5250-5350 MHz:

RSS-247 Clause 6.2.2.2

For transmitters with operating frequencies in the band 5150-5250 MHz, all emissions outside the band 5150-5350 MHz shall not exceed -27 dBm/MHz e.i.r.p. Any unwanted emissions that fall into the band 5250-5350 MHz shall be attenuated below the channel power by at least 26 dB, when measured using a resolution bandwidth between 1 and 5% of the occupied bandwidth (i.e. 99% bandwidth), above 5250 MHz. The 26 dB bandwidth may fall into the 5250-5350 MHz band; however, if the occupied bandwidth also falls within the 5250-5350 MHz band, the transmission is considered as intentional and the devices shall comply with all requirements in the band 5250-5350 MHz including implementing dynamic frequency selection (DFS) and TPC, on the portion of the emission that resides in the 5250-5350 MHz band.

Frequency bands 5470-5600 MHz and 5650-5725 MHz:

RSS-247 Clause 6.2.3.2

Emissions outside the band 5470-5600 MHz and 5650-5725 MHz shall not exceed -27 dBm/MHz e.i.r.p. However, devices with bandwidth overlapping the band edge of 5725 MHz can meet the emission limit of -27 dBm/MHz e.i.r.p. at 5850 MHz instead of 5725 MHz.

Frequency band 5725-5850 MHz

RSS-247 Clause 6.2.4.2

Devices operating in the band 5725-5850 MHz with antenna gain greater than 10 dBi can have unwanted emissions that comply with either the limits in this section or in section 5.5 until six (6) months after the publication date of this standard for certification. Certified devices that do not comply with emission limits in this section shall not be manufactured, imported, distributed, leased, offered for sale or sold after April 1, 2018.

Devices operating in the band 5725-5850 MHz with antenna gain of 10 dBi or less can have unwanted emissions that comply with either the limits in this section or in section 5.5 until April 1, 2018 for certification. Certified devices that do not comply with emission limits in this section shall not be manufactured, imported, distributed, leased, offered for sale or sold after April 1, 2020. Devices operating in the band 5725-5850 MHz shall have e.i.r.p. of unwanted emissions comply with the following:

- a) 27 dBm/MHz at frequencies from the band edges decreasing linearly to 15.6 dBm/MHz at 5 MHz above or below the band edges;
- b) 15.6 dBm/MHz at 5 MHz above or below the band edges decreasing linearly to 10 dBm/MHz at 25 MHz above or below the band edges;
- c) 10 dBm/MHz at 25 MHz above or below the band edges decreasing linearly to -27 dBm/MHz at 75 MHz above or below the band edges; and
- d) -27 dBm/MHz at frequencies more than 75 MHz above or below the band edges.

4.2.2 EUT Setup

9kHz~30MHz:

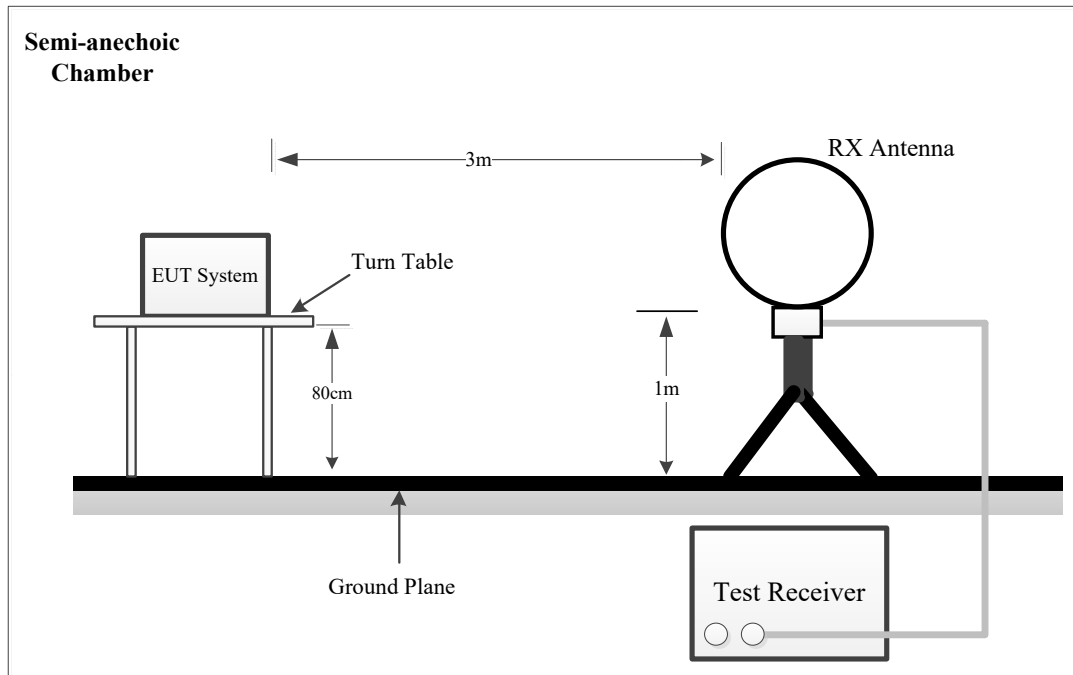

30MHz~1GHz:

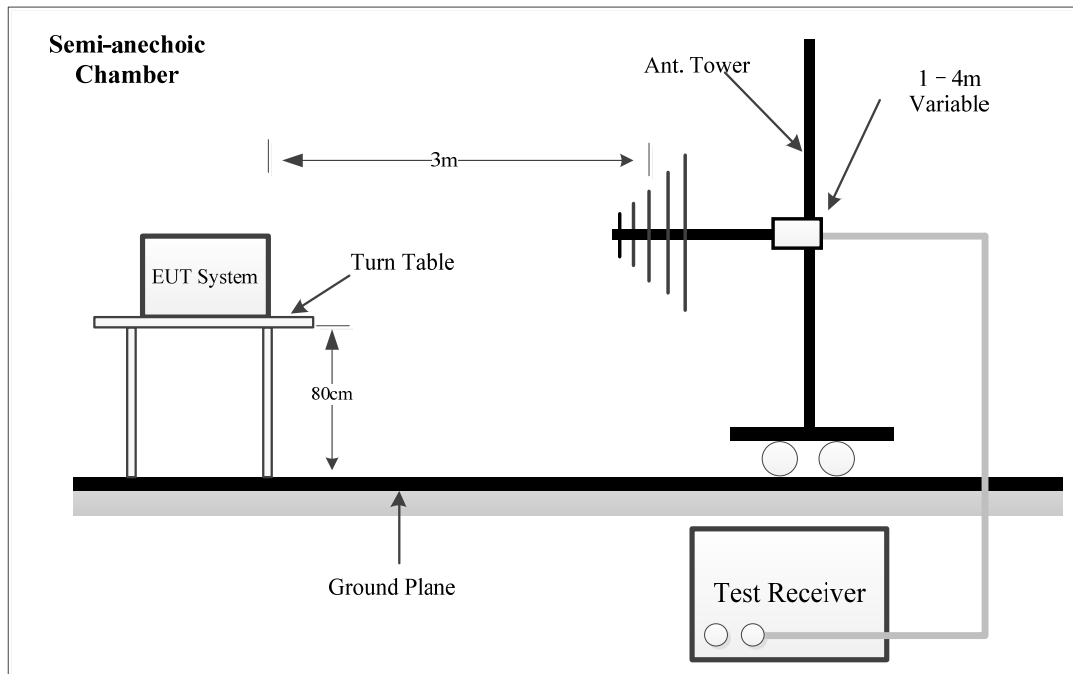

Above 1GHz:

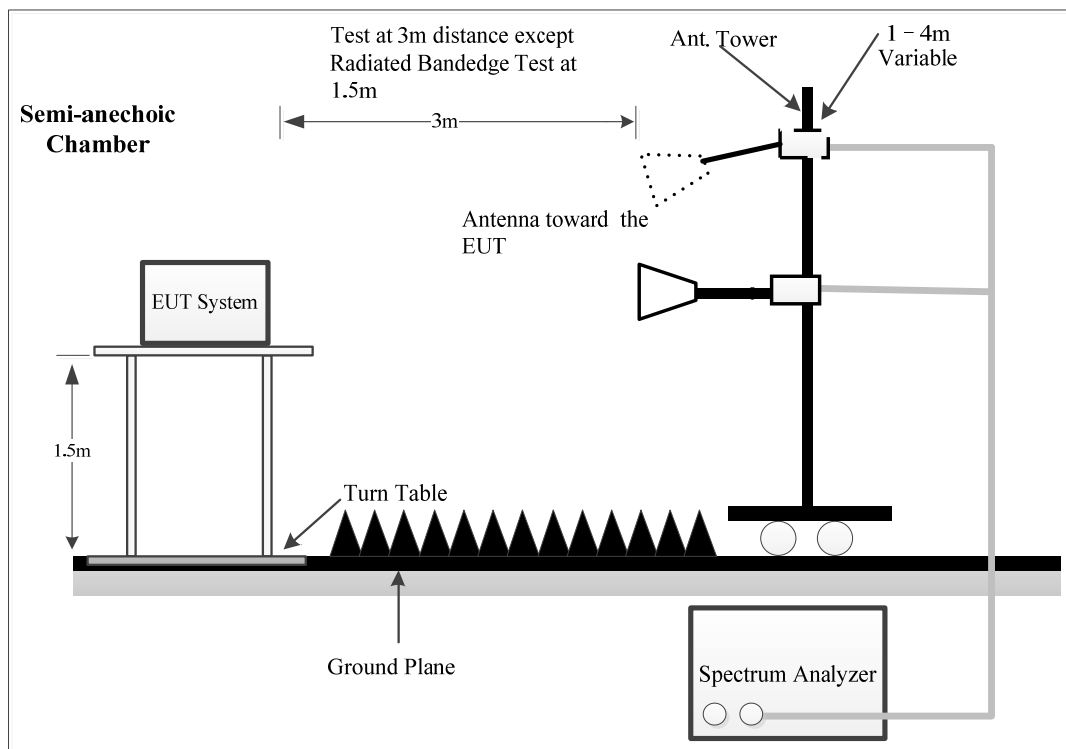

The radiated emission tests were performed in the semi-anechoic chamber, using the setup accordance with the ANSI C63.10-2013. The specification used was FCC 15.209, FCC 15.407, RSS-247, RSS-Gen limits.

The external I/O cables were draped along the test table and formed a bundle 30 to 40 cm long in the middle.

The spacing between the peripherals was 10 cm.

For 9kHz-30MHz test, the lowest height of the magnetic antenna shall be 1 m above the ground and three antenna orientations (parallel, perpendicular, and ground-parallel) shall be measured.

4.2.3 EMI Test Receiver & Spectrum Analyzer Setup

The system was investigated from 9 kHz to 40 GHz.

During the radiated emission test, the EMI test receiver & Spectrum Analyzer Setup were set with the following configurations:

9kHz-1000MHz:

Frequency Range	Measurement	RBW	Video B/W	IF B/W
9 kHz – 150 kHz	QP/AV	200 Hz	1 kHz	200 Hz
150 kHz – 30 MHz	QP/AV	9 kHz	30 kHz	9 kHz
30 MHz – 1000 MHz	PK	100 kHz	300 kHz	/
	QP	/	/	120 kHz

1GHz- 40GHz:

Measurement	Duty cycle	RBW	Video B/W
PK	Any	1MHz	3 MHz
Ave.	>98%	1MHz	10 Hz
	<98%	1MHz	$\geq 1/T$

Note: T is minimum transmission duration

If the maximized peak measured value is under the QP limit by more than 6dB, then it is unnecessary to perform an QP measurement.

If the maximized peak measured value is under the average limit, then it is unnecessary to perform an QP measurement.

4.2.4 Test Procedure

Data was recorded in Quasi-peak detection mode for frequency range of 9 kHz -1 GHz, except 9-90 kHz, 110-490 kHz, employing an average detector, peak and Average detection modes for frequencies above 1 GHz.

According to KDB 789033 D02 General UNII Test Procedures New Rules v02r01, emission shall be computed as: $E [dB\mu V/m] = EIRP[dBm] + 95.2$, for $d = 3$ meters.

For Radiated Bandedge test, which was performed at 1.5 m distance, according to C63.10, the test result shall be extrapolated to the specified distance using an extrapolation Factor of 20dB/decade from 3m to 1.5m

Distance extrapolation Factor = $20 \log (\text{specific distance } [3m]/\text{test distance } [1.5m])$ dB = 6.02 dB

4.2.5 Corrected Result & Margin Calculation

The basic equation except radiated bandedge test is as follows:

Factor = Antenna Factor + Cable Loss- Amplifier Gain

Result = Reading + Factor

For Radiated Bandedge test:

Factor = Antenna Factor + Cable Loss-Distance extrapolation Factor

Result = Reading + Factor

The “**Margin**” column of the following data tables indicates the degree of compliance within the applicable limit. The equation for margin calculation is as follows:

Margin = Limit – Result

4.2.6 Test Result

Please refer to section 5.2.

4.3 26dB Attenuated Below The Channel Power

4.3.1 Applicable Standard

RSS-247 Clause 6.2.1.2

For transmitters with operating frequencies in the band 5150-5250 MHz, all emissions outside the band 5150-5350 MHz shall not exceed -27 dBm/MHz e.i.r.p. Any unwanted emissions that fall into the band 5250-5350 MHz shall be attenuated below the channel power by at least 26 dB, when measured using a resolution bandwidth between 1 and 5% of the occupied bandwidth (i.e. 99% bandwidth), above 5250 MHz. The 26 dB bandwidth may fall into the 5250-5350 MHz band; however, if the occupied bandwidth also falls within the 5250-5350 MHz band, the transmission is considered as intentional and the devices shall comply with all requirements in the band 5250-5350 MHz including implementing dynamic frequency selection (DFS) and TPC, on the portion of the emission that resides in the 5250-5350 MHz band.

4.3.2 EUT Setup

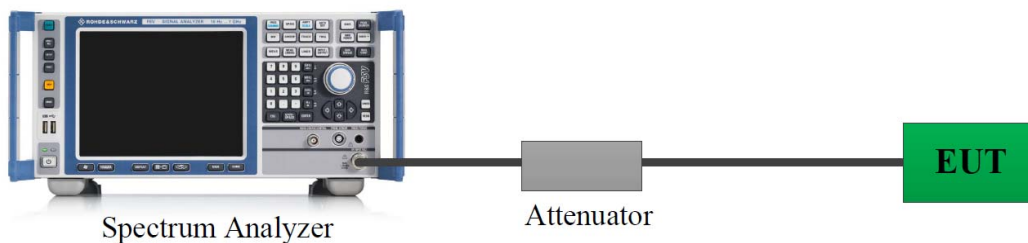

A short RF cable with low cable loss connected to the EUT antenna port, which was provided by manufacturer.

4.3.3 Test Procedure

- a) Set RBW = 1%~5% of the emission bandwidth.
- b) Set the VBW > RBW.
- c) Detector = RMS.
- d) Trace mode = max hold
- e) Measure the emission attenuated below the channel power

4.3.4 Test Result

Please refer to section 5.3.

4.4 Emission Bandwidth

4.4.1 Applicable Standard

FCC §15.407 (a),(h)

(h)(2) Radar Detection Function of Dynamic Frequency Selection (DFS). U-NII devices operating with any part of its 26 dB emission bandwidth in the 5.25-5.35 GHz and 5.47-5.725 GHz bands shall employ a DFS radar detection mechanism to detect the presence of radar systems and to avoid co-channel operation with radar systems.

FCC §15.407 (e)

Within the 5.725-5.850 GHz and 5.850-5.895 GHz bands, the minimum 6 dB bandwidth of U-NII devices shall be at least 500 kHz.

RSS-247 Clause 6.2.1.2

For transmitters with operating frequencies in the band 5150-5250 MHz, all emissions outside the band 5150-5350 MHz shall not exceed -27 dBm/MHz e.i.r.p. Any unwanted emissions that fall into the band 5250-5350 MHz shall be attenuated below the channel power by at least 26 dB, when measured using a resolution bandwidth between 1 and 5% of the occupied bandwidth (i.e. 99% bandwidth), above 5250 MHz. The 26 dB bandwidth may fall into the 5250-5350 MHz band; however, if the occupied bandwidth also falls within the 5250-5350 MHz band, the transmission is considered as intentional and the devices shall comply with all requirements in the band 5250-5350 MHz including implementing dynamic frequency selection (DFS) and TPC, on the portion of the emission that resides in the 5250-5350 MHz band.

RSS-247 Clause 6.2.2.1

Devices, other than devices installed in vehicles, shall comply with the following:

- a) The maximum conducted output power shall not exceed 250 mW or $11 + 10 \log_{10}B$, dBm, whichever is less. The power spectral density shall not exceed 11 dBm in any 1.0 MHz band;
- b) The maximum e.i.r.p. shall not exceed 1.0 W or $17 + 10 \log_{10}B$, dBm, whichever is less. B is the 99% emission bandwidth in megahertz. Note that devices with a maximum e.i.r.p. greater than 500 mW shall implement TPC in order to have the capability to operate at least 6 dB below the maximum permitted e.i.r.p. of 1 W

RSS-247 Clause 6.2.3.1

The maximum conducted output power shall not exceed 250 mW or $11 + 10 \log_{10}B$, dBm, whichever is less. The power spectral density shall not exceed 11 dBm in any 1.0 MHz band.

The maximum e.i.r.p. shall not exceed 1.0 W or $17 + 10 \log_{10}B$, dBm, whichever is less. B is the 99% emission bandwidth in megahertz. Note that devices with a maximum e.i.r.p. greater than 500 mW shall implement TPC in order to have the capability to operate at least 6 dB below the maximum permitted e.i.r.p. of 1 W.

RSS-247 Clause 6.2.4.1

For equipment operating in the band 5725-5850 MHz, the minimum 6 dB bandwidth shall be at least 500 kHz.

4.4.2 EUT Setup

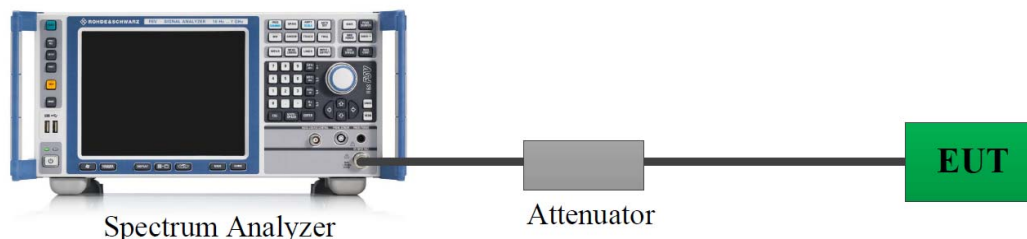

A short RF cable with low cable loss connected to the EUT antenna port, which was provided by manufacturer.

4.4.3 Test Procedure

26dB Emission Bandwidth:

According to ANSI C63.10-2013 Section 12.4.1

- a) Set RBW = approximately 1% of the emission bandwidth.
- b) Set the VBW > RBW.
- c) Detector = peak.
- d) Trace mode = max hold
- e) Measure the maximum width of the emission that is 26 dB down from the peak of the emission. Compare this with the RBW setting of the instrument. Readjust RBW and repeat measurement as needed until the RBW/EBW ratio is approximately 1%.

6 dB emission bandwidth:

According to KDB 789033 D02 General UNII Test Procedures New Rules v02r01

- a) Set RBW = 100 kHz.
- b) Set the video bandwidth (VBW) ≥ 3 RBW.
- c) Detector = Peak.
- d) Trace mode = max hold.
- e) Sweep = auto couple.
- f) Allow the trace to stabilize.
- g) Measure the maximum width of the emission that is constrained by the frequencies associated with the two outermost amplitude points (upper and lower frequencies) that are attenuated by 6 dB relative to the maximum level measured in the fundamental emission.

Note: The automatic bandwidth measurement capability of a spectrum analyzer or EMI receiver may be employed if it implements the functionality described in this section. For devices that use channel aggregation refer to III.A and III.C for determining emission bandwidth.

99% Occupied Bandwidth:

According to ANSI C63.10-2013 Section 12.4.2&6.9.3

The occupied bandwidth is the frequency bandwidth such that, below its lower and above its upper frequency limits, the mean powers are each equal to 0.5% of the total mean power of the given emission. The following procedure shall be used for measuring 99% power bandwidth:

a) The instrument center frequency is set to the nominal EUT channel center frequency. The frequency span for the spectrum analyzer shall be between 1.5 times and 5.0 times the OBW.

b) The nominal IF filter bandwidth (3 dB RBW) shall be in the range of 1% to 5% of the OBW, and VBW shall be approximately three times the RBW, unless otherwise specified by the applicable requirement.

c) Set the reference level of the instrument as required, keeping the signal from exceeding the maximum input mixer level for linear operation. In general, the peak of the spectral envelope shall be more than $[10 \log (OBW/RBW)]$ below the reference level. Specific guidance is given in 4.1.5.2.

d) Step a) through step c) might require iteration to adjust within the specified range.

e) Video averaging is not permitted. Where practical, a sample detection and single sweep mode shall be used. Otherwise, peak detection and max hold mode (until the trace stabilizes) shall be used.

f) Use the 99% power bandwidth function of the instrument (if available) and report the measured bandwidth.

g) If the instrument does not have a 99% power bandwidth function, then the trace data points are recovered and directly summed in linear power terms. The recovered amplitude data points, beginning at the lowest frequency, are placed in a running sum until 0.5% of the total is reached; that frequency is recorded as the lower frequency. The process is repeated until 99.5% of the total is reached; that frequency is recorded as the upper frequency. The 99% power bandwidth is the difference between these two frequencies.

h) The occupied bandwidth shall be reported by providing plot(s) of the measuring instrument display; the plot axes and the scale units per division shall be clearly labeled. Tabular data may be reported in addition to the plot(s).

4.4.4 Test Result

Please refer to section 5.4 and section 5.5.

4.5 Maximum Conducted Output Power

4.5.1 Applicable Standard

FCC §15.407(a) (1)(iv)

For client devices in the 5.15 – 5.25 GHz band, the maximum conducted output power over the frequency band of operation shall not exceed 250 mW provided the maximum antenna gain does not exceed 6 dBi. In addition, the maximum power spectral density shall not exceed 11 dBm in any 1 megahertz band. If transmitting antennas of directional gain greater than 6 dBi are used, both the maximum conducted output power and the maximum power spectral density shall be reduced by the amount in dB that the directional gain of the antenna exceeds 6 dBi.

FCC §15.407(a) (2)

For the 5.25-5.35 GHz and 5.47-5.725 GHz bands, the maximum conducted output power over the frequency bands of operation shall not exceed the lesser of 250 mW or $11 \text{ dBm} + 10 \log B$, where B is the 26 dB emission bandwidth in megahertz. In addition, the maximum power spectral density shall not exceed 11 dBm in any 1 megahertz band. If transmitting antennas of directional gain greater than 6 dBi are used, both the maximum conducted output power and the maximum power spectral density shall be reduced by the amount in dB that the directional gain of the antenna exceeds 6 dBi.

FCC §15.407(a) (3)(i)

For the band 5.725-5.850 GHz, the maximum conducted output power over the frequency band of operation shall not exceed 1 W. In addition, the maximum power spectral density shall not exceed 30 dBm in any 500-kHz band. If transmitting antennas of directional gain greater than 6 dBi are used, both the maximum conducted output power and the maximum power spectral density shall be reduced by the amount in dB that the directional gain of the antenna exceeds 6 dBi. However, fixed point-to-point U-NII devices operating in this band may employ transmitting antennas with directional gain greater than 6 dBi without any corresponding reduction in transmitter conducted power. Fixed, point-to-point operations exclude the use of point-to-multipoint systems, omnidirectional applications, and multiple collocated transmitters transmitting the same information. The operator of the U-NII device, or if the equipment is professionally installed, the installer, is responsible for ensuring that systems employing high gain directional antennas are used exclusively for fixed, point-to-point operations.

RSS-247 Clause 6.2.1.1

For OEM devices installed in vehicles, the maximum e.i.r.p. shall not exceed 30 mW or $1.76 + 10 \log_{10} B$, dBm, whichever is less stringent. Devices shall implement transmitter power control (TPC) in order to have the capability to operate at least 3 dB below the maximum permitted e.i.r.p. of 30 mW.

For other devices, the maximum e.i.r.p. shall not exceed 200 mW or $10 + 10 \log_{10} B$, dBm, whichever power is less. B is the 99% emission bandwidth in megahertz. The e.i.r.p. spectral density shall not exceed 10 dBm in any 1.0 MHz band.

RSS-247 Clause 6.2.2.1

Devices, other than devices installed in vehicles, shall comply with the following:

- a) The maximum conducted output power shall not exceed 250 mW or $11 + 10 \log_{10} B$, dBm, whichever is less. The power spectral density shall not exceed 11 dBm in any 1.0 MHz band;
- b) The maximum e.i.r.p. shall not exceed 1.0 W or $17 + 10 \log_{10} B$, dBm, whichever is less. B is the 99% emission bandwidth in megahertz. Note that devices with a maximum e.i.r.p. greater than 500 mW shall implement TPC in order to have the capability to operate at least 6 dB below the maximum permitted e.i.r.p. of 1 W.

RSS-247 Clause 6.2.3.1

The maximum conducted output power shall not exceed 250 mW or $11 + 10 \log_{10}B$, dBm, whichever is less. The power spectral density shall not exceed 11 dBm in any 1.0 MHz band.

The maximum e.i.r.p. shall not exceed 1.0 W or $17 + 10 \log_{10}B$, dBm, whichever is less. B is the 99% emission bandwidth in megahertz. Note that devices with a maximum e.i.r.p. greater than 500 mW shall implement TPC in order to have the capability to operate at least 6 dB below the maximum permitted e.i.r.p. of 1 W.

RSS-247 Clause 6.2.4.1

The maximum conducted output power shall not exceed 1 W. The output power spectral density shall not exceed 30 dBm in any 500 kHz band. If transmitting antennas of directional gain greater than 6 dBi are used, both the maximum conducted output power and the output power spectral density shall be reduced by the amount in dB that the directional gain of the antenna exceeds 6 dBi. However, fixed point-to-point devices operating in this band may employ transmitting antennas with directional gain greater than 6 dBi without any corresponding reduction in transmitter conducted power. Fixed point-to-point operations exclude the use of point-to-multipoint systems, omnidirectional applications and multiple collocated transmitters transmitting the same information.

4.5.2 EUT Setup

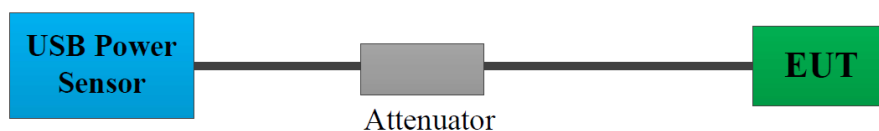

A short RF cable with low cable loss connected to the EUT antenna port, which was provided by manufacturer. The cable loss of this RF cable was offset into the setting of test equipment, which was provided by manufacturer ▲.

4.5.3 Test Procedure

According to ANSI C63.10-2013 Section 12.3.3.1

Method PM-G is measurement using a gated RF average power meter.

Measurements may be performed using a wideband gated RF power meter provided that the gate parameters are adjusted such that the power is measured only when the EUT is transmitting at its maximum power control level. Because the measurement is made only during the ON time of the transmitter, no duty cycle correction factor is required.

4.5.4 Test Result

Please refer to section 5.6.

4.6 Maximum Power Spectral Density

4.6.1 Applicable Standard

FCC §15.407(a) (1)(iv)

For client devices in the 5.15 – 5.25 GHz band, the maximum conducted output power over the frequency band of operation shall not exceed 250 mW provided the maximum antenna gain does not exceed 6 dBi. In addition, the maximum power spectral density shall not exceed 11 dBm in any 1 megahertz band. If transmitting antennas of directional gain greater than 6 dBi are used, both the maximum conducted output power and the maximum power spectral density shall be reduced by the amount in dB that the directional gain of the antenna exceeds 6 dBi.

FCC §15.407(a) (2)

For the 5.25-5.35 GHz and 5.47-5.725 GHz bands, the maximum conducted output power over the frequency bands of operation shall not exceed the lesser of 250 mW or $11 \text{ dBm} + 10 \log B$, where B is the 26 dB emission bandwidth in megahertz. In addition, the maximum power spectral density shall not exceed 11 dBm in any 1 megahertz band. If transmitting antennas of directional gain greater than 6 dBi are used, both the maximum conducted output power and the maximum power spectral density shall be reduced by the amount in dB that the directional gain of the antenna exceeds 6 dBi.

FCC §15.407(a) (3)(i)

For the band 5.725-5.850 GHz, the maximum conducted output power over the frequency band of operation shall not exceed 1 W. In addition, the maximum power spectral density shall not exceed 30 dBm in any 500-kHz band. If transmitting antennas of directional gain greater than 6 dBi are used, both the maximum conducted output power and the maximum power spectral density shall be reduced by the amount in dB that the directional gain of the antenna exceeds 6 dBi. However, fixed point-to-point U-NII devices operating in this band may employ transmitting antennas with directional gain greater than 6 dBi without any corresponding reduction in transmitter conducted power. Fixed, point-to-point operations exclude the use of point-to-multipoint systems, omnidirectional applications, and multiple collocated transmitters transmitting the same information. The operator of the U-NII device, or if the equipment is professionally installed, the installer, is responsible for ensuring that systems employing high gain directional antennas are used exclusively for fixed, point-to-point operations.

RSS-247 Clause 6.2.1.1

For OEM devices installed in vehicles, the maximum e.i.r.p. shall not exceed 30 mW or $1.76 + 10 \log_{10} B$, dBm, whichever is less stringent. Devices shall implement transmitter power control (TPC) in order to have the capability to operate at least 3 dB below the maximum permitted e.i.r.p. of 30 mW.

For other devices, the maximum e.i.r.p. shall not exceed 200 mW or $10 + 10 \log_{10} B$, dBm, whichever power is less. B is the 99% emission bandwidth in megahertz. The e.i.r.p. spectral density shall not exceed 10 dBm in any 1.0 MHz band.

RSS-247 Clause 6.2.2.1

Devices, other than devices installed in vehicles, shall comply with the following:

- a) The maximum conducted output power shall not exceed 250 mW or $11 + 10 \log_{10} B$, dBm, whichever is less. The power spectral density shall not exceed 11 dBm in any 1.0 MHz band;
- b) The maximum e.i.r.p. shall not exceed 1.0 W or $17 + 10 \log_{10} B$, dBm, whichever is less. B is the 99% emission bandwidth in megahertz. Note that devices with a maximum e.i.r.p. greater than 500 mW shall implement TPC in order to have the capability to operate at least 6 dB below the maximum permitted e.i.r.p. of 1 W.

RSS-247 Clause 6.2.3.1

The maximum conducted output power shall not exceed 250 mW or $11 + 10 \log_{10}B$, dBm, whichever is less. The power spectral density shall not exceed 11 dBm in any 1.0 MHz band.

The maximum e.i.r.p. shall not exceed 1.0 W or $17 + 10 \log_{10}B$, dBm, whichever is less. B is the 99% emission bandwidth in megahertz. Note that devices with a maximum e.i.r.p. greater than 500 mW shall implement TPC in order to have the capability to operate at least 6 dB below the maximum permitted e.i.r.p. of 1 W.

RSS-247 Clause 6.2.4.1

The maximum conducted output power shall not exceed 1 W. The output power spectral density shall not exceed 30 dBm in any 500 kHz band. If transmitting antennas of directional gain greater than 6 dBi are used, both the maximum conducted output power and the output power spectral density shall be reduced by the amount in dB that the directional gain of the antenna exceeds 6 dBi. However, fixed point-to-point devices operating in this band may employ transmitting antennas with directional gain greater than 6 dBi without any corresponding reduction in transmitter conducted power. Fixed point-to-point operations exclude the use of point-to-multipoint systems, omnidirectional applications and multiple collocated transmitters transmitting the same information.

4.6.2 EUT Setup

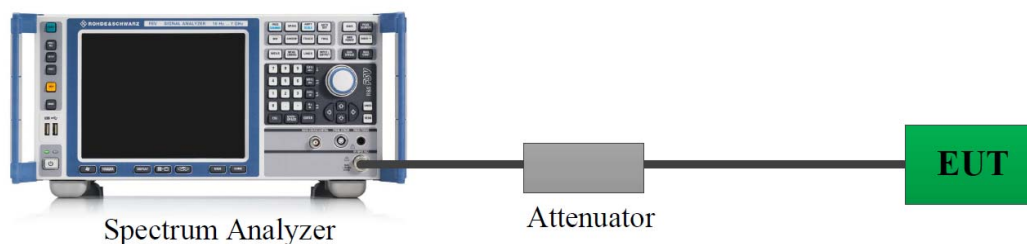

A short RF cable with low cable loss connected to the EUT antenna port, which was provided by manufacturer. The cable loss of this RF cable was offset into the setting of test equipment, which was provided by manufacturer ▲.

4.6.3 Test Procedure

According to KDB 789033 D02 General UNII Test Procedures New Rules v02r01

Duty cycle $\geq 98\%$

KDB 789033 D02 General UNII Test Procedures New Rules v02r01 Method SA-1 should be applied.

Duty cycle $< 98\%$, duty cycle variations are less than $\pm 2\%$

KDB 789033 D02 General UNII Test Procedures New Rules v02r01 Method SA-2 should be applied.

Duty cycle $< 98\%$, duty cycle variations exceed $\pm 2\%$

KDB 789033 D02 General UNII Test Procedures New Rules v02r01 Method SA-3 should be applied.

4.6.4 Test Result

Please refer to section 5.7.

4.7 Duty Cycle

4.7.1 EUT Setup

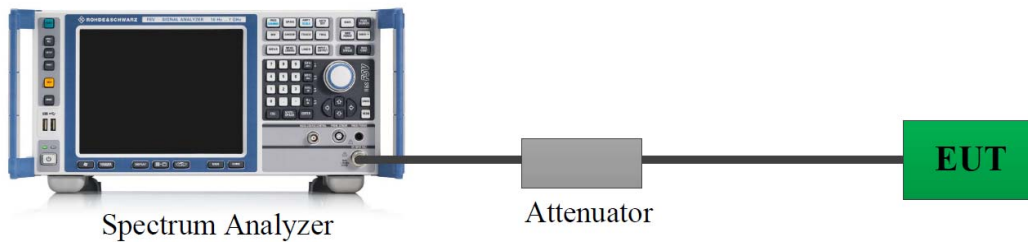

A short RF cable with low cable loss connected to the EUT antenna port, which was provided by manufacturer.

4.7.2 Test Procedure

According to ANSI C63.10-2013 Section 12.2

The zero-span mode on a spectrum analyzer or EMI receiver if the response time and spacing between bins on the sweep are sufficient to permit accurate measurements of the ON and OFF times of the transmitted signal:

- 1) Set the center frequency of the instrument to the center frequency of the transmission.
- 2) Set $RBW \geq OBW$ if possible; otherwise, set RBW to the largest available value.
- 3) Set $VBW \geq RBW$. Set detector = peak or average.
- 4) The zero-span measurement method shall not be used unless both RBW and VBW are $> 50/T$ and the number of sweep points across duration T exceeds 100. (For example, if VBW and/or RBW are limited to 3 MHz, then the zero-span method of measuring the duty cycle shall not be used if $T \leq 16.7 \mu s$.)

4.7.3 Judgment

Report Only. Please refer to section 5.8.

4.8 Antenna Requirement

4.8.1 Applicable Standard

FCC §15.203

An intentional radiator shall be designed to ensure that no antenna other than that furnished by the responsible party shall be used with the device. The use of a permanently attached antenna or of an antenna that uses a unique coupling to the intentional radiator shall be considered sufficient to comply with the provisions of this section. The manufacturer may design the unit so that a broken antenna can be replaced by the user, but the use of a standard antenna jack or electrical connector is prohibited. This requirement does not apply to carrier current devices or to devices operated under the provisions of §§15.211, 15.213, 15.217, 15.219, 15.221, or §15.236. Further, this requirement does not apply to intentional radiators that must be professionally installed, such as perimeter protection systems and some field disturbance sensors, or to other intentional radiators which, in accordance with §15.31(d), must be measured at the installation site. However, the installer shall be responsible for ensuring that the proper antenna is employed so that the limits in this part are not exceeded.

RSS-Gen Clause 6.8

The applicant for equipment certification shall provide a list of all antenna types that may be used with the transmitter, where applicable (i.e. for transmitters with detachable antenna), indicating the maximum permissible antenna gain (in dBi) and the required impedance for each antenna. The test report shall demonstrate the compliance of the transmitter with the limit for maximum equivalent isotropically radiated power (e.i.r.p.) specified in the applicable RSS, when the transmitter is equipped with any antenna type, selected from this list.

For expediting the testing, measurements may be performed using only the antenna with highest gain of each combination of transmitter and antenna type, with the transmitter output power set at the maximum level. However, the transmitter shall comply with the applicable requirements under all operational conditions and when in combination with any type of antenna from the list provided in the test report (and in the notice to be included in the user manual, provided below). When measurements at the antenna port are used to determine the RF output power, the effective gain of the device's antenna shall be stated, based on a measurement or on data from the antenna's manufacturer.

The test report shall state the RF power, output power setting and spurious emission measurements with each antenna type that is used with the transmitter being tested.

For licence-exempt equipment with detachable antennas, the user manual shall also contain the following notice in a conspicuous location:

This radio transmitter [enter the device's ISED certification number] has been approved by Innovation, Science and Economic Development Canada to operate with the antenna types listed below, with the maximum permissible gain indicated. Antenna types not included in this list that have a gain greater than the maximum gain indicated for any type listed are strictly prohibited for use with this device.

Immediately following the above notice, the manufacturer shall provide a list of all antenna types which can be used with the transmitter, indicating the maximum permissible antenna gain (in dBi) and the required impedance for each antenna type.

4.8.2 Judgment

Compliant. Please refer to the Antenna Information detail in Section 1.3.

4.9 Additional requirement

4.9.1 Applicable Standard

According to RSS-247 Clause 6.4 Additional requirement

The following requirements shall apply:

- a) The device shall automatically discontinue transmission in cases of absence of information to transmit, or operational failure. A description on how this is done shall accompany the application for equipment certification. Note that this is not intended to prohibit transmission of control or signalling information or the use of repetitive codes where required by the technology.
- b) All LE-LAN devices must contain security features to protect against modification of software by unauthorized parties.

Manufacturers must implement security features in any digitally modulated devices capable of operating in any of the frequency ranges within the 5 GHz band, so that third parties are not able to reprogram the device to operate outside the parameters for which the device was certified. The software must prevent the user from operating the transmitter with operating frequencies, output power, modulation types or other radio frequency parameters outside those that were approved for the device. Manufacturers may use various means, including the use of a private network that allows only authenticated users to download software, electronic signatures in software or coding in hardware that is decoded by software to verify that new software can be legally loaded into a device to meet these requirements and must describe the methods in their application for equipment certification.

Manufacturers must take steps to ensure that DFS functionality cannot be disabled by the operator of the LE-LAN device.

- c) The user manual for LE-LAN devices shall contain instructions related to the restrictions mentioned in the above sections, namely that:
 - i. the device for operation in the band 5150–5250 MHz is only for indoor use to reduce the potential for harmful interference to co-channel mobile satellite systems;⁴
 - ii. for devices with detachable antenna(s), the maximum antenna gain permitted for devices in the bands 5250-5350 MHz and 5470-5725 MHz shall be such that the equipment still complies with the e.i.r.p. limit;
 - iii. for devices with detachable antenna(s), the maximum antenna gain permitted for devices in the band 5725-5850 MHz shall be such that the equipment still complies with the e.i.r.p. limits as appropriate; and
 - iv. where applicable, antenna type(s), antenna models(s), and worst-case tilt angle(s) necessary to remain compliant with the e.i.r.p. elevation mask requirement set forth in section 6.2.2.3 shall be clearly indicated.

4.9.2 Judgment

RSS-247 Clause 6.4 a):

The device shall automatically discontinue transmission in cases of absence of information to transmit, or operational failure. Please refer to the declaration

RSS-247 Clause 6.4 b):

The devices must contain security features to protect against modification of software by unauthorized parties. Please refer to the declaration

RSS-247 Clause 6.4 c):

i). The device is only for indoor use.

ii). The device operates on 5250-5350MHz/5470-5725MHz meet the EIRP limit, please refer to the power test result.

iii). The antenna permanently attached to the unit, and all the EIRP compliance with RSS-247 requirement. Please refer to the conducted output power test result.

iv). The device EIRP less than 200mW(23 dBm)

5. Test DATA AND RESULTS

5.1 AC Line Conducted Emissions

Serial Number:	2HP4-4	Test Date:	2024/2/26
Test Site:	CE	Test Mode:	Transmitting
Tester:	Lane Sun	Test Result:	Pass

Environmental Conditions:

Temperature: (°C)	19	Relative Humidity: (%)	46	ATM Pressure: (kPa)	101.7
----------------------	----	------------------------------	----	------------------------	-------

Test Equipment List and Details:

Manufacturer	Description	Model	Serial Number	Calibration Date	Calibration Due Date
R&S	LISN	ENV216	101614	2023/10/18	2024/10/17
MICRO-COAX	Coaxial Cable	C-NJNJ-50	C-0200-01	2023/9/5	2024/9/4
R&S	EMI Test Receiver	ESCI	100035	2023/8/18	2024/8/17
R&S	Test Software	EMC32	V9.10.00	N/A	N/A

* Statement of Traceability: Bay Area Compliance Laboratories Corp. (Dongguan) attests that all calibrations have been performed, traceable to National Primary Standards and International System of Units (SI).

Project No: XMDN240206-08079E-RF
 Test Engineer: Lane Sun
 Test Date: 2024-2-26
 Port: L
 Test Mode: Transmitting
 Power Source: AC 120V/60Hz
 Note: 802.11ac vht80 5775MHz

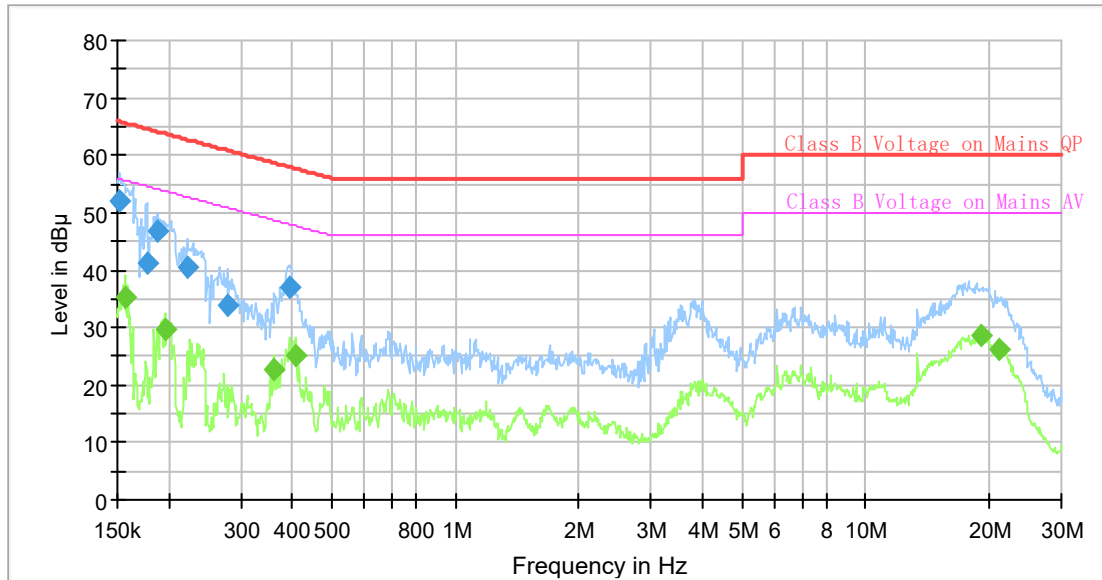

Final Result

Frequency (MHz)	QuasiPeak (dB μV)	Average (dB μV)	Limit (dB μV)	Margin (dB)	Bandwidth (kHz)	Line	Corr. (dB)
0.152261	52.01	---	65.88	13.87	9.000	L1	10.8
0.156106	---	35.33	55.67	20.34	9.000	L1	10.8
0.176836	41.07	---	64.63	23.56	9.000	L1	10.8
0.188682	46.70	---	64.09	17.39	9.000	L1	10.8
0.196363	---	29.85	53.76	23.91	9.000	L1	10.8
0.222439	40.46	---	62.73	22.27	9.000	L1	10.8
0.278409	33.86	---	60.86	27.00	9.000	L1	10.8
0.362647	---	22.79	48.67	25.88	9.000	L1	10.8
0.392773	36.91	---	58.00	21.09	9.000	L1	10.8
0.406728	---	25.28	47.71	22.43	9.000	L1	10.8
19.120678	---	28.67	50.00	21.33	9.000	L1	10.9
21.126352	---	26.29	50.00	23.71	9.000	L1	10.9

Project No: XMDN240206-08079E-RF
 Test Engineer: Lane Sun
 Test Date: 2024-2-26
 Port: N
 Test Mode: Transmitting
 Power Source: AC 120V/60Hz
 Note: 802.11ac vht80 5775MHz

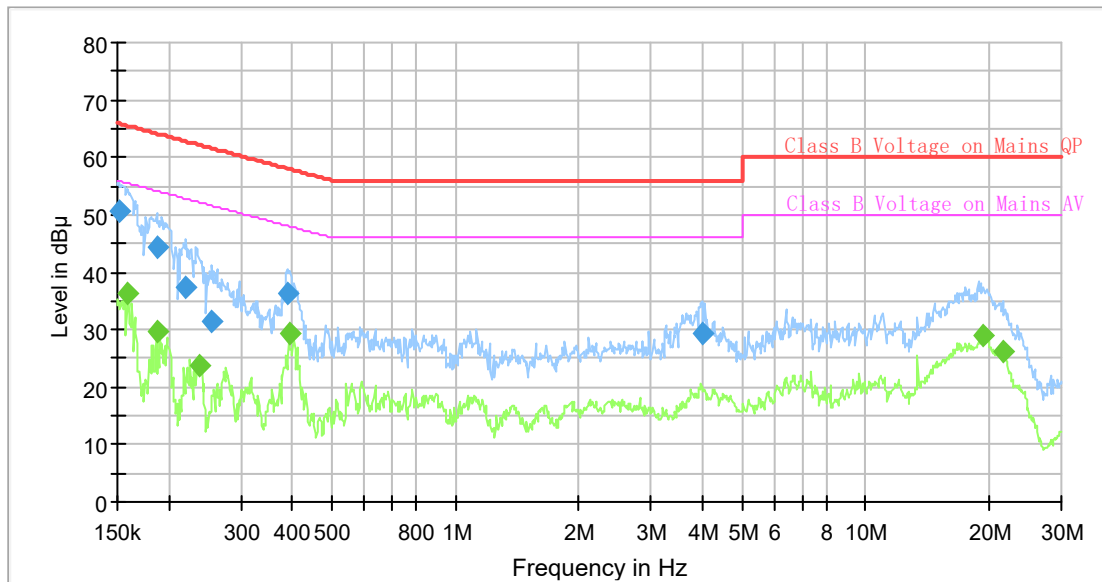

Final Result

Frequency (MHz)	QuasiPeak (dB μV)	Average (dB μV)	Limit (dB μV)	Margin (dB)	Bandwidth (kHz)	Line	Corr. (dB)
0.151504	50.55	---	65.92	15.37	9.000	N	10.9
0.159252	---	36.40	55.50	19.10	9.000	N	10.9
0.186809	44.27	---	64.18	19.91	9.000	N	10.9
0.186809	---	29.85	54.18	24.33	9.000	N	10.9
0.220231	37.25	---	62.81	25.56	9.000	N	10.8
0.237339	---	23.85	52.19	28.34	9.000	N	10.8
0.255776	31.55	---	61.57	30.02	9.000	N	10.8
0.388874	36.17	---	58.09	21.92	9.000	N	10.8
0.392773	---	29.18	48.00	18.82	9.000	N	10.8
3.993557	29.20	---	56.00	26.80	9.000	N	10.9
19.408925	---	29.00	50.00	21.00	9.000	N	10.9
21.659819	---	26.16	50.00	23.84	9.000	N	10.9

5.2 Radiation Spurious Emissions

Serial Number:	2HP4-4	Test Date:	Below 1GHz: 2024/4/9 Above 1GHz: 2024/3/10-2024/3/14
Test Site:	Chamber 10m, Chamber B	Test Mode:	Transmitting
Tester:	Zoo Zou, Colin Yang	Test Result:	Pass

Environmental Conditions:					
Temperature: (°C)	19.5~24.2	Relative Humidity: (%)	41~60	ATM Pressure: (kPa)	100.8~101.5

Test Equipment List and Details:

Manufacturer	Description	Model	Serial Number	Calibration Date	Calibration Due Date
9kHz~1000MHz					
EMCO	Passive Loop Antenna	6512	9706-1206	2023/10/21	2026/10/20
Sunol Sciences	Hybrid Antenna	JB3	A060611-1	2023/9/6	2026/9/5
Narda	Coaxial Attenuator	779-6dB	04269	2023/9/6	2026/9/5
Unknown	Coaxial Cable	C-NJNJ-50	C-1000-01	2023/8/1	2024/7/31
Unknown	Coaxial Cable	C-NJNJ-50	C-0400-04	2023/8/1	2024/7/31
Unknown	Coaxial Cable	C-NJNJ-50	C-0530-01	2023/8/1	2024/7/31
Sonoma	Amplifier	310N	185914	2023/8/1	2024/7/31
R&S	EMI Test Receiver	ESCI	101121	2023/10/18	2024/10/17
Farad	Test Software	EZ-EMC	V1.1.4.2	N/A	N/A
Above 1GHz					
ETS-Lindgren	Horn Antenna	3115	000 527 35	2023/9/7	2024/9/6
Ducommun Technologies	Horn Antenna	ARH-4223-02	1007726-02 1304	2023/2/22	2026/2/21
Xinhang Macrowave	Coaxial Cable	XH750A-N/J-SMA/J-10M	20231117004 #0001	2023/11/17	2024/11/16
Xinhang Macrowave	Coaxial Cable	XH360A-2.92/J-2.92/J-6M-A	20231208001 #0001	2023/12/11	2024/12/10
AH	Preamplifier	PAM-0118P	469	2023/8/19	2024/8/18
AH	Preamplifier	PAM-1840VH	191	2023/9/7	2024/9/6
R&S	Spectrum Analyzer	FSV40	101944	2023/10/18	2024/10/17
Audix	Test Software	E3	191218 (V9)	N/A	N/A
Ducommun Technologies	Horn Antenna	ARH-2823-02	1007726-01 1302	2023/2/22	2026/2/21
Sinoscite	Band Rejection Filter	BSF5150-5850MN	0899003	2023/6/16	2024/6/15
Mini-Circuits	High Pass Filter	VHF-6010+	31118	2023/12/1	2024/11/30

* Statement of Traceability: Bay Area Compliance Laboratories Corp. (Dongguan) attests that all calibrations have been performed, traceable to National Primary Standards and International System of Units (SI).

Test Data:

Please refer to the below table and plots.

1) 9kHz~30MHz

802.11ac vht80 5775MHz was tested, the amplitude of spurious emissions attenuated more than 20 dB below the permissible value is not required to be report.

1) 30MHz-1GHz

Project No: XMDN240206-08079E-RF
 Test Engineer: Zoo Zou
 Test Date: 2024-4-9
 Polarization: Horizontal
 Test Mode: Transmitting
 Power Source: AC 120V/60Hz
 Note: 802.11ac vht80 5775MHz

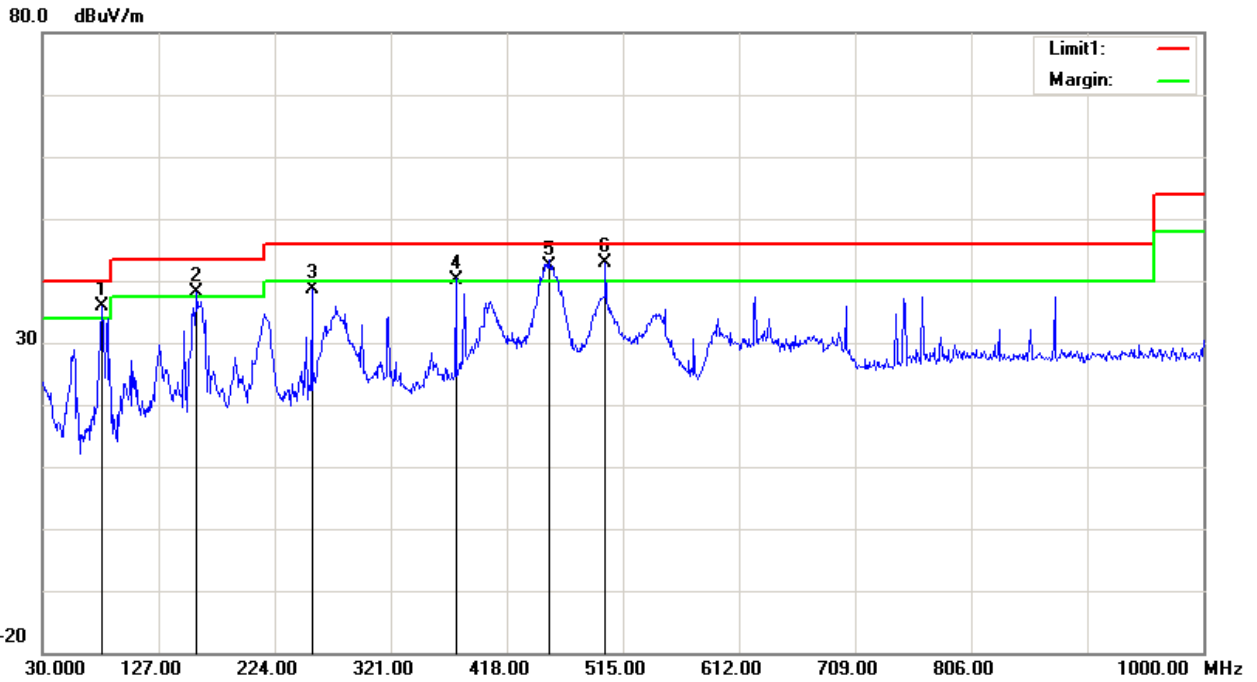

No.	Frequency (MHz)	Reading (dBuV)	Detector	Factor (dB/m)	Result (dBuV/m)	Limit (dBuV/m)	Margin (dB)
1	79.4700	52.24	QP	-16.44	35.80	40.00	4.20
2	159.0100	49.27	QP	-11.17	38.10	43.50	5.40
3	255.0400	50.09	peak	-11.37	38.72	46.00	7.28
4	375.3200	48.09	QP	-7.89	40.20	46.00	5.80
5	452.9200	47.63	QP	-5.33	42.30	46.00	3.70
6	500.4500	47.18	QP	-4.28	42.90	46.00	3.10

Project No: XMDN240206-08079E-RF
 Test Engineer: Zoo Zou
 Test Date: 2024-4-9
 Polarization: Vertical
 Test Mode: Transmitting
 Power Source: AC 120V/60Hz
 Note: 802.11ac vht80 5775MHz

80.0 dBuV/m

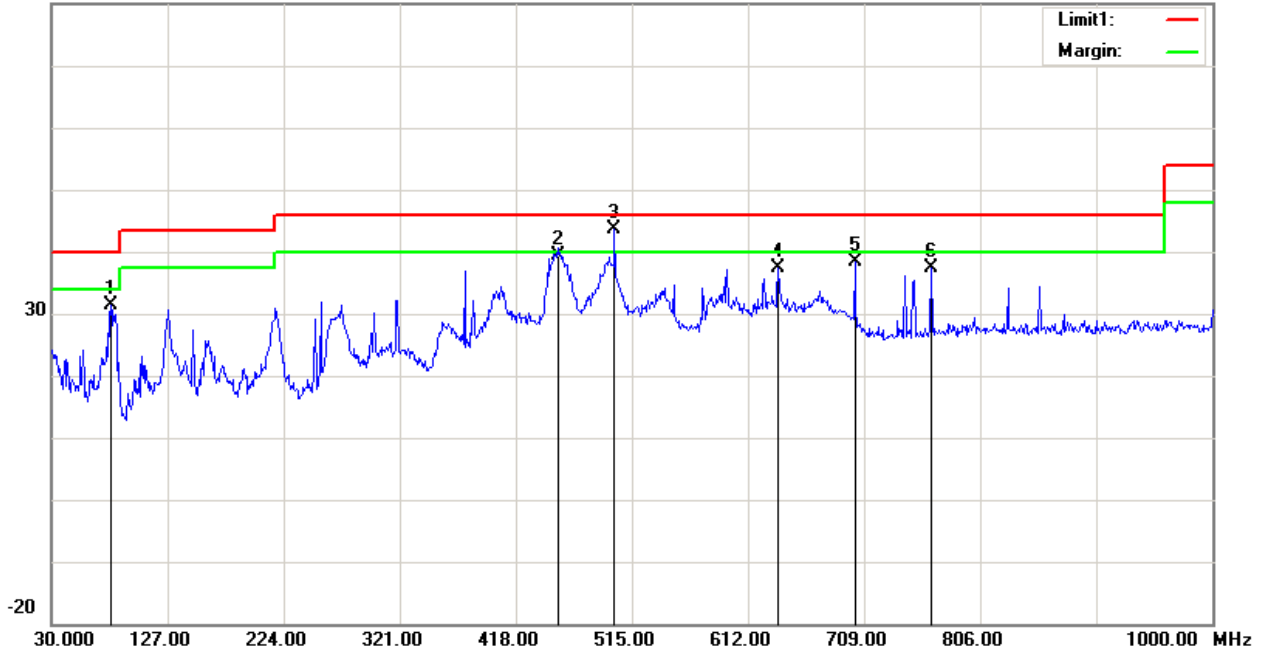

No.	Frequency (MHz)	Reading (dBuV)	Detector	Factor (dB/m)	Result (dBuV/m)	Limit (dBuV/m)	Margin (dB)
1	79.4700	47.86	peak	-16.44	31.42	40.00	8.58
2	452.9200	44.83	QP	-5.33	39.50	46.00	6.50
3	500.4500	47.88	QP	-4.28	43.60	46.00	2.40
4	637.2200	39.55	peak	-2.06	37.49	46.00	8.51
5	701.2400	39.71	peak	-1.24	38.47	46.00	7.53
6	765.2600	37.55	peak	-0.12	37.43	46.00	8.57

3) 1-18GHz:
5150-5250MHz :

802.11a mode, Low Channel, Horizontal		802.11a mode, Low Channel, Vertical																																																																																																																	
<p>Project No.: XMDN240206-08079E-RF Serial No.: ZHP4-4 Polarization: Horizontal Tester: Colin Yang Test Mode: Transmitting Note: 802.11a_U-NII-1_low channel 5180MHz</p> <p>Date: 2024-03-13</p>		<p>Project No.: XMDN240206-08079E-RF Serial No.: ZHP4-4 Polarization: Vertical Tester: Colin Yang Test Mode: Transmitting Note: 802.11a_U-NII-1_low channel 5180MHz</p> <p>Date: 2024-03-13</p>																																																																																																																	
<table border="1"> <thead> <tr> <th>No.</th> <th>Frequency (MHz)</th> <th>Reading (dBuV)</th> <th>Factor (dB/m)</th> <th>Result (dBuV/m)</th> <th>Limit (dBuV/m)</th> <th>Margin (dB)</th> <th>Detector</th> </tr> </thead> <tbody> <tr> <td>1</td> <td>4145.00</td> <td>41.72</td> <td>-3.79</td> <td>37.93</td> <td>54.00</td> <td>16.07</td> <td>Average</td> </tr> <tr> <td>2</td> <td>4145.00</td> <td>53.01</td> <td>-3.79</td> <td>49.22</td> <td>74.00</td> <td>24.78</td> <td>Peak</td> </tr> </tbody> </table>		No.	Frequency (MHz)	Reading (dBuV)	Factor (dB/m)	Result (dBuV/m)	Limit (dBuV/m)	Margin (dB)	Detector	1	4145.00	41.72	-3.79	37.93	54.00	16.07	Average	2	4145.00	53.01	-3.79	49.22	74.00	24.78	Peak	<table border="1"> <thead> <tr> <th>No.</th> <th>Frequency (MHz)</th> <th>Reading (dBuV)</th> <th>Factor (dB/m)</th> <th>Result (dBuV/m)</th> <th>Limit (dBuV/m)</th> <th>Margin (dB)</th> <th>Detector</th> </tr> </thead> <tbody> <tr> <td>1</td> <td>4144.00</td> <td>50.34</td> <td>-3.79</td> <td>46.55</td> <td>54.00</td> <td>7.45</td> <td>Average</td> </tr> <tr> <td>2</td> <td>4144.00</td> <td>62.32</td> <td>-3.79</td> <td>58.53</td> <td>74.00</td> <td>15.47</td> <td>Peak</td> </tr> </tbody> </table>		No.	Frequency (MHz)	Reading (dBuV)	Factor (dB/m)	Result (dBuV/m)	Limit (dBuV/m)	Margin (dB)	Detector	1	4144.00	50.34	-3.79	46.55	54.00	7.45	Average	2	4144.00	62.32	-3.79	58.53	74.00	15.47	Peak																																																																
No.	Frequency (MHz)	Reading (dBuV)	Factor (dB/m)	Result (dBuV/m)	Limit (dBuV/m)	Margin (dB)	Detector																																																																																																												
1	4145.00	41.72	-3.79	37.93	54.00	16.07	Average																																																																																																												
2	4145.00	53.01	-3.79	49.22	74.00	24.78	Peak																																																																																																												
No.	Frequency (MHz)	Reading (dBuV)	Factor (dB/m)	Result (dBuV/m)	Limit (dBuV/m)	Margin (dB)	Detector																																																																																																												
1	4144.00	50.34	-3.79	46.55	54.00	7.45	Average																																																																																																												
2	4144.00	62.32	-3.79	58.53	74.00	15.47	Peak																																																																																																												
<p>Project No.: XMDN240206-08079E-RF Serial No.: ZHP4-4 Polarization: Horizontal Tester: Colin Yang Test Mode: Transmitting Note: 802.11a_U-NII-1_low channel 5180MHz</p> <p>Date: 2024-03-10</p>		<p>Project No.: XMDN240206-08079E-RF Serial No.: ZHP4-4 Polarization: Vertical Tester: Colin Yang Test Mode: Transmitting Note: 802.11a_U-NII-1_low channel 5180MHz</p> <p>Date: 2024-03-10</p>																																																																																																																	
<table border="1"> <thead> <tr> <th>No.</th> <th>Frequency (MHz)</th> <th>Reading (dBuV)</th> <th>Factor (dB/m)</th> <th>Result (dBuV/m)</th> <th>Limit (dBuV/m)</th> <th>Margin (dB)</th> <th>Detector</th> </tr> </thead> <tbody> <tr> <td>1</td> <td>10360.00</td> <td>45.74</td> <td>6.49</td> <td>52.23</td> <td>68.20</td> <td>15.97</td> <td>Peak</td> </tr> <tr> <td>2</td> <td>15540.00</td> <td>35.38</td> <td>4.67</td> <td>40.05</td> <td>54.00</td> <td>13.95</td> <td>Average</td> </tr> <tr> <td>3</td> <td>15540.00</td> <td>45.79</td> <td>4.67</td> <td>50.46</td> <td>74.00</td> <td>23.54</td> <td>Peak</td> </tr> <tr> <td>4</td> <td>17404.80</td> <td>43.62</td> <td>15.11</td> <td>58.73</td> <td>68.20</td> <td>9.47</td> <td>Peak</td> </tr> <tr> <td>5</td> <td>17740.80</td> <td>28.24</td> <td>16.90</td> <td>45.14</td> <td>54.00</td> <td>8.86</td> <td>Average</td> </tr> <tr> <td>6</td> <td>17740.80</td> <td>38.41</td> <td>16.90</td> <td>55.31</td> <td>74.00</td> <td>18.69</td> <td>Peak</td> </tr> </tbody> </table>		No.	Frequency (MHz)	Reading (dBuV)	Factor (dB/m)	Result (dBuV/m)	Limit (dBuV/m)	Margin (dB)	Detector	1	10360.00	45.74	6.49	52.23	68.20	15.97	Peak	2	15540.00	35.38	4.67	40.05	54.00	13.95	Average	3	15540.00	45.79	4.67	50.46	74.00	23.54	Peak	4	17404.80	43.62	15.11	58.73	68.20	9.47	Peak	5	17740.80	28.24	16.90	45.14	54.00	8.86	Average	6	17740.80	38.41	16.90	55.31	74.00	18.69	Peak	<table border="1"> <thead> <tr> <th>No.</th> <th>Frequency (MHz)</th> <th>Reading (dBuV)</th> <th>Factor (dB/m)</th> <th>Result (dBuV/m)</th> <th>Limit (dBuV/m)</th> <th>Margin (dB)</th> <th>Detector</th> </tr> </thead> <tbody> <tr> <td>1</td> <td>10360.00</td> <td>45.06</td> <td>6.49</td> <td>51.55</td> <td>68.20</td> <td>16.65</td> <td>Peak</td> </tr> <tr> <td>2</td> <td>15540.00</td> <td>36.20</td> <td>4.67</td> <td>40.87</td> <td>54.00</td> <td>13.13</td> <td>Average</td> </tr> <tr> <td>3</td> <td>15540.00</td> <td>46.45</td> <td>4.67</td> <td>51.12</td> <td>74.00</td> <td>22.88</td> <td>Peak</td> </tr> <tr> <td>4</td> <td>17443.20</td> <td>43.56</td> <td>15.42</td> <td>58.98</td> <td>68.20</td> <td>9.22</td> <td>Peak</td> </tr> <tr> <td>5</td> <td>17992.80</td> <td>27.78</td> <td>18.12</td> <td>45.90</td> <td>54.00</td> <td>8.10</td> <td>Average</td> </tr> <tr> <td>6</td> <td>17992.80</td> <td>37.69</td> <td>18.12</td> <td>55.81</td> <td>74.00</td> <td>18.19</td> <td>Peak</td> </tr> </tbody> </table>		No.	Frequency (MHz)	Reading (dBuV)	Factor (dB/m)	Result (dBuV/m)	Limit (dBuV/m)	Margin (dB)	Detector	1	10360.00	45.06	6.49	51.55	68.20	16.65	Peak	2	15540.00	36.20	4.67	40.87	54.00	13.13	Average	3	15540.00	46.45	4.67	51.12	74.00	22.88	Peak	4	17443.20	43.56	15.42	58.98	68.20	9.22	Peak	5	17992.80	27.78	18.12	45.90	54.00	8.10	Average	6	17992.80	37.69	18.12	55.81	74.00	18.19	Peak
No.	Frequency (MHz)	Reading (dBuV)	Factor (dB/m)	Result (dBuV/m)	Limit (dBuV/m)	Margin (dB)	Detector																																																																																																												
1	10360.00	45.74	6.49	52.23	68.20	15.97	Peak																																																																																																												
2	15540.00	35.38	4.67	40.05	54.00	13.95	Average																																																																																																												
3	15540.00	45.79	4.67	50.46	74.00	23.54	Peak																																																																																																												
4	17404.80	43.62	15.11	58.73	68.20	9.47	Peak																																																																																																												
5	17740.80	28.24	16.90	45.14	54.00	8.86	Average																																																																																																												
6	17740.80	38.41	16.90	55.31	74.00	18.69	Peak																																																																																																												
No.	Frequency (MHz)	Reading (dBuV)	Factor (dB/m)	Result (dBuV/m)	Limit (dBuV/m)	Margin (dB)	Detector																																																																																																												
1	10360.00	45.06	6.49	51.55	68.20	16.65	Peak																																																																																																												
2	15540.00	36.20	4.67	40.87	54.00	13.13	Average																																																																																																												
3	15540.00	46.45	4.67	51.12	74.00	22.88	Peak																																																																																																												
4	17443.20	43.56	15.42	58.98	68.20	9.22	Peak																																																																																																												
5	17992.80	27.78	18.12	45.90	54.00	8.10	Average																																																																																																												
6	17992.80	37.69	18.12	55.81	74.00	18.19	Peak																																																																																																												

802.11a mode, Low Channel, Bandedge, Horizontal

Project No.: XMDN240206-08079E-RF Serial No.: 2HP4-4
 Polarization: Horizontal Tester: Colin Yang
 Test Mode: Transmitting
 Note: 802.11a_U-NII-1_low channel 5180MHz

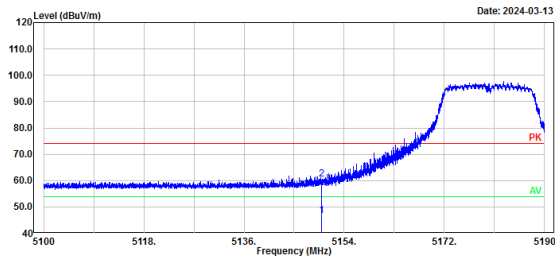

No.	Frequency (MHz)	Reading (dBuV)	Factor (dB/m)	Result (dBuV/m)	Limit (dBuV/m)	Margin (dB)	Detector
1	5150.00	18.05	28.68	46.73	54.00	7.27	Average
2	5150.00	31.84	28.68	60.52	74.00	13.48	Peak

802.11a mode, Low Channel, Bandedge, Vertical

Project No.: XMDN240206-08079E-RF Serial No.: 2HP4-4
 Polarization: Vertical Tester: Colin Yang
 Test Mode: Transmitting
 Note: 802.11a_U-NII-1_low channel 5180MHz

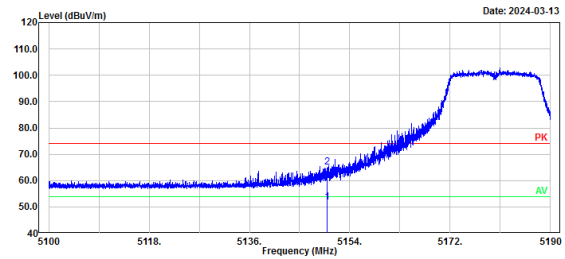

No.	Frequency (MHz)	Reading (dBuV)	Factor (dB/m)	Result (dBuV/m)	Limit (dBuV/m)	Margin (dB)	Detector
1	5150.00	23.01	28.68	51.69	54.00	2.31	Average
2	5150.00	36.46	28.68	65.14	74.00	8.86	Peak

802.11a mode, Middle Channel, Horizontal

Project No.: XMDN240206-08079E-RF Serial No.: 2HP4-4
 Polarization: Horizontal Tester: Colin Yang
 Test Mode: Transmitting
 Note: 802.11a_U-NII-1_middle channel 5200MHz

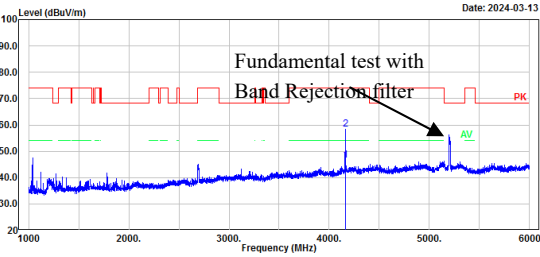

No.	Frequency (MHz)	Reading (dBuV)	Factor (dB/m)	Result (dBuV/m)	Limit (dBuV/m)	Margin (dB)	Detector
1	4160.00	50.23	-3.70	46.53	54.00	7.47	Average
2	4160.00	62.07	-3.70	58.37	74.00	15.63	Peak

802.11a mode, Middle Channel, Vertical

Project No.: XMDN240206-08079E-RF Serial No.: 2HP4-4
 Polarization: Vertical Tester: Colin Yang
 Test Mode: Transmitting
 Note: 802.11a_U-NII-1_middle channel 5200MHz

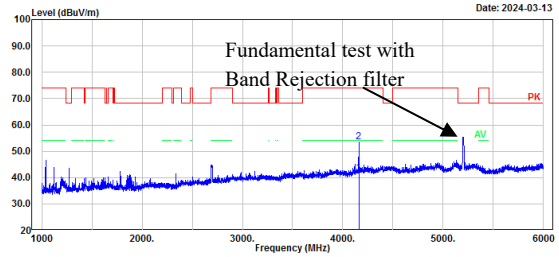

No.	Frequency (MHz)	Reading (dBuV)	Factor (dB/m)	Result (dBuV/m)	Limit (dBuV/m)	Margin (dB)	Detector
1	4159.00	45.51	-3.70	41.81	54.00	12.19	Average
2	4159.00	57.18	-3.70	53.48	74.00	20.52	Peak

Project No.: XMDN240206-08079E-RF Serial No.: 2HP4-4
 Polarization: Horizontal Tester: Colin Yang
 Test Mode: Transmitting
 Note: 802.11a_U-NII-1_middle channel 5200MHz

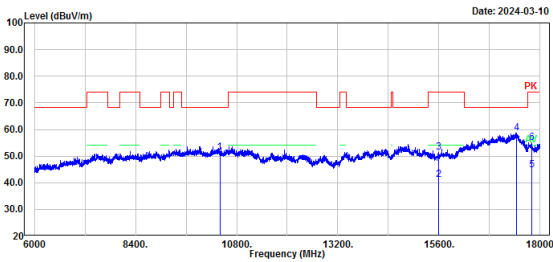

No.	Frequency (MHz)	Reading (dBuV)	Factor (dB/m)	Result (dBuV/m)	Limit (dBuV/m)	Margin (dB)	Detector
1	10400.00	44.97	6.44	51.41	68.20	16.79	Peak
2	15600.00	36.34	4.77	41.11	54.00	12.89	Average
3	15600.00	46.59	4.77	51.36	74.00	22.64	Peak
4	17438.40	43.18	15.39	58.57	68.20	9.63	Peak
5	17800.80	27.48	17.24	44.72	54.00	9.28	Average
6	17800.80	37.78	17.24	55.02	74.00	18.98	Peak

Project No.: XMDN240206-08079E-RF Serial No.: 2HP4-4
 Polarization: Vertical Tester: Colin Yang
 Test Mode: Transmitting
 Note: 802.11a_U-NII-1_middle channel 5200MHz

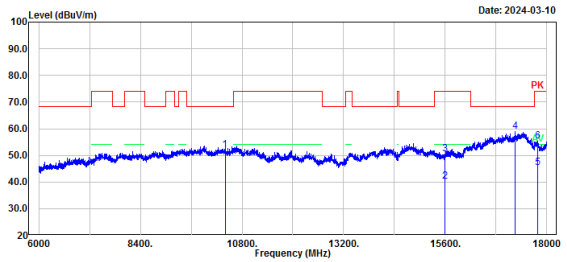

No.	Frequency (MHz)	Reading (dBuV)	Factor (dB/m)	Result (dBuV/m)	Limit (dBuV/m)	Margin (dB)	Detector
1	10400.00	45.54	6.44	51.98	68.20	16.22	Peak
2	15600.00	35.38	4.77	40.15	54.00	13.85	Average
3	15600.00	45.82	4.77	50.59	74.00	23.41	Peak
4	17248.80	45.12	13.85	58.97	68.20	9.23	Peak
5	17774.40	28.14	17.09	45.23	54.00	8.77	Average
6	17774.40	38.31	17.09	55.40	74.00	18.60	Peak

802.11a mode, High Channel, Horizontal

Project No.: XMDN240206-08079E-RF
 Polarization: Horizontal
 Test Mode: Transmitting
 Note: 802.11a_U-NII-1_high channel 5240MHz

Serial No.: 2HP4-4
 Tester: Colin Yang

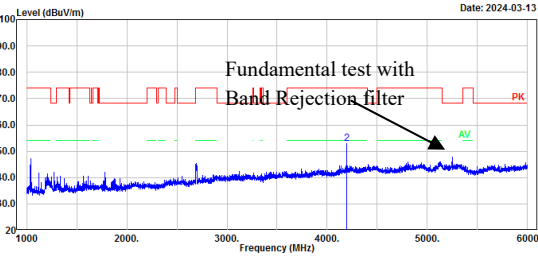

No.	Frequency (MHz)	Reading (dBuV)	Factor (dB/m)	Result (dBuV/m)	Limit (dBuV/m)	Margin (dB)	Detector
1	4193.00	44.23	-3.53	40.70	54.00	13.30	Average
2	4193.00	56.42	-3.53	52.89	74.00	21.11	Peak

802.11a mode, High Channel, Vertical

Project No.: XMDN240206-08079E-RF
 Polarization: Vertical
 Test Mode: Transmitting
 Note: 802.11a_U-NII-1_high channel 5240MHz

Serial No.: 2HP4-4
 Tester: Colin Yang

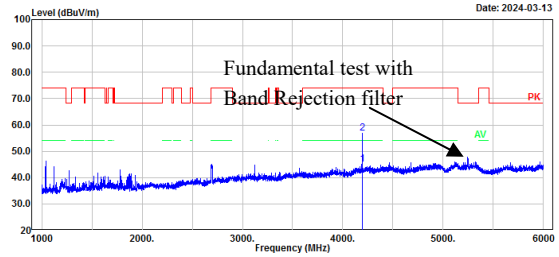

No.	Frequency (MHz)	Reading (dBuV)	Factor (dB/m)	Result (dBuV/m)	Limit (dBuV/m)	Margin (dB)	Detector
1	4192.00	48.57	-3.54	45.03	54.00	8.97	Average
2	4192.00	60.37	-3.54	56.83	74.00	17.17	Peak

Project No.: XMDN240206-08079E-RF
 Polarization: Horizontal
 Test Mode: Transmitting
 Note: 802.11a_U-NII-1_high channel 5240MHz

Serial No.: 2HP4-4
 Tester: Colin Yang

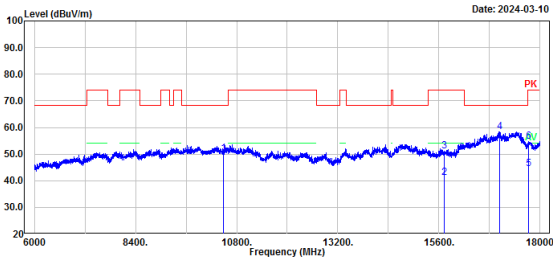

No.	Frequency (MHz)	Reading (dBuV)	Factor (dB/m)	Result (dBuV/m)	Limit (dBuV/m)	Margin (dB)	Detector
1	10480.00	43.60	6.60	50.20	68.20	18.00	Peak
2	15720.00	36.03	5.05	41.08	54.00	12.92	Average
3	15720.00	46.06	5.05	51.11	74.00	22.89	Peak
4	17037.60	46.24	12.24	58.48	68.20	9.72	Peak
5	17731.20	27.76	16.83	44.59	54.00	9.41	Average
6	17731.20	37.81	16.83	54.64	74.00	19.36	Peak

Project No.: XMDN240206-08079E-RF
 Polarization: Vertical
 Test Mode: Transmitting
 Note: 802.11a_U-NII-1_high channel 5240MHz

Serial No.: 2HP4-4
 Tester: Colin Yang

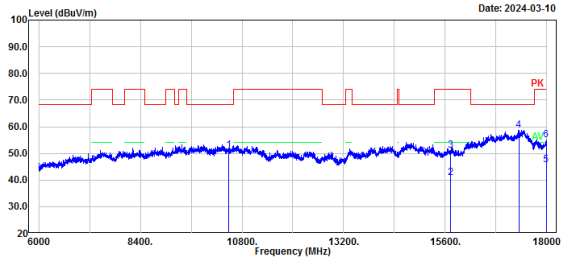

No.	Frequency (MHz)	Reading (dBuV)	Factor (dB/m)	Result (dBuV/m)	Limit (dBuV/m)	Margin (dB)	Detector
1	10480.00	44.52	6.60	51.12	68.20	17.08	Peak
2	15720.00	35.89	5.05	40.94	54.00	13.06	Average
3	15720.00	46.04	5.05	51.09	74.00	22.91	Peak
4	17335.20	44.19	14.54	58.73	68.20	9.47	Peak
5	17983.20	27.68	18.09	45.77	54.00	8.23	Average
6	17983.20	37.01	18.09	55.10	74.00	18.90	Peak

802.11a mode, High Channel, Bandedge, Horizontal

Project No.: XMDN240206-08079E-RF Serial No.: 2HP4-4
 Polarization: Horizontal Tester: Colin Yang
 Test Mode: Transmitting
 Note: 802.11a_U-NII-1_high channel 5240MHz

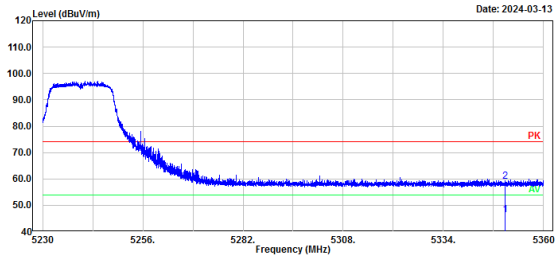

No.	Frequency (MHz)	Reading (dBuV)	Factor (dB/m)	Result (dBuV/m)	Limit (dBuV/m)	Margin (dB)	Detector
1	5350.00	17.25	29.16	46.41	54.00	7.59	Average
2	5350.00	29.78	29.16	58.94	74.00	15.06	Peak

802.11a mode, High Channel, Bandedge, Vertical

Project No.: XMDN240206-08079E-RF Serial No.: 2HP4-4
 Polarization: Vertical Tester: Colin Yang
 Test Mode: Transmitting
 Note: 802.11a_U-NII-1_high channel 5240MHz

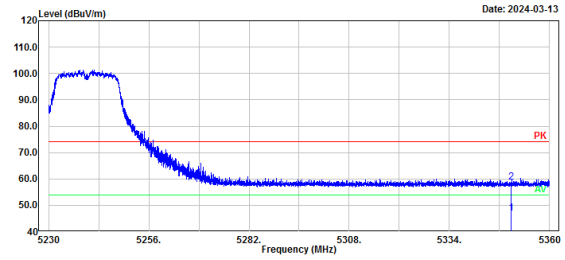

No.	Frequency (MHz)	Reading (dBuV)	Factor (dB/m)	Result (dBuV/m)	Limit (dBuV/m)	Margin (dB)	Detector
1	5350.00	17.68	29.16	46.84	54.00	7.16	Average
2	5350.00	29.46	29.16	58.62	74.00	15.38	Peak

802.11n ht20 mode, Low Channel, Horizontal

Project No.: XMDN240206-08079E-RF
 Polarization: Horizontal
 Test Mode: Transmitting
 Note: 802.11n20_U-NII-1_low channel 5180MHz
 Serial No.: 2HP4-4
 Tester: Colin Yang

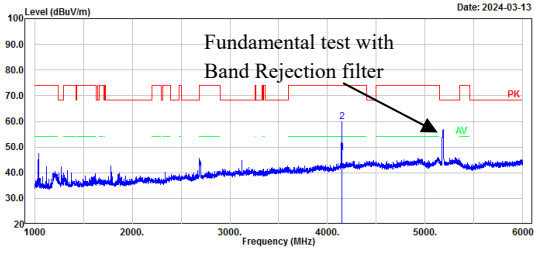

No.	Frequency (MHz)	Reading (dBuV)	Factor (dB/m)	Result (dBuV/m)	Limit (dBuV/m)	Margin (dB)	Detector
1	4144.00	51.56	-3.79	47.77	54.00	6.23	Average
2	4144.00	63.53	-3.79	59.74	74.00	14.26	Peak

802.11n ht20 mode, Low Channel, Vertical

Project No.: XMDN240206-08079E-RF
 Polarization: Vertical
 Test Mode: Transmitting
 Note: 802.11n20_U-NII-1_low channel 5180MHz
 Serial No.: 2HP4-4
 Tester: Colin Yang

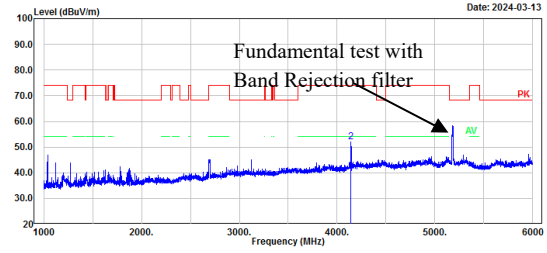

No.	Frequency (MHz)	Reading (dBuV)	Factor (dB/m)	Result (dBuV/m)	Limit (dBuV/m)	Margin (dB)	Detector
1	4143.00	43.51	-3.80	39.71	54.00	14.29	Average
2	4143.00	55.84	-3.80	52.04	74.00	21.96	Peak

Project No.: XMDN240206-08079E-RF
 Polarization: Horizontal
 Test Mode: Transmitting
 Note: 802.11n20_U-NII-1_low channel 5180MHz
 Serial No.: 2HP4-4
 Tester: Colin Yang

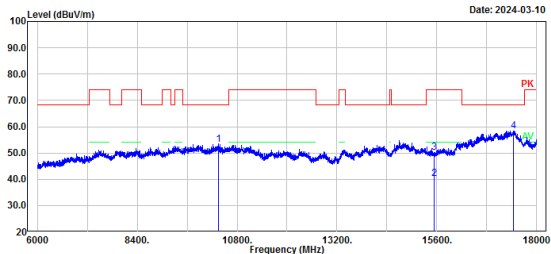

No.	Frequency (MHz)	Reading (dBuV)	Factor (dB/m)	Result (dBuV/m)	Limit (dBuV/m)	Margin (dB)	Detector
1	10360.00	46.61	6.49	53.10	68.20	15.10	Peak
2	15540.00	35.51	4.67	40.18	54.00	13.82	Average
3	15540.00	45.44	4.67	50.11	74.00	23.89	Peak
4	17438.40	43.01	15.39	58.40	68.20	9.80	Peak

Project No.: XMDN240206-08079E-RF
 Polarization: Vertical
 Test Mode: Transmitting
 Note: 802.11n20_U-NII-1_low channel 5180MHz
 Serial No.: 2HP4-4
 Tester: Colin Yang

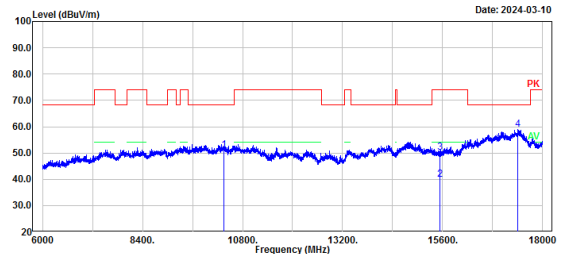

No.	Frequency (MHz)	Reading (dBuV)	Factor (dB/m)	Result (dBuV/m)	Limit (dBuV/m)	Margin (dB)	Detector
1	10360.00	44.57	6.49	51.06	68.20	17.14	Peak
2	15540.00	35.30	4.67	39.97	54.00	14.03	Average
3	15540.00	45.42	4.67	50.09	74.00	23.91	Peak
4	17402.40	43.92	15.10	59.02	68.20	9.18	Peak

802.11n ht20 mode, Low Channel, Bandedge, Horizontal

Project No.: XMDN240206-08079E-RF Serial No.: ZHP4-4
 Polarization: Horizontal Tester: Colin Yang
 Test Mode: Transmitting
 Note: 802.11n20_U-NII-1_low channel 5180MHz

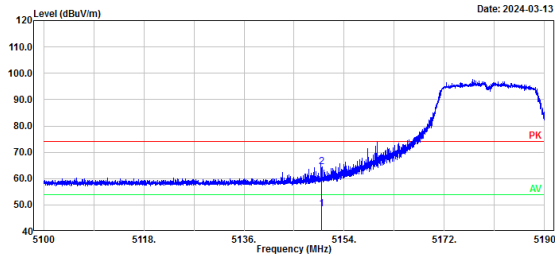

No.	Frequency (MHz)	Reading (dBμV)	Factor (dB/m)	Result (dBμV/m)	Limit (dBμV/m)	Margin (dB)	Detector
1	5150.00	19.68	28.68	48.36	54.00	5.64	Average
2	5150.00	35.81	28.68	64.49	74.00	9.51	Peak

802.11n ht20 mode, Low Channel, Bandedge, Vertical

Project No.: XMDN240206-08079E-RF Serial No.: ZHP4-4
 Polarization: Vertical Tester: Colin Yang
 Test Mode: Transmitting
 Note: 802.11n20_U-NII-1_low channel 5180MHz

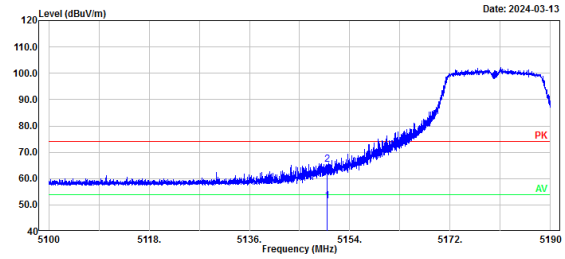

No.	Frequency (MHz)	Reading (dBμV)	Factor (dB/m)	Result (dBμV/m)	Limit (dBμV/m)	Margin (dB)	Detector
1	5150.00	22.65	28.68	51.33	54.00	2.67	Average
2	5150.00	36.62	28.68	65.30	74.00	8.70	Peak

802.11n ht20 mode, Middle Channel, Horizontal

Project No.: XMDN240206-08079E-RF Serial No.: 2HP4-4
 Polarization: Horizontal Tester: Colin Yang
 Test Mode: Transmitting
 Note: 802.11n20_U-NII-1_middle channel 5200MHz

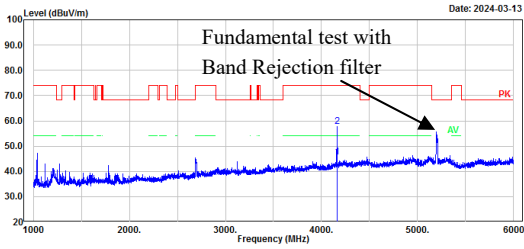

No.	Frequency (MHz)	Reading (dBuV)	Factor (dB/m)	Result (dBuV/m)	Limit (dBuV/m)	Margin (dB)	Detector
1	4160.00	49.35	-3.70	45.65	54.00	8.35	Average
2	4160.00	61.52	-3.70	57.82	74.00	16.18	Peak

802.11n ht20 mode, Middle Channel, Vertical

Project No.: XMDN240206-08079E-RF Serial No.: 2HP4-4
 Polarization: Vertical Tester: Colin Yang
 Test Mode: Transmitting
 Note: 802.11n20_U-NII-1_middle channel 5200MHz

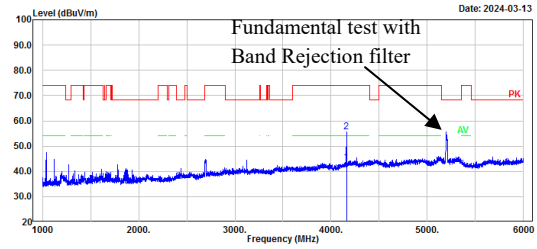

No.	Frequency (MHz)	Reading (dBuV)	Factor (dB/m)	Result (dBuV/m)	Limit (dBuV/m)	Margin (dB)	Detector
1	4159.00	47.34	-3.70	43.64	54.00	10.36	Average
2	4159.00	59.24	-3.70	55.54	74.00	18.46	Peak

Project No.: XMDN240206-08079E-RF Serial No.: 2HP4-4
 Polarization: Horizontal Tester: Colin Yang
 Test Mode: Transmitting
 Note: 802.11n20_U-NII-1_middle channel 5200MHz

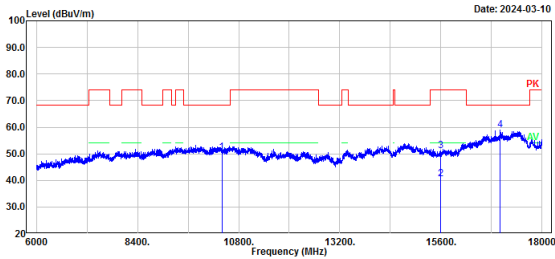

No.	Frequency (MHz)	Reading (dBuV)	Factor (dB/m)	Result (dBuV/m)	Limit (dBuV/m)	Margin (dB)	Detector
1	10400.00	44.15	6.44	50.59	68.20	17.61	Peak
2	15600.00	35.86	4.77	40.63	54.00	13.37	Average
3	15600.00	46.21	4.77	50.98	74.00	23.02	Peak
4	17006.40	46.91	11.96	58.87	68.20	9.33	Peak

Project No.: XMDN240206-08079E-RF Serial No.: 2HP4-4
 Polarization: Vertical Tester: Colin Yang
 Test Mode: Transmitting
 Note: 802.11n20_U-NII-1_middle channel 5200MHz

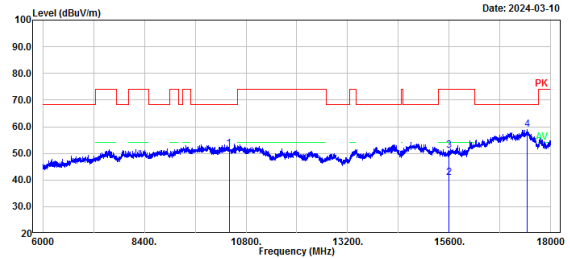

No.	Frequency (MHz)	Reading (dBuV)	Factor (dB/m)	Result (dBuV/m)	Limit (dBuV/m)	Margin (dB)	Detector
1	10400.00	45.22	6.44	51.66	68.20	16.54	Peak
2	15600.00	36.19	4.77	40.96	54.00	13.04	Average
3	15600.00	46.26	4.77	51.03	74.00	22.97	Peak
4	17445.60	43.45	15.44	58.89	68.20	9.31	Peak

802.11n ht20 mode, High Channel, Horizontal

Project No.: XMDN240206-08079E-RF Serial No.: 2HP4-4
 Polarization: Horizontal Tester: Colin Yang
 Test Mode: Transmitting
 Note: 802.11n20_U-NII-1_high channel 5240MHz

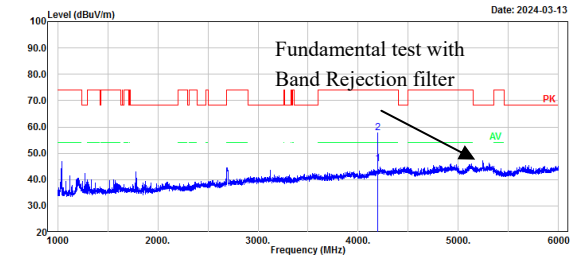

No.	Frequency (MHz)	Reading (dBuV)	Factor (dB/m)	Result (dBuV/m)	Limit (dBuV/m)	Margin (dB)	Detector
1	4192.00	49.57	-3.54	46.03	54.00	7.97	Average
2	4192.00	61.34	-3.54	57.80	74.00	16.20	Peak

802.11n ht20 mode, High Channel, Vertical

Project No.: XMDN240206-08079E-RF Serial No.: 2HP4-4
 Polarization: Vertical Tester: Colin Yang
 Test Mode: Transmitting
 Note: 802.11n20_U-NII-1_high channel 5240MHz

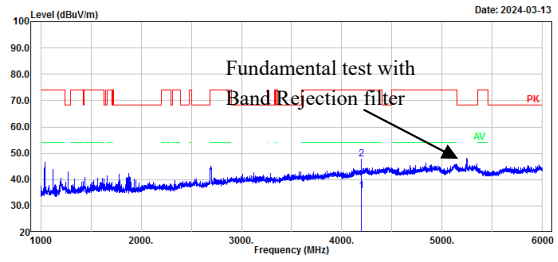

No.	Frequency (MHz)	Reading (dBuV)	Factor (dB/m)	Result (dBuV/m)	Limit (dBuV/m)	Margin (dB)	Detector
1	4192.00	39.34	-3.54	35.80	54.00	18.20	Average
2	4192.00	51.45	-3.54	47.91	74.00	26.09	Peak

Project No.: XMDN240206-08079E-RF Serial No.: 2HP4-4
 Polarization: Horizontal Tester: Colin Yang
 Test Mode: Transmitting
 Note: 802.11n20_U-NII-1_high channel 5240MHz

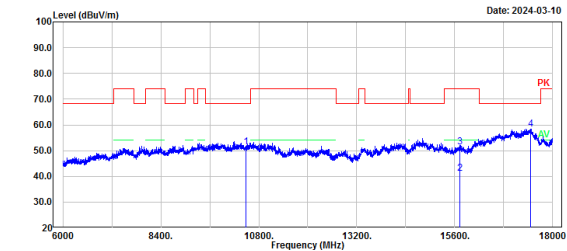

No.	Frequency (MHz)	Reading (dBuV)	Factor (dB/m)	Result (dBuV/m)	Limit (dBuV/m)	Margin (dB)	Detector
1	10480.00	44.86	6.60	51.46	68.20	16.74	Peak
2	15720.00	36.14	5.05	41.19	54.00	12.81	Average
3	15720.00	46.39	5.05	51.44	74.00	22.56	Peak
4	17467.20	42.84	15.61	58.45	68.20	9.75	Peak

Project No.: XMDN240206-08079E-RF Serial No.: 2HP4-4
 Polarization: Vertical Tester: Colin Yang
 Test Mode: Transmitting
 Note: 802.11n20_U-NII-1_high channel 5240MHz

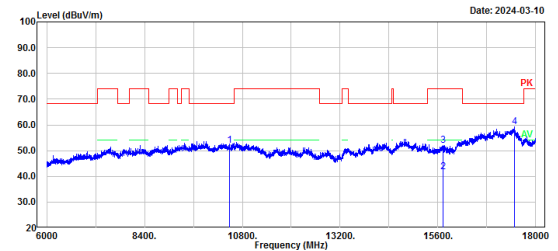

No.	Frequency (MHz)	Reading (dBuV)	Factor (dB/m)	Result (dBuV/m)	Limit (dBuV/m)	Margin (dB)	Detector
1	10480.00	45.29	6.60	51.89	68.20	16.31	Peak
2	15720.00	36.54	5.05	41.59	54.00	12.41	Average
3	15720.00	46.81	5.05	51.86	74.00	22.14	Peak
4	17472.00	43.71	15.65	59.36	68.20	8.84	Peak

802.11n ht20 mode, High Channel, Bandedge, Horizontal

Project No.: XMDN240206-08079E-RF Serial No.: 2HP4-4
 Polarization: Horizontal Tester: Colin Yang
 Test Mode: Transmitting
 Note: 802.11n20_U-NII-1_high channel 5240MHz

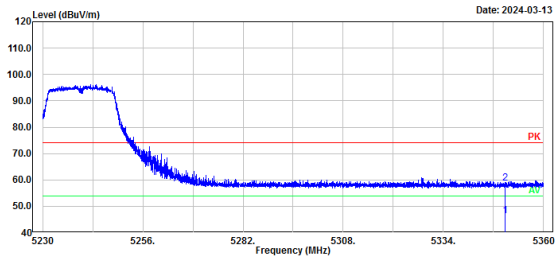

No.	Frequency (MHz)	Reading (dBuV)	Factor (dB/m)	Result (dBuV/m)	Limit (dBuV/m)	Margin (dB)	Detector
1	5350.00	17.27	29.16	46.43	54.00	7.57	Average
2	5350.00	29.53	29.16	58.69	74.00	15.31	Peak

802.11n ht20 mode, High Channel, Bandedge, Vertical

Project No.: XMDN240206-08079E-RF Serial No.: 2HP4-4
 Polarization: Vertical Tester: Colin Yang
 Test Mode: Transmitting
 Note: 802.11n20_U-NII-1_high channel 5240MHz

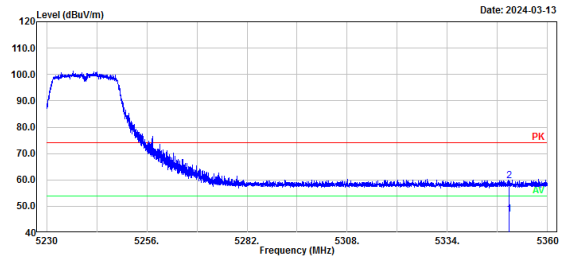

No.	Frequency (MHz)	Reading (dBuV)	Factor (dB/m)	Result (dBuV/m)	Limit (dBuV/m)	Margin (dB)	Detector
1	5350.00	17.85	29.16	47.01	54.00	6.99	Average
2	5350.00	30.32	29.16	59.48	74.00	14.52	Peak

802.11n ht40 mode, Low Channel, Horizontal

Project No.: XMDN240206-08079E-RF
 Polarization: Horizontal
 Test Mode: Transmitting
 Note: 802.11n40_U-NII-1_low channel 5190MHz
 Serial No.: 2HP4-4
 Tester: Colin Yang

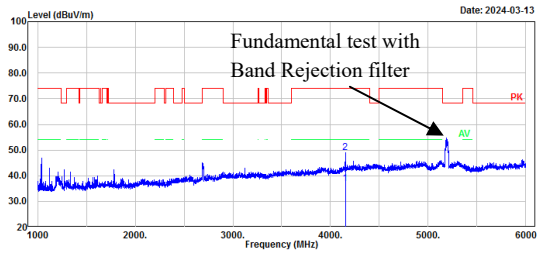

No.	Frequency (MHz)	Reading (dBμV)	Factor (dB/m)	Result (dBμV/m)	Limit (dBμV/m)	Margin (dB)	Detector
1	4151.00	40.65	-3.75	36.90	54.00	17.10	Average
2	4151.00	52.59	-3.75	48.84	74.00	25.16	Peak

802.11n ht40 mode, Low Channel, Vertical

Project No.: XMDN240206-08079E-RF
 Polarization: Vertical
 Test Mode: Transmitting
 Note: 802.11n40_U-NII-1_low channel 5190MHz
 Serial No.: 2HP4-4
 Tester: Colin Yang

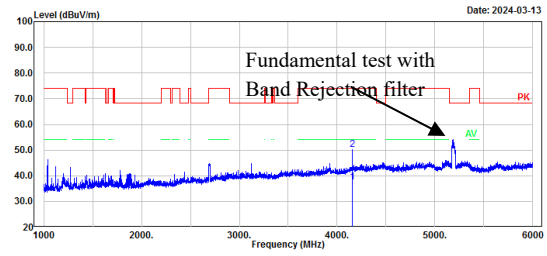

No.	Frequency (MHz)	Reading (dBμV)	Factor (dB/m)	Result (dBμV/m)	Limit (dBμV/m)	Margin (dB)	Detector
1	4152.00	41.28	-3.75	37.53	54.00	16.47	Average
2	4152.00	53.97	-3.75	50.22	74.00	23.78	Peak

Project No.: XMDN240206-08079E-RF
 Polarization: Horizontal
 Test Mode: Transmitting
 Note: 802.11n40_U-NII-1_low channel 5190MHz
 Serial No.: 2HP4-4
 Tester: Colin Yang

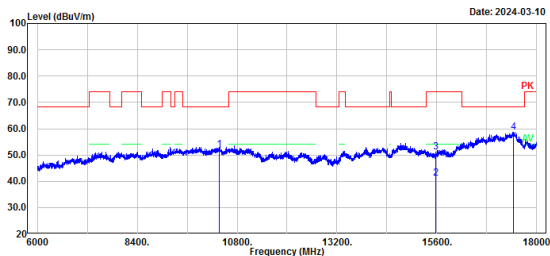

No.	Frequency (MHz)	Reading (dBμV)	Factor (dB/m)	Result (dBμV/m)	Limit (dBμV/m)	Margin (dB)	Detector
1	10380.00	45.63	6.47	52.10	68.20	16.10	Peak
2	15570.00	36.31	4.72	41.03	54.00	12.97	Average
3	15570.00	46.27	4.72	50.99	74.00	23.01	Peak
4	17445.00	43.23	15.44	58.67	68.20	9.53	Peak

Project No.: XMDN240206-08079E-RF
 Polarization: Vertical
 Test Mode: Transmitting
 Note: 802.11n40_U-NII-1_low channel 5190MHz
 Serial No.: 2HP4-4
 Tester: Colin Yang

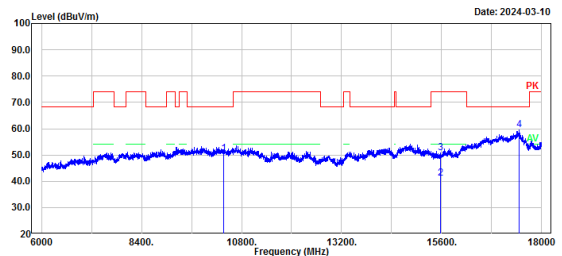

No.	Frequency (MHz)	Reading (dBμV)	Factor (dB/m)	Result (dBμV/m)	Limit (dBμV/m)	Margin (dB)	Detector
1	10380.00	44.05	6.47	50.52	68.20	17.68	Peak
2	15570.00	36.32	4.72	41.04	54.00	12.96	Average
3	15570.00	46.07	4.72	50.79	74.00	23.21	Peak
4	17457.00	43.98	15.53	59.51	68.20	8.69	Peak

802.11n ht40 mode, Low Channel, Bandedge, Horizontal

Project No.: XMDN240206-08079E-RF
 Polarization: Horizontal
 Test Mode: Transmitting
 Note: 802.11n40_U-NII-1_low channel 5190MHz

Serial No.: ZHP4-4
 Tester: Colin Yang

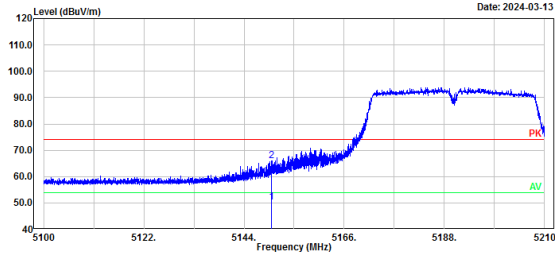

No.	Frequency (MHz)	Reading (dBuV)	Factor (dB/m)	Result (dBuV/m)	Limit (dBuV/m)	Margin (dB)	Detector
1	5150.00	21.52	28.68	50.20	54.00	3.80	Average
2	5150.00	37.18	28.68	65.86	74.00	8.14	Peak

802.11n ht40 mode, Low Channel, Bandedge, Vertical

Project No.: XMDN240206-08079E-RF
 Polarization: Vertical
 Test Mode: Transmitting
 Note: 802.11n40_U-NII-1_low channel 5190MHz

Serial No.: ZHP4-4
 Tester: Colin Yang

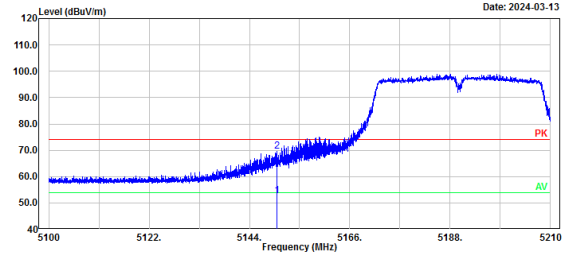

No.	Frequency (MHz)	Reading (dBuV)	Factor (dB/m)	Result (dBuV/m)	Limit (dBuV/m)	Margin (dB)	Detector
1	5150.00	23.88	28.68	52.56	54.00	1.44	Average
2	5150.00	40.78	28.68	69.46	74.00	4.54	Peak

802.11n ht40 mode, High Channel, Horizontal

Project No.: XMDN240206-08079E-RF Serial No.: 2HP4-4
 Polarization: Horizontal Tester: Colin Yang
 Test Mode: Transmitting
 Note: 802.11n40_U-NII-1_high channel 5230MHz

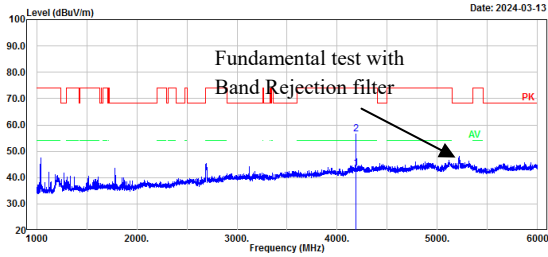

No.	Frequency (MHz)	Reading (dBuV)	Factor (dB/m)	Result (dBuV/m)	Limit (dBuV/m)	Margin (dB)	Detector
1	4185.00	47.22	-3.57	43.65	54.00	10.35	Average
2	4185.00	59.99	-3.57	56.42	74.00	17.58	Peak

802.11n ht40 mode, High Channel, Vertical

Project No.: XMDN240206-08079E-RF Serial No.: 2HP4-4
 Polarization: Vertical Tester: Colin Yang
 Test Mode: Transmitting
 Note: 802.11n40_U-NII-1_high channel 5230MHz

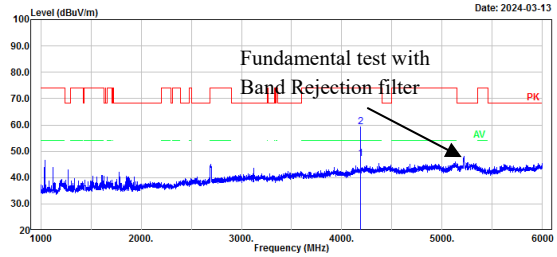

No.	Frequency (MHz)	Reading (dBuV)	Factor (dB/m)	Result (dBuV/m)	Limit (dBuV/m)	Margin (dB)	Detector
1	4184.00	50.75	-3.57	47.18	54.00	6.82	Average
2	4184.00	62.81	-3.57	59.24	74.00	14.76	Peak

Project No.: XMDN240206-08079E-RF Serial No.: 2HP4-4
 Polarization: Horizontal Tester: Colin Yang
 Test Mode: Transmitting
 Note: 802.11n40_U-NII-1_high channel 5230MHz

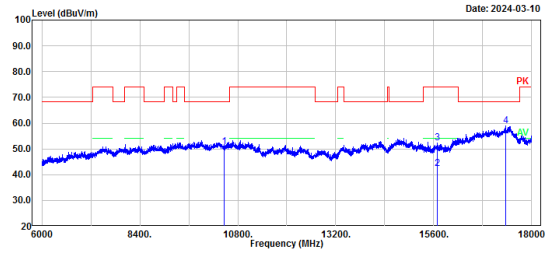

No.	Frequency (MHz)	Reading (dBuV)	Factor (dB/m)	Result (dBuV/m)	Limit (dBuV/m)	Margin (dB)	Detector
1	10460.00	44.16	6.56	50.72	68.20	17.48	Peak
2	15690.00	37.36	4.97	42.33	54.00	11.67	Average
3	15690.00	47.25	4.97	52.22	74.00	21.78	Peak
4	17364.00	44.12	14.78	58.90	68.20	9.30	Peak

Project No.: XMDN240206-08079E-RF Serial No.: 2HP4-4
 Polarization: Vertical Tester: Colin Yang
 Test Mode: Transmitting
 Note: 802.11n40_U-NII-1_high channel 5230MHz

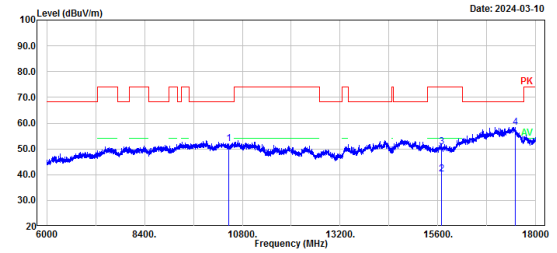

No.	Frequency (MHz)	Reading (dBuV)	Factor (dB/m)	Result (dBuV/m)	Limit (dBuV/m)	Margin (dB)	Detector
1	10460.00	45.42	6.56	51.98	68.20	16.22	Peak
2	15690.00	35.27	4.97	40.24	54.00	13.76	Average
3	15690.00	45.86	4.97	50.83	74.00	23.17	Peak
4	17500.80	42.57	15.87	58.44	68.20	9.76	Peak

802.11n ht40 mode, High Channel, Bandedge, Horizontal

Project No.: XMDN240206-08079E-RF Serial No.: 2HP4-4
 Polarization: Horizontal Tester: Colin Yang
 Test Mode: Transmitting
 Note: 802.11n40_U-NII-1_high channel 5230MHz

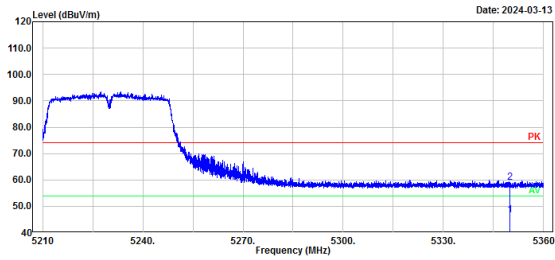

No.	Frequency (MHz)	Reading (dBuV)	Factor (dB/m)	Result (dBuV/m)	Limit (dBuV/m)	Margin (dB)	Detector
1	5350.00	17.39	29.16	46.55	54.00	7.45	Average
2	5350.00	29.75	29.16	58.91	74.00	15.09	Peak

802.11n ht40 mode, High Channel, Bandedge, Vertical

Project No.: XMDN240206-08079E-RF Serial No.: 2HP4-4
 Polarization: Vertical Tester: Colin Yang
 Test Mode: Transmitting
 Note: 802.11n40_U-NII-1_high channel 5230MHz

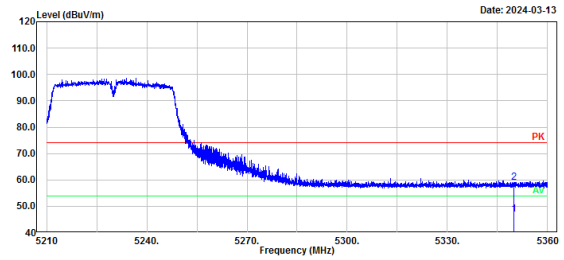

No.	Frequency (MHz)	Reading (dBuV)	Factor (dB/m)	Result (dBuV/m)	Limit (dBuV/m)	Margin (dB)	Detector
1	5350.00	17.69	29.16	46.85	54.00	7.15	Average
2	5350.00	29.97	29.16	59.13	74.00	14.87	Peak

802.11ac80 mode, Middle Channel, Horizontal

Project No.: XMDN240206-08079E-RF Serial No.: 2HP4-4
 Polarization: Horizontal Tester: Colin Yang
 Test Mode: Transmitting
 Note: 802.11ac80_U-NII-1_middle channel 5210MHz

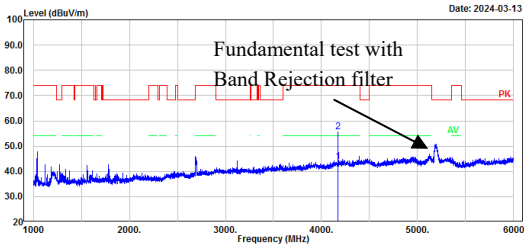

No.	Frequency (MHz)	Reading (dBuV)	Factor (dB/m)	Result (dBuV/m)	Limit (dBuV/m)	Margin (dB)	Detector
1	4168.00	47.38	-3.66	43.72	54.00	10.28	Average
2	4168.00	59.29	-3.66	55.63	74.00	18.37	Peak

802.11ac80 mode, Middle Channel, Vertical

Project No.: XMDN240206-08079E-RF Serial No.: 2HP4-4
 Polarization: Vertical Tester: Colin Yang
 Test Mode: Transmitting
 Note: 802.11ac80_U-NII-1_middle channel 5210MHz

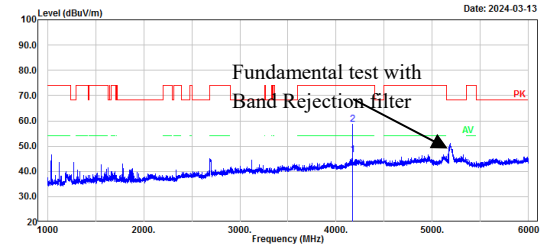

No.	Frequency (MHz)	Reading (dBuV)	Factor (dB/m)	Result (dBuV/m)	Limit (dBuV/m)	Margin (dB)	Detector
1	4168.00	50.22	-3.66	46.56	54.00	7.44	Average
2	4168.00	62.43	-3.66	58.77	74.00	15.23	Peak

Project No.: XMDN240206-08079E-RF Serial No.: 2HP4-4
 Polarization: Horizontal Tester: Colin Yang
 Test Mode: Transmitting
 Note: 802.11ac80_U-NII-1_middle channel 5210MHz

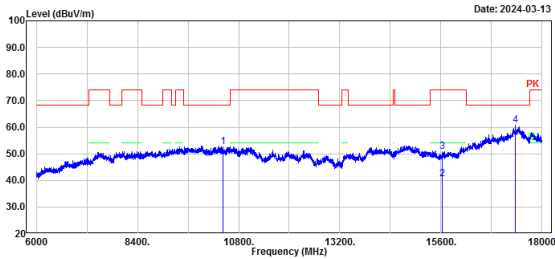

No.	Frequency (MHz)	Reading (dBuV)	Factor (dB/m)	Result (dBuV/m)	Limit (dBuV/m)	Margin (dB)	Detector
1	10420.00	46.15	6.47	52.62	68.20	15.58	Peak
2	15630.00	35.67	4.84	40.51	54.00	13.49	Average
3	15630.00	46.09	4.84	50.93	74.00	23.07	Peak
4	17364.00	45.87	14.78	60.65	68.20	7.55	Peak

Project No.: XMDN240206-08079E-RF Serial No.: 2HP4-4
 Polarization: Vertical Tester: Colin Yang
 Test Mode: Transmitting
 Note: 802.11ac80_U-NII-1_middle channel 5210MHz

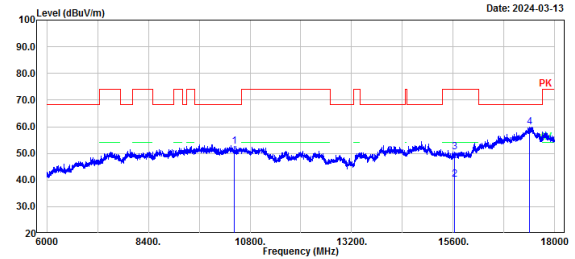

No.	Frequency (MHz)	Reading (dBuV)	Factor (dB/m)	Result (dBuV/m)	Limit (dBuV/m)	Margin (dB)	Detector
1	10420.00	46.09	6.47	52.56	68.20	15.64	Peak
2	15630.00	35.24	4.84	40.08	54.00	13.92	Average
3	15630.00	45.64	4.84	50.48	74.00	23.52	Peak
4	17404.00	44.71	15.11	59.82	68.20	8.38	Peak

802.11 ac80 mode, Middle Channel, Bandedge, Horizontal

Project No.: XMDN240206-08079E-RF Serial No.: 2HP4-4
 Polarization: Horizontal Tester: Colin Yang
 Test Mode: Transmitting
 Note: 802.11ac80_U-NII-1_middle channel 5210MHz

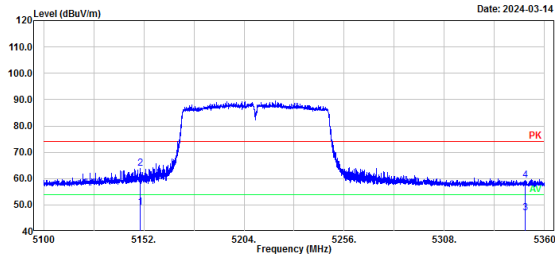

No.	Frequency (MHz)	Reading (dBuV)	Factor (dB/m)	Result (dBuV/m)	Limit (dBuV/m)	Margin (dB)	Detector
1	5150.00	20.35	28.68	49.03	54.00	4.97	Average
2	5150.00	35.19	28.68	63.87	74.00	10.13	Peak
3	5350.00	17.68	29.16	46.84	54.00	7.16	Average
4	5350.00	30.03	29.16	59.19	74.00	14.81	Peak

802.11 ac80 mode, Middle Channel, Bandedge, Vertical

Project No.: XMDN240206-08079E-RF Serial No.: 2HP4-4
 Polarization: Vertical Tester: Colin Yang
 Test Mode: Transmitting
 Note: 802.11ac80_U-NII-1_middle channel 5210MHz

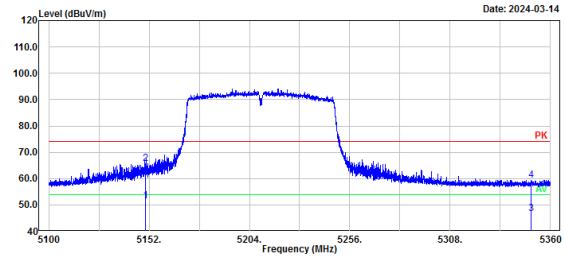

No.	Frequency (MHz)	Reading (dBuV)	Factor (dB/m)	Result (dBuV/m)	Limit (dBuV/m)	Margin (dB)	Detector
1	5150.00	22.91	28.68	51.59	54.00	2.41	Average
2	5150.00	37.09	28.68	65.77	74.00	8.23	Peak
3	5350.00	17.60	29.16	46.76	54.00	7.24	Average
4	5350.00	30.18	29.16	59.34	74.00	14.66	Peak

802.11 ax he20 mode, Low Channel, Horizontal

Project No.: XMDN240206-08079E-RF
 Polarization: Horizontal
 Test Mode: Transmitting
 Note: 802.11ax20_U-NII-1_low channel 5180MHz

Serial No.: 2HP4-4
 Tester: Colin Yang

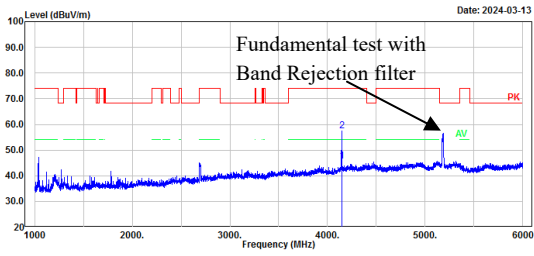

No.	Frequency (MHz)	Reading (dBμV)	Factor (dB/m)	Result (dBμV/m)	Limit (dBμV/m)	Margin (dB)	Detector
1	4144.00	49.58	-3.79	45.79	54.00	8.21	Average
2	4144.00	61.11	-3.79	57.32	74.00	16.68	Peak

802.11 ax he20 mode, Low Channel, Vertical

Project No.: XMDN240206-08079E-RF
 Polarization: Vertical
 Test Mode: Transmitting
 Note: 802.11ax20_U-NII-1_low channel 5180MHz

Serial No.: 2HP4-4
 Tester: Colin Yang

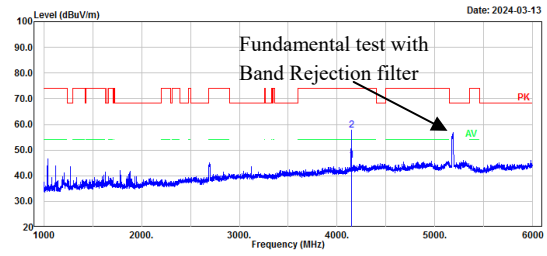

No.	Frequency (MHz)	Reading (dBμV)	Factor (dB/m)	Result (dBμV/m)	Limit (dBμV/m)	Margin (dB)	Detector
1	4144.00	49.85	-3.79	46.06	54.00	7.94	Average
2	4144.00	61.41	-3.79	57.62	74.00	16.38	Peak

Project No.: XMDN240206-08079E-RF
 Polarization: Horizontal
 Test Mode: Transmitting
 Note: 802.11ax20_U-NII-1_low channel 5180MHz

Serial No.: 2HP4-4
 Tester: Colin Yang

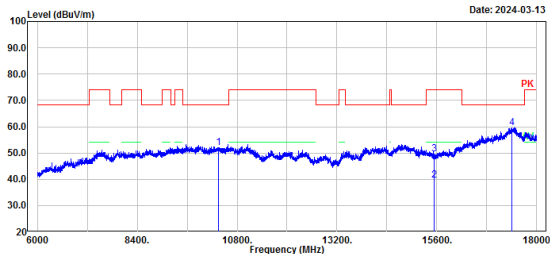

No.	Frequency (MHz)	Reading (dBμV)	Factor (dB/m)	Result (dBμV/m)	Limit (dBμV/m)	Margin (dB)	Detector
1	10360.00	45.42	6.49	51.91	68.20	16.29	Peak
2	15540.00	34.88	4.67	39.55	54.00	14.45	Average
3	15540.00	44.91	4.67	49.58	74.00	24.42	Peak
4	17409.60	44.38	15.15	59.53	68.20	8.67	Peak

Project No.: XMDN240206-08079E-RF
 Polarization: Vertical
 Test Mode: Transmitting
 Note: 802.11ax20_U-NII-1_low channel 5180MHz

Serial No.: 2HP4-4
 Tester: Colin Yang

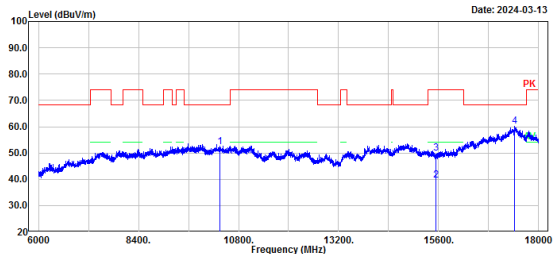

No.	Frequency (MHz)	Reading (dBμV)	Factor (dB/m)	Result (dBμV/m)	Limit (dBμV/m)	Margin (dB)	Detector
1	10360.00	45.76	6.49	52.25	68.20	15.95	Peak
2	15540.00	35.01	4.67	39.68	54.00	14.32	Average
3	15540.00	45.11	4.67	49.78	74.00	24.22	Peak
4	17421.60	44.88	15.25	60.13	68.20	8.07	Peak

802.11 ax he20 mode, Low Channel, Bandedge, Horizontal

Project No.: XMDN240206-08079E-RF Serial No.: ZHP4-4
 Polarization: Horizontal Tester: Colin Yang
 Test Mode: Transmitting
 Note: 802.11ax20_U-NII-1_low channel 5180MHz

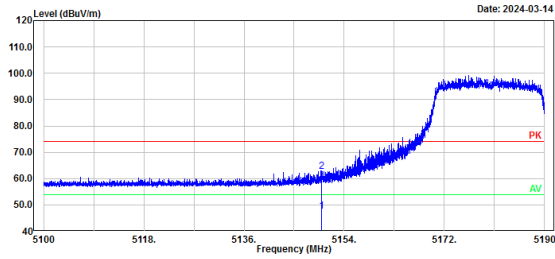

No.	Frequency (MHz)	Reading (dBμV)	Factor (dB/m)	Result (dBμV/m)	Limit (dBμV/m)	Margin (dB)	Detector
1	5150.00	18.75	28.68	47.43	54.00	6.57	Average
2	5150.00	34.06	28.68	62.74	74.00	11.26	Peak

802.11 ax he20 mode, Low Channel, Bandedge, Vertical

Project No.: XMDN240206-08079E-RF Serial No.: ZHP4-4
 Polarization: Vertical Tester: Colin Yang
 Test Mode: Transmitting
 Note: 802.11ax20_U-NII-1_low channel 5180MHz

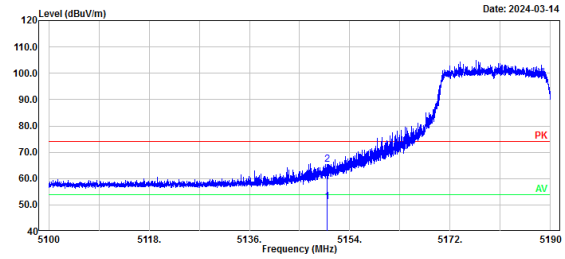

No.	Frequency (MHz)	Reading (dBμV)	Factor (dB/m)	Result (dBμV/m)	Limit (dBμV/m)	Margin (dB)	Detector
1	5150.00	22.63	28.68	51.31	54.00	2.69	Average
2	5150.00	36.81	28.68	65.49	74.00	8.51	Peak

802.11 ax he20 mode, Middle Channel, Horizontal

Project No.: XMDN240206-08079E-RF
 Polarization: Horizontal
 Test Mode: Transmitting
 Note: 802.11ax20_U-NII-1_middle channel 5200MHz

Serial No.: 2HP4-4
 Tester: Colin Yang

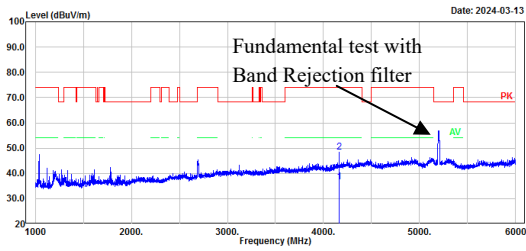

No.	Frequency (MHz)	Reading (dBuV)	Factor (dB/m)	Result (dBuV/m)	Limit (dBuV/m)	Margin (dB)	Detector
1	4161.00	40.15	-3.70	36.45	54.00	17.55	Average
2	4161.00	52.19	-3.70	48.49	74.00	25.51	Peak

802.11 ax he20 mode, Middle Channel, Vertical

Project No.: XMDN240206-08079E-RF
 Polarization: Vertical
 Test Mode: Transmitting
 Note: 802.11ax20_U-NII-1_middle channel 5200MHz

Serial No.: 2HP4-4
 Tester: Colin Yang

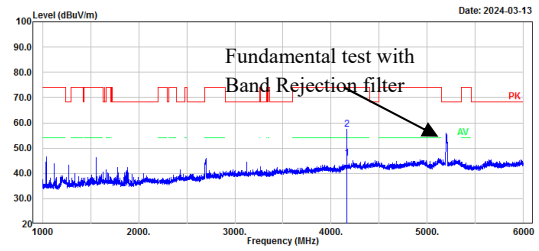

No.	Frequency (MHz)	Reading (dBuV)	Factor (dB/m)	Result (dBuV/m)	Limit (dBuV/m)	Margin (dB)	Detector
1	4160.00	49.52	-3.70	45.82	54.00	8.18	Average
2	4160.00	61.01	-3.70	57.31	74.00	16.69	Peak

Project No.: XMDN240206-08079E-RF
 Polarization: Horizontal
 Test Mode: Transmitting
 Note: 802.11ax20_U-NII-1_middle channel 5200MHz

Serial No.: 2HP4-4
 Tester: Colin Yang

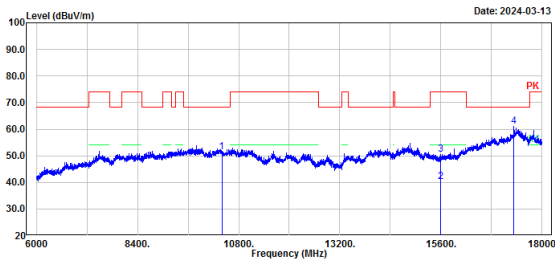

No.	Frequency (MHz)	Reading (dBuV)	Factor (dB/m)	Result (dBuV/m)	Limit (dBuV/m)	Margin (dB)	Detector
1	10400.00	45.06	6.44	51.50	68.20	16.70	Peak
2	15600.00	35.36	4.77	40.13	54.00	13.87	Average
3	15600.00	45.74	4.77	50.51	74.00	23.49	Peak
4	17332.80	46.52	14.52	61.04	68.20	7.16	Peak

Project No.: XMDN240206-08079E-RF
 Polarization: Vertical
 Test Mode: Transmitting
 Note: 802.11ax20_U-NII-1_middle channel 5200MHz

Serial No.: 2HP4-4
 Tester: Colin Yang

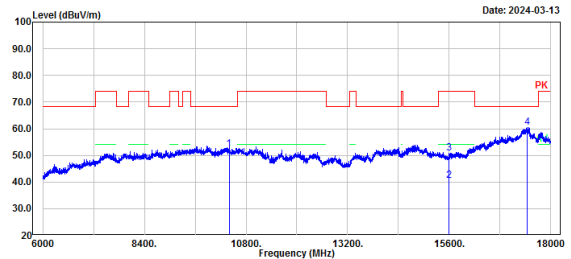

No.	Frequency (MHz)	Reading (dBuV)	Factor (dB/m)	Result (dBuV/m)	Limit (dBuV/m)	Margin (dB)	Detector
1	10400.00	45.96	6.44	52.40	68.20	15.80	Peak
2	15600.00	35.86	4.77	40.63	54.00	13.37	Average
3	15600.00	46.04	4.77	50.81	74.00	23.19	Peak
4	17443.20	45.01	15.42	60.43	68.20	7.77	Peak

802.11 ax he20 mode, High Channel, Horizontal

Project No.: XMDN240206-08079E-RF
 Polarization: Horizontal
 Test Mode: Transmitting
 Note: 802.11ax20_U-NII-1_high channel 5240MHz

Serial No.: 2HP4-4
 Tester: Colin Yang

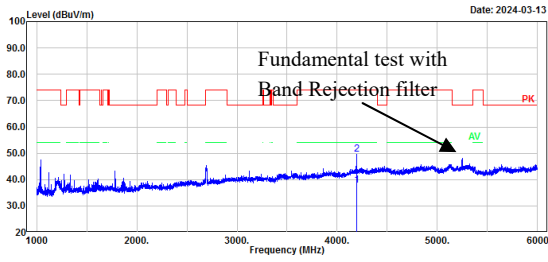

No.	Frequency (MHz)	Reading (dBuV)	Factor (dB/m)	Result (dBuV/m)	Limit (dBuV/m)	Margin (dB)	Detector
1	4192.00	41.28	-3.54	37.74	54.00	16.26	Average
2	4192.00	53.14	-3.54	49.60	74.00	24.40	Peak

802.11 ax he20 mode, High Channel, Vertical

Project No.: XMDN240206-08079E-RF
 Polarization: Vertical
 Test Mode: Transmitting
 Note: 802.11ax20_U-NII-1_high channel 5240MHz

Serial No.: 2HP4-4
 Tester: Colin Yang

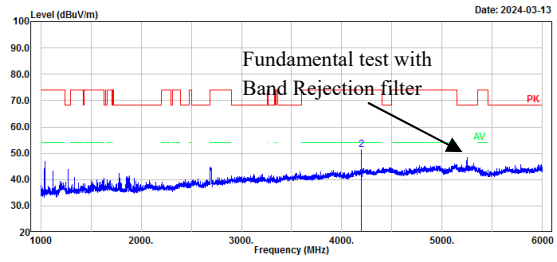

No.	Frequency (MHz)	Reading (dBuV)	Factor (dB/m)	Result (dBuV/m)	Limit (dBuV/m)	Margin (dB)	Detector
1	4192.00	43.40	-3.54	39.86	54.00	14.14	Average
2	4192.00	55.01	-3.54	51.47	74.00	22.53	Peak

Project No.: XMDN240206-08079E-RF
 Polarization: Horizontal
 Test Mode: Transmitting
 Note: 802.11ax20_U-NII-1_high channel 5240MHz

Serial No.: 2HP4-4
 Tester: Colin Yang

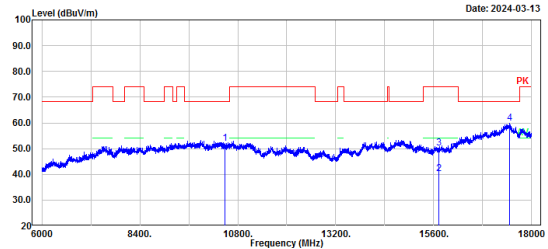

No.	Frequency (MHz)	Reading (dBuV)	Factor (dB/m)	Result (dBuV/m)	Limit (dBuV/m)	Margin (dB)	Detector
1	10480.00	45.34	6.60	51.94	68.20	16.26	Peak
2	15720.00	35.23	5.05	40.28	54.00	13.72	Average
3	15720.00	45.17	5.05	50.22	74.00	23.78	Peak
4	17457.60	44.21	15.53	59.74	68.20	8.46	Peak

Project No.: XMDN240206-08079E-RF
 Polarization: Vertical
 Test Mode: Transmitting
 Note: 802.11ax20_U-NII-1_high channel 5240MHz

Serial No.: 2HP4-4
 Tester: Colin Yang

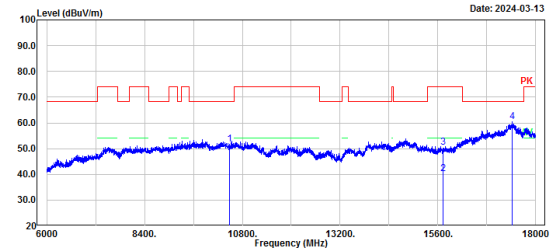

No.	Frequency (MHz)	Reading (dBuV)	Factor (dB/m)	Result (dBuV/m)	Limit (dBuV/m)	Margin (dB)	Detector
1	10480.00	45.15	6.60	51.75	68.20	16.45	Peak
2	15720.00	35.27	5.05	40.32	54.00	13.68	Average
3	15720.00	45.48	5.05	50.53	74.00	23.47	Peak
4	17414.40	45.23	15.19	60.42	68.20	7.78	Peak

802.11 ax he20 mode, High Channel, Bandedge, Horizontal

Project No.: XMDN240206-08079E-RF Serial No.: 2HP4-4
 Polarization: Horizontal Tester: Colin Yang
 Test Mode: Transmitting
 Note: 802.11ax20_U-NII-1_high channel 5240MHz

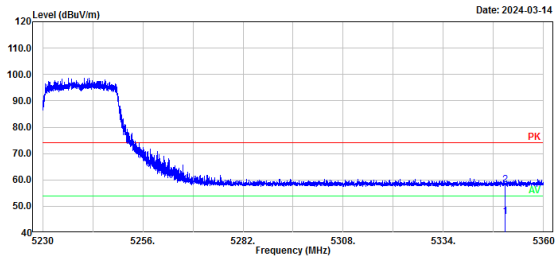

No.	Frequency (MHz)	Reading (dBμV)	Factor (dB/m)	Result (dBμV/m)	Limit (dBμV/m)	Margin (dB)	Detector
1	5350.00	16.87	29.16	46.03	54.00	7.97	Average
2	5350.00	28.99	29.16	58.15	74.00	15.85	Peak

802.11 ax he20 mode, High Channel, Bandedge, Vertical

Project No.: XMDN240206-08079E-RF Serial No.: 2HP4-4
 Polarization: Vertical Tester: Colin Yang
 Test Mode: Transmitting
 Note: 802.11ax20_U-NII-1_high channel 5240MHz

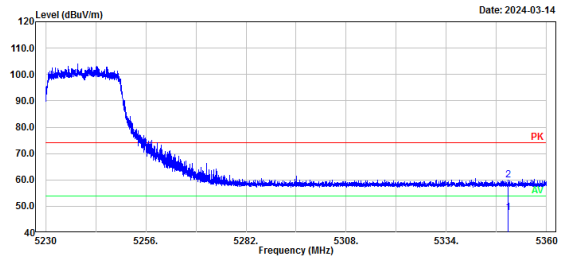

No.	Frequency (MHz)	Reading (dBμV)	Factor (dB/m)	Result (dBμV/m)	Limit (dBμV/m)	Margin (dB)	Detector
1	5350.00	18.24	29.16	47.40	54.00	6.60	Average
2	5350.00	30.82	29.16	59.98	74.00	14.02	Peak

802.11 ax he40 mode, Low Channel, Horizontal

Project No.: XMDN240206-08079E-RF
 Polarization: Horizontal
 Test Mode: Transmitting
 Note: 802.11ax40_U-NII-1_low channel 5190MHz

Serial No.: 2HP4-4
 Tester: Colin Yang

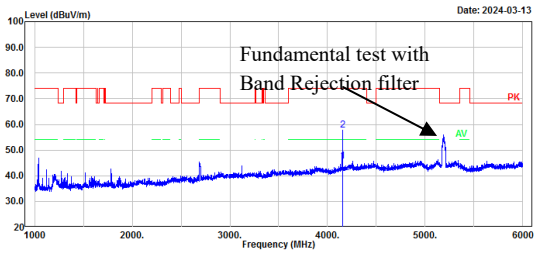

No.	Frequency (MHz)	Reading (dBuV)	Factor (dB/m)	Result (dBuV/m)	Limit (dBuV/m)	Margin (dB)	Detector
1	4152.00	49.36	-3.75	45.61	54.00	8.39	Average
2	4152.00	61.52	-3.75	57.77	74.00	16.23	Peak

802.11 ax he40 mode, Low Channel, Vertical

Project No.: XMDN240206-08079E-RF
 Polarization: Vertical
 Test Mode: Transmitting
 Note: 802.11ax40_U-NII-1_low channel 5190MHz

Serial No.: 2HP4-4
 Tester: Colin Yang

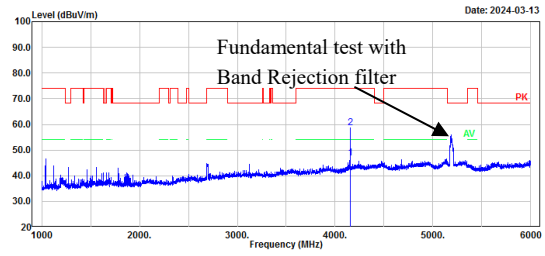

No.	Frequency (MHz)	Reading (dBuV)	Factor (dB/m)	Result (dBuV/m)	Limit (dBuV/m)	Margin (dB)	Detector
1	4152.00	50.68	-3.75	46.93	54.00	7.07	Average
2	4152.00	62.48	-3.75	58.73	74.00	15.27	Peak

Project No.: XMDN240206-08079E-RF
 Polarization: Horizontal
 Test Mode: Transmitting
 Note: 802.11ax40_U-NII-1_low channel 5190MHz

Serial No.: 2HP4-4
 Tester: Colin Yang

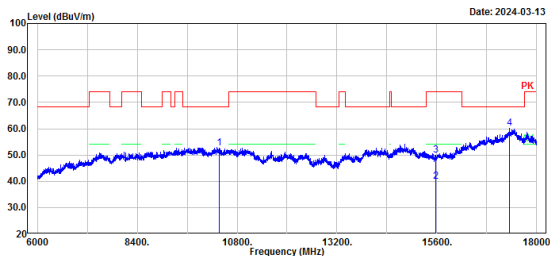

No.	Frequency (MHz)	Reading (dBuV)	Factor (dB/m)	Result (dBuV/m)	Limit (dBuV/m)	Margin (dB)	Detector
1	10380.00	46.09	6.47	52.56	68.20	15.64	Peak
2	15570.00	35.12	4.72	39.84	54.00	14.16	Average
3	15570.00	45.09	4.72	49.81	74.00	24.19	Peak
4	17342.40	45.53	14.60	60.13	68.20	8.07	Peak

Project No.: XMDN240206-08079E-RF
 Polarization: Vertical
 Test Mode: Transmitting
 Note: 802.11ax40_U-NII-1_low channel 5190MHz

Serial No.: 2HP4-4
 Tester: Colin Yang

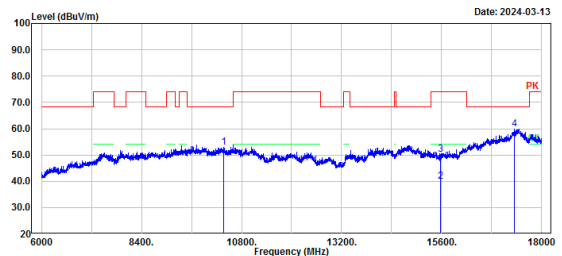

No.	Frequency (MHz)	Reading (dBuV)	Factor (dB/m)	Result (dBuV/m)	Limit (dBuV/m)	Margin (dB)	Detector
1	10380.00	46.50	6.47	52.97	68.20	15.23	Peak
2	15570.00	35.32	4.72	40.04	54.00	13.96	Average
3	15570.00	45.46	4.72	50.18	74.00	23.82	Peak
4	17340.00	45.36	14.58	59.94	68.20	8.26	Peak

802.11 ax he40 mode, Low Channel, Bandedge, Horizontal

Project No.: XMDN240206-08079E-RF Serial No.: ZHP4-4
 Polarization: Horizontal Tester: Colin Yang
 Test Mode: Transmitting
 Note: 802.11ax40_U-NII-1_low channel 5190MHz

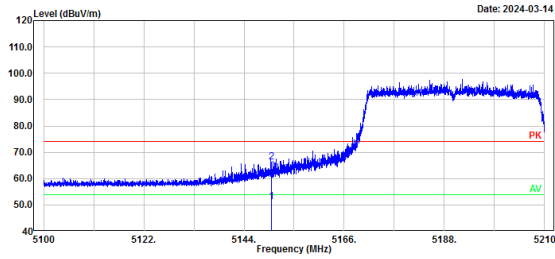

No.	Frequency (MHz)	Reading (dBμV)	Factor (dB/m)	Result (dBμV/m)	Limit (dBμV/m)	Margin (dB)	Detector
1	5150.00	22.54	28.68	51.22	54.00	2.78	Average
2	5150.00	37.72	28.68	66.40	74.00	7.60	Peak

802.11 ax he40 mode, Low Channel, Bandedge, Vertical

Project No.: XMDN240206-08079E-RF Serial No.: ZHP4-4
 Polarization: Vertical Tester: Colin Yang
 Test Mode: Transmitting
 Note: 802.11ax40_U-NII-1_low channel 5190MHz

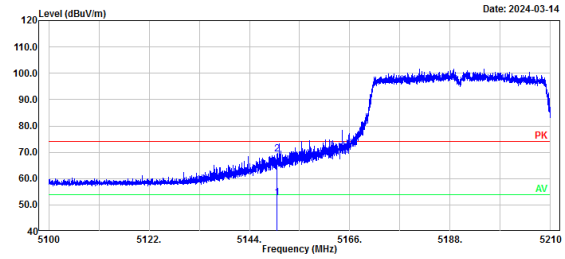

No.	Frequency (MHz)	Reading (dBμV)	Factor (dB/m)	Result (dBμV/m)	Limit (dBμV/m)	Margin (dB)	Detector
1	5150.00	23.96	28.68	52.64	54.00	1.36	Average
2	5150.00	40.50	28.68	69.18	74.00	4.82	Peak

802.11 ax he40 mode, High Channel, Horizontal

Project No.: XMDN240206-08079E-RF Serial No.: 2HP4-4
 Polarization: Horizontal Tester: Colin Yang
 Test Mode: Transmitting
 Note: 802.11ax40_U-NII-1_high channel 5230MHz

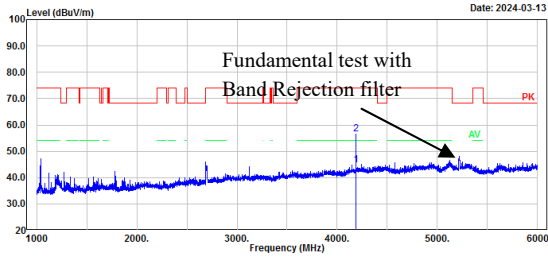

No.	Frequency (MHz)	Reading (dBuV)	Factor (dB/m)	Result (dBuV/m)	Limit (dBuV/m)	Margin (dB)	Detector
1	4184.00	48.35	-3.57	44.78	54.00	9.22	Average
2	4184.00	60.06	-3.57	56.49	74.00	17.51	Peak

802.11 ax he40 mode, High Channel, Vertical

Project No.: XMDN240206-08079E-RF Serial No.: 2HP4-4
 Polarization: Vertical Tester: Colin Yang
 Test Mode: Transmitting
 Note: 802.11ax40_U-NII-1_high channel 5230MHz

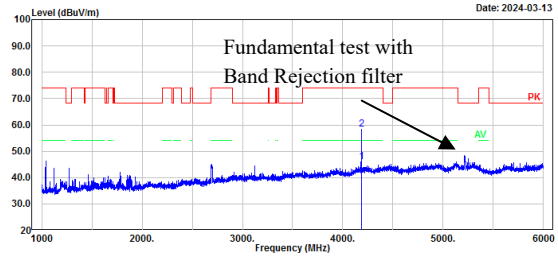

No.	Frequency (MHz)	Reading (dBuV)	Factor (dB/m)	Result (dBuV/m)	Limit (dBuV/m)	Margin (dB)	Detector
1	4184.00	49.52	-3.57	45.95	54.00	8.05	Average
2	4184.00	61.88	-3.57	58.31	74.00	15.69	Peak

Project No.: XMDN240206-08079E-RF Serial No.: 2HP4-4
 Polarization: Horizontal Tester: Colin Yang
 Test Mode: Transmitting
 Note: 802.11ax40_U-NII-1_high channel 5230MHz

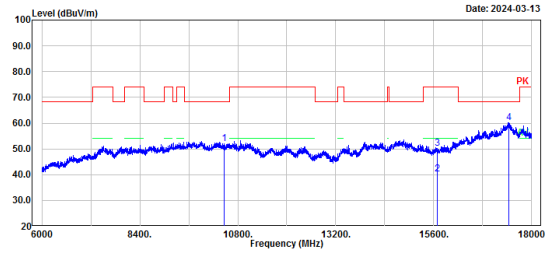

No.	Frequency (MHz)	Reading (dBuV)	Factor (dB/m)	Result (dBuV/m)	Limit (dBuV/m)	Margin (dB)	Detector
1	10460.00	45.46	6.56	52.02	68.20	16.18	Peak
2	15690.00	35.36	4.97	40.33	54.00	13.67	Average
3	15690.00	45.27	4.97	50.24	74.00	23.76	Peak
4	17433.60	44.92	15.34	60.26	68.20	7.94	Peak

Project No.: XMDN240206-08079E-RF Serial No.: 2HP4-4
 Polarization: Vertical Tester: Colin Yang
 Test Mode: Transmitting
 Note: 802.11ax40_U-NII-1_high channel 5230MHz

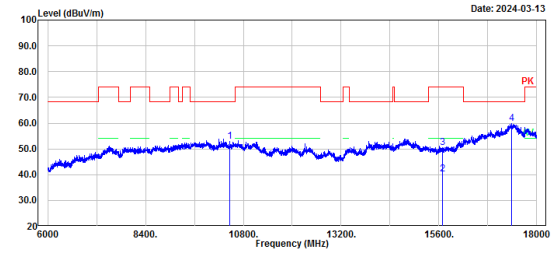

No.	Frequency (MHz)	Reading (dBuV)	Factor (dB/m)	Result (dBuV/m)	Limit (dBuV/m)	Margin (dB)	Detector
1	10460.00	46.31	6.56	52.87	68.20	15.33	Peak
2	15690.00	35.27	4.97	40.24	54.00	13.76	Average
3	15690.00	45.42	4.97	50.39	74.00	23.61	Peak
4	17380.80	45.02	14.92	59.94	68.20	8.26	Peak

802.11ax ht40 mode, High Channel, Bandedge, Horizontal

Project No.: XMDN240206-08079E-RF Serial No.: 2HP4-4
 Polarization: Horizontal Tester: Colin Yang
 Test Mode: Transmitting
 Note: 802.11ax40_U-NII-1_high channel 5230MHz

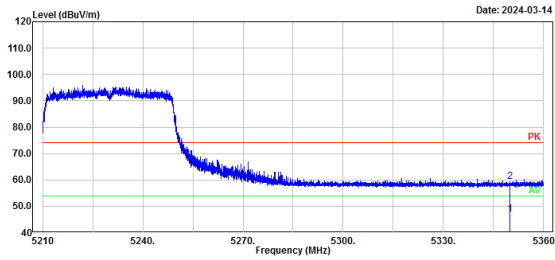

No.	Frequency (MHz)	Reading (dBuV)	Factor (dB/m)	Result (dBuV/m)	Limit (dBuV/m)	Margin (dB)	Detector
1	5350.00	17.78	29.16	46.94	54.00	7.06	Average
2	5350.00	30.16	29.16	59.32	74.00	14.68	Peak

802.11 ax he40 mode, High Channel, Bandedge, Vertical

Project No.: XMDN240206-08079E-RF Serial No.: 2HP4-4
 Polarization: Vertical Tester: Colin Yang
 Test Mode: Transmitting
 Note: 802.11ax40_U-NII-1_high channel 5230MHz

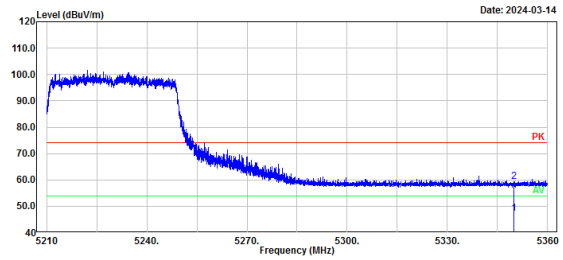

No.	Frequency (MHz)	Reading (dBuV)	Factor (dB/m)	Result (dBuV/m)	Limit (dBuV/m)	Margin (dB)	Detector
1	5350.00	18.01	29.16	47.17	54.00	6.83	Average
2	5350.00	30.02	29.16	59.18	74.00	14.82	Peak

802.11ax80 mode, Middle Channel, Horizontal

Project No.: XMDN240206-08079E-RF
 Polarization: Horizontal
 Test Mode: Transmitting
 Note: 802.11ax80_U-NII-1_middle channel 5210MHz

Serial No.: 2HP4-4
 Tester: Colin Yang

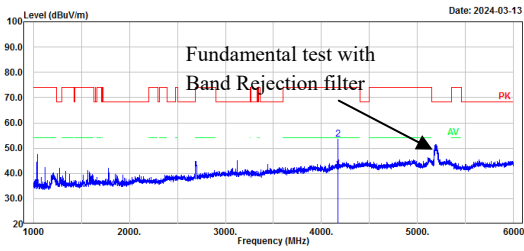

No.	Frequency (MHz)	Reading (dBuV)	Factor (dB/m)	Result (dBuV/m)	Limit (dBuV/m)	Margin (dB)	Detector
1	4168.00	45.31	-3.66	41.65	54.00	12.35	Average
2	4168.00	57.16	-3.66	53.50	74.00	20.50	Peak

802.11ax80 mode, Middle Channel, Vertical

Project No.: XMDN240206-08079E-RF
 Polarization: Vertical
 Test Mode: Transmitting
 Note: 802.11ax80_U-NII-1_middle channel 5210MHz

Serial No.: 2HP4-4
 Tester: Colin Yang

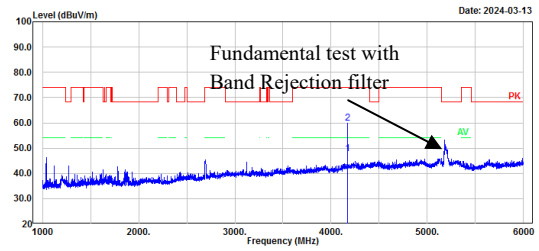

No.	Frequency (MHz)	Reading (dBuV)	Factor (dB/m)	Result (dBuV/m)	Limit (dBuV/m)	Margin (dB)	Detector
1	4168.00	51.33	-3.66	47.67	54.00	6.33	Average
2	4168.00	63.56	-3.66	59.90	74.00	14.10	Peak

Project No.: XMDN240206-08079E-RF
 Polarization: Horizontal
 Test Mode: Transmitting
 Note: 802.11ax80_U-NII-1_middle channel 5210MHz

Serial No.: 2HP4-4
 Tester: Colin Yang

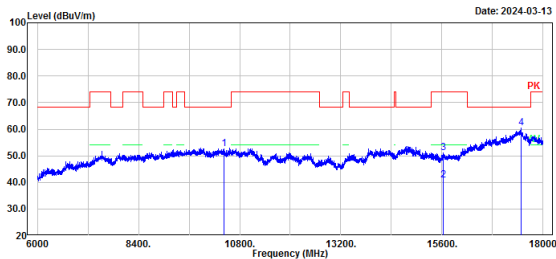

No.	Frequency (MHz)	Reading (dBuV)	Factor (dB/m)	Result (dBuV/m)	Limit (dBuV/m)	Margin (dB)	Detector
1	10420.00	46.13	6.47	52.60	68.20	15.60	Peak
2	15630.00	35.93	4.84	40.77	54.00	13.23	Average
3	15630.00	46.30	4.84	51.14	74.00	22.86	Peak
4	17474.40	44.76	15.67	60.43	68.20	7.77	Peak

Project No.: XMDN240206-08079E-RF
 Polarization: Vertical
 Test Mode: Transmitting
 Note: 802.11ax80_U-NII-1_middle channel 5210MHz

Serial No.: 2HP4-4
 Tester: Colin Yang

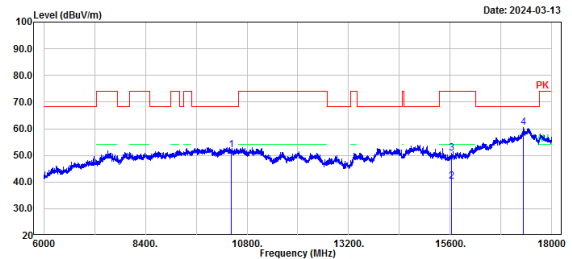

No.	Frequency (MHz)	Reading (dBuV)	Factor (dB/m)	Result (dBuV/m)	Limit (dBuV/m)	Margin (dB)	Detector
1	10420.00	45.57	6.47	52.04	68.20	16.16	Peak
2	15630.00	35.45	4.84	40.29	54.00	13.71	Average
3	15630.00	45.83	4.84	50.67	74.00	23.33	Peak
4	17328.00	45.85	14.49	60.34	68.20	7.86	Peak

802.11 ax 80 mode, Middle Channel, Bandedge, Horizontal

Project No.: XMDN240206-08079E-RF
 Polarization: Horizontal
 Test Mode: Transmitting
 Note: 802.11ax80_U-NII-1_middle channel 5210MHz

Serial No.: ZHP4-4
 Tester: Colin Yang

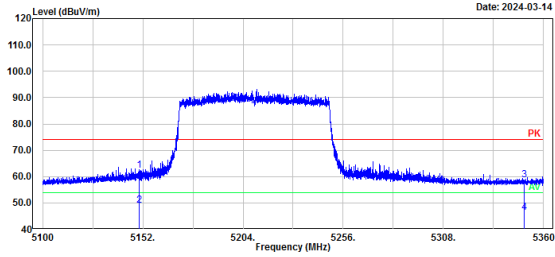

No.	Frequency (MHz)	Reading (dBuV)	Factor (dB/m)	Result (dBuV/m)	Limit (dBuV/m)	Margin (dB)	Detector
1	5150.00	33.64	28.68	62.32	74.00	11.68	Peak
2	5150.00	20.48	28.68	49.16	54.00	4.84	Average
3	5350.00	29.55	29.16	58.71	74.00	15.29	Peak
4	5350.00	17.24	29.16	46.40	54.00	7.60	Average

802.11 ax 80 mode, Middle Channel, Bandedge, Vertical

Project No.: XMDN240206-08079E-RF
 Polarization: Vertical
 Test Mode: Transmitting
 Note: 802.11ax80_U-NII-1_middle channel 5210MHz

Serial No.: ZHP4-4
 Tester: Colin Yang

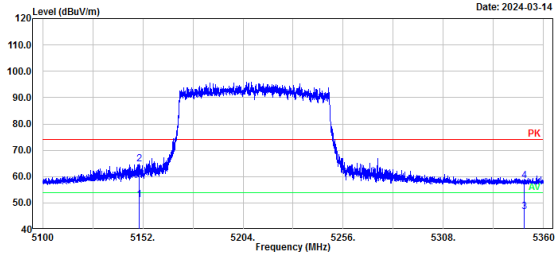

No.	Frequency (MHz)	Reading (dBuV)	Factor (dB/m)	Result (dBuV/m)	Limit (dBuV/m)	Margin (dB)	Detector
1	5150.00	22.35	28.68	51.03	54.00	2.97	Average
2	5150.00	36.13	28.68	64.81	74.00	9.19	Peak
3	5350.00	17.52	29.16	46.68	54.00	7.32	Average
4	5350.00	29.21	29.16	58.37	74.00	15.63	Peak

5250-5350MHz :

802.11a mode, Low Channel, Horizontal

Project No.: XMDN240206-08079E-RF Serial No.: ZHP4-4
 Polarization: Horizontal Tester: Colin Yang
 Test Mode: Transmitting
 Note: 802.11a_U-NII-2A_low channel 5260MHz

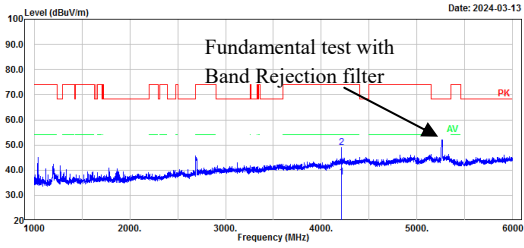

No.	Frequency (MHz)	Reading (dBuV)	Factor (dB/m)	Result (dBuV/m)	Limit (dBuV/m)	Margin (dB)	Detector
1	4208.00	40.58	-3.50	37.08	54.00	16.92	Average
2	4208.00	52.45	-3.50	48.95	74.00	25.05	Peak

802.11a mode, Low Channel, Vertical

Project No.: XMDN240206-08079E-RF Serial No.: ZHP4-4
 Polarization: Vertical Tester: Colin Yang
 Test Mode: Transmitting
 Note: 802.11a_U-NII-2A_low channel 5260MHz

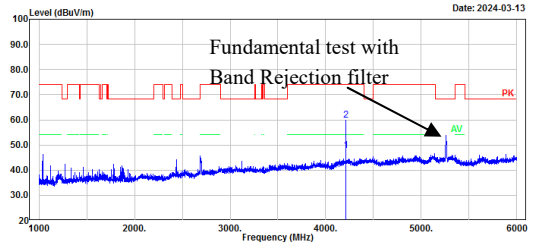

No.	Frequency (MHz)	Reading (dBuV)	Factor (dB/m)	Result (dBuV/m)	Limit (dBuV/m)	Margin (dB)	Detector
1	4208.00	51.28	-3.50	47.78	54.00	6.22	Average
2	4208.00	63.46	-3.50	59.96	74.00	14.04	Peak

Project No.: XMDN240206-08079E-RF Serial No.: ZHP4-4
 Polarization: Horizontal Tester: Colin Yang
 Test Mode: Transmitting
 Note: 802.11a_U-NII-2A_low channel 5260MHz

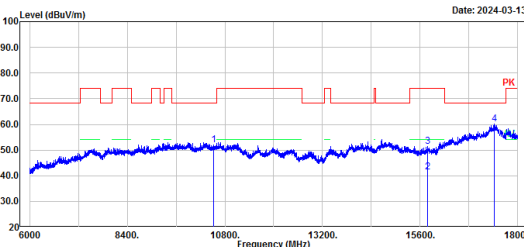

No.	Frequency (MHz)	Reading (dBuV)	Factor (dB/m)	Result (dBuV/m)	Limit (dBuV/m)	Margin (dB)	Detector
1	10520.00	45.49	6.63	52.12	68.20	16.08	Peak
2	15780.00	36.12	5.21	41.33	54.00	12.67	Average
3	15780.00	46.28	5.21	51.49	74.00	22.51	Peak
4	17416.00	44.86	15.22	60.08	68.20	8.12	Peak

Project No.: XMDN240206-08079E-RF Serial No.: ZHP4-4
 Polarization: Vertical Tester: Colin Yang
 Test Mode: Transmitting
 Note: 802.11a_U-NII-2A_low channel 5260MHz

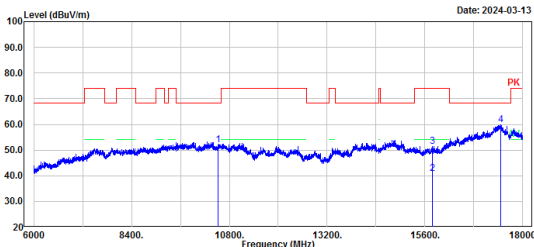

No.	Frequency (MHz)	Reading (dBuV)	Factor (dB/m)	Result (dBuV/m)	Limit (dBuV/m)	Margin (dB)	Detector
1	10520.00	45.44	6.63	52.07	68.20	16.13	Peak
2	15780.00	35.68	5.21	40.89	54.00	13.11	Average
3	15780.00	46.04	5.21	51.25	74.00	22.75	Peak
4	17455.20	44.46	15.51	59.97	68.20	8.23	Peak

802.11a mode, Low Channel, Bandedge, Horizontal

Project No.: XMDN240206-08079E-RF Serial No.: 2HP4-4
 Polarization: Horizontal Tester: Colin Yang
 Test Mode: Transmitting
 Note: 802.11a_U-NII-2A_low channel 5260MHz

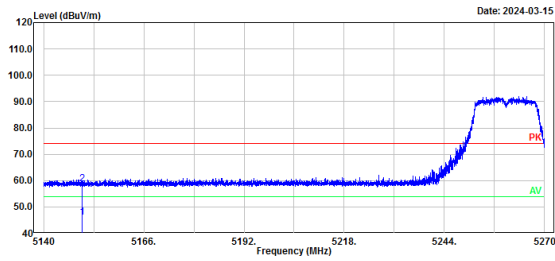

No.	Frequency (MHz)	Reading (dBμV)	Factor (dB/m)	Result (dBμV/m)	Limit (dBμV/m)	Margin (dB)	Detector
1	5150.00	17.35	28.68	46.03	54.00	7.97	Average
2	5150.00	29.94	28.68	58.62	74.00	15.38	Peak

802.11a mode, Low Channel, Bandedge, Vertical

Project No.: XMDN240206-08079E-RF Serial No.: 2HP4-4
 Polarization: Vertical Tester: Colin Yang
 Test Mode: Transmitting
 Note: 802.11a_U-NII-2A_low channel 5260MHz

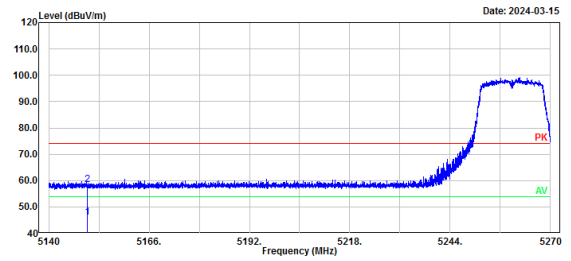

No.	Frequency (MHz)	Reading (dBμV)	Factor (dB/m)	Result (dBμV/m)	Limit (dBμV/m)	Margin (dB)	Detector
1	5150.00	17.35	28.68	46.03	54.00	7.97	Average
2	5150.00	29.65	28.68	58.33	74.00	15.67	Peak

802.11a mode, Middle Channel, Horizontal

Project No.: XMDN240206-08079E-RF Serial No.: 2HP4-4
 Polarization: Horizontal Tester: Colin Yang
 Test Mode: Transmitting
 Note: 802.11a_U-NII-2A_middle channel 5280MHz

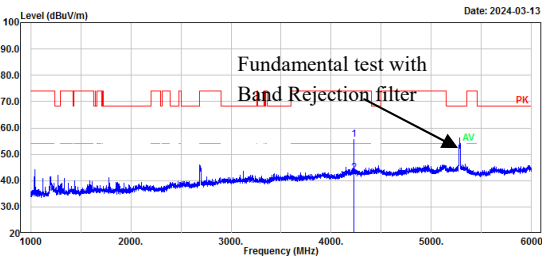

No.	Frequency (MHz)	Reading (dBuV)	Factor (dB/m)	Result (dBuV/m)	Limit (dBuV/m)	Margin (dB)	Detector
1	4225.00	59.07	-3.52	55.55	74.00	18.45	Peak
2	4225.00	46.39	-3.52	42.87	54.00	11.13	Average

802.11a mode, Middle Channel, Vertical

Project No.: XMDN240206-08079E-RF Serial No.: 2HP4-4
 Polarization: Vertical Tester: Colin Yang
 Test Mode: Transmitting
 Note: 802.11a_U-NII-2A_middle channel 5280MHz

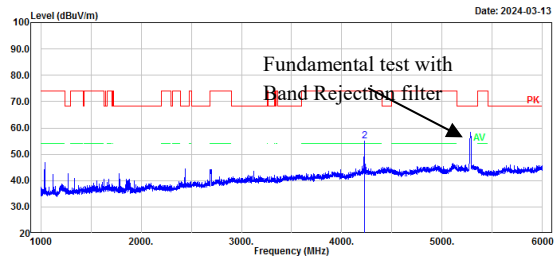

No.	Frequency (MHz)	Reading (dBuV)	Factor (dB/m)	Result (dBuV/m)	Limit (dBuV/m)	Margin (dB)	Detector
1	4224.00	46.15	-3.52	42.63	54.00	11.37	Average
2	4224.00	58.68	-3.52	55.16	74.00	18.84	Peak

Project No.: XMDN240206-08079E-RF Serial No.: 2HP4-4
 Polarization: Horizontal Tester: Colin Yang
 Test Mode: Transmitting
 Note: 802.11a_U-NII-2A_middle channel 5280MHz

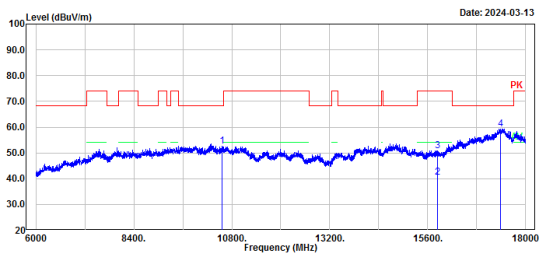

No.	Frequency (MHz)	Reading (dBuV)	Factor (dB/m)	Result (dBuV/m)	Limit (dBuV/m)	Margin (dB)	Detector
1	10560.00	45.96	6.63	52.59	68.20	15.61	Peak
2	15840.00	35.37	5.27	40.64	54.00	13.36	Average
3	15840.00	45.65	5.27	50.92	74.00	23.08	Peak
4	17380.00	44.44	14.91	59.35	68.20	8.85	Peak

Project No.: XMDN240206-08079E-RF Serial No.: 2HP4-4
 Polarization: Vertical Tester: Colin Yang
 Test Mode: Transmitting
 Note: 802.11a_U-NII-2A_middle channel 5280MHz

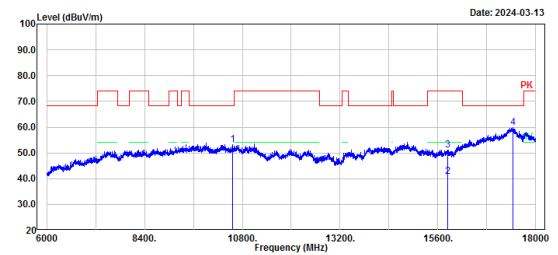

No.	Frequency (MHz)	Reading (dBuV)	Factor (dB/m)	Result (dBuV/m)	Limit (dBuV/m)	Margin (dB)	Detector
1	10560.00	46.64	6.63	53.27	68.20	14.93	Peak
2	15840.00	35.46	5.27	40.73	54.00	13.27	Average
3	15840.00	45.89	5.27	51.16	74.00	22.84	Peak
4	17445.60	44.48	15.44	59.92	68.20	8.28	Peak

802.11a mode, High Channel, Horizontal

Project No.: XMDN240206-08079E-RF
 Polarization: Horizontal
 Test Mode: Transmitting
 Note: 802.11a_U-NII-2A_high channel 5320MHz

Serial No.: 2HP4-4
 Tester: Colin Yang

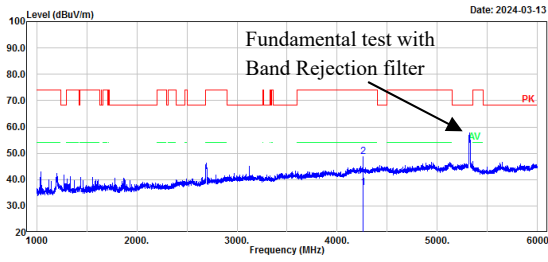

No.	Frequency (MHz)	Reading (dBuV)	Factor (dB/m)	Result (dBuV/m)	Limit (dBuV/m)	Margin (dB)	Detector
1	4256.00	40.38	-3.56	36.82	54.00	17.18	Average
2	4256.00	52.09	-3.56	48.53	74.00	25.47	Peak

802.11a mode, High Channel, Vertical

Project No.: XMDN240206-08079E-RF
 Polarization: Vertical
 Test Mode: Transmitting
 Note: 802.11a_U-NII-2A_high channel 5320MHz

Serial No.: 2HP4-4
 Tester: Colin Yang

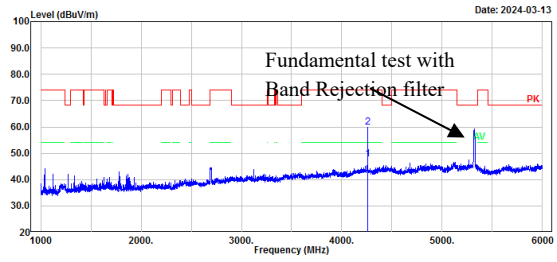

No.	Frequency (MHz)	Reading (dBuV)	Factor (dB/m)	Result (dBuV/m)	Limit (dBuV/m)	Margin (dB)	Detector
1	4256.00	51.26	-3.56	47.70	54.00	6.30	Average
2	4256.00	63.36	-3.56	59.80	74.00	14.20	Peak

Project No.: XMDN240206-08079E-RF
 Polarization: Horizontal
 Test Mode: Transmitting
 Note: 802.11a_U-NII-2A_high channel 5320MHz

Serial No.: 2HP4-4
 Tester: Colin Yang

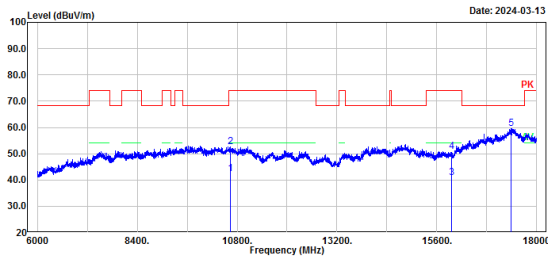

No.	Frequency (MHz)	Reading (dBuV)	Factor (dB/m)	Result (dBuV/m)	Limit (dBuV/m)	Margin (dB)	Detector
1	10640.00	35.68	6.55	42.23	54.00	11.77	Average
2	10640.00	46.11	6.55	52.66	74.00	21.34	Peak
3	15960.00	35.39	5.45	40.84	54.00	13.16	Average
4	15960.00	45.25	5.45	50.70	74.00	23.30	Peak
5	17380.80	44.77	14.92	59.69	68.20	8.51	Peak

Project No.: XMDN240206-08079E-RF
 Polarization: Vertical
 Test Mode: Transmitting
 Note: 802.11a_U-NII-2A_high channel 5320MHz

Serial No.: 2HP4-4
 Tester: Colin Yang

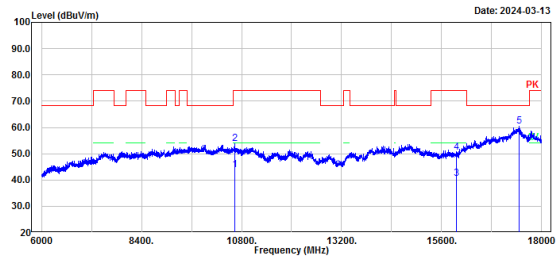

No.	Frequency (MHz)	Reading (dBuV)	Factor (dB/m)	Result (dBuV/m)	Limit (dBuV/m)	Margin (dB)	Detector
1	10640.00	37.36	6.55	43.91	54.00	10.09	Average
2	10640.00	47.40	6.55	53.95	74.00	20.05	Peak
3	15960.00	35.13	5.45	40.58	54.00	13.42	Average
4	15960.00	45.01	5.45	50.46	74.00	23.54	Peak
5	17450.40	44.84	15.48	60.32	68.20	7.88	Peak

802.11a mode, High Channel, Bandedge, Horizontal

Project No.: XMDN240206-08079E-RF Serial No.: 2HP4-4
 Polarization: Horizontal Tester: Colin Yang
 Test Mode: Transmitting
 Note: 802.11a_U-NII-2A_high channel 5320MHz

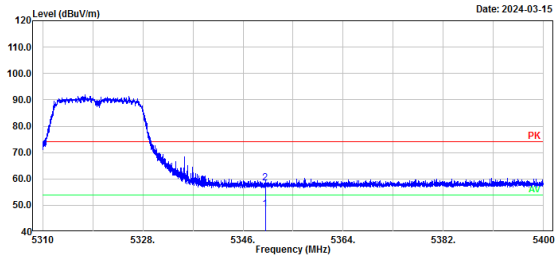

No.	Frequency (MHz)	Reading (dBuV)	Factor (dB/m)	Result (dBuV/m)	Limit (dBuV/m)	Margin (dB)	Detector
1	5350.00	19.36	29.16	48.52	54.00	5.48	Average
2	5350.00	29.33	29.16	58.49	74.00	15.51	Peak

802.11a mode, High Channel, Bandedge, Vertical

Project No.: XMDN240206-08079E-RF Serial No.: 2HP4-4
 Polarization: Vertical Tester: Colin Yang
 Test Mode: Transmitting
 Note: 802.11a_U-NII-2A_high channel 5320MHz

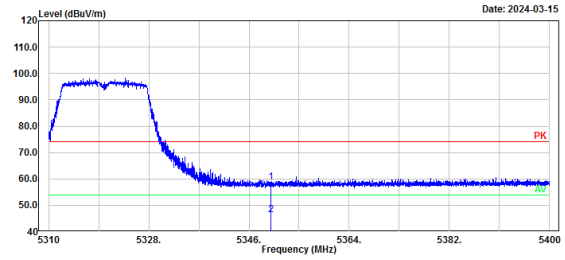

No.	Frequency (MHz)	Reading (dBuV)	Factor (dB/m)	Result (dBuV/m)	Limit (dBuV/m)	Margin (dB)	Detector
1	5350.00	29.65	29.16	58.81	74.00	15.19	Peak
2	5350.00	17.33	29.16	46.49	54.00	7.51	Average

802.11n ht20 mode, Low Channel, Horizontal

Project No.: XMDN240206-08079E-RF
 Polarization: Horizontal
 Test Mode: Transmitting
 Note: 802.11n20_U-NII-2A_low channel 5260MHz

Serial No.: 2HP4-4
 Tester: Colin Yang

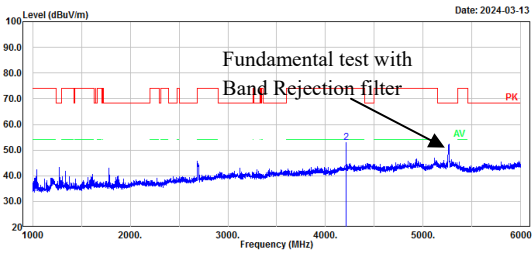

No.	Frequency (MHz)	Reading (dBμV)	Factor (dB/m)	Result (dBμV/m)	Limit (dBμV/m)	Margin (dB)	Detector
1	4208.00	44.29	-3.50	40.79	54.00	13.21	Average
2	4208.00	56.41	-3.50	52.91	74.00	21.09	Peak

802.11n ht20 mode, Low Channel, Vertical

Project No.: XMDN240206-08079E-RF
 Polarization: Vertical
 Test Mode: Transmitting
 Note: 802.11n20_U-NII-2A_low channel 5260MHz

Serial No.: 2HP4-4
 Tester: Colin Yang

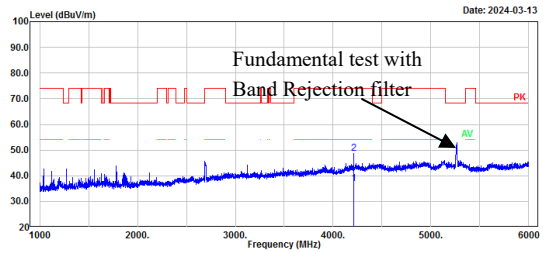

No.	Frequency (MHz)	Reading (dBμV)	Factor (dB/m)	Result (dBμV/m)	Limit (dBμV/m)	Margin (dB)	Detector
1	4209.00	40.27	-3.50	36.77	54.00	17.23	Average
2	4209.00	52.29	-3.50	48.79	74.00	25.21	Peak

Project No.: XMDN240206-08079E-RF
 Polarization: Horizontal
 Test Mode: Transmitting
 Note: 802.11n20_U-NII-2A_low channel 5260MHz

Serial No.: 2HP4-4
 Tester: Colin Yang

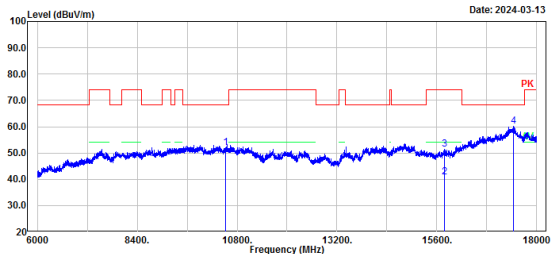

No.	Frequency (MHz)	Reading (dBμV)	Factor (dB/m)	Result (dBμV/m)	Limit (dBμV/m)	Margin (dB)	Detector
1	10520.00	45.52	6.63	52.15	68.20	16.05	Peak
2	15780.00	35.74	5.21	40.95	54.00	13.05	Average
3	15780.00	46.17	5.21	51.38	74.00	22.62	Peak
4	17443.20	44.67	15.42	60.09	68.20	8.11	Peak

Project No.: XMDN240206-08079E-RF
 Polarization: Vertical
 Test Mode: Transmitting
 Note: 802.11n20_U-NII-2A_low channel 5260MHz

Serial No.: 2HP4-4
 Tester: Colin Yang

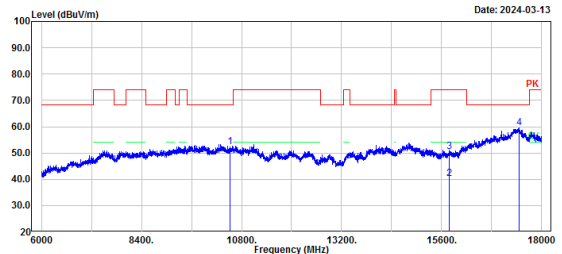

No.	Frequency (MHz)	Reading (dBμV)	Factor (dB/m)	Result (dBμV/m)	Limit (dBμV/m)	Margin (dB)	Detector
1	10520.00	45.59	6.63	52.22	68.20	15.98	Peak
2	15780.00	35.14	5.21	40.35	54.00	13.65	Average
3	15780.00	45.33	5.21	50.54	74.00	23.46	Peak
4	17450.40	43.98	15.48	59.46	68.20	8.74	Peak

802.11n ht20 mode, Low Channel, Bandedge, Horizontal

Project No.: XMDN240206-08079E-RF Serial No.: ZHP4-4
 Polarization: Horizontal Tester: Colin Yang
 Test Mode: Transmitting
 Note: 802.11n20_U-NII-2A_low channel 5260MHz

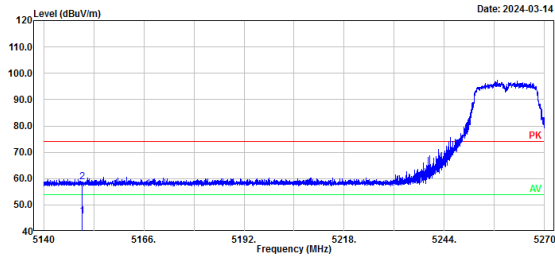

No.	Frequency (MHz)	Reading (dBuV)	Factor (dB/m)	Result (dBuV/m)	Limit (dBuV/m)	Margin (dB)	Detector
1	5150.00	17.02	28.68	45.70	54.00	8.30	Average
2	5150.00	30.07	28.68	58.75	74.00	15.25	Peak

802.11n ht20 mode, Low Channel, Bandedge, Vertical

Project No.: XMDN240206-08079E-RF Serial No.: ZHP4-4
 Polarization: Vertical Tester: Colin Yang
 Test Mode: Transmitting
 Note: 802.11n20_U-NII-2A_low channel 5260MHz

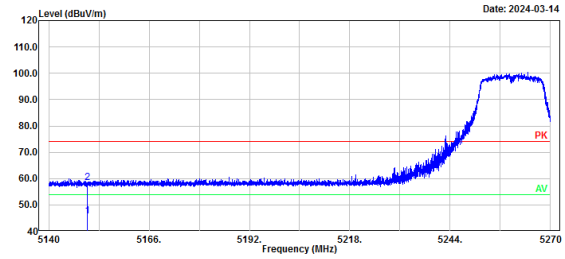

No.	Frequency (MHz)	Reading (dBuV)	Factor (dB/m)	Result (dBuV/m)	Limit (dBuV/m)	Margin (dB)	Detector
1	5150.00	17.03	28.68	45.71	54.00	8.29	Average
2	5150.00	29.85	28.68	58.53	74.00	15.47	Peak

802.11n ht20 mode, Middle Channel, Horizontal

Project No.: XMDN240206-08079E-RF Serial No.: 2HP4-4
 Polarization: Horizontal Tester: Colin Yang
 Test Mode: Transmitting
 Note: 802.11n20_U-NII-2A_middle channel 5280MHz

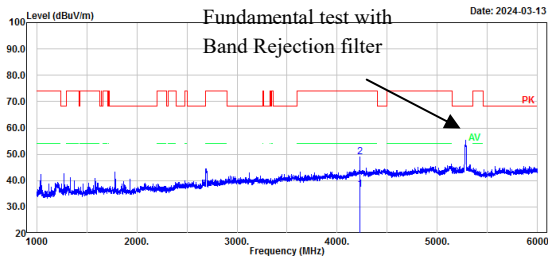

No.	Frequency (MHz)	Reading (dBuV)	Factor (dB/m)	Result (dBuV/m)	Limit (dBuV/m)	Margin (dB)	Detector
1	4225.00	40.21	-3.52	36.69	54.00	17.31	Average
2	4225.00	52.44	-3.52	48.92	74.00	25.08	Peak

802.11n ht20 mode, Middle Channel, Vertical

Project No.: XMDN240206-08079E-RF Serial No.: 2HP4-4
 Polarization: Vertical Tester: Colin Yang
 Test Mode: Transmitting
 Note: 802.11n20_U-NII-2A_middle channel 5280MHz

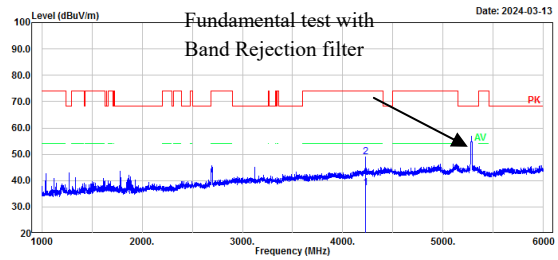

No.	Frequency (MHz)	Reading (dBuV)	Factor (dB/m)	Result (dBuV/m)	Limit (dBuV/m)	Margin (dB)	Detector
1	4224.00	40.69	-3.52	37.17	54.00	16.83	Average
2	4224.00	52.45	-3.52	48.93	74.00	25.07	Peak

Project No.: XMDN240206-08079E-RF Serial No.: 2HP4-4
 Polarization: Horizontal Tester: Colin Yang
 Test Mode: Transmitting
 Note: 802.11n20_U-NII-2A_middle channel 5280MHz

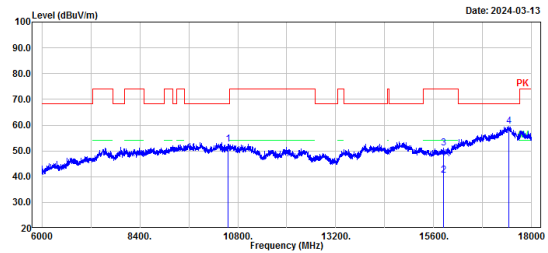

No.	Frequency (MHz)	Reading (dBuV)	Factor (dB/m)	Result (dBuV/m)	Limit (dBuV/m)	Margin (dB)	Detector
1	10560.00	46.09	6.63	52.72	68.20	15.48	Peak
2	15840.00	35.39	5.27	40.66	54.00	13.34	Average
3	15840.00	45.71	5.27	50.98	74.00	23.02	Peak
4	17438.40	44.18	15.39	59.57	68.20	8.63	Peak

Project No.: XMDN240206-08079E-RF Serial No.: 2HP4-4
 Polarization: Vertical Tester: Colin Yang
 Test Mode: Transmitting
 Note: 802.11n20_U-NII-2A_middle channel 5280MHz

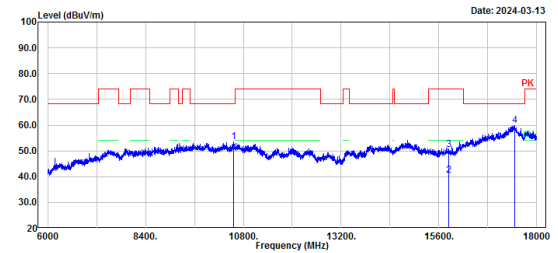

No.	Frequency (MHz)	Reading (dBuV)	Factor (dB/m)	Result (dBuV/m)	Limit (dBuV/m)	Margin (dB)	Detector
1	10560.00	46.84	6.63	53.47	68.20	14.73	Peak
2	15840.00	35.23	5.27	40.50	54.00	13.50	Average
3	15840.00	45.07	5.27	50.34	74.00	23.66	Peak
4	17452.80	44.21	15.50	59.71	68.20	8.49	Peak

802.11n ht20 mode, High Channel, Horizontal

Project No.: XMDN240206-08079E-RF Serial No.: 2HP4-4
 Polarization: Horizontal Tester: Colin Yang
 Test Mode: Transmitting
 Note: 802.11n20_U-NII-2A_high channel 5320MHz

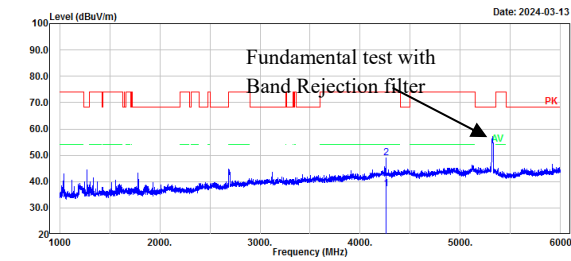

No.	Frequency (MHz)	Reading (dBuV)	Factor (dB/m)	Result (dBuV/m)	Limit (dBuV/m)	Margin (dB)	Detector
1	4256.00	40.71	-3.56	37.15	54.00	16.85	Average
2	4256.00	52.55	-3.56	48.99	74.00	25.01	Peak

802.11n ht20 mode, High Channel, Vertical

Project No.: XMDN240206-08079E-RF Serial No.: 2HP4-4
 Polarization: Vertical Tester: Colin Yang
 Test Mode: Transmitting
 Note: 802.11n20_U-NII-2A_high channel 5320MHz

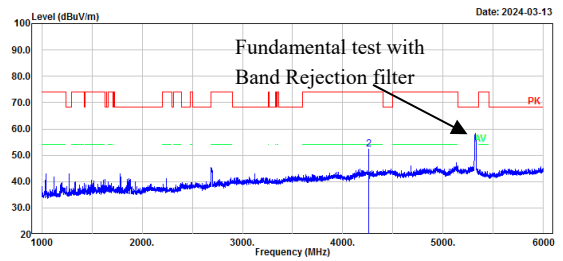

No.	Frequency (MHz)	Reading (dBuV)	Factor (dB/m)	Result (dBuV/m)	Limit (dBuV/m)	Margin (dB)	Detector
1	4257.00	43.37	-3.56	39.81	54.00	14.19	Average
2	4257.00	55.99	-3.56	52.43	74.00	21.57	Peak

Project No.: XMDN240206-08079E-RF Serial No.: 2HP4-4
 Polarization: Horizontal Tester: Colin Yang
 Test Mode: Transmitting
 Note: 802.11n20_U-NII-2A_high channel 5320MHz

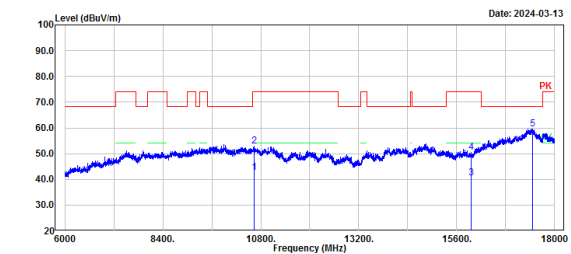

No.	Frequency (MHz)	Reading (dBuV)	Factor (dB/m)	Result (dBuV/m)	Limit (dBuV/m)	Margin (dB)	Detector
1	10640.00	36.13	6.55	42.68	54.00	11.32	Average
2	10640.00	46.36	6.55	52.91	74.00	21.09	Peak
3	15960.00	35.21	5.45	40.66	54.00	13.34	Average
4	15960.00	45.07	5.45	50.52	74.00	23.48	Peak
5	17450.40	44.16	15.48	59.64	68.20	8.56	Peak

Project No.: XMDN240206-08079E-RF Serial No.: 2HP4-4
 Polarization: Vertical Tester: Colin Yang
 Test Mode: Transmitting
 Note: 802.11n20_U-NII-2A_high channel 5320MHz

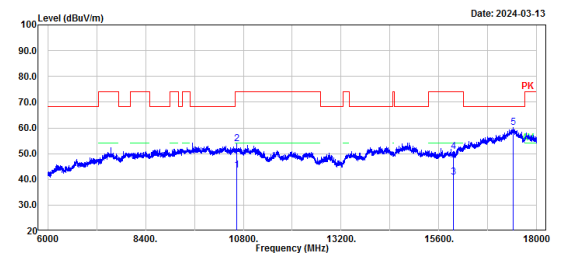

No.	Frequency (MHz)	Reading (dBuV)	Factor (dB/m)	Result (dBuV/m)	Limit (dBuV/m)	Margin (dB)	Detector
1	10640.00	36.85	6.55	43.40	54.00	10.60	Average
2	10640.00	47.30	6.55	53.85	74.00	20.15	Peak
3	15960.00	35.38	5.45	40.83	54.00	13.17	Average
4	15960.00	45.31	5.45	50.76	74.00	23.24	Peak
5	17421.60	45.05	15.25	60.30	68.20	7.90	Peak

802.11n ht20 mode, High Channel, Bandedge, Horizontal

Project No.: XMDN240206-08079E-RF Serial No.: 2HP4-4
 Polarization: Horizontal Tester: Colin Yang
 Test Mode: Transmitting
 Note: 802.11n20_U-NII-2A_high channel 5320MHz

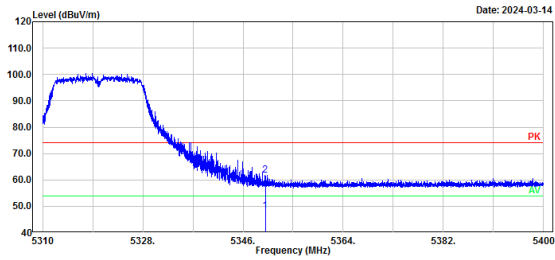

No.	Frequency (MHz)	Reading (dBuV)	Factor (dB/m)	Result (dBuV/m)	Limit (dBuV/m)	Margin (dB)	Detector
1	5350.00	18.85	29.16	48.01	54.00	5.99	Average
2	5350.00	32.67	29.16	61.83	74.00	12.17	Peak

802.11n ht20 mode, High Channel, Bandedge, Vertical

Project No.: XMDN240206-08079E-RF Serial No.: 2HP4-4
 Polarization: Vertical Tester: Colin Yang
 Test Mode: Transmitting
 Note: 802.11n20_U-NII-2A_high channel 5320MHz

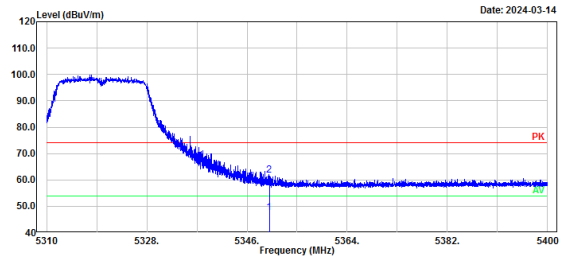

No.	Frequency (MHz)	Reading (dBuV)	Factor (dB/m)	Result (dBuV/m)	Limit (dBuV/m)	Margin (dB)	Detector
1	5350.00	18.35	29.16	47.51	54.00	6.49	Average
2	5350.00	32.64	29.16	61.80	74.00	12.20	Peak

802.11n ht40 mode, Low Channel, Horizontal

Project No.: XMDN240206-08079E-RF
 Polarization: Horizontal
 Test Mode: Transmitting
 Note: 802.11n40_U-NII-2A_low channel 5270MHz

Serial No.: 2HP4-4
 Tester: Colin Yang

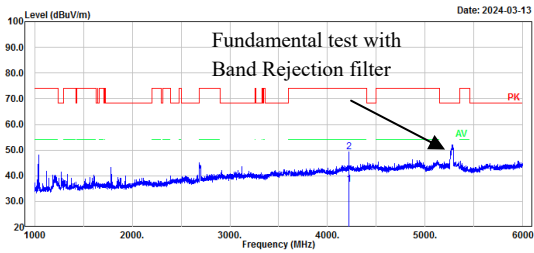

No.	Frequency (MHz)	Reading (dBuV)	Factor (dB/m)	Result (dBuV/m)	Limit (dBuV/m)	Margin (dB)	Detector
1	4216.00	40.21	-3.51	36.70	54.00	17.30	Average
2	4216.00	52.91	-3.51	49.40	74.00	24.60	Peak

802.11n ht40 mode, Low Channel, Vertical

Project No.: XMDN240206-08079E-RF
 Polarization: Vertical
 Test Mode: Transmitting
 Note: 802.11n40_U-NII-2A_low channel 5270MHz

Serial No.: 2HP4-4
 Tester: Colin Yang

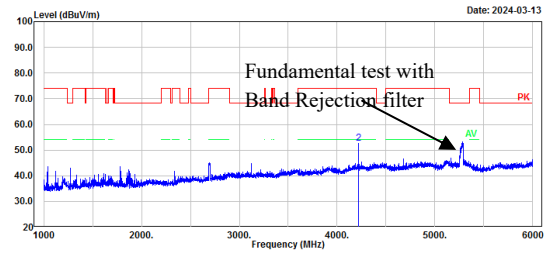

No.	Frequency (MHz)	Reading (dBuV)	Factor (dB/m)	Result (dBuV/m)	Limit (dBuV/m)	Margin (dB)	Detector
1	4216.00	44.37	-3.51	40.86	54.00	13.14	Average
2	4216.00	56.09	-3.51	52.58	74.00	21.42	Peak

Project No.: XMDN240206-08079E-RF
 Polarization: Horizontal
 Test Mode: Transmitting
 Note: 802.11n40_U-NII-2A_low channel 5270MHz

Serial No.: 2HP4-4
 Tester: Colin Yang

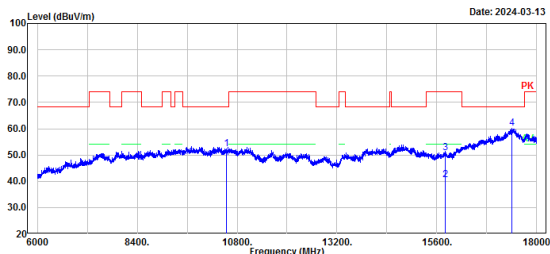

No.	Frequency (MHz)	Reading (dBuV)	Factor (dB/m)	Result (dBuV/m)	Limit (dBuV/m)	Margin (dB)	Detector
1	10540.00	45.68	6.62	52.30	68.20	15.90	Peak
2	15810.00	35.29	5.27	40.56	54.00	13.44	Average
3	15810.00	45.49	5.27	50.76	74.00	23.24	Peak
4	17487.20	44.93	15.13	60.06	68.20	8.14	Peak

Project No.: XMDN240206-08079E-RF
 Polarization: Vertical
 Test Mode: Transmitting
 Note: 802.11n40_U-NII-2A_low channel 5270MHz

Serial No.: 2HP4-4
 Tester: Colin Yang

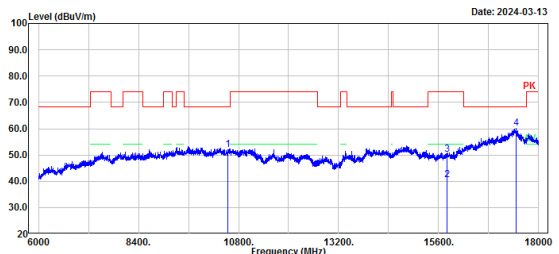

No.	Frequency (MHz)	Reading (dBuV)	Factor (dB/m)	Result (dBuV/m)	Limit (dBuV/m)	Margin (dB)	Detector
1	10540.00	45.30	6.62	51.92	68.20	16.28	Peak
2	15810.00	35.36	5.27	40.63	54.00	13.37	Average
3	15810.00	45.06	5.27	50.33	74.00	23.67	Peak
4	17450.40	44.59	15.48	60.07	68.20	8.13	Peak

802.11n ht40 mode, Low Channel, Bandedge, Horizontal

Project No.: XMDN240206-08079E-RF
 Polarization: Horizontal
 Test Mode: Transmitting
 Note: 802.11n40_U-NII-2A_low channel 5270MHz

Serial No.: ZHP4-4
 Tester: Colin Yang

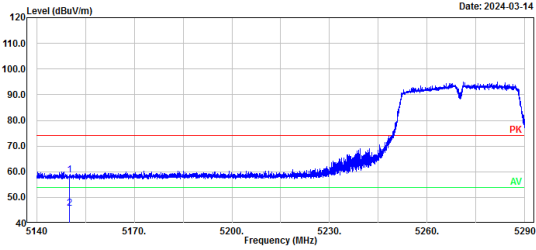

No.	Frequency (MHz)	Reading (dBuV)	Factor (dB/m)	Result (dBuV/m)	Limit (dBuV/m)	Margin (dB)	Detector
1	5150.00	30.04	28.68	58.72	74.00	15.28	Peak
2	5150.00	17.01	28.68	45.69	54.00	8.31	Average

802.11n ht40 mode, Low Channel, Bandedge, Vertical

Project No.: XMDN240206-08079E-RF
 Polarization: Vertical
 Test Mode: Transmitting
 Note: 802.11n40_U-NII-2A_low channel 5270MHz

Serial No.: ZHP4-4
 Tester: Colin Yang

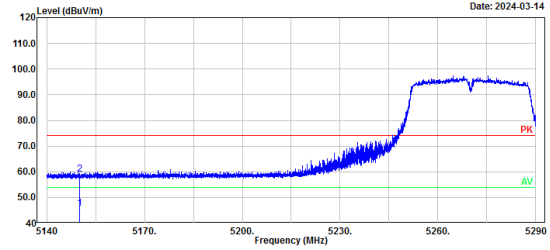

No.	Frequency (MHz)	Reading (dBuV)	Factor (dB/m)	Result (dBuV/m)	Limit (dBuV/m)	Margin (dB)	Detector
1	5150.00	17.13	28.68	45.81	54.00	8.19	Average
2	5150.00	30.24	28.68	58.92	74.00	15.08	Peak

802.11n ht40 mode, High Channel, Horizontal

Project No.: XMDN240206-08079E-RF Serial No.: 2HP4-4
 Polarization: Horizontal Tester: Colin Yang
 Test Mode: Transmitting
 Note: 802.11n40_U-NII-2A_high channel 5310MHz

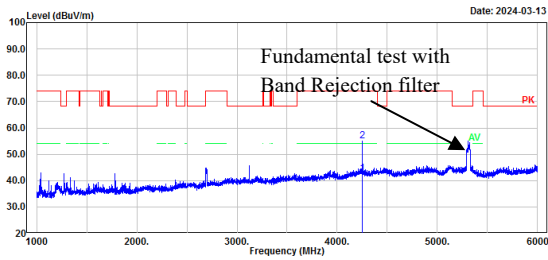

No.	Frequency (MHz)	Reading (dBuV)	Factor (dB/m)	Result (dBuV/m)	Limit (dBuV/m)	Margin (dB)	Detector
1	4248.00	46.23	-3.54	42.69	54.00	11.31	Average
2	4248.00	58.45	-3.54	54.91	74.00	19.09	Peak

802.11n ht40 mode, High Channel, Vertical

Project No.: XMDN240206-08079E-RF Serial No.: 2HP4-4
 Polarization: Vertical Tester: Colin Yang
 Test Mode: Transmitting
 Note: 802.11n40_U-NII-2A_high channel 5310MHz

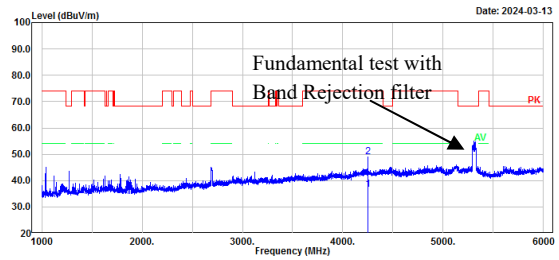

No.	Frequency (MHz)	Reading (dBuV)	Factor (dB/m)	Result (dBuV/m)	Limit (dBuV/m)	Margin (dB)	Detector
1	4249.00	40.24	-3.55	36.69	54.00	17.31	Average
2	4249.00	52.60	-3.55	49.05	74.00	24.95	Peak

Project No.: XMDN240206-08079E-RF Serial No.: 2HP4-4
 Polarization: Horizontal Tester: Colin Yang
 Test Mode: Transmitting
 Note: 802.11n40_U-NII-2A_high channel 5310MHz

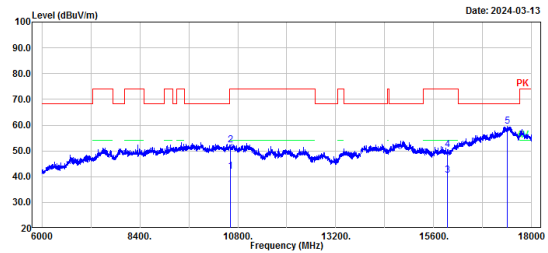

No.	Frequency (MHz)	Reading (dBuV)	Factor (dB/m)	Result (dBuV/m)	Limit (dBuV/m)	Margin (dB)	Detector
1	10620.00	35.45	6.59	42.04	54.00	11.96	Average
2	10620.00	45.84	6.59	52.43	74.00	21.57	Peak
3	15930.00	35.23	5.36	40.59	54.00	13.41	Average
4	15930.00	45.06	5.36	50.42	74.00	23.58	Peak
5	17409.60	44.46	15.15	59.61	68.20	8.59	Peak

Project No.: XMDN240206-08079E-RF Serial No.: 2HP4-4
 Polarization: Vertical Tester: Colin Yang
 Test Mode: Transmitting
 Note: 802.11n40_U-NII-2A_high channel 5310MHz

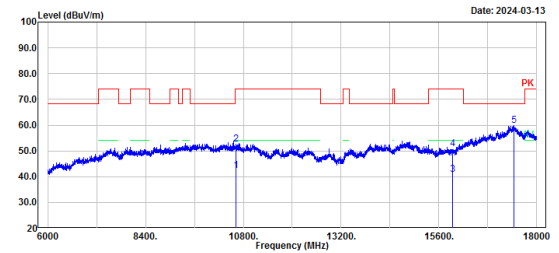

No.	Frequency (MHz)	Reading (dBuV)	Factor (dB/m)	Result (dBuV/m)	Limit (dBuV/m)	Margin (dB)	Detector
1	10620.00	35.62	6.59	42.21	54.00	11.79	Average
2	10620.00	46.00	6.59	52.59	74.00	21.41	Peak
3	15930.00	35.40	5.36	40.76	54.00	13.24	Average
4	15930.00	45.57	5.36	50.93	74.00	23.07	Peak
5	17448.00	44.38	15.45	59.83	68.20	8.37	Peak

802.11n ht40 mode, High Channel, Bandedge, Horizontal

Project No.: XMDN240206-08079E-RF Serial No.: 2HP4-4
 Polarization: Horizontal Tester: Colin Yang
 Test Mode: Transmitting
 Note: 802.11n40_U-NII-2A_high channel 5310MHz

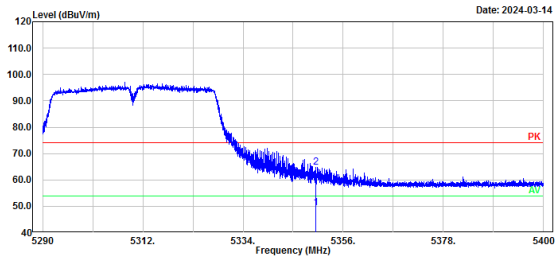

No.	Frequency (MHz)	Reading (dBuV)	Factor (dB/m)	Result (dBuV/m)	Limit (dBuV/m)	Margin (dB)	Detector
1	5350.00	20.14	29.16	49.30	54.00	4.70	Average
2	5350.00	35.48	29.16	64.64	74.00	9.36	Peak

802.11n ht40 mode, High Channel, Bandedge, Vertical

Project No.: XMDN240206-08079E-RF Serial No.: 2HP4-4
 Polarization: Vertical Tester: Colin Yang
 Test Mode: Transmitting
 Note: 802.11n40_U-NII-2A_high channel 5310MHz

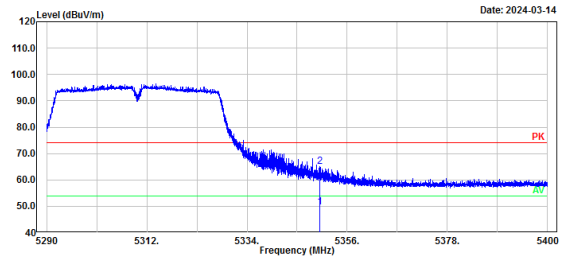

No.	Frequency (MHz)	Reading (dBuV)	Factor (dB/m)	Result (dBuV/m)	Limit (dBuV/m)	Margin (dB)	Detector
1	5350.00	20.42	29.16	49.58	54.00	4.42	Average
2	5350.00	35.80	29.16	64.96	74.00	9.04	Peak

802.11ac80 mode, Middle Channel, Horizontal

Project No.: XMDN240206-08079E-RF
 Polarization: Horizontal
 Test Mode: Transmitting
 Note: 802.11ac80_U-NII-2A_middle channel 5290MHz

Serial No.: 2HP4-4
 Tester: Colin Yang

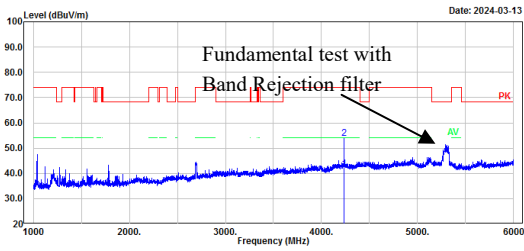

No.	Frequency (MHz)	Reading (dBuV)	Factor (dB/m)	Result (dBuV/m)	Limit (dBuV/m)	Margin (dB)	Detector
1	4232.00	45.28	-3.53	41.75	54.00	12.25	Average
2	4232.00	57.38	-3.53	53.85	74.00	20.15	Peak

802.11ac80 mode, Middle Channel, Vertical

Project No.: XMDN240206-08079E-RF
 Polarization: Vertical
 Test Mode: Transmitting
 Note: 802.11ac80_U-NII-2A_middle channel 5290MHz

Serial No.: 2HP4-4
 Tester: Colin Yang

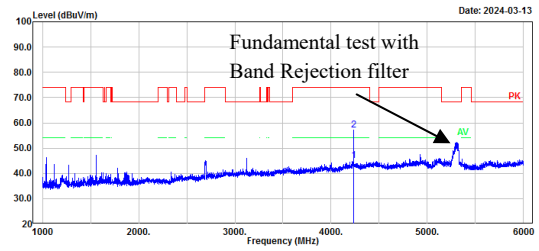

No.	Frequency (MHz)	Reading (dBuV)	Factor (dB/m)	Result (dBuV/m)	Limit (dBuV/m)	Margin (dB)	Detector
1	4232.00	48.62	-3.53	45.09	54.00	8.91	Average
2	4232.00	60.60	-3.53	57.07	74.00	16.93	Peak

Project No.: XMDN240206-08079E-RF
 Polarization: Horizontal
 Test Mode: Transmitting
 Note: 802.11ac80_U-NII-2A_middle channel 5290MHz

Serial No.: 2HP4-4
 Tester: Colin Yang

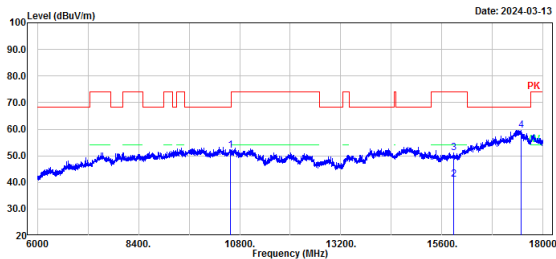

No.	Frequency (MHz)	Reading (dBuV)	Factor (dB/m)	Result (dBuV/m)	Limit (dBuV/m)	Margin (dB)	Detector
1	10580.00	45.25	6.62	51.87	68.20	16.33	Peak
2	15870.00	35.74	5.28	41.02	54.00	12.98	Average
3	15870.00	45.68	5.28	50.96	74.00	23.04	Peak
4	17474.40	43.93	15.67	59.60	68.20	8.60	Peak

Project No.: XMDN240206-08079E-RF
 Polarization: Vertical
 Test Mode: Transmitting
 Note: 802.11ac80_U-NII-2A_middle channel 5290MHz

Serial No.: 2HP4-4
 Tester: Colin Yang

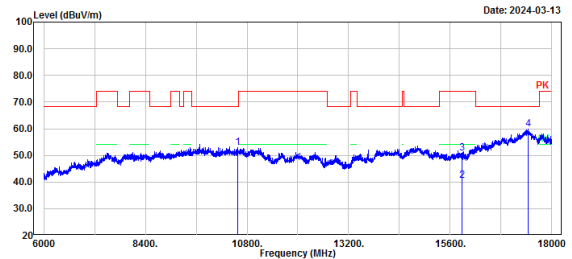

No.	Frequency (MHz)	Reading (dBuV)	Factor (dB/m)	Result (dBuV/m)	Limit (dBuV/m)	Margin (dB)	Detector
1	10580.00	46.29	6.62	52.91	68.20	15.29	Peak
2	15870.00	35.20	5.28	40.48	54.00	13.52	Average
3	15870.00	45.40	5.28	50.68	74.00	23.32	Peak
4	17440.80	44.38	15.40	59.78	68.20	8.42	Peak

802.11 ac80 mode, Middle Channel, Bandedge, Horizontal

Project No.: XMDN240206-08079E-RF Serial No.: 2HP4-4
 Polarization: Horizontal Tester: Colin Yang
 Test Mode: Transmitting
 Note: 802.11ac80_U-NII-2A_middle channel 5290MHz

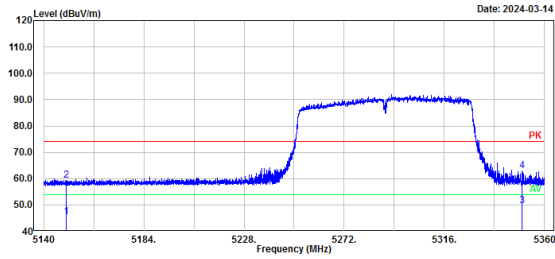

No.	Frequency (MHz)	Reading (dBuV)	Factor (dB/m)	Result (dBuV/m)	Limit (dBuV/m)	Margin (dB)	Detector
1	5150.00	16.67	28.68	45.35	54.00	8.65	Average
2	5150.00	30.61	28.68	59.29	74.00	14.71	Peak
3	5350.00	20.44	29.16	49.60	54.00	4.40	Average
4	5350.00	33.70	29.16	62.86	74.00	11.14	Peak

802.11 ac80 mode, Middle Channel, Bandedge, Vertical

Project No.: XMDN240206-08079E-RF Serial No.: 2HP4-4
 Polarization: Vertical Tester: Colin Yang
 Test Mode: Transmitting
 Note: 802.11ac80_U-NII-2A_middle channel 5290MHz

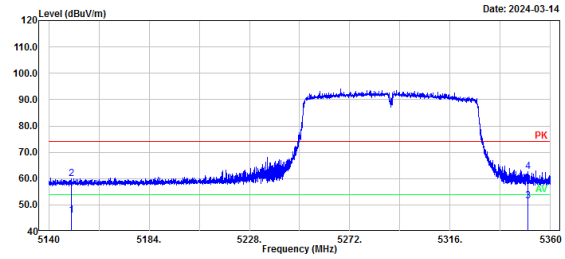

No.	Frequency (MHz)	Reading (dBuV)	Factor (dB/m)	Result (dBuV/m)	Limit (dBuV/m)	Margin (dB)	Detector
1	5150.00	17.32	28.68	46.00	54.00	8.00	Average
2	5150.00	31.09	28.68	59.77	74.00	14.23	Peak
3	5350.00	22.42	29.16	51.58	54.00	2.42	Average
4	5350.00	33.38	29.16	62.54	74.00	11.46	Peak

802.11 ax he20 mode, Low Channel, Horizontal

Project No.: XMDN240206-08079E-RF
 Polarization: Horizontal
 Test Mode: Transmitting
 Note: 802.11ax20_U-NII-2A_low channel 5260MHz

Serial No.: 2HP4-4
 Tester: Colin Yang

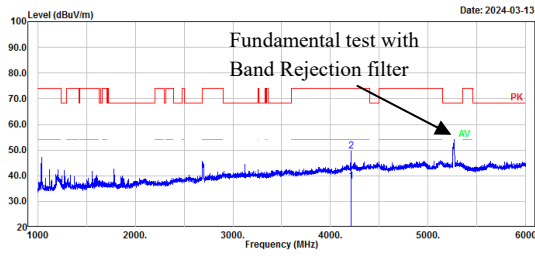

No.	Frequency (MHz)	Reading (dBuV)	Factor (dB/m)	Result (dBuV/m)	Limit (dBuV/m)	Margin (dB)	Detector
1	4208.00	41.43	-3.50	37.93	54.00	16.07	Average
2	4208.00	53.15	-3.50	49.65	74.00	24.35	Peak

802.11 ax he20 mode, Low Channel, Vertical

Project No.: XMDN240206-08079E-RF
 Polarization: Vertical
 Test Mode: Transmitting
 Note: 802.11ax20_U-NII-2A_low channel 5260MHz

Serial No.: 2HP4-4
 Tester: Colin Yang

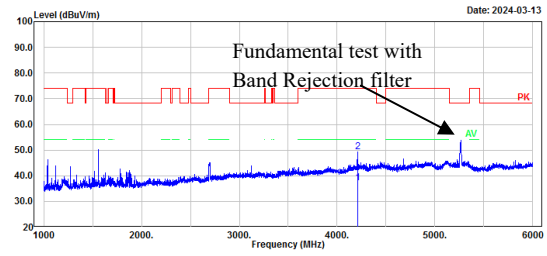

No.	Frequency (MHz)	Reading (dBuV)	Factor (dB/m)	Result (dBuV/m)	Limit (dBuV/m)	Margin (dB)	Detector
1	4207.00	40.71	-3.50	37.21	54.00	16.79	Average
2	4207.00	52.86	-3.50	49.36	74.00	24.64	Peak

Project No.: XMDN240206-08079E-RF
 Polarization: Horizontal
 Test Mode: Transmitting
 Note: 802.11ax20_U-NII-2A_low channel 5260MHz

Serial No.: 2HP4-4
 Tester: Colin Yang

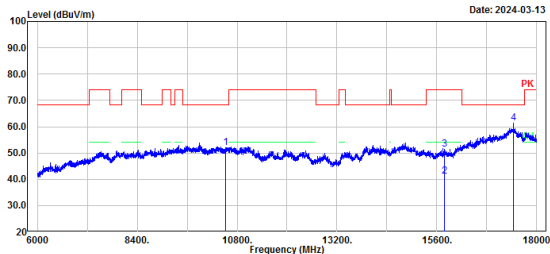

No.	Frequency (MHz)	Reading (dBuV)	Factor (dB/m)	Result (dBuV/m)	Limit (dBuV/m)	Margin (dB)	Detector
1	10520.00	45.49	6.63	52.12	68.20	16.08	Peak
2	15780.00	35.87	5.21	41.08	54.00	12.92	Average
3	15780.00	46.31	5.21	51.52	74.00	22.48	Peak
4	17433.60	46.10	15.34	61.44	68.20	6.76	Peak

Project No.: XMDN240206-08079E-RF
 Polarization: Vertical
 Test Mode: Transmitting
 Note: 802.11ax20_U-NII-2A_low channel 5260MHz

Serial No.: 2HP4-4
 Tester: Colin Yang

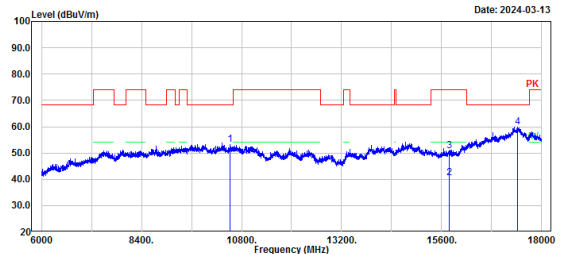

No.	Frequency (MHz)	Reading (dBuV)	Factor (dB/m)	Result (dBuV/m)	Limit (dBuV/m)	Margin (dB)	Detector
1	10520.00	46.69	6.63	53.32	68.20	14.88	Peak
2	15780.00	35.25	5.21	40.46	54.00	13.54	Average
3	15780.00	45.55	5.21	50.76	74.00	23.24	Peak
4	17426.40	44.55	15.28	59.83	68.20	8.37	Peak

802.11 ax he20 mode, Low Channel, Bandedge, Horizontal

Project No.: XMDN240206-08079E-RF Serial No.: ZHP4-4
 Polarization: Horizontal Tester: Colin Yang
 Test Mode: Transmitting
 Note: 802.11ax20_U-NII-2A_low channel 5260MHz

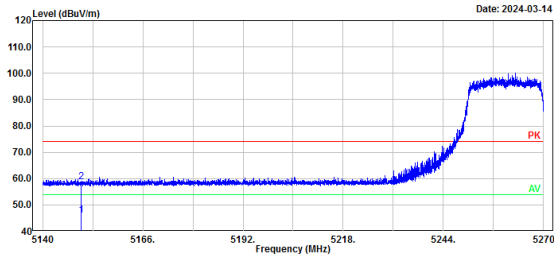

No.	Frequency (MHz)	Reading (dBuV)	Factor (dB/m)	Result (dBuV/m)	Limit (dBuV/m)	Margin (dB)	Detector
1	5150.00	17.23	28.68	45.91	54.00	8.09	Average
2	5150.00	29.94	28.68	58.62	74.00	15.38	Peak

802.11 ax he20 mode, Low Channel, Bandedge, Vertical

Project No.: XMDN240206-08079E-RF Serial No.: ZHP4-4
 Polarization: Vertical Tester: Colin Yang
 Test Mode: Transmitting
 Note: 802.11ax20_U-NII-2A_low channel 5260MHz

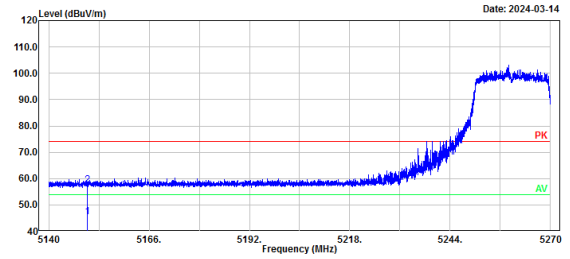

No.	Frequency (MHz)	Reading (dBuV)	Factor (dB/m)	Result (dBuV/m)	Limit (dBuV/m)	Margin (dB)	Detector
1	5150.00	16.77	28.68	45.45	54.00	8.55	Average
2	5150.00	28.80	28.68	57.48	74.00	16.52	Peak

802.11 ax he20 mode, Middle Channel, Horizontal

Project No.: XMDN240206-08079E-RF
 Polarization: Horizontal
 Test Mode: Transmitting
 Note: 802.11ax20_U-NII-2A_middle channel 5280MHz

Serial No.: 2HP4-4
 Tester: Colin Yang

Date: 2024-03-13

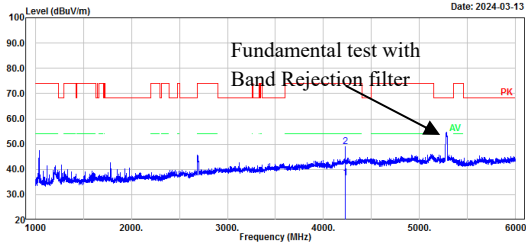

No.	Frequency (MHz)	Reading (dBuV)	Factor (dB/m)	Result (dBuV/m)	Limit (dBuV/m)	Margin (dB)	Detector
1	4224.00	40.12	-3.52	36.60	54.00	17.40	Average
2	4224.00	52.55	-3.52	49.03	74.00	24.97	Peak

802.11 ax he20 mode, Middle Channel, Vertical

Project No.: XMDN240206-08079E-RF
 Polarization: Vertical
 Test Mode: Transmitting
 Note: 802.11ax20_U-NII-2A_middle channel 5280MHz

Serial No.: 2HP4-4
 Tester: Colin Yang

Date: 2024-03-13

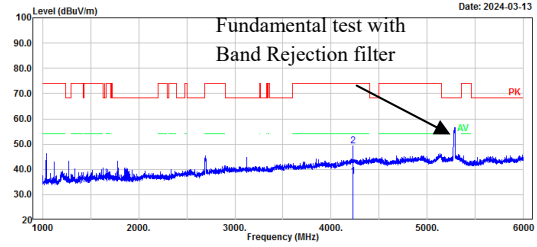

No.	Frequency (MHz)	Reading (dBuV)	Factor (dB/m)	Result (dBuV/m)	Limit (dBuV/m)	Margin (dB)	Detector
1	4224.00	40.78	-3.52	37.26	54.00	16.74	Average
2	4224.00	52.79	-3.52	49.27	74.00	24.73	Peak

Project No.: XMDN240206-08079E-RF
 Polarization: Horizontal
 Test Mode: Transmitting
 Note: 802.11ax20_U-NII-2A_middle channel 5280MHz

Serial No.: 2HP4-4
 Tester: Colin Yang

Date: 2024-03-13

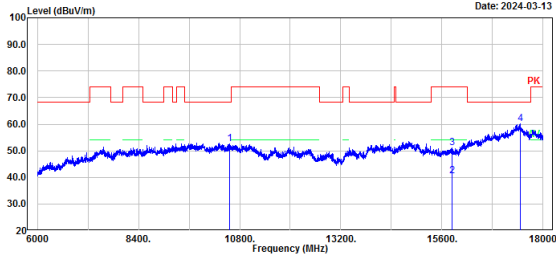

No.	Frequency (MHz)	Reading (dBuV)	Factor (dB/m)	Result (dBuV/m)	Limit (dBuV/m)	Margin (dB)	Detector
1	10560.00	45.94	6.63	52.57	68.20	15.63	Peak
2	15840.00	35.27	5.27	40.54	54.00	13.46	Average
3	15840.00	45.95	5.27	51.22	74.00	22.78	Peak
4	17450.40	44.78	15.48	60.26	68.20	7.94	Peak

Project No.: XMDN240206-08079E-RF
 Polarization: Vertical
 Test Mode: Transmitting
 Note: 802.11ax20_U-NII-2A_middle channel 5280MHz

Serial No.: 2HP4-4
 Tester: Colin Yang

Date: 2024-03-13

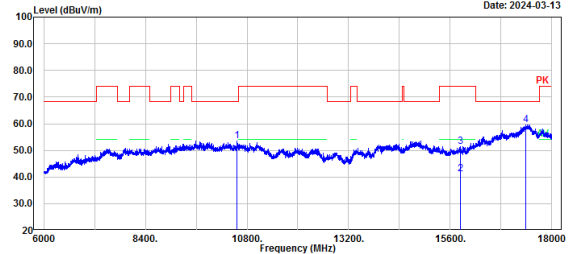

No.	Frequency (MHz)	Reading (dBuV)	Factor (dB/m)	Result (dBuV/m)	Limit (dBuV/m)	Margin (dB)	Detector
1	10560.00	46.75	6.63	53.38	68.20	14.82	Peak
2	15840.00	35.91	5.27	41.18	54.00	12.82	Average
3	15840.00	46.14	5.27	51.41	74.00	22.59	Peak
4	17390.40	44.61	14.99	59.60	68.20	8.60	Peak

802.11 ax he20 mode, High Channel, Horizontal

Project No.: XMDN240206-08079E-RF
 Polarization: Horizontal
 Test Mode: Transmitting
 Note: 802.11ax20_U-NII-2A_high channel 5320MHz

Serial No.: 2HP4-4
 Tester: Colin Yang

Date: 2024-03-13

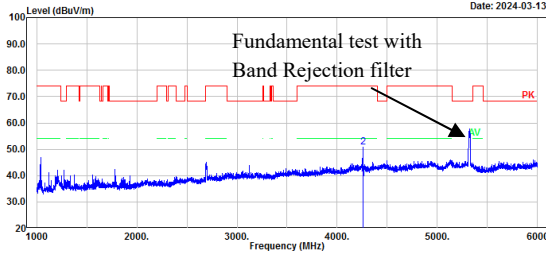

No.	Frequency (MHz)	Reading (dBuV)	Factor (dB/m)	Result (dBuV/m)	Limit (dBuV/m)	Margin (dB)	Detector
1	4255.00	42.32	-3.55	38.77	54.00	15.23	Average
2	4255.00	54.31	-3.55	50.76	74.00	23.24	Peak

802.11 ax he20 mode, High Channel, Vertical

Project No.: XMDN240206-08079E-RF
 Polarization: Vertical
 Test Mode: Transmitting
 Note: 802.11ax20_U-NII-2A_high channel 5320MHz

Serial No.: 2HP4-4
 Tester: Colin Yang

Date: 2024-03-13

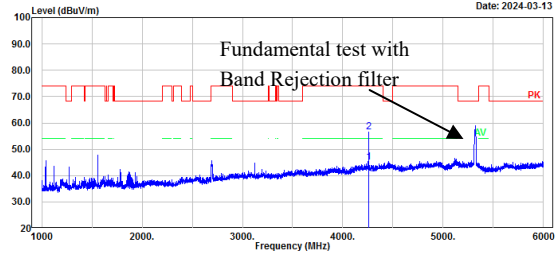

No.	Frequency (MHz)	Reading (dBuV)	Factor (dB/m)	Result (dBuV/m)	Limit (dBuV/m)	Margin (dB)	Detector
1	4256.00	48.52	-3.56	44.96	54.00	9.04	Average
2	4256.00	60.12	-3.56	56.56	74.00	17.44	Peak

Project No.: XMDN240206-08079E-RF
 Polarization: Horizontal
 Test Mode: Transmitting
 Note: 802.11ax20_U-NII-2A_high channel 5320MHz

Serial No.: 2HP4-4
 Tester: Colin Yang

Date: 2024-03-13

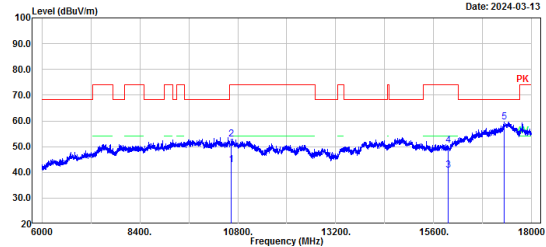

No.	Frequency (MHz)	Reading (dBuV)	Factor (dB/m)	Result (dBuV/m)	Limit (dBuV/m)	Margin (dB)	Detector
1	10640.00	36.36	6.55	42.91	54.00	11.09	Average
2	10640.00	46.50	6.55	53.05	74.00	20.95	Peak
3	15960.00	35.23	5.45	40.68	54.00	13.32	Average
4	15960.00	45.14	5.45	50.59	74.00	23.41	Peak
5	17320.80	45.04	14.42	59.46	68.20	8.74	Peak

Project No.: XMDN240206-08079E-RF
 Polarization: Vertical
 Test Mode: Transmitting
 Note: 802.11ax20_U-NII-2A_high channel 5320MHz

Serial No.: 2HP4-4
 Tester: Colin Yang

Date: 2024-03-13

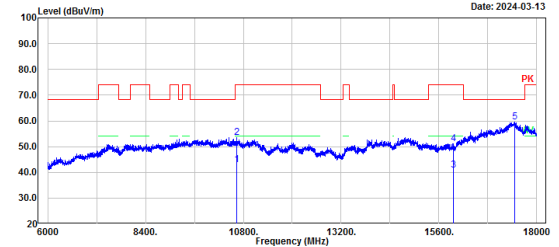

No.	Frequency (MHz)	Reading (dBuV)	Factor (dB/m)	Result (dBuV/m)	Limit (dBuV/m)	Margin (dB)	Detector
1	10640.00	36.39	6.55	42.94	54.00	11.06	Average
2	10640.00	47.11	6.55	53.66	74.00	20.34	Peak
3	15960.00	35.34	5.45	40.79	54.00	13.21	Average
4	15960.00	45.55	5.45	51.00	74.00	23.00	Peak
5	17464.80	43.98	15.59	59.57	68.20	8.63	Peak

802.11 ax he20 mode, High Channel, Bandedge, Horizontal

Project No.: XMDN240206-08079E-RF Serial No.: 2HP4-4
 Polarization: Horizontal Tester: Colin Yang
 Test Mode: Transmitting
 Note: 802.11ax20_U-NII-2A_high channel 5320MHz

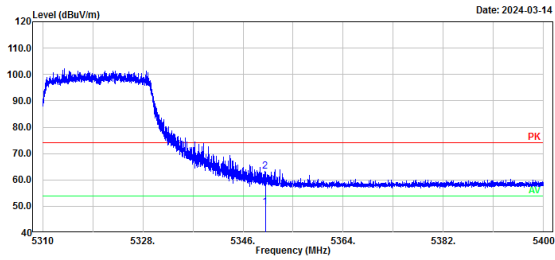

No.	Frequency (MHz)	Reading (dBμV)	Factor (dB/m)	Result (dBμV/m)	Limit (dBμV/m)	Margin (dB)	Detector
1	5350.00	20.64	29.16	49.80	54.00	4.20	Average
2	5350.00	34.19	29.16	63.35	74.00	10.65	Peak

802.11 ax he20 mode, High Channel, Bandedge, Vertical

Project No.: XMDN240206-08079E-RF Serial No.: 2HP4-4
 Polarization: Vertical Tester: Colin Yang
 Test Mode: Transmitting
 Note: 802.11ax20_U-NII-2A_high channel 5320MHz

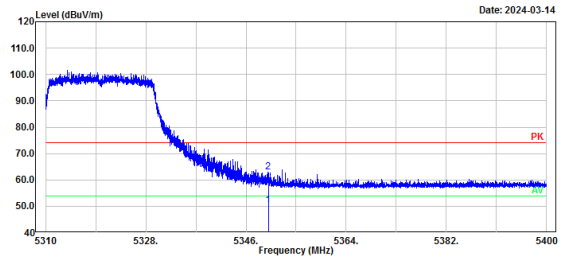

No.	Frequency (MHz)	Reading (dBμV)	Factor (dB/m)	Result (dBμV/m)	Limit (dBμV/m)	Margin (dB)	Detector
1	5350.00	21.03	29.16	50.19	54.00	3.81	Average
2	5350.00	33.83	29.16	62.99	74.00	11.01	Peak

802.11 ax he40 mode, Low Channel, Horizontal

Project No.: XMDN240206-08079E-RF
 Polarization: Horizontal
 Test Mode: Transmitting
 Note: 802.11ax40_U-NII-2A_low channel 5270MHz

Serial No.: 2HP4-4
 Tester: Colin Yang

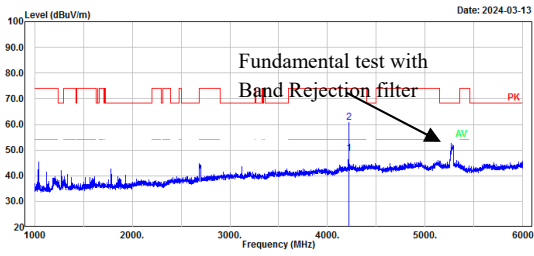

No.	Frequency (MHz)	Reading (dBuV)	Factor (dB/m)	Result (dBuV/m)	Limit (dBuV/m)	Margin (dB)	Detector
1	4216.00	52.31	-3.51	48.80	54.00	5.20	Average
2	4216.00	64.37	-3.51	60.86	74.00	13.14	Peak

802.11 ax he40 mode, Low Channel, Vertical

Project No.: XMDN240206-08079E-RF
 Polarization: Vertical
 Test Mode: Transmitting
 Note: 802.11ax40_U-NII-2A_low channel 5270MHz

Serial No.: 2HP4-4
 Tester: Colin Yang

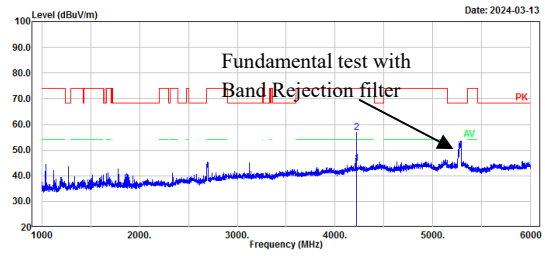

No.	Frequency (MHz)	Reading (dBuV)	Factor (dB/m)	Result (dBuV/m)	Limit (dBuV/m)	Margin (dB)	Detector
1	4216.00	48.24	-3.51	44.73	54.00	9.27	Average
2	4216.00	60.46	-3.51	56.95	74.00	17.05	Peak

Project No.: XMDN240206-08079E-RF
 Polarization: Horizontal
 Test Mode: Transmitting
 Note: 802.11ax40_U-NII-2A_low channel 5270MHz

Serial No.: 2HP4-4
 Tester: Colin Yang

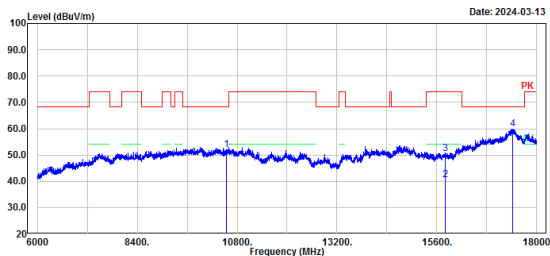

No.	Frequency (MHz)	Reading (dBuV)	Factor (dB/m)	Result (dBuV/m)	Limit (dBuV/m)	Margin (dB)	Detector
1	10540.00	45.51	6.62	52.13	68.20	16.07	Peak
2	15810.00	35.23	5.27	40.50	54.00	13.50	Average
3	15810.00	45.16	5.27	50.43	74.00	23.57	Peak
4	17426.40	44.60	15.28	59.88	68.20	8.32	Peak

Project No.: XMDN240206-08079E-RF
 Polarization: Vertical
 Test Mode: Transmitting
 Note: 802.11ax40_U-NII-2A_low channel 5270MHz

Serial No.: 2HP4-4
 Tester: Colin Yang

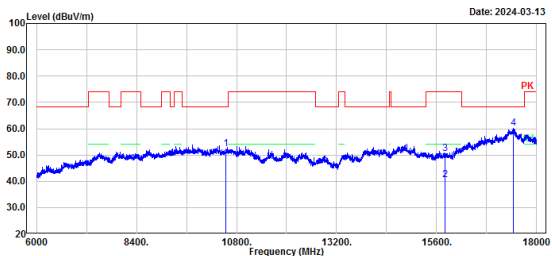

No.	Frequency (MHz)	Reading (dBuV)	Factor (dB/m)	Result (dBuV/m)	Limit (dBuV/m)	Margin (dB)	Detector
1	10540.00	45.69	6.62	52.31	68.20	15.89	Peak
2	15810.00	35.38	5.27	40.65	54.00	13.35	Average
3	15810.00	45.30	5.27	50.57	74.00	23.43	Peak
4	17445.60	44.83	15.44	60.27	68.20	7.93	Peak

802.11 ax he40 mode, Low Channel, Bandedge, Horizontal

Project No.: XMDN240206-08079E-RF Serial No.: ZHP4-4
 Polarization: Horizontal Tester: Colin Yang
 Test Mode: Transmitting
 Note: 802.11ax40_U-NII-2A_low channel 5270MHz

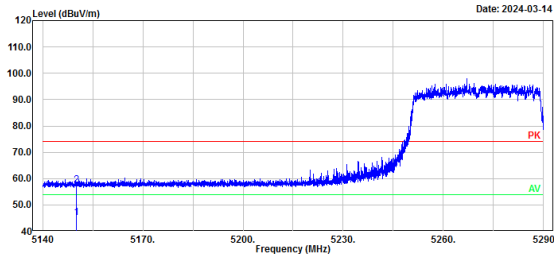

No.	Frequency (MHz)	Reading (dBuV)	Factor (dB/m)	Result (dBuV/m)	Limit (dBuV/m)	Margin (dB)	Detector
1	5150.00	16.35	28.68	45.03	54.00	8.97	Average
2	5150.00	28.79	28.68	57.47	74.00	16.53	Peak

802.11 ax he40 mode, Low Channel, Bandedge, Vertical

Project No.: XMDN240206-08079E-RF Serial No.: ZHP4-4
 Polarization: Vertical Tester: Colin Yang
 Test Mode: Transmitting
 Note: 802.11ax40_U-NII-2A_low channel 5270MHz

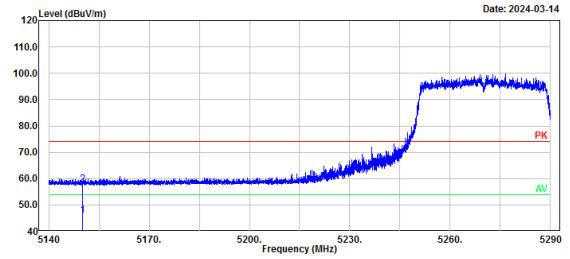

No.	Frequency (MHz)	Reading (dBuV)	Factor (dB/m)	Result (dBuV/m)	Limit (dBuV/m)	Margin (dB)	Detector
1	5150.00	17.24	28.68	45.92	54.00	8.08	Average
2	5150.00	29.19	28.68	57.87	74.00	16.13	Peak

802.11 ax he40 mode, High Channel, Horizontal

Project No.: XMDN240206-08079E-RF Serial No.: 2HP4-4
 Polarization: Horizontal Tester: Colin Yang
 Test Mode: Transmitting
 Note: 802.11ax40_U-NII-2A_high channel 5310MHz

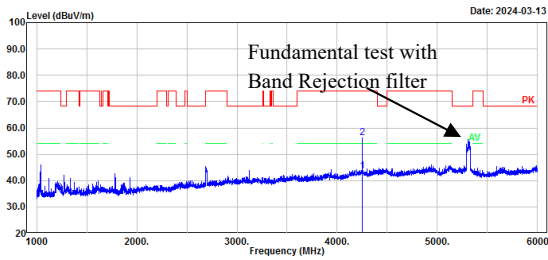

No.	Frequency (MHz)	Reading (dBuV)	Factor (dB/m)	Result (dBuV/m)	Limit (dBuV/m)	Margin (dB)	Detector
1	4248.00	47.18	-3.54	43.64	54.00	10.36	Average
2	4248.00	59.67	-3.54	56.13	74.00	17.87	Peak

802.11 ax he40 mode, High Channel, Vertical

Project No.: XMDN240206-08079E-RF Serial No.: 2HP4-4
 Polarization: Vertical Tester: Colin Yang
 Test Mode: Transmitting
 Note: 802.11ax40_U-NII-2A_high channel 5310MHz

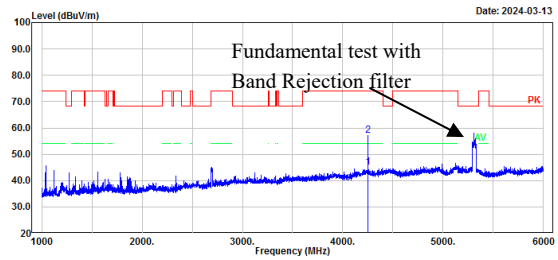

No.	Frequency (MHz)	Reading (dBuV)	Factor (dB/m)	Result (dBuV/m)	Limit (dBuV/m)	Margin (dB)	Detector
1	4248.00	48.61	-3.54	45.07	54.00	8.93	Average
2	4248.00	60.54	-3.54	57.00	74.00	17.00	Peak

Project No.: XMDN240206-08079E-RF Serial No.: 2HP4-4
 Polarization: Horizontal Tester: Colin Yang
 Test Mode: Transmitting
 Note: 802.11ax40_U-NII-2A_high channel 5310MHz

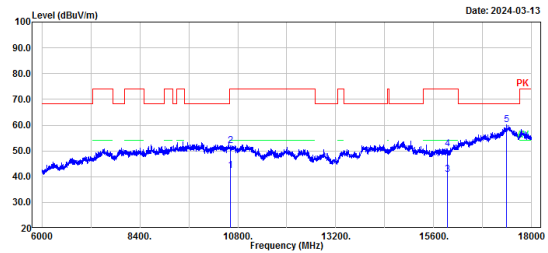

No.	Frequency (MHz)	Reading (dBuV)	Factor (dB/m)	Result (dBuV/m)	Limit (dBuV/m)	Margin (dB)	Detector
1	10620.00	35.84	6.59	42.43	54.00	11.57	Average
2	10620.00	45.49	6.59	52.08	74.00	21.92	Peak
3	15930.00	35.37	5.36	40.73	54.00	13.27	Average
4	15930.00	45.38	5.36	50.74	74.00	23.26	Peak
5	17385.60	45.07	14.96	60.03	68.20	8.17	Peak

Project No.: XMDN240206-08079E-RF Serial No.: 2HP4-4
 Polarization: Vertical Tester: Colin Yang
 Test Mode: Transmitting
 Note: 802.11ax40_U-NII-2A_high channel 5310MHz

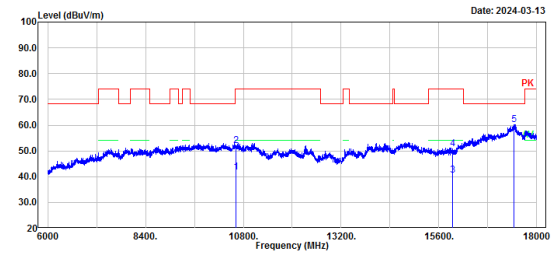

No.	Frequency (MHz)	Reading (dBuV)	Factor (dB/m)	Result (dBuV/m)	Limit (dBuV/m)	Margin (dB)	Detector
1	10620.00	35.27	6.59	41.86	54.00	12.14	Average
2	10620.00	45.45	6.59	52.04	74.00	21.96	Peak
3	15930.00	35.09	5.36	40.45	54.00	13.55	Average
4	15930.00	45.53	5.36	50.89	74.00	23.11	Peak
5	17438.40	44.88	15.39	60.27	68.20	7.93	Peak

802.11ax ht40 mode, High Channel, Bandedge, Horizontal

Project No.: XMDN240206-08079E-RF Serial No.: 2HP4-4
 Polarization: Horizontal Tester: Colin Yang
 Test Mode: Transmitting
 Note: 802.11ax40_U-NII-2A_high channel 5310MHz

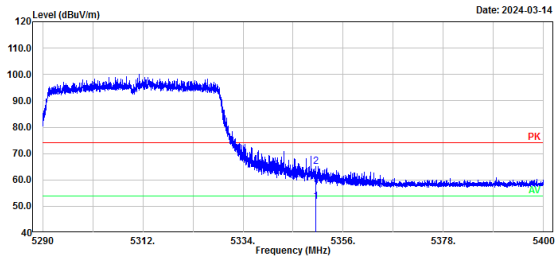

No.	Frequency (MHz)	Reading (dBμV)	Factor (dB/m)	Result (dBμV/m)	Limit (dBμV/m)	Margin (dB)	Detector
1	5350.00	22.73	29.16	51.89	54.00	2.11	Average
2	5350.00	35.90	29.16	65.06	74.00	8.94	Peak

802.11 ax he40 mode, High Channel, Bandedge, Vertical

Project No.: XMDN240206-08079E-RF Serial No.: 2HP4-4
 Polarization: Vertical Tester: Colin Yang
 Test Mode: Transmitting
 Note: 802.11ax40_U-NII-2A_high channel 5310MHz

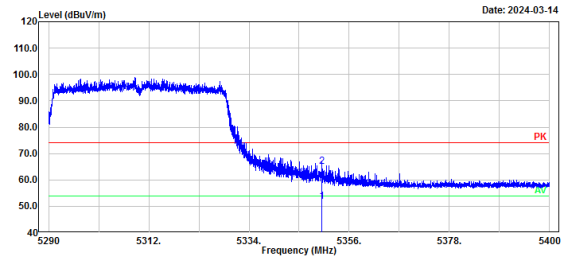

No.	Frequency (MHz)	Reading (dBμV)	Factor (dB/m)	Result (dBμV/m)	Limit (dBμV/m)	Margin (dB)	Detector
1	5350.00	22.57	29.16	51.73	54.00	2.27	Average
2	5350.00	35.97	29.16	65.13	74.00	8.87	Peak

802.11ax80 mode, Middle Channel, Horizontal

Project No.: XMDN240206-08079E-RF Serial No.: 2HP4-4
 Polarization: Horizontal Tester: Colin Yang
 Test Mode: Transmitting
 Note: 802.11ax80_U-NII-2A_middle channel 5290MHz

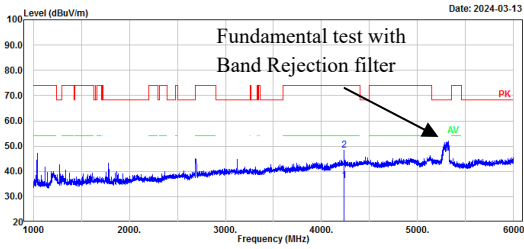

No.	Frequency (MHz)	Reading (dBuV)	Factor (dB/m)	Result (dBuV/m)	Limit (dBuV/m)	Margin (dB)	Detector
1	4233.00	39.84	-3.53	36.31	54.00	17.69	Average
2	4233.00	51.96	-3.53	48.43	74.00	25.57	Peak

802.11ax80 mode, Middle Channel, Vertical

Project No.: XMDN240206-08079E-RF Serial No.: 2HP4-4
 Polarization: Vertical Tester: Colin Yang
 Test Mode: Transmitting
 Note: 802.11ax80_U-NII-2A_middle channel 5290MHz

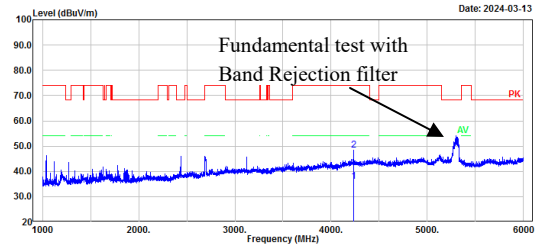

No.	Frequency (MHz)	Reading (dBuV)	Factor (dB/m)	Result (dBuV/m)	Limit (dBuV/m)	Margin (dB)	Detector
1	4232.00	39.38	-3.53	35.85	54.00	18.15	Average
2	4232.00	51.94	-3.53	48.41	74.00	25.59	Peak

Project No.: XMDN240206-08079E-RF Serial No.: 2HP4-4
 Polarization: Horizontal Tester: Colin Yang
 Test Mode: Transmitting
 Note: 802.11ax80_U-NII-2A_middle channel 5290MHz

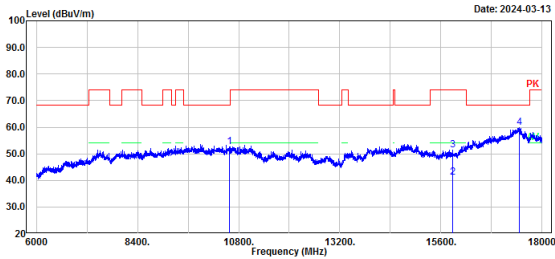

No.	Frequency (MHz)	Reading (dBuV)	Factor (dB/m)	Result (dBuV/m)	Limit (dBuV/m)	Margin (dB)	Detector
1	10580.00	46.09	6.62	52.71	68.20	15.49	Peak
2	15870.00	35.87	5.28	41.15	54.00	12.85	Average
3	15870.00	46.17	5.28	51.45	74.00	22.55	Peak
4	17460.00	44.21	15.56	59.77	68.20	8.43	Peak

Project No.: XMDN240206-08079E-RF Serial No.: 2HP4-4
 Polarization: Vertical Tester: Colin Yang
 Test Mode: Transmitting
 Note: 802.11ax80_U-NII-2A_middle channel 5290MHz

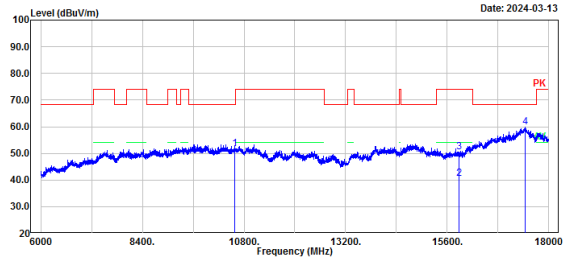

No.	Frequency (MHz)	Reading (dBuV)	Factor (dB/m)	Result (dBuV/m)	Limit (dBuV/m)	Margin (dB)	Detector
1	10580.00	45.21	6.62	51.83	68.20	16.37	Peak
2	15870.00	35.10	5.28	40.38	54.00	13.62	Average
3	15870.00	45.36	5.28	50.64	74.00	23.36	Peak
4	17438.40	44.40	15.39	59.79	68.20	8.41	Peak

802.11 ax 80 mode, Middle Channel, Bandedge, Horizontal

Project No.: XMDN240206-08079E-RF Serial No.: 2HP4-4
 Polarization: Horizontal Tester: Colin Yang
 Test Mode: Transmitting
 Note: 802.11ax80_U-NII-2A_middle channel 5290MHz

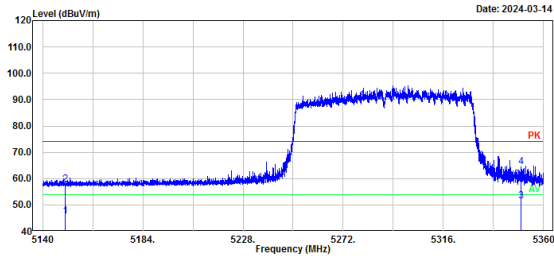

No.	Frequency (MHz)	Reading (dBuV)	Factor (dB/m)	Result (dBuV/m)	Limit (dBuV/m)	Margin (dB)	Detector
1	5150.00	16.97	28.68	45.65	54.00	8.35	Average
2	5150.00	29.17	28.68	57.85	74.00	16.15	Peak
3	5350.00	22.37	29.16	51.53	54.00	2.47	Average
4	5350.00	35.33	29.16	64.49	74.00	9.51	Peak

802.11 ax80 mode, Middle Channel, Bandedge, Vertical

Project No.: XMDN240206-08079E-RF Serial No.: 2HP4-4
 Polarization: Vertical Tester: Colin Yang
 Test Mode: Transmitting
 Note: 802.11ax80_U-NII-2A_middle channel 5290MHz

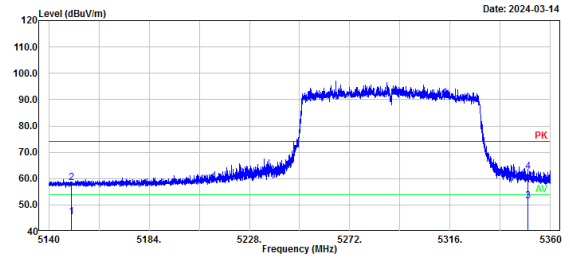

No.	Frequency (MHz)	Reading (dBuV)	Factor (dB/m)	Result (dBuV/m)	Limit (dBuV/m)	Margin (dB)	Detector
1	5150.00	16.85	28.68	45.53	54.00	8.47	Average
2	5150.00	29.71	28.68	58.39	74.00	15.61	Peak
3	5350.00	22.38	29.16	51.54	54.00	2.46	Average
4	5350.00	33.61	29.16	62.77	74.00	11.23	Peak

5470-5725MHz :

802.11a mode, Low Channel, Horizontal

Project No.: XMDN240206-08079E-RF
 Polarization: Horizontal
 Test Mode: Transmitting
 Note: 802.11a_U-WiFi-2C_low channel 5500MHz

Serial No.: ZHP4-4
 Tester: Colin Yang

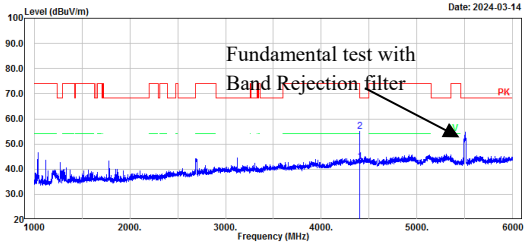

No.	Frequency (MHz)	Reading (dBuV)	Factor (dB/m)	Result (dBuV/m)	Limit (dBuV/m)	Margin (dB)	Detector
1	4400.00	46.35	-3.31	43.04	54.00	10.96	Average
2	4400.00	58.44	-3.31	55.13	68.20	13.07	Peak

802.11a mode, Low Channel, Vertical

Project No.: XMDN240206-08079E-RF
 Polarization: Vertical
 Test Mode: Transmitting
 Note: 802.11a_U-WiFi-2C_low channel 5500MHz

Serial No.: ZHP4-4
 Tester: Colin Yang

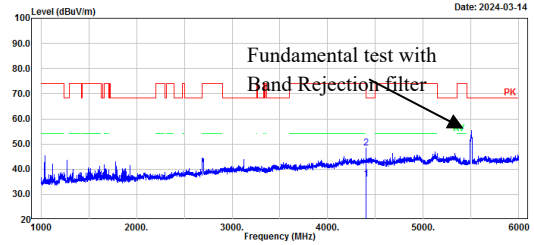

No.	Frequency (MHz)	Reading (dBuV)	Factor (dB/m)	Result (dBuV/m)	Limit (dBuV/m)	Margin (dB)	Detector
1	4400.00	39.37	-3.31	36.06	54.00	17.94	Average
2	4400.00	51.77	-3.31	48.46	68.20	19.74	Peak

Project No.: XMDN240206-08079E-RF
 Polarization: Horizontal
 Test Mode: Transmitting
 Note: 802.11a_U-WiFi-2C_low channel 5500MHz

Serial No.: ZHP4-4
 Tester: Colin Yang

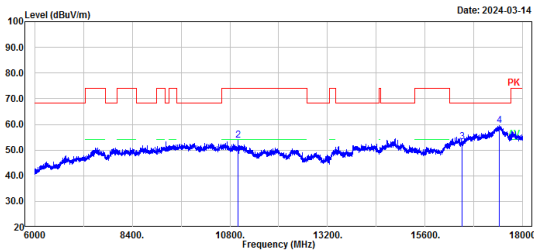

No.	Frequency (MHz)	Reading (dBuV)	Factor (dB/m)	Result (dBuV/m)	Limit (dBuV/m)	Margin (dB)	Detector
1	11000.00	41.23	6.35	47.58	54.00	6.42	Average
2	11000.00	47.50	6.35	53.85	74.00	20.15	Peak
3	16500.00	43.75	9.36	53.11	68.20	15.09	Peak
4	17419.20	44.45	15.23	59.68	68.20	8.52	Peak

Project No.: XMDN240206-08079E-RF
 Polarization: Vertical
 Test Mode: Transmitting
 Note: 802.11a_U-WiFi-2C_low channel 5500MHz

Serial No.: ZHP4-4
 Tester: Colin Yang

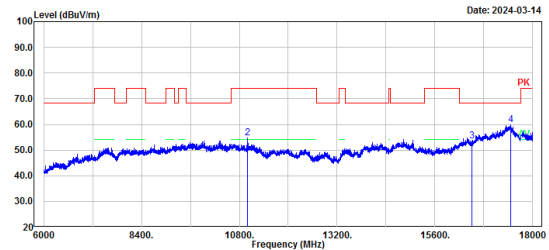

No.	Frequency (MHz)	Reading (dBuV)	Factor (dB/m)	Result (dBuV/m)	Limit (dBuV/m)	Margin (dB)	Detector
1	11000.00	42.23	6.35	48.58	54.00	5.42	Average
2	11000.00	48.29	6.35	54.64	74.00	19.36	Peak
3	16500.00	44.25	9.36	53.61	68.20	14.59	Peak
4	17450.40	44.27	15.48	59.75	68.20	8.45	Peak

802.11a mode, Low Channel, Bandedge, Horizontal

Project No.: XMDN240206-08079E-RF Serial No.: 2HP4-4
 Polarization: Horizontal Tester: Colin Yang
 Test Mode: Transmitting
 Note: 802.11a_U-NII-2C_low channel 5500MHz

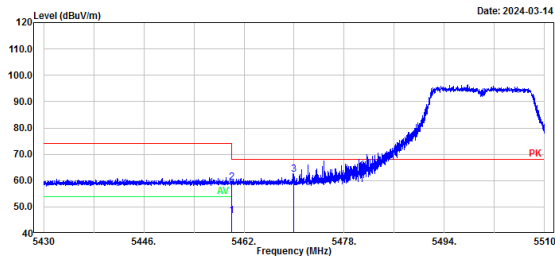

No.	Frequency (MHz)	Reading (dBμV)	Factor (dB/m)	Result (dBμV/m)	Limit (dBμV/m)	Margin (dB)	Detector
1	5460.00	17.24	29.34	46.58	54.00	7.42	Average
2	5460.00	29.96	29.34	59.30	74.00	14.70	Peak
3	5470.00	32.99	29.36	62.35	68.20	5.85	Peak

802.11a mode, Low Channel, Bandedge, Vertical

Project No.: XMDN240206-08079E-RF Serial No.: 2HP4-4
 Polarization: Vertical Tester: Colin Yang
 Test Mode: Transmitting
 Note: 802.11a_U-NII-2C_low channel 5500MHz

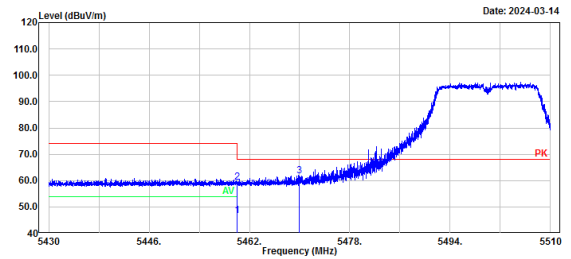

No.	Frequency (MHz)	Reading (dBμV)	Factor (dB/m)	Result (dBμV/m)	Limit (dBμV/m)	Margin (dB)	Detector
1	5460.00	17.17	29.34	46.51	54.00	7.49	Average
2	5460.00	30.08	29.34	59.42	74.00	14.58	Peak
3	5470.00	32.52	29.36	61.88	68.20	6.32	Peak

802.11a mode, Middle Channel, Horizontal

Project No.: XMDN240206-08079E-RF Serial No.: 2HP4-4
 Polarization: Horizontal Tester: Colin Yang
 Test Mode: Transmitting
 Note: 802.11a_U-NII-2C_middle channel 5580MHz

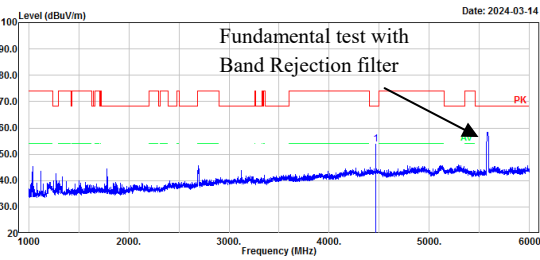

No.	Frequency (MHz)	Reading (dBuV)	Factor (dB/m)	Result (dBuV/m)	Limit (dBuV/m)	Margin (dB)	Detector
1	4464.00	57.17	-3.25	53.92	68.20	14.28	Peak

802.11a mode, Middle Channel, Vertical

Project No.: XMDN240206-08079E-RF Serial No.: 2HP4-4
 Polarization: Vertical Tester: Colin Yang
 Test Mode: Transmitting
 Note: 802.11a_U-NII-2C_middle channel 5580MHz

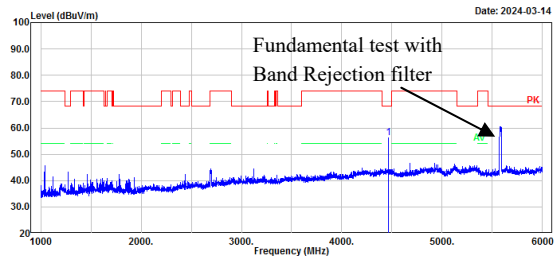

No.	Frequency (MHz)	Reading (dBuV)	Factor (dB/m)	Result (dBuV/m)	Limit (dBuV/m)	Margin (dB)	Detector
1	4464.00	59.36	-3.25	56.11	68.20	12.09	Peak

Project No.: XMDN240206-08079E-RF Serial No.: 2HP4-4
 Polarization: Horizontal Tester: Colin Yang
 Test Mode: Transmitting
 Note: 802.11a_U-NII-2C_middle channel 5580MHz

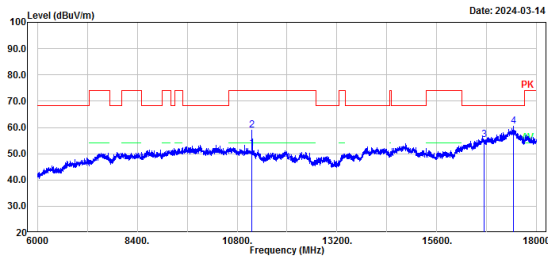

No.	Frequency (MHz)	Reading (dBuV)	Factor (dB/m)	Result (dBuV/m)	Limit (dBuV/m)	Margin (dB)	Detector
1	11160.00	46.23	5.91	52.14	54.00	1.86	Average
2	11160.00	52.98	5.91	58.89	74.00	15.11	Peak
3	16740.00	44.54	10.64	55.18	68.20	13.02	Peak
4	17433.60	44.98	15.34	60.32	68.20	7.88	Peak

Project No.: XMDN240206-08079E-RF Serial No.: 2HP4-4
 Polarization: Vertical Tester: Colin Yang
 Test Mode: Transmitting
 Note: 802.11a_U-NII-2C_middle channel 5580MHz

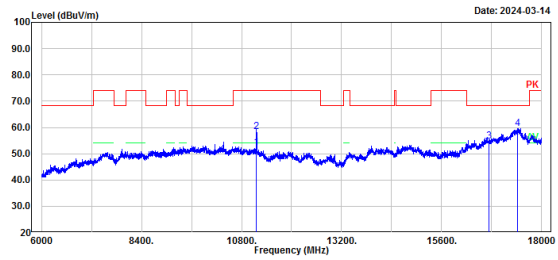

No.	Frequency (MHz)	Reading (dBuV)	Factor (dB/m)	Result (dBuV/m)	Limit (dBuV/m)	Margin (dB)	Detector
1	11160.00	46.37	5.91	52.28	54.00	1.72	Average
2	11160.00	52.52	5.91	58.43	74.00	15.57	Peak
3	16740.00	43.96	10.64	54.60	68.20	13.60	Peak
4	17414.40	44.44	15.19	59.63	68.20	8.57	Peak

802.11a mode, High Channel, Horizontal

Project No.: XMDN240206-08079E-RF Serial No.: 2HP4-4
 Polarization: Horizontal Tester: Colin Yang
 Test Mode: Transmitting
 Note: 802.11a_U-NII-2C_high channel 5700MHz

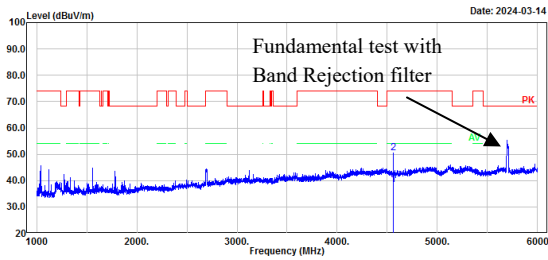

No.	Frequency (MHz)	Reading (dBuV)	Factor (dB/m)	Result (dBuV/m)	Limit (dBuV/m)	Margin (dB)	Detector
1	4560.00	41.72	-3.43	38.29	54.00	15.71	Average
2	4560.00	53.79	-3.43	50.36	74.00	23.64	Peak

802.11a mode, High Channel, Vertical

Project No.: XMDN240206-08079E-RF Serial No.: 2HP4-4
 Polarization: Vertical Tester: Colin Yang
 Test Mode: Transmitting
 Note: 802.11a_U-NII-2C_high channel 5700MHz

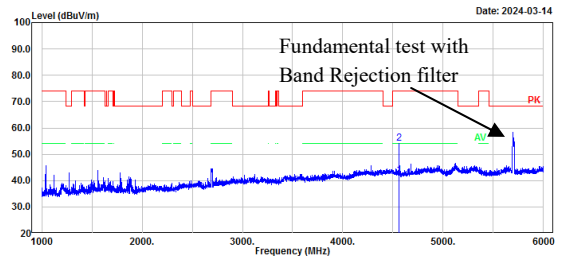

No.	Frequency (MHz)	Reading (dBuV)	Factor (dB/m)	Result (dBuV/m)	Limit (dBuV/m)	Margin (dB)	Detector
1	4560.00	45.35	-3.43	41.92	54.00	12.08	Average
2	4560.00	57.63	-3.43	54.20	74.00	19.80	Peak

Project No.: XMDN240206-08079E-RF Serial No.: 2HP4-4
 Polarization: Horizontal Tester: Colin Yang
 Test Mode: Transmitting
 Note: 802.11a_U-NII-2C_high channel 5700MHz

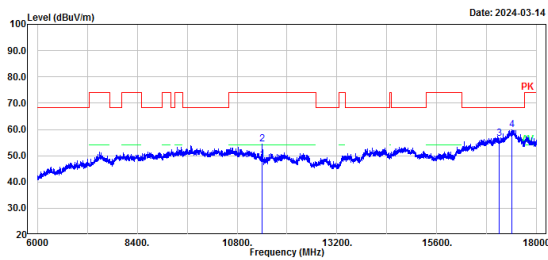

No.	Frequency (MHz)	Reading (dBuV)	Factor (dB/m)	Result (dBuV/m)	Limit (dBuV/m)	Margin (dB)	Detector
1	11400.00	44.07	4.33	48.40	54.00	5.60	Average
2	11400.00	50.09	4.33	54.42	74.00	19.58	Peak
3	17100.00	43.69	12.80	56.49	68.20	11.71	Peak
4	17397.60	44.78	15.06	59.84	68.20	8.36	Peak

Project No.: XMDN240206-08079E-RF Serial No.: 2HP4-4
 Polarization: Vertical Tester: Colin Yang
 Test Mode: Transmitting
 Note: 802.11a_U-NII-2C_high channel 5700MHz

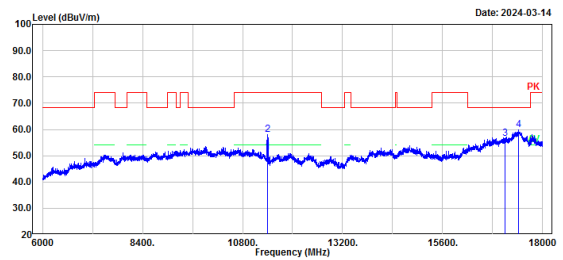

No.	Frequency (MHz)	Reading (dBuV)	Factor (dB/m)	Result (dBuV/m)	Limit (dBuV/m)	Margin (dB)	Detector
1	11400.00	47.21	4.33	51.54	54.00	2.46	Average
2	11400.00	53.68	4.33	58.01	74.00	15.99	Peak
3	17100.00	43.61	12.80	56.41	68.20	11.79	Peak
4	17428.80	44.58	15.30	59.88	68.20	8.32	Peak

802.11a mode, High Channel, Bandedge, Horizontal

Project No.: XMDN240206-08079E-RF Serial No.: 2HP4-4
 Polarization: Horizontal Tester: Colin Yang
 Test Mode: Transmitting
 Note: 802.11a_U-NII-2C_high channel 5700MHz

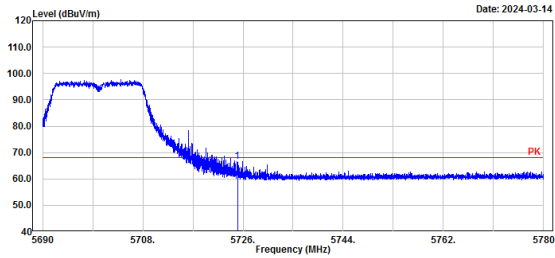

No.	Frequency (MHz)	Reading (dBuV)	Factor (dB/m)	Result (dBuV/m)	Limit (dBuV/m)	Margin (dB)	Detector
1	5725.00	36.87	29.81	66.68	68.20	1.52	Peak

802.11a mode, High Channel, Bandedge, Vertical

Project No.: XMDN240206-08079E-RF Serial No.: 2HP4-4
 Polarization: Vertical Tester: Colin Yang
 Test Mode: Transmitting
 Note: 802.11a_U-NII-2C_high channel 5700MHz

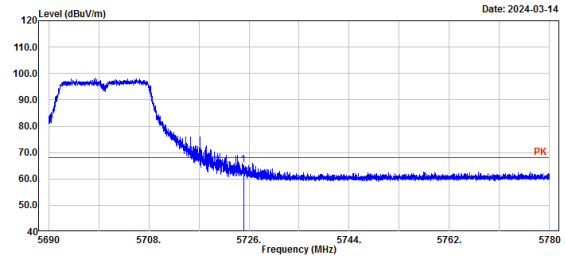

No.	Frequency (MHz)	Reading (dBuV)	Factor (dB/m)	Result (dBuV/m)	Limit (dBuV/m)	Margin (dB)	Detector
1	5725.00	35.46	29.81	65.27	68.20	2.93	Peak

802.11n ht20 mode, Low Channel, Horizontal

Project No.: XMDN240206-08079E-RF
 Polarization: Horizontal
 Test Mode: Transmitting
 Note: 802.11ax20_U-NII-2C_low channel 5500MHz

Serial No.: 2HP4-4
 Tester: Colin Yang

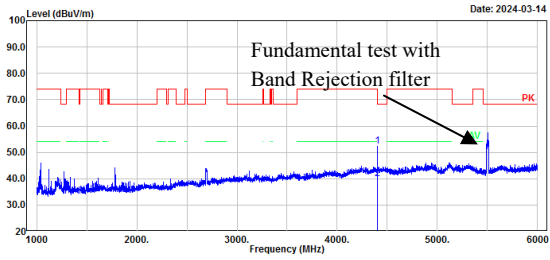

No.	Frequency (MHz)	Reading (dBuV)	Factor (dB/m)	Result (dBuV/m)	Limit (dBuV/m)	Margin (dB)	Detector
1	4400.00	55.66	-3.31	52.35	74.00	21.65	Peak
2	4400.00	43.29	-3.31	39.98	54.00	14.02	Average

802.11n ht20 mode, Low Channel, Vertical

Project No.: XMDN240206-08079E-RF
 Polarization: Vertical
 Test Mode: Transmitting
 Note: 802.11ax20_U-NII-2C_low channel 5500MHz

Serial No.: 2HP4-4
 Tester: Colin Yang

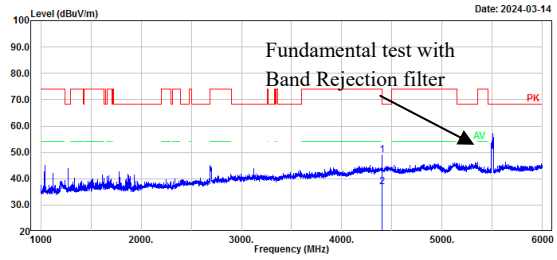

No.	Frequency (MHz)	Reading (dBuV)	Factor (dB/m)	Result (dBuV/m)	Limit (dBuV/m)	Margin (dB)	Detector
1	4400.00	52.14	-3.31	48.83	74.00	25.17	Peak
2	4400.00	40.28	-3.31	36.97	54.00	17.03	Average

Project No.: XMDN240206-08079E-RF
 Polarization: Horizontal
 Test Mode: Transmitting
 Note: 802.11n20_U-NII-2C_low channel 5500MHz

Serial No.: 2HP4-4
 Tester: Colin Yang

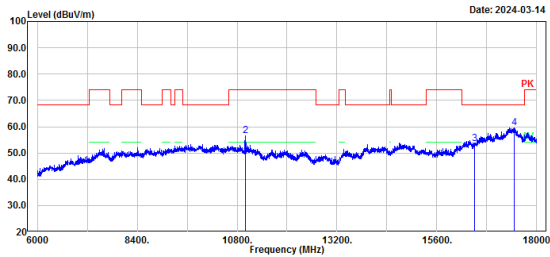

No.	Frequency (MHz)	Reading (dBuV)	Factor (dB/m)	Result (dBuV/m)	Limit (dBuV/m)	Margin (dB)	Detector
1	11000.00	42.19	6.35	48.54	54.00	5.46	Average
2	11000.00	50.23	6.35	56.58	74.00	17.42	Peak
3	16500.00	44.18	9.36	53.54	68.20	14.66	Peak
4	17455.20	44.12	15.51	59.63	68.20	8.57	Peak

Project No.: XMDN240206-08079E-RF
 Polarization: Vertical
 Test Mode: Transmitting
 Note: 802.11n20_U-NII-2C_low channel 5500MHz

Serial No.: 2HP4-4
 Tester: Colin Yang

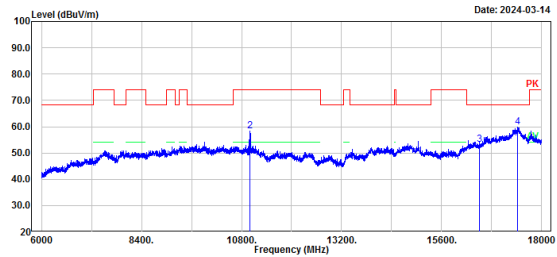

No.	Frequency (MHz)	Reading (dBuV)	Factor (dB/m)	Result (dBuV/m)	Limit (dBuV/m)	Margin (dB)	Detector
1	11000.00	43.35	6.35	49.70	54.00	4.30	Average
2	11000.00	51.88	6.35	58.23	74.00	15.77	Peak
3	16500.00	43.95	9.36	53.31	68.20	14.89	Peak
4	17416.80	44.52	15.22	59.74	68.20	8.46	Peak

802.11n ht20 mode, Low Channel, Bandedge, Horizontal

Project No.: XMDN240206-08079E-RF Serial No.: 2HP4-4
 Polarization: Horizontal Tester: Colin Yang
 Test Mode: Transmitting
 Note: 802.11n20_U-NII-2C_low channel 5500MHz

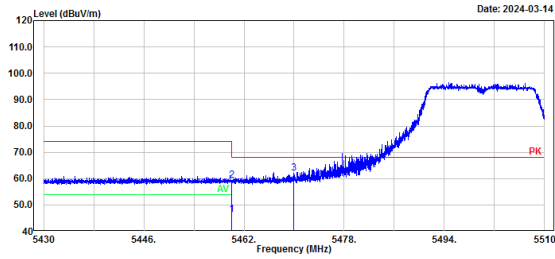

No.	Frequency (MHz)	Reading (dBuV)	Factor (dB/m)	Result (dBuV/m)	Limit (dBuV/m)	Margin (dB)	Detector
1	5460.00	17.05	29.34	46.39	54.00	7.61	Average
2	5460.00	29.89	29.34	59.23	74.00	14.77	Peak
3	5470.00	32.64	29.36	62.00	68.20	6.20	Peak

802.11n ht20 mode, Low Channel, Bandedge, Vertical

Project No.: XMDN240206-08079E-RF Serial No.: 2HP4-4
 Polarization: Vertical Tester: Colin Yang
 Test Mode: Transmitting
 Note: 802.11n20_U-NII-2C_low channel 5500MHz

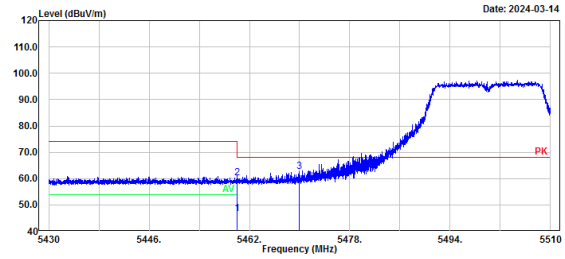

No.	Frequency (MHz)	Reading (dBuV)	Factor (dB/m)	Result (dBuV/m)	Limit (dBuV/m)	Margin (dB)	Detector
1	5460.00	17.34	29.34	46.68	54.00	7.32	Average
2	5460.00	30.85	29.34	60.19	74.00	13.81	Peak
3	5470.00	33.23	29.36	62.59	68.20	5.61	Peak

802.11n ht20 mode, Middle Channel, Horizontal

Project No.: XMDN240206-08079E-RF
 Polarization: Horizontal
 Test Mode: Transmitting
 Note: 802.11n20_U-NII-2C_middle channel 5580MHz

Serial No.: ZHP4-4
 Tester: Colin Yang

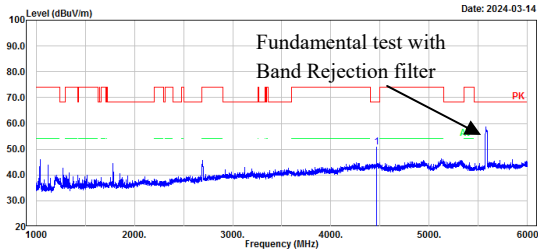

Date: 2024-03-14

No.	Frequency (MHz)	Reading (dBμV)	Factor (dB/m)	Result (dBμV/m)	Limit (dBμV/m)	Margin (dB)	Detector
1	4465.00	53.94	-3.25	50.69	68.20	17.51	Peak

802.11n ht20 mode, Middle Channel, Vertical

Project No.: XMDN240206-08079E-RF
 Polarization: Vertical
 Test Mode: Transmitting
 Note: 802.11n20_U-NII-2C_middle channel 5580MHz

Serial No.: ZHP4-4
 Tester: Colin Yang

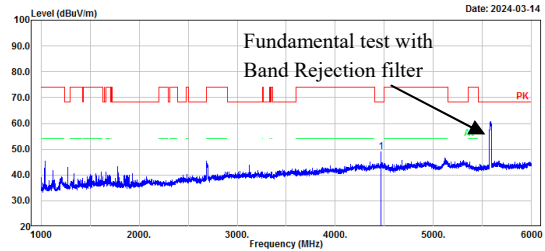

Date: 2024-03-14

No.	Frequency (MHz)	Reading (dBμV)	Factor (dB/m)	Result (dBμV/m)	Limit (dBμV/m)	Margin (dB)	Detector
1	4465.00	52.22	-3.25	48.97	68.20	19.23	Peak

Project No.: XMDN240206-08079E-RF
 Polarization: Horizontal
 Test Mode: Transmitting
 Note: 802.11n20_U-NII-2C_middle channel 5580MHz

Serial No.: ZHP4-4
 Tester: Colin Yang

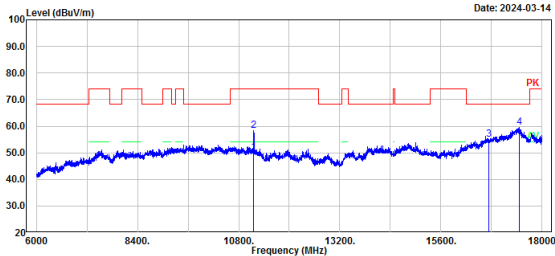

Date: 2024-03-14

No.	Frequency (MHz)	Reading (dBμV)	Factor (dB/m)	Result (dBμV/m)	Limit (dBμV/m)	Margin (dB)	Detector
1	11160.00	44.23	5.91	50.14	54.00	3.86	Average
2	11160.00	52.46	5.91	58.37	74.00	15.63	Peak
3	16740.00	44.51	10.64	55.15	68.20	13.05	Peak
4	17452.80	43.93	15.50	59.43	68.20	8.77	Peak

Project No.: XMDN240206-08079E-RF
 Polarization: Vertical
 Test Mode: Transmitting
 Note: 802.11n20_U-NII-2C_middle channel 5580MHz

Serial No.: ZHP4-4
 Tester: Colin Yang

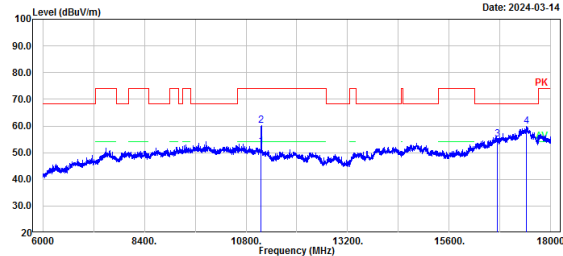

Date: 2024-03-14

No.	Frequency (MHz)	Reading (dBμV)	Factor (dB/m)	Result (dBμV/m)	Limit (dBμV/m)	Margin (dB)	Detector
1	11160.00	46.32	5.91	52.23	54.00	1.77	Average
2	11160.00	54.39	5.91	60.30	74.00	13.70	Peak
3	16740.00	44.36	10.64	55.00	68.20	13.20	Peak
4	17416.80	44.76	15.22	59.98	68.20	8.22	Peak

802.11n ht20 mode, High Channel, Horizontal

Project No.: XMDN240206-08079E-RF
 Polarization: Horizontal
 Test Mode: Transmitting
 Note: 802.11n20_U-NII-2C_high channel 5700MHz

Serial No.: 2HP4-4
 Tester: Colin Yang

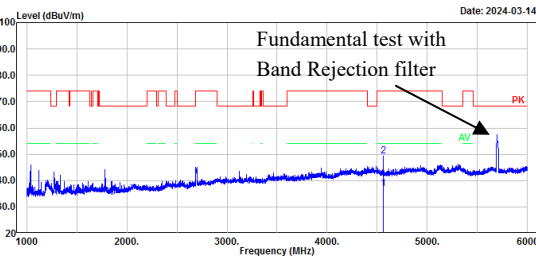

No.	Frequency (MHz)	Reading (dBuV)	Factor (dB/m)	Result (dBuV/m)	Limit (dBuV/m)	Margin (dB)	Detector
1	4561.00	40.32	-3.44	36.88	54.00	17.12	Average
2	4561.00	52.70	-3.44	49.26	74.00	24.74	Peak

802.11n ht20 mode, High Channel, Vertical

Project No.: XMDN240206-08079E-RF
 Polarization: Vertical
 Test Mode: Transmitting
 Note: 802.11n20_U-NII-2C_high channel 5700MHz

Serial No.: 2HP4-4
 Tester: Colin Yang

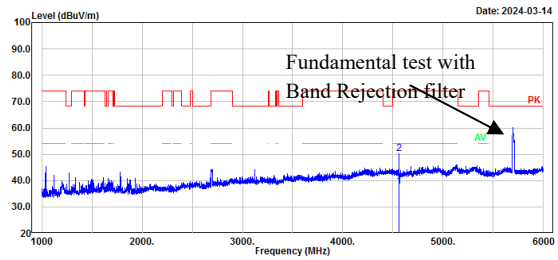

No.	Frequency (MHz)	Reading (dBuV)	Factor (dB/m)	Result (dBuV/m)	Limit (dBuV/m)	Margin (dB)	Detector
1	4561.00	41.29	-3.44	37.85	54.00	16.15	Average
2	4561.00	53.68	-3.44	50.24	74.00	23.76	Peak

Project No.: XMDN240206-08079E-RF
 Polarization: Horizontal
 Test Mode: Transmitting
 Note: 802.11n20_U-NII-2C_high channel 5700MHz

Serial No.: 2HP4-4
 Tester: Colin Yang

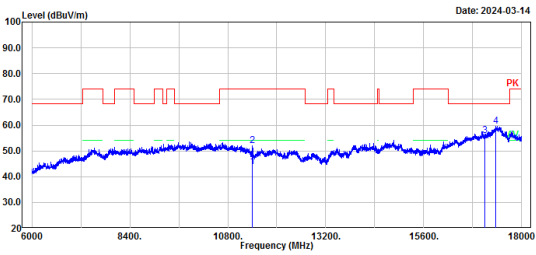

No.	Frequency (MHz)	Reading (dBuV)	Factor (dB/m)	Result (dBuV/m)	Limit (dBuV/m)	Margin (dB)	Detector
1	11400.00	39.62	4.33	43.95	54.00	10.05	Average
2	11400.00	47.78	4.33	52.11	74.00	21.89	Peak
3	17100.00	43.11	12.80	55.91	68.20	12.29	Peak
4	17366.40	44.70	14.80	59.50	68.20	8.70	Peak

Project No.: XMDN240206-08079E-RF
 Polarization: Vertical
 Test Mode: Transmitting
 Note: 802.11n20_U-NII-2C_high channel 5700MHz

Serial No.: 2HP4-4
 Tester: Colin Yang

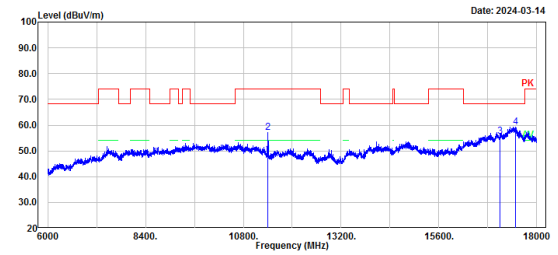

No.	Frequency (MHz)	Reading (dBuV)	Factor (dB/m)	Result (dBuV/m)	Limit (dBuV/m)	Margin (dB)	Detector
1	11400.00	44.27	4.33	48.60	54.00	5.40	Average
2	11400.00	52.74	4.33	57.07	74.00	16.93	Peak
3	17100.00	42.70	12.80	55.50	68.20	12.70	Peak
4	17474.40	43.65	15.67	59.32	68.20	8.88	Peak

802.11n ht20 mode, High Channel, Bandedge, Horizontal

Project No.: XMDN240206-08079E-RF Serial No.: 2HP4-4
 Polarization: Horizontal Tester: Colin Yang
 Test Mode: Transmitting
 Note: 802.11n20_U-NII-2C_high channel 5700MHz

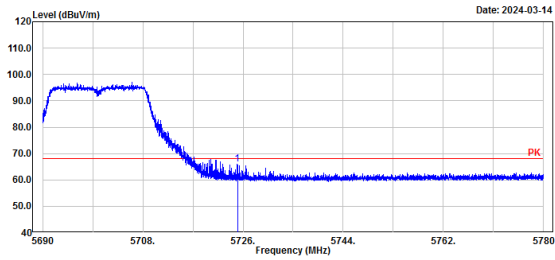

No.	Frequency (MHz)	Reading (dBuV)	Factor (dB/m)	Result (dBuV/m)	Limit (dBuV/m)	Margin (dB)	Detector
1	5725.00	36.09	29.81	65.90	68.20	2.30	Peak

802.11n ht20 mode, High Channel, Bandedge, Vertical

Project No.: XMDN240206-08079E-RF Serial No.: 2HP4-4
 Polarization: Vertical Tester: Colin Yang
 Test Mode: Transmitting
 Note: 802.11n20_U-NII-2C_high channel 5700MHz

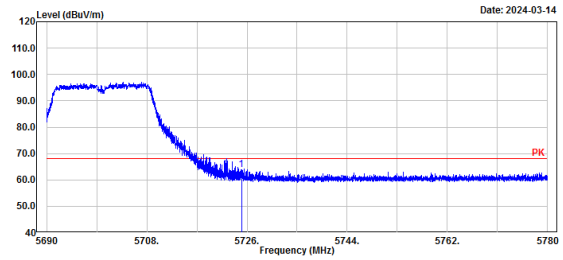

No.	Frequency (MHz)	Reading (dBuV)	Factor (dB/m)	Result (dBuV/m)	Limit (dBuV/m)	Margin (dB)	Detector
1	5725.00	33.98	29.81	63.79	68.20	4.41	Peak

802.11n ht40 mode, Low Channel, Horizontal

Project No.: XMDN240206-08079E-RF
 Polarization: Horizontal
 Test Mode: Transmitting
 Note: 802.11n40_U-NII-2C_low channel 5510MHz

Serial No.: 2HP4-4
 Tester: Colin Yang

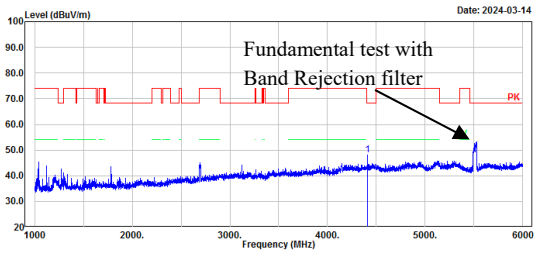

No.	Frequency (MHz)	Reading (dBμV)	Factor (dB/m)	Result (dBμV/m)	Limit (dBμV/m)	Margin (dB)	Detector
1	4409.00	51.52	-3.30	48.22	68.20	19.98	Peak

802.11n ht40 mode, Low Channel, Vertical

Project No.: XMDN240206-08079E-RF
 Polarization: Vertical
 Test Mode: Transmitting
 Note: 802.11n40_U-NII-2C_low channel 5510MHz

Serial No.: 2HP4-4
 Tester: Colin Yang

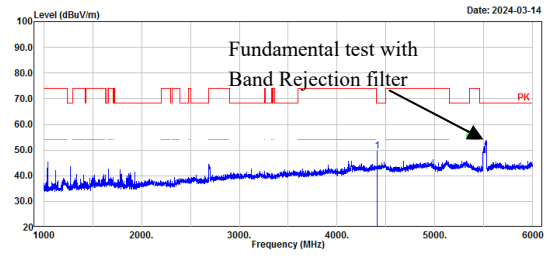

No.	Frequency (MHz)	Reading (dBμV)	Factor (dB/m)	Result (dBμV/m)	Limit (dBμV/m)	Margin (dB)	Detector
1	4409.00	52.86	-3.30	49.56	68.20	18.64	Peak

Project No.: XMDN240206-08079E-RF
 Polarization: Horizontal
 Test Mode: Transmitting
 Note: 802.11n40_U-NII-2C_low channel 5510MHz

Serial No.: 2HP4-4
 Tester: Colin Yang

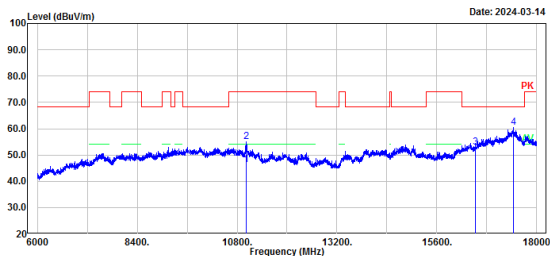

No.	Frequency (MHz)	Reading (dBμV)	Factor (dB/m)	Result (dBμV/m)	Limit (dBμV/m)	Margin (dB)	Detector
1	11020.00	40.09	6.30	46.39	54.00	7.61	Average
2	11020.00	48.61	6.30	54.91	74.00	19.09	Peak
3	16530.00	43.46	9.54	53.00	68.20	15.20	Peak
4	17431.20	45.23	15.33	60.56	68.20	7.64	Peak

Project No.: XMDN240206-08079E-RF
 Polarization: Vertical
 Test Mode: Transmitting
 Note: 802.11n40_U-NII-2C_low channel 5510MHz

Serial No.: 2HP4-4
 Tester: Colin Yang

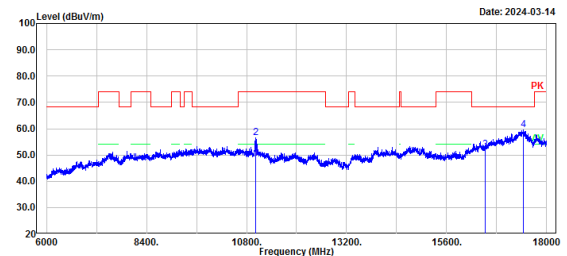

No.	Frequency (MHz)	Reading (dBμV)	Factor (dB/m)	Result (dBμV/m)	Limit (dBμV/m)	Margin (dB)	Detector
1	11020.00	42.47	6.30	48.77	54.00	5.23	Average
2	11020.00	50.30	6.30	56.60	74.00	17.40	Peak
3	16530.00	42.49	9.54	52.03	68.20	16.17	Peak
4	17433.00	44.24	15.34	59.58	68.20	8.62	Peak

802.11n ht40 mode, Low Channel, Bandedge, Horizontal

Project No.: XMDN240206-08079E-RF Serial No.: 2HP4-4
 Polarization: Horizontal Tester: Colin Yang
 Test Mode: Transmitting
 Note: 802.11n40_U-NII-2C_low channel 5510MHz

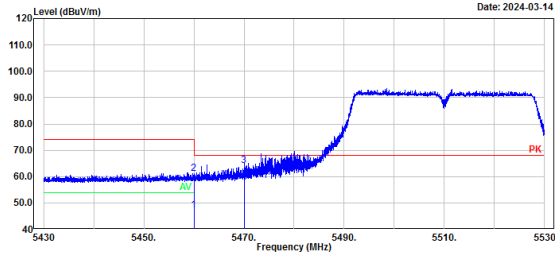

No.	Frequency (MHz)	Reading (dBμV)	Factor (dB/m)	Result (dBμV/m)	Limit (dBμV/m)	Margin (dB)	Detector
1	5460.00	17.78	29.34	47.12	54.00	6.88	Average
2	5460.00	31.91	29.34	61.25	74.00	12.75	Peak
3	5470.00	34.72	29.36	64.08	68.20	4.12	Peak

802.11n ht40 mode, Low Channel, Bandedge, Vertical

Project No.: XMDN240206-08079E-RF Serial No.: 2HP4-4
 Polarization: Vertical Tester: Colin Yang
 Test Mode: Transmitting
 Note: 802.11n40_U-NII-2C_low channel 5510MHz

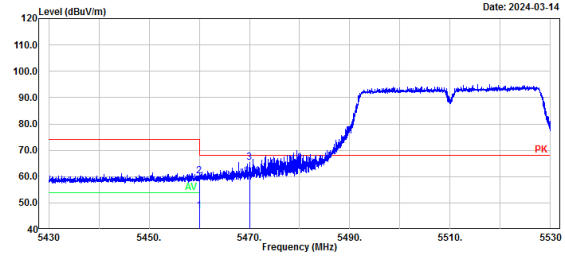

No.	Frequency (MHz)	Reading (dBμV)	Factor (dB/m)	Result (dBμV/m)	Limit (dBμV/m)	Margin (dB)	Detector
1	5460.00	17.64	29.34	46.98	54.00	7.02	Average
2	5460.00	30.98	29.34	60.32	74.00	13.68	Peak
3	5470.00	36.01	29.36	65.37	68.20	2.83	Peak

802.11n ht40 mode, Middle Channel, Horizontal

Project No.: XMDN240206-08079E-RF Serial No.: 2HP4-4
 Polarization: Horizontal Tester: Colin Yang
 Test Mode: Transmitting
 Note: 802.11n40_U-NII-2C_middle channel 5550MHz

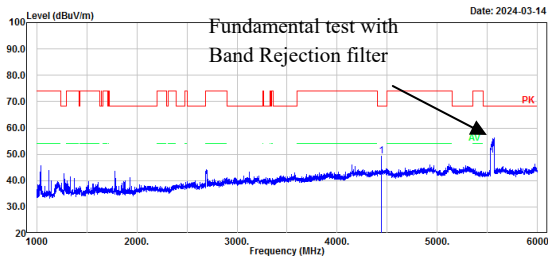

No.	Frequency (MHz)	Reading (dBuV)	Factor (dB/m)	Result (dBuV/m)	Limit (dBuV/m)	Margin (dB)	Detector
1	4440.00	52.51	-3.28	49.23	68.20	18.97	Peak

802.11n ht40 mode, Middle Channel, Vertical

Project No.: XMDN240206-08079E-RF Serial No.: 2HP4-4
 Polarization: Vertical Tester: Colin Yang
 Test Mode: Transmitting
 Note: 802.11n40_U-NII-2C_middle channel 5550MHz

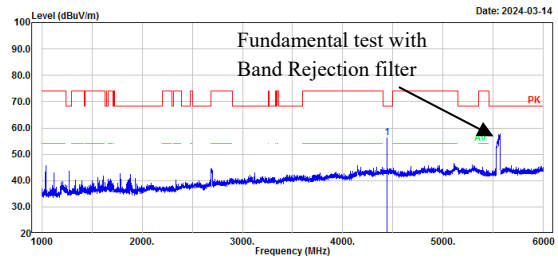

No.	Frequency (MHz)	Reading (dBuV)	Factor (dB/m)	Result (dBuV/m)	Limit (dBuV/m)	Margin (dB)	Detector
1	4440.00	59.57	-3.28	56.29	68.20	11.91	Peak

Project No.: XMDN240206-08079E-RF Serial No.: 2HP4-4
 Polarization: Horizontal Tester: Colin Yang
 Test Mode: Transmitting
 Note: 802.11n40_U-NII-2C_middle channel 5550MHz

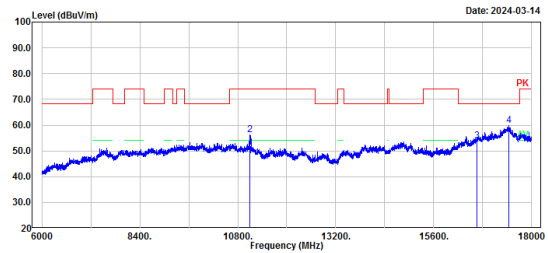

No.	Frequency (MHz)	Reading (dBuV)	Factor (dB/m)	Result (dBuV/m)	Limit (dBuV/m)	Margin (dB)	Detector
1	11100.00	42.03	6.09	48.12	54.00	5.88	Average
2	11100.00	50.11	6.09	56.20	74.00	17.80	Peak
3	16650.00	43.61	10.19	53.80	68.20	14.40	Peak
4	17448.00	44.33	15.45	59.78	68.20	8.42	Peak

Project No.: XMDN240206-08079E-RF Serial No.: 2HP4-4
 Polarization: Vertical Tester: Colin Yang
 Test Mode: Transmitting
 Note: 802.11n40_U-NII-2C_middle channel 5550MHz

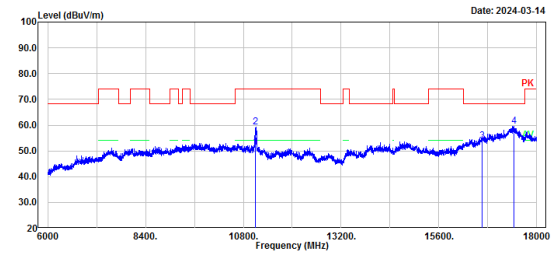

No.	Frequency (MHz)	Reading (dBuV)	Factor (dB/m)	Result (dBuV/m)	Limit (dBuV/m)	Margin (dB)	Detector
1	11100.00	45.21	6.09	51.30	54.00	2.70	Average
2	11100.00	53.15	6.09	59.24	74.00	14.76	Peak
3	16650.00	43.69	10.19	53.88	68.20	14.32	Peak
4	17445.60	44.05	15.44	59.49	68.20	8.71	Peak

802.11n ht40 mode, High Channel, Horizontal

Project No.: XMDN240206-08079E-RF Serial No.: 2HP4-4
 Polarization: Horizontal Tester: Colin Yang
 Test Mode: Transmitting
 Note: 802.11n40_U-NII-2C_high channel 5670MHz

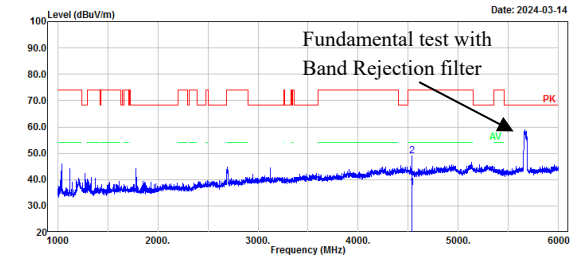

No.	Frequency (MHz)	Reading (dBuV)	Factor (dB/m)	Result (dBuV/m)	Limit (dBuV/m)	Margin (dB)	Detector
1	4536.00	40.12	-3.33	36.79	54.00	17.21	Average
2	4536.00	52.25	-3.33	48.92	74.00	25.08	Peak

802.11n ht40 mode, High Channel, Vertical

Project No.: XMDN240206-08079E-RF Serial No.: 2HP4-4
 Polarization: Vertical Tester: Colin Yang
 Test Mode: Transmitting
 Note: 802.11n40_U-NII-2C_high channel 5670MHz

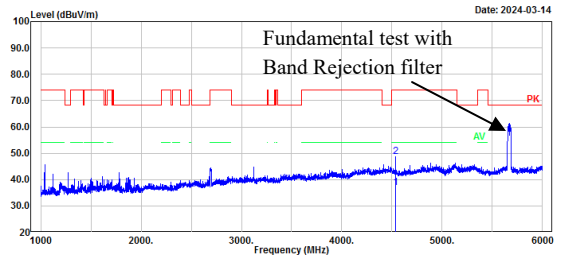

No.	Frequency (MHz)	Reading (dBuV)	Factor (dB/m)	Result (dBuV/m)	Limit (dBuV/m)	Margin (dB)	Detector
1	4536.00	40.09	-3.33	36.76	54.00	17.24	Average
2	4536.00	52.05	-3.33	48.72	74.00	25.28	Peak

Project No.: XMDN240206-08079E-RF Serial No.: 2HP4-4
 Polarization: Horizontal Tester: Colin Yang
 Test Mode: Transmitting
 Note: 802.11n40_U-NII-2C_high channel 5670MHz

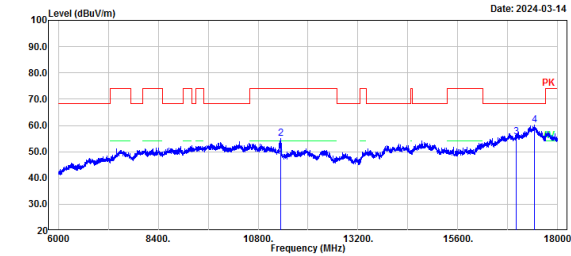

No.	Frequency (MHz)	Reading (dBuV)	Factor (dB/m)	Result (dBuV/m)	Limit (dBuV/m)	Margin (dB)	Detector
1	11340.00	42.31	4.83	47.14	54.00	6.86	Average
2	11340.00	50.17	4.83	55.00	74.00	19.00	Peak
3	17010.00	43.53	12.00	55.53	68.20	12.67	Peak
4	17436.00	44.94	15.36	60.30	68.20	7.90	Peak

Project No.: XMDN240206-08079E-RF Serial No.: 2HP4-4
 Polarization: Vertical Tester: Colin Yang
 Test Mode: Transmitting
 Note: 802.11n40_U-NII-2C_high channel 5670MHz

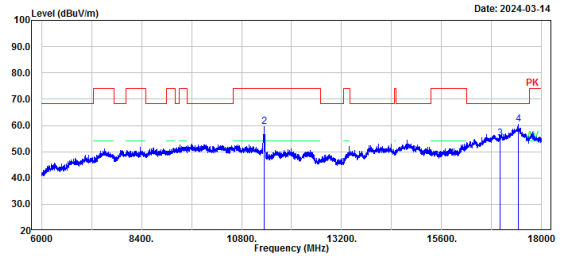

No.	Frequency (MHz)	Reading (dBuV)	Factor (dB/m)	Result (dBuV/m)	Limit (dBuV/m)	Margin (dB)	Detector
1	11340.00	46.12	4.83	50.95	54.00	3.05	Average
2	11340.00	54.78	4.83	59.61	74.00	14.39	Peak
3	17010.00	42.96	12.00	54.96	68.20	13.24	Peak
4	17445.60	45.06	15.44	60.50	68.20	7.70	Peak

802.11n ht40 mode, High Channel, Bandedge, Horizontal

Project No.: XMDN240206-08079E-RF Serial No.: 2HP4-4
 Polarization: Horizontal Tester: Colin Yang
 Test Mode: Transmitting
 Note: 802.11n40_U-NII-2C_high channel 5670MHz

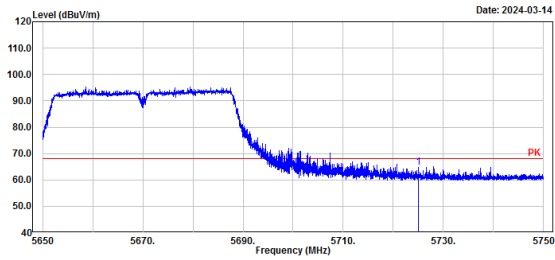

No.	Frequency (MHz)	Reading (dBμV)	Factor (dB/m)	Result (dBμV/m)	Limit (dBμV/m)	Margin (dB)	Detector
1	5725.00	35.07	29.81	64.88	68.20	3.32	Peak

802.11n ht40 mode, High Channel, Bandedge, Vertical

Project No.: XMDN240206-08079E-RF Serial No.: 2HP4-4
 Polarization: Vertical Tester: Colin Yang
 Test Mode: Transmitting
 Note: 802.11n40_U-NII-2C_high channel 5670MHz

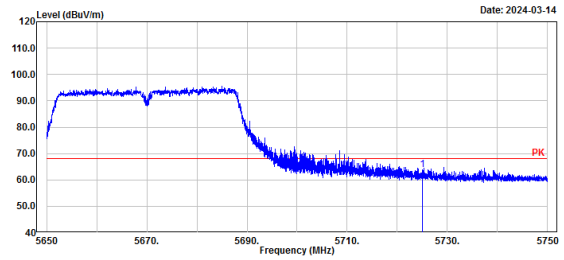

No.	Frequency (MHz)	Reading (dBμV)	Factor (dB/m)	Result (dBμV/m)	Limit (dBμV/m)	Margin (dB)	Detector
1	5725.00	34.03	29.81	63.84	68.20	4.36	Peak

802.11 ac 80 mode, Low Channel, Horizontal

Project No.: XMDN240206-08079E-RF
 Polarization: Horizontal
 Test Mode: Transmitting
 Note: 802.11ac80_U-NII-2C_low channel 5530MHz

Serial No.: 2HP4-4
 Tester: Colin Yang

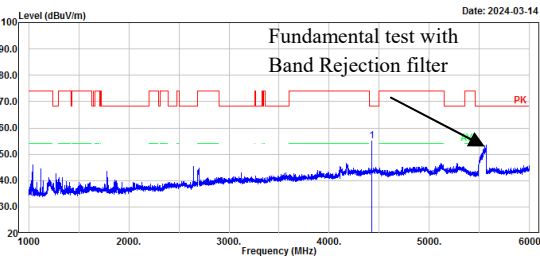

No.	Frequency (MHz)	Reading (dBuV)	Factor (dB/m)	Result (dBuV/m)	Limit (dBuV/m)	Margin (dB)	Detector
1	4424.00	58.21	-3.29	54.92	68.20	13.28	Peak

802.11 ac 80 mode, Low Channel, Vertical

Project No.: XMDN240206-08079E-RF
 Polarization: Vertical
 Test Mode: Transmitting
 Note: 802.11ac80_U-NII-2C_low channel 5530MHz

Serial No.: 2HP4-4
 Tester: Colin Yang

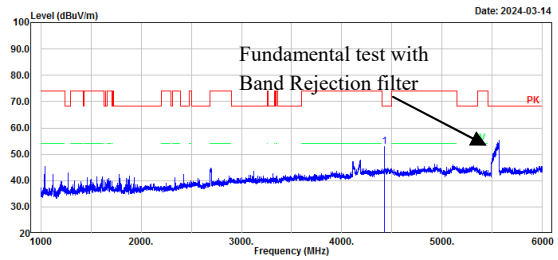

No.	Frequency (MHz)	Reading (dBuV)	Factor (dB/m)	Result (dBuV/m)	Limit (dBuV/m)	Margin (dB)	Detector
1	4424.00	56.21	-3.29	52.92	68.20	15.28	Peak

Project No.: XMDN240206-08079E-RF
 Polarization: Horizontal
 Test Mode: Transmitting
 Note: 802.11ac80_U-NII-2C_low channel 5530MHz

Serial No.: 2HP4-4
 Tester: Colin Yang

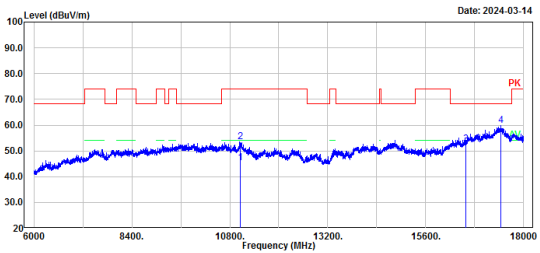

No.	Frequency (MHz)	Reading (dBuV)	Factor (dB/m)	Result (dBuV/m)	Limit (dBuV/m)	Margin (dB)	Detector
1	11060.00	39.26	6.19	45.45	54.00	8.55	Average
2	11060.00	47.25	6.19	53.44	74.00	20.56	Peak
3	16590.00	42.76	9.91	52.67	68.20	15.53	Peak
4	17438.40	44.41	15.39	59.80	68.20	8.40	Peak

Project No.: XMDN240206-08079E-RF
 Polarization: Vertical
 Test Mode: Transmitting
 Note: 802.11ac80_U-NII-2C_low channel 5530MHz

Serial No.: 2HP4-4
 Tester: Colin Yang

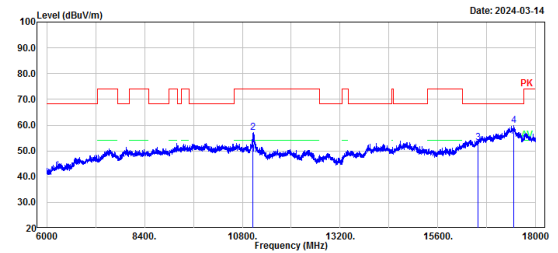

No.	Frequency (MHz)	Reading (dBuV)	Factor (dB/m)	Result (dBuV/m)	Limit (dBuV/m)	Margin (dB)	Detector
1	11060.00	42.35	6.19	48.54	54.00	5.46	Average
2	11060.00	50.90	6.19	57.09	74.00	16.91	Peak
3	16590.00	43.16	9.91	53.07	68.20	15.13	Peak
4	17460.00	44.14	15.56	59.70	68.20	8.50	Peak

802.11 ac 80 mode, Low Channel, Bandedge, Horizontal

Project No.: XMDN240206-08079E-RF Serial No.: 2HP4-4
 Polarization: Horizontal Tester: Colin Yang
 Test Mode: Transmitting
 Note: 802.11ac80_U-NII-2C_low channel 5530MHz

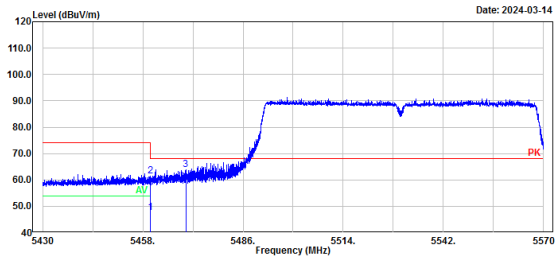

No.	Frequency (MHz)	Reading (dBμV)	Factor (dB/m)	Result (dBμV/m)	Limit (dBμV/m)	Margin (dB)	Detector
1	5460.00	18.23	29.34	47.57	54.00	6.43	Average
2	5460.00	32.19	29.34	61.53	74.00	12.47	Peak
3	5470.00	34.49	29.36	63.85	68.20	4.35	Peak

802.11 ac 80 mode, Low Channel, Bandedge, Vertical

Project No.: XMDN240206-08079E-RF Serial No.: 2HP4-4
 Polarization: Vertical Tester: Colin Yang
 Test Mode: Transmitting
 Note: 802.11ac80_U-NII-2C_low channel 5530MHz

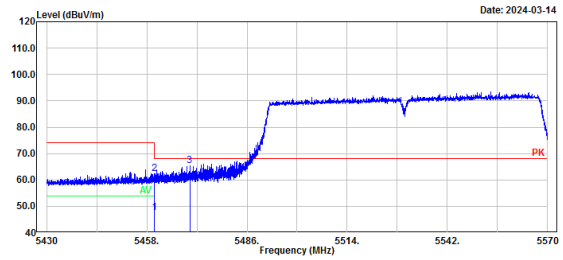

No.	Frequency (MHz)	Reading (dBμV)	Factor (dB/m)	Result (dBμV/m)	Limit (dBμV/m)	Margin (dB)	Detector
1	5460.00	18.25	29.34	47.59	54.00	6.41	Average
2	5460.00	33.14	29.34	62.48	74.00	11.52	Peak
3	5470.00	35.92	29.36	65.28	68.20	2.92	Peak

802.11 ac 80 mode, High Channel, Horizontal

Project No.: XMDN240206-08079E-RF Serial No.: 2HP4-4
 Polarization: Horizontal Tester: Colin Yang
 Test Mode: Transmitting
 Note: 802.11ac80_U-NII-2C_high channel 5610MHz

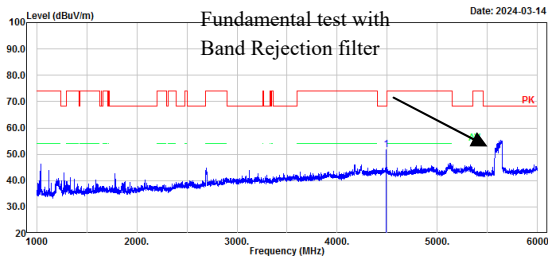

No.	Frequency (MHz)	Reading (dBuV)	Factor (dB/m)	Result (dBuV/m)	Limit (dBuV/m)	Margin (dB)	Detector
1	4488.00	54.94	-3.21	51.73	68.20	16.47	Peak

802.11 ac 80 mode, High Channel, Vertical

Project No.: XMDN240206-08079E-RF Serial No.: 2HP4-4
 Polarization: Vertical Tester: Colin Yang
 Test Mode: Transmitting
 Note: 802.11ac80_U-NII-2C_high channel 5610MHz

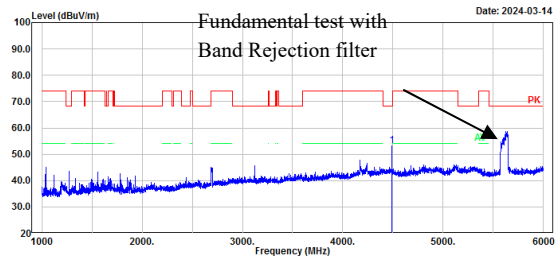

No.	Frequency (MHz)	Reading (dBuV)	Factor (dB/m)	Result (dBuV/m)	Limit (dBuV/m)	Margin (dB)	Detector
1	4488.00	56.40	-3.21	53.19	68.20	15.01	Peak

Project No.: XMDN240206-08079E-RF Serial No.: 2HP4-4
 Polarization: Horizontal Tester: Colin Yang
 Test Mode: Transmitting
 Note: 802.11ac80_U-NII-2C_high channel 5610MHz

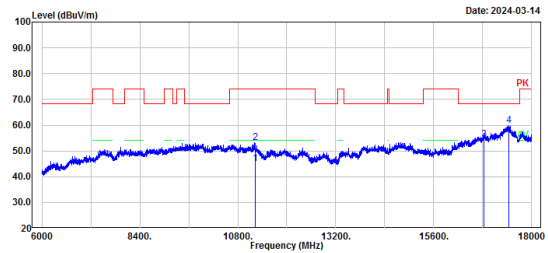

No.	Frequency (MHz)	Reading (dBuV)	Factor (dB/m)	Result (dBuV/m)	Limit (dBuV/m)	Margin (dB)	Detector
1	11220.00	39.37	5.67	45.04	54.00	8.96	Average
2	11220.00	47.41	5.67	53.08	74.00	20.92	Peak
3	16830.00	43.26	11.07	54.33	68.20	13.87	Peak
4	17433.60	44.49	15.34	59.83	68.20	8.37	Peak

Project No.: XMDN240206-08079E-RF Serial No.: 2HP4-4
 Polarization: Vertical Tester: Colin Yang
 Test Mode: Transmitting
 Note: 802.11ac80_U-NII-2C_high channel 5610MHz

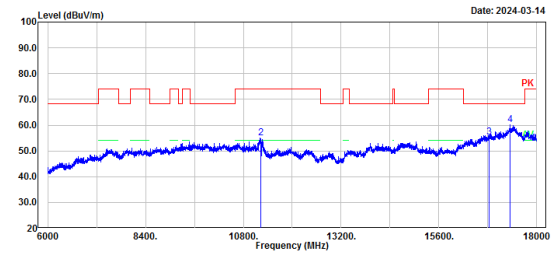

No.	Frequency (MHz)	Reading (dBuV)	Factor (dB/m)	Result (dBuV/m)	Limit (dBuV/m)	Margin (dB)	Detector
1	11220.00	41.27	5.67	46.94	54.00	7.06	Average
2	11220.00	49.43	5.67	55.10	74.00	18.90	Peak
3	16830.00	44.18	11.07	55.25	68.20	12.95	Peak
4	17340.00	45.43	14.58	60.01	68.20	8.19	Peak

802.11ac 80 mode, High Channel, Bandedge, Horizontal

Project No.: XMDN240206-08079E-RF
 Polarization: Horizontal
 Test Mode: Transmitting
 Note: 802.11ac80_U-NII-2C_high channel 5610MHz

Serial No.: 2HP4-4
 Tester: Colin Yang

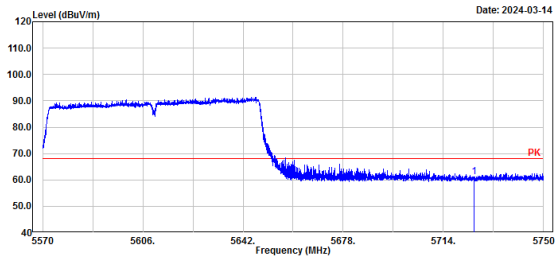

No.	Frequency (MHz)	Reading (dBuV)	Factor (dB/m)	Result (dBuV/m)	Limit (dBuV/m)	Margin (dB)	Detector
1	5725.00	31.26	29.81	61.07	68.20	7.13	Peak

802.11 ac 80 mode, High Channel, Bandedge, Vertical

Project No.: XMDN240206-08079E-RF
 Polarization: Vertical
 Test Mode: Transmitting
 Note: 802.11ac80_U-NII-2C_high channel 5610MHz

Serial No.: 2HP4-4
 Tester: Colin Yang

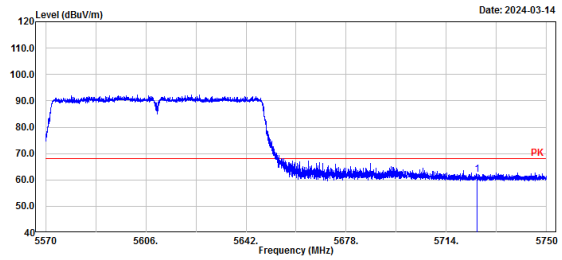

No.	Frequency (MHz)	Reading (dBuV)	Factor (dB/m)	Result (dBuV/m)	Limit (dBuV/m)	Margin (dB)	Detector
1	5725.00	32.13	29.81	61.94	68.20	6.26	Peak

802.11 ac 80 mode, Cross Channel, Horizontal

Project No.: XMDN240206-08079E-RF Serial No.: 2HP4-4
 Polarization: Horizontal Tester: Colin Yang
 Test Mode: Transmitting
 Note: 802.11ac80_U-NII-2C_high channel 5690MHz

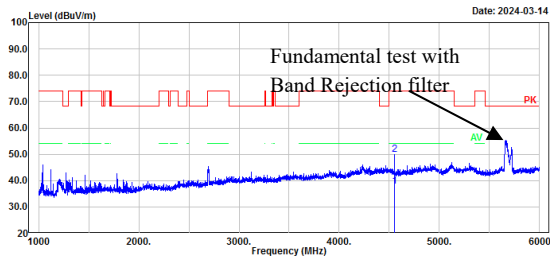

No.	Frequency (MHz)	Reading (dBuV)	Factor (dB/m)	Result (dBuV/m)	Limit (dBuV/m)	Margin (dB)	Detector
1	4552.00	41.36	-3.40	37.96	54.00	16.04	Average
2	4552.00	53.34	-3.40	49.94	74.00	24.06	Peak

802.11 ac 80 mode, Cross Channel, Vertical

Project No.: XMDN240206-08079E-RF Serial No.: 2HP4-4
 Polarization: Vertical Tester: Colin Yang
 Test Mode: Transmitting
 Note: 802.11ac80_U-NII-2C_high channel 5690MHz

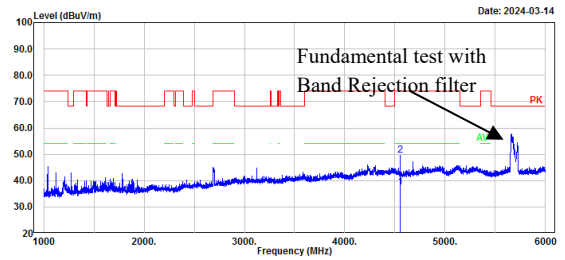

No.	Frequency (MHz)	Reading (dBuV)	Factor (dB/m)	Result (dBuV/m)	Limit (dBuV/m)	Margin (dB)	Detector
1	4552.00	40.86	-3.40	37.46	54.00	16.54	Average
2	4552.00	53.00	-3.40	49.60	74.00	24.40	Peak

Project No.: XMDN240206-08079E-RF Serial No.: 2HP4-4
 Polarization: Horizontal Tester: Colin Yang
 Test Mode: Transmitting
 Note: 802.11ac80_U-NII-2C_high channel 5690MHz

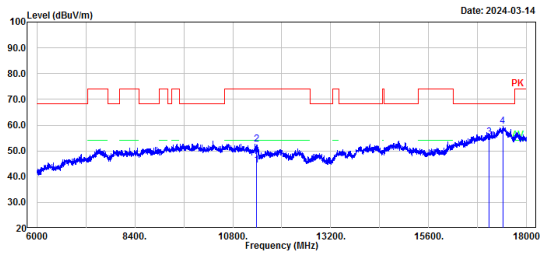

No.	Frequency (MHz)	Reading (dBuV)	Factor (dB/m)	Result (dBuV/m)	Limit (dBuV/m)	Margin (dB)	Detector
1	11380.00	40.03	4.50	44.53	54.00	9.47	Average
2	11380.00	48.20	4.50	52.70	74.00	21.30	Peak
3	17070.00	42.83	12.53	55.36	68.20	12.84	Peak
4	17412.00	44.43	15.17	59.60	68.20	8.60	Peak

Project No.: XMDN240206-08079E-RF Serial No.: 2HP4-4
 Polarization: Vertical Tester: Colin Yang
 Test Mode: Transmitting
 Note: 802.11ac80_U-NII-2C_high channel 5690MHz

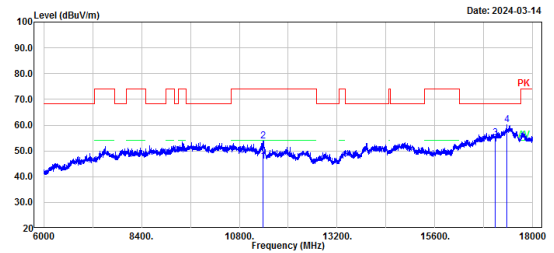

No.	Frequency (MHz)	Reading (dBuV)	Factor (dB/m)	Result (dBuV/m)	Limit (dBuV/m)	Margin (dB)	Detector
1	11380.00	41.43	4.50	45.93	54.00	8.07	Average
2	11380.00	49.33	4.50	53.83	74.00	20.17	Peak
3	17070.00	42.40	12.53	54.93	68.20	13.27	Peak
4	17361.60	45.25	14.76	60.01	68.20	8.19	Peak

802.11 ax he20 mode, Low Channel, Horizontal

Project No.: XMDN240206-08079E-RF
 Polarization: Horizontal
 Test Mode: Transmitting
 Note: 802.11ax20_U-NII-2C_low channel 5500MHz

Serial No.: 2HP4-4
 Tester: Colin Yang

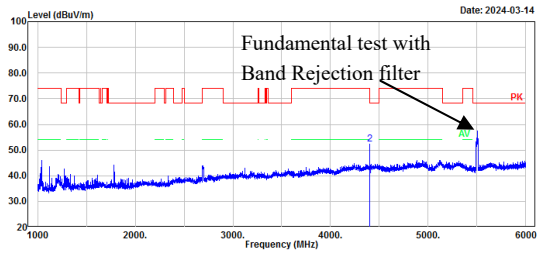

No.	Frequency (MHz)	Reading (dBuV)	Factor (dB/m)	Result (dBuV/m)	Limit (dBuV/m)	Margin (dB)	Detector
1	4400.00	43.29	-3.31	39.98	54.00	14.02	Average
2	4400.00	55.66	-3.31	52.35	68.20	15.85	Peak

802.11 ax he20 mode, Low Channel, Vertical

Project No.: XMDN240206-08079E-RF
 Polarization: Vertical
 Test Mode: Transmitting
 Note: 802.11ax20_U-NII-2C_low channel 5500MHz

Serial No.: 2HP4-4
 Tester: Colin Yang

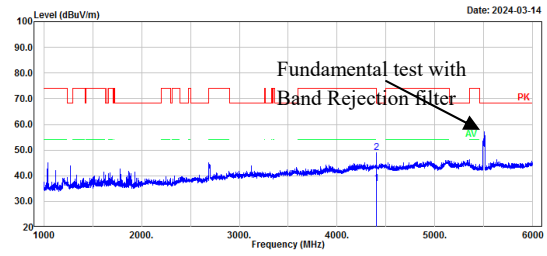

No.	Frequency (MHz)	Reading (dBuV)	Factor (dB/m)	Result (dBuV/m)	Limit (dBuV/m)	Margin (dB)	Detector
1	4400.00	40.28	-3.31	36.97	54.00	17.03	Average
2	4400.00	52.14	-3.31	48.83	68.20	19.37	Peak

Project No.: XMDN240206-08079E-RF
 Polarization: Horizontal
 Test Mode: Transmitting
 Note: 802.11ax20_U-NII-2C_low channel 5500MHz

Serial No.: 2HP4-4
 Tester: Colin Yang

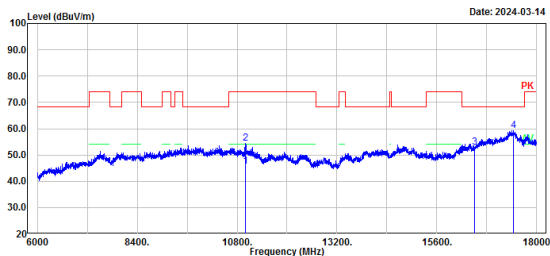

No.	Frequency (MHz)	Reading (dBuV)	Factor (dB/m)	Result (dBuV/m)	Limit (dBuV/m)	Margin (dB)	Detector
1	11000.00	39.23	6.35	45.58	54.00	8.42	Average
2	11000.00	47.96	6.35	54.31	74.00	19.69	Peak
3	16500.00	43.46	9.36	52.82	68.20	15.38	Peak
4	17443.20	43.88	15.42	59.30	68.20	8.90	Peak

Project No.: XMDN240206-08079E-RF
 Polarization: Vertical
 Test Mode: Transmitting
 Note: 802.11ax20_U-NII-2C_low channel 5500MHz

Serial No.: 2HP4-4
 Tester: Colin Yang

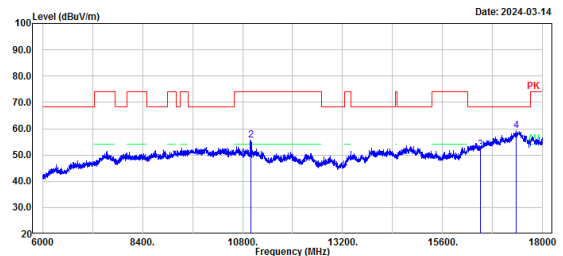

No.	Frequency (MHz)	Reading (dBuV)	Factor (dB/m)	Result (dBuV/m)	Limit (dBuV/m)	Margin (dB)	Detector
1	11000.00	41.28	6.35	47.63	54.00	6.37	Average
2	11000.00	49.41	6.35	55.76	74.00	18.24	Peak
3	16500.00	42.64	9.36	52.00	68.20	16.20	Peak
4	17366.40	44.44	14.80	59.24	68.20	8.96	Peak

802.11 ax he20 mode, Low Channel, Bandedge, Horizontal

Project No.: XMDN240206-08079E-RF Serial No.: 2HP4-4
 Polarization: Horizontal Tester: Colin Yang
 Test Mode: Transmitting
 Note: 802.11ax20_U-NII-2C_low channel 5500MHz

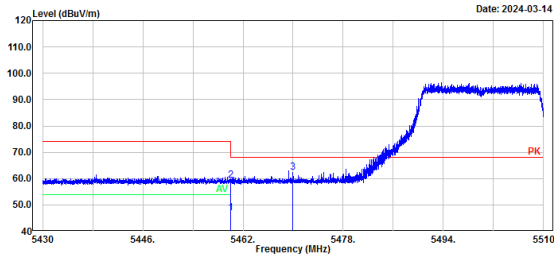

No.	Frequency (MHz)	Reading (dBμV)	Factor (dB/m)	Result (dBμV/m)	Limit (dBμV/m)	Margin (dB)	Detector
1	5460.00	17.53	29.34	46.87	54.00	7.13	Average
2	5460.00	30.09	29.34	59.43	74.00	14.57	Peak
3	5470.00	33.11	29.36	62.47	68.20	5.73	Peak

802.11 ax he20 mode, Low Channel, Bandedge, Vertical

Project No.: XMDN240206-08079E-RF Serial No.: 2HP4-4
 Polarization: Vertical Tester: Colin Yang
 Test Mode: Transmitting
 Note: 802.11ax20_U-NII-2C_low channel 5500MHz

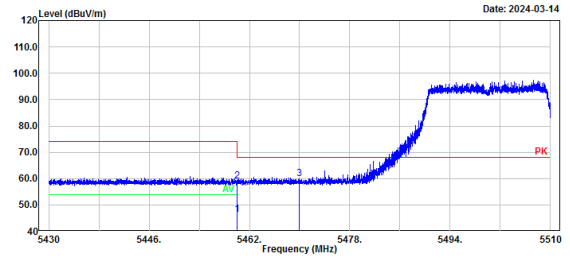

No.	Frequency (MHz)	Reading (dBμV)	Factor (dB/m)	Result (dBμV/m)	Limit (dBμV/m)	Margin (dB)	Detector
1	5460.00	17.09	29.34	46.43	54.00	7.57	Average
2	5460.00	29.54	29.34	58.88	74.00	15.12	Peak
3	5470.00	30.47	29.36	59.83	68.20	8.37	Peak

802.11 ax he20 mode, Middle Channel, Horizontal

Project No.: XMDN240206-08079E-RF
 Polarization: Horizontal
 Test Mode: Transmitting
 Note: 802.11ax20_U-NII-2C_middle channel 5580MHz

Serial No.: 2HP4-4
 Tester: Colin Yang

Date: 2024-03-14

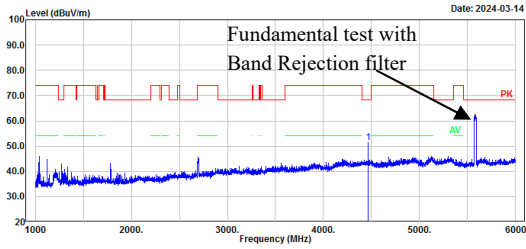

No.	Frequency (MHz)	Reading (dBuV)	Factor (dB/m)	Result (dBuV/m)	Limit (dBuV/m)	Margin (dB)	Detector
1	4465.00	54.50	-3.25	51.25	68.20	16.95	Peak

802.11 ax he20 mode, Middle Channel, Vertical

Project No.: XMDN240206-08079E-RF
 Polarization: Vertical
 Test Mode: Transmitting
 Note: 802.11ax20_U-NII-2C_middle channel 5580MHz

Serial No.: 2HP4-4
 Tester: Colin Yang

Date: 2024-03-14

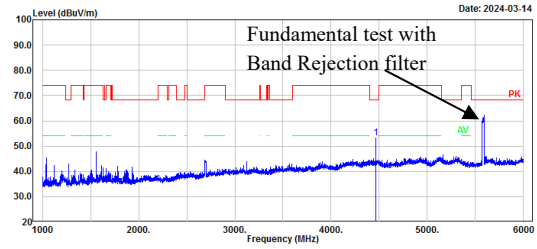

No.	Frequency (MHz)	Reading (dBuV)	Factor (dB/m)	Result (dBuV/m)	Limit (dBuV/m)	Margin (dB)	Detector
1	4465.00	56.33	-3.25	53.08	68.20	15.12	Peak

Project No.: XMDN240206-08079E-RF
 Polarization: Horizontal
 Test Mode: Transmitting
 Note: 802.11ax20_U-NII-2C_middle channel 5580MHz

Serial No.: 2HP4-4
 Tester: Colin Yang

Date: 2024-03-14

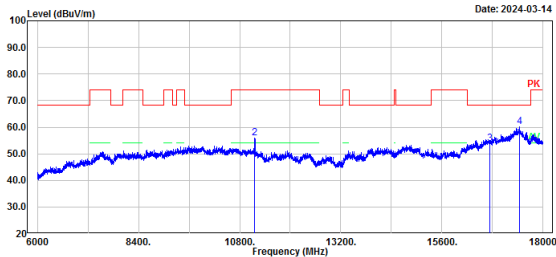

No.	Frequency (MHz)	Reading (dBuV)	Factor (dB/m)	Result (dBuV/m)	Limit (dBuV/m)	Margin (dB)	Detector
1	11160.00	41.98	5.91	47.89	54.00	6.11	Average
2	11160.00	50.03	5.91	55.94	74.00	18.06	Peak
3	16740.00	43.06	10.64	53.70	68.20	14.50	Peak
4	17438.40	44.79	15.39	60.18	68.20	8.02	Peak

Project No.: XMDN240206-08079E-RF
 Polarization: Vertical
 Test Mode: Transmitting
 Note: 802.11ax20_U-NII-2C_middle channel 5580MHz

Serial No.: 2HP4-4
 Tester: Colin Yang

Date: 2024-03-14

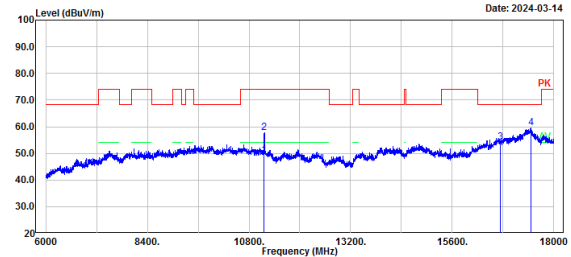

No.	Frequency (MHz)	Reading (dBuV)	Factor (dB/m)	Result (dBuV/m)	Limit (dBuV/m)	Margin (dB)	Detector
1	11160.00	43.35	5.91	49.26	54.00	4.74	Average
2	11160.00	51.75	5.91	57.66	74.00	16.34	Peak
3	16740.00	43.40	10.64	54.04	68.20	14.16	Peak
4	17457.60	43.91	15.53	59.44	68.20	8.76	Peak

802.11 ax he20 mode, High Channel, Horizontal

Project No.: XMDN240206-08079E-RF
 Polarization: Horizontal
 Test Mode: Transmitting
 Note: 802.11ax20_U-NII-2C_high channel 5700MHz

Serial No.: 2HP4-4
 Tester: Colin Yang

Date: 2024-03-14

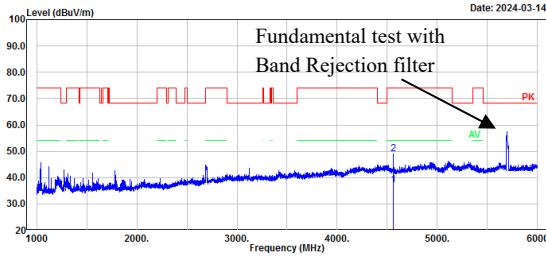

No.	Frequency (MHz)	Reading (dBuV)	Factor (dB/m)	Result (dBuV/m)	Limit (dBuV/m)	Margin (dB)	Detector
1	4560.00	40.59	-3.43	37.16	54.00	16.84	Average
2	4560.00	52.54	-3.43	49.11	74.00	24.89	Peak

802.11 ax he20 mode, High Channel, Vertical

Project No.: XMDN240206-08079E-RF
 Polarization: Vertical
 Test Mode: Transmitting
 Note: 802.11ax20_U-NII-2C_high channel 5700MHz

Serial No.: 2HP4-4
 Tester: Colin Yang

Date: 2024-03-14

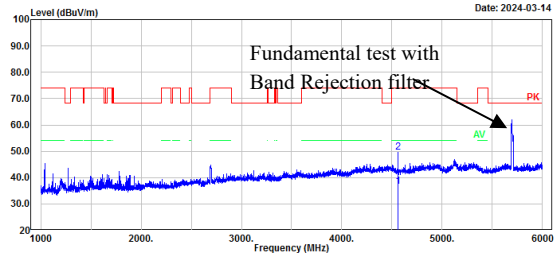

No.	Frequency (MHz)	Reading (dBuV)	Factor (dB/m)	Result (dBuV/m)	Limit (dBuV/m)	Margin (dB)	Detector
1	4560.00	40.16	-3.43	36.73	54.00	17.27	Average
2	4560.00	52.95	-3.43	49.52	74.00	24.48	Peak

Project No.: XMDN240206-08079E-RF
 Polarization: Horizontal
 Test Mode: Transmitting
 Note: 802.11ax20_U-NII-2C_high channel 5700MHz

Serial No.: 2HP4-4
 Tester: Colin Yang

Date: 2024-03-14

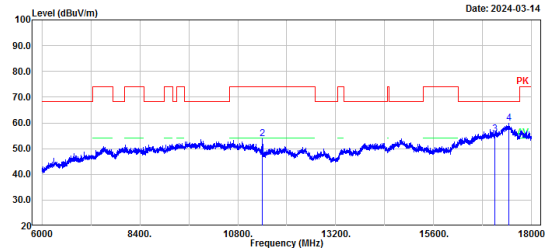

No.	Frequency (MHz)	Reading (dBuV)	Factor (dB/m)	Result (dBuV/m)	Limit (dBuV/m)	Margin (dB)	Detector
1	11400.00	41.27	4.33	45.60	54.00	8.40	Average
2	11400.00	49.53	4.33	53.86	74.00	20.14	Peak
3	17100.00	42.83	12.80	55.63	68.20	12.57	Peak
4	17445.60	44.43	15.44	59.87	68.20	8.33	Peak

Project No.: XMDN240206-08079E-RF
 Polarization: Vertical
 Test Mode: Transmitting
 Note: 802.11ax20_U-NII-2C_high channel 5700MHz

Serial No.: 2HP4-4
 Tester: Colin Yang

Date: 2024-03-14

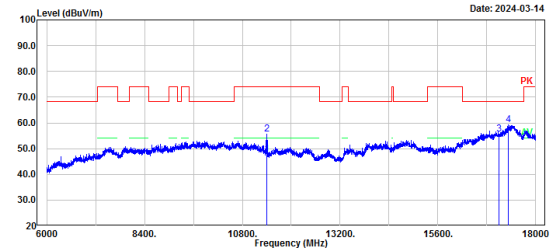

No.	Frequency (MHz)	Reading (dBuV)	Factor (dB/m)	Result (dBuV/m)	Limit (dBuV/m)	Margin (dB)	Detector
1	11400.00	43.38	4.33	47.71	54.00	6.29	Average
2	11400.00	51.22	4.33	55.55	74.00	18.45	Peak
3	17100.00	42.80	12.80	55.60	68.20	12.60	Peak
4	17325.60	44.67	14.45	59.12	68.20	9.08	Peak

802.11 ax he20 mode, High Channel, Bandedge, Horizontal

Project No.: XMDN240206-08079E-RF Serial No.: 2HP4-4
 Polarization: Horizontal Tester: Colin Yang
 Test Mode: Transmitting
 Note: 802.11ax20_U-NII-2C_high channel 5700MHz

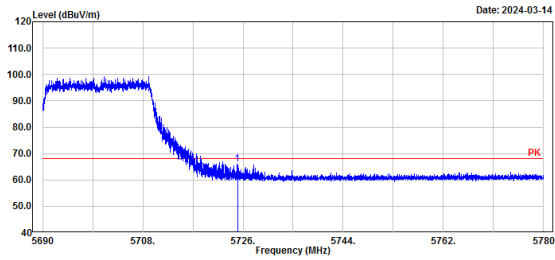

No.	Frequency (MHz)	Reading (dBμV)	Factor (dB/m)	Result (dBμV/m)	Limit (dBμV/m)	Margin (dB)	Detector
1	5725.00	36.08	29.81	65.89	68.20	2.31	Peak

802.11 ax he20 mode, High Channel, Bandedge, Vertical

Project No.: XMDN240206-08079E-RF Serial No.: 2HP4-4
 Polarization: Vertical Tester: Colin Yang
 Test Mode: Transmitting
 Note: 802.11ax20_U-NII-2C_high channel 5700MHz

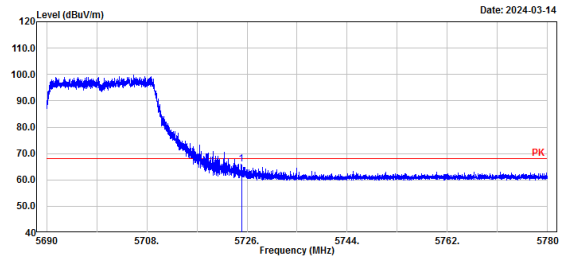

No.	Frequency (MHz)	Reading (dBμV)	Factor (dB/m)	Result (dBμV/m)	Limit (dBμV/m)	Margin (dB)	Detector
1	5725.00	36.27	29.81	66.08	68.20	2.12	Peak

802.11 ax he40 mode, Low Channel, Horizontal

Project No.: XMDN240206-08079E-RF
 Polarization: Horizontal
 Test Mode: Transmitting
 Note: 802.11ax40_U-NII-2C_low channel 5510MHz

Serial No.: 2HP4-4
 Tester: Colin Yang

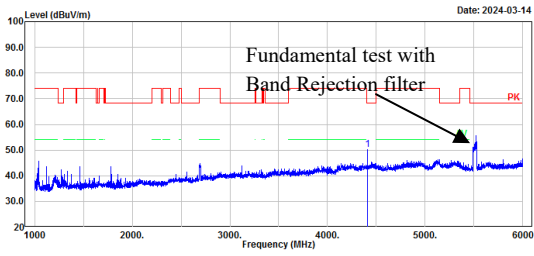

No.	Frequency (MHz)	Reading (dBμV)	Factor (dB/m)	Result (dBμV/m)	Limit (dBμV/m)	Margin (dB)	Detector
1	4407.00	53.62	-3.30	50.32	68.20	17.88	Peak

802.11 ax he40 mode, Low Channel, Vertical

Project No.: XMDN240206-08079E-RF
 Polarization: Vertical
 Test Mode: Transmitting
 Note: 802.11ax40_U-NII-2C_low channel 5510MHz

Serial No.: 2HP4-4
 Tester: Colin Yang

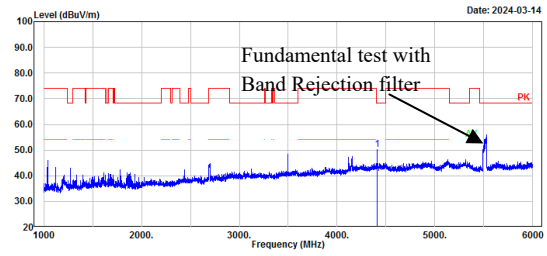

No.	Frequency (MHz)	Reading (dBμV)	Factor (dB/m)	Result (dBμV/m)	Limit (dBμV/m)	Margin (dB)	Detector
1	4408.00	53.37	-3.30	50.07	68.20	18.13	Peak

Project No.: XMDN240206-08079E-RF
 Polarization: Horizontal
 Test Mode: Transmitting
 Note: 802.11ax40_U-NII-2C_low channel 5510MHz

Serial No.: 2HP4-4
 Tester: Colin Yang

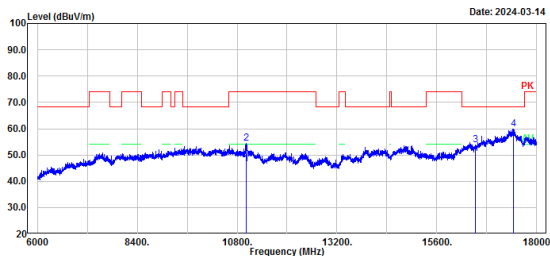

No.	Frequency (MHz)	Reading (dBμV)	Factor (dB/m)	Result (dBμV/m)	Limit (dBμV/m)	Margin (dB)	Detector
1	11020.00	40.27	6.30	46.57	54.00	7.43	Average
2	11020.00	48.24	6.30	54.54	74.00	19.46	Peak
3	16530.00	44.25	9.54	53.79	68.20	14.41	Peak
4	17445.00	44.43	15.44	59.87	68.20	8.33	Peak

Project No.: XMDN240206-08079E-RF
 Polarization: Vertical
 Test Mode: Transmitting
 Note: 802.11ax40_U-NII-2C_low channel 5510MHz

Serial No.: 2HP4-4
 Tester: Colin Yang

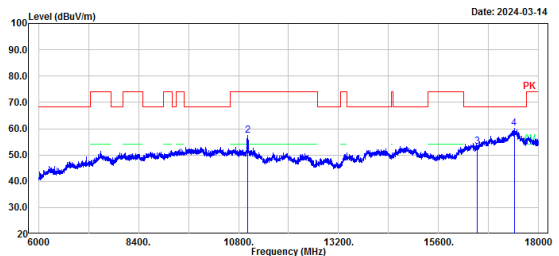

No.	Frequency (MHz)	Reading (dBμV)	Factor (dB/m)	Result (dBμV/m)	Limit (dBμV/m)	Margin (dB)	Detector
1	11020.00	43.35	6.30	49.65	54.00	4.35	Average
2	11020.00	51.00	6.30	57.30	74.00	16.70	Peak
3	16530.00	43.74	9.54	53.28	68.20	14.92	Peak
4	17412.00	44.84	15.17	60.01	68.20	8.19	Peak

802.11 ax he40 mode, Low Channel, Bandedge, Horizontal

Project No.: XMDN240206-08079E-RF Serial No.: ZHP4-4
 Polarization: Horizontal Tester: Colin Yang
 Test Mode: Transmitting
 Note: 802.11ax40_U-NII-2C_low channel 5510MHz

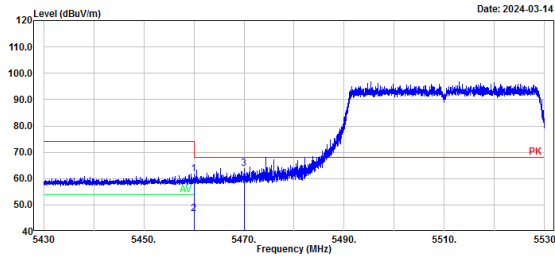

No.	Frequency (MHz)	Reading (dBuV)	Factor (dB/m)	Result (dBuV/m)	Limit (dBuV/m)	Margin (dB)	Detector
1	5460.00	32.48	29.34	61.82	74.00	12.18	Peak
2	5460.00	17.21	29.34	46.55	54.00	7.45	Average
3	5470.00	34.62	29.36	63.98	68.20	4.22	Peak

802.11 ax he40 mode, Low Channel, Bandedge, Vertical

Project No.: XMDN240206-08079E-RF Serial No.: ZHP4-4
 Polarization: Vertical Tester: Colin Yang
 Test Mode: Transmitting
 Note: 802.11ax40_U-NII-2C_low channel 5510MHz

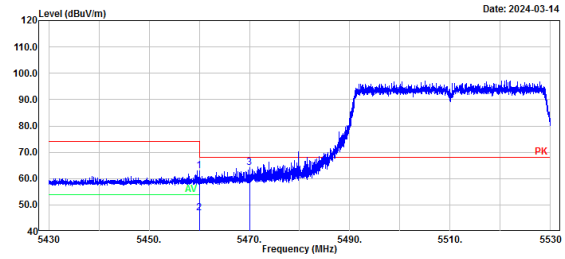

No.	Frequency (MHz)	Reading (dBuV)	Factor (dB/m)	Result (dBuV/m)	Limit (dBuV/m)	Margin (dB)	Detector
1	5460.00	33.67	29.34	63.01	74.00	10.99	Peak
2	5460.00	17.63	29.34	46.97	54.00	7.03	Average
3	5470.00	34.72	29.36	64.08	68.20	4.12	Peak

802.11 ax he40 mode, Middle Channel, Horizontal

Project No.: XMDN240206-08079E-RF
 Polarization: Horizontal
 Test Mode: Transmitting
 Note: 802.11ax40_U-NII-2C_middle channel 5550MHz

Serial No.: 2HP4-4
 Tester: Colin Yang

Date: 2024-03-14

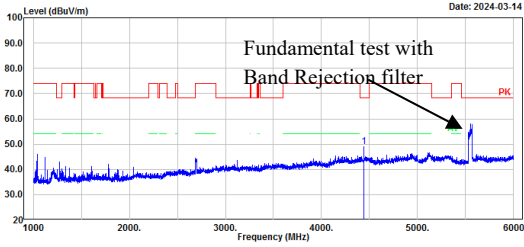

No.	Frequency (MHz)	Reading (dBuV)	Factor (dB/m)	Result (dBuV/m)	Limit (dBuV/m)	Margin (dB)	Detector
1	4440.00	52.21	-3.28	48.93	68.20	19.27	Peak

802.11 ax he40 mode, Middle Channel, Vertical

Project No.: XMDN240206-08079E-RF
 Polarization: Vertical
 Test Mode: Transmitting
 Note: 802.11ax40_U-NII-2C_middle channel 5550MHz

Serial No.: 2HP4-4
 Tester: Colin Yang

Date: 2024-03-14

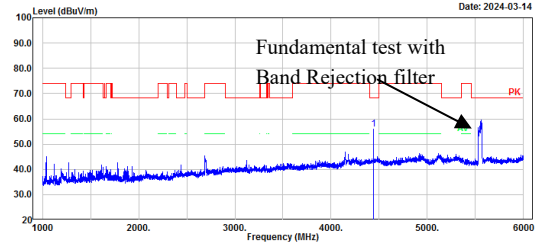

No.	Frequency (MHz)	Reading (dBuV)	Factor (dB/m)	Result (dBuV/m)	Limit (dBuV/m)	Margin (dB)	Detector
1	4440.00	59.07	-3.28	55.79	68.20	12.41	Peak

Project No.: XMDN240206-08079E-RF
 Polarization: Horizontal
 Test Mode: Transmitting
 Note: 802.11ax40_U-NII-2C_middle channel 5550MHz

Serial No.: 2HP4-4
 Tester: Colin Yang

Date: 2024-03-14

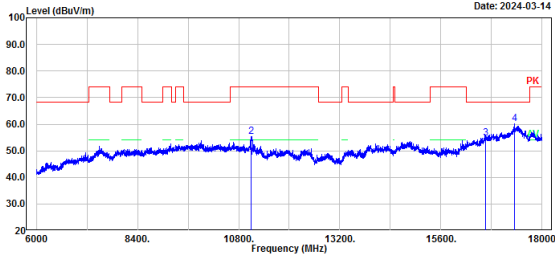

No.	Frequency (MHz)	Reading (dBuV)	Factor (dB/m)	Result (dBuV/m)	Limit (dBuV/m)	Margin (dB)	Detector
1	11100.00	41.46	6.09	47.55	54.00	6.45	Average
2	11100.00	49.32	6.09	55.41	74.00	18.59	Peak
3	16650.00	44.54	10.19	54.73	68.20	13.47	Peak
4	17340.00	45.58	14.58	60.16	68.20	8.04	Peak

Project No.: XMDN240206-08079E-RF
 Polarization: Vertical
 Test Mode: Transmitting
 Note: 802.11ax40_U-NII-2C_middle channel 5550MHz

Serial No.: 2HP4-4
 Tester: Colin Yang

Date: 2024-03-14

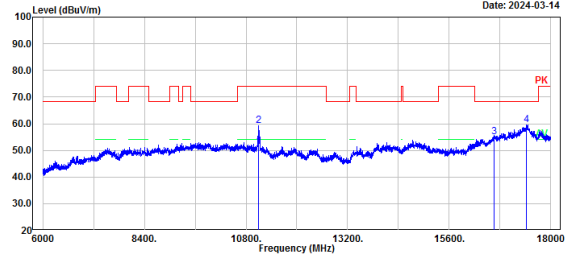

No.	Frequency (MHz)	Reading (dBuV)	Factor (dB/m)	Result (dBuV/m)	Limit (dBuV/m)	Margin (dB)	Detector
1	11100.00	45.36	6.09	51.45	54.00	2.55	Average
2	11100.00	53.29	6.09	59.38	74.00	14.62	Peak
3	16650.00	44.87	10.19	55.06	68.20	13.14	Peak
4	17424.00	44.19	15.27	59.46	68.20	8.74	Peak

802.11 ax he40 mode, High Channel, Horizontal

Project No.: XMDN240206-08079E-RF Serial No.: 2HP4-4
 Polarization: Horizontal Tester: Colin Yang
 Test Mode: Transmitting
 Note: 802.11ax40_U-NII-2C_high channel 5670MHz

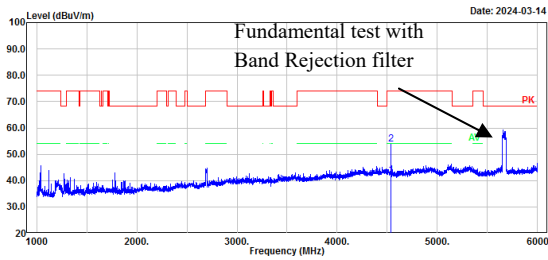

No.	Frequency (MHz)	Reading (dBuV)	Factor (dB/m)	Result (dBuV/m)	Limit (dBuV/m)	Margin (dB)	Detector
1	4536.00	45.29	-3.33	41.96	54.00	12.04	Average
2	4536.00	57.29	-3.33	53.96	74.00	20.04	Peak

802.11 ax he40 mode, High Channel, Vertical

Project No.: XMDN240206-08079E-RF Serial No.: 2HP4-4
 Polarization: Vertical Tester: Colin Yang
 Test Mode: Transmitting
 Note: 802.11ax40_U-NII-2C_high channel 5670MHz

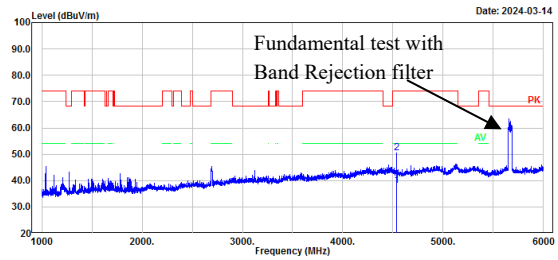

No.	Frequency (MHz)	Reading (dBuV)	Factor (dB/m)	Result (dBuV/m)	Limit (dBuV/m)	Margin (dB)	Detector
1	4536.00	41.49	-3.33	38.16	54.00	15.84	Average
2	4536.00	53.96	-3.33	50.63	74.00	23.37	Peak

Project No.: XMDN240206-08079E-RF Serial No.: 2HP4-4
 Polarization: Horizontal Tester: Colin Yang
 Test Mode: Transmitting
 Note: 802.11ax40_U-NII-2C_high channel 5670MHz

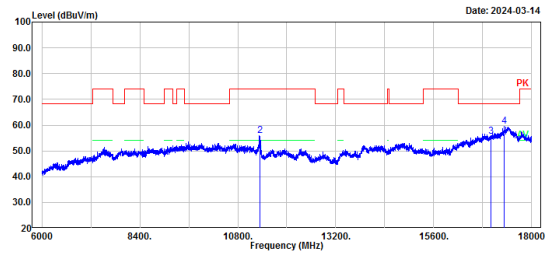

No.	Frequency (MHz)	Reading (dBuV)	Factor (dB/m)	Result (dBuV/m)	Limit (dBuV/m)	Margin (dB)	Detector
1	11340.00	43.52	4.83	48.35	54.00	5.65	Average
2	11340.00	51.19	4.83	56.02	74.00	17.98	Peak
3	17010.00	43.71	12.00	55.71	68.20	12.49	Peak
4	17320.80	45.17	14.42	59.59	68.20	8.61	Peak

Project No.: XMDN240206-08079E-RF Serial No.: 2HP4-4
 Polarization: Vertical Tester: Colin Yang
 Test Mode: Transmitting
 Note: 802.11ax40_U-NII-2C_high channel 5670MHz

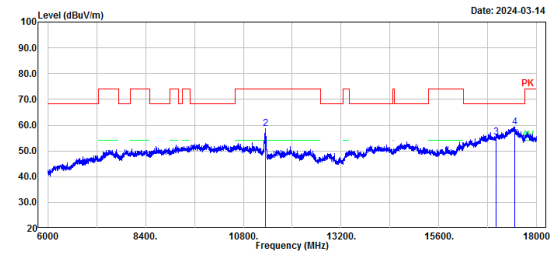

No.	Frequency (MHz)	Reading (dBuV)	Factor (dB/m)	Result (dBuV/m)	Limit (dBuV/m)	Margin (dB)	Detector
1	11340.00	45.57	4.83	50.40	54.00	3.60	Average
2	11340.00	53.73	4.83	58.56	74.00	15.44	Peak
3	17010.00	43.21	12.00	55.21	68.20	12.99	Peak
4	17460.00	43.70	15.56	59.26	68.20	8.94	Peak

802.11ax ht40 mode, High Channel, Bandedge, Horizontal

Project No.: XMDN240206-08079E-RF Serial No.: 2HP4-4
 Polarization: Horizontal Tester: Colin Yang
 Test Mode: Transmitting
 Note: 802.11ax40_U-NII-2C_high channel 5670MHz

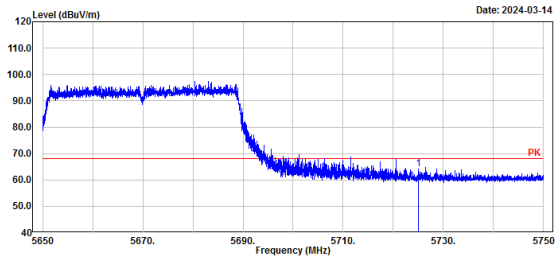

No.	Frequency (MHz)	Reading (dBμV)	Factor (dB/m)	Result (dBμV/m)	Limit (dBμV/m)	Margin (dB)	Detector
1	5725.00	34.22	29.81	64.03	68.20	4.17	Peak

802.11 ax he40 mode, High Channel, Bandedge, Vertical

Project No.: XMDN240206-08079E-RF Serial No.: 2HP4-4
 Polarization: Vertical Tester: Colin Yang
 Test Mode: Transmitting
 Note: 802.11ax40_U-NII-2C_high channel 5670MHz

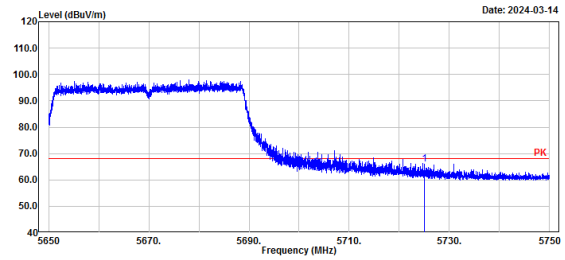

No.	Frequency (MHz)	Reading (dBμV)	Factor (dB/m)	Result (dBμV/m)	Limit (dBμV/m)	Margin (dB)	Detector
1	5725.00	36.27	29.81	66.08	68.20	2.12	Peak

802.11 ax 80 mode, Low Channel, Horizontal

Project No.: XMDN240206-08079E-RF
 Polarization: Horizontal
 Test Mode: Transmitting
 Note: 802.11ax80_U-NII-2C_low channel 5530MHz

Serial No.: 2HP4-4
 Tester: Colin Yang

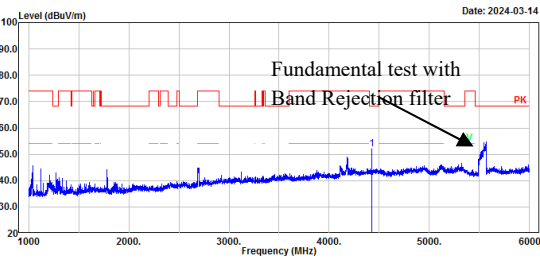

No.	Frequency (MHz)	Reading (dBuV)	Factor (dB/m)	Result (dBuV/m)	Limit (dBuV/m)	Margin (dB)	Detector
1	4423.00	55.40	-3.29	52.11	68.20	16.09	Peak

802.11 ax 80 mode, Low Channel, Vertical

Project No.: XMDN240206-08079E-RF
 Polarization: Vertical
 Test Mode: Transmitting
 Note: 802.11ax80_U-NII-2C_low channel 5530MHz

Serial No.: 2HP4-4
 Tester: Colin Yang

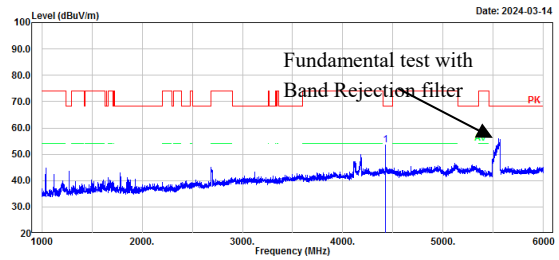

No.	Frequency (MHz)	Reading (dBuV)	Factor (dB/m)	Result (dBuV/m)	Limit (dBuV/m)	Margin (dB)	Detector
1	4424.00	56.93	-3.29	53.64	68.20	14.56	Peak

Project No.: XMDN240206-08079E-RF
 Polarization: Horizontal
 Test Mode: Transmitting
 Note: 802.11ax80_U-NII-2C_low channel 5530MHz

Serial No.: 2HP4-4
 Tester: Colin Yang

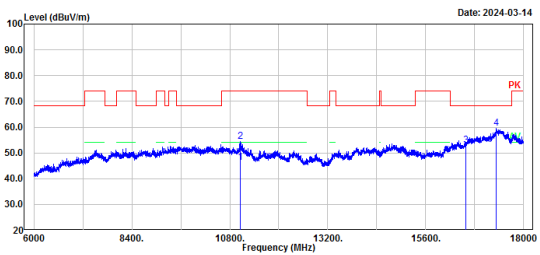

No.	Frequency (MHz)	Reading (dBuV)	Factor (dB/m)	Result (dBuV/m)	Limit (dBuV/m)	Margin (dB)	Detector
1	11060.00	40.16	6.19	46.35	54.00	7.65	Average
2	11060.00	48.30	6.19	54.49	74.00	19.51	Peak
3	16590.00	43.14	9.91	53.05	68.20	15.15	Peak
4	17330.40	44.98	14.51	59.49	68.20	8.71	Peak

Project No.: XMDN240206-08079E-RF
 Polarization: Vertical
 Test Mode: Transmitting
 Note: 802.11ax80_U-NII-2C_low channel 5530MHz

Serial No.: 2HP4-4
 Tester: Colin Yang

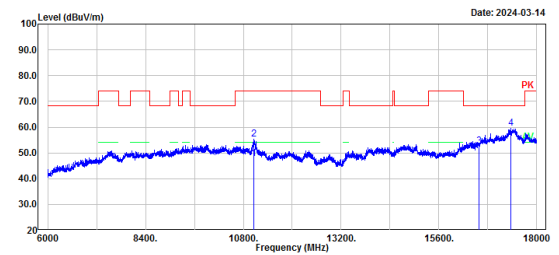

No.	Frequency (MHz)	Reading (dBuV)	Factor (dB/m)	Result (dBuV/m)	Limit (dBuV/m)	Margin (dB)	Detector
1	11060.00	41.62	6.19	47.81	54.00	6.19	Average
2	11060.00	49.12	6.19	55.31	74.00	18.69	Peak
3	16590.00	42.78	9.91	52.69	68.20	15.51	Peak
4	17366.40	44.89	14.80	59.69	68.20	8.51	Peak

802.11 ax 80 mode, Low Channel, Bandedge, Horizontal

Project No.: XMDN240206-08079E-RF Serial No.: 2HP4-4
 Polarization: Horizontal Tester: Colin Yang
 Test Mode: Transmitting
 Note: 802.11ax80_U-NII-2C_low channel 5530MHz

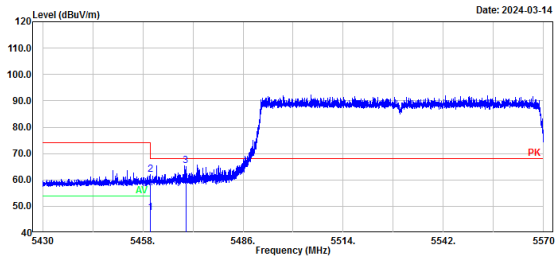

No.	Frequency (MHz)	Reading (dBμV)	Factor (dB/m)	Result (dBμV/m)	Limit (dBμV/m)	Margin (dB)	Detector
1	5460.00	18.21	29.34	47.55	54.00	6.45	Average
2	5460.00	32.58	29.34	61.92	74.00	12.08	Peak
3	5470.00	35.97	29.36	65.33	68.20	2.87	Peak

802.11 ax 80 mode, Low Channel, Bandedge, Vertical

Project No.: XMDN240206-08079E-RF Serial No.: 2HP4-4
 Polarization: Vertical Tester: Colin Yang
 Test Mode: Transmitting
 Note: 802.11ax80_U-NII-2C_low channel 5530MHz

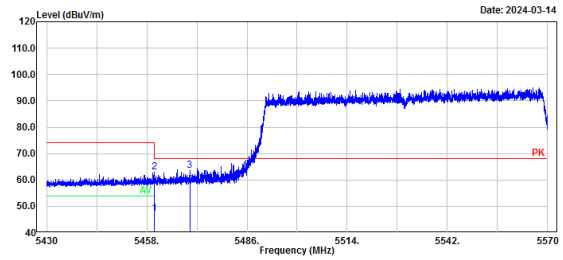

No.	Frequency (MHz)	Reading (dBμV)	Factor (dB/m)	Result (dBμV/m)	Limit (dBμV/m)	Margin (dB)	Detector
1	5460.00	18.05	29.34	47.39	54.00	6.61	Average
2	5460.00	33.47	29.34	62.81	74.00	11.19	Peak
3	5470.00	34.06	29.36	63.42	68.20	4.78	Peak

802.11 ax 80 mode, High Channel, Horizontal

Project No.: XMDN240206-08079E-RF Serial No.: ZHP4-4
 Polarization: Horizontal Tester: Colin Yang
 Test Mode: Transmitting
 Note: 802.11ax80_U-NII-2C_high channel 5610MHz

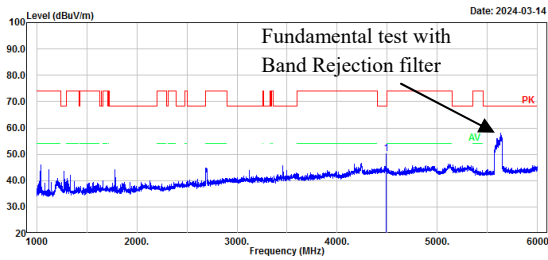

No.	Frequency (MHz)	Reading (dBuV)	Factor (dB/m)	Result (dBuV/m)	Limit (dBuV/m)	Margin (dB)	Detector
1	4488.00	53.40	-3.21	50.19	68.20	18.01	Peak

802.11 ax 80 mode, High Channel, Vertical

Project No.: XMDN240206-08079E-RF Serial No.: ZHP4-4
 Polarization: Vertical Tester: Colin Yang
 Test Mode: Transmitting
 Note: 802.11ax80_U-NII-2C_high channel 5610MHz

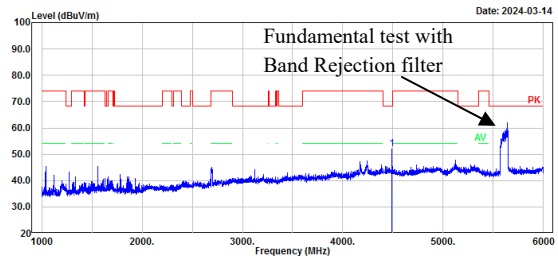

No.	Frequency (MHz)	Reading (dBuV)	Factor (dB/m)	Result (dBuV/m)	Limit (dBuV/m)	Margin (dB)	Detector
1	4488.00	55.23	-3.21	52.02	68.20	16.18	Peak

Project No.: XMDN240206-08079E-RF Serial No.: ZHP4-4
 Polarization: Horizontal Tester: Colin Yang
 Test Mode: Transmitting
 Note: 802.11ax80_U-NII-2C_high channel 5610MHz

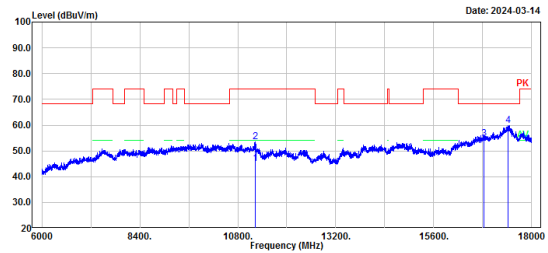

No.	Frequency (MHz)	Reading (dBuV)	Factor (dB/m)	Result (dBuV/m)	Limit (dBuV/m)	Margin (dB)	Detector
1	11220.00	39.25	5.67	44.92	54.00	9.08	Average
2	11220.00	47.98	5.67	53.65	74.00	20.35	Peak
3	16830.00	43.64	11.07	54.71	68.20	13.49	Peak
4	17421.60	44.70	15.25	59.95	68.20	8.25	Peak

Project No.: XMDN240206-08079E-RF Serial No.: ZHP4-4
 Polarization: Vertical Tester: Colin Yang
 Test Mode: Transmitting
 Note: 802.11ax80_U-NII-2C_high channel 5610MHz

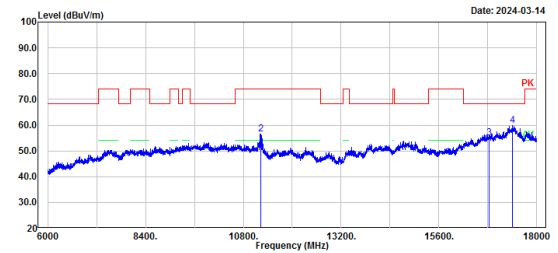

No.	Frequency (MHz)	Reading (dBuV)	Factor (dB/m)	Result (dBuV/m)	Limit (dBuV/m)	Margin (dB)	Detector
1	11220.00	43.51	5.67	49.18	54.00	4.82	Average
2	11220.00	51.01	5.67	56.68	74.00	17.32	Peak
3	16830.00	43.86	11.07	54.93	68.20	13.27	Peak
4	17404.80	44.81	15.11	59.92	68.20	8.28	Peak

802.11ax 80 mode, High Channel, Bandedge, Horizontal

Project No.: XMDN240206-08079E-RF Serial No.: 2HP4-4
 Polarization: Horizontal Tester: Colin Yang
 Test Mode: Transmitting
 Note: 802.11ax80_U-NII-2C_high channel 5610MHz

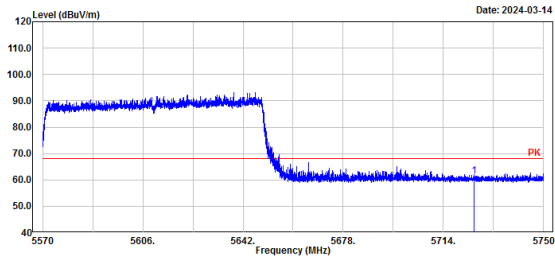

No.	Frequency (MHz)	Reading (dBμV)	Factor (dB/m)	Result (dBμV/m)	Limit (dBμV/m)	Margin (dB)	Detector
1	5725.00	31.75	29.81	61.56	68.20	6.64	Peak

802.11 ax 80 mode, High Channel, Bandedge, Vertical

Project No.: XMDN240206-08079E-RF Serial No.: 2HP4-4
 Polarization: Vertical Tester: Colin Yang
 Test Mode: Transmitting
 Note: 802.11ax80_U-NII-2C_high channel 5610MHz

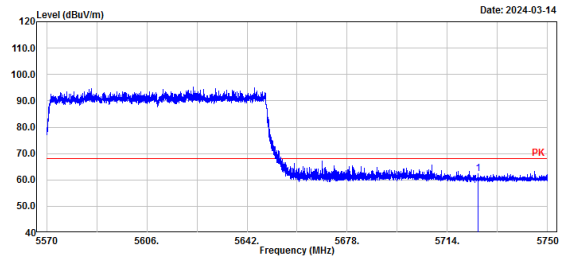

No.	Frequency (MHz)	Reading (dBμV)	Factor (dB/m)	Result (dBμV/m)	Limit (dBμV/m)	Margin (dB)	Detector
1	5725.00	32.58	29.81	62.39	68.20	5.81	Peak

802.11 ax 80 mode, Cross Channel, Horizontal

Project No.: XMDN240206-08079E-RF
 Polarization: Horizontal
 Test Mode: Transmitting
 Note: 802.11ax80_U-NII-2C_high channel 5690MHz

Serial No.: 2HP4-4
 Tester: Colin Yang

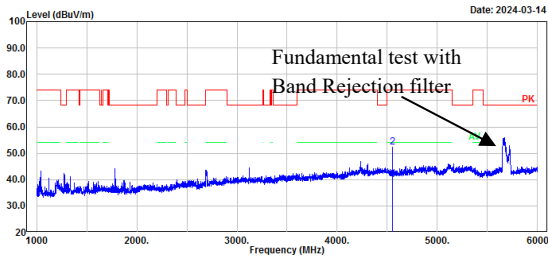

No.	Frequency (MHz)	Reading (dBuV)	Factor (dB/m)	Result (dBuV/m)	Limit (dBuV/m)	Margin (dB)	Detector
1	4552.00	43.32	-3.40	39.92	54.00	14.08	Average
2	4552.00	55.84	-3.40	52.44	74.00	21.56	Peak

802.11 ax 80 mode, Cross Channel, Vertical

Project No.: XMDN240206-08079E-RF
 Polarization: Vertical
 Test Mode: Transmitting
 Note: 802.11ax80_U-NII-2C_high channel 5690MHz

Serial No.: 2HP4-4
 Tester: Colin Yang

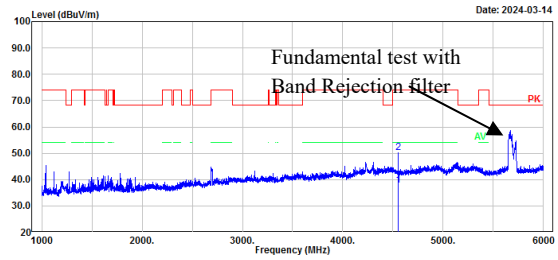

No.	Frequency (MHz)	Reading (dBuV)	Factor (dB/m)	Result (dBuV/m)	Limit (dBuV/m)	Margin (dB)	Detector
1	4552.00	41.25	-3.40	37.85	54.00	16.15	Average
2	4552.00	53.60	-3.40	50.20	74.00	23.80	Peak

Project No.: XMDN240206-08079E-RF
 Polarization: Horizontal
 Test Mode: Transmitting
 Note: 802.11ax80_U-NII-2C_high channel 5690MHz

Serial No.: 2HP4-4
 Tester: Colin Yang

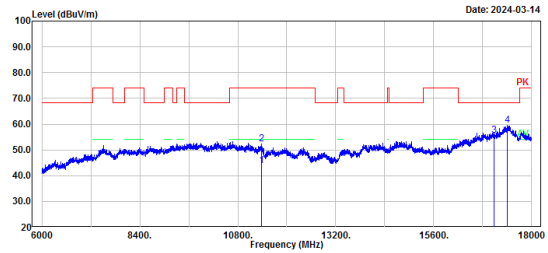

No.	Frequency (MHz)	Reading (dBuV)	Factor (dB/m)	Result (dBuV/m)	Limit (dBuV/m)	Margin (dB)	Detector
1	11380.00	39.24	4.50	43.74	54.00	10.26	Average
2	11380.00	47.68	4.50	52.18	74.00	21.82	Peak
3	17070.00	43.12	12.53	55.65	68.20	12.55	Peak
4	17402.40	44.43	15.10	59.53	68.20	8.67	Peak

Project No.: XMDN240206-08079E-RF
 Polarization: Vertical
 Test Mode: Transmitting
 Note: 802.11ax80_U-NII-2C_high channel 5690MHz

Serial No.: 2HP4-4
 Tester: Colin Yang

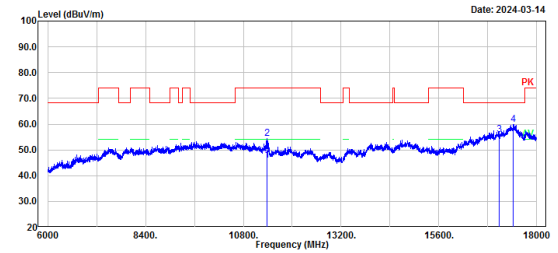

No.	Frequency (MHz)	Reading (dBuV)	Factor (dB/m)	Result (dBuV/m)	Limit (dBuV/m)	Margin (dB)	Detector
1	11380.00	41.32	4.50	45.82	54.00	8.18	Average
2	11380.00	49.87	4.50	54.37	74.00	19.63	Peak
3	17070.00	43.25	12.53	55.78	68.20	12.42	Peak
4	17414.40	44.54	15.19	59.73	68.20	8.47	Peak

5725-5850MHz:

802.11a mode, Low Channel, Horizontal		802.11a mode, Low Channel, Vertical																																																																	
<p>Project No.: XMDN240206-08079E-RF Serial No.: 2HP4-4 Polarization: Horizontal Tester: Bill Yang Test Mode: Transmitting Note: 802.11a_U-NII-3_low channel 5745MHz</p> <p>Fundamental test with Band Rejection filter</p>		<p>Project No.: XMDN240206-08079E-RF Serial No.: 2HP4-4 Polarization: Vertical Tester: Bill Yang Test Mode: Transmitting Note: 802.11a_U-NII-3_low channel 5745MHz</p> <p>Fundamental test with Band Rejection filter</p>																																																																	
<table border="1"> <thead> <tr> <th>No.</th> <th>Frequency (MHz)</th> <th>Reading (dBuV)</th> <th>Factor (dB/m)</th> <th>Result (dBuV/m)</th> <th>Limit (dBuV/m)</th> <th>Margin (dB)</th> <th>Detector</th> </tr> </thead> <tbody> <tr> <td>1</td> <td>4596.00</td> <td>45.92</td> <td>-3.59</td> <td>42.33</td> <td>54.00</td> <td>11.67</td> <td>Average</td> </tr> <tr> <td>2</td> <td>4596.00</td> <td>55.71</td> <td>-3.59</td> <td>52.12</td> <td>74.00</td> <td>21.88</td> <td>Peak</td> </tr> </tbody> </table>		No.	Frequency (MHz)	Reading (dBuV)	Factor (dB/m)	Result (dBuV/m)	Limit (dBuV/m)	Margin (dB)	Detector	1	4596.00	45.92	-3.59	42.33	54.00	11.67	Average	2	4596.00	55.71	-3.59	52.12	74.00	21.88	Peak	<table border="1"> <thead> <tr> <th>No.</th> <th>Frequency (MHz)</th> <th>Reading (dBuV)</th> <th>Factor (dB/m)</th> <th>Result (dBuV/m)</th> <th>Limit (dBuV/m)</th> <th>Margin (dB)</th> <th>Detector</th> </tr> </thead> <tbody> <tr> <td>1</td> <td>4596.00</td> <td>46.37</td> <td>-3.59</td> <td>42.78</td> <td>54.00</td> <td>11.22</td> <td>Average</td> </tr> <tr> <td>2</td> <td>4596.00</td> <td>55.88</td> <td>-3.59</td> <td>52.29</td> <td>74.00</td> <td>21.71</td> <td>Peak</td> </tr> </tbody> </table>		No.	Frequency (MHz)	Reading (dBuV)	Factor (dB/m)	Result (dBuV/m)	Limit (dBuV/m)	Margin (dB)	Detector	1	4596.00	46.37	-3.59	42.78	54.00	11.22	Average	2	4596.00	55.88	-3.59	52.29	74.00	21.71	Peak																
No.	Frequency (MHz)	Reading (dBuV)	Factor (dB/m)	Result (dBuV/m)	Limit (dBuV/m)	Margin (dB)	Detector																																																												
1	4596.00	45.92	-3.59	42.33	54.00	11.67	Average																																																												
2	4596.00	55.71	-3.59	52.12	74.00	21.88	Peak																																																												
No.	Frequency (MHz)	Reading (dBuV)	Factor (dB/m)	Result (dBuV/m)	Limit (dBuV/m)	Margin (dB)	Detector																																																												
1	4596.00	46.37	-3.59	42.78	54.00	11.22	Average																																																												
2	4596.00	55.88	-3.59	52.29	74.00	21.71	Peak																																																												
<p>Project No.: XMDN240206-08079E-RF Serial No.: 2HP4-4 Polarization: Horizontal Tester: Bill Yang Test Mode: Transmitting Note: 802.11a_U-NII-3_low channel 5745MHz</p>		<p>Project No.: XMDN240206-08079E-RF Serial No.: 2HP4-4 Polarization: Vertical Tester: Bill Yang Test Mode: Transmitting Note: 802.11a_U-NII-3_low channel 5745MHz</p>																																																																	
<table border="1"> <thead> <tr> <th>No.</th> <th>Frequency (MHz)</th> <th>Reading (dBuV)</th> <th>Factor (dB/m)</th> <th>Result (dBuV/m)</th> <th>Limit (dBuV/m)</th> <th>Margin (dB)</th> <th>Detector</th> </tr> </thead> <tbody> <tr> <td>1</td> <td>11490.00</td> <td>42.33</td> <td>4.23</td> <td>46.56</td> <td>54.00</td> <td>7.44</td> <td>Average</td> </tr> <tr> <td>2</td> <td>11490.00</td> <td>52.68</td> <td>4.23</td> <td>56.91</td> <td>74.00</td> <td>17.09</td> <td>Peak</td> </tr> <tr> <td>3</td> <td>17235.00</td> <td>41.31</td> <td>13.75</td> <td>55.06</td> <td>68.20</td> <td>13.14</td> <td>Peak</td> </tr> </tbody> </table>		No.	Frequency (MHz)	Reading (dBuV)	Factor (dB/m)	Result (dBuV/m)	Limit (dBuV/m)	Margin (dB)	Detector	1	11490.00	42.33	4.23	46.56	54.00	7.44	Average	2	11490.00	52.68	4.23	56.91	74.00	17.09	Peak	3	17235.00	41.31	13.75	55.06	68.20	13.14	Peak	<table border="1"> <thead> <tr> <th>No.</th> <th>Frequency (MHz)</th> <th>Reading (dBuV)</th> <th>Factor (dB/m)</th> <th>Result (dBuV/m)</th> <th>Limit (dBuV/m)</th> <th>Margin (dB)</th> <th>Detector</th> </tr> </thead> <tbody> <tr> <td>1</td> <td>11490.00</td> <td>45.65</td> <td>4.23</td> <td>49.88</td> <td>54.00</td> <td>4.12</td> <td>Average</td> </tr> <tr> <td>2</td> <td>11490.00</td> <td>55.30</td> <td>4.23</td> <td>59.53</td> <td>74.00</td> <td>14.47</td> <td>Peak</td> </tr> <tr> <td>3</td> <td>17235.00</td> <td>42.53</td> <td>13.75</td> <td>56.28</td> <td>68.20</td> <td>11.92</td> <td>Peak</td> </tr> </tbody> </table>		No.	Frequency (MHz)	Reading (dBuV)	Factor (dB/m)	Result (dBuV/m)	Limit (dBuV/m)	Margin (dB)	Detector	1	11490.00	45.65	4.23	49.88	54.00	4.12	Average	2	11490.00	55.30	4.23	59.53	74.00	14.47	Peak	3	17235.00	42.53	13.75	56.28	68.20	11.92	Peak
No.	Frequency (MHz)	Reading (dBuV)	Factor (dB/m)	Result (dBuV/m)	Limit (dBuV/m)	Margin (dB)	Detector																																																												
1	11490.00	42.33	4.23	46.56	54.00	7.44	Average																																																												
2	11490.00	52.68	4.23	56.91	74.00	17.09	Peak																																																												
3	17235.00	41.31	13.75	55.06	68.20	13.14	Peak																																																												
No.	Frequency (MHz)	Reading (dBuV)	Factor (dB/m)	Result (dBuV/m)	Limit (dBuV/m)	Margin (dB)	Detector																																																												
1	11490.00	45.65	4.23	49.88	54.00	4.12	Average																																																												
2	11490.00	55.30	4.23	59.53	74.00	14.47	Peak																																																												
3	17235.00	42.53	13.75	56.28	68.20	11.92	Peak																																																												

802.11a mode, Low Channel, Bandedge, Horizontal

Project No.: XMDN240206-08079E-RF Serial No.: 2HP4-4
 Polarization: Horizontal Tester: Bill Yang
 Test Mode: Transmitting
 Note: 802.11a_U-NII-3_low channel 5745MHz

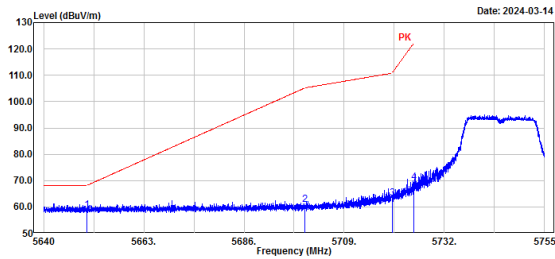

No.	Frequency (MHz)	Reading (dBμV)	Factor (dB/m)	Result (dBμV/m)	Limit (dBμV/m)	Margin (dB)	Detector
1	5650.00	29.13	29.70	58.83	68.20	9.37	Peak
2	5700.00	31.09	29.77	60.86	105.20	44.34	Peak
3	5720.00	33.46	29.80	63.26	110.80	47.54	Peak
4	5725.00	39.39	29.81	69.20	122.20	53.00	Peak

802.11a mode, Low Channel, Bandedge, Vertical

Project No.: XMDN240206-08079E-RF Serial No.: 2HP4-4
 Polarization: Vertical Tester: Bill Yang
 Test Mode: Transmitting
 Note: 802.11a_U-NII-3_low channel 5745MHz

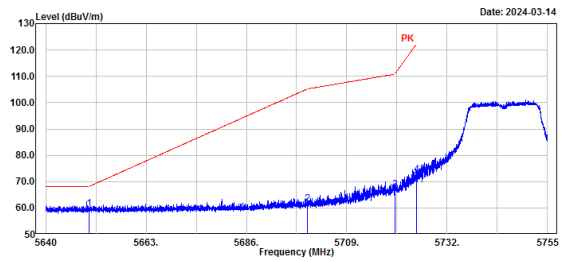

No.	Frequency (MHz)	Reading (dBμV)	Factor (dB/m)	Result (dBμV/m)	Limit (dBμV/m)	Margin (dB)	Detector
1	5650.01	29.90	29.70	59.60	68.20	8.60	Peak
2	5700.00	31.67	29.77	61.44	105.20	43.76	Peak
3	5720.00	37.02	29.80	66.82	110.80	43.98	Peak
4	5725.00	42.83	29.81	72.64	122.20	49.56	Peak

802.11a mode, Middle Channel, Horizontal

Project No.: XMDN240206-08079E-RF Serial No.: 2HP4-4
 Polarization: Horizontal Tester: Bill Yang
 Test Mode: Transmitting
 Note: 802.11a_U-NII-3_middle channel 5785MHz

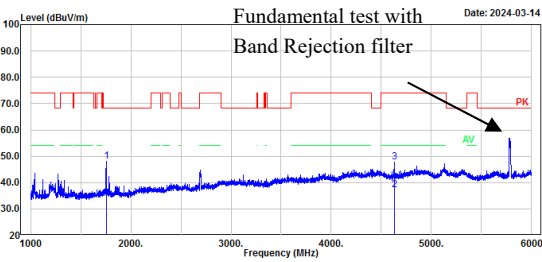

No.	Frequency (MHz)	Reading (dBuV)	Factor (dB/m)	Result (dBuV/m)	Limit (dBuV/m)	Margin (dB)	Detector
1	1756.00	57.69	-9.69	48.00	68.20	20.20	Peak
2	4628.00	40.62	-3.48	37.14	54.00	16.86	Average
3	4628.00	51.15	-3.48	47.67	74.00	26.33	Peak

802.11a mode, Middle Channel, Vertical

Project No.: XMDN240206-08079E-RF Serial No.: 2HP4-4
 Polarization: Vertical Tester: Bill Yang
 Test Mode: Transmitting
 Note: 802.11a_U-NII-3_middle channel 5785MHz

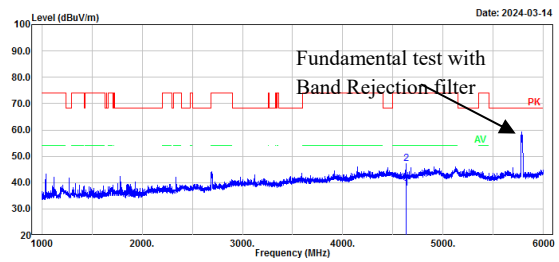

No.	Frequency (MHz)	Reading (dBuV)	Factor (dB/m)	Result (dBuV/m)	Limit (dBuV/m)	Margin (dB)	Detector
1	4628.00	41.43	-3.48	37.95	54.00	16.05	Average
2	4628.00	50.53	-3.48	47.05	74.00	26.95	Peak

Project No.: XMDN240206-08079E-RF Serial No.: 2HP4-4
 Polarization: Horizontal Tester: Bill Yang
 Test Mode: Transmitting
 Note: 802.11a_U-NII-3_middle channel 5785MHz

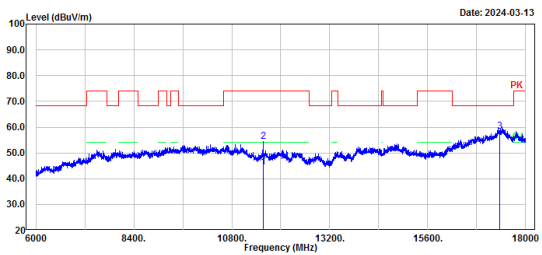

No.	Frequency (MHz)	Reading (dBuV)	Factor (dB/m)	Result (dBuV/m)	Limit (dBuV/m)	Margin (dB)	Detector
1	11570.00	40.09	4.44	44.53	54.00	9.47	Average
2	11570.00	50.02	4.44	54.46	74.00	19.54	Peak
3	17355.00	43.62	14.70	58.32	68.20	9.88	Peak

Project No.: XMDN240206-08079E-RF Serial No.: 2HP4-4
 Polarization: Vertical Tester: Bill Yang
 Test Mode: Transmitting
 Note: 802.11a_U-NII-3_middle channel 5785MHz

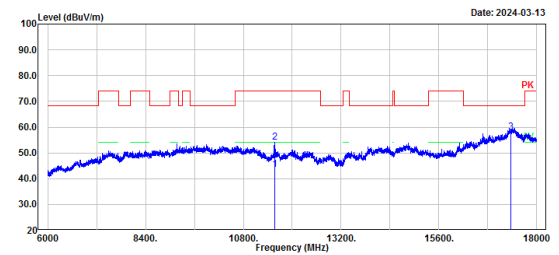

No.	Frequency (MHz)	Reading (dBuV)	Factor (dB/m)	Result (dBuV/m)	Limit (dBuV/m)	Margin (dB)	Detector
1	11570.00	39.24	4.44	43.68	54.00	10.32	Average
2	11570.00	49.73	4.44	54.17	74.00	19.83	Peak
3	17355.00	43.37	14.70	58.07	68.20	10.13	Peak

802.11a mode, High Channel, Horizontal

Project No.: XMDN240206-08079E-RF
 Polarization: Horizontal
 Test Mode: Transmitting
 Note: 802.11a_U-NII-3_high channel 5825MHz

Serial No.: 2HP4-4
 Tester: Bill Yang

Date: 2024-03-14

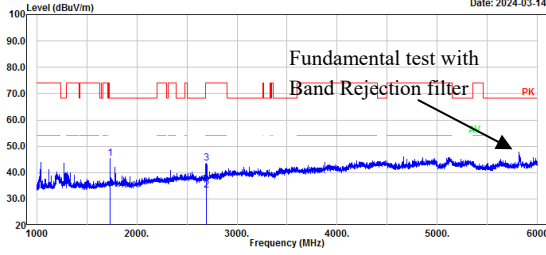

No.	Frequency (MHz)	Reading (dBuV)	Factor (dB/m)	Result (dBuV/m)	Limit (dBuV/m)	Margin (dB)	Detector
1	1736.00	54.93	-9.70	45.23	68.20	22.97	Peak
2	2695.00	40.21	-7.01	33.20	54.00	20.80	Average
3	2695.00	50.60	-7.01	43.59	74.00	30.41	Peak

802.11a mode, High Channel, Vertical

Project No.: XMDN240206-08079E-RF
 Polarization: Vertical
 Test Mode: Transmitting
 Note: 802.11a_U-NII-3_high channel 5825MHz

Serial No.: 2HP4-4
 Tester: Bill Yang

Date: 2024-03-14

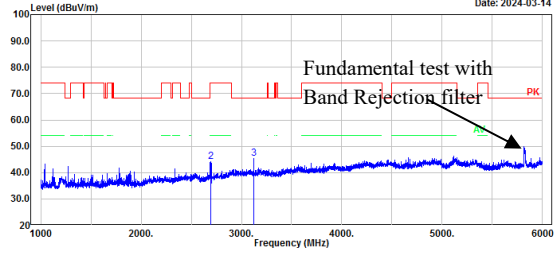

No.	Frequency (MHz)	Reading (dBuV)	Factor (dB/m)	Result (dBuV/m)	Limit (dBuV/m)	Margin (dB)	Detector
1	2695.00	41.75	-7.01	34.74	54.00	19.26	Average
2	2695.00	51.04	-7.01	44.03	74.00	29.97	Peak
3	3120.00	51.50	-6.12	45.38	68.20	22.82	Peak

Project No.: XMDN240206-08079E-RF
 Polarization: Horizontal
 Test Mode: Transmitting
 Note: 802.11a_U-NII-3_high channel 5825MHz

Serial No.: 2HP4-4
 Tester: Bill Yang

Date: 2024-03-13

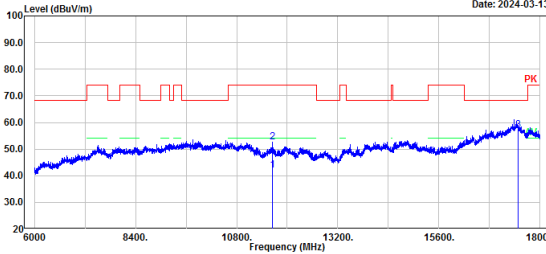

No.	Frequency (MHz)	Reading (dBuV)	Factor (dB/m)	Result (dBuV/m)	Limit (dBuV/m)	Margin (dB)	Detector
1	11650.00	37.66	4.52	42.18	54.00	11.82	Average
2	11650.00	47.96	4.52	52.48	74.00	21.52	Peak
3	17475.00	41.59	15.67	57.26	68.20	10.94	Peak

Project No.: XMDN240206-08079E-RF
 Polarization: Vertical
 Test Mode: Transmitting
 Note: 802.11a_U-NII-3_high channel 5825MHz

Serial No.: 2HP4-4
 Tester: Bill Yang

Date: 2024-03-13

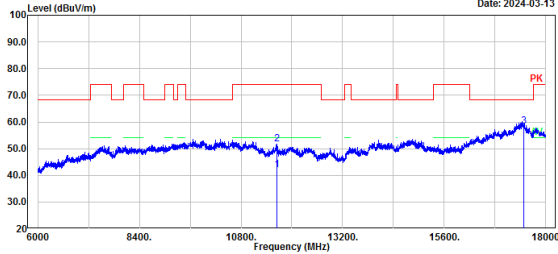

No.	Frequency (MHz)	Reading (dBuV)	Factor (dB/m)	Result (dBuV/m)	Limit (dBuV/m)	Margin (dB)	Detector
1	11650.00	37.44	4.52	41.96	54.00	12.04	Average
2	11650.00	47.21	4.52	51.73	74.00	22.27	Peak
3	17475.00	42.56	15.67	58.23	68.20	9.97	Peak

802.11a mode, High Channel, Bandedge, Horizontal

Project No.: XMDN240206-08079E-RF Serial No.: 2HP4-4
 Polarization: Horizontal Tester: Bill Yang
 Test Mode: Transmitting
 Note: 802.11a_U-NII-3_high channel 5825MHz

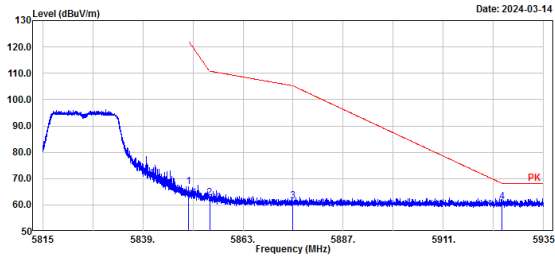

No.	Frequency (MHz)	Reading (dBuV)	Factor (dB/m)	Result (dBuV/m)	Limit (dBuV/m)	Margin (dB)	Detector
1	5850.00	37.02	29.99	67.01	122.20	55.19	Peak
2	5855.00	32.69	30.00	62.69	110.80	48.11	Peak
3	5875.00	31.52	30.03	61.55	105.20	43.65	Peak
4	5925.00	30.93	30.10	61.03	68.20	7.17	Peak

802.11a mode, High Channel, Bandedge, Vertical

Project No.: XMDN240206-08079E-RF Serial No.: 2HP4-4
 Polarization: Vertical Tester: Bill Yang
 Test Mode: Transmitting
 Note: 802.11a_U-NII-3_high channel 5825MHz

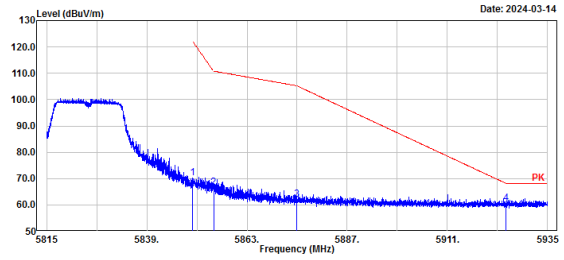

No.	Frequency (MHz)	Reading (dBuV)	Factor (dB/m)	Result (dBuV/m)	Limit (dBuV/m)	Margin (dB)	Detector
1	5850.00	40.27	29.99	70.26	122.20	51.94	Peak
2	5855.00	36.52	30.00	66.52	110.80	44.28	Peak
3	5875.00	32.19	30.03	62.22	105.20	42.98	Peak
4	5925.00	30.36	30.10	60.46	68.20	7.74	Peak

802.11n ht20 mode, Low Channel, Horizontal

Project No.: XMDN240206-08079E-RF
 Polarization: Horizontal
 Test Mode: Transmitting
 Note: 802.11n20_U-NII-3_low channel 5745MHz

Serial No.: 2HP4-4
 Tester: Bill Yang

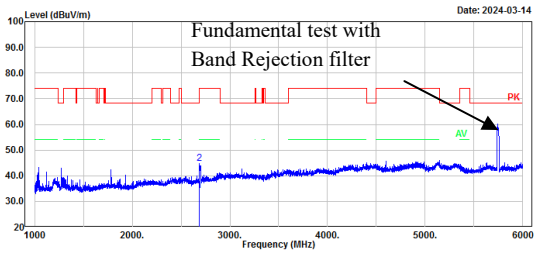

No.	Frequency (MHz)	Reading (dBuV)	Factor (dB/m)	Result (dBuV/m)	Limit (dBuV/m)	Margin (dB)	Detector
1	2690.00	41.14	-7.04	34.10	54.00	19.90	Average
2	2690.00	51.78	-7.04	44.74	68.20	23.46	Peak

802.11n ht20 mode, Low Channel, Vertical

Project No.: XMDN240206-08079E-RF
 Polarization: Vertical
 Test Mode: Transmitting
 Note: 802.11n20_U-NII-3_low channel 5745MHz

Serial No.: 2HP4-4
 Tester: Bill Yang

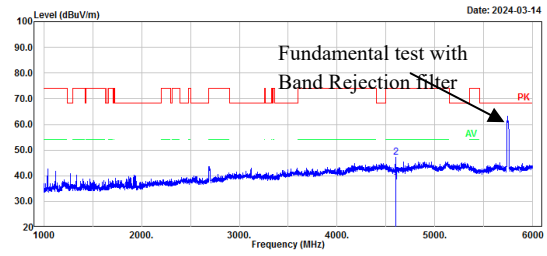

No.	Frequency (MHz)	Reading (dBuV)	Factor (dB/m)	Result (dBuV/m)	Limit (dBuV/m)	Margin (dB)	Detector
1	4596.00	41.00	-3.59	37.41	54.00	16.59	Average
2	4596.00	50.80	-3.59	47.21	74.00	26.79	Peak

Project No.: XMDN240206-08079E-RF
 Polarization: Horizontal
 Test Mode: Transmitting
 Note: 802.11n20_U-NII-3_low channel 5745MHz

Serial No.: 2HP4-4
 Tester: Bill Yang

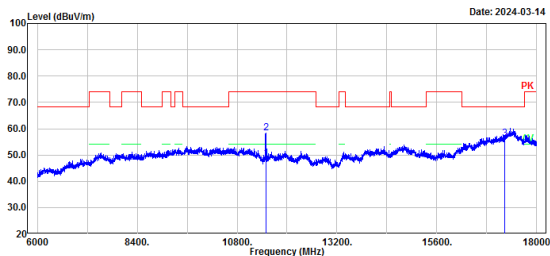

No.	Frequency (MHz)	Reading (dBuV)	Factor (dB/m)	Result (dBuV/m)	Limit (dBuV/m)	Margin (dB)	Detector
1	11490.00	44.32	4.23	48.55	54.00	5.45	Average
2	11490.00	54.24	4.23	58.47	74.00	15.53	Peak
3	17235.00	42.43	13.75	56.18	68.20	12.02	Peak

Project No.: XMDN240206-08079E-RF
 Polarization: Vertical
 Test Mode: Transmitting
 Note: 802.11n20_U-NII-3_low channel 5745MHz

Serial No.: 2HP4-4
 Tester: Bill Yang

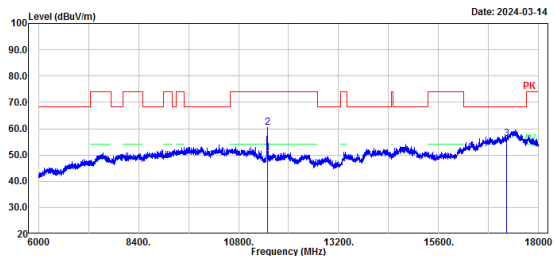

No.	Frequency (MHz)	Reading (dBuV)	Factor (dB/m)	Result (dBuV/m)	Limit (dBuV/m)	Margin (dB)	Detector
1	11490.00	46.52	4.23	50.75	54.00	3.25	Average
2	11490.00	56.10	4.23	60.33	74.00	13.67	Peak
3	17235.00	42.49	13.75	56.24	68.20	11.96	Peak

802.11n ht20 mode, Low Channel, Bandedge, Horizontal

Project No.: XMDN240206-08079E-RF Serial No.: 2HP4-4
 Polarization: Horizontal Tester: Bill Yang
 Test Mode: Transmitting
 Note: 802.11n20_U-NII-3_low channel 5745MHz

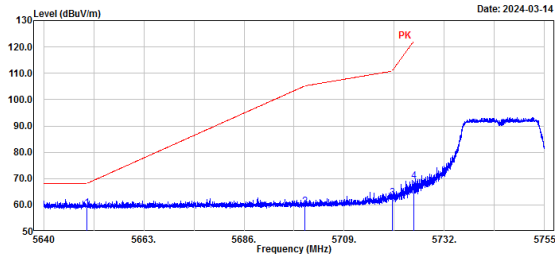

No.	Frequency (MHz)	Reading (dBμV)	Factor (dB/m)	Result (dBμV/m)	Limit (dBμV/m)	Margin (dB)	Detector
1	5650.00	29.19	29.70	58.89	68.20	9.31	Peak
2	5700.00	29.69	29.77	59.46	105.20	45.74	Peak
3	5720.00	32.88	29.80	62.68	110.80	48.12	Peak
4	5725.00	39.08	29.81	68.89	122.20	53.31	Peak

802.11n ht20 mode, Low Channel, Bandedge, Vertical

Project No.: XMDN240206-08079E-RF Serial No.: 2HP4-4
 Polarization: Vertical Tester: Bill Yang
 Test Mode: Transmitting
 Note: 802.11n20_U-NII-3_low channel 5745MHz

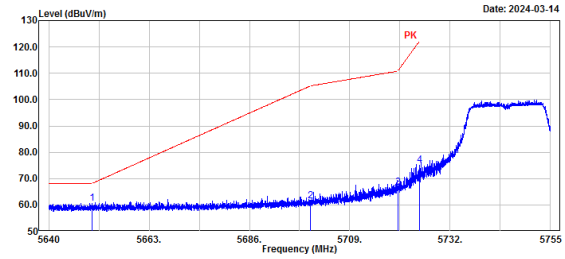

No.	Frequency (MHz)	Reading (dBμV)	Factor (dB/m)	Result (dBμV/m)	Limit (dBμV/m)	Margin (dB)	Detector
1	5650.00	30.85	29.70	60.55	68.20	7.65	Peak
2	5700.00	31.85	29.77	61.62	105.20	43.58	Peak
3	5720.00	36.83	29.80	66.63	110.80	44.17	Peak
4	5725.00	45.33	29.81	75.14	122.20	47.06	Peak

802.11n ht20 mode, Middle Channel, Horizontal

Project No.: XMDN240206-08079E-RF Serial No.: 2HP4-4
 Polarization: Horizontal Tester: Bill Yang
 Test Mode: Transmitting
 Note: 802.11n20_U-NII-3_middle channel 5785MHz

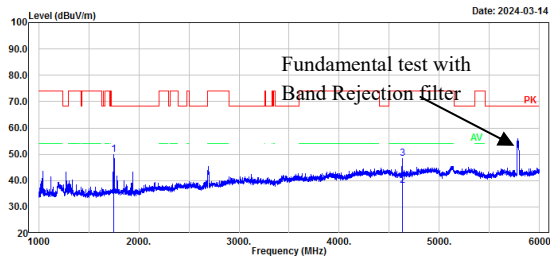

No.	Frequency (MHz)	Reading (dBuV)	Factor (dB/m)	Result (dBuV/m)	Limit (dBuV/m)	Margin (dB)	Detector
1	1746.00	59.55	-9.69	49.86	68.20	18.34	Peak
2	4628.00	41.68	-3.48	38.20	54.00	15.80	Average
3	4628.00	51.89	-3.48	48.41	74.00	25.59	Peak

802.11n ht20 mode, Middle Channel, Vertical

Project No.: XMDN240206-08079E-RF Serial No.: 2HP4-4
 Polarization: Vertical Tester: Bill Yang
 Test Mode: Transmitting
 Note: 802.11n20_U-NII-3_middle channel 5785MHz

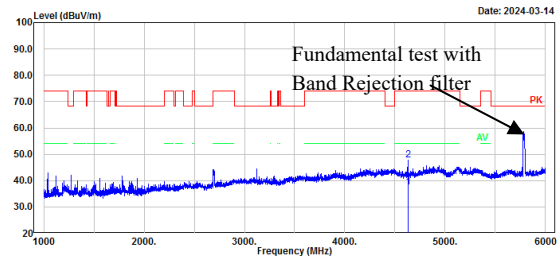

No.	Frequency (MHz)	Reading (dBuV)	Factor (dB/m)	Result (dBuV/m)	Limit (dBuV/m)	Margin (dB)	Detector
1	4628.00	41.03	-3.48	37.55	54.00	16.45	Average
2	4628.00	51.40	-3.48	47.92	74.00	26.08	Peak

Project No.: XMDN240206-08079E-RF Serial No.: 2HP4-4
 Polarization: Horizontal Tester: Bill Yang
 Test Mode: Transmitting
 Note: 802.11n20_U-NII-3_middle channel 5785MHz

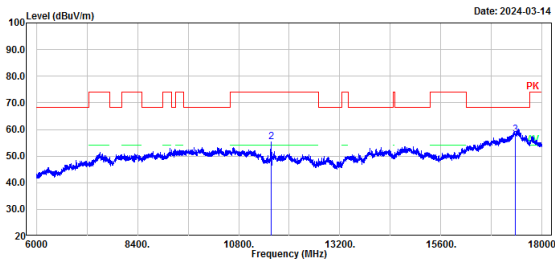

No.	Frequency (MHz)	Reading (dBuV)	Factor (dB/m)	Result (dBuV/m)	Limit (dBuV/m)	Margin (dB)	Detector
1	11570.00	40.96	4.44	45.40	54.00	8.60	Average
2	11570.00	50.96	4.44	55.40	74.00	18.60	Peak
3	17355.00	43.21	14.70	57.91	68.20	10.29	Peak

Project No.: XMDN240206-08079E-RF Serial No.: 2HP4-4
 Polarization: Vertical Tester: Bill Yang
 Test Mode: Transmitting
 Note: 802.11n20_U-NII-3_middle channel 5785MHz

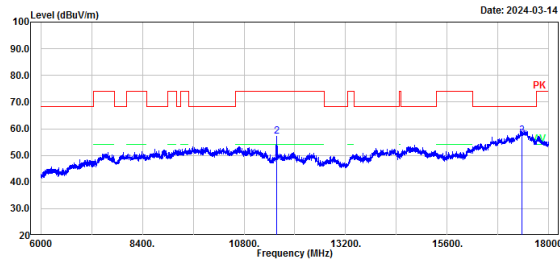

No.	Frequency (MHz)	Reading (dBuV)	Factor (dB/m)	Result (dBuV/m)	Limit (dBuV/m)	Margin (dB)	Detector
1	11570.00	42.78	4.44	47.22	54.00	6.78	Average
2	11570.00	52.82	4.44	57.26	74.00	16.74	Peak
3	17355.00	42.69	14.70	57.39	68.20	10.81	Peak

802.11n ht20 mode, High Channel, Horizontal

Project No.: XMDN240206-08079E-RF Serial No.: 2HP4-4
 Polarization: Horizontal Tester: Bill Yang
 Test Mode: Transmitting
 Note: 802.11n20_U-NII-3_high channel 5825MHz

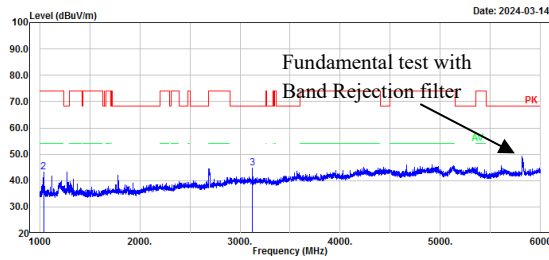

No.	Frequency (MHz)	Reading (dBuV)	Factor (dB/m)	Result (dBuV/m)	Limit (dBuV/m)	Margin (dB)	Detector
1	1039.00	44.14	-10.91	33.23	54.00	20.77	Average
2	1039.00	54.10	-10.91	43.19	74.00	30.81	Peak
3	3120.00	50.79	-6.12	44.67	68.20	23.53	Peak

802.11n ht20 mode, High Channel, Vertical

Project No.: XMDN240206-08079E-RF Serial No.: 2HP4-4
 Polarization: Vertical Tester: Bill Yang
 Test Mode: Transmitting
 Note: 802.11n20_U-NII-3_high channel 5825MHz

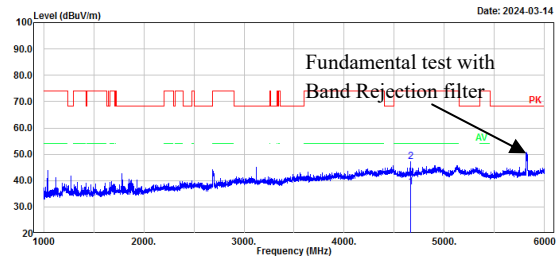

No.	Frequency (MHz)	Reading (dBuV)	Factor (dB/m)	Result (dBuV/m)	Limit (dBuV/m)	Margin (dB)	Detector
1	4661.00	40.88	-3.33	37.55	54.00	16.45	Average
2	4661.00	50.64	-3.33	47.31	74.00	26.69	Peak

Project No.: XMDN240206-08079E-RF Serial No.: 2HP4-4
 Polarization: Horizontal Tester: Bill Yang
 Test Mode: Transmitting
 Note: 802.11n20_U-NII-3_high channel 5825MHz

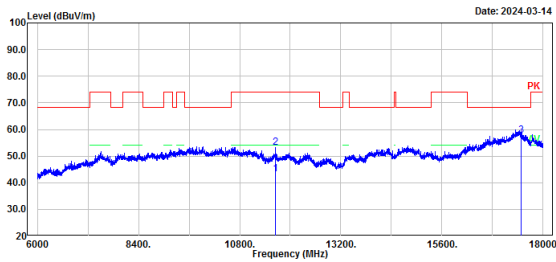

No.	Frequency (MHz)	Reading (dBuV)	Factor (dB/m)	Result (dBuV/m)	Limit (dBuV/m)	Margin (dB)	Detector
1	11650.00	38.78	4.52	43.30	54.00	10.70	Average
2	11650.00	48.83	4.52	53.35	74.00	20.65	Peak
3	17475.00	42.21	15.67	57.88	68.20	10.32	Peak

Project No.: XMDN240206-08079E-RF Serial No.: 2HP4-4
 Polarization: Vertical Tester: Bill Yang
 Test Mode: Transmitting
 Note: 802.11n20_U-NII-3_high channel 5825MHz

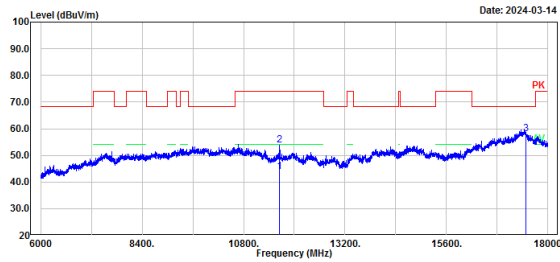

No.	Frequency (MHz)	Reading (dBuV)	Factor (dB/m)	Result (dBuV/m)	Limit (dBuV/m)	Margin (dB)	Detector
1	11650.00	39.36	4.52	43.88	54.00	10.12	Average
2	11650.00	49.30	4.52	53.82	74.00	20.18	Peak
3	17475.00	42.52	15.67	58.19	68.20	10.01	Peak

802.11n ht20 mode, High Channel, Bandedge, Horizontal

Project No.: XMDN240206-08079E-RF Serial No.: 2HP4-4
 Polarization: Horizontal Tester: Bill Yang
 Test Mode: Transmitting
 Note: 802.11n20_U-NII-3_high channel 5825MHz

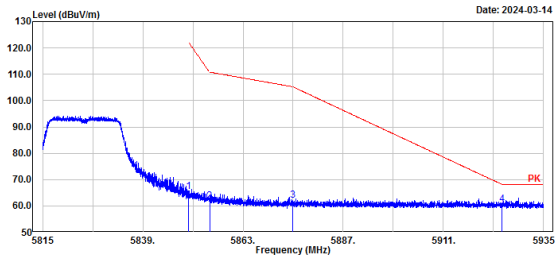

No.	Frequency (MHz)	Reading (dBμV)	Factor (dB/m)	Result (dBμV/m)	Limit (dBμV/m)	Margin (dB)	Detector
1	5850.00	35.46	29.99	65.45	122.20	56.75	Peak
2	5855.00	31.72	30.00	61.72	110.80	49.08	Peak
3	5875.00	31.97	30.03	62.00	105.20	43.20	Peak
4	5925.00	30.41	30.10	60.51	68.20	7.69	Peak

802.11n ht20 mode, High Channel, Bandedge, Vertical

Project No.: XMDN240206-08079E-RF Serial No.: 2HP4-4
 Polarization: Vertical Tester: Bill Yang
 Test Mode: Transmitting
 Note: 802.11n20_U-NII-3_high channel 5825MHz

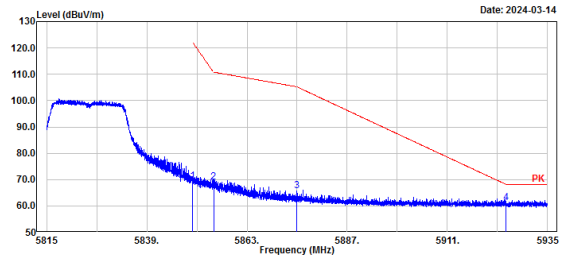

No.	Frequency (MHz)	Reading (dBμV)	Factor (dB/m)	Result (dBμV/m)	Limit (dBμV/m)	Margin (dB)	Detector
1	5850.00	39.45	29.99	69.44	122.20	52.76	Peak
2	5855.00	39.11	30.00	69.11	110.80	41.69	Peak
3	5875.00	35.69	30.03	65.72	105.20	39.48	Peak
4	5925.00	31.01	30.10	61.11	68.20	7.09	Peak

802.11n ht40 mode, Low Channel, Horizontal

Project No.: XMDN240206-08079E-RF
 Polarization: Horizontal
 Test Mode: Transmitting
 Note: 802.11n40_U-NII-3_low channel 5755MHz

Serial No.: 2HP4-4
 Tester: Bill Yang

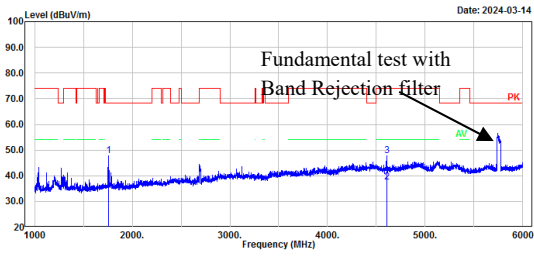

No.	Frequency (MHz)	Reading (dBuV)	Factor (dB/m)	Result (dBuV/m)	Limit (dBuV/m)	Margin (dB)	Detector
1	1761.00	57.59	-9.70	47.89	68.20	20.31	Peak
2	4604.00	41.06	-3.60	37.46	54.00	16.54	Average
3	4604.00	51.38	-3.60	47.78	74.00	26.22	Peak

802.11n ht40 mode, Low Channel, Vertical

Project No.: XMDN240206-08079E-RF
 Polarization: Vertical
 Test Mode: Transmitting
 Note: 802.11n40_U-NII-3_low channel 5755MHz

Serial No.: 2HP4-4
 Tester: Bill Yang

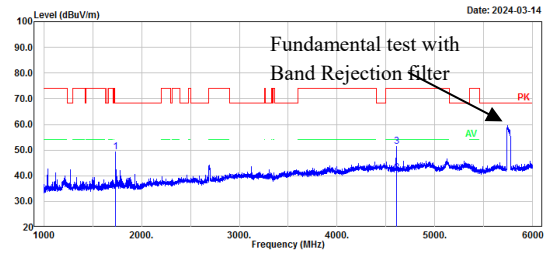

No.	Frequency (MHz)	Reading (dBuV)	Factor (dB/m)	Result (dBuV/m)	Limit (dBuV/m)	Margin (dB)	Detector
1	1736.00	59.13	-9.70	49.43	68.20	18.77	Peak
2	4604.00	44.81	-3.60	41.21	54.00	12.79	Average
3	4604.00	55.05	-3.60	51.45	74.00	22.55	Peak

Project No.: XMDN240206-08079E-RF
 Polarization: Horizontal
 Test Mode: Transmitting
 Note: 802.11n40_U-NII-3_low channel 5755MHz

Serial No.: 2HP4-4
 Tester: Bill Yang

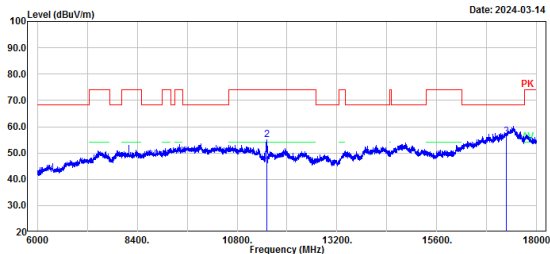

No.	Frequency (MHz)	Reading (dBuV)	Factor (dB/m)	Result (dBuV/m)	Limit (dBuV/m)	Margin (dB)	Detector
1	11510.00	40.69	4.25	44.94	54.00	9.06	Average
2	11510.00	50.90	4.25	55.15	74.00	18.85	Peak
3	17265.00	42.13	13.97	56.10	68.20	12.10	Peak

Project No.: XMDN240206-08079E-RF
 Polarization: Vertical
 Test Mode: Transmitting
 Note: 802.11n40_U-NII-3_low channel 5755MHz

Serial No.: 2HP4-4
 Tester: Bill Yang

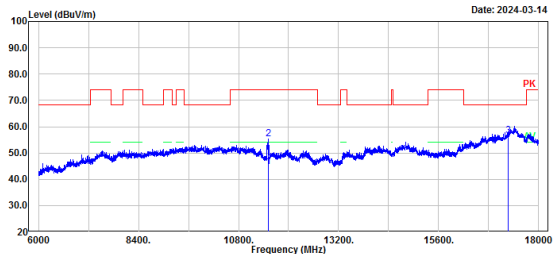

No.	Frequency (MHz)	Reading (dBuV)	Factor (dB/m)	Result (dBuV/m)	Limit (dBuV/m)	Margin (dB)	Detector
1	11510.00	40.55	4.25	44.80	54.00	9.20	Average
2	11510.00	50.94	4.25	55.19	74.00	18.81	Peak
3	17265.00	42.43	13.97	56.40	68.20	11.80	Peak

802.11n ht40 mode, Low Channel, Bandedge, Horizontal

Project No.: XMDN240206-08079E-RF Serial No.: 2HP4-4
 Polarization: Horizontal Tester: Bill Yang
 Test Mode: Transmitting
 Note: 802.11n40_U-NII-3_low channel 5755MHz

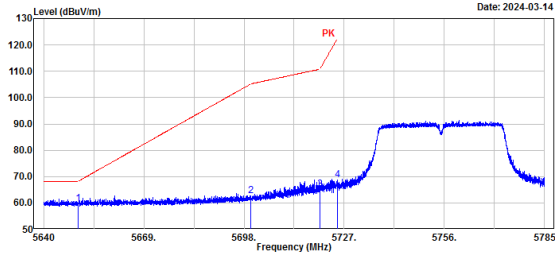

Date: 2024-03-14

No.	Frequency (MHz)	Reading (dBμV)	Factor (dB/m)	Result (dBμV/m)	Limit (dBμV/m)	Margin (dB)	Detector
1	5650.00	29.96	29.70	59.66	68.20	8.54	Peak
2	5700.00	33.03	29.77	62.80	105.20	42.40	Peak
3	5720.00	35.17	29.80	64.97	110.80	45.83	Peak
4	5725.00	38.87	29.81	68.68	122.20	53.52	Peak

802.11n ht40 mode, Low Channel, Bandedge, Vertical

Project No.: XMDN240206-08079E-RF Serial No.: 2HP4-4
 Polarization: Vertical Tester: Bill Yang
 Test Mode: Transmitting
 Note: 802.11n40_U-NII-3_low channel 5755MHz

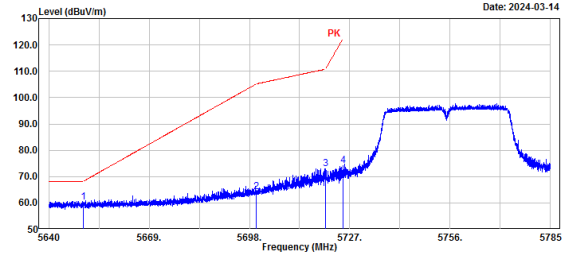

Date: 2024-03-14

No.	Frequency (MHz)	Reading (dBμV)	Factor (dB/m)	Result (dBμV/m)	Limit (dBμV/m)	Margin (dB)	Detector
1	5650.00	30.67	29.70	60.37	68.20	7.83	Peak
2	5700.00	34.50	29.77	64.27	105.20	40.93	Peak
3	5720.00	43.01	29.80	72.81	110.80	37.99	Peak
4	5725.00	44.37	29.81	74.18	122.20	48.02	Peak

802.11n ht40 mode, High Channel, Horizontal

Project No.: XMDN240206-08079E-RF Serial No.: 2HP4-4
 Polarization: Horizontal Tester: Bill Yang
 Test Mode: Transmitting
 Note: 802.11n40_U-NII-3_high channel 5795MHz

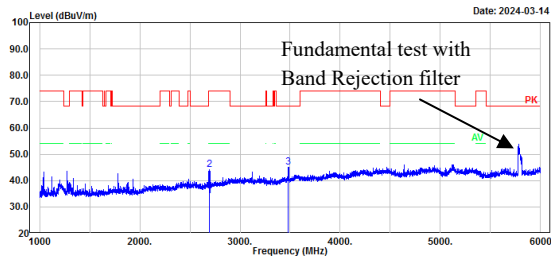

No.	Frequency (MHz)	Reading (dBuV)	Factor (dB/m)	Result (dBuV/m)	Limit (dBuV/m)	Margin (dB)	Detector
1	2691.00	41.12	-7.02	34.10	54.00	19.90	Average
2	2691.00	51.15	-7.02	44.13	74.00	29.87	Peak
3	3484.00	50.63	-5.68	44.95	68.20	23.25	Peak

802.11n ht40 mode, High Channel, Vertical

Project No.: XMDN240206-08079E-RF Serial No.: 2HP4-4
 Polarization: Vertical Tester: Bill Yang
 Test Mode: Transmitting
 Note: 802.11n40_U-NII-3_high channel 5795MHz

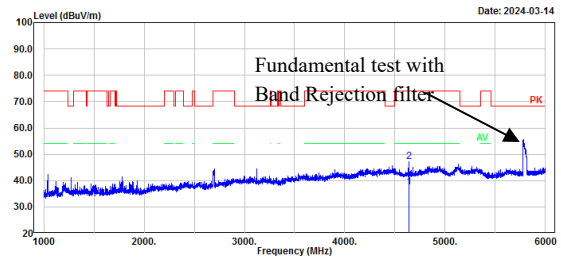

No.	Frequency (MHz)	Reading (dBuV)	Factor (dB/m)	Result (dBuV/m)	Limit (dBuV/m)	Margin (dB)	Detector
1	4636.00	40.90	-3.44	37.46	54.00	16.54	Average
2	4636.00	50.63	-3.44	47.19	74.00	26.81	Peak

Project No.: XMDN240206-08079E-RF Serial No.: 2HP4-4
 Polarization: Horizontal Tester: Bill Yang
 Test Mode: Transmitting
 Note: 802.11n40_U-NII-3_high channel 5795MHz

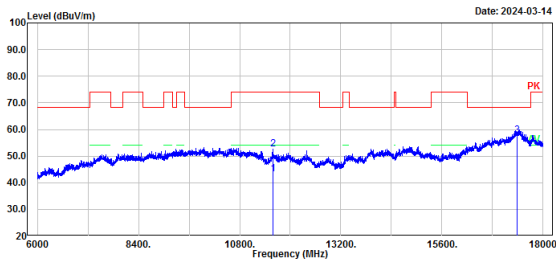

No.	Frequency (MHz)	Reading (dBuV)	Factor (dB/m)	Result (dBuV/m)	Limit (dBuV/m)	Margin (dB)	Detector
1	11590.00	38.74	4.51	43.25	54.00	10.75	Average
2	11590.00	48.08	4.51	52.59	74.00	21.41	Peak
3	17385.00	42.76	14.96	57.72	68.20	10.48	Peak

Project No.: XMDN240206-08079E-RF Serial No.: 2HP4-4
 Polarization: Vertical Tester: Bill Yang
 Test Mode: Transmitting
 Note: 802.11n40_U-NII-3_high channel 5795MHz

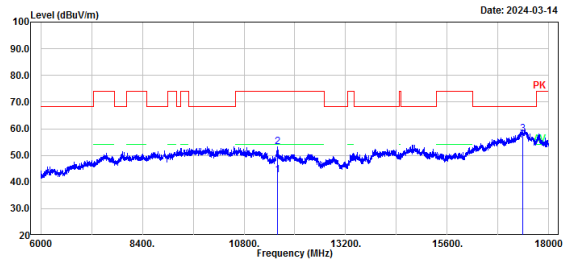

No.	Frequency (MHz)	Reading (dBuV)	Factor (dB/m)	Result (dBuV/m)	Limit (dBuV/m)	Margin (dB)	Detector
1	11590.00	38.26	4.51	42.77	54.00	11.23	Average
2	11590.00	48.72	4.51	53.23	74.00	20.77	Peak
3	17385.00	43.20	14.96	58.16	68.20	10.04	Peak

802.11n ht40 mode, High Channel, Bandedge, Horizontal

Project No.: XMDN240206-08079E-RF
 Polarization: Horizontal
 Test Mode: Transmitting
 Note: 802.11n40_U-NII-3_high channel 5795MHz

Serial No.: 2HP4-4
 Tester: Bill Yang

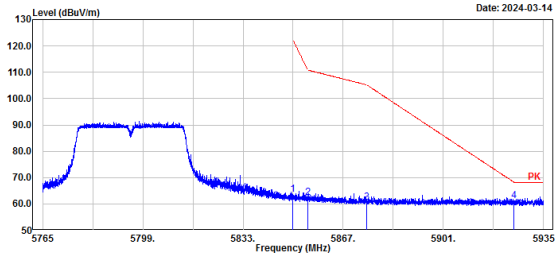

No.	Frequency (MHz)	Reading (dBuV)	Factor (dB/m)	Result (dBuV/m)	Limit (dBuV/m)	Margin (dB)	Detector
1	5850.00	33.61	29.99	63.60	122.20	58.60	Peak
2	5855.00	32.52	30.00	62.52	110.80	48.28	Peak
3	5875.00	30.48	30.03	60.51	105.20	44.69	Peak
4	5925.00	31.17	30.10	61.27	68.20	6.93	Peak

802.11n ht40 mode, High Channel, Bandedge, Vertical

Project No.: XMDN240206-08079E-RF
 Polarization: Vertical
 Test Mode: Transmitting
 Note: 802.11n40_U-NII-3_high channel 5795MHz

Serial No.: 2HP4-4
 Tester: Bill Yang

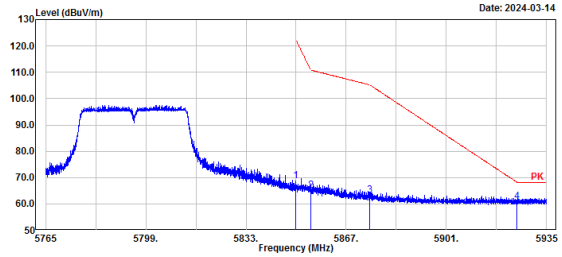

No.	Frequency (MHz)	Reading (dBuV)	Factor (dB/m)	Result (dBuV/m)	Limit (dBuV/m)	Margin (dB)	Detector
1	5850.00	38.86	29.99	68.85	122.20	53.35	Peak
2	5855.00	35.20	30.00	65.20	110.80	45.60	Peak
3	5875.00	33.28	30.03	63.31	105.20	41.89	Peak
4	5925.00	30.91	30.10	61.01	68.20	7.19	Peak

802.11ac80 mode, Middle Channel, Horizontal

Project No.: XMDN240206-08079E-RF Serial No.: 2HP4-4
 Polarization: Horizontal Tester: Bill Yang
 Test Mode: Transmitting
 Note: 802.11ac80_U-NII-3_middle channel 5775MHz

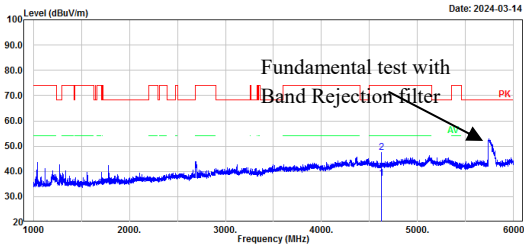

No.	Frequency (MHz)	Reading (dBuV)	Factor (dB/m)	Result (dBuV/m)	Limit (dBuV/m)	Margin (dB)	Detector
1	4622.00	40.65	-3.51	37.14	54.00	16.86	Average
2	4622.00	51.13	-3.51	47.62	74.00	26.38	Peak

802.11ac80 mode, Middle Channel, Vertical

Project No.: XMDN240206-08079E-RF Serial No.: 2HP4-4
 Polarization: Vertical Tester: Bill Yang
 Test Mode: Transmitting
 Note: 802.11ac80_U-NII-3_middle channel 5775MHz

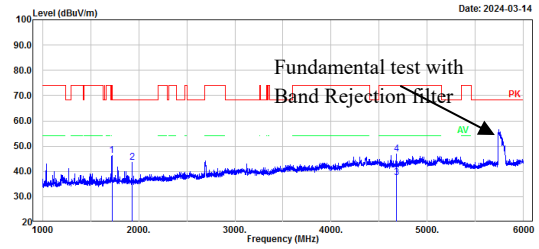

No.	Frequency (MHz)	Reading (dBuV)	Factor (dB/m)	Result (dBuV/m)	Limit (dBuV/m)	Margin (dB)	Detector
1	1722.00	55.94	-9.70	46.24	74.00	27.76	Peak
2	1933.00	53.07	-9.41	43.66	68.20	24.54	Peak
3	4680.00	40.80	-3.26	37.54	54.00	16.46	Average
4	4680.00	50.26	-3.26	47.00	74.00	27.00	Peak

Project No.: XMDN240206-08079E-RF Serial No.: 2HP4-4
 Polarization: Horizontal Tester: Bill Yang
 Test Mode: Transmitting
 Note: 802.11ac80_U-NII-3_middle channel 5775MHz

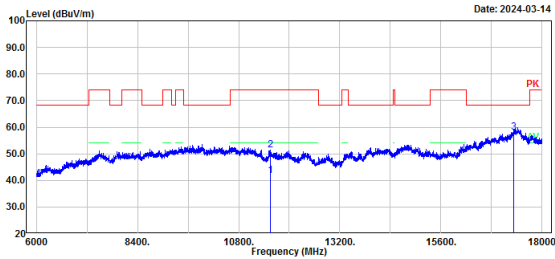

No.	Frequency (MHz)	Reading (dBuV)	Factor (dB/m)	Result (dBuV/m)	Limit (dBuV/m)	Margin (dB)	Detector
1	11550.00	37.24	4.38	41.62	54.00	12.38	Average
2	11550.00	47.08	4.38	51.46	74.00	22.54	Peak
3	17325.00	43.67	14.45	58.12	68.20	10.08	Peak

Project No.: XMDN240206-08079E-RF Serial No.: 2HP4-4
 Polarization: Vertical Tester: Bill Yang
 Test Mode: Transmitting
 Note: 802.11ac80_U-NII-3_middle channel 5775MHz

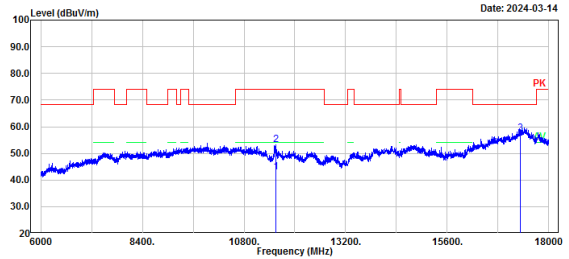

No.	Frequency (MHz)	Reading (dBuV)	Factor (dB/m)	Result (dBuV/m)	Limit (dBuV/m)	Margin (dB)	Detector
1	11550.00	38.44	4.38	42.82	54.00	11.18	Average
2	11550.00	48.85	4.38	53.23	74.00	20.77	Peak
3	17325.00	43.11	14.45	57.56	68.20	10.64	Peak

802.11ac80 mode, High Channel, Bandedge, Horizontal

Project No.: XMDN240206-08079E-RF Serial No.: 2HP4-4
 Polarization: Horizontal Tester: Bill Yang
 Test Mode: Transmitting
 Note: 802.11ac80_U-NII-3_middle channel 5775MHz

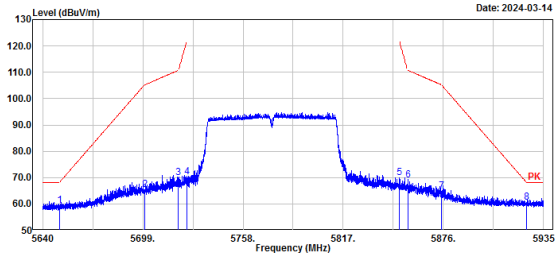

No.	Frequency (MHz)	Reading (dBuV)	Factor (dB/m)	Result (dBuV/m)	Limit (dBuV/m)	Margin (dB)	Detector
1	5650.00	29.65	29.70	59.35	68.20	8.85	Peak
2	5700.00	35.50	29.77	65.27	105.20	39.93	Peak
3	5720.00	40.27	29.80	70.07	110.80	40.73	Peak
4	5725.00	40.43	29.81	70.24	122.20	51.96	Peak
5	5850.00	39.87	29.99	69.86	122.20	52.34	Peak
6	5855.00	39.04	30.00	69.04	110.80	41.76	Peak
7	5875.00	34.66	30.03	64.69	105.20	40.51	Peak
8	5925.00	30.42	30.10	60.52	68.20	7.68	Peak

802.11ac80 mode, High Channel, Bandedge, Vertical

Project No.: XMDN240206-08079E-RF Serial No.: 2HP4-4
 Polarization: Vertical Tester: Bill Yang
 Test Mode: Transmitting
 Note: 802.11ac80_U-NII-3_middle channel 5775MHz

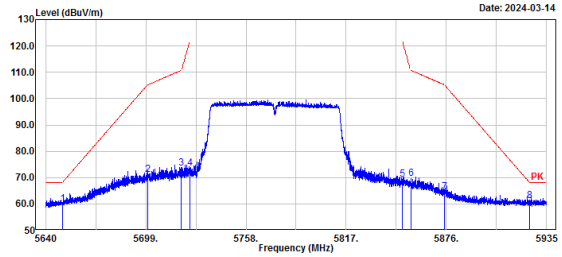

No.	Frequency (MHz)	Reading (dBuV)	Factor (dB/m)	Result (dBuV/m)	Limit (dBuV/m)	Margin (dB)	Detector
1	5650.00	30.30	29.70	60.00	68.20	8.20	Peak
2	5700.00	41.23	29.77	71.00	105.20	34.20	Peak
3	5720.00	43.67	29.80	73.47	110.80	37.33	Peak
4	5725.00	43.65	29.81	73.46	122.20	48.74	Peak
5	5850.00	39.25	29.99	69.24	122.20	52.96	Peak
6	5855.00	39.63	30.00	69.63	110.80	41.17	Peak
7	5875.00	34.32	30.03	64.35	105.20	40.85	Peak
8	5925.00	31.09	30.10	61.19	68.20	7.01	Peak

802.11 ax he20 mode, Low Channel, Horizontal

Project No.: XMDN240206-08079E-RF
 Polarization: Horizontal
 Test Mode: Transmitting
 Note: 802.11ax20_U-NII-3_low channel 5745MHz

Serial No.: 2HP4-4
 Tester: Bill Yang

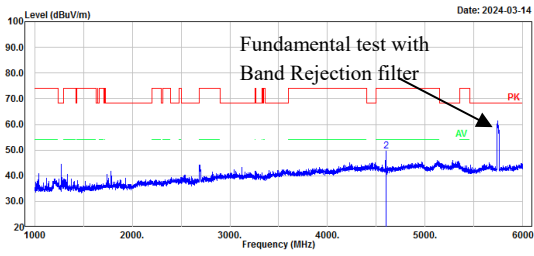

No.	Frequency (MHz)	Reading (dBuV)	Factor (dB/m)	Result (dBuV/m)	Limit (dBuV/m)	Margin (dB)	Detector
1	4596.00	42.83	-3.59	39.24	54.00	14.76	Average
2	4596.00	53.08	-3.59	49.49	74.00	24.51	Peak

802.11 ax he20 mode, Low Channel, Vertical

Project No.: XMDN240206-08079E-RF
 Polarization: Vertical
 Test Mode: Transmitting
 Note: 802.11ax20_U-NII-3_low channel 5745MHz

Serial No.: 2HP4-4
 Tester: Bill Yang

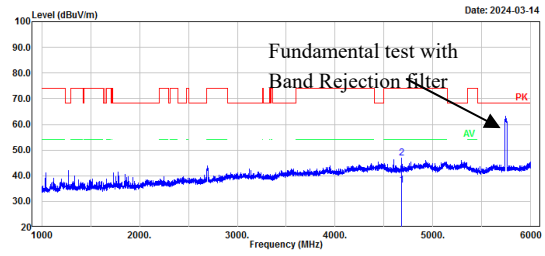

No.	Frequency (MHz)	Reading (dBuV)	Factor (dB/m)	Result (dBuV/m)	Limit (dBuV/m)	Margin (dB)	Detector
1	4680.00	39.50	-3.26	36.24	54.00	17.76	Average
2	4680.00	50.18	-3.26	46.92	74.00	27.08	Peak

Project No.: XMDN240206-08079E-RF
 Polarization: Horizontal
 Test Mode: Transmitting
 Note: 802.11ax20_U-NII-3_low channel 5745MHz

Serial No.: 2HP4-4
 Tester: Bill Yang

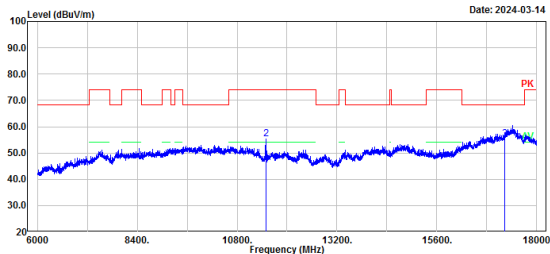

No.	Frequency (MHz)	Reading (dBuV)	Factor (dB/m)	Result (dBuV/m)	Limit (dBuV/m)	Margin (dB)	Detector
1	11490.00	41.21	4.23	45.44	54.00	8.56	Average
2	11490.00	51.11	4.23	55.34	74.00	18.66	Peak
3	17235.00	41.64	13.75	55.39	68.20	12.81	Peak

Project No.: XMDN240206-08079E-RF
 Polarization: Vertical
 Test Mode: Transmitting
 Note: 802.11ax20_U-NII-3_low channel 5745MHz

Serial No.: 2HP4-4
 Tester: Bill Yang

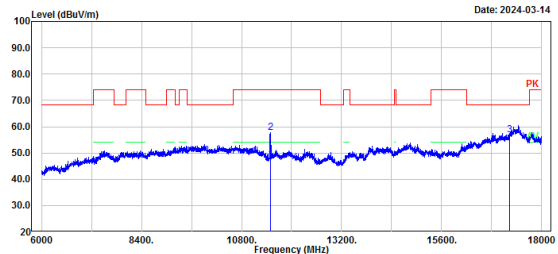

No.	Frequency (MHz)	Reading (dBuV)	Factor (dB/m)	Result (dBuV/m)	Limit (dBuV/m)	Margin (dB)	Detector
1	11490.00	43.39	4.23	47.62	54.00	6.38	Average
2	11490.00	53.61	4.23	57.84	74.00	16.16	Peak
3	17235.00	42.93	13.75	56.68	68.20	11.52	Peak

802.11 ax he20 mode, Low Channel, Bandedge, Horizontal

802.11 ax he20 mode, Low Channel, Bandedge, Vertical

Project No.: XMDN240206-08079E-RF Serial No.: ZHP4-4
 Polarization: Horizontal Tester: Bill Yang
 Test Mode: Transmitting
 Note: 802.11ax20_U-NII-3_low channel 5745MHz

Project No.: XMDN240206-08079E-RF Serial No.: ZHP4-4
 Polarization: Vertical Tester: Bill Yang
 Test Mode: Transmitting
 Note: 802.11ax20_U-NII-3_low channel 5745MHz

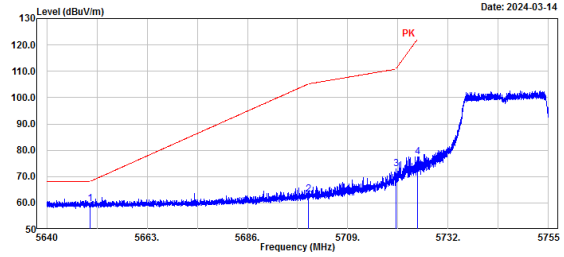
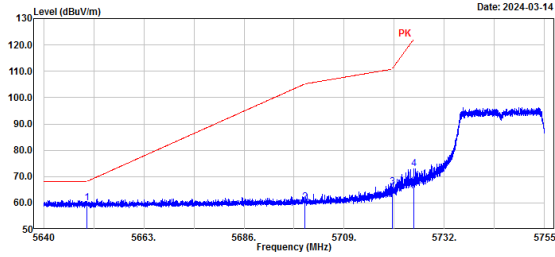

No.	Frequency (MHz)	Reading (dBμV)	Factor (dB/m)	Result (dBμV/m)	Limit (dBμV/m)	Margin (dB)	Detector
1	5650.00	30.29	29.70	59.99	68.20	8.21	Peak
2	5700.00	30.39	29.77	60.16	105.20	45.04	Peak
3	5720.00	36.23	29.80	66.03	110.80	44.77	Peak
4	5725.00	43.07	29.81	72.88	122.20	49.32	Peak

No.	Frequency (MHz)	Reading (dBμV)	Factor (dB/m)	Result (dBμV/m)	Limit (dBμV/m)	Margin (dB)	Detector
1	5650.00	30.00	29.70	59.70	68.20	8.50	Peak
2	5700.00	33.44	29.77	63.21	105.20	41.99	Peak
3	5720.00	43.14	29.80	72.94	110.80	37.86	Peak
4	5725.00	47.65	29.81	77.46	122.20	44.74	Peak

802.11 ax he20 mode, Middle Channel, Horizontal

Project No.: XMDN240206-08079E-RF Serial No.: 2HP4-4
 Polarization: Horizontal Tester: Bill Yang
 Test Mode: Transmitting
 Note: 802.11ax20_U-NII-3_middle channel 5785MHz

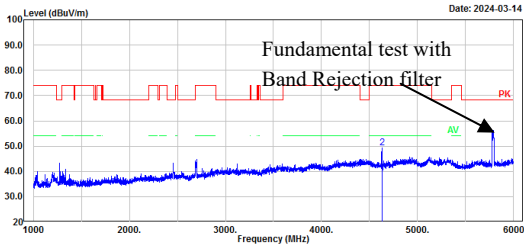

No.	Frequency (MHz)	Reading (dBuV)	Factor (dB/m)	Result (dBuV/m)	Limit (dBuV/m)	Margin (dB)	Detector
1	4628.00	42.84	-3.48	39.36	54.00	14.64	Average
2	4628.00	52.77	-3.48	49.29	74.00	24.71	Peak

802.11 ax he20 mode, Middle Channel, Vertical

Project No.: XMDN240206-08079E-RF Serial No.: 2HP4-4
 Polarization: Vertical Tester: Bill Yang
 Test Mode: Transmitting
 Note: 802.11ax20_U-NII-3_middle channel 5785MHz

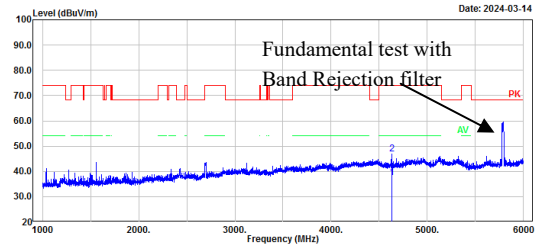

No.	Frequency (MHz)	Reading (dBuV)	Factor (dB/m)	Result (dBuV/m)	Limit (dBuV/m)	Margin (dB)	Detector
1	4628.00	40.89	-3.48	37.41	54.00	16.59	Average
2	4628.00	50.49	-3.48	47.01	74.00	26.99	Peak

Project No.: XMDN240206-08079E-RF Serial No.: 2HP4-4
 Polarization: Horizontal Tester: Bill Yang
 Test Mode: Transmitting
 Note: 802.11ax20_U-NII-3_middle channel 5785MHz

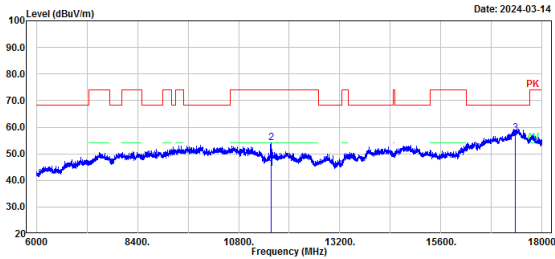

No.	Frequency (MHz)	Reading (dBuV)	Factor (dB/m)	Result (dBuV/m)	Limit (dBuV/m)	Margin (dB)	Detector
1	11570.00	39.87	4.44	44.31	54.00	9.69	Average
2	11570.00	49.65	4.44	54.09	74.00	19.91	Peak
3	17355.00	43.03	14.70	57.73	68.20	10.47	Peak

Project No.: XMDN240206-08079E-RF Serial No.: 2HP4-4
 Polarization: Vertical Tester: Bill Yang
 Test Mode: Transmitting
 Note: 802.11ax20_U-NII-3_middle channel 5785MHz

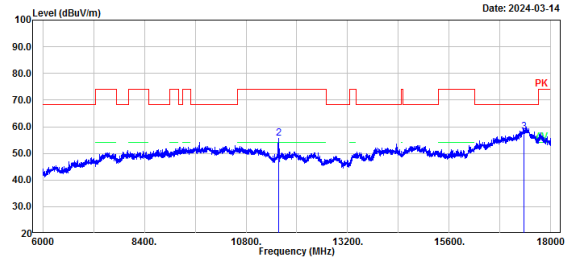

No.	Frequency (MHz)	Reading (dBuV)	Factor (dB/m)	Result (dBuV/m)	Limit (dBuV/m)	Margin (dB)	Detector
1	11570.00	41.23	4.44	45.67	54.00	8.33	Average
2	11570.00	51.30	4.44	55.74	74.00	18.26	Peak
3	17355.00	43.19	14.70	57.89	68.20	10.31	Peak