

## TEST REPORT

**Applicant:** Fujian LANDI Commercial Equipment Co.,Ltd.

**FCC:** Building 17, Section A, Software Park, No. 89 Software Road, Gulou District, Fuzhou Municipality, Fujian Province, China  
**Address:** IC: Building 17, Section A, Software Park, No. 89 Software Road, Gulou District, Fuzhou Municipality, Fujian Province, P.R. 350003 China

**Product Name:** POS Terminal

**FCC ID:** 2AG6N-C20LITE

**IC:** 23725-C20LITE

**HVIN:** C20LiteS, C20LiteD

47 CFR Part 15, Subpart C(15.247)  
RSS-247 Issue 3, August 2023  
**Standard(s):** RSS-Gen, Issue 5, February 2021 Amendment 2  
ANSI C63.10-2013  
KDB 558074 D01 15.247 Meas Guidance v05r02

**Report Number:** XMDN240205-07900E-RF-00B

**Report Date:** 2024/4/8

The above device has been tested and found compliant with the requirement of the relative standards by Bay Area Compliance Laboratories Corp. (Dongguan).

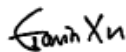

**Reviewed By:** Gavin Xu  
Title: RF Engineer



**Approved By:** Ivan Cao  
Title: EMC Manager

---

**Bay Area Compliance Laboratories Corp. (Dongguan)**  
No.12, Pulong East 1<sup>st</sup> Road, Tangxia Town, Dongguan, Guangdong, China

Tel: +86-769-86858888

Fax: +86-769-86858891

[www.baclcorp.com.cn](http://www.baclcorp.com.cn)

Note: The information marked ▲ is provided by the applicant, the laboratory is not responsible for its authenticity and this information can affect the validity of the result in the test report. Unless otherwise stated the results shown in this test report refer only to the sample(s) tested. This report cannot be reproduced except in full, without prior written approval of the Company. This report is valid only with a valid digital signature. The digital signature may be available only under the Adobe software above version 7.0. This report may contain data that are not covered by the accreditation scope and shall be marked with ★. This report must not be used by the client to claim product certification, approval, or endorsement by NVLAP, NIST, or any agency of the U.S. Government.

# CONTENTS

<b>DOCUMENT REVISION HISTORY .....</b>	<b>4</b>
<b>1. GENERAL INFORMATION .....</b>	<b>5</b>
<b>1.1 PRODUCT DESCRIPTION FOR EQUIPMENT UNDER TEST (EUT) .....</b>	<b>5</b>
<b>1.2 ACCESSORY INFORMATION.....</b>	<b>5</b>
<b>1.3 ANTENNA INFORMATION DETAIL▲.....</b>	<b>5</b>
<b>1.4 EQUIPMENT MODIFICATIONS .....</b>	<b>5</b>
<b>3. SUMMARY OF TEST RESULTS .....</b>	<b>6</b>
<b>3. DESCRIPTION OF TEST CONFIGURATION .....</b>	<b>7</b>
<b>3.1 OPERATION FREQUENCY DETAIL.....</b>	<b>7</b>
<b>3.2 EUT OPERATION CONDITION.....</b>	<b>7</b>
<b>3.3 SUPPORT EQUIPMENT LIST AND DETAILS .....</b>	<b>7</b>
<b>3.4 SUPPORT CABLE LIST AND DETAILS .....</b>	<b>8</b>
<b>3.5 BLOCK DIAGRAM OF TEST SETUP .....</b>	<b>8</b>
<b>3.6 TEST FACILITY.....</b>	<b>10</b>
<b>3.7 MEASUREMENT UNCERTAINTY .....</b>	<b>10</b>
<b>4. REQUIREMENTS AND TEST PROCEDURES .....</b>	<b>11</b>
<b>4.1 AC LINE CONDUCTED EMISSIONS.....</b>	<b>11</b>
4.1.1 Applicable Standard.....	11
4.1.2 EUT Setup.....	13
4.1.3 EMI Test Receiver Setup .....	13
4.1.4 Test Procedure .....	14
4.1.5 Corrected Amplitude & Margin Calculation.....	14
4.1.6 Test Result .....	14
<b>4.2 RADIATION SPURIOUS EMISSIONS .....</b>	<b>15</b>
4.2.1 Applicable Standard.....	15
4.2.2 EUT Setup.....	15
4.2.3 EMI Test Receiver & Spectrum Analyzer Setup .....	17
4.2.4 Test Procedure .....	17
4.2.5 Corrected Amplitude & Margin Calculation.....	17
4.2.6 Test Result .....	17
<b>4.3 MINIMUM 6 DB EMISSION BANDWIDTH .....</b>	<b>18</b>
4.3.1 Applicable Standard.....	18
4.3.2 EUT Setup.....	18
4.3.3 Test Procedure .....	18
4.3.4 Test Result .....	18
<b>4.4 99% OCCUPIED BANDWIDTH.....</b>	<b>19</b>
4.4.1 Applicable Standard.....	19
4.4.2 EUT Setup.....	19
4.4.3 Test Procedure .....	20
4.4.4 Test Result .....	20
<b>4.5 MAXIMUM CONDUCTED OUTPUT POWER.....</b>	<b>21</b>
4.5.1 Applicable Standard.....	21

4.5.2 EUT Setup.....21  
 4.5.3 Test Procedure .....21  
 4.5.4 Test Result .....21  
**4.6 MAXIMUM POWER SPECTRAL DENSITY .....22**  
 4.6.1 Applicable Standard.....22  
 4.6.2 EUT Setup.....22  
 4.6.3 Test Procedure .....22  
 4.6.4 Test Result .....22  
**4.7 100 KHZ BANDWIDTH OF FREQUENCY BAND EDGE.....23**  
 4.7.1 Applicable Standard.....23  
 4.7.2 EUT Setup.....23  
 4.7.3 Test Procedure .....23  
 4.7.4 Test Result .....23  
**4.8 DUTY CYCLE .....24**  
 4.8.1 EUT Setup.....24  
 4.8.2 Test Procedure .....24  
 4.8.3 Judgment.....24  
**4.9 ANTENNA REQUIREMENT.....25**  
 4.9.1 Applicable Standard.....25  
 4.9.2 Judgment.....25  
**5. Test DATA AND RESULTS .....26**  
**5.1 AC LINE CONDUCTED EMISSIONS.....26**  
**5.2 RADIATION SPURIOUS EMISSIONS .....29**  
**5.3 MINIMUM 6 DB EMISSION BANDWIDTH .....54**  
**5.4 99% OCCUPIED BANDWIDTH.....57**  
**5.5 MAXIMUM CONDUCTED OUTPUT POWER.....60**  
**5.6 MAXIMUM POWER SPECTRAL DENSITY .....61**  
**5.7 100 KHZ BANDWIDTH OF FREQUENCY BAND EDGE: .....64**  
**5.8 DUTY CYCLE: .....67**  
**APPENDIX A - EUT PHOTOGRAPHS .....69**  
**APPENDIX B - TEST SETUP PHOTOGRAPHS.....70**  
**APPENDIX C - RF EXPOSURE EVALUATION .....71**  
**MAXIMUM PERMISSIBLE EXPOSURE (MPE) .....71**  
**EXEMPTION LIMITS FOR ROUTINE EVALUATION-RF EXPOSURE EVALUATION.....72**

## DOCUMENT REVISION HISTORY

Revision Number	Report Number	Description of Revision	Date of Revision
1.0	XMDN240205-07900E-RF-00B	Original Report	2024/4/8

## 1. GENERAL INFORMATION

### 1.1 Product Description for Equipment under Test (EUT)

<b>EUT Name:</b>	POS Terminal
<b>EUT Model:</b>	C20Lite
<b>Operation Frequency:</b>	2412-2462 MHz(802.11b/g/n ht20) 2422-2452 MHz(802.11n ht40)
<b>Maximum Peak Output Power (Conducted):</b>	23.86dBm
<b>Modulation Type:</b>	802.11b:DSSS-DBPSK, DQPSK, CCK 802.11g/n: OFDM-BPSK, QPSK, 16QAM, 64QAM
<b>Rated Input Voltage:</b>	DC 19V from adapter
<b>Serial Number:</b>	Double screen: 2HNF-2(For RF Conducted test) 2HNF-1(For Radiated spurious emission(Above 1G) test) Single screen: 2HNF-3(For Radiated spurious emission(Below 1G) test and AC line conducted emission test)
<b>EUT Received Date:</b>	2024/2/6
<b>EUT Received Status:</b>	Good

### 1.2 Accessory Information

Accessory Description	Manufacturer	Model	Parameters
Adapter 1#	LITE-ON TECHNOLOGY CORPORATION	PA-1400-76	Input: 100-240Vac,50/60Hz,1.2A Output: 19Vdc,2.1A
Adapter 2#	LITE-ON TECHNOLOGY CORPORATION	PA-1650-90	Input: 100-240Vac,50/60Hz,1.6A Output: 19Vdc,3.42A

### 1.3 Antenna Information Detail ▲

Antenna Manufacturer	Antenna Type	input impedance (Ohm)	Frequency Range	Antenna Gain
Shanghai Jesoncom Communication Engineering Co., Ltd	FPC	50	2.4~2.5GHz	6.45 dBi
<b>The design of compliance with §15.203:</b>				
<input checked="" type="checkbox"/> Unit uses a permanently attached antenna.				
<input type="checkbox"/> Unit uses a unique coupling to the intentional radiator.				
<input type="checkbox"/> Unit was professionally installed, and installer shall be responsible for verifying that the correct antenna is employed with the unit.				

### 1.4 Equipment Modifications

No modifications are made to the EUT during all test items.

### 3. SUMMARY OF TEST RESULTS

Standard(s) Section	Test Items	Result
§15.207(a) RSS-Gen Clause 8.8	AC Line Conducted Emissions	Compliant
§15.205, §15.209, §15.247(d) RSS-Gen Clause 8.10	Spurious Emissions	Compliant
§15.247 (a)(2) RSS-247 Clause 5.2 a)	Minimum 6 dB Bandwidth	Compliant
RSS-Gen Clause 6.7	99% Occupied Bandwidth	Compliant
§15.247(b)(3) RSS-247 Clause 5.4 d)	Maximum Conducted Output Power	Compliant
§15.247(d) RSS-247 Clause 5.5	100 kHz Bandwidth Of Frequency Band Edge	Compliant
§15.247(e) RSS-247 Clause 5.2 b)	Power Spectral Density	Compliant
FCC §15.203 RSS-Gen Clause 6.8	Antenna Requirement	Compliant
<p>Note 1: For AC line conducted emissions, the maximum output power mode and channel was tested.</p> <p>Note 2: For Radiated Spurious Emissions 9kHz~ 1GHz and 18-25GHz, the maximum output power mode and channel was tested.</p> <p>Note 3: According to the test result of Bluetooth, single screen configuration &amp; Adapter 1# was the worst, so the single screen configuration &amp; Adapter 1# was tested for AC line conducted emission/Radiated spurious emissions below 1GHz.</p>		

### 3. DESCRIPTION OF TEST CONFIGURATION

#### 3.1 Operation Frequency Detail

For 802.11b/g/n ht20:

Channel	Frequency (MHz)	Channel	Frequency (MHz)
1	2412	7	2442
2	2417	8	2447
3	2422	9	2452
4	2427	10	2457
5	2432	11	2462
6	2437	/	/

For 802.11n ht40:

Channel	Frequency (MHz)	Channel	Frequency (MHz)
3	2422	7	2442
4	2427	8	2447
5	2432	9	2452
6	2437	/	/

#### 3.2 EUT Operation Condition

The system was configured for testing in Engineering Mode, which was provided by the manufacturer.

EUT Exercise Software:		CMD		
The software was provided by manufacturer. The maximum power was configured as below, that was provided by the manufacturer ▲ :				
Test Modes	Data Rate	Power Level Setting		
		Low Channel	Middle Channel	High Channel
802.11b	1Mbps	43	43	43
802.11g	6Mbps	40	40	40
802.11n ht20	MCS0	43	43	40
802.11n ht40	MCS0	40	40	37
The above are the worst-case data rates, which are determined for each mode based upon investigations by measuring the average power and PSD across all data rates, bandwidths, and modulations.				

#### 3.3 Support Equipment List and Details

Manufacturer	Description	Model	Serial Number
SanDisk	Micro TF Card	UHS-I-16G	9292DVDSV0XZ
SANDisk	USB Flash Disk	16G	BL201026115 B
SANDisk	USB Flash Disk	16G	BL201026331
D-Link	Router	DGS-1100-08PD	S01Z1H000012
PHILIPS	Keyboard	SPK6234	K234210510743
PHILIPS	Mouse	SPK7214	M214BQ210411115
IPRO	Earphone	Phonenix 5.0s	EMZBEP21103002B
Fujian LANDI Commercial Equipment Co.,Ltd.	Cashbox	Unkown	EZ240214F212

### 3.4 Support Cable List and Details

Cable Description	Shielding Type	Ferrite Core	Length (m)	From Port	To
DC Cable	No	No	1.0	Adapter 1#	EUT
RJ45 Cable	No	No	10	EUT	Router
USB Cable	No	No	1.5	Keyboard	EUT
USB Cable	No	No	1.5	Mouse	EUT
Earphone Cable	No	No	1.0	Earphone	EUT
Cashbox Cable	No	No	1.0	Cashbox	EUT

### 3.5 Block Diagram of Test Setup

AC power line conducted emissions:

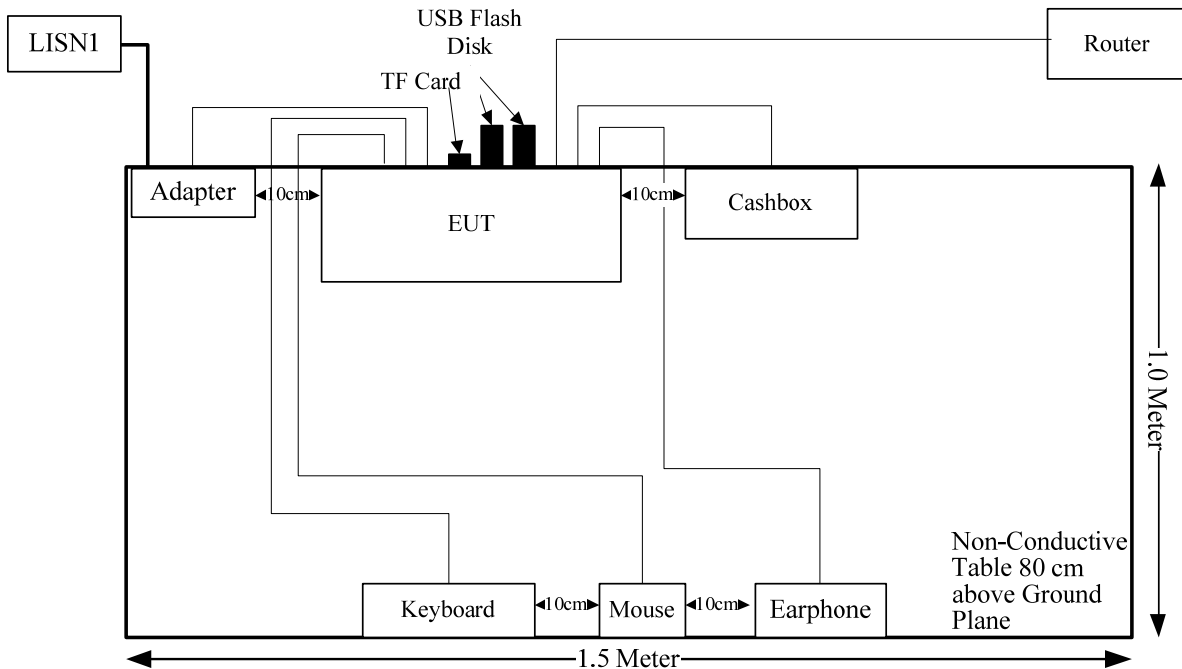



Radiated Spurious Emissions:

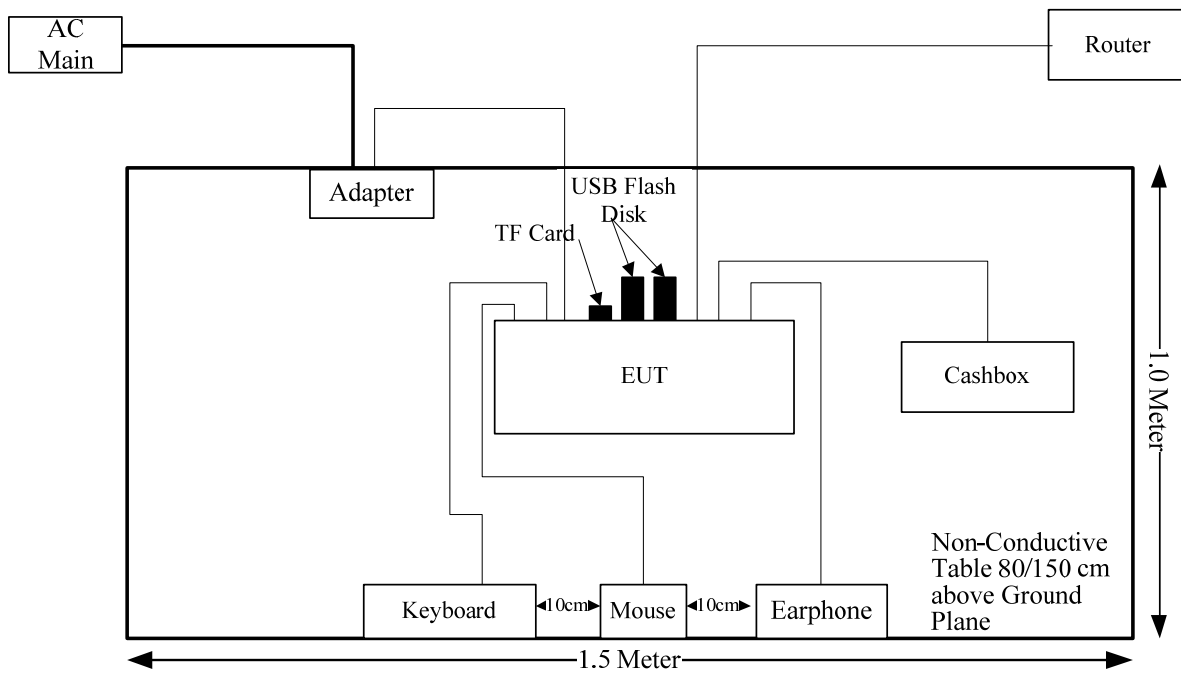

### 3.6 Test Facility

The Test site used by Bay Area Compliance Laboratories Corp. (Dongguan) to collect test data is located on the No.12, Pulong East 1st Road, Tangxia Town, Dongguan, Guangdong, China.

The lab has been recognized as the FCC accredited lab under the KDB 974614 D01 and is listed in the FCC Public Access Link (PAL) database, FCC Registration No. : 829273, the FCC Designation No. : CN5044.

The lab has been recognized by Innovation, Science and Economic Development Canada to test to Canadian radio equipment requirements, the CAB identifier: CN0022.

### 3.7 Measurement Uncertainty

Otherwise required by the applicant or Product Regulations, Decision Rule in this report did not consider the uncertainty. The extended uncertainty given in this report is obtained by combining the standard uncertainty times the coverage factor K with the 95% confidence interval.

Parameter	Measurement Uncertainty
Occupied Channel Bandwidth	±5 %
RF output power, conducted	±0.61dB
Power Spectral Density, conducted	±0.61 dB
Unwanted Emissions, radiated	9kHz~30MHz: 3.3dB, 30MHz~200MHz: 4.55 dB, 200MHz~1GHz: 5.92 dB, 1GHz~6GHz: 4.98 dB, 6GHz~18GHz: 5.89 dB, 18GHz~26.5GHz:5.47 dB, 26.5GHz~40GHz:5.63 dB
Unwanted Emissions, conducted	±2.47 dB
Temperature	±1°C
Humidity	±5%
DC and low frequency voltages	±0.4%
Duty Cycle	1%
AC Power Lines Conducted Emission	3.11 dB (150 kHz to 30 MHz)

## 4. REQUIREMENTS AND TEST PROCEDURES

### 4.1 AC Line Conducted Emissions

#### 4.1.1 Applicable Standard

FCC§15.207(a).

(a) Except as shown in paragraphs (b) and (c) of this section, for an intentional radiator that is designed to be connected to the public utility (AC) power line, the radio frequency voltage that is conducted back onto the AC power line on any frequency or frequencies, within the band 150 kHz to 30 MHz, shall not exceed the limits in the following table, as measured using a 50  $\mu$ H/50 ohms line impedance stabilization network (LISN). Compliance with the provisions of this paragraph shall be based on the measurement of the radio frequency voltage between each power line and ground at the power terminal. The lower limit applies at the boundary between the frequency ranges.

Frequency of emission (MHz)	Conducted limit (dB $\mu$ V)	
	Quasi-peak	Average
0.15-0.5	66 to 56*	56 to 46*
0.5-5	56	46
5-30	60	50

\*Decreases with the logarithm of the frequency.

(b) The limit shown in paragraph (a) of this section shall not apply to carrier current systems operating as intentional radiators on frequencies below 30 MHz. In lieu thereof, these carrier current systems shall be subject to the following standards:

(1) For carrier current system containing their fundamental emission within the frequency band 535-1705 kHz and intended to be received using a standard AM broadcast receiver: no limit on conducted emissions.

(2) For all other carrier current systems: 1000  $\mu$ V within the frequency band 535-1705 kHz, as measured using a 50  $\mu$ H/50 ohms LISN.

(3) Carrier current systems operating below 30 MHz are also subject to the radiated emission limits in §15.205, §15.209, §15.221, §15.223, or §15.227, as appropriate.

(c) Measurements to demonstrate compliance with the conducted limits are not required for devices which only employ battery power for operation and which do not operate from the AC power lines or contain provisions for operation while connected to the AC power lines. Devices that include, or make provisions for, the use of battery chargers which permit operating while charging, AC adapters or battery eliminators or that connect to the AC power lines indirectly, obtaining their power through another device which is connected to the AC power lines, shall be tested to demonstrate compliance with the conducted limits.

## RSS-Gen Clause 8.8

Unless stated otherwise in the applicable RSS, for radio apparatus that are designed to be connected to the public utility AC power network, the radio frequency voltage that is conducted back onto the AC power line on any frequency or frequencies within the range 150 kHz to 30 MHz shall not exceed the limits in table 4, as measured using a 50  $\mu$ H / 50  $\Omega$  line impedance stabilization network. This requirement applies for the radio frequency voltage measured between each power line and the ground terminal of each AC power-line mains cable of the EUT. For an EUT that connects to the AC power lines indirectly, through another device, the requirement for compliance with the limits in table 4 shall apply at the terminals of the AC power-line mains cable of a representative support device, while it provides power to the EUT. The lower limit applies at the boundary between the frequency ranges. The device used to power the EUT shall be representative of typical applications.

**Table 4 – AC power-line conducted emissions limits**

Frequency (MHz)	Conducted limit (dB $\mu$ V)	
	Quasi-peak	Average
0.15 - 0.5	66 to 56 <sup>1</sup>	56 to 46 <sup>1</sup>
0.5 – 5	56	46
5 – 30	60	50

**Note 1:** The level decreases linearly with the logarithm of the frequency.

For an EUT with a permanent or detachable antenna operating between 150 kHz and 30 MHz, the AC power-line conducted emissions must be measured using the following configurations:

- (a) Perform the AC power-line conducted emissions test with the antenna connected to determine compliance with the limits of table 4 outside the transmitter's fundamental emission band.
- (b) Retest with a dummy load instead of the antenna to determine compliance with the limits of table 4 within the transmitter's fundamental emission band. For a detachable antenna, remove the antenna and connect a suitable dummy load to the antenna connector. For a permanent antenna, remove the antenna and terminate the RF output with a dummy load or network that simulates the antenna in the fundamental frequency band.

**4.1.2 EUT Setup**

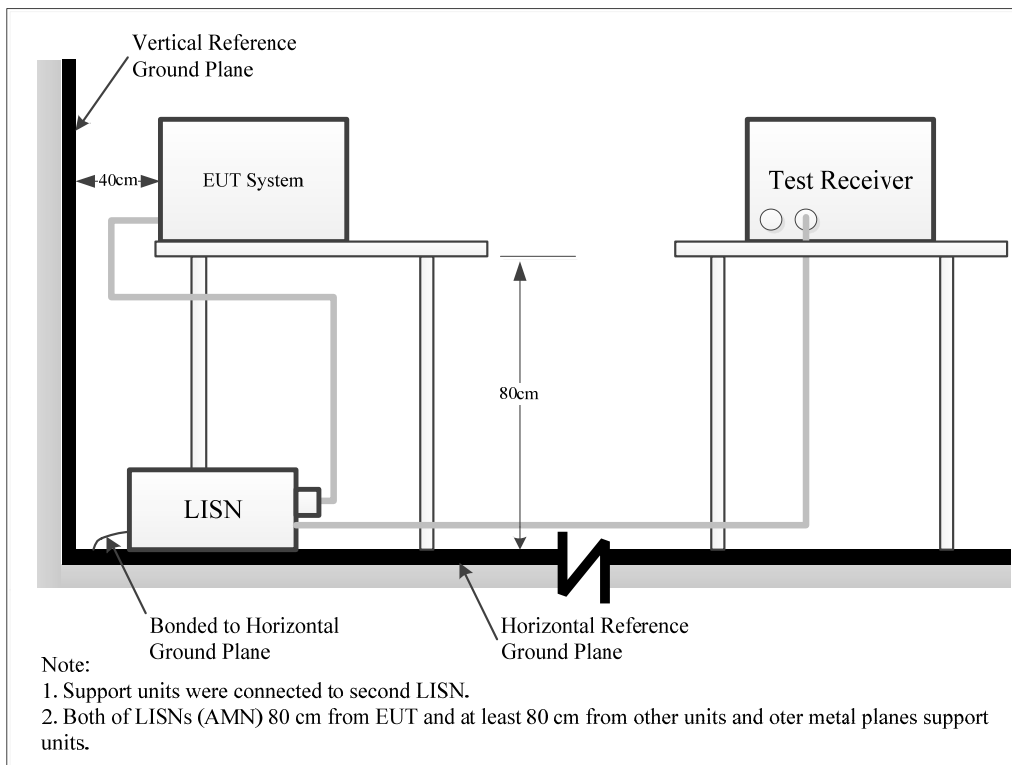

The setup of EUT is according with per ANSI C63.10-2013 measurement procedure. The specification used was with the FCC Part 15.207 ,RSS-Gen limits.

The spacing between the peripherals was 10 cm.

The adapter or EUT was connected to the main LISN with a 120 V/60 Hz AC power source.

**4.1.3 EMI Test Receiver Setup**

The EMI test receiver was set to investigate the spectrum from 150 kHz to 30 MHz.

During the conducted emission test, the EMI test receiver was set with the following configurations:

Frequency Range	IF B/W
150 kHz – 30 MHz	9 kHz

#### 4.1.4 Test Procedure

The frequency and amplitude of the six highest ac power-line conducted emissions relative to the limit, measured over all the current-carrying conductors of the EUT power cords, and the operating frequency or frequency to which the EUT is tuned (if appropriate), should be reported, unless such emissions are more than 20 dB below the limit. AC power-line conducted emissions measurements are to be separately carried out only on each of the phase (“hot”) line(s) and (if used) on the neutral line(s), but not on the ground [protective earth] line(s). If less than six emission frequencies are within 20 dB of the limit, then the noise level of the measuring instrument at representative frequencies should be reported. The specific conductor of the power-line cord for each of the reported emissions should be identified. Measure the six highest emissions with respect to the limit on each current-carrying conductor of each power cord associated with the EUT (but not the power cords of associated or peripheral equipment that are part of the test configuration). Then, report the six highest emissions with respect to the limit from among all the measurements identifying the frequency and specific current-carrying conductor identified with the emission. The six highest emissions should be reported for each of the current-carrying conductors, or the six highest emissions may be reported over all the current-carrying conductors.

#### 4.1.5 Corrected Amplitude & Margin Calculation

The basic equation is as follows:

$$\text{Result} = \text{Reading} + \text{Factor}$$

$$\text{Factor} = \text{attenuation caused by cable loss} + \text{voltage division factor of AMN}$$

The “**Margin**” column of the following data tables indicates the degree of compliance within the applicable limit. The equation for margin calculation is as follows:

$$\text{Margin} = \text{Limit} - \text{Result}$$

#### 4.1.6 Test Result

Please refer to section 5.1.

## 4.2 Radiation Spurious Emissions

### 4.2.1 Applicable Standard

FCC §15.247 (d);

In any 100 kHz bandwidth outside the frequency band in which the spread spectrum or digitally modulated intentional radiator is operating, the radio frequency power that is produced by the intentional radiator shall be at least 20 dB below that in the 100 kHz bandwidth within the band that contains the highest level of the desired power, based on either an RF conducted or a radiated measurement, provided the transmitter demonstrates compliance with the peak conducted power limits. If the transmitter complies with the conducted power limits based on the use of RMS averaging over a time interval, as permitted under paragraph (b)(3) of this section, the attenuation required under this paragraph shall be 30 dB instead of 20 dB. Attenuation below the general limits specified in §15.209(a) is not required. In addition, radiated emissions which fall in the restricted bands, as defined in §15.205(a), must also comply with the radiated emission limits specified in §15.209(a) (see §15.205(c)).

RSS-247 Clause 5.5

In any 100 kHz bandwidth outside the frequency band in which the spread spectrum or digitally modulated device is operating, the RF power that is produced shall be at least 20 dB below that in the 100 kHz bandwidth within the band that contains the highest level of the desired power, based on either an RF conducted or a radiated measurement, provided that the transmitter demonstrates compliance with the peak conducted power limits. If the transmitter complies with the conducted power limits based on the use of root-mean-square averaging over a time interval, as permitted under section 5.4(d), the attenuation required shall be 30 dB instead of 20 dB. Attenuation below the general field strength limits specified in RSS-Gen is not required

### 4.2.2 EUT Setup

9kHz~30MHz:

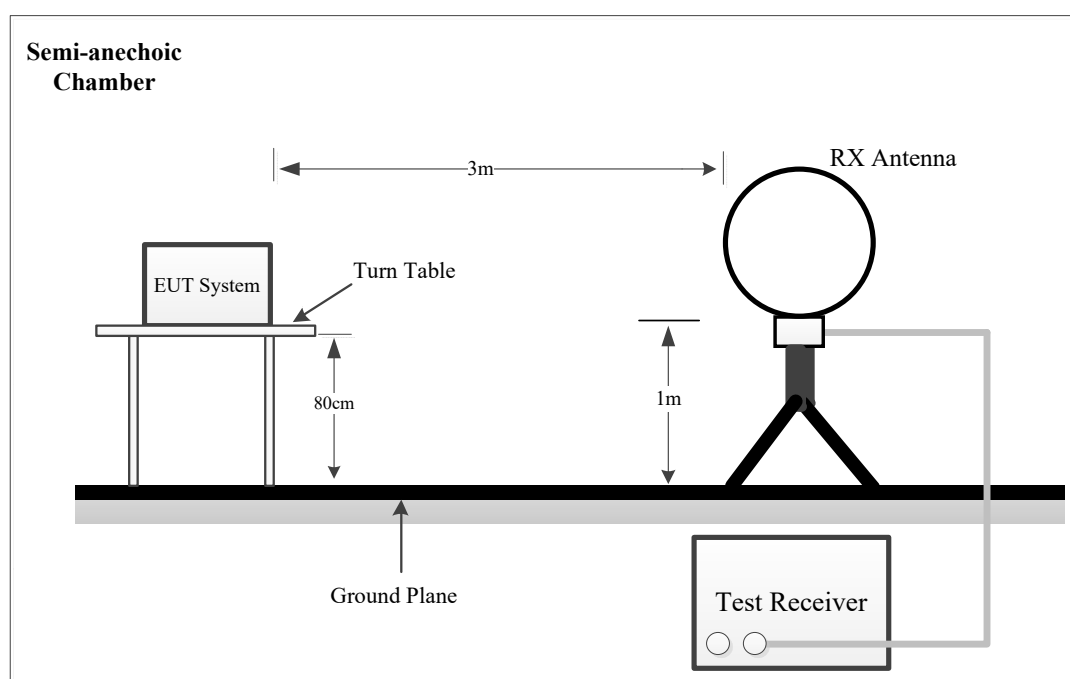

**30MHz~1GHz:**

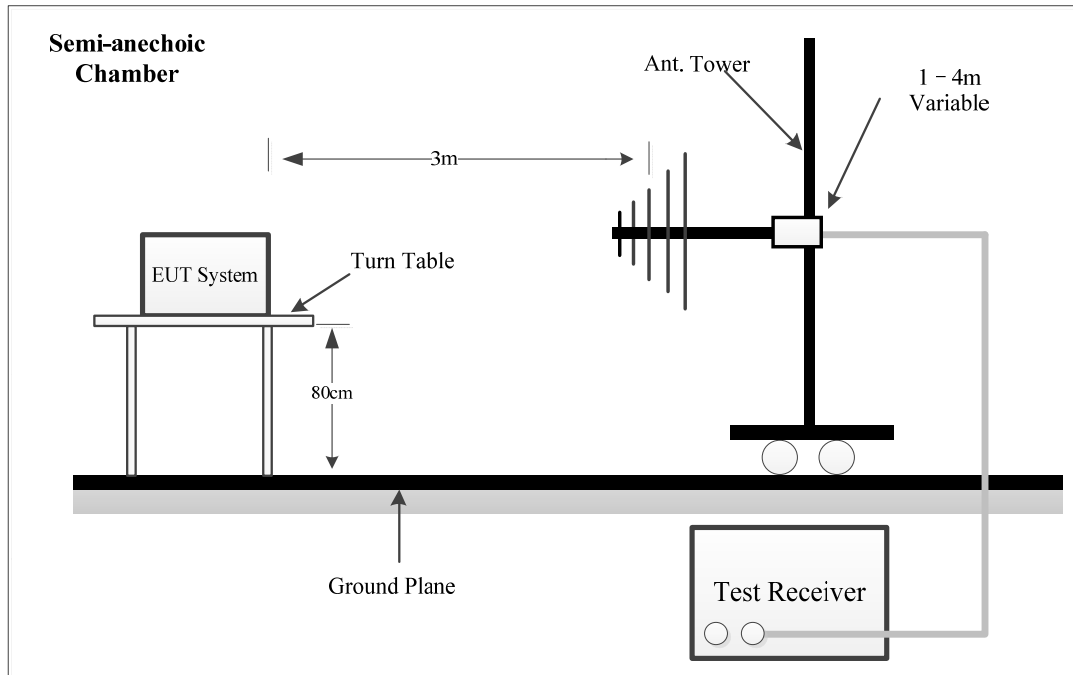

**Above 1GHz:**

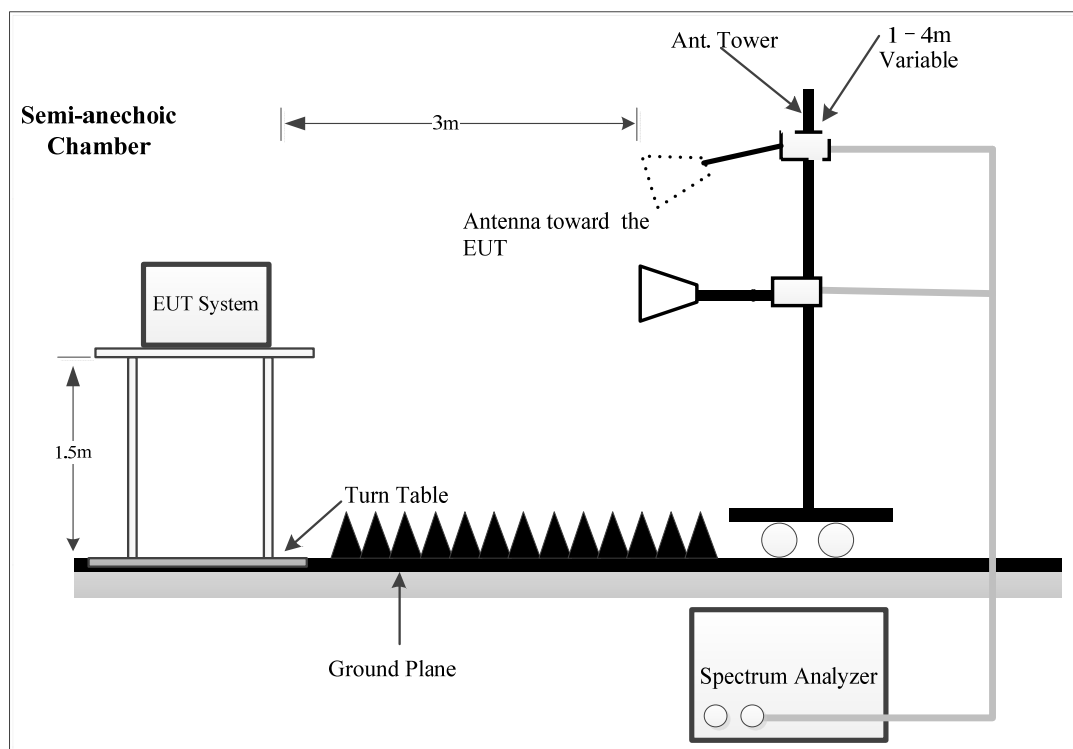

The radiated emissions were performed in the 3 meters distance, using the setup accordance with the ANSI C63.10-2013. The specification used was the FCC 15.209, and FCC 15.247, RSS-247, RSS-Gen limits.

The external I/O cables were draped along the test table and formed a bundle 30 to 40 cm long in the middle.



For 9kHz-30MHz test, the lowest height of the magnetic antenna shall be 1 m above the ground and three antenna orientations (parallel, perpendicular, and ground-parallel) shall be measured.

#### 4.2.3 EMI Test Receiver & Spectrum Analyzer Setup

The system was investigated from 9 kHz to 25 GHz.

During the radiated emission test, the EMI test receiver & Spectrum Analyzer Setup were set with the following configurations:

9kHz-1000MHz:

Frequency Range	Measurement	RBW	Video B/W	IF B/W
9 kHz – 150 kHz	QP/AV	200 Hz	1 kHz	200 Hz
150 kHz – 30 MHz	QP/AV	9 kHz	30 kHz	9 kHz
30 MHz – 1000 MHz	PK	100 kHz	300 kHz	/
	QP	/	/	120 kHz

1GHz- 25GHz:

Measurement	Duty cycle	RBW	Video B/W
PK	Any	1MHz	3 MHz
Ave.	>98%	1MHz	10 Hz
	<98%	1MHz	$\geq 1/T$

Note: T is minimum transmission duration

If the maximized peak measured value complies with under the QP limit more than 6dB, then it is unnecessary to perform an QP measurement.

If the maximized peak measured value complies with under the Average limit, then it is unnecessary to perform an Average measurement.

#### 4.2.4 Test Procedure

Maximizing procedure was performed on the highest emissions to ensure that the EUT complied with all installation combinations.

Data was recorded in Quasi-peak detection mode for frequency range of 9 kHz-1 GHz except 9 – 90 kHz, 110 – 490 kHz, employing an average detector, peak and Average detection modes for frequencies above 1 GHz.

All emissions under the average limit and under the noise floor have not recorded in the report.

#### 4.2.5 Corrected Amplitude & Margin Calculation

The basic equation is as follows:

Result = Reading + Factor

Factor = Antenna Factor + Cable Loss - Amplifier Gain

The “**Margin**” column of the following data tables indicates the degree of compliance within the applicable limit. The equation for margin calculation is as follows:

Margin = Limit – Result

#### 4.2.6 Test Result

Please refer to section 5.2.

### 4.3 Minimum 6 dB Emission Bandwidth

#### 4.3.1 Applicable Standard

FCC §15.247 (a)(2)

Systems using digital modulation techniques may operate in the 902-928 MHz, 2400-2483.5 MHz, and 5725-5850 MHz bands. The minimum 6 dB bandwidth shall be at least 500 kHz.

RSS-247 Clause 5.2 a

The minimum 6 dB bandwidth shall be 500 kHz.

#### 4.3.2 EUT Setup

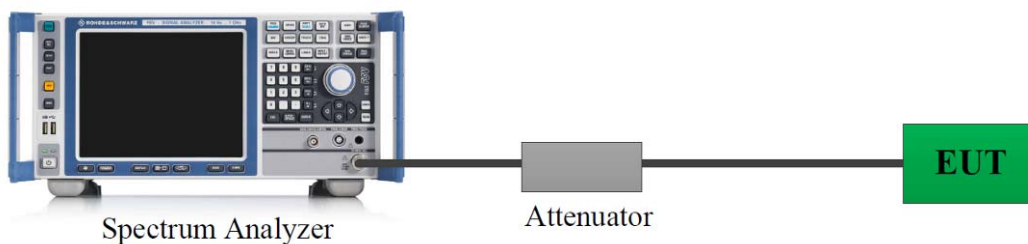

A short RF cable with low cable loss connected to the EUT antenna port, which was provided by manufacturer.

#### 4.3.3 Test Procedure

According to ANSI C63.10-2013 Section 11.8

- a) Set RBW = 100 kHz.
- b) Set the video bandwidth (VBW)  $\geq 3 \times$  RBW.
- c) Detector = Peak.
- d) Trace mode = max hold.
- e) Sweep = auto couple.
- f) Allow the trace to stabilize.
- g) Measure the maximum width of the emission that is constrained by the frequencies associated with the two outermost amplitude points (upper and lower frequencies) that are attenuated by 6 dB relative to the maximum level measured in the fundamental emission.

#### 4.3.4 Test Result

Please refer to section 5.3.

## 4.4 99% Occupied Bandwidth

### 4.4.1 Applicable Standard

RSS-Gen Clause 6.7

The occupied bandwidth or the “99% emission bandwidth” is defined as the frequency range between two points, one above and the other below the carrier frequency, within which 99% of the total transmitted power of the fundamental transmitted emission is contained. The occupied bandwidth shall be reported for all equipment in addition to the specified bandwidth required in the applicable RSSs. In some cases, the “x dB bandwidth” is required, which is defined as the frequency range between two points, one at the lowest frequency below and one at the highest frequency above the carrier frequency, at which the maximum power level of the transmitted emission is attenuated x dB below the maximum in-band power level of the modulated signal, where the two points are on the outskirts of the in-band emission.

The following conditions shall be observed for measuring the occupied bandwidth and x dB bandwidth: The transmitter shall be operated at its maximum carrier power measured under normal test conditions. The span of the spectrum analyzer shall be set large enough to capture all products of the modulation process, including the emission skirts, around the carrier frequency, but small enough to avoid having other emissions (e.g. on adjacent channels) within the span.

The detector of the spectrum analyzer shall be set to “Sample”. However, a peak, or peak hold, may be used in place of the sampling detector since this usually produces a wider bandwidth than the actual bandwidth (worst-case measurement). Use of a peak hold (or “Max Hold”) may be necessary to determine the occupied / x dB bandwidth if the device is not transmitting continuously.

The resolution bandwidth (RBW) shall be in the range of 1% to 5% of the actual occupied / x dB bandwidth and the video bandwidth (VBW) shall not be smaller than three times the RBW value. Video averaging is not permitted.

Note: It may be necessary to repeat the measurement a few times until the RBW and VBW are in compliance with the above requirement.

For the 99% emission bandwidth, the trace data points are recovered and directly summed in linear power level terms. The recovered amplitude data points, beginning at the lowest frequency, are placed in a running sum until 0.5% of the total is reached, and that frequency recorded. The process is repeated for the highest frequency data points (starting at the highest frequency, at the right side of the span, and going down in frequency). This frequency is then recorded. The difference between the two recorded frequencies is the occupied bandwidth (or the 99% emission bandwidth).

### 4.4.2 EUT Setup

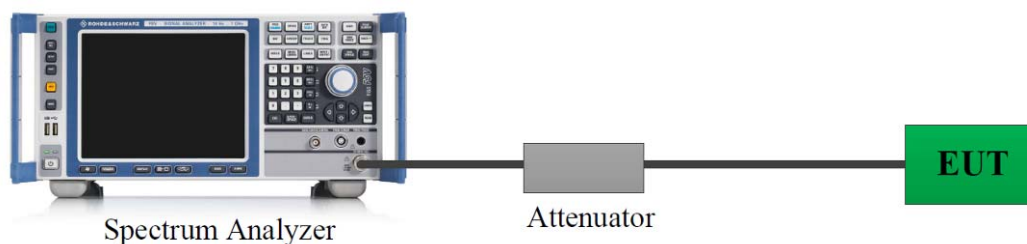

A short RF cable with low cable loss connected to the EUT antenna port, which was provided by manufacturer.

#### 4.4.3 Test Procedure

According to ANSI C63.10-2013 Section 6.9.3

The occupied bandwidth is the frequency bandwidth such that, below its lower and above its upper frequency limits, the mean powers are each equal to 0.5% of the total mean power of the given emission. The following procedure shall be used for measuring 99% power bandwidth:

- a) The instrument center frequency is set to the nominal EUT channel center frequency. The frequency span for the spectrum analyzer shall be between 1.5 times and 5.0 times the OBW.
- b) The nominal IF filter bandwidth (3 dB RBW) shall be in the range of 1% to 5% of the OBW, and VBW shall be approximately three times the RBW, unless otherwise specified by the applicable requirement.
- c) Set the reference level of the instrument as required, keeping the signal from exceeding the maximum input mixer level for linear operation. In general, the peak of the spectral envelope shall be more than  $[10 \log (\text{OBW}/\text{RBW})]$  below the reference level. Specific guidance is given in 4.1.5.2.
- d) Step a) through step c) might require iteration to adjust within the specified range.
- e) Video averaging is not permitted. Where practical, a sample detection and single sweep mode shall be used. Otherwise, peak detection and max hold mode (until the trace stabilizes) shall be used.
- f) Use the 99% power bandwidth function of the instrument (if available) and report the measured bandwidth.
- g) If the instrument does not have a 99% power bandwidth function, then the trace data points are recovered and directly summed in linear power terms. The recovered amplitude data points, beginning at the lowest frequency, are placed in a running sum until 0.5% of the total is reached; that frequency is recorded as the lower frequency. The process is repeated until 99.5% of the total is reached; that frequency is recorded as the upper frequency. The 99% power bandwidth is the difference between these two frequencies.
- h) The occupied bandwidth shall be reported by providing plot(s) of the measuring instrument display; the plot axes and the scale units per division shall be clearly labeled. Tabular data may be reported in addition to the plot(s).

#### 4.4.4 Test Result

Please refer to section 5.4.

## 4.5 Maximum Conducted Output Power

### 4.5.1 Applicable Standard

FCC §15.247 (b)(3)

For systems using digital modulation in the 902-928 MHz, 2400-2483.5 MHz, and 5725-5850 MHz bands: 1 Watt. As an alternative to a peak power measurement, compliance with the one Watt limit can be based on a measurement of the maximum conducted output power. Maximum Conducted Output Power is defined as the total transmit power delivered to all antennas and antenna elements averaged across all symbols in the signaling alphabet when the transmitter is operating at its maximum power control level. Power must be summed across all antennas and antenna elements. The average must not include any time intervals during which the transmitter is off or is transmitting at a reduced power level. If multiple modes of operation are possible (e.g., alternative modulation methods), the maximum conducted output power is the highest total transmit power occurring in any mode.

RSS-247 Clause 5.4 d

For DTSs employing digital modulation techniques operating in the bands 902-928 MHz and 2400-2483.5 MHz, the maximum peak conducted output power shall not exceed 1W. The e.i.r.p. shall not exceed 4 W, except as provided in section 5.4(e).

### 4.5.2 EUT Setup

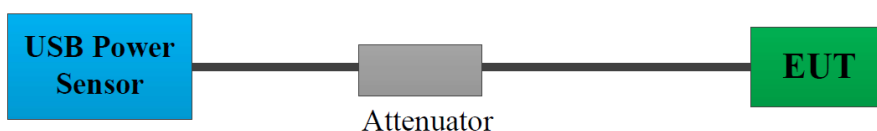

A short RF cable with low cable loss connected to the EUT antenna port, which was provided by manufacturer. The cable loss of this RF cable was offset into the setting of test equipment, which was provided by manufacturer ▲.

### 4.5.3 Test Procedure

According to ANSI C63.10-2013 Section 11.9.1.3

The maximum peak conducted output power may be measured using a broadband peak RF power meter. The power meter shall have a video bandwidth that is greater than or equal to the DTS bandwidth and shall use a fast-responding diode detector.

- a) Set the EUT in transmitting mode.
- b) Remove the antenna from the EUT and then connect a low loss RF cable from the antenna port to test equipment.
- c) Add a correction factor to the display.
- d) Set the power meter to test peak output power, record the result.

According to ANSI C63.10-2013 Section 11.9.2.3.2

Method AVGPM-G is a measurement using a gated RF average power meter.

Alternatively, measurements may be performed using a wideband gated RF power meter provided that the gate parameters are adjusted such that the power is measured only when the EUT is transmitting at its maximum power control level. Because the measurement is made only during the ON time of the transmitter, no duty cycle correction factor is required.

### 4.5.4 Test Result

Please refer to section 5.5.

## 4.6 Maximum Power Spectral Density

### 4.6.1 Applicable Standard

FCC §15.247 (e)

For digitally modulated systems, the power spectral density conducted from the intentional radiator to the antenna shall not be greater than 8 dBm in any 3 kHz band during any time interval of continuous transmission. This power spectral density shall be determined in accordance with the provisions of paragraph (b) of this section. The same method of determining the conducted output power shall be used to determine the power spectral density.

RSS-247 Clause 5.2 b

The transmitter power spectral density conducted from the transmitter to the antenna shall not be greater than 8 dBm in any 3 kHz band during any time interval of continuous transmission. This power spectral density shall be determined in accordance with the provisions of section 5.4(d), (i.e. the power spectral density shall be determined using the same method as is used to determine the conducted output power).

### 4.6.2 EUT Setup

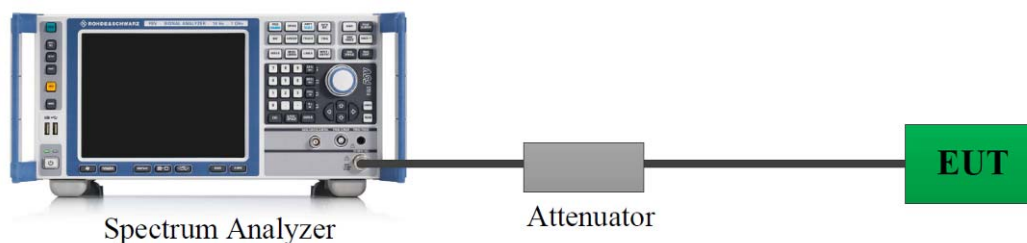

A short RF cable with low cable loss connected to the EUT antenna port, which was provided by manufacturer. The cable loss of this RF cable was offset into the setting of test equipment, which was provided by manufacturer ▲.

### 4.6.3 Test Procedure

According to ANSI C63.10-2013 Section 11.10.2

The following procedure shall be used if maximum peak conducted output power was used to determine compliance:

- a) Set analyzer center frequency to DTS channel center frequency.
- b) Set the span to 1.5 times the DTS bandwidth.
- c) Set RBW to:  $3 \text{ kHz} \leq \text{RBW} \leq 100 \text{ kHz}$ .
- d) Set VBW  $\geq [3 \times \text{RBW}]$ .
- e) Detector = peak.
- f) Sweep time = auto couple.
- g) Trace mode = max hold.
- h) Allow trace to fully stabilize.
- i) Use the peak marker function to determine the maximum amplitude level within the RBW.
- j) If measured value exceeds requirement, then reduce RBW (but no less than 3 kHz) and repeat.

### 4.6.4 Test Result

Please refer to section 5.6.

## 4.7 100 kHz Bandwidth of Frequency Band Edge

### 4.7.1 Applicable Standard

FCC §15.247 (d);

In any 100 kHz bandwidth outside the frequency band in which the spread spectrum or digitally modulated intentional radiator is operating, the radio frequency power that is produced by the intentional radiator shall be at least 20 dB below that in the 100 kHz bandwidth within the band that contains the highest level of the desired power, based on either an RF conducted or a radiated measurement, provided the transmitter demonstrates compliance with the peak conducted power limits. If the transmitter complies with the conducted power limits based on the use of RMS averaging over a time interval, as permitted under paragraph (b)(3) of this section, the attenuation required under this paragraph shall be 30 dB instead of 20 dB. Attenuation below the general limits specified in §15.209(a) is not required. In addition, radiated emissions which fall in the restricted bands, as defined in §15.205(a), must also comply with the radiated emission limits specified in §15.209(a) (see §15.205(c)).

RSS-247 Clause 5.5

In any 100 kHz bandwidth outside the frequency band in which the spread spectrum or digitally modulated device is operating, the RF power that is produced shall be at least 20 dB below that in the 100 kHz bandwidth within the band that contains the highest level of the desired power, based on either an RF conducted or a radiated measurement, provided that the transmitter demonstrates compliance with the peak conducted power limits. If the transmitter complies with the conducted power limits based on the use of root-mean-square averaging over a time interval, as permitted under section 5.4(d), the attenuation required shall be 30 dB instead of 20 dB. Attenuation below the general field strength limits specified in RSS-Gen is not required

### 4.7.2 EUT Setup

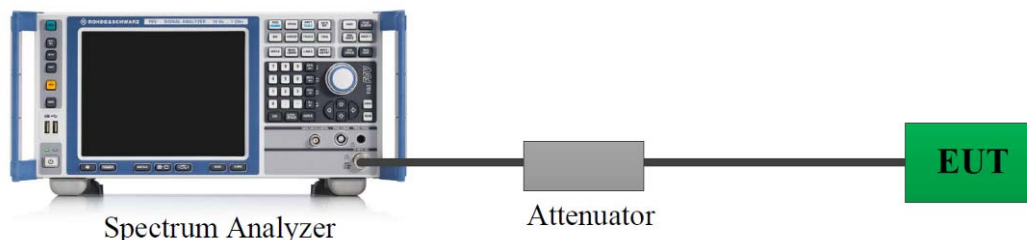

A short RF cable with low cable loss connected to the EUT antenna port, which was provided by manufacturer.

### 4.7.3 Test Procedure

According to ANSI C63.10-2013 Section 11.11

- Set the center frequency and span to encompass frequency range to be measured.
- Set the RBW = 100 kHz.
- Set the VBW  $\geq [3 \times \text{RBW}]$ .
- Detector = peak.
- Sweep time = auto couple.
- Trace mode = max hold.
- Allow trace to fully stabilize.
- Use the peak marker function to determine the maximum amplitude level.

Ensure that the amplitude of all unwanted emissions outside of the authorized frequency band (excluding restricted frequency bands) is attenuated by at least the minimum requirements specified in 11.11. Report the three highest emissions relative to the limit.

### 4.7.4 Test Result

Please refer to section 5.7.

## 4.8 Duty Cycle

### 4.8.1 EUT Setup

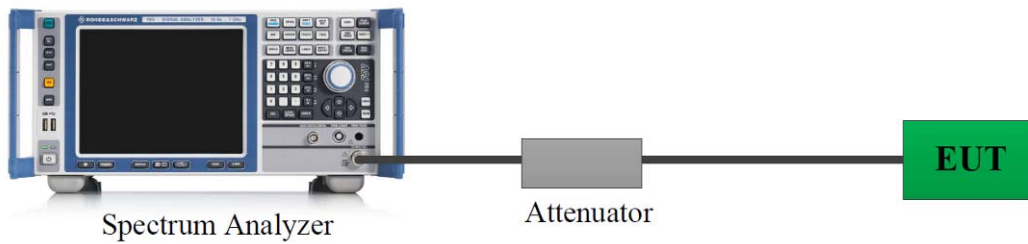

### 4.8.2 Test Procedure

According to ANSI C63.10-2013 Section 11.6

The zero-span mode on a spectrum analyzer or EMI receiver if the response time and spacing between bins on the sweep are sufficient to permit accurate measurements of the ON and OFF times of the transmitted signal:

- 1) Set the center frequency of the instrument to the center frequency of the transmission.
- 2) Set  $RBW \geq OBW$  if possible; otherwise, set RBW to the largest available value.
- 3) Set  $VBW \geq RBW$ . Set detector = peak or average.
- 4) The zero-span measurement method shall not be used unless both RBW and VBW are  $> 50/T$  and the number of sweep points across duration T exceeds 100. (For example, if VBW and/or RBW are limited to 3 MHz, then the zero-span method of measuring the duty cycle shall not be used if  $T \leq 16.7 \mu s$ .)

### 4.8.3 Judgment

Report Only. Please refer to section 5.8.



## 4.9 Antenna Requirement

### 4.9.1 Applicable Standard

FCC §15.203

An intentional radiator shall be designed to ensure that no antenna other than that furnished by the responsible party shall be used with the device. The use of a permanently attached antenna or of an antenna that uses a unique coupling to the intentional radiator shall be considered sufficient to comply with the provisions of this section. The manufacturer may design the unit so that a broken antenna can be replaced by the user, but the use of a standard antenna jack or electrical connector is prohibited. This requirement does not apply to carrier current devices or to devices operated under the provisions of §§15.211, 15.213, 15.217, 15.219, 15.221, or §15.236. Further, this requirement does not apply to intentional radiators that must be professionally installed, such as perimeter protection systems and some field disturbance sensors, or to other intentional radiators which, in accordance with §15.31(d), must be measured at the installation site. However, the installer shall be responsible for ensuring that the proper antenna is employed so that the limits in this part are not exceeded.

RSS-GEN Clause 6.8

The applicant for equipment certification shall provide a list of all antenna types that may be used with the transmitter, where applicable (i.e. for transmitters with detachable antenna), indicating the maximum permissible antenna gain (in dBi) and the required impedance for each antenna. The test report shall demonstrate the compliance of the transmitter with the limit for maximum equivalent isotropically radiated power (e.i.r.p.) specified in the applicable RSS, when the transmitter is equipped with any antenna type, selected from this list.

For expediting the testing, measurements may be performed using only the antenna with highest gain of each combination of transmitter and antenna type, with the transmitter output power set at the maximum level. However, the transmitter shall comply with the applicable requirements under all operational conditions and when in combination with any type of antenna from the list provided in the test report (and in the notice to be included in the user manual, provided below). When measurements at the antenna port are used to determine the RF output power, the effective gain of the device's antenna shall be stated, based on a measurement or on data from the antenna's manufacturer.

The test report shall state the RF power, output power setting and spurious emission measurements with each antenna type that is used with the transmitter being tested.

For licence-exempt equipment with detachable antennas, the user manual shall also contain the following notice in a conspicuous location:

This radio transmitter [enter the device's ISED certification number] has been approved by Innovation, Science and Economic Development Canada to operate with the antenna types listed below, with the maximum permissible gain indicated. Antenna types not included in this list that have a gain greater than the maximum gain indicated for any type listed are strictly prohibited for use with this device.

Immediately following the above notice, the manufacturer shall provide a list of all antenna types which can be used with the transmitter, indicating the maximum permissible antenna gain (in dBi) and the required impedance for each antenna type.

### 4.9.2 Judgment

**Compliant.** Please refer to the Antenna Information detail in Section 1.

## 5. Test DATA AND RESULTS

### 5.1 AC Line Conducted Emissions

Serial Number:	2HNF-3	Test Date:	2024/2/23
Test Site:	CE	Test Mode:	Transmitting
Tester:	Lane Sun	Test Result:	Pass

#### Environmental Conditions:

Temperature: (°C)	23.6	Relative Humidity: (%)	51	ATM Pressure: (kPa)	101.5
----------------------	------	------------------------------	----	------------------------	-------

#### Test Equipment List and Details:

Manufacturer	Description	Model	Serial Number	Calibration Date	Calibration Due Date
R&S	LISN	ENV216	101614	2023/10/18	2024/10/17
MICRO-COAX	Coaxial Cable	C-NJNJ-50	C-0200-01	2023/9/5	2024/9/4
R&S	EMI Test Receiver	ESCI	100035	2023/8/18	2024/8/17
R&S	Test Software	EMC32	V9.10.00	N/A	N/A

\* Statement of Traceability: Bay Area Compliance Laboratories Corp. (Dongguan) attests that all calibrations have been performed, traceable to National Primary Standards and International System of Units (SI).

Project No: XMDN240205-07900E-RF  
 Test Engineer: Lane Sun  
 Test Date: 2024/2/23  
 Port: L  
 Test Mode: Transmitting  
 Power Source: AC 120V/60Hz  
 Note: 802.11n ht20 middle channel

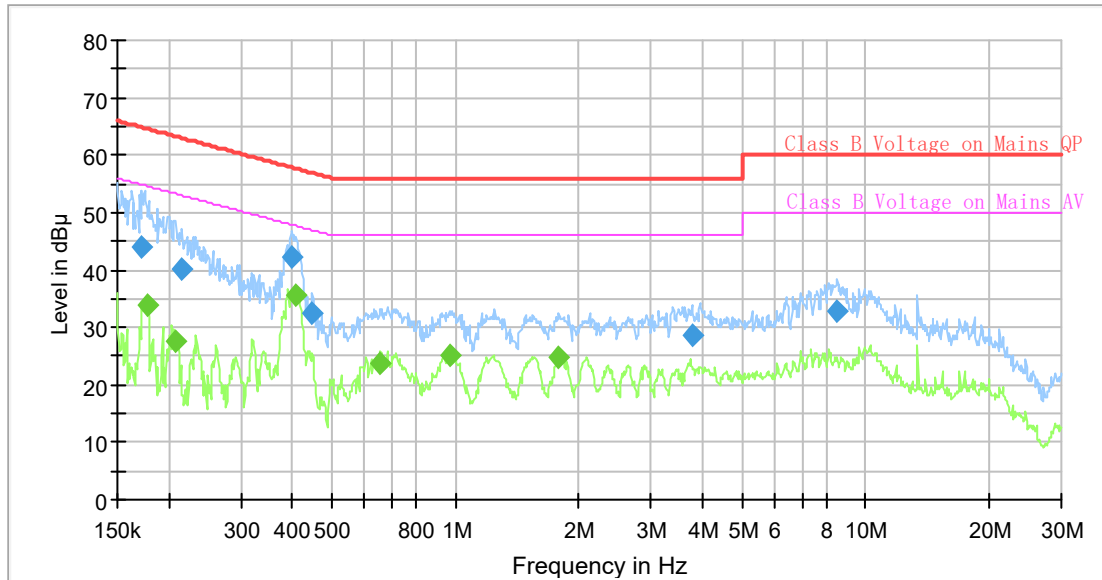

### Final Result

Frequency (MHz)	QuasiPeak (dB μV)	Average (dB μV)	Limit (dB μV)	Margin (dB)	Bandwidth (kHz)	Line	Corr. (dB)
0.171623	43.85	---	64.88	21.03	9.000	L1	10.8
0.177720	---	33.84	54.59	20.75	9.000	L1	10.8
0.208474	---	27.73	53.27	25.54	9.000	L1	10.8
0.215881	40.08	---	62.98	22.90	9.000	L1	10.8
0.400687	42.29	---	57.84	15.55	9.000	L1	10.8
0.406728	---	35.56	47.71	12.15	9.000	L1	10.8
0.447156	32.51	---	56.93	24.42	9.000	L1	10.8
0.656516	---	23.77	46.00	22.23	9.000	L1	10.8
0.973564	---	25.06	46.00	20.94	9.000	L1	10.9
1.789056	---	24.84	46.00	21.16	9.000	L1	10.8
3.780360	28.79	---	56.00	27.21	9.000	L1	10.8
8.523173	32.74	---	60.00	27.26	9.000	L1	10.8

Project No: XMDN240205-07900E-RF  
 Test Engineer: Lane Sun  
 Test Date: 2024/2/23  
 Port: N  
 Test Mode: Transmitting  
 Power Source: AC 120V/60Hz  
 Note: 802.11n ht20 middle channel

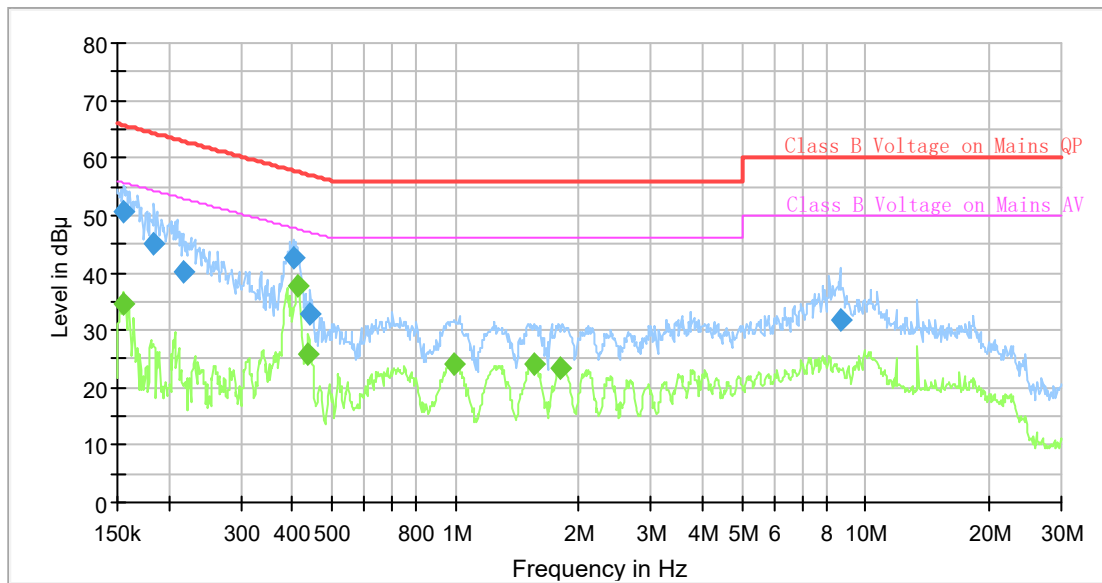

### Final Result

Frequency (MHz)	QuasiPeak (dB μV)	Average (dB μV)	Limit (dB μV)	Margin (dB)	Bandwidth (kHz)	Line	Corr. (dB)
0.154557	---	34.75	55.75	21.00	9.000	N	10.9
0.155329	50.62	---	65.71	15.09	9.000	N	10.9
0.184035	45.18	---	64.30	19.12	9.000	N	10.9
0.216960	40.10	---	62.93	22.83	9.000	N	10.8
0.402691	42.53	---	57.80	15.27	9.000	N	10.8
0.412859	---	37.66	47.59	9.93	9.000	N	10.8
0.438323	---	25.86	47.09	21.23	9.000	N	10.8
0.442717	32.68	---	57.01	24.33	9.000	N	10.8
0.998148	---	23.95	46.00	22.05	9.000	N	10.8
1.555873	---	24.17	46.00	21.83	9.000	N	10.9
1.798001	---	23.46	46.00	22.54	9.000	N	10.9
8.694919	31.73	---	60.00	28.27	9.000	N	10.8

### 5.2 Radiation Spurious Emissions

Serial Number:	2HNF-1, 2HNF-3	Test Date:	Below 1GHz: 2024/3/2 Above 1GHz: 2024/3/1
Test Site:	Chamber 10m, Chamber B	Test Mode:	Transmitting
Tester:	Leesin Xiang, Colin Yang	Test Result:	Pass

<b>Environmental Conditions:</b>					
Temperature: (°C)	19.6~19.9	Relative Humidity: (%)	46~51	ATM Pressure: (kPa)	101.6~101.8

#### Test Equipment List and Details:

Manufacturer	Description	Model	Serial Number	Calibration Date	Calibration Due Date
9kHz~1000MHz					
EMCO	Passive Loop Antenna	6512	9706-1206	2023/10/21	2024/10/20
Sunol Sciences	Hybrid Antenna	JB3	A060611-1	2023/9/6	2024/9/5
Narda	Attenuator	779-6dB	04269	2023/9/6	2024/9/5
Unknown	Coaxial Cable	C-NJNJ-50	C-1000-01	2023/8/1	2024/7/31
Unknown	Coaxial Cable	C-NJNJ-50	C-0400-04	2023/8/1	2024/7/31
Unknown	Coaxial Cable	C-NJNJ-50	C-0530-01	2023/8/1	2024/7/31
Sonoma	Amplifier	310N	185914	2023/8/1	2024/7/31
R&S	EMI Test Receiver	ESCI	100224	2023/8/18	2024/8/17
Farad	Test Software	EZ-EMC	V1.1.4.2	N/A	N/A
Above 1GHz					
ETS-Lindgren	Horn Antenna	3115	000 527 35	2023/9/7	2024/9/6
Ducommun Technologies	Horn Antenna	ARH-4223-02	1007726-02 1304	2023/2/22	2026/2/21
Xinhang Macrowave	Coaxial Cable	XH750A-N/J-SMA/J-10M	20231117004 #0001	2023/11/17	2024/11/16
Xinhang Macrowave	Coaxial Cable	XH360A-2.92/J-2.92/J-6M-A	20231208001 #0001	2023/12/11	2024/12/10
AH	Preamplifier	PAM-0118P	469	2023/8/19	2024/8/18
AH	Preamplifier	PAM-1840VH	191	2023/9/7	2024/9/6
R&S	Spectrum Analyzer	FSV40	101944	2023/10/18	2024/10/17
Audix	Test Software	E3	191218 (V9)	N/A	N/A
E-Microwave	Band Rejection Filter	OBSF-2400-2483.5-S	OE01601525	2023/6/16	2024/6/15
Micro-tronics	High Pass Filter	HPM50111	G217	2023/12/1	2024/11/30

\* Statement of Traceability: Bay Area Compliance Laboratories Corp. (Dongguan) attests that all calibrations have been performed, traceable to National Primary Standards and International System of Units (SI).

#### Test Data:

Please refer to the below table and plots.

**1) 9kHz~30MHz**

802.11n ht20 middle channel was tested. The amplitude of spurious emissions attenuated more than 20 dB below the permissible value is not required to be report.

2) 30MHz-1GHz

Project No: XMDN240205-07900E-RF  
 Test Engineer: Leesin Xiang  
 Test Date: 2024/3/2  
 Polarization: Horizontal  
 Test Mode: Transmitting  
 Power Source: AC 120V/60Hz  
 Note: 802.11n ht20 middle channel

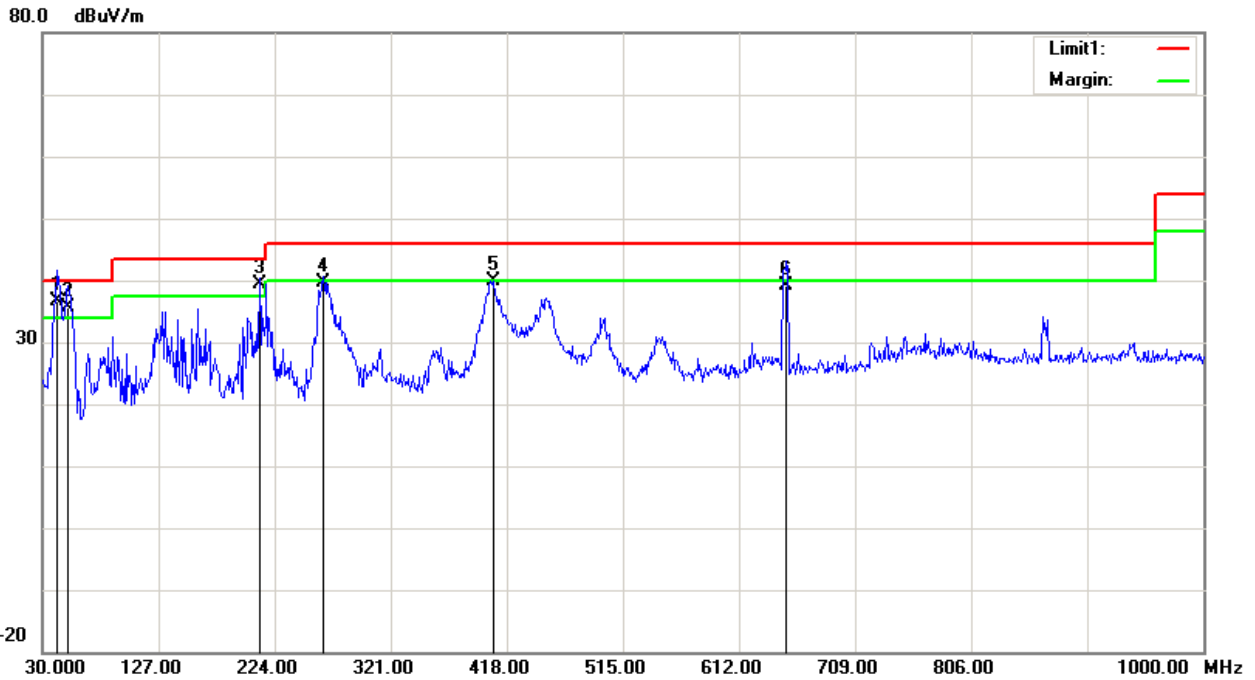

No.	Frequency (MHz)	Reading (dBuV)	Detector	Factor (dB/m)	Result (dBuV/m)	Limit (dBuV/m)	Margin (dB)
1	42.6100	49.30	QP	-12.70	36.60	40.00	3.40
2	51.3400	52.15	QP	-16.45	35.70	40.00	4.30
3	211.3900	51.89	QP	-12.59	39.30	43.50	4.20
4	264.7400	50.09	QP	-10.49	39.60	46.00	6.40
5	406.3600	46.60	peak	-6.73	39.87	46.00	6.13
6	651.7700	41.10	QP	-1.90	39.20	46.00	6.80

Project No: XMDN240205-07900E-RF  
 Test Engineer: Leesin Xiang  
 Test Date: 2024/3/2  
 Polarization: Vertical  
 Test Mode: Transmitting  
 Power Source: AC 120V/60Hz  
 Note: 802.11n ht20 middle channel

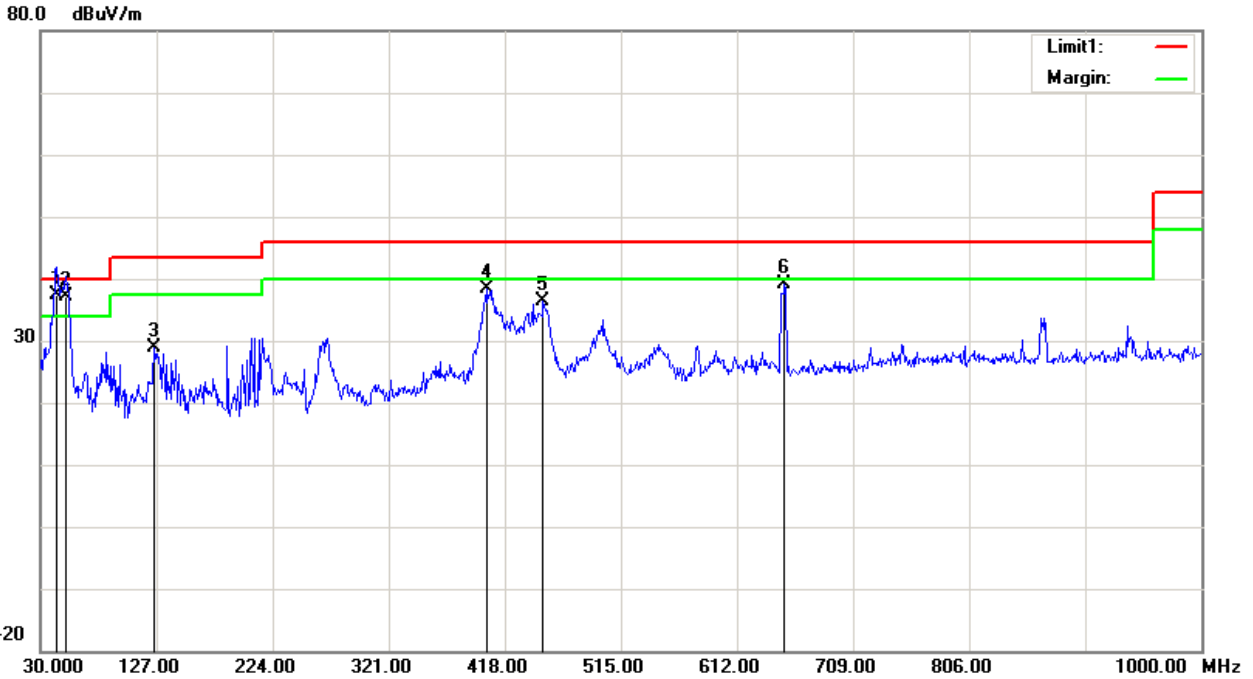

No.	Frequency (MHz)	Reading (dBuV)	Detector	Factor (dB/m)	Result (dBuV/m)	Limit (dBuV/m)	Margin (dB)
1	43.5800	50.78	QP	-13.38	37.40	40.00	2.60
2	51.3400	53.65	QP	-16.45	37.20	40.00	2.80
3	125.0600	38.44	peak	-9.61	28.83	43.50	14.67
4	403.4500	45.17	peak	-6.83	38.34	46.00	7.66
5	450.0100	41.81	peak	-5.47	36.34	46.00	9.66
6	651.7700	41.02	peak	-1.90	39.12	46.00	6.88



3) 1-18GHz:

802.11b mode, Low Channel, Horizontal

Project No.: XMDN240205-07900E-RF  
 Polarization: Horizontal  
 Test Mode: Transmitting  
 Note: 802.11b\_low channel 2412MHz

Serial No.: 2HMF-1  
 Tester: Colin Yang

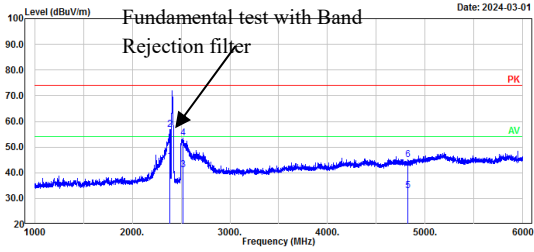

No.	Frequency (MHz)	Reading (dBuV)	Factor (dB/m)	Result (dBuV/m)	Limit (dBuV/m)	Margin (dB)	Detector
1	2386.00	52.16	-7.85	44.31	54.00	9.69	Average
2	2386.00	64.77	-7.85	56.92	74.00	17.08	Peak
3	2521.00	48.76	-7.56	41.20	54.00	12.80	Average
4	2521.00	61.17	-7.56	53.61	74.00	20.39	Peak
5	4824.00	36.07	-2.98	33.09	54.00	20.91	Average
6	4824.00	48.00	-2.98	45.02	74.00	28.98	Peak

802.11b mode, Low Channel, Vertical

Project No.: XMDN240205-07900E-RF  
 Polarization: Vertical  
 Test Mode: Transmitting  
 Note: 802.11b\_low channel 2412MHz

Serial No.: 2HMF-1  
 Tester: Colin Yang

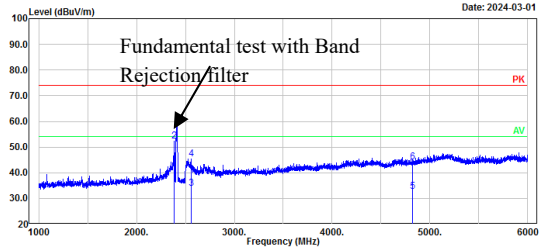

No.	Frequency (MHz)	Reading (dBuV)	Factor (dB/m)	Result (dBuV/m)	Limit (dBuV/m)	Margin (dB)	Detector
1	2387.00	47.35	-7.84	39.51	54.00	14.49	Average
2	2387.00	69.00	-7.84	61.16	74.00	12.84	Peak
3	2560.00	41.28	-7.52	33.76	54.00	20.24	Average
4	2560.00	53.03	-7.52	45.51	74.00	28.49	Peak
5	4824.00	35.55	-2.98	32.57	54.00	21.43	Average
6	4824.00	47.19	-2.98	44.21	74.00	29.79	Peak

Project No.: XMDN240205-07900E-RF  
 Polarization: Horizontal  
 Test Mode: Transmitting  
 Note: 802.11b\_low channel 2412MHz

Serial No.: 2HMF-1  
 Tester: Colin Yang

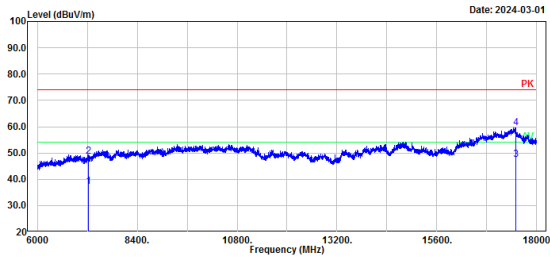

No.	Frequency (MHz)	Reading (dBuV)	Factor (dB/m)	Result (dBuV/m)	Limit (dBuV/m)	Margin (dB)	Detector
1	7236.00	35.42	1.79	37.21	54.00	16.79	Average
2	7236.00	46.85	1.79	48.64	74.00	25.36	Peak
3	17488.80	31.74	15.78	47.52	54.00	6.48	Average
4	17488.80	43.78	15.78	59.56	74.00	14.44	Peak

Project No.: XMDN240205-07900E-RF  
 Polarization: Vertical  
 Test Mode: Transmitting  
 Note: 802.11b\_low channel 2412MHz

Serial No.: 2HMF-1  
 Tester: Colin Yang

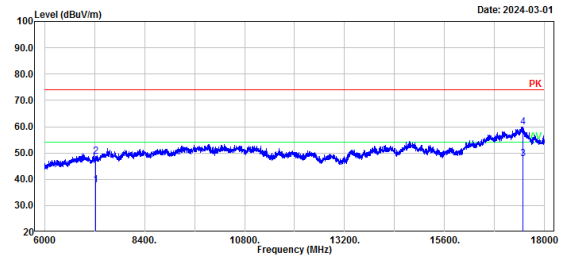

No.	Frequency (MHz)	Reading (dBuV)	Factor (dB/m)	Result (dBuV/m)	Limit (dBuV/m)	Margin (dB)	Detector
1	7236.00	36.12	1.79	37.91	54.00	16.09	Average
2	7236.00	46.89	1.79	48.68	74.00	25.32	Peak
3	17479.20	32.13	15.70	47.83	54.00	6.17	Average
4	17479.20	44.27	15.70	59.97	74.00	14.03	Peak

802.11b mode, Low Channel, Bandedge, Horizontal

Project No.: XMDN240205-07900E-RF  
 Polarization: Horizontal  
 Test Mode: Transmitting  
 Note: 802.11b\_low channel 2412MHz

Serial No.: 2HNF-1  
 Tester: Colin Yang

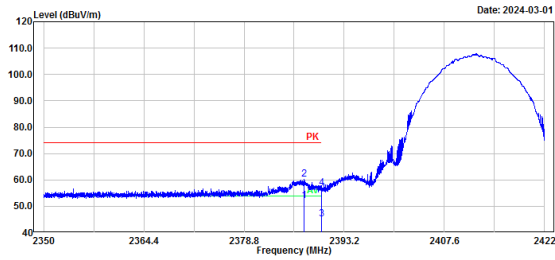

No.	Frequency (MHz)	Reading (dBuV)	Factor (dB/m)	Result (dBuV/m)	Limit (dBuV/m)	Margin (dB)	Detector
1	2387.41	23.43	28.56	51.99	54.00	2.01	Average
2	2387.41	31.53	28.56	60.09	74.00	13.91	Peak
3	2390.00	16.45	28.57	45.02	54.00	8.98	Average
4	2390.00	28.44	28.57	57.01	74.00	16.99	Peak

802.11b mode, Low Channel, Bandedge, Vertical

Project No.: XMDN240205-07900E-RF  
 Polarization: Vertical  
 Test Mode: Transmitting  
 Note: 802.11b\_low channel 2412MHz

Serial No.: 2HNF-1  
 Tester: Colin Yang

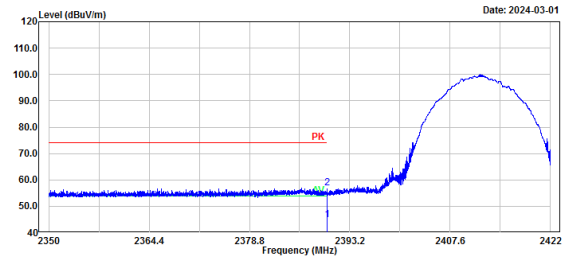

No.	Frequency (MHz)	Reading (dBuV)	Factor (dB/m)	Result (dBuV/m)	Limit (dBuV/m)	Margin (dB)	Detector
1	2390.00	16.24	28.57	44.81	54.00	9.19	Average
2	2390.00	28.38	28.57	56.95	74.00	17.05	Peak

802.11b mode, Middle Channel, Horizontal

Project No.: XMDN240205-07900E-RF  
 Polarization: Horizontal  
 Test Mode: Transmitting  
 Note: 802.11b\_middle channel 2437MHz

Serial No.: 2HNF-1  
 Tester: Colin Yang

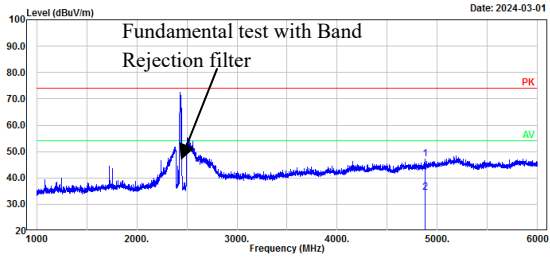

No.	Frequency (MHz)	Reading (dBuV)	Factor (dB/m)	Result (dBuV/m)	Limit (dBuV/m)	Margin (dB)	Detector
1	4874.00	49.85	-2.77	47.08	74.00	26.92	Peak
2	4874.00	37.19	-2.77	34.42	54.00	19.58	Average

802.11b mode, Middle Channel, Vertical

Project No.: XMDN240205-07900E-RF  
 Polarization: Vertical  
 Test Mode: Transmitting  
 Note: 802.11b\_middle channel 2437MHz

Serial No.: 2HNF-1  
 Tester: Colin Yang

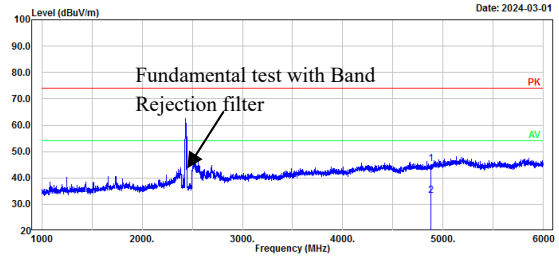

No.	Frequency (MHz)	Reading (dBuV)	Factor (dB/m)	Result (dBuV/m)	Limit (dBuV/m)	Margin (dB)	Detector
1	4874.00	48.20	-2.77	45.43	74.00	28.57	Peak
2	4874.00	36.15	-2.77	33.38	54.00	20.62	Average

Project No.: XMDN240205-07900E-RF  
 Polarization: Horizontal  
 Test Mode: Transmitting  
 Note: 802.11b\_middle channel 2437MHz

Serial No.: 2HNF-1  
 Tester: Colin Yang

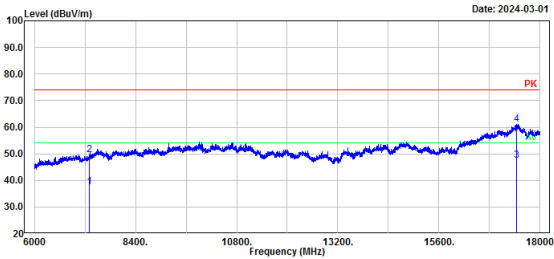

No.	Frequency (MHz)	Reading (dBuV)	Factor (dB/m)	Result (dBuV/m)	Limit (dBuV/m)	Margin (dB)	Detector
1	7311.00	35.42	2.08	37.50	54.00	16.50	Average
2	7311.00	47.36	2.08	49.44	74.00	24.56	Peak
3	17431.20	32.17	15.33	47.50	54.00	6.50	Average
4	17431.20	45.84	15.33	61.17	74.00	12.83	Peak

Project No.: XMDN240205-07900E-RF  
 Polarization: Vertical  
 Test Mode: Transmitting  
 Note: 802.11b\_middle channel 2437MHz

Serial No.: 2HNF-1  
 Tester: Colin Yang

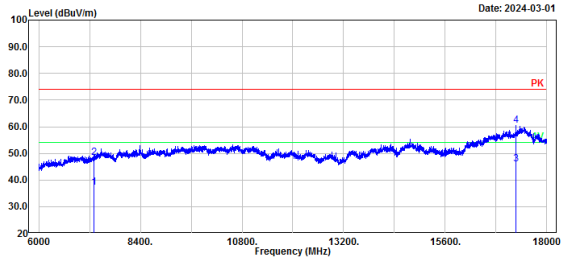

No.	Frequency (MHz)	Reading (dBuV)	Factor (dB/m)	Result (dBuV/m)	Limit (dBuV/m)	Margin (dB)	Detector
1	7311.00	35.12	2.08	37.20	54.00	16.80	Average
2	7311.00	46.22	2.08	48.30	74.00	25.70	Peak
3	17272.80	32.04	14.03	46.07	54.00	7.93	Average
4	17272.80	46.43	14.03	60.46	74.00	13.54	Peak

802.11b mode, High Channel, Horizontal

Project No.: XMDN240205-07900E-RF  
 Polarization: Horizontal  
 Test Mode: Transmitting  
 Note: 802.11b\_high channel 2462MHz

Serial No.: 2HNF-1  
 Tester: Colin Yang

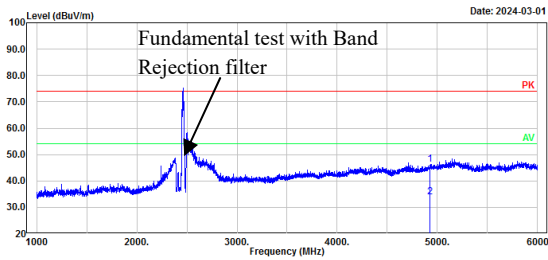

No.	Frequency (MHz)	Reading (dBuV)	Factor (dB/m)	Result (dBuV/m)	Limit (dBuV/m)	Margin (dB)	Detector
1	4924.00	48.83	-2.53	46.30	74.00	27.70	Peak
2	4924.00	36.28	-2.53	33.75	54.00	20.25	Average

802.11b mode, High Channel, Vertical

Project No.: XMDN240205-07900E-RF  
 Polarization: Vertical  
 Test Mode: Transmitting  
 Note: 802.11b\_high channel 2462MHz

Serial No.: 2HNF-1  
 Tester: Colin Yang

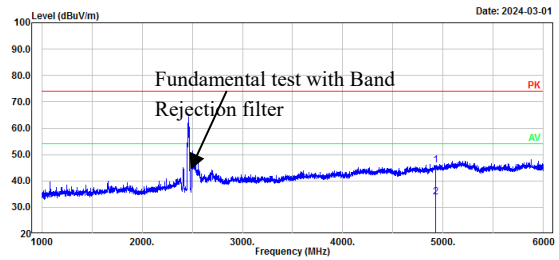

No.	Frequency (MHz)	Reading (dBuV)	Factor (dB/m)	Result (dBuV/m)	Limit (dBuV/m)	Margin (dB)	Detector
1	4924.00	48.38	-2.53	45.85	74.00	28.15	Peak
2	4924.00	36.49	-2.53	33.96	54.00	20.04	Average

Project No.: XMDN240205-07900E-RF  
 Polarization: Horizontal  
 Test Mode: Transmitting  
 Note: 802.11b\_high channel 2462MHz

Serial No.: 2HNF-1  
 Tester: Colin Yang

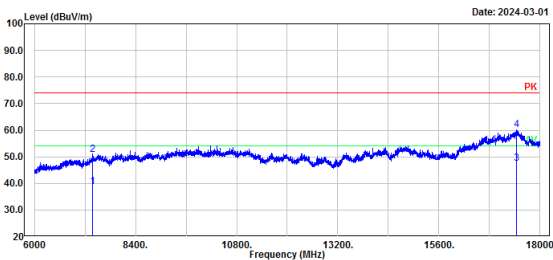

No.	Frequency (MHz)	Reading (dBuV)	Factor (dB/m)	Result (dBuV/m)	Limit (dBuV/m)	Margin (dB)	Detector
1	7386.00	36.49	2.25	38.74	54.00	15.26	Average
2	7386.00	48.43	2.25	50.68	74.00	23.32	Peak
3	17445.60	32.07	15.44	47.51	54.00	6.49	Average
4	17445.60	44.62	15.44	60.06	74.00	13.94	Peak

Project No.: XMDN240205-07900E-RF  
 Polarization: Vertical  
 Test Mode: Transmitting  
 Note: 802.11b\_high channel 2462MHz

Serial No.: 2HNF-1  
 Tester: Colin Yang

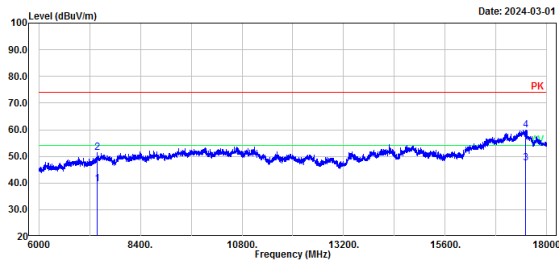

No.	Frequency (MHz)	Reading (dBuV)	Factor (dB/m)	Result (dBuV/m)	Limit (dBuV/m)	Margin (dB)	Detector
1	7386.00	37.25	2.25	39.50	54.00	14.50	Average
2	7386.00	49.03	2.25	51.28	74.00	22.72	Peak
3	17503.20	31.69	15.88	47.57	54.00	6.43	Average
4	17503.20	44.02	15.88	59.90	74.00	14.10	Peak

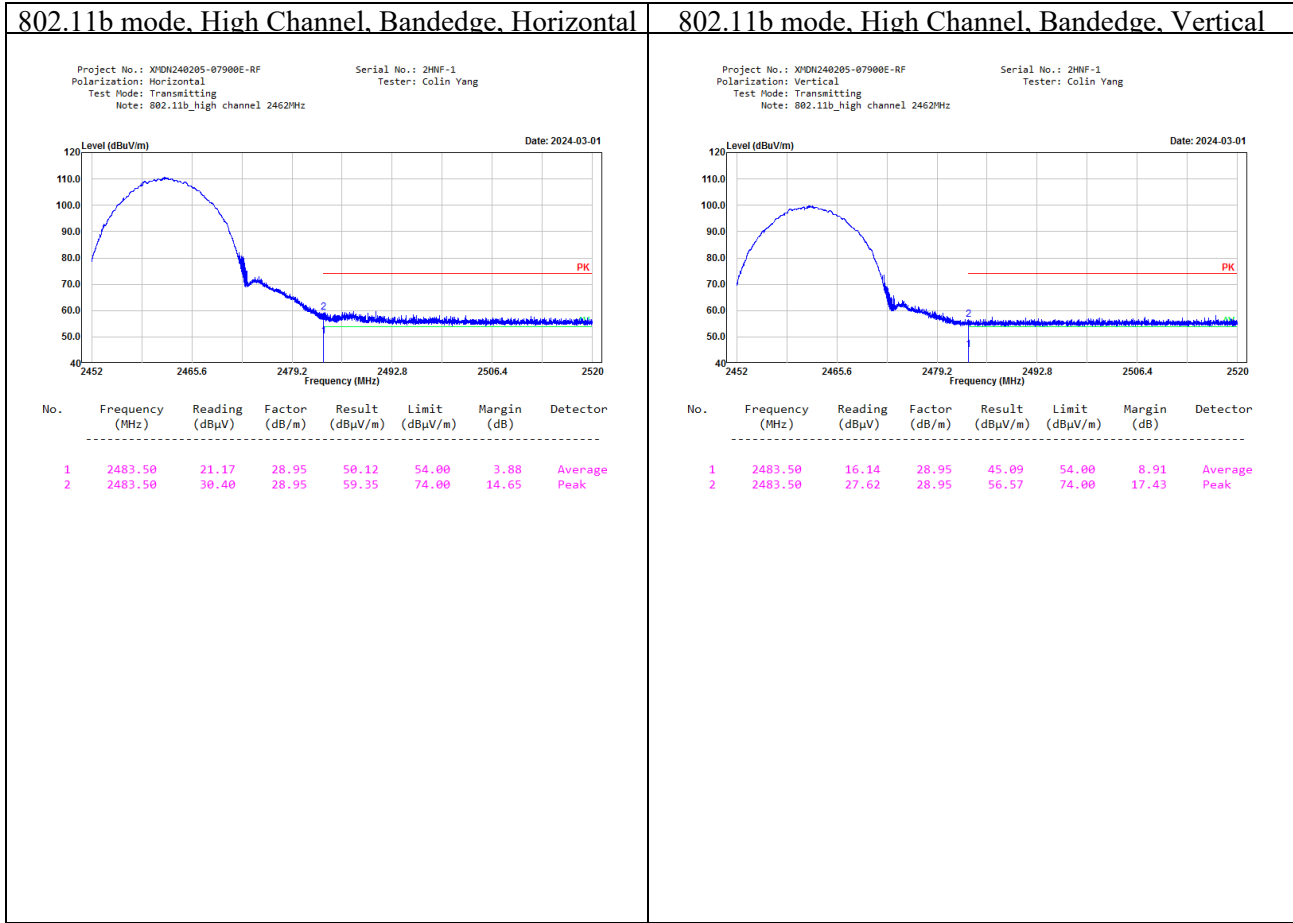

802.11g mode, Low Channel, Horizontal

Project No.: XMDN240205-07900E-RF  
 Polarization: Horizontal  
 Test Mode: Transmitting  
 Note: 802.11g\_low channel 2412MHz

Serial No.: 2MHF-1  
 Tester: Colin Yang

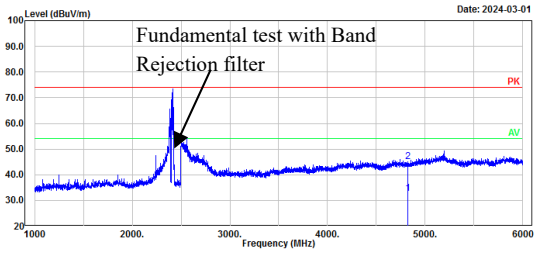

No.	Frequency (MHz)	Reading (dBuV)	Factor (dB/m)	Result (dBuV/m)	Limit (dBuV/m)	Margin (dB)	Detector
1	4824.00	35.63	-2.98	32.65	54.00	21.35	Average
2	4824.00	47.91	-2.98	44.93	74.00	29.07	Peak

802.11g mode, Low Channel, Vertical

Project No.: XMDN240205-07900E-RF  
 Polarization: Vertical  
 Test Mode: Transmitting  
 Note: 802.11g\_low channel 2412MHz

Serial No.: 2MHF-1  
 Tester: Colin Yang

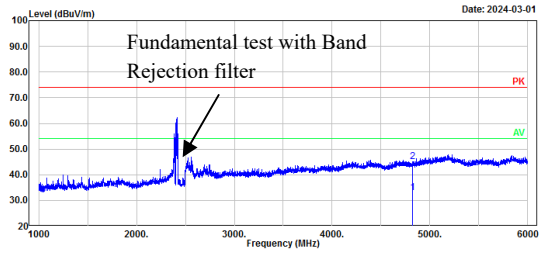

No.	Frequency (MHz)	Reading (dBuV)	Factor (dB/m)	Result (dBuV/m)	Limit (dBuV/m)	Margin (dB)	Detector
1	4824.00	36.03	-2.98	33.05	54.00	20.95	Average
2	4824.00	48.11	-2.98	45.13	74.00	28.87	Peak

Project No.: XMDN240205-07900E-RF  
 Polarization: Horizontal  
 Test Mode: Transmitting  
 Note: 802.11g\_low channel 2412MHz

Serial No.: 2MHF-1  
 Tester: Colin Yang

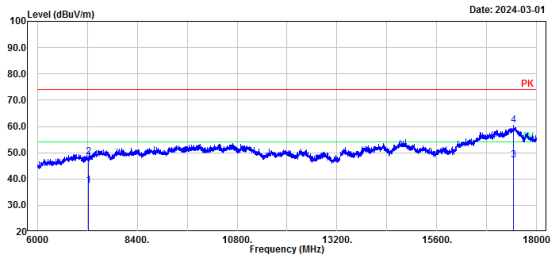

No.	Frequency (MHz)	Reading (dBuV)	Factor (dB/m)	Result (dBuV/m)	Limit (dBuV/m)	Margin (dB)	Detector
1	7236.00	35.74	1.79	37.53	54.00	16.47	Average
2	7236.00	46.71	1.79	48.50	74.00	25.50	Peak
3	17436.00	31.89	15.36	47.25	54.00	6.75	Average
4	17436.00	45.18	15.36	60.54	74.00	13.46	Peak

Project No.: XMDN240205-07900E-RF  
 Polarization: Vertical  
 Test Mode: Transmitting  
 Note: 802.11g\_low channel 2412MHz

Serial No.: 2MHF-1  
 Tester: Colin Yang

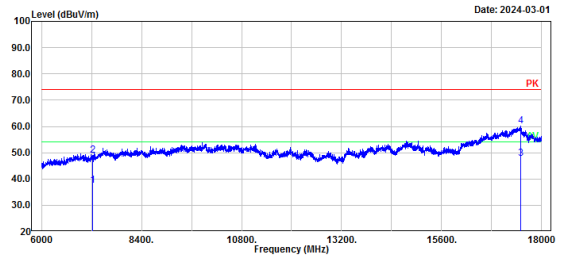

No.	Frequency (MHz)	Reading (dBuV)	Factor (dB/m)	Result (dBuV/m)	Limit (dBuV/m)	Margin (dB)	Detector
1	7236.00	35.69	1.79	37.48	54.00	16.52	Average
2	7236.00	47.24	1.79	49.03	74.00	24.97	Peak
3	17500.00	31.77	15.87	47.64	54.00	6.36	Average
4	17500.00	44.42	15.87	60.29	74.00	13.71	Peak

802.11g mode, Low Channel, Bandedge, Horizontal

Project No.: XMDN240205-07900E-RF  
 Polarization: Horizontal  
 Test Mode: Transmitting  
 Note: 802.11g\_low channel 2412MHz  
 Serial No.: 2HNF-1  
 Tester: Colin Yang

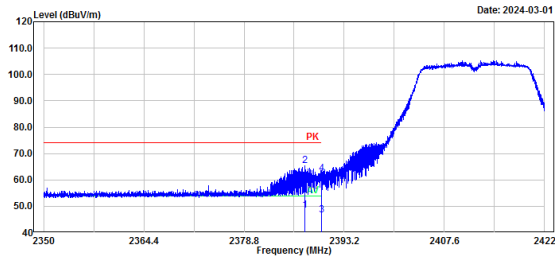

No.	Frequency (MHz)	Reading (dBuV)	Factor (dB/m)	Result (dBuV/m)	Limit (dBuV/m)	Margin (dB)	Detector
1	2387.54	19.75	28.56	48.31	54.00	5.69	Average
2	2387.54	36.92	28.56	65.48	74.00	8.52	Peak
3	2390.00	18.21	28.57	46.78	54.00	7.22	Average
4	2390.00	33.78	28.57	62.35	74.00	11.65	Peak

802.11g mode, Low Channel, Bandedge, Vertical

Project No.: XMDN240205-07900E-RF  
 Polarization: Vertical  
 Test Mode: Transmitting  
 Note: 802.11g\_low channel 2412MHz  
 Serial No.: 2HNF-1  
 Tester: Colin Yang

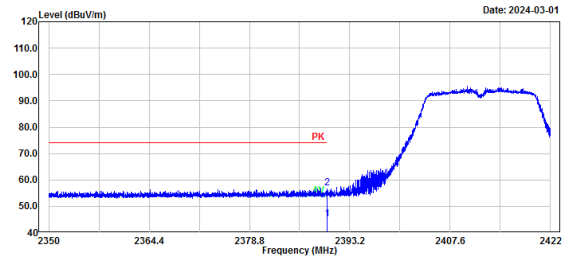

No.	Frequency (MHz)	Reading (dBuV)	Factor (dB/m)	Result (dBuV/m)	Limit (dBuV/m)	Margin (dB)	Detector
1	2390.00	16.47	28.57	45.04	54.00	8.96	Average
2	2390.00	28.39	28.57	56.96	74.00	17.04	Peak

802.11g mode, Middle Channel, Horizontal

Project No.: XMDN240205-07900E-RF  
 Polarization: Horizontal  
 Test Mode: Transmitting  
 Note: 802.11g\_middle channel 2437MHz  
 Serial No.: 2HNF-1  
 Tester: Colin Yang

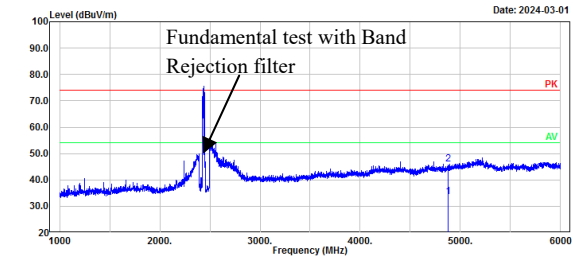

No.	Frequency (MHz)	Reading (dBuV)	Factor (dB/m)	Result (dBuV/m)	Limit (dBuV/m)	Margin (dB)	Detector
1	4874.00	36.33	-2.77	33.56	54.00	20.44	Average
2	4874.00	48.71	-2.77	45.94	74.00	28.06	Peak

802.11g mode, Middle Channel, Vertical

Project No.: XMDN240205-07900E-RF  
 Polarization: Vertical  
 Test Mode: Transmitting  
 Note: 802.11g\_middle channel 2437MHz  
 Serial No.: 2HNF-1  
 Tester: Colin Yang

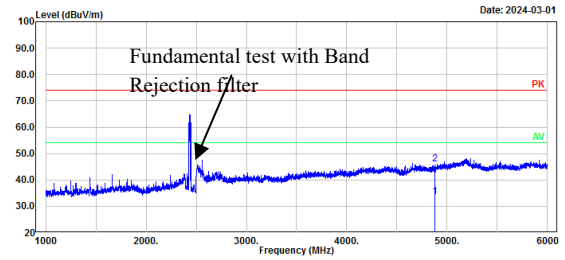

No.	Frequency (MHz)	Reading (dBuV)	Factor (dB/m)	Result (dBuV/m)	Limit (dBuV/m)	Margin (dB)	Detector
1	4874.00	36.25	-2.77	33.48	54.00	20.52	Average
2	4874.00	48.75	-2.77	45.98	74.00	28.02	Peak

Project No.: XMDN240205-07900E-RF  
 Polarization: Horizontal  
 Test Mode: Transmitting  
 Note: 802.11g\_middle channel 2437MHz  
 Serial No.: 2HNF-1  
 Tester: Colin Yang

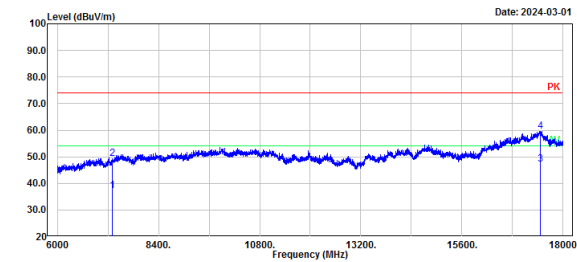

No.	Frequency (MHz)	Reading (dBuV)	Factor (dB/m)	Result (dBuV/m)	Limit (dBuV/m)	Margin (dB)	Detector
1	7311.00	35.17	2.08	37.25	54.00	16.75	Average
2	7311.00	47.06	2.08	49.14	74.00	24.86	Peak
3	17467.20	31.67	15.61	47.28	54.00	6.72	Average
4	17467.20	43.94	15.61	59.55	74.00	14.45	Peak

Project No.: XMDN240205-07900E-RF  
 Polarization: Vertical  
 Test Mode: Transmitting  
 Note: 802.11g\_middle channel 2437MHz  
 Serial No.: 2HNF-1  
 Tester: Colin Yang

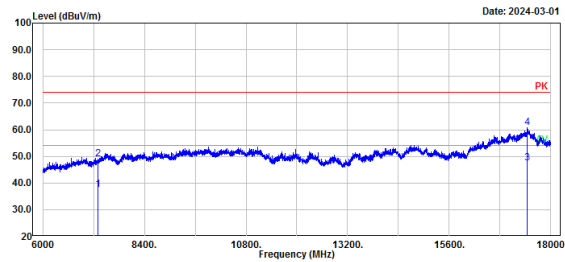

No.	Frequency (MHz)	Reading (dBuV)	Factor (dB/m)	Result (dBuV/m)	Limit (dBuV/m)	Margin (dB)	Detector
1	7311.00	35.34	2.08	37.42	54.00	16.58	Average
2	7311.00	46.88	2.08	48.96	74.00	25.04	Peak
3	17440.80	32.11	15.40	47.51	54.00	6.49	Average
4	17440.80	45.27	15.40	60.67	74.00	13.33	Peak



802.11g mode, High Channel, Horizontal

Project No.: XMDN240205-07900E-RF  
 Polarization: Horizontal  
 Test Mode: Transmitting  
 Note: 802.11g\_high channel 2462MHz

Serial No.: 2HNF-1  
 Tester: Colin Yang

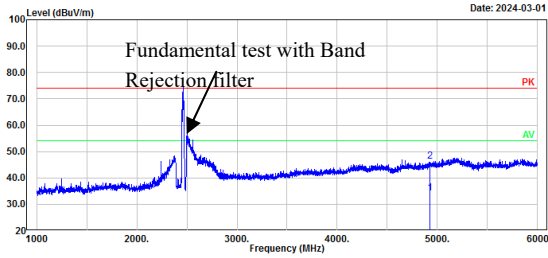

No.	Frequency (MHz)	Reading (dBuV)	Factor (dB/m)	Result (dBuV/m)	Limit (dBuV/m)	Margin (dB)	Detector
1	4924.00	36.71	-2.53	34.18	54.00	19.82	Average
2	4924.00	48.79	-2.53	46.26	74.00	27.74	Peak

802.11g mode, High Channel, Vertical

Project No.: XMDN240205-07900E-RF  
 Polarization: Vertical  
 Test Mode: Transmitting  
 Note: 802.11g\_high channel 2462MHz

Serial No.: 2HNF-1  
 Tester: Colin Yang

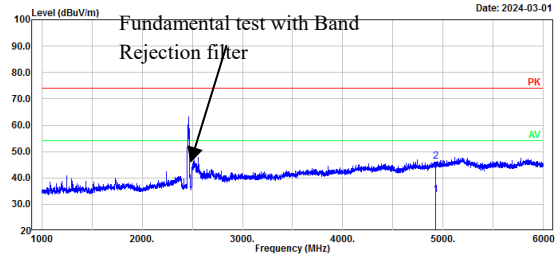

No.	Frequency (MHz)	Reading (dBuV)	Factor (dB/m)	Result (dBuV/m)	Limit (dBuV/m)	Margin (dB)	Detector
1	4924.00	36.18	-2.53	33.65	54.00	20.35	Average
2	4924.00	48.88	-2.53	46.35	74.00	27.65	Peak

Project No.: XMDN240205-07900E-RF  
 Polarization: Horizontal  
 Test Mode: Transmitting  
 Note: 802.11g\_high channel 2462MHz

Serial No.: 2HNF-1  
 Tester: Colin Yang

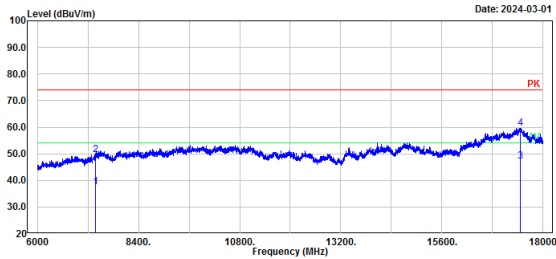

No.	Frequency (MHz)	Reading (dBuV)	Factor (dB/m)	Result (dBuV/m)	Limit (dBuV/m)	Margin (dB)	Detector
1	7386.00	35.32	2.25	37.57	54.00	16.43	Average
2	7386.00	47.44	2.25	49.69	74.00	24.31	Peak
3	17467.20	31.58	15.61	47.19	54.00	6.81	Average
4	17467.20	44.05	15.61	59.66	74.00	14.34	Peak

Project No.: XMDN240205-07900E-RF  
 Polarization: Vertical  
 Test Mode: Transmitting  
 Note: 802.11g\_high channel 2462MHz

Serial No.: 2HNF-1  
 Tester: Colin Yang

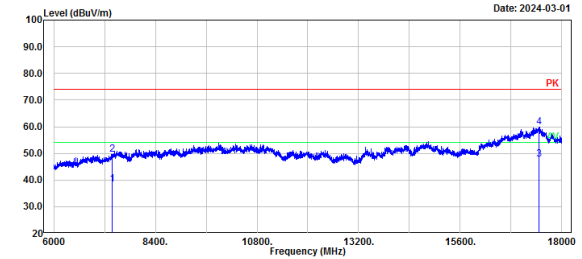

No.	Frequency (MHz)	Reading (dBuV)	Factor (dB/m)	Result (dBuV/m)	Limit (dBuV/m)	Margin (dB)	Detector
1	7386.00	36.27	2.25	38.52	54.00	15.48	Average
2	7386.00	47.27	2.25	49.52	74.00	24.48	Peak
3	17450.40	32.15	15.48	47.63	54.00	6.37	Average
4	17450.40	44.51	15.48	59.99	74.00	14.01	Peak

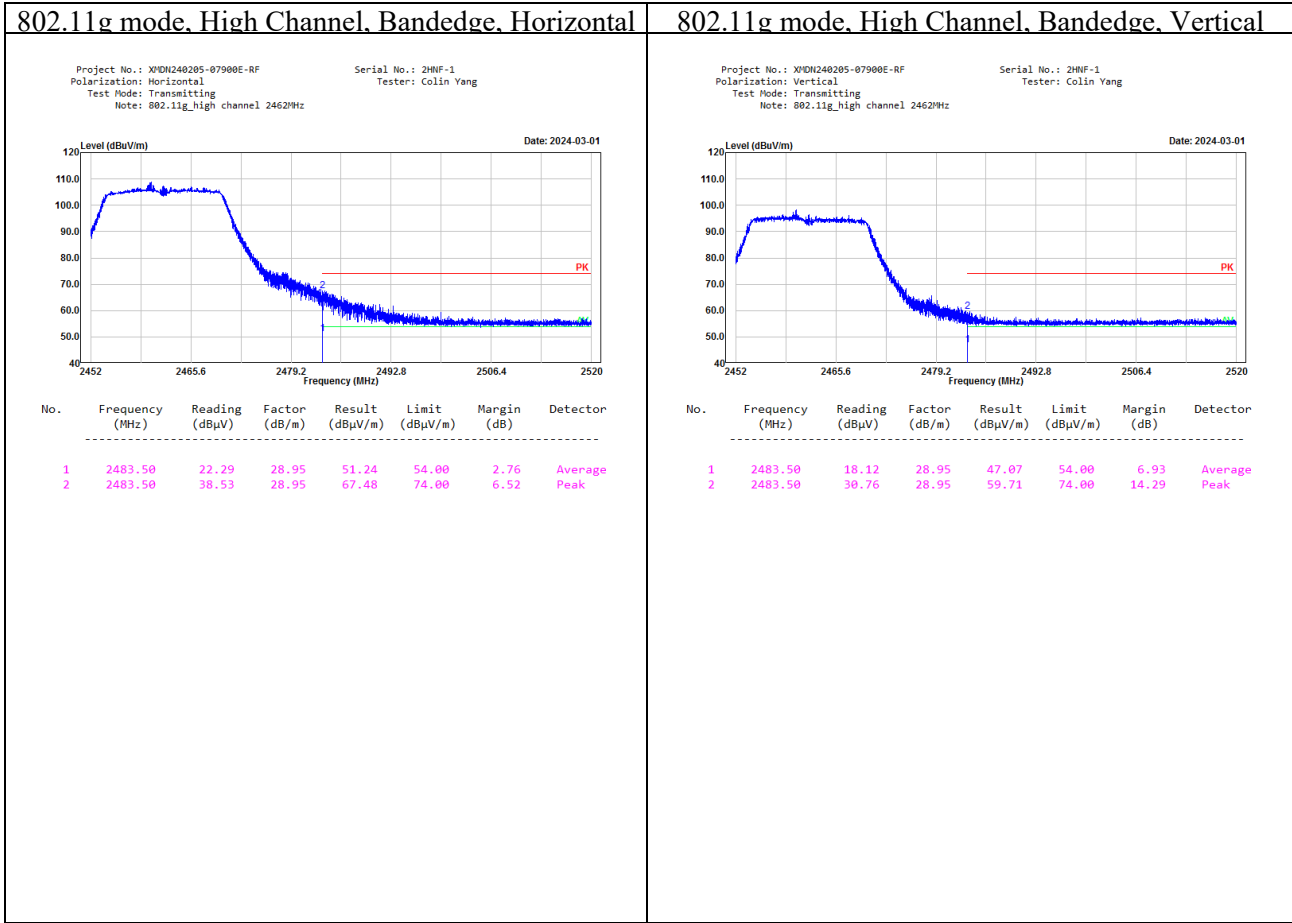

802.11n ht20 mode, Low Channel, Horizontal

Project No.: XMDN240205-07900E-RF  
 Polarization: Horizontal  
 Test Mode: Transmitting  
 Note: 802.11n20\_low channel 2412MHz  
 Serial No.: 2MHF-1  
 Tester: Colin Yang

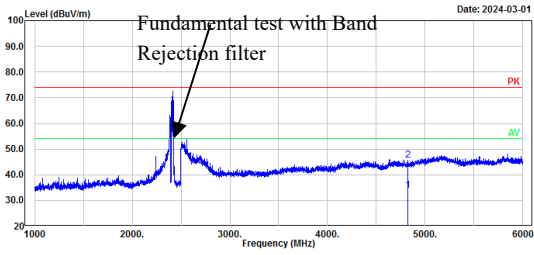

No.	Frequency (MHz)	Reading (dBuV)	Factor (dB/m)	Result (dBuV/m)	Limit (dBuV/m)	Margin (dB)	Detector
1	4824.00	36.80	-2.98	33.82	54.00	20.18	Average
2	4824.00	48.71	-2.98	45.73	74.00	28.27	Peak

802.11n ht20 mode, Low Channel, Vertical

Project No.: XMDN240205-07900E-RF  
 Polarization: Vertical  
 Test Mode: Transmitting  
 Note: 802.11n20\_low channel 2412MHz  
 Serial No.: 2MHF-1  
 Tester: Colin Yang

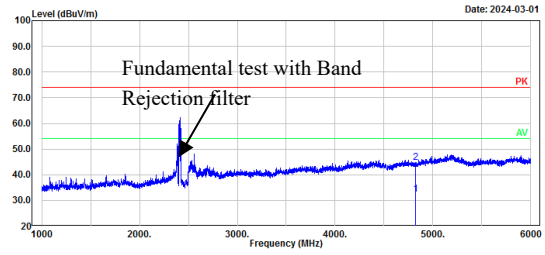

No.	Frequency (MHz)	Reading (dBuV)	Factor (dB/m)	Result (dBuV/m)	Limit (dBuV/m)	Margin (dB)	Detector
1	4824.00	35.24	-2.98	32.26	54.00	21.74	Average
2	4824.00	47.69	-2.98	44.71	74.00	29.29	Peak

Project No.: XMDN240205-07900E-RF  
 Polarization: Horizontal  
 Test Mode: Transmitting  
 Note: 802.11n20\_low channel 2412MHz  
 Serial No.: 2MHF-1  
 Tester: Colin Yang

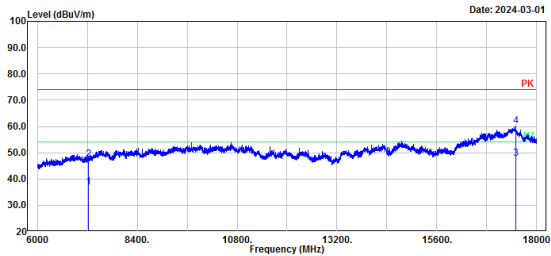

No.	Frequency (MHz)	Reading (dBuV)	Factor (dB/m)	Result (dBuV/m)	Limit (dBuV/m)	Margin (dB)	Detector
1	7236.00	35.24	1.79	37.03	54.00	16.97	Average
2	7236.00	45.82	1.79	47.61	74.00	26.39	Peak
3	17500.80	32.01	15.87	47.88	54.00	6.12	Average
4	17500.80	44.20	15.87	60.07	74.00	13.93	Peak

Project No.: XMDN240205-07900E-RF  
 Polarization: Vertical  
 Test Mode: Transmitting  
 Note: 802.11n20\_low channel 2412MHz  
 Serial No.: 2MHF-1  
 Tester: Colin Yang

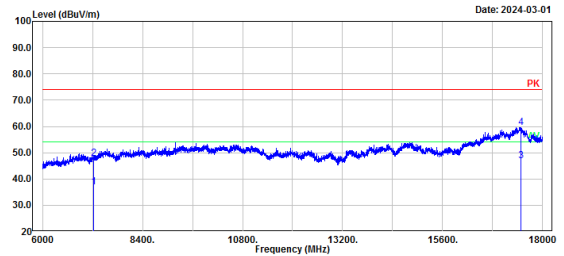

No.	Frequency (MHz)	Reading (dBuV)	Factor (dB/m)	Result (dBuV/m)	Limit (dBuV/m)	Margin (dB)	Detector
1	7236.00	35.19	1.79	36.98	54.00	17.02	Average
2	7236.00	46.09	1.79	47.88	74.00	26.12	Peak
3	17481.60	31.27	15.72	46.99	54.00	7.01	Average
4	17481.60	43.90	15.72	59.62	74.00	14.38	Peak

802.11n ht20 mode, Low Channel, Bandedge, Horizontal

Project No.: XMDN240205-07900E-RF  
 Polarization: Horizontal  
 Test Mode: Transmitting  
 Note: 802.11n20\_low channel 2412MHz

Serial No.: 2HIF-1  
 Tester: Colin Yang

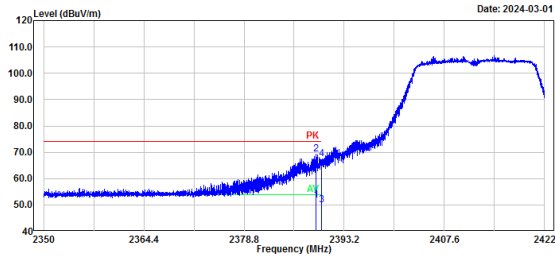

No.	Frequency (MHz)	Reading (dBuV)	Factor (dB/m)	Result (dBuV/m)	Limit (dBuV/m)	Margin (dB)	Detector
1	2389.10	23.14	28.56	51.70	54.00	2.30	Average
2	2389.10	40.61	28.56	69.17	74.00	4.83	Peak
3	2390.00	21.54	28.57	50.11	54.00	3.89	Average
4	2390.00	38.96	28.57	67.53	74.00	6.47	Peak

802.11n ht20 mode, Low Channel, Bandedge, Vertical

Project No.: XMDN240205-07900E-RF  
 Polarization: Vertical  
 Test Mode: Transmitting  
 Note: 802.11n20\_low channel 2412MHz

Serial No.: 2HIF-1  
 Tester: Colin Yang

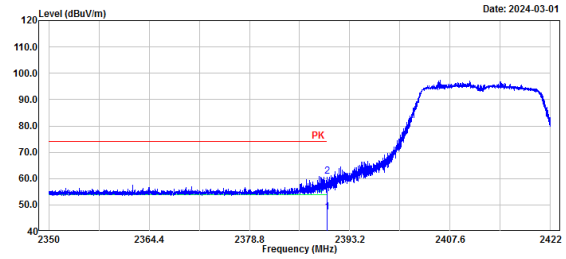

No.	Frequency (MHz)	Reading (dBuV)	Factor (dB/m)	Result (dBuV/m)	Limit (dBuV/m)	Margin (dB)	Detector
1	2390.00	18.75	28.57	47.32	54.00	6.68	Average
2	2390.00	32.40	28.57	60.97	74.00	13.03	Peak

802.11n ht20 mode, Middle Channel, Horizontal

Project No.: XMDN240205-07900E-RF  
 Polarization: Horizontal  
 Test Mode: Transmitting  
 Note: 802.11n20\_middle channel 2437MHz  
 Serial No.: 2HNF-1  
 Tester: Colin Yang

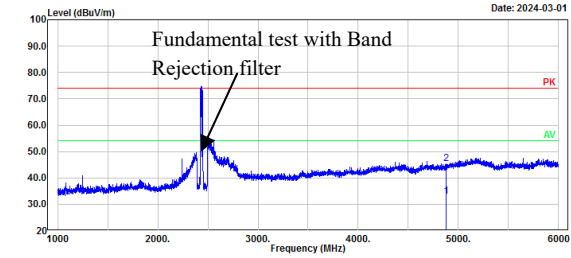

No.	Frequency (MHz)	Reading (dBuV)	Factor (dB/m)	Result (dBuV/m)	Limit (dBuV/m)	Margin (dB)	Detector
1	4874.00	35.87	-2.77	33.10	54.00	20.90	Average
2	4874.00	48.00	-2.77	45.23	74.00	28.77	Peak

802.11n ht20 mode, Middle Channel, Vertical

Project No.: XMDN240205-07900E-RF  
 Polarization: Vertical  
 Test Mode: Transmitting  
 Note: 802.11n20\_middle channel 2437MHz  
 Serial No.: 2HNF-1  
 Tester: Colin Yang

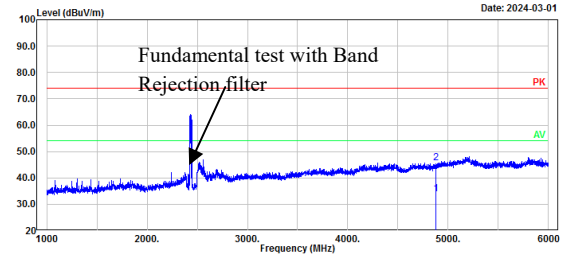

No.	Frequency (MHz)	Reading (dBuV)	Factor (dB/m)	Result (dBuV/m)	Limit (dBuV/m)	Margin (dB)	Detector
1	4874.00	36.62	-2.77	33.85	54.00	20.15	Average
2	4874.00	48.54	-2.77	45.77	74.00	28.23	Peak

Project No.: XMDN240205-07900E-RF  
 Polarization: Horizontal  
 Test Mode: Transmitting  
 Note: 802.11n20\_middle channel 2437MHz  
 Serial No.: 2HNF-1  
 Tester: Colin Yang

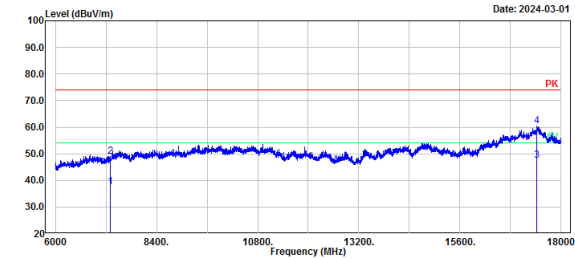

No.	Frequency (MHz)	Reading (dBuV)	Factor (dB/m)	Result (dBuV/m)	Limit (dBuV/m)	Margin (dB)	Detector
1	7311.00	35.36	2.08	37.44	54.00	16.56	Average
2	7311.00	46.77	2.08	48.85	74.00	25.15	Peak
3	17426.40	32.10	15.28	47.38	54.00	6.62	Average
4	17426.40	45.06	15.28	60.34	74.00	13.66	Peak

Project No.: XMDN240205-07900E-RF  
 Polarization: Vertical  
 Test Mode: Transmitting  
 Note: 802.11n20\_middle channel 2437MHz  
 Serial No.: 2HNF-1  
 Tester: Colin Yang

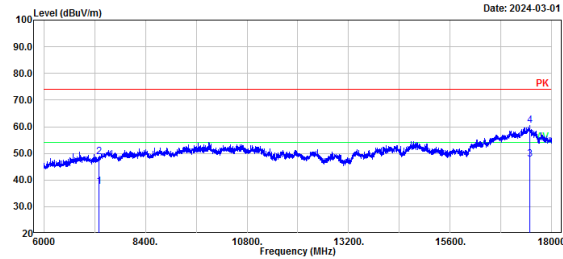

No.	Frequency (MHz)	Reading (dBuV)	Factor (dB/m)	Result (dBuV/m)	Limit (dBuV/m)	Margin (dB)	Detector
1	7311.00	35.48	2.08	37.56	54.00	16.44	Average
2	7311.00	46.68	2.08	48.76	74.00	25.24	Peak
3	17476.80	32.16	15.69	47.85	54.00	6.15	Average
4	17476.80	44.71	15.69	60.40	74.00	13.60	Peak

802.11n ht20 mode, High Channel, Horizontal

Project No.: XMDN240205-07900E-RF  
 Polarization: Horizontal  
 Test Mode: Transmitting  
 Note: 802.11n20\_high channel 2462MHz

Serial No.: 2HNF-1  
 Tester: Colin Yang

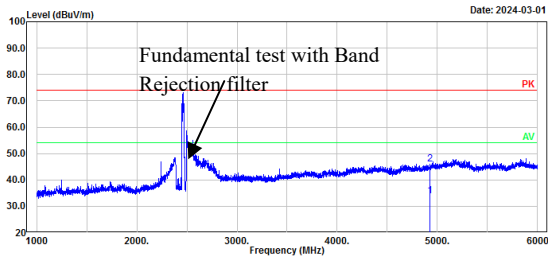

No.	Frequency (MHz)	Reading (dBuV)	Factor (dB/m)	Result (dBuV/m)	Limit (dBuV/m)	Margin (dB)	Detector
1	4924.00	36.37	-2.53	33.84	54.00	20.16	Average
2	4924.00	48.56	-2.53	46.03	74.00	27.97	Peak

802.11n ht20 mode, High Channel, Vertical

Project No.: XMDN240205-07900E-RF  
 Polarization: Vertical  
 Test Mode: Transmitting  
 Note: 802.11n20\_high channel 2462MHz

Serial No.: 2HNF-1  
 Tester: Colin Yang

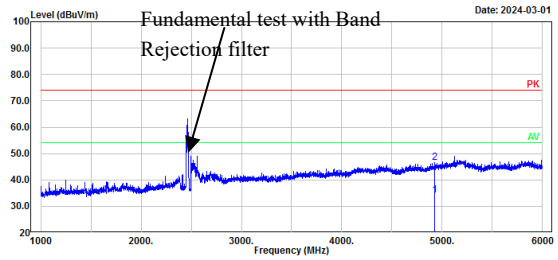

No.	Frequency (MHz)	Reading (dBuV)	Factor (dB/m)	Result (dBuV/m)	Limit (dBuV/m)	Margin (dB)	Detector
1	4924.00	36.82	-2.53	34.29	54.00	19.71	Average
2	4924.00	49.10	-2.53	46.57	74.00	27.43	Peak

Project No.: XMDN240205-07900E-RF  
 Polarization: Horizontal  
 Test Mode: Transmitting  
 Note: 802.11n20\_high channel 2462MHz

Serial No.: 2HNF-1  
 Tester: Colin Yang

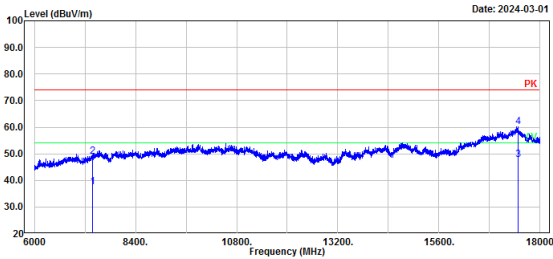

No.	Frequency (MHz)	Reading (dBuV)	Factor (dB/m)	Result (dBuV/m)	Limit (dBuV/m)	Margin (dB)	Detector
1	7386.00	35.27	2.25	37.52	54.00	16.48	Average
2	7386.00	46.64	2.25	48.89	74.00	25.11	Peak
3	17474.40	32.03	15.67	47.70	54.00	6.30	Average
4	17474.40	44.48	15.67	60.15	74.00	13.85	Peak

Project No.: XMDN240205-07900E-RF  
 Polarization: Vertical  
 Test Mode: Transmitting  
 Note: 802.11n20\_high channel 2462MHz

Serial No.: 2HNF-1  
 Tester: Colin Yang

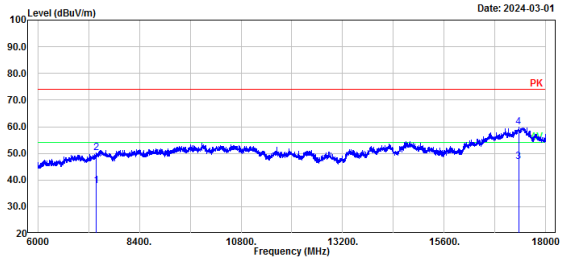

No.	Frequency (MHz)	Reading (dBuV)	Factor (dB/m)	Result (dBuV/m)	Limit (dBuV/m)	Margin (dB)	Detector
1	7386.00	35.41	2.25	37.66	54.00	16.34	Average
2	7386.00	47.80	2.25	50.05	74.00	23.95	Peak
3	17354.40	32.21	14.70	46.91	54.00	7.09	Average
4	17354.40	45.19	14.70	59.89	74.00	14.11	Peak

802.11n ht20 mode, High Channel, Bandedge, Horizontal

Project No.: XMDN240205-07900E-RF      Serial No.: 2HNF-1  
 Polarization: Horizontal                      Tester: Colin Yang  
 Test Mode: Transmitting  
 Note: 802.11n20\_high channel 2462MHz

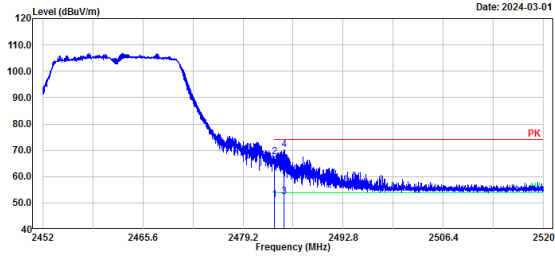

No.	Frequency (MHz)	Reading (dBuV)	Factor (dB/m)	Result (dBuV/m)	Limit (dBuV/m)	Margin (dB)	Detector
1	2483.50	22.14	28.95	51.09	54.00	2.91	Average
2	2483.50	38.65	28.95	67.60	74.00	6.40	Peak
3	2484.78	23.31	28.96	52.27	54.00	1.73	Average
4	2484.78	41.26	28.96	70.22	74.00	3.78	Peak

802.11n ht20 mode, High Channel, Bandedge, Vertical

Project No.: XMDN240205-07900E-RF      Serial No.: 2HNF-1  
 Polarization: Vertical                              Tester: Colin Yang  
 Test Mode: Transmitting  
 Note: 802.11n20\_high channel 2462MHz

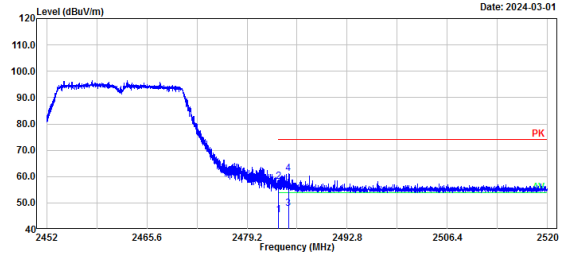

No.	Frequency (MHz)	Reading (dBuV)	Factor (dB/m)	Result (dBuV/m)	Limit (dBuV/m)	Margin (dB)	Detector
1	2483.50	16.42	28.95	45.37	54.00	8.63	Average
2	2483.50	29.17	28.95	58.12	74.00	15.88	Peak
3	2484.82	18.74	28.96	47.70	54.00	6.30	Average
4	2484.82	32.06	28.96	61.02	74.00	12.98	Peak

802.11n ht40 mode, Low Channel, Horizontal

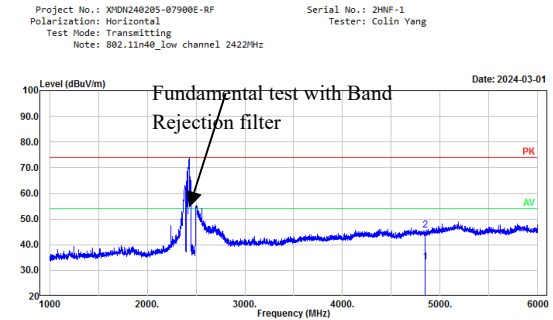

No.	Frequency (MHz)	Reading (dBuV)	Factor (dB/m)	Result (dBuV/m)	Limit (dBuV/m)	Margin (dB)	Detector
1	4844.00	36.14	-2.90	33.24	54.00	20.76	Average
2	4844.00	48.47	-2.90	45.57	74.00	28.43	Peak

802.11n ht40 mode, Low Channel, Vertical

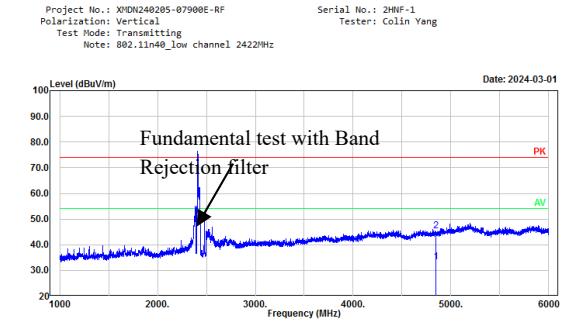

No.	Frequency (MHz)	Reading (dBuV)	Factor (dB/m)	Result (dBuV/m)	Limit (dBuV/m)	Margin (dB)	Detector
1	4844.00	36.29	-2.90	33.39	54.00	20.61	Average
2	4844.00	48.40	-2.90	45.50	74.00	28.50	Peak

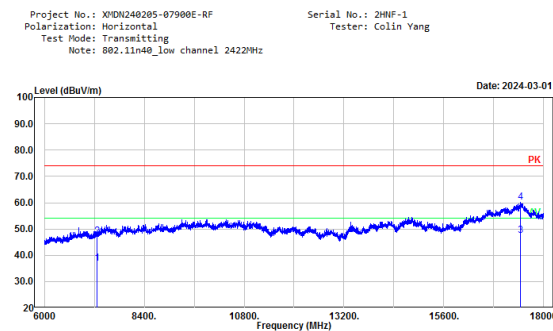

No.	Frequency (MHz)	Reading (dBuV)	Factor (dB/m)	Result (dBuV/m)	Limit (dBuV/m)	Margin (dB)	Detector
1	7266.00	35.11	1.93	37.04	54.00	16.96	Average
2	7266.00	45.21	1.93	47.14	74.00	26.86	Peak
3	17445.60	32.07	15.44	47.51	54.00	6.49	Average
4	17445.60	44.69	15.44	60.13	74.00	13.87	Peak

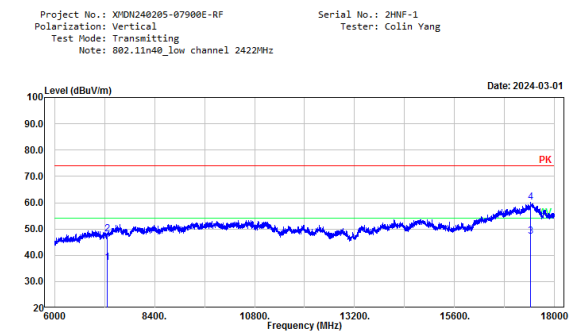

No.	Frequency (MHz)	Reading (dBuV)	Factor (dB/m)	Result (dBuV/m)	Limit (dBuV/m)	Margin (dB)	Detector
1	7266.00	35.39	1.93	37.32	54.00	16.68	Average
2	7266.00	46.14	1.93	48.07	74.00	25.93	Peak
3	17416.80	32.07	15.22	47.29	54.00	6.71	Average
4	17416.80	44.85	15.22	60.07	74.00	13.93	Peak



802.11n ht40 mode, Low Channel, Bandedge, Horizontal

Project No.: XMDN240205-07900E-RF  
 Polarization: Horizontal  
 Test Mode: Transmitting  
 Note: 802.11n40\_low channel 2422MHz

Serial No.: 2HIF-1  
 Tester: Colin Yang

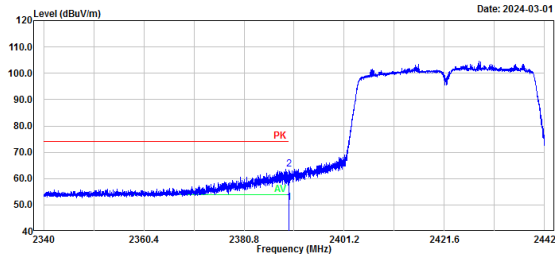

No.	Frequency (MHz)	Reading (dBμV)	Factor (dB/m)	Result (dBμV/m)	Limit (dBμV/m)	Margin (dB)	Detector
1	2390.00	22.26	28.57	50.83	54.00	3.17	Average
2	2390.00	34.83	28.57	63.40	74.00	10.60	Peak

802.11n ht40 mode, Low Channel, Bandedge, Vertical

Project No.: XMDN240205-07900E-RF  
 Polarization: Vertical  
 Test Mode: Transmitting  
 Note: 802.11n40\_low channel 2422MHz

Serial No.: 2HIF-1  
 Tester: Colin Yang

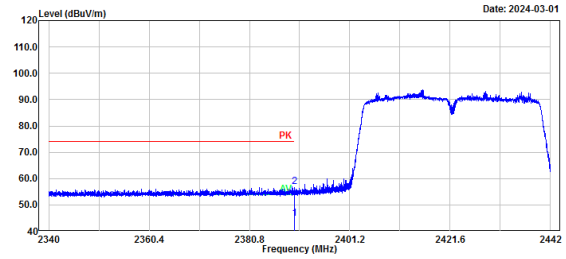

No.	Frequency (MHz)	Reading (dBμV)	Factor (dB/m)	Result (dBμV/m)	Limit (dBμV/m)	Margin (dB)	Detector
1	2390.00	16.24	28.57	44.81	54.00	9.19	Average
2	2390.00	28.46	28.57	57.03	74.00	16.97	Peak

802.11n ht40 mode, Middle Channel, Horizontal

Project No.: XMDN240205-07900E-RF  
 Polarization: Horizontal  
 Test Mode: Transmitting  
 Note: 802.11n40\_middle channel 2437MHz

Serial No.: 2HNF-1  
 Tester: Colin Yang

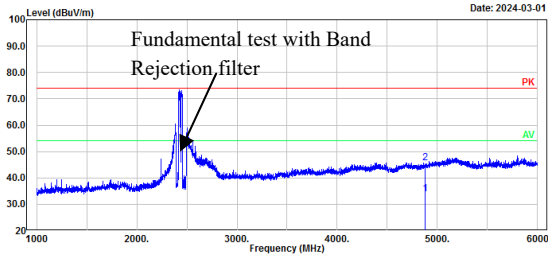

No.	Frequency (MHz)	Reading (dBuV)	Factor (dB/m)	Result (dBuV/m)	Limit (dBuV/m)	Margin (dB)	Detector
1	4874.00	36.55	-2.77	33.78	54.00	20.22	Average
2	4874.00	48.44	-2.77	45.67	74.00	28.33	Peak

802.11n ht40 mode, Middle Channel, Vertical

Project No.: XMDN240205-07900E-RF  
 Polarization: Vertical  
 Test Mode: Transmitting  
 Note: 802.11n40\_middle channel 2437MHz

Serial No.: 2HNF-1  
 Tester: Colin Yang

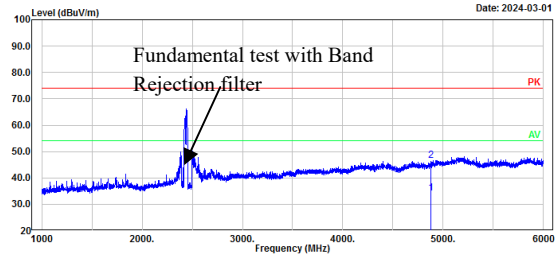

No.	Frequency (MHz)	Reading (dBuV)	Factor (dB/m)	Result (dBuV/m)	Limit (dBuV/m)	Margin (dB)	Detector
1	4874.00	36.88	-2.77	34.11	54.00	19.89	Average
2	4874.00	49.27	-2.77	46.50	74.00	27.50	Peak

Project No.: XMDN240205-07900E-RF  
 Polarization: Horizontal  
 Test Mode: Transmitting  
 Note: 802.11n40\_middle channel 2437MHz

Serial No.: 2HNF-1  
 Tester: Colin Yang

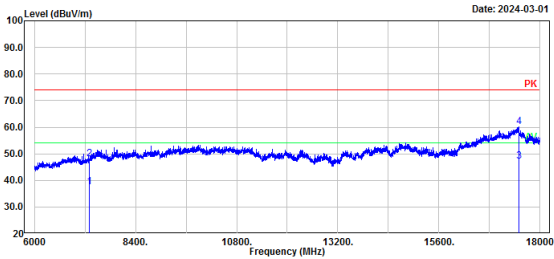

No.	Frequency (MHz)	Reading (dBuV)	Factor (dB/m)	Result (dBuV/m)	Limit (dBuV/m)	Margin (dB)	Detector
1	7311.00	35.43	2.08	37.51	54.00	16.49	Average
2	7311.00	45.96	2.08	48.04	74.00	25.96	Peak
3	17488.80	31.26	15.78	47.04	54.00	6.96	Average
4	17488.80	44.42	15.78	60.20	74.00	13.80	Peak

Project No.: XMDN240205-07900E-RF  
 Polarization: Vertical  
 Test Mode: Transmitting  
 Note: 802.11n40\_middle channel 2437MHz

Serial No.: 2HNF-1  
 Tester: Colin Yang

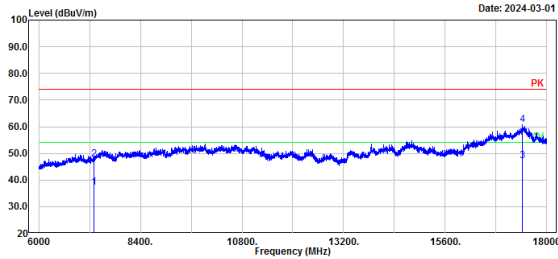

No.	Frequency (MHz)	Reading (dBuV)	Factor (dB/m)	Result (dBuV/m)	Limit (dBuV/m)	Margin (dB)	Detector
1	7311.00	35.14	2.08	37.22	54.00	16.78	Average
2	7311.00	45.56	2.08	47.64	74.00	26.36	Peak
3	17414.40	32.05	15.19	47.24	54.00	6.76	Average
4	17414.40	45.43	15.19	60.62	74.00	13.38	Peak

802.11n ht40 mode, High Channel, Horizontal

Project No.: XMDN240205-07900E-RF  
 Polarization: Horizontal  
 Test Mode: Transmitting  
 Note: 802.11n40\_high channel 2452MHz

Serial No.: 2HNF-1  
 Tester: Colin Yang

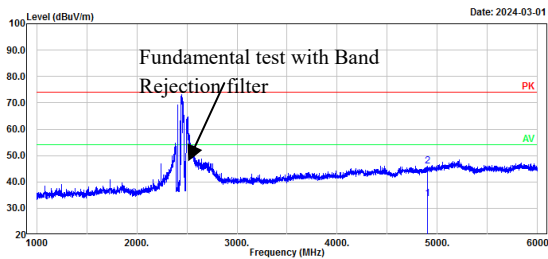

No.	Frequency (MHz)	Reading (dBuV)	Factor (dB/m)	Result (dBuV/m)	Limit (dBuV/m)	Margin (dB)	Detector
1	4904.00	36.33	-2.62	33.71	54.00	20.29	Average
2	4904.00	48.52	-2.62	45.90	74.00	28.10	Peak

802.11n ht40 mode, High Channel, Vertical

Project No.: XMDN240205-07900E-RF  
 Polarization: Vertical  
 Test Mode: Transmitting  
 Note: 802.11n40\_high channel 2452MHz

Serial No.: 2HNF-1  
 Tester: Colin Yang

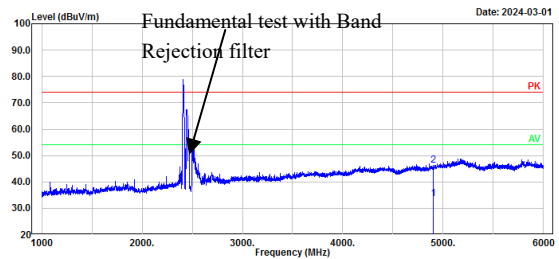

No.	Frequency (MHz)	Reading (dBuV)	Factor (dB/m)	Result (dBuV/m)	Limit (dBuV/m)	Margin (dB)	Detector
1	4904.00	36.18	-2.62	33.56	54.00	20.44	Average
2	4904.00	48.92	-2.62	46.30	74.00	27.70	Peak

Project No.: XMDN240205-07900E-RF  
 Polarization: Horizontal  
 Test Mode: Transmitting  
 Note: 802.11n40\_high channel 2452MHz

Serial No.: 2HNF-1  
 Tester: Colin Yang

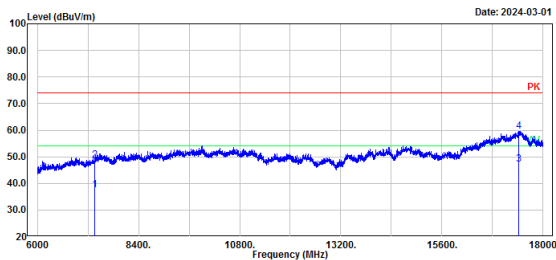

No.	Frequency (MHz)	Reading (dBuV)	Factor (dB/m)	Result (dBuV/m)	Limit (dBuV/m)	Margin (dB)	Detector
1	7356.00	35.28	2.16	37.44	54.00	16.56	Average
2	7356.00	46.52	2.16	48.68	74.00	25.32	Peak
3	17419.20	31.92	15.23	47.15	54.00	6.85	Average
4	17419.20	44.24	15.23	59.47	74.00	14.53	Peak

Project No.: XMDN240205-07900E-RF  
 Polarization: Vertical  
 Test Mode: Transmitting  
 Note: 802.11n40\_high channel 2452MHz

Serial No.: 2HNF-1  
 Tester: Colin Yang

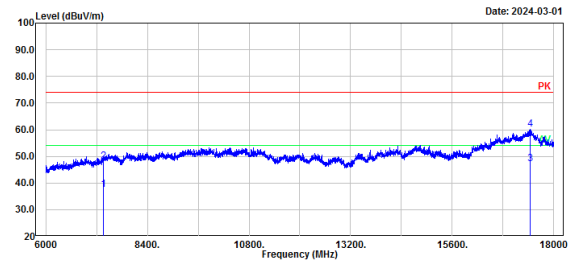

No.	Frequency (MHz)	Reading (dBuV)	Factor (dB/m)	Result (dBuV/m)	Limit (dBuV/m)	Margin (dB)	Detector
1	7356.00	35.29	2.16	37.45	54.00	16.55	Average
2	7356.00	45.86	2.16	48.02	74.00	25.98	Peak
3	17448.00	31.87	15.45	47.32	54.00	6.68	Average
4	17448.00	44.81	15.45	60.26	74.00	13.74	Peak

802.11n ht40 mode, High Channel, Bandedge,  
Horizontal

Project No.: XMDN240205-07900E-RF      Serial No.: 2HNF-1  
Polarization: Horizontal                      Tester: Colin Yang  
Test Mode: Transmitting  
Note: 802.11n40\_high channel 2452MHz

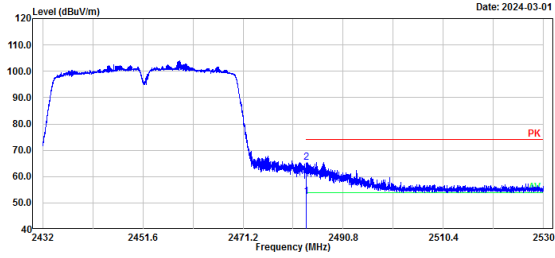

No.	Frequency (MHz)	Reading (dBuV)	Factor (dB/m)	Result (dBuV/m)	Limit (dBuV/m)	Margin (dB)	Detector
1	2483.50	23.43	28.95	52.38	54.00	1.62	Average
2	2483.50	36.44	28.95	65.39	74.00	8.61	Peak

802.11n ht40 mode, High Channel, Bandedge,  
Vertical

Project No.: XMDN240205-07900E-RF      Serial No.: 2HNF-1  
Polarization: Vertical                          Tester: Colin Yang  
Test Mode: Transmitting  
Note: 802.11n40\_high channel 2452MHz

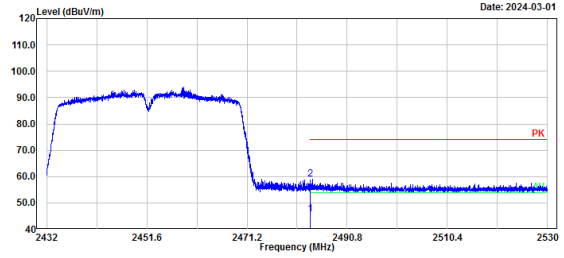

No.	Frequency (MHz)	Reading (dBuV)	Factor (dB/m)	Result (dBuV/m)	Limit (dBuV/m)	Margin (dB)	Detector
1	2483.50	16.87	28.95	45.82	54.00	8.18	Average
2	2483.50	29.99	28.95	58.94	74.00	15.06	Peak

**18-25GHz:**

No Emission was detected in the range 18-25GHz, test was performed on the mode and channel which with the maximum power.

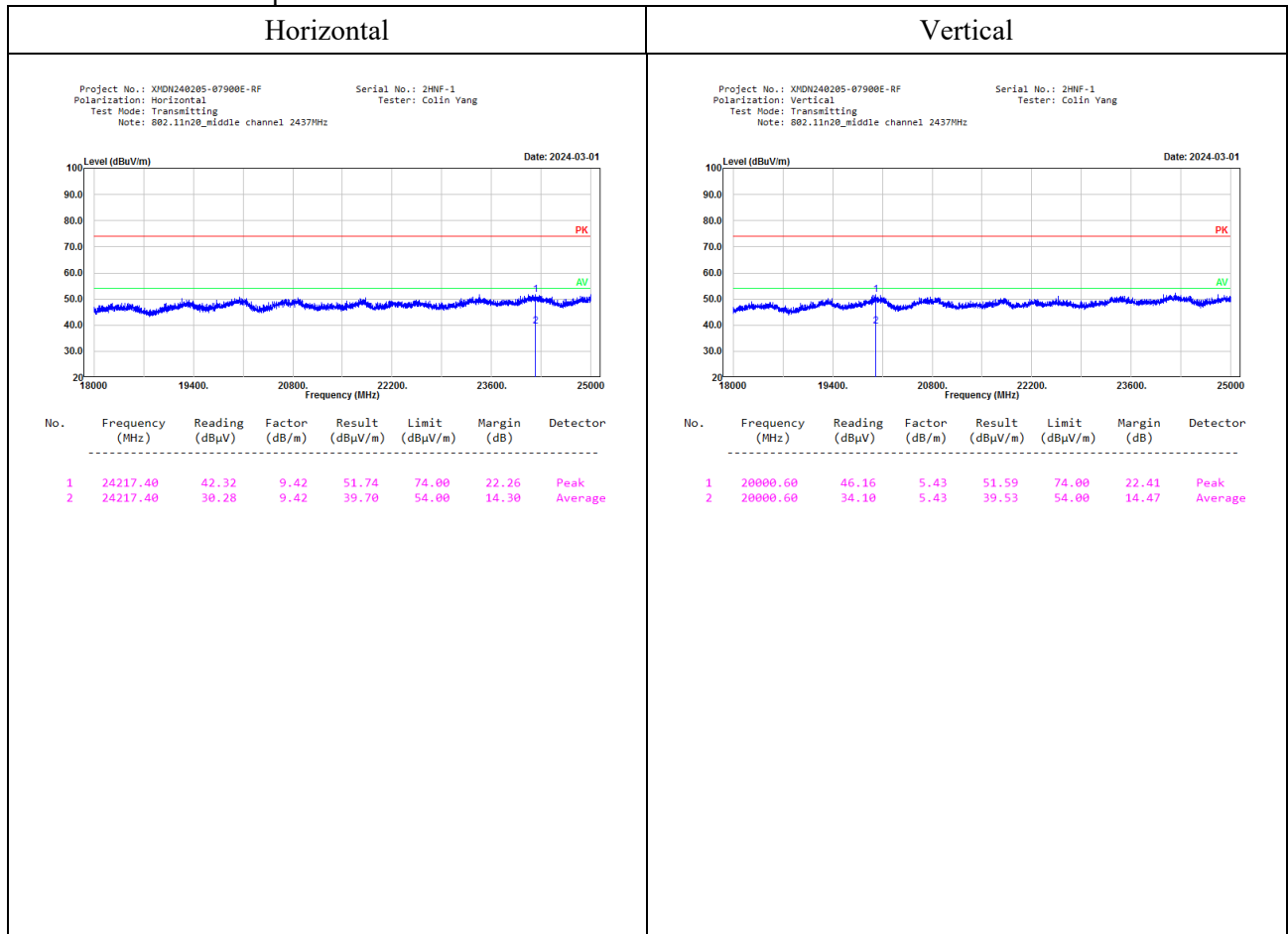

### 5.3 Minimum 6 dB Emission Bandwidth

<b>Serial No.:</b>	2HNF-2	<b>Test Date:</b>	2024/3/30
<b>Test Site:</b>	RF	<b>Test Mode:</b>	Transmitting
<b>Tester:</b>	Alice Tan	<b>Test Result:</b>	Pass

#### Environmental Conditions:

<b>Temperature:</b> (°C)	26.3	<b>Relative Humidity:</b> (%)	49	<b>ATM Pressure:</b> (kPa)	100.8
-----------------------------	------	----------------------------------	----	-------------------------------	-------

#### Test Equipment List and Details:

Manufacturer	Description	Model	Serial Number	Calibration Date	Calibration Due Date
R&S	Spectrum Analyzer	FSU 26	200160/026	2023/10/18	2024/10/17
Eastsheep	Coaxial Attenuator	5W-N-JK-6G-10dB	F-08-EM502	2023/9/10	2024/9/9

\* Statement of Traceability: Bay Area Compliance Laboratories Corp. (Dongguan) attests that all calibrations have been performed, traceable to National Primary Standards and International System of Units (SI).

#### Test Data:

Mode	Value (MHz)	Limit (MHz)	Result
b_2412MHz_Chain 0	10	0.5	Pass
b_2437MHz_Chain 0	10.08	0.5	Pass
b_2462MHz_Chain 0	10.08	0.5	Pass
g_2412MHz_Chain 0	16.16	0.5	Pass
g_2437MHz_Chain 0	16.24	0.5	Pass
g_2462MHz_Chain 0	16.4	0.5	Pass
n20_2412MHz_Chain 0	17.6	0.5	Pass
n20_2437MHz_Chain 0	17.6	0.5	Pass
n20_2462MHz_Chain 0	17.36	0.5	Pass
n40_2422MHz_Chain 0	35.36	0.5	Pass
n40_2437MHz_Chain 0	35.2	0.5	Pass
n40_2452MHz_Chain 0	35.52	0.5	Pass

b\_2412MHz

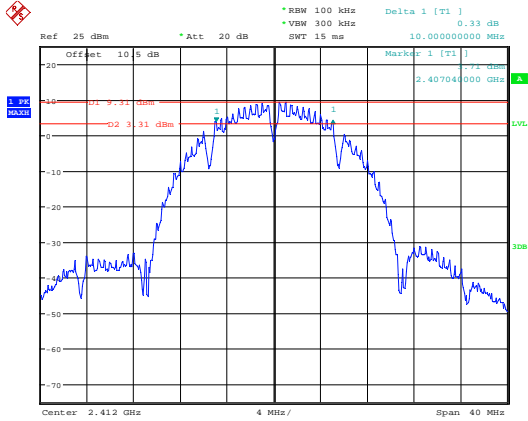

ProjectNo.:XMDN240205-07900E Tester:Alice Tan  
Date: 30.MAR.2024 11:54:56

b\_2437MHz

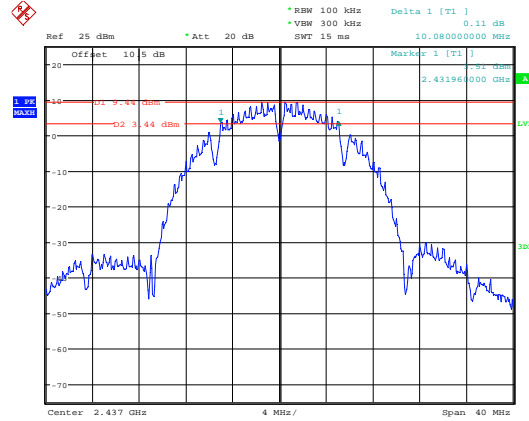

ProjectNo.:XMDN240205-07900E Tester:Alice Tan  
Date: 30.MAR.2024 11:53:18

b\_2462MHz

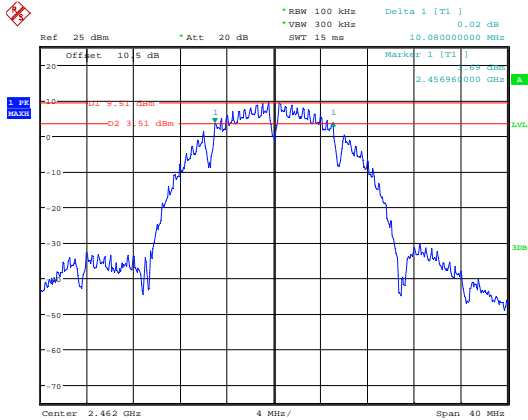

ProjectNo.:XMDN240205-07900E Tester:Alice Tan  
Date: 30.MAR.2024 11:52:05

g\_2412MHz

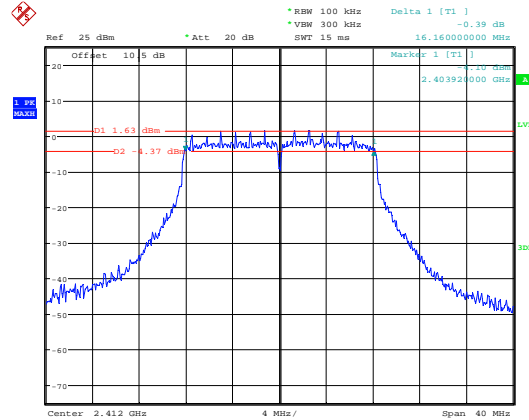

ProjectNo.:XMDN240205-07900E Tester:Alice Tan  
Date: 30.MAR.2024 11:49:07

g\_2437MHz

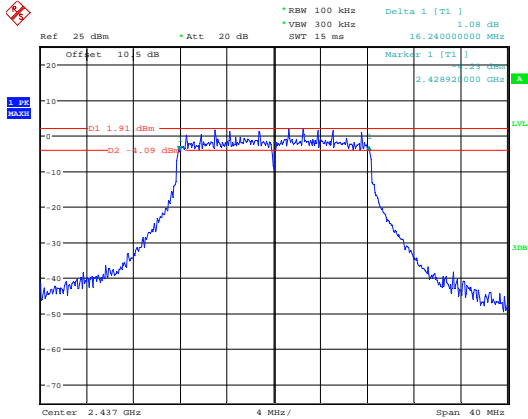

ProjectNo.:XMDN240205-07900E Tester:Alice Tan  
Date: 30.MAR.2024 11:47:53

g\_2462MHz

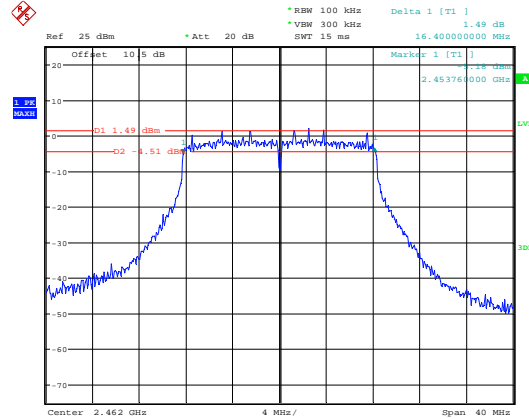

ProjectNo.:XMDN240205-07900E Tester:Alice Tan  
Date: 30.MAR.2024 11:45:16

n20\_2412MHz

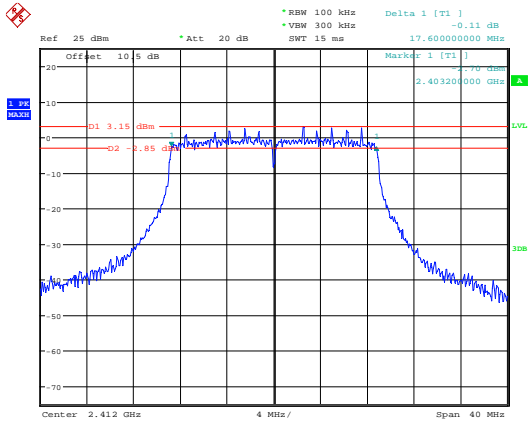

ProjectNo.:XMDN240205-07900E Tester:Alice Tan  
Date: 30.MAR.2024 11:40:56

n20\_2437MHz

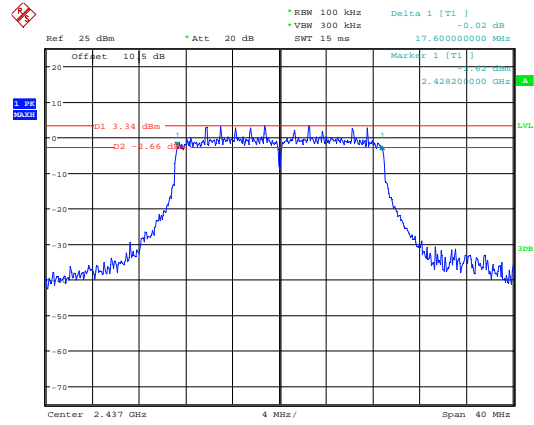

ProjectNo.:XMDN240205-07900E Tester:Alice Tan  
Date: 30.MAR.2024 11:42:21

n20\_2462MHz

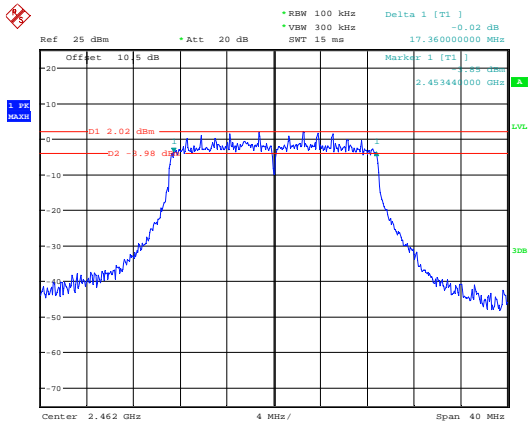

ProjectNo.:XMDN240205-07900E Tester:Alice Tan  
Date: 30.MAR.2024 11:43:41

n40\_2422MHz

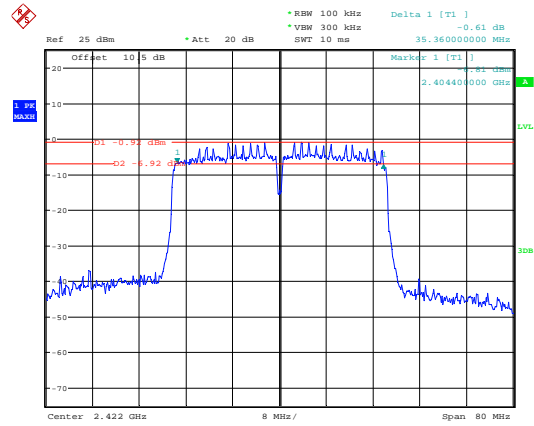

ProjectNo.:XMDN240205-07900E Tester:Alice Tan  
Date: 30.MAR.2024 11:38:59

n40\_2437MHz

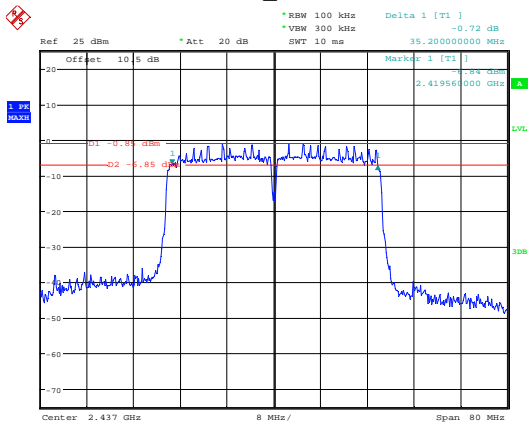

ProjectNo.:XMDN240205-07900E Tester:Alice Tan  
Date: 30.MAR.2024 11:37:13

n40\_2452MHz

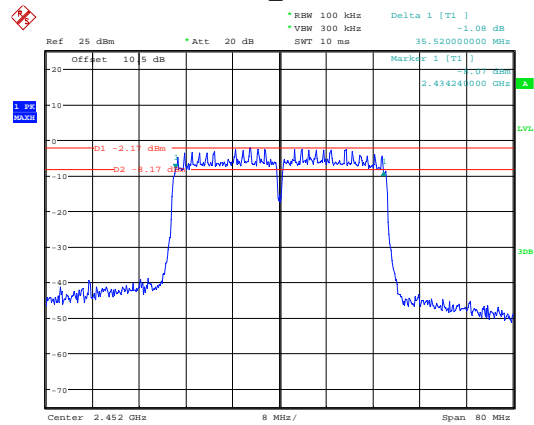

ProjectNo.:XMDN240205-07900E Tester:Alice Tan  
Date: 30.MAR.2024 11:34:47



**5.4 99% Occupied Bandwidth**

<b>Serial No.:</b>	2HNF-2	<b>Test Date:</b>	2024/3/30
<b>Test Site:</b>	RF	<b>Test Mode:</b>	Transmitting
<b>Tester:</b>	Alice Tan	<b>Test Result:</b>	/

**Environmental Conditions:**

<b>Temperature:</b> (°C)	26.3	<b>Relative Humidity:</b> (%)	49	<b>ATM Pressure:</b> (kPa)	100.8
-----------------------------	------	----------------------------------	----	-------------------------------	-------

**Test Equipment List and Details:**

Manufacturer	Description	Model	Serial Number	Calibration Date	Calibration Due Date
R&S	Spectrum Analyzer	FSU 26	200160/026	2023/10/18	2024/10/17
Eastsheep	Coaxial Attenuator	5W-N-JK-6G-10dB	F-08-EM502	2023/9/10	2024/9/9

*\* Statement of Traceability: Bay Area Compliance Laboratories Corp. (Dongguan) attests that all calibrations have been performed, traceable to National Primary Standards and International System of Units (SI).*

**Test Data:**

Mode	99% OBW (MHz)
b_2412MHz_Chain 0	14.88
b_2437MHz_Chain 0	14.88
b_2462MHz_Chain 0	14.8
g_2412MHz_Chain 0	17.04
g_2437MHz_Chain 0	16.88
g_2462MHz_Chain 0	17.04
n20_2412MHz_Chain 0	18.08
n20_2437MHz_Chain 0	18.08
n20_2462MHz_Chain 0	18
n40_2422MHz_Chain 0	36
n40_2437MHz_Chain 0	36
n40_2452MHz_Chain 0	36

b\_2412MHz

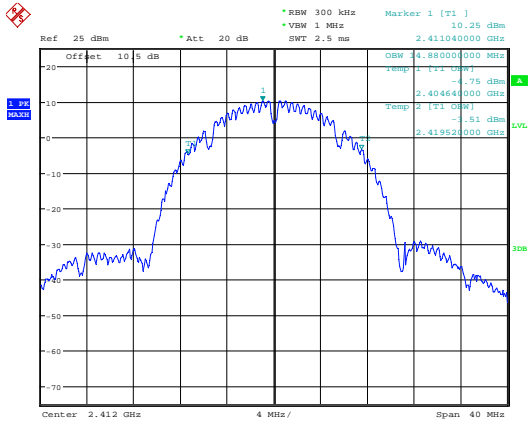

ProjectNo.:XMDN240205-07900E Tester:Alice Tan  
Date: 30.MAR.2024 11:50:59

b\_2437MHz

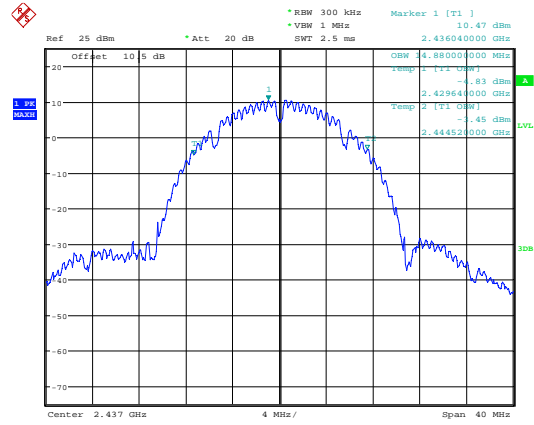

ProjectNo.:XMDN240205-07900E Tester:Alice Tan  
Date: 30.MAR.2024 11:53:31

b\_2462MHz

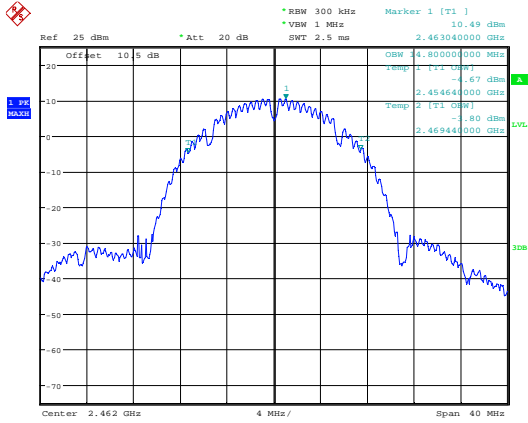

ProjectNo.:XMDN240205-07900E Tester:Alice Tan  
Date: 30.MAR.2024 11:52:18

g\_2412MHz

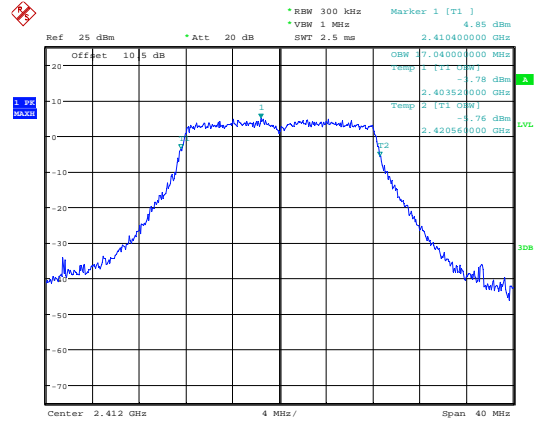

ProjectNo.:XMDN240205-07900E Tester:Alice Tan  
Date: 30.MAR.2024 11:49:24

g\_2437MHz

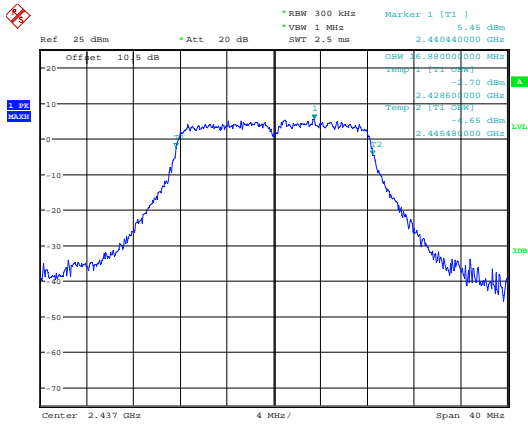

ProjectNo.:XMDN240205-07900E Tester:Alice Tan  
Date: 30.MAR.2024 11:46:57

g\_2462MHz

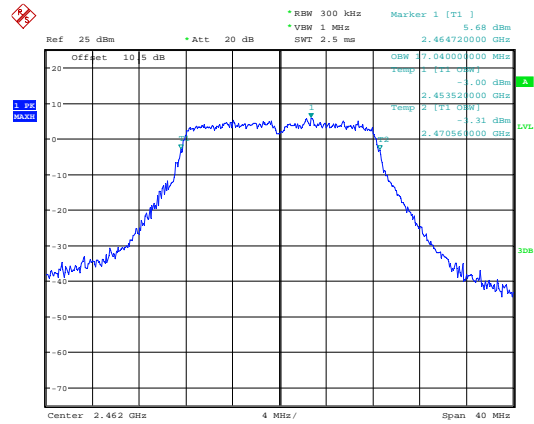

ProjectNo.:XMDN240205-07900E Tester:Alice Tan  
Date: 30.MAR.2024 11:45:33

n20\_2412MHz

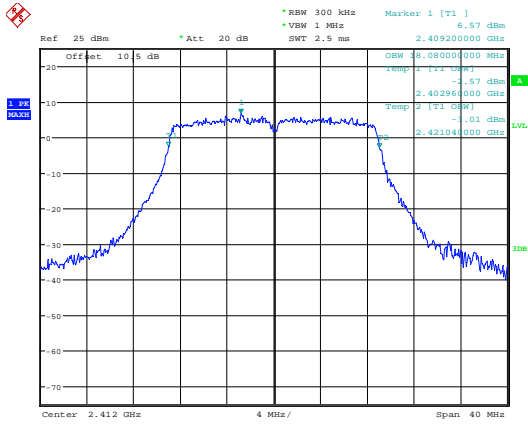

ProjectNo.:XMDN240205-07900E Tester:Alice Tan  
Date: 30.MAR.2024 11:41:12

n20\_2437MHz

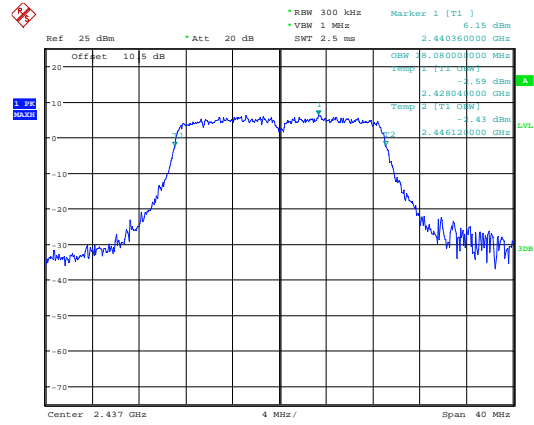

ProjectNo.:XMDN240205-07900E Tester:Alice Tan  
Date: 30.MAR.2024 11:42:38

n20\_2462MHz

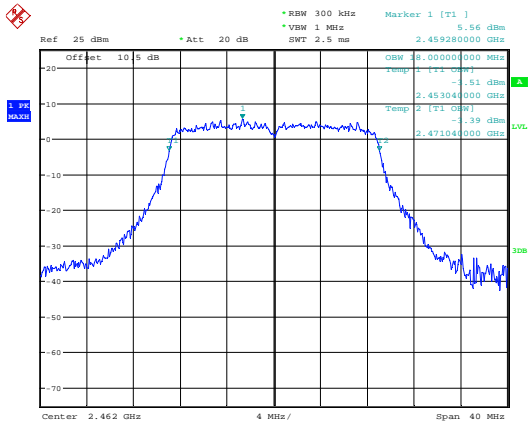

ProjectNo.:XMDN240205-07900E Tester:Alice Tan  
Date: 30.MAR.2024 11:43:57

n40\_2422MHz

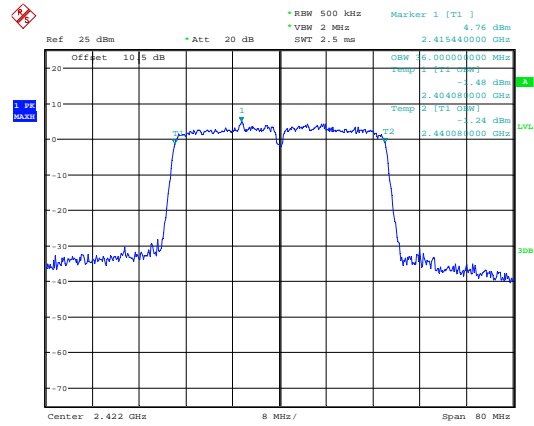

ProjectNo.:XMDN240205-07900E Tester:Alice Tan  
Date: 30.MAR.2024 11:39:15

n40\_2437MHz

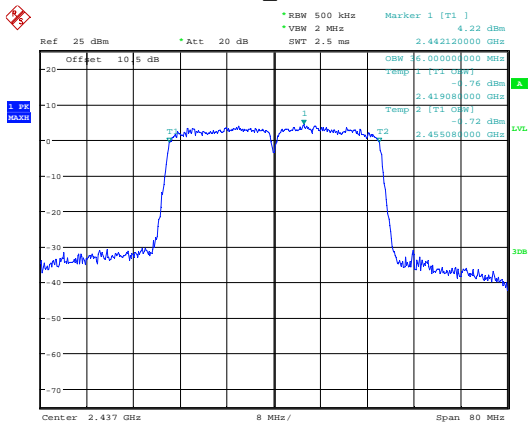

ProjectNo.:XMDN240205-07900E Tester:Alice Tan  
Date: 30.MAR.2024 11:37:29

n40\_2452MHz

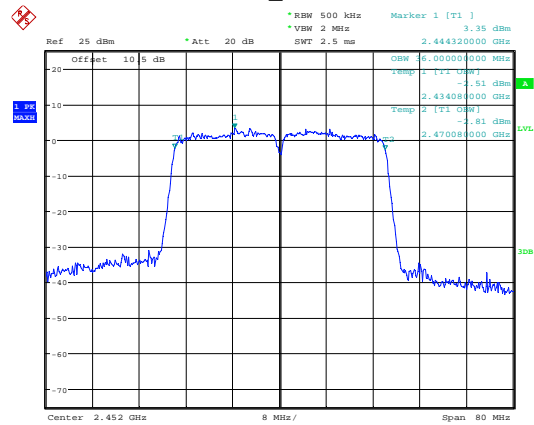

ProjectNo.:XMDN240205-07900E Tester:Alice Tan  
Date: 30.MAR.2024 11:35:04

**5.5 Maximum Conducted Output Power**

<b>Serial No.:</b>	2HNF-2	<b>Test Date:</b>	2024/3/30
<b>Test Site:</b>	RF	<b>Test Mode:</b>	Transmitting
<b>Tester:</b>	Alice Tan	<b>Test Result:</b>	Pass

**Environmental Conditions:**

<b>Temperature:</b> (°C)	26.3	<b>Relative Humidity:</b> (%)	49	<b>ATM Pressure:</b> (kPa)	100.8
-----------------------------	------	----------------------------------	----	-------------------------------	-------

**Test Equipment List and Details:**

Manufacturer	Description	Model	Serial Number	Calibration Date	Calibration Due Date
Anritsu	Microwave Peak Power Sensor	MA24418A	12618	2023/09/04	2024/09/03
Eastsheep	Coaxial Attenuator	5W-N-JK-6G-10dB	F-08-EM502	2023/9/10	2024/9/9

\* Statement of Traceability: Bay Area Compliance Laboratories Corp. (Dongguan) attests that all calibrations have been performed, traceable to National Primary Standards and International System of Units (SI).

**Test Data:**

Mode	Conducted Peak Output Power (dBm)	Limit (dBm)	Result
b 2412MHz Chain 0	21.09	29.55	Pass
b 2437MHz Chain 0	21.3	29.55	Pass
b 2462MHz Chain 0	21.46	29.55	Pass
g 2412MHz Chain 0	23.3	29.55	Pass
g 2437MHz Chain 0	22.99	29.55	Pass
g 2462MHz Chain 0	23.16	29.55	Pass
n20 2412MHz Chain 0	23.7	29.55	Pass
n20 2437MHz Chain 0	<b>23.86</b>	29.55	Pass
n20 2462MHz Chain 0	22.67	29.55	Pass
n40 2422MHz Chain 0	23.32	29.55	Pass
n40 2437MHz Chain 0	23.67	29.55	Pass
n40 2452MHz Chain 0	22.22	29.55	Pass

Note:

- Maximum EIRP=23.86+6.45=30.31dBm<36dBm
- Conducted Power Limit: 30-6.45+6dBm=29.55dBm.

**5.6 Maximum Power Spectral Density**

<b>Serial No.:</b>	2HNF-2	<b>Test Date:</b>	2024/3/30
<b>Test Site:</b>	RF	<b>Test Mode:</b>	Transmitting
<b>Tester:</b>	Alice Tan	<b>Test Result:</b>	Pass

**Environmental Conditions:**

<b>Temperature:</b> (°C)	26.3	<b>Relative Humidity:</b> (%)	49	<b>ATM Pressure:</b> (kPa)	100.8
-----------------------------	------	----------------------------------	----	-------------------------------	-------

**Test Equipment List and Details:**

Manufacturer	Description	Model	Serial Number	Calibration Date	Calibration Due Date
R&S	Spectrum Analyzer	FSU 26	200160/026	2023/10/18	2024/10/17
Eastsheep	Coaxial Attenuator	5W-N-JK-6G-10dB	F-08-EM502	2023/9/10	2024/9/9

*\* Statement of Traceability: Bay Area Compliance Laboratories Corp. (Dongguan) attests that all calibrations have been performed, traceable to National Primary Standards and International System of Units (SI).*

**Test Data:**

Mode	Value (dBm/3kHz)	Limit (dBm/3kHz)	Result
b_2412MHz_Chain 0	-4.01	7.55	Pass
b_2437MHz_Chain 0	-4.56	7.55	Pass
b_2462MHz_Chain 0	-4.56	7.55	Pass
g_2412MHz_Chain 0	-12.23	7.55	Pass
g_2437MHz_Chain 0	-11.91	7.55	Pass
g_2462MHz_Chain 0	-12.15	7.55	Pass
n20_2412MHz_Chain 0	-10.77	7.55	Pass
n20_2437MHz_Chain 0	-10.96	7.55	Pass
n20_2462MHz_Chain 0	-12.34	7.55	Pass
n40_2422MHz_Chain 0	-14.96	7.55	Pass
n40_2437MHz_Chain 0	-15.26	7.55	Pass
n40_2452MHz_Chain 0	-16.45	7.55	Pass

Note:  
PSD Limit: 8-6.45+6dBm=7.55dBm.

b\_2412MHz

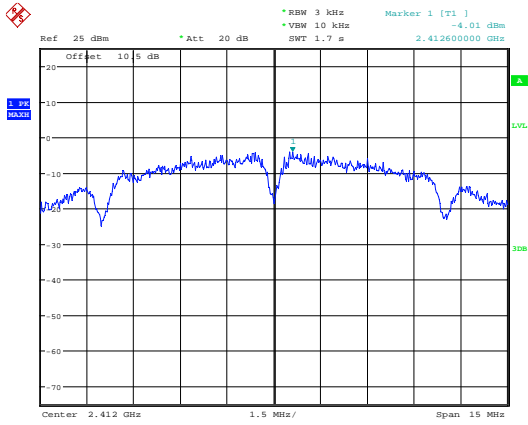

ProjectNo.:XMDN240205-07900E Tester:Alice Tan  
Date: 30.MAR.2024 11:55:42

b\_2437MHz

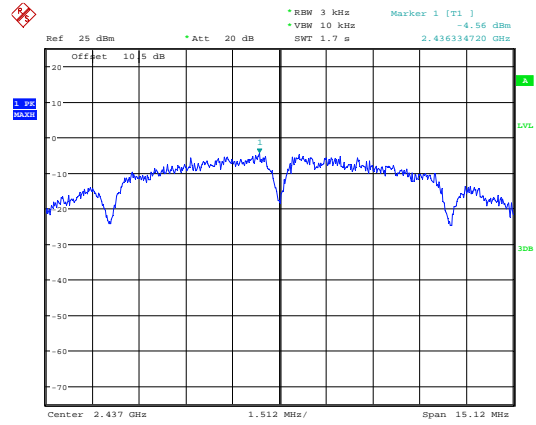

ProjectNo.:XMDN240205-07900E Tester:Alice Tan  
Date: 30.MAR.2024 11:54:00

b\_2462MHz

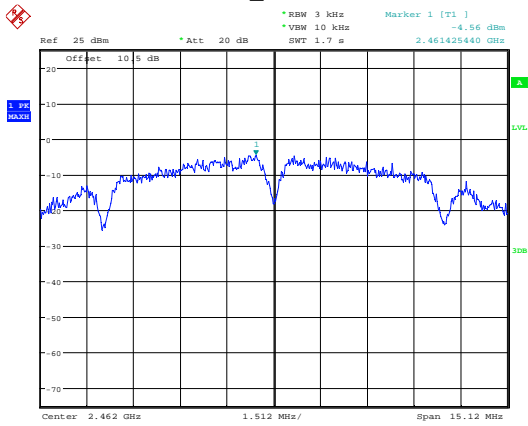

ProjectNo.:XMDN240205-07900E Tester:Alice Tan  
Date: 30.MAR.2024 11:52:41

g\_2412MHz

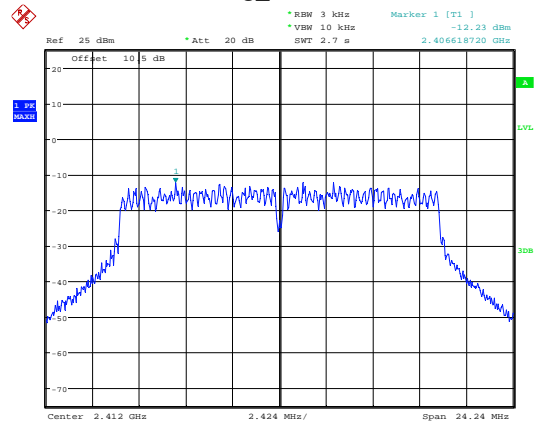

ProjectNo.:XMDN240205-07900E Tester:Alice Tan  
Date: 30.MAR.2024 11:49:57

g\_2437MHz

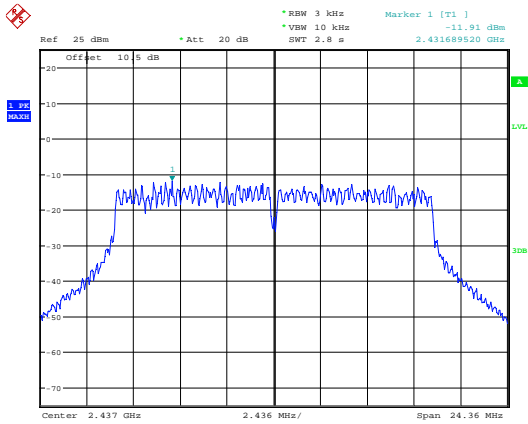

ProjectNo.:XMDN240205-07900E Tester:Alice Tan  
Date: 30.MAR.2024 11:47:32

g\_2462MHz

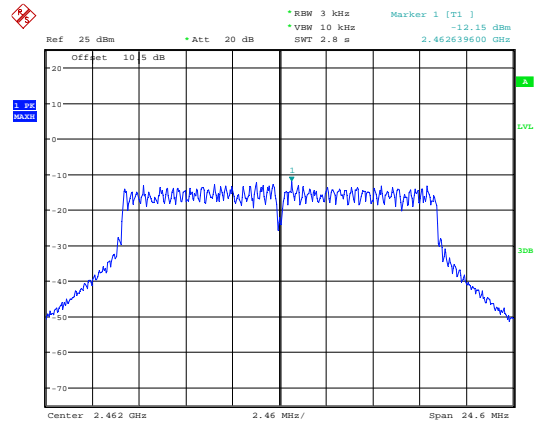

ProjectNo.:XMDN240205-07900E Tester:Alice Tan  
Date: 30.MAR.2024 11:46:07

n20\_2412MHz

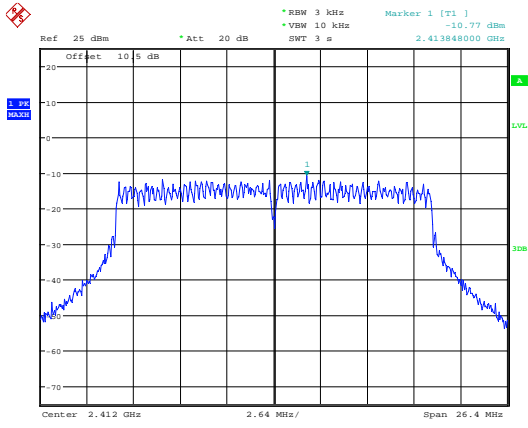

ProjectNo.:XMDN240205-07900E Tester:Alice Tan  
Date: 30.MAR.2024 11:41:38

n20\_2437MHz

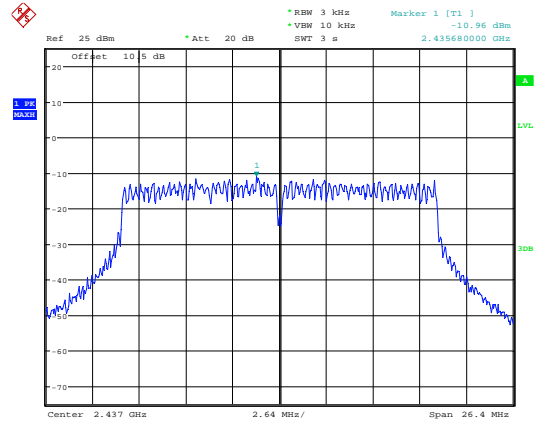

ProjectNo.:XMDN240205-07900E Tester:Alice Tan  
Date: 30.MAR.2024 11:43:14

n20\_2462MHz

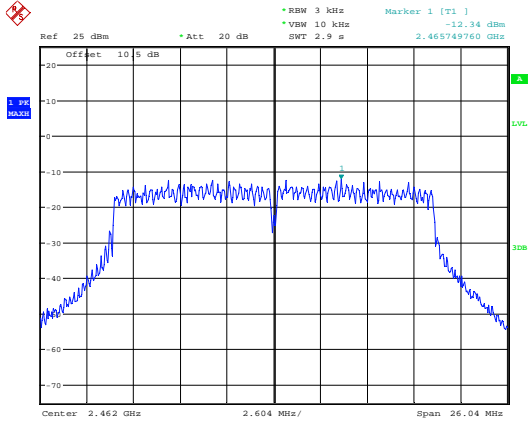

ProjectNo.:XMDN240205-07900E Tester:Alice Tan  
Date: 30.MAR.2024 11:44:32

n40\_2422MHz

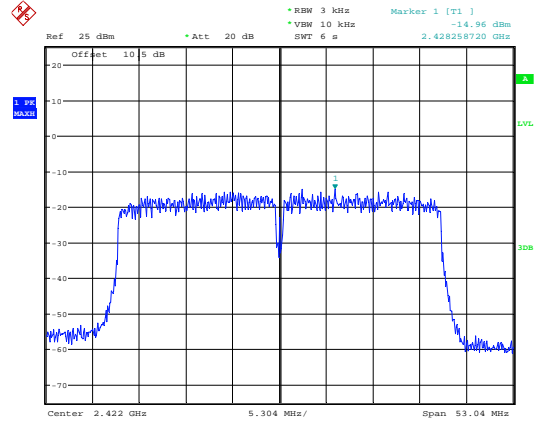

ProjectNo.:XMDN240205-07900E Tester:Alice Tan  
Date: 30.MAR.2024 11:40:21

n40\_2437MHz

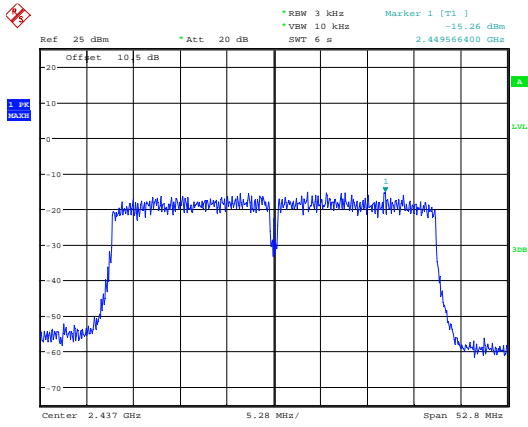

ProjectNo.:XMDN240205-07900E Tester:Alice Tan  
Date: 30.MAR.2024 11:38:35

n40\_2452MHz

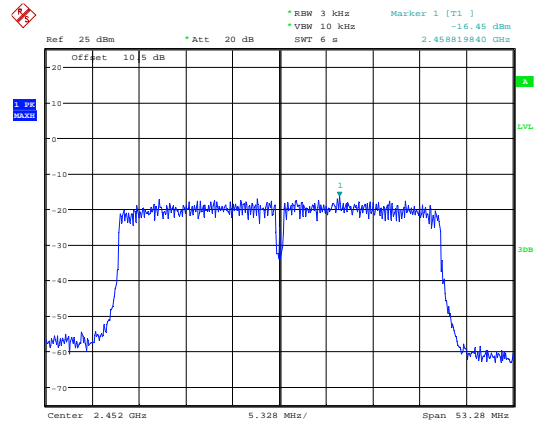

ProjectNo.:XMDN240205-07900E Tester:Alice Tan  
Date: 30.MAR.2024 11:36:10

**5.7 100 kHz Bandwidth of Frequency Band Edge:**

<b>Serial No.:</b>	2HNF-2	<b>Test Date:</b>	2024/3/30
<b>Test Site:</b>	RF	<b>Test Mode:</b>	Transmitting
<b>Tester:</b>	Alice Tan	<b>Test Result:</b>	Pass

**Environmental Conditions:**

<b>Temperature:</b> (°C)	26.3	<b>Relative Humidity:</b> (%)	49	<b>ATM Pressure:</b> (kPa)	100.8
-----------------------------	------	----------------------------------	----	-------------------------------	-------

**Test Equipment List and Details:**

Manufacturer	Description	Model	Serial Number	Calibration Date	Calibration Due Date
R&S	Spectrum Analyzer	FSU 26	200160/026	2023/10/18	2024/10/17
Eastsheep	Coaxial Attenuator	5W-N-JK-6G-10dB	F-08-EM502	2023/9/10	2024/9/9

*\* Statement of Traceability: Bay Area Compliance Laboratories Corp. (Dongguan) attests that all calibrations have been performed, traceable to National Primary Standards and International System of Units (SI).*

**Test Data:**

Please refer to the following plots.



b\_2412MHz

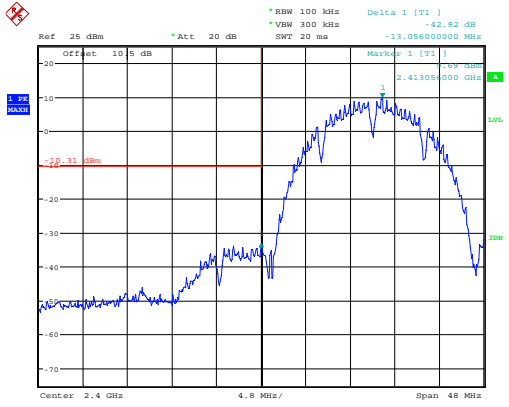

ProjectNo.:XMDN240205-07900E Tester:Alice Tan  
Date: 30.MAR.2024 11:51:40

b\_2462MHz

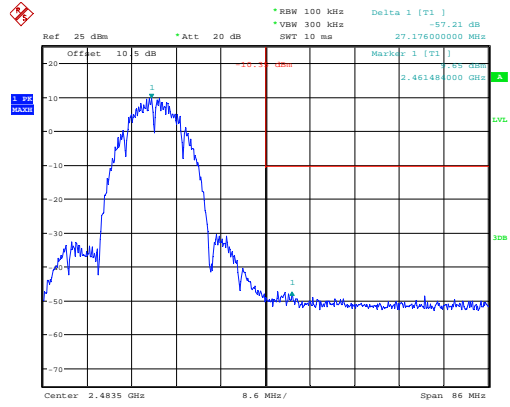

ProjectNo.:XMDN240205-07900E Tester:Alice Tan  
Date: 30.MAR.2024 11:52:54

g\_2412MHz

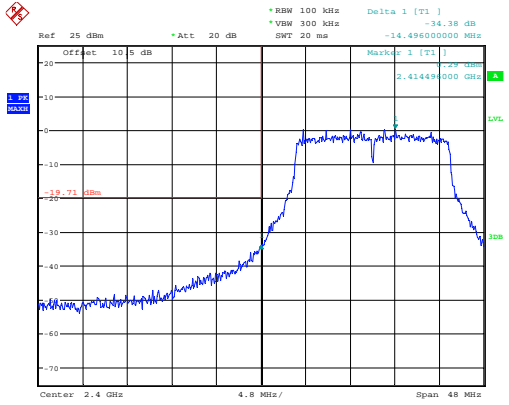

ProjectNo.:XMDN240205-07900E Tester:Alice Tan  
Date: 30.MAR.2024 11:50:11

g\_2462MHz

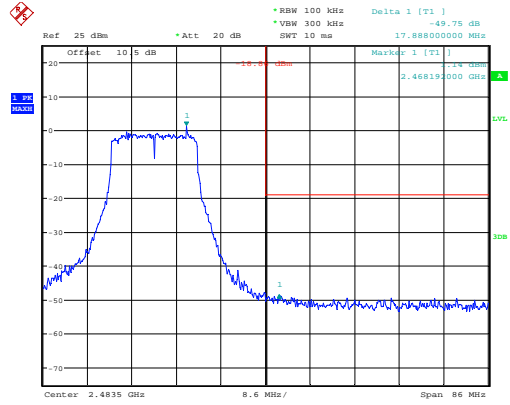

ProjectNo.:XMDN240205-07900E Tester:Alice Tan  
Date: 30.MAR.2024 11:46:20

n20\_2412MHz

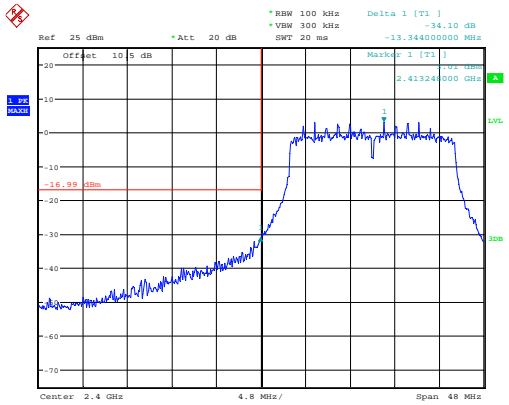

ProjectNo.:XMDN240205-07900E Tester:Alice Tan  
Date: 30.MAR.2024 11:41:51

n20\_2462MHz\_

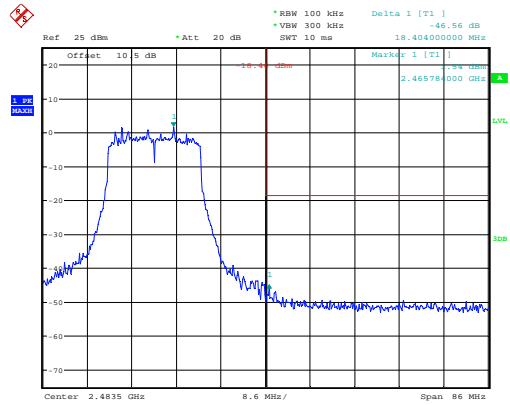

ProjectNo.:XMDN240205-07900E Tester:Alice Tan  
Date: 30.MAR.2024 11:44:48

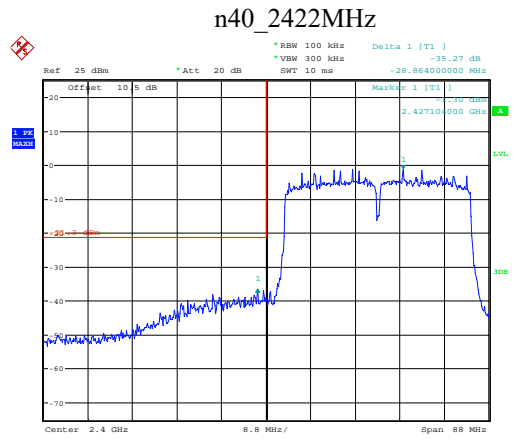

ProjectNo.:XMDN240205-07900E Tester:Alice Tan  
Date: 30.MAR.2024 11:40:34

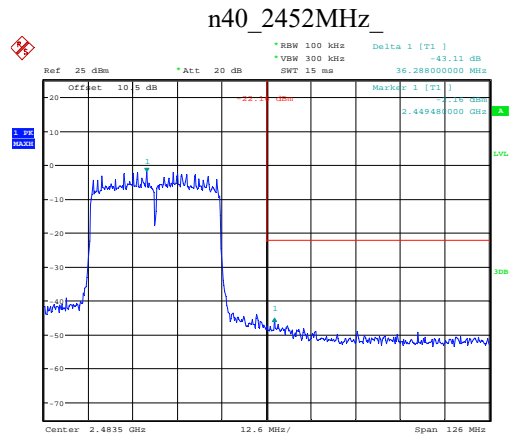

ProjectNo.:XMDN240205-07900E Tester:Alice Tan  
Date: 30.MAR.2024 11:36:23

**5.8 Duty Cycle:**

<b>Serial No.:</b>	2HNF-2	<b>Test Date:</b>	2024/3/30
<b>Test Site:</b>	RF	<b>Test Mode:</b>	Transmitting
<b>Tester:</b>	Alice Tan	<b>Test Result:</b>	Pass

**Environmental Conditions:**

<b>Temperature:</b> (°C)	26.3	<b>Relative Humidity:</b> (%)	49	<b>ATM Pressure:</b> (kPa)	100.8
-----------------------------	------	----------------------------------	----	-------------------------------	-------

**Test Equipment List and Details:**

Manufacturer	Description	Model	Serial Number	Calibration Date	Calibration Due Date
R&S	Spectrum Analyzer	FSU 26	200160/026	2023/10/18	2024/10/17
Eastsheep	Coaxial Attenuator	5W-N-JK-6G-10dB	F-08-EM502	2023/9/10	2024/9/9

\* Statement of Traceability: Bay Area Compliance Laboratories Corp. (Dongguan) attests that all calibrations have been performed, traceable to National Primary Standards and International System of Units (SI).

**Test Data:**

Mode	Ton (ms)	Ton+Toff (ms)	Duty Cycle (%)	1/T (Hz)	VBW Setting (kHz)
b_2437MHz_Chain 0	12.621	12.781	98.75	/	0.01
g_2437MHz_Chain 0	2.14	/	Not constant	467	0.5
n20_2437MHz_Chain 0	1.936	/	Not constant	517	1
n40_2437MHz_Chain 0	0.968	/	Not constant	1033	2

Duty Cycle = Ton/(Ton+Toff)\*100%

b\_2437MHz

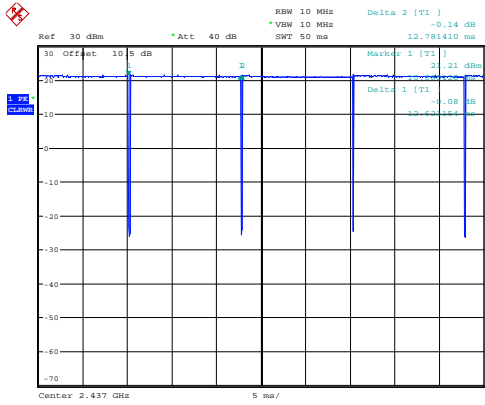

ProjectNo.:XMDN240205-07900E Tester:Alice Tan  
Date: 30.MAR.2024 13:10:33

g\_2437MHz

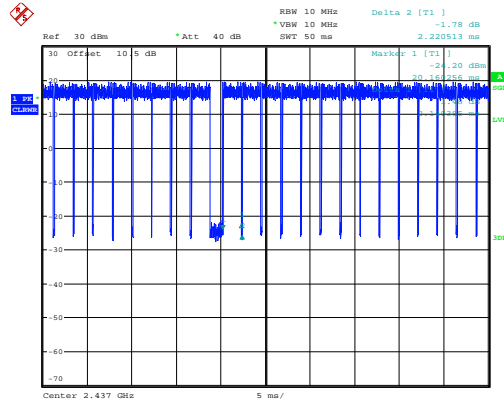

ProjectNo.:XMDN240205-07900E Tester:Alice Tan  
Date: 30.MAR.2024 11:59:59

n20\_2437MHz

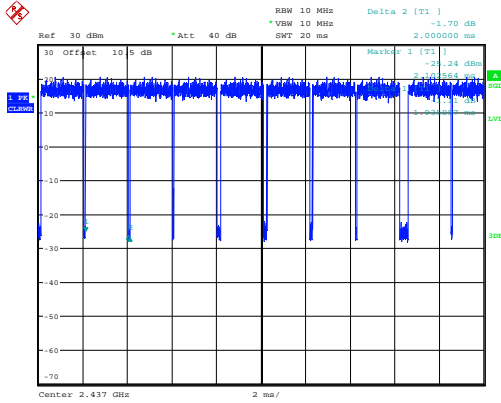

ProjectNo.:XMDN240205-07900E Tester:Alice Tan  
Date: 30.MAR.2024 13:13:32

n40\_2437MHz

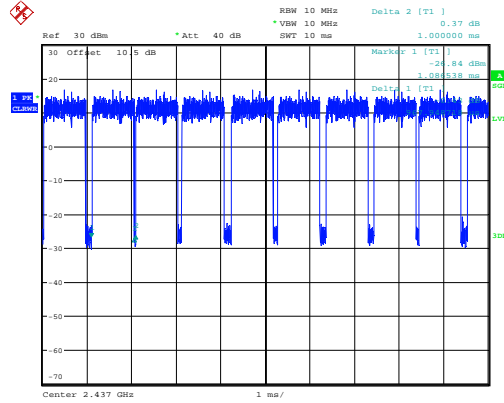

ProjectNo.:XMDN240205-07900E Tester:Alice Tan  
Date: 30.MAR.2024 13:15:52

## **APPENDIX A - EUT PHOTOGRAPHS**

---

Please refer to the attachment XMDN240205-07900E-RF-EXP EUT EXTERNAL PHOTOGRAPHS and XMDN240205-07900E-RF-INP EUT INTERNAL PHOTOGRAPHS

## **APPENDIX B - TEST SETUP PHOTOGRAPHS**

---

Please refer to the attachment XMDN240205-07900E-RF-00B-TSP TEST SETUP PHOTOGRAPHS.

## APPENDIX C - RF EXPOSURE EVALUATION

### Maximum Permissible Exposure (MPE)

#### Applicable Standard

According to subpart §1.1310,15.247(i) systems operating under the provisions of this section shall be operated in a manner that ensures that the public is not exposed to radio frequency energy level in excess of the Commission’s guidelines.

Limits for Maximum Permissible Exposure (MPE) (§1.1310, §2.1091)

(B) Limits for General Population/Uncontrolled Exposure				
Frequency Range (MHz)	Electric Field Strength (V/m)	Magnetic Field Strength (A/m)	Power Density (mW/cm <sup>2</sup> )	Averaging Time (minutes)
0.3–1.34	614	1.63	*(100)	30
1.34–30	824/f	2.19/f	*(180/f <sup>2</sup> )	30
30–300	27.5	0.073	0.2	30
300–1500	/	/	f/1500	30
1500–100,000	/	/	1.0	30

f = frequency in MHz; \* = Plane-wave equivalent power density;

According to §1.1310 and §2.1091 RF exposure is calculated.

#### Calculation formula:

Prediction of power density at the distance of the applicable MPE limit

$S = PG/4\pi R^2$  = power density (in appropriate units, e.g. mW/cm<sup>2</sup>);

P = power input to the antenna (in appropriate units, e.g., mW);

G = power gain of the antenna in the direction of interest relative to an isotropic radiator, the power gain factor, is normally numeric gain;

R = distance to the center of radiation of the antenna (appropriate units, e.g., cm);

#### Calculated Data:

Mode	Frequency (MHz)	Antenna Gain		Conducted output power including Tune-up Tolerance		Evaluation Distance (cm)	Power Density (mW/cm <sup>2</sup> )	MPE Limit (mW/cm <sup>2</sup> )
		(dBi)	(numeric)	(dBm)	(mW)			
BDR/EDR	2402-2480	6.45	4.42	8	6.31	20.00	0.006	1.0
BLE	2402-2480	6.45	4.42	7	5.01	20.00	0.004	1.0
WiFi-2.4G	2412-2462	6.45	4.42	24	251.19	20.00	0.22	1.0

Note:

The Conducted output power including Tune-up Tolerance provided by manufacturer BDR/EDR/BLE/WiFi-2.4G can’t transmit simultaneously

**Result:** The device meet FCC MPE at 20 cm distance

## Exemption Limits For Routine Evaluation-RF Exposure Evaluation

### Applicable Standard

According to RSS-102 clause 2.5.2:

RF exposure evaluation is required if the separation distance between the user and/or bystander and the device's radiating element is greater than 20 cm, except when the device operates as follows:

- below 20 MHz and the source-based, time-averaged maximum e.i.r.p. of the device is equal to or less than 1 W (adjusted for tune-up tolerance);
- at or above 20 MHz and below 48 MHz and the source-based, time-averaged maximum e.i.r.p. of the device is equal to or less than  $4.49/f^{0.5}$  W (adjusted for tune-up tolerance), where  $f$  is in MHz;
- at or above 48 MHz and below 300 MHz and the source-based, time-averaged maximum e.i.r.p. of the device is equal to or less than 0.6 W (adjusted for tune-up tolerance);
- at or above 300 MHz and below 6 GHz and the source-based, time-averaged maximum e.i.r.p. of the device is equal to or less than  $1.31 \times 10^{-2} f^{0.6834}$  W (adjusted for tune-up tolerance), where  $f$  is in MHz;
- at or above 6 GHz and the source-based, time-averaged maximum e.i.r.p. of the device is equal to or less than 5 W (adjusted for tune-up tolerance).

In these cases, the information contained in the RF exposure technical brief may be limited to information that demonstrates how the e.i.r.p. was derived.

### Calculated Data:

Mode	Frequency (MHz)	Antenna Gain	Conducted output power including Tune-up Tolerance	EIRP		Exemption limits (mW)
		(dBi)	(dBm)	(dBm)	(mW)	
BDR/EDR	2402-2480	6.45	8	14.45	27.86	2676
BLE	2402-2480	6.45	7	13.45	22.13	2676
WiFi-2.4G	2412-2462	6.45	24	30.45	1109.17	2684

Note: The Conducted output power including Tune-up Tolerance was provided by manufacturer.

**Result:** So the device is compliance with the exemption from Routine Evaluation Limits –RF exposure Evaluation.

\*\*\*\*\* END OF REPORT \*\*\*\*\*