

Parrot®

FLYPAD

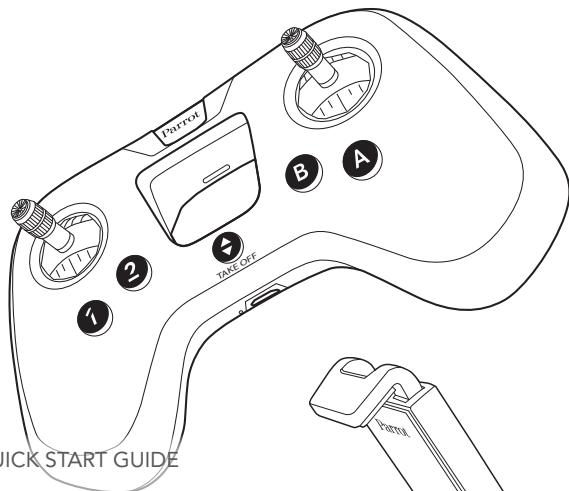

QUICK START GUIDE

GUIDE D'UTILISATION RAPIDE

GUÍA DE UTILIZACIÓN RÁPIDA

SCHNELLSTART-ANLEITUNG

GUIDA DI RIFERIMENTO RAPIDO

BEKNOPTE GEBRUIKSHANDLEIDING

GUIA DE UTILIZAÇÃO RÁPIDA

دليل المستخدم المختصر

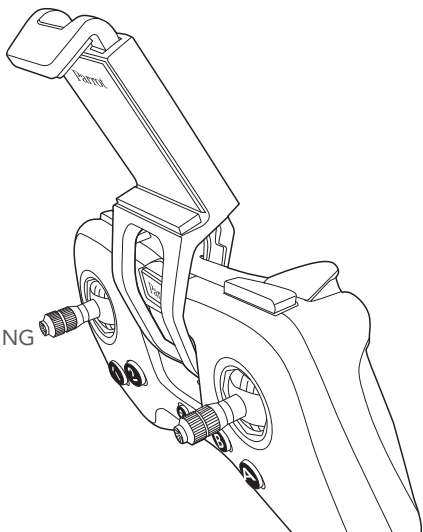

English.....	4
Français	25
Español.....	46
Deutsch	67
Italiano	88
Nederlands.....	108
Português.....	128
العربية	149

PRESENTATION OF THE PARROT FLYPAD

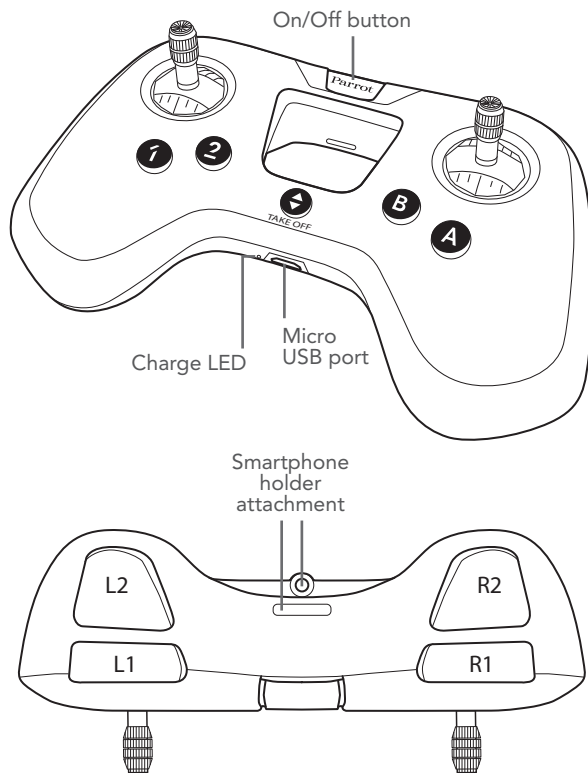

CHARGING THE BATTERY

1. Connect the micro USB cable to the Parrot Flypad's micro USB port.
2. Connect the USB port to a computer or a USB power adapter.
 - > The charge LED turns red to indicate that charging is in progress. Once charging is complete, the LED turns green.

The charge time is approximately 2 hours. Once charged, the Parrot Flypad has a battery life of about 6 hours.

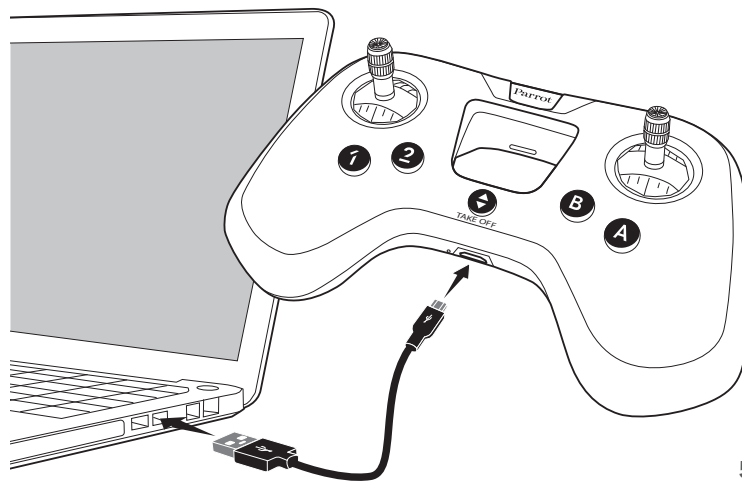

CONNECTING THE PARROT FLYPAD TO YOUR DRONE

1. Turn on your drone.
2. Press the Parrot Flypad's ON/OFF button to turn it on.
 - > The Parrot Flypad's warning light flashes green and then becomes a steady green when the connection is established.

You are connected to the drone, and you can fly it.

ATTACHING THE SMARTPHONE HOLDER

Before using the Parrot Flypad's smartphone holder, make sure your smartphone does not exceed the following dimensions:

- Width: 78 mm.
- Thickness: 9.8 mm.

1. Secure the smartphone holder's tab in the Parrot Flypad's slot.

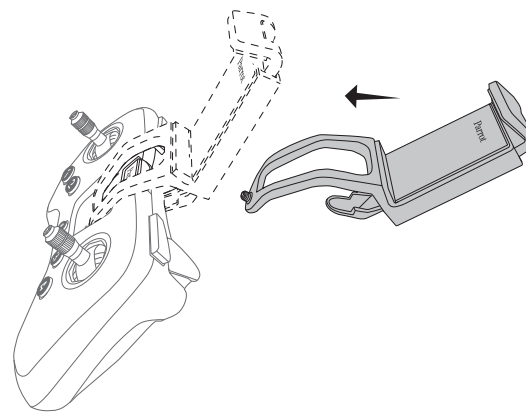

2. Screw on the holder.

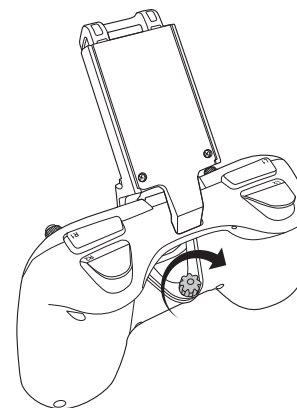

3. Fit your smartphone in the holder.

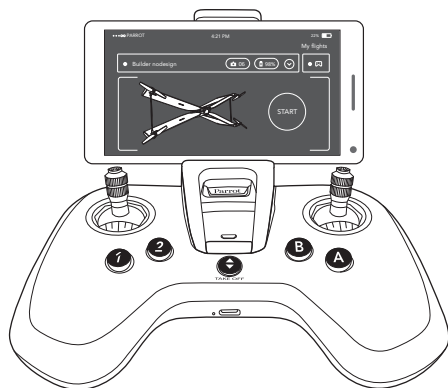

CONFIGURING THE PARROT FLYPAD'S BUTTONS



DOWNLOAD THE FREEFLIGHT MINI APPLICATION

Login to the App Store® or Google Play™ and download the free FreeFlight Mini application to your smartphone or tablet.

CONNECT YOUR SMARTPHONE TO THE PARROT FLYPAD AND THE PARROT DRONE

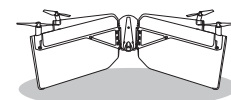
1. Make sure your Parrot Flypad is switched off.
2. Turn on your Parrot drone.
3. Place the Parrot drone on a flat surface with the propellers up.
4. Wait until the warning lights on the Parrot drone turn green.
5. On your smartphone, turn on the Bluetooth® function and open the FreeFlight Mini application.
 - > The list of available Parrot drones appears.
6. Select your Parrot drone.
 - > The application connects to the Parrot drone.



7. Turn on your Parrot Flypad.
 - > The Parrot Flypad's warning light flashes green.
8. In the FreeFlight Mini application, press 
9. Press  to display the drop-down list.
10. Select your Parrot Flypad.
 - > The warning light on the Parrot Flypad turns green: you are connected. You can configure the buttons of the Parrot Flypad.

CONFIGURING THE BUTTONS

Before you start, make sure your smartphone is connected to the Parrot Flypad and the Parrot drone.

1. In the FreeFlight Mini application, press 
 - > The list of functions associated with the Parrot Flypad buttons appears.

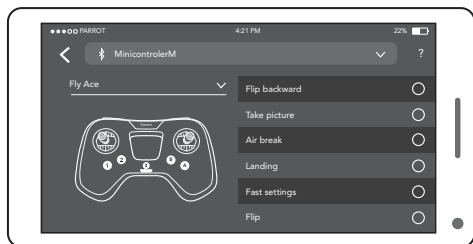

2. In the application, press the function you want to change to select it.
3. On your Parrot Flypad, press the button you want to assign the function to.
 - > The button and the function are associated.

To return to the default settings, press Reset.

TURNING OFF THE PARROT FLYPAD

To turn off the Parrot Flypad, press and hold down the On/Off button.

WARNING LIGHT INDICATIONS

Steady green light	The Parrot Flypad is connected to the Parrot drone or your smartphone.
Flashing green light	The Parrot Flypad is waiting for a connection.
Flashing red light	The Parrot Flypad is waiting for a connection, but its battery is low. > Charge the Parrot Flypad's battery.
Steady red light	The Parrot Flypad is connected to your smartphone or your Parrot drone, but its battery is low. > Charge your Parrot Flypad's battery.
Steady red light and the Parrot Flypad is vibrating	The Parrot Flypad is connected to your smartphone or your Parrot drone, but the Parrot drone's battery is low. > Charge your Parrot drone's battery.

GENERAL INFORMATION

PRECAUTIONS FOR USE AND MAINTENANCE

The Parrot Flypad is intended to fly the Parrot Mambo and the Parrot Swing and is not suitable for children under 14 years of age.

Check the list of drones that are compatible with the Parrot Flypad in the Support section on www.parrot.com.

Only use accessories specified by Parrot Drones SAS.

If sand or dust gets into the Parrot Flypad, it may be irreparably damaged and no longer function correctly.

Do not expose the Parrot Flypad to rain or sun for an extended period.

Do not use this device near liquids.

Risk of ingestion of small objects. The packaging is not part of the product and must be discarded as a safety measure.

WARNING REGARDING PRIVACY AND RESPECT FOR IMAGES OF PROPERTY

Recording and broadcasting an individual's image without their permission may constitute an invasion of privacy and you may be held liable. Ask permission before filming people, especially if you intend to keep your recordings and/or broadcast them. Do not broadcast degrading images which may affect an individual's reputation or dignity.

Recording and broadcasting the image of property without permission from its owner and/or any third party holding intellectual property rights on the property may constitute a violation of the property's image rights and you may be held liable. Ask permission from its owner and/or any third party with ownership rights.

WARRANTY

For the warranty conditions, please read the Terms and Conditions of sale of the retailer where you purchased the Parrot Flypad.

HOW TO RECYCLE THIS PRODUCT



This symbol on the product or its documentation indicates that it must not be disposed of with household waste. Uncontrolled waste disposal may harm the environment or human health. Please separate your device from other types of waste to recycle it responsibly. This will help to foster the sustainable re-use of material resources. We invite you to contact your retailer or inquire at your local town hall to find out where and how the Parrot Flypad can be recycled.

CONFORMITY DECLARATION

PARROT DRONES, 174 quai de Jemmapes, 75010 Paris, France, hereby declares that it is solely responsible for the compliance of the product described in this user guide with technical standards, EN 301489-17, EN300328, EN71-1, EN71-2, EN71-3, EN62115, EN62321 (1-7), according to the provisions of the R&TTE Directive 1999/5/EC and the General Product Safety Directive 2001/95/EC, the ROHS Directive 2011/65/EU. <http://www.parrot.com/uk/ce/?parrot-flypad><http://www.parrot.com/ce/?parrot-flypad>

DECLARATION OF CONFORMITY IN CANADA

This device complies with the Industry Canada RSS applicable to license-exempt radio apparatus. Operation is permitted subject to the following two conditions: (1) the device must not produce interference, and (2) the user of the device must accept any radio interference encountered, even if the interference is likely to compromise operations.

TRADEMARKS

Parrot Flypad, Parrot Swing as well as their respective logos are trademarks of Parrot Drones SAS.

Parrot and the Parrot logos are trademarks of Parrot S.A.

App Store is a trademark of Apple Inc.

Google Play is a trademark of Google Inc.

The Bluetooth® name and logo are registered trademarks of Bluetooth SIG, Inc. and any use of these trademarks by Parrot Drones SAS is done under licence. All other trademarks mentioned in this guide are the property of their respective owners.

MANUFACTURER INFORMATION

The Parrot Flypad is manufactured by: PARROT DRONES SAS - 174 Quai de Jemmapes - 75010 Paris (France) - Corporate and Trade Register Paris 808 408 074

www.parrot.com



PRÉSENTATION DU PARROT FLYPAD

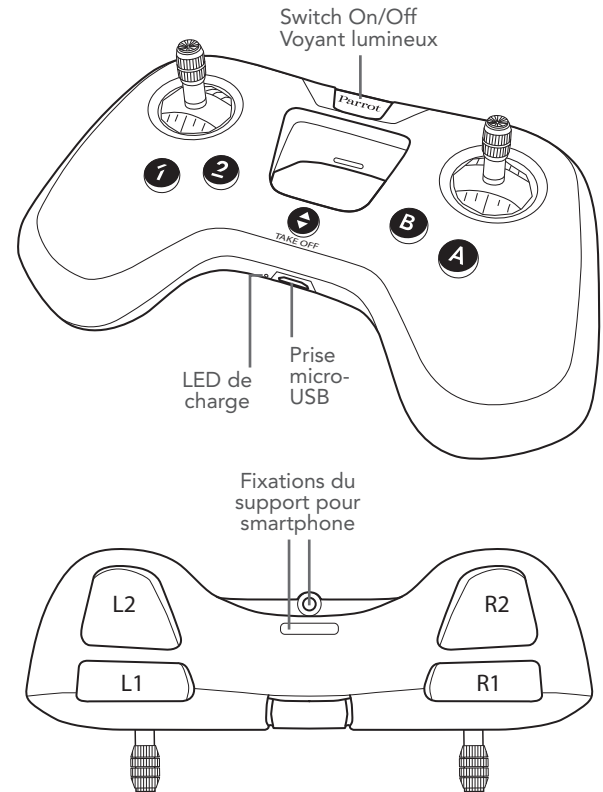

This device complies with part 15 of the FCC Rules. Operation is subject to the following two conditions: (1) This device may not cause harmful interference, and (2) this device must accept any interference received, including interference that may cause undesired operation.

Any Changes or modifications not expressly approved by the party responsible for compliance could void the user's authority to operate the equipment.

Note: This equipment has been tested and found to comply with the limits for a Class B digital device, pursuant to part 15 of the FCC Rules. These limits are designed to provide reasonable protection against harmful interference in a residential installation. This equipment generates uses and can radiate radio frequency energy and, if not installed and used in accordance with the instructions, may cause harmful interference to radio communications. However, there is no guarantee that interference will not occur in a particular installation. If this equipment does cause harmful interference to radio or television reception, which can be determined by turning the equipment off and on, the user is encouraged to try to correct the interference by one or more of the following measures:

- Reorient or relocate the receiving antenna.
- Increase the separation between the equipment and receiver.
- Connect the equipment into an outlet on a circuit different from that to which the receiver is connected.
- Consult the dealer or an experienced radio/TV technician for help.

This device complies with Industry Canada licence-exempt RSS standard(s).

Operation is subject to the following two conditions: (1) This device may not cause interference, and (2) This device must accept any interference, including interference that may cause undesired operation of the device.

Le présent appareil est conforme aux CNR d'Industrie Canada applicables aux appareils radio exempts de licence. L'exploitation est autorisée aux deux conditions suivantes:

- (1) l'appareil ne doit pas produire de brouillage, et
- (2) l'utilisateur de l'appareil doit accepter tout brouillage radioélectrique subi, même si le brouillage est susceptible d'en compromettre le fonctionnement.