

# CelloTrack XT LTE (LV300.PS) Overview



Cellocator Division  
Pointer Telocation Ltd.

Version 1.2

Revised and Updated: September 10, 2020

## Legal Notices

### IMPORTANT

1. All legal terms and safety and operating instructions should be read thoroughly before the product accompanying this document is installed and operated.
2. This document should be retained for future reference.
3. Attachments, accessories or peripheral devices not supplied or recommended in writing by Pointer Telocation Ltd. May be hazardous and/or may cause damage to the product and should not, in any circumstances, be used or combined with the product.

### General

The product accompanying this document is not designated for and should not be used in life support appliances, devices, machines or other systems of any sort where any malfunction of the product can reasonably be expected to result in injury or death. Customers of Pointer Telocation Ltd. using, integrating, and/or selling the product for use in such applications do so at their own risk and agree to fully indemnify Pointer Telocation Ltd. for any resulting loss or damages.

### Warranty Exceptions and Disclaimers

Pointer Telocation Ltd. Shall bear no responsibility and shall have no obligation under the foregoing limited warranty for any damages resulting from normal wear and tear, the cost of obtaining substitute products, or any defect that is (i) discovered by purchaser during the warranty period but purchaser does not notify Pointer Telocation Ltd. Until after the end of the warranty period, (ii) caused by any accident, force majeure, misuse, abuse, handling or testing, improper installation or unauthorized repair or modification of the product, (iii) caused by use of any software not supplied by Pointer Telocation Ltd., or by use of the product other than in accordance with its documentation, or (iv) the result of electrostatic discharge, electrical surge, fire, flood or similar causes. Unless otherwise provided in a written agreement between the purchaser and Pointer Telocation Ltd., the purchaser shall be solely responsible for the proper configuration, testing and verification of the product prior to deployment in the field.

POINTER TELOCATION LTD.'S SOLE RESPONSIBILITY AND PURCHASER'S SOLE REMEDY UNDER THIS LIMITED WARRANTY SHALL BE TO REPAIR OR REPLACE THE PRODUCT HARDWARE, SOFTWARE OR SOFTWARE MEDIA (OR IF REPAIR OR REPLACEMENT IS NOT POSSIBLE, OBTAIN A REFUND OF THE PURCHASE PRICE) AS PROVIDED ABOVE. POINTER TELOCATION LTD. EXPRESSLY DISCLAIMS ALL OTHER WARRANTIES OF ANY KIND, EXPRESS OR IMPLIED, INCLUDING WITHOUT LIMITATION ANY IMPLIED WARRANTIES OF NON-INFRINGEMENT, MERCHANTABILITY, SATISFACTORY PERFORMANCE AND FITNESS FOR A PARTICULAR PURPOSE. IN NO EVENT SHALL POINTER TELOCATION LTD. BE LIABLE FOR ANY INDIRECT, SPECIAL, EXEMPLARY, INCIDENTAL OR CONSEQUENTIAL DAMAGES (INCLUDING WITHOUT LIMITATION LOSS OR INTERRUPTION OF USE, DATA, REVENUES OR PROFITS) RESULTING FROM A BREACH OF THIS WARRANTY OR BASED ON ANY OTHER LEGAL THEORY, EVEN IF POINTER TELOCATION LTD. HAS BEEN ADVISED OF THE POSSIBILITY OR LIKELIHOOD OF SUCH DAMAGES.

## Intellectual Property

Copyright in and to this document is owned solely by Pointer Telocation Ltd. Nothing in this document shall be construed as granting you any license to any intellectual property rights subsisting in or related to the subject matter of this document including, without limitation, patents, patent applications, trademarks, copyrights or other intellectual property rights, all of which remain the sole property of Pointer Telocation Ltd. Subject to applicable copyright law, no part of this document may be reproduced, stored in or introduced into a retrieval system, or transmitted in any form or by any means (electronic, mechanical, photocopying, recording or otherwise), or for any purpose, without the express written permission of Pointer Telocation Ltd.

## FCC & IC Compliance Statement

### The FCC Wants You to Know

This equipment has been tested and found to comply with the limits for a Class B digital device, pursuant to Part 15 of the FCC rules. These limits are designed to provide reasonable protection against harmful interference in a residential installation.

This equipment generates, uses and can radiate radio frequency energy and, if not installed and used in accordance with the instructions, may cause harmful interference to radio communications.

However, there is no guarantee that interference will not occur in a particular installation. If this equipment does cause harmful interference radio or television reception, which can be determined by turning the equipment off and on, the user is encouraged to try to correct the interference by one or more of the following measures:

- a) Reorient or relocate the receiving antenna.
- b) Increase the separation between the equipment and receiver.
- c) Connect the equipment to an outlet on a circuit different from that to which the receiver is connected.
- d) Consult the dealer or an experienced radio/TV technician

This device complies with FCC Rules Part 15:

Operation is subject to two conditions:

(1) This device may not cause harmful interference, and (2) this device must accept any interference that may be received or that may cause undesired operation.

## CelloTrack XT LTE Overview



This device complies with Industry Canada licence-exempt RSS standard(s). Operation is subject to two conditions:  
(1) This device may not cause harmful interference, and (2) this device must accept any interference that may be received or that may cause undesired operation.

Le present appareil est conforme aux CNR d'Industrie Canada applicables aux appareils radio exempts de licence. L'exploitation est autorisee aux deux conditions suivantes : (1) l'appareil ne doit pas produire de brouillage, et (2) l'utilisateur de l'appareil doit accepter tout brouillage radioelectrique subi, meme si le brouillage est susceptible d'en compromettre le fonctionnement.

### Warning

Modifications not expressly approved by the manufacturer could void the user authority to operate the equipment under FCC Rules.

A distance of at least 20 cm. between the equipment and all persons should be maintained during the operation of the equipment.  
Une distance d'au moins 20 cm. entre l'équipement et toutes les personnes devraient être maintenues pendant le fonctionnement de l'équipement

© Copyright 2020. All rights reserved.

## Table of Contents

<b>1</b>	<b>Introduction .....</b>	<b>7</b>
1.1	About this Document .....	7
1.2	CelloTrack XT LTE Branding .....	7
1.3	Abbreviations .....	7
1.4	References .....	8
1.5	Revision History .....	8
<b>2</b>	<b>The CelloTrack LTE Plus Overview .....</b>	<b>9</b>
2.1	Overview.....	9
<b>2.2</b>	<b>Main Advantages over the CelloTrack T .....</b>	<b>10</b>
<b>3</b>	<b>The CelloTrack LTE Plus Variants .....</b>	<b>11</b>
3.1	The CelloTrack Standalone .....	11
3.2	The CelloTrack Power.....	11
3.3	The CelloTrack Lighter .....	11
3.4	CelloTrack LTE Plus Variants .....	12
3.5	CelloTrack Accessories .....	12
3.6	The CelloTrack Cradle .....	13
3.7	The CelloTrack Magnetic Cradle.....	14
<b>4</b>	<b>The CelloTrack LTE Plus Description .....</b>	<b>15</b>
4.1	CelloTrack Interfaces .....	15
4.1.1	<i>The CelloTrack Standalone Interface .....</i>	<i>15</i>
4.1.2	<i>The CelloTrack Power Interface .....</i>	<i>16</i>
4.1.3	<i>CelloTrack Front Button and LEDs .....</i>	<i>16</i>
4.1.4	<i>CelloTrack Connector .....</i>	<i>16</i>
4.1.5	<i>CelloTrack Power Harness .....</i>	<i>17</i>
4.2	CelloTrack COMM LED description.....	18
4.2.1	<i>Overview .....</i>	<i>18</i>
4.2.2	<i>Cellular Network Monitoring Zone .....</i>	<i>18</i>
4.2.3	<i>GNSS Monitoring Zone .....</i>	<i>20</i>
4.3	User Features .....	21
4.3.1	<i>Activation .....</i>	<i>21</i>
4.3.2	<i>De-Activation .....</i>	<i>21</i>
4.3.3	<i>Panic/Distress .....</i>	<i>21</i>
4.3.4	<i>Battery Status Manual Check .....</i>	<i>21</i>
4.4	BLE Functionality.....	22
4.5	MultiSense and MultiSense-TH .....	22
4.6	CelloTrack Feature List.....	23

# CelloTrack XT LTE Overview



<b>5</b>	<b>CelloTrack Operational States .....</b>	<b>25</b>
5.1	Not Activated State .....	25
5.2	Hibernation State .....	25
5.2.1	<i>Glancing</i> .....	26
5.2.2	<i>Specific Time Glancing</i> .....	27
5.2.3	<i>Not Live Tracking</i> .....	27
5.3	Tracking State .....	28
5.3.1	<i>Live Tracking</i> .....	29
5.3.2	<i>Tracking with GNSS Peeking</i> .....	29
5.3.3	<i>Offline Tracking</i> .....	30
5.3.4	<i>Improved (Take Location) Tracking Mode</i> .....	31
5.3.5	<i>BOD/EOD Tracking Mode</i> .....	31
5.4	Radio-Off .....	32
5.5	Motion Detection .....	32
<b>6</b>	<b>CelloTrack Power Features.....</b>	<b>34</b>
<b>7</b>	<b>CelloTrack LTE Plus Specifications .....</b>	<b>35</b>
<b>8</b>	<b>CelloTrack Release Package .....</b>	<b>38</b>
8.1	Evaluation Suite.....	38
8.1.1	<i>Communication Center</i> .....	38
8.1.2	<i>Cellocator Programmer</i> .....	38
8.2	Integration Package (Cellocator GW) .....	39
8.3	Cellocator Wireless Communication Protocol .....	39
8.4	Cellocator Integration Package Manual.....	39
8.5	Evaluation Suite Manual .....	39
8.6	Cellocator Programmer Manual .....	40
8.7	Integration Manual .....	40
8.8	Training Presentation.....	40



## 1 Introduction

### 1.1 About this Document

This document provides a brief overview of the CelloTrack XT LTE and its accessories. It includes descriptions of the CelloTrack variants, CelloTrack special features and modes of operation, battery life tables and technical specifications.

This document describes the high-level system features and capabilities of the CelloTrack XT LTE. For further details about MultiSense devices, the other main component of the CelloTrack LTE Plus solution, refer to the *MultiSense Product Overview*.

### 1.2 CelloTrack XT LTE Branding

The CelloTrack XT LTE has two main branding, each one supports two variants, as follows:

1. CelloTrack LTE Plus Brand
  - a. CelloTrack XT LTE C1 NA
  - b. CelloTrack Power XT LTE C1 NA
2. LV300 Brand
  - a. LV300
  - b. LV300.PS

This document refer to the CelloTrack LTE Plus brand, but the information is relevant to the LV300 brand as well.

The LV300 variant is identical to the CelloTrack Power XT LTE C1 NA variant.

The LV300.PS has the same infrastructure and RF interfaces as the other variants and it's two I/O lines have different functionalities.

### 1.3 Abbreviations

Abbreviation	Description
FB	Front Button
GSM	Global System for Mobile communications
GPS	Global Positioning System
GNSS	Global Navigation Satellite System
OTA	Over the Air
SMS	Short Message Service (GSM)
IP	International Protection Rating
8M	Eight Months
AH	Amper Hour
3D	3 Dimensions
LED	Light Emitted Diode
APS	Automatic Power Save (modem feature)
GPIO	General Purpose Input / Output



# CelloTrack LTE Plus Overview



## 1.4 References

#	Reference	Description
1	Programmer Manual	
2	Wireless Communication Protocol	

## 1.5 Revision History

Version	Date	Description





## 2 The CelloTrack LTE Plus Overview

### 2.1 Overview

CelloTrack's CelloTrack LTE Plus is designed for advanced asset tracking and asset management applications, and provides enhanced functionality, ease of installation and support for a wide range of applications: target applications include inventory management throughout short/mid-term Track & Trace, shipment and distribution management, security (anti-theft), protection (anti-vandal, break-in detection) and more.

The capabilities provided by the CelloTrack LTE can greatly reduce an enterprise's financial losses incurred as a result of the often-difficult task of successfully tracking and remotely managing the location, usage profile and security aspects of unpowered but mobile transportation equipment. This equipment includes trailers, containers, train wagons or any kind of valuable mobile asset such as electricity generators, heavy machinery, chemical toilets and waste containers.

The CelloTrack LTE unit can interface via a short-range RF link to multiple MultiSense devices, which acts as a Wireless Sensors Network (WSN). Read more about MultiSense devices in the *MultiSense and MultiSense-TH* section.

The unit includes a 6 pin connector for programming, covered by a rubber cover for dust and water protection (IP67).

The unit also provides a durable and long-life solution that supports up to 20 months of continuous operation (single GNSS readings and Cellular transmissions per day).

The unit supports the required network standards for NA and supports all the major service providers and their affiliates, such as AT&T, T-Mobile, Telus and Rogers.

Based on Cello and CelloTrack technologies, the CelloTrack LTE supports similar tracking, communication, GNSS location-based features and maintenance capabilities as per those available in the Cello and CelloTrack families.

Other CelloTrack LTE Plus features include:

- ◆ Stand-alone tracking device; it can be installed and operated for long periods without a power supply.
- ◆ Houses all components in the same enclosure, including battery, GNSS positioning engine, Cellular modem and antennas.
- ◆ Highly rugged durable IP67 weatherproof casing for outdoor long-life service.
- ◆ Long operation time (up to 20 months @ 1 transmission / day) via 5.3 Ah rechargeable Lithium Polymer battery.
- ◆ Purpose-built for minimum idle current consumption during hibernation.
- ◆ Supports NA LTE network with user equipment category CAT 1.
- ◆ Scalable Cellular communication technology; it can support any cellular network supported by the Cinterion modem family.
- ◆ CSR SiRFstarV™ based GPS and GLONASS positioning engine for reduced acquisition time and better accuracy.
- ◆ Supports a Wireless Sensor Network and up to 16 MultiSense devices.
- ◆ Two fully configurable general purpose I/O ports: Digital, Analog or Pulse Counter inputs or Open Collector outputs.
- ◆ A 3D accelerometer that detects crashes (accidents), movement and vibrations of assets and enables different transmission rates for a moving asset and a standing asset.



## CelloTrack LTE Plus Overview



- ◆ A programmable (on/off/test/panic) push button.
- ◆ Two monitoring LEDs for GSM and GNSS status indication.
- ◆ A charging and communication connector.
- ◆ Easy mounting using double-sided adhesive / screws / or magnetic cradle.
- ◆ Dual tampering detection: Cradle from surface or Unit from cradle.
- ◆ Designed for operation with minimal maintenance (environment tests, Halt tests, Formal reliability assessments).
- ◆ Operating temperature range: -30°C to 75°C.
- ◆ ISO16750 compliance (shock, temperature, humidity, UV, chemical, salt, and so on).
- ◆ Supports up to 9000 time-stamped events.
- ◆ Supports a variety of operation (logging and reporting frequency) profiles to meet required transmissions and power budget.
- ◆ Advanced carrier selection algorithm.
- ◆ Built-in Geo-fence capabilities.
- ◆ Supports an internal 6 pin connector allowing RMA and debugging.
- ◆ Supports OTA FW upgrade (FOTA).

## 2.2 Main Advantages over the CelloTrack T

- ◆ Supports 4G (LTE Cat1) Cellular networks.
- ◆ Extended operating temperature range (-30°C to 75°C instead of -20°C to 60°C)
- ◆ Supports a Wireless Sensor Network and up to 16 MultiSense devices.

### 3 The CelloTrack LTE Plus Variants

#### 3.1 The CelloTrack Standalone

The regular CelloTrack unit is designed for unpowered assets. It is ideal for trailers, containers, trains and other high value mobile assets.

The unit includes a 6-pin connector for battery charging, programming, and two general purpose I/Os which can function as dry contact inputs, threshold based input, analog input, frequency counter or open collector output (relay driver). The connector is covered by a rubber cover for dust and water protection (IP67).

The CelloTrack LTE with XT battery provides an asset tracking solution for environments of temperature range -30°C to +70°C and charging temperature range of -20°C to +60°C. The CelloTrack LTE support up to 20 months of single GPS readings and GPRS transmissions per day, utilizing a 5.3 Ah rechargeable Li-Poly battery.

The unit is charged via a dedicated charger from a standard electric wall outlet (110 / 230 V).



#### 3.2 The CelloTrack Power

The CelloTrack Power unit is designed specifically for assets which have an occasional power connection, such as trailers. The unit charges its battery when the power is connected and uses its battery and the advanced power management algorithm to maintain tracking when the power is disconnected.

The unit includes a pigtail harness for battery charging, programming and two general purpose I/Os which can function as dry contact inputs, threshold based input, analog input, frequency counter or open collector output (relay driver). The unit is charged via the asset (trailer) power supply (12 / 24 V).

When not connected to power supply, the unit supports the same temperature range and life time of the CelloTrack Standalone.

When connected to external power, the CelloTrack power supports temperature range of -30°C to +75°C.



#### 3.3 The CelloTrack Lighter

The CelloTrack Lighter unit is designed especially for applications where power is connected only on "ignition on" and minimum installation and maintenance is required.

The CelloTrack Lighter is shipped as a kit comprised of the CelloTrack Power and the Lighter Harness. The Lighter Harness is terminated with a connector which fits a vehicle's standard cigarette lighter socket.

This setup allows the unit to be installed in the driver's cabin with a fast and simple connection to the vehicle power. The unit charges its battery when the power is connected and uses its battery and the advanced power management algorithms to maintain tracking when vehicle power is disconnected.

**NOTES:**

- The SIM card must also support the declared temperature range to provide overall unit support.
- The parameter "Enable Extended Charging Temperature Range" in the PL should be set to 1.

## 3.4 CelloTrack LTE Plus Variants

The CelloTrack LTE Plus supports two variants:

CelloTrack Standalone: GC9773014-000 CelloTrack XT LTE C1 NA

CelloTrack Power: GC9773013-000 CelloTrack Power XT LTE C1 NA

## 3.5 CelloTrack Accessories

The CelloTrack accessories are described in the following table:

Part	Description	
CelloTrack Cradle PN: 805-60803	A cradle designed to be mounted on the surface of a container, wagon or track, and which holds the CelloTrack unit.	
CelloTrack Magnetic Cradle PN: 815-60803	Allows CelloTrack Family units to be fixed on steel (iron) surfaces by means of very strong permanent magnets.	
Lighter Harness PN: 711-00316	The Lighter Harness, together with the CelloTrack Power, make up the CelloTrack Lighter kit.	
Communication Harness PN: 711-00251	Allows configuration and FW upgrades. Please read the warning below.	
CelloTrack Charger – EU PN: 711-00168	CelloTrack external charger to be used in Europe.	
CelloTrack Charger – US PN: 711-00170	CelloTrack external charger to be used in the USA.	
CelloTrack XT Battery	Additional XT (Extreme Temperature) battery.	

Part	Description	
PN: 711-20071		
CelloTrack Power 3G NA Evaluation Kit PN: K080-001	Evaluation kit for the CelloTrack Power 3G NA.	

**WARNING:** The Communication Harness used for the CelloTrack T family and the CelloTrack LTE (PN 711-00251) is different from the one used for the legacy CelloTrack (PN 711-00278). Using the wrong Communication Harness can damage the electrical circuit of the CelloTrack T, and require repair at the Cellocator premises (RMA). Therefore only the correct Communication Harness, easily differentiated by its red label, should be used.

## 3.6 The CelloTrack Cradle

The CelloTrack Cradle is designed to be mounted on the surface of a mobile asset and to firmly hold the CelloTrack unit. The cradle supports mounting on a surface by double-sided adhesive tape or by using screws. The cradle also supports a setup with four POT magnets, allowing instant attachment to metal (iron) surfaces.

The unit can be easily placed into the cradle using the cradle side snaps. The cradle also supports securing the CelloTrack in the cradle by using four cable ties.

Detection of removal of the cradle from the mounting surface (cradle tamper detection) is also supported.



### 3.7 The CelloTrack Magnetic Cradle

The CelloTrack Magnetic Cradle is a standard CelloTrack cradle with four powerful POT magnets. This configuration allows instant attachment to a vehicle or an asset with a metal surface, on a per-trip basis, in order to provide covert CelloTrack installation. It is especially useful for monitoring rented trucks or containers for a specific trip or time period.

The POT magnet technology annuls the influence of the magnetic field on the CelloTrack GSM modem, GNSS antenna, and the electronic circuit, while providing a concentrated magnetic force to attach the cradle to the asset's surface.

The CelloTrack Magnetic Cradle is designed to contend with rapid acceleration or braking, and serious vibration caused by journeys over rough roads, and it can even remain effective where layers of dirt separate between the magnets and the vehicle surface or in cases where the vehicle's body material is not 100% iron. Each of the magnets supports up to 16 Kg, i.e, 64 Kg per cradle, while the CelloTrack weight is approximately only 0.55 Kg.

The CelloTrack Magnetic Cradle has been successfully tested while driving in difficult conditions on rough roads.

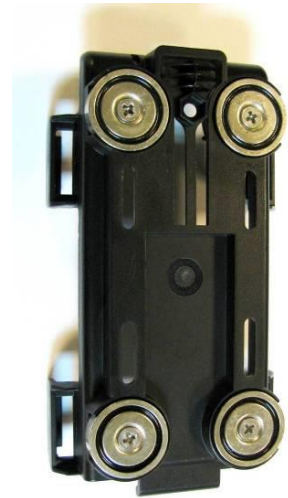

## 4 The CelloTrack LTE Plus Description

### 4.1 CelloTrack Interfaces

#### 4.1.1 The CelloTrack Standalone Interface



- 1 – FB (Front Button)
- 2 – COMM LED
- 3 – SYS LED
- 4 – Cradle Tamper Switch
- 5 – Cradle
- 6 – Unit Tamper Switch
- 7 – Connector
- 8 – Connector Cover

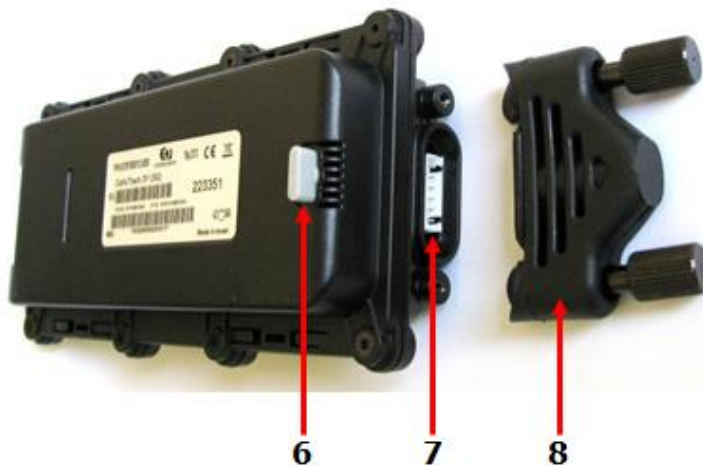

### 4.1.2 *The CelloTrack Power Interface*

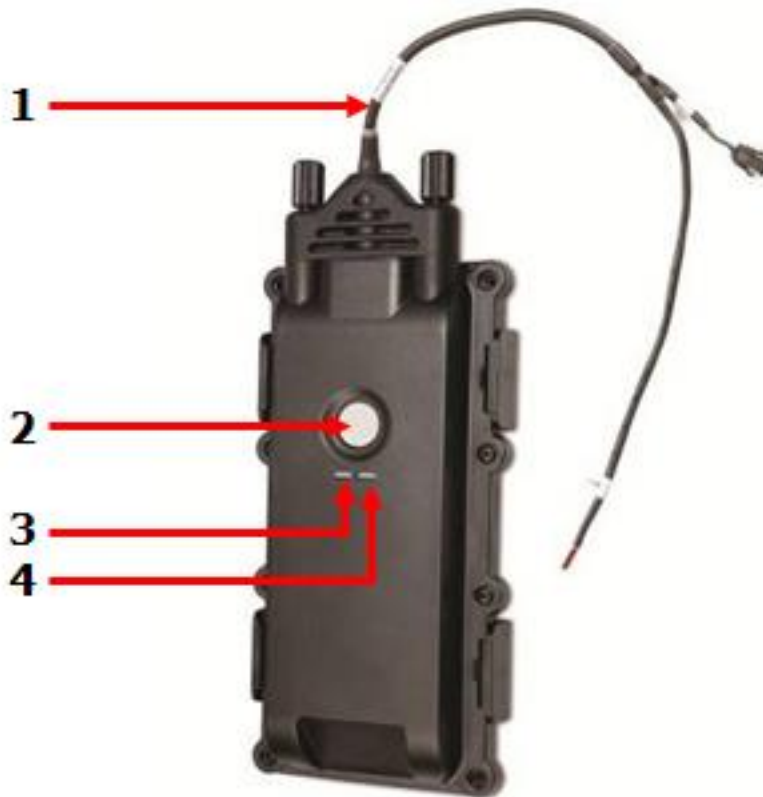

1. **CelloTrack Power harness (pigtail)**
2. **FB (Front Button)**
3. **COMM LED**
4. **SYS LED**

### 4.1.3 *CelloTrack Front Button and LEDs*

- ◆ The Front Button allows activation/de-activation, battery status check and battery replacement sequence.
- ◆ The SYS LED is a dual color (Green and Red) LED, which indicates unit activation/de-activation, panic, and battery status/replacement.
- ◆ The COMM LED is a dual color (Green and Red) LED, which indicates the unit's cellular communication and position status.

### 4.1.4 *CelloTrack Connector*

The CelloTrack 6-pin connector is protected by a plastic cover, providing IP67 compliancy. The following illustration shows the CelloTrack unit with the rubber cover removed.



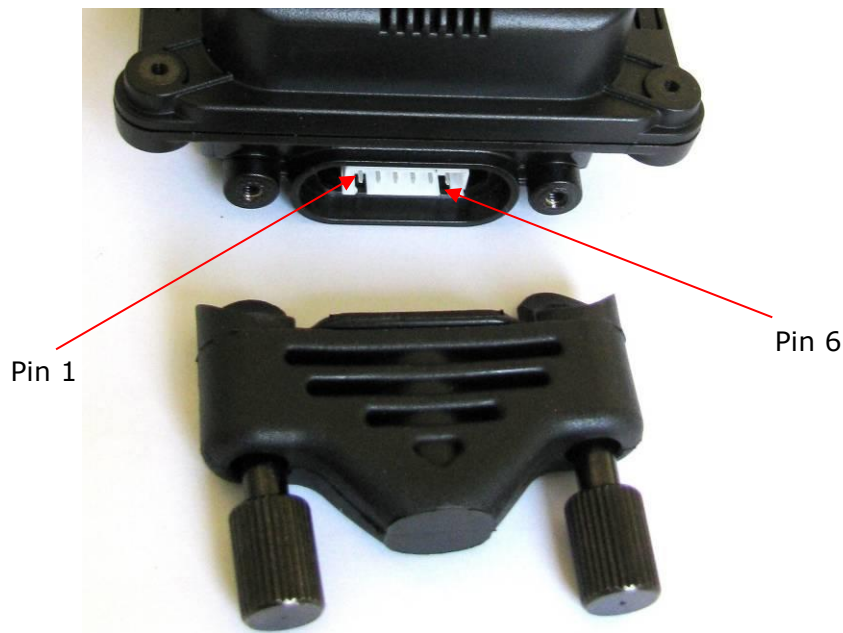

The connector pin out is as follows:

- Pin 1 – VCC
- Pin 2 – Ground (GND)
- Pin 3 – General Purpose I/O 1 (GP1)
- Pin 4 – General Purpose I/O 2 (GP2)
- Pin 5 – RS232 TXD
- Pin 6 – RS232 RXD

**NOTE:** Removing the connector cover revokes the unit’s IP67 compliancy. It is the customer’s responsibility to provide proper sealing if the connector cover is removed.

## 4.1.5 CelloTrack Power Harness

The CelloTrack Power utilizes a 45 cm pigtail harness which ends with several free wires and a connector for the programming cable, as described in the following table.

Pin No.	Color	Function	Free Wire	Programming Connector Pin No.
1.	red	VCC (9-32v)	+	
2.	black	Ground (GND)	+	1
3.	orange	General Purpose I/O (GP)	+	
4.	brown	General Purpose I/O (GP)	+	
5.	green	RS232 TXD		2
6.	yellow	RS232 RXD		3

## 4.2 CelloTrack COMM LED description

### 4.2.1 Overview

The COMM LED is used to indicate unit cellular communication and position with a green light.

The blinking pattern is constructed from cycles of 2 blinking zones each, which will be repeated by unit continually. The first zone represents the functionality of Cellular communication (GSM), the second zone – the GNSS status.

Each zone will last 3 seconds with 1 second of LED off interval between them. 5 seconds LED Off interval will separate between each cycle.

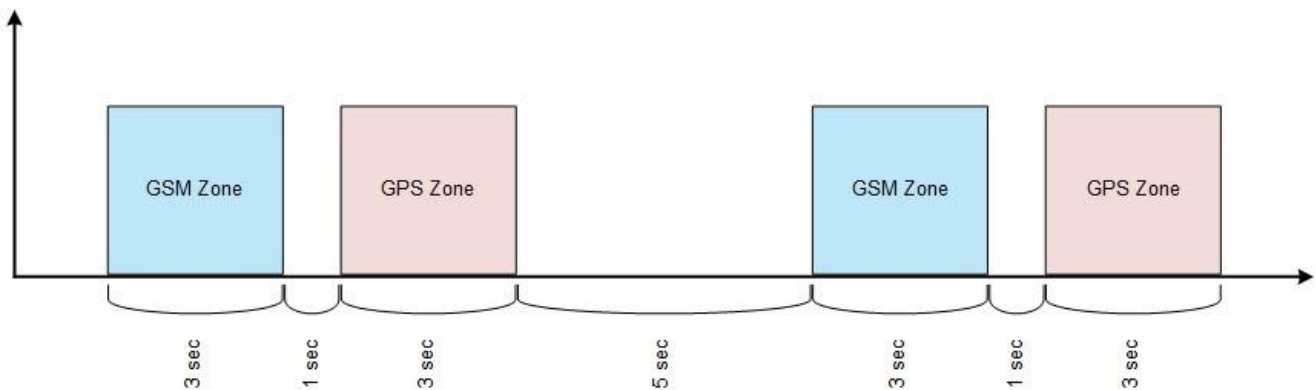

### 4.2.2 Cellular Network Monitoring Zone

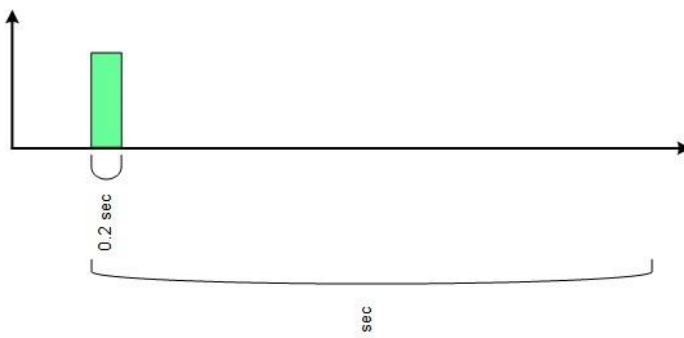
Status	Blinking pattern
GSM Off	Off
Not registered to GSM/No SIM	



# CelloTrack LTE Plus Overview

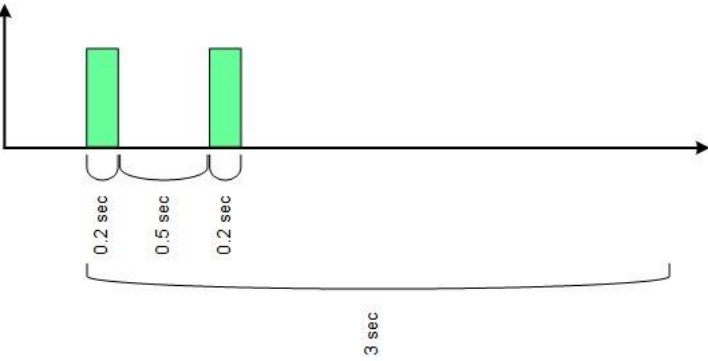
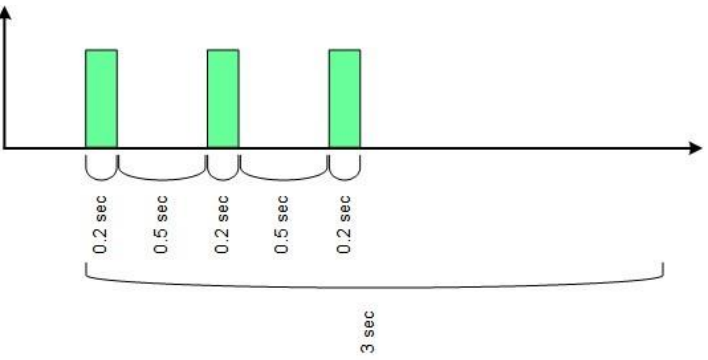
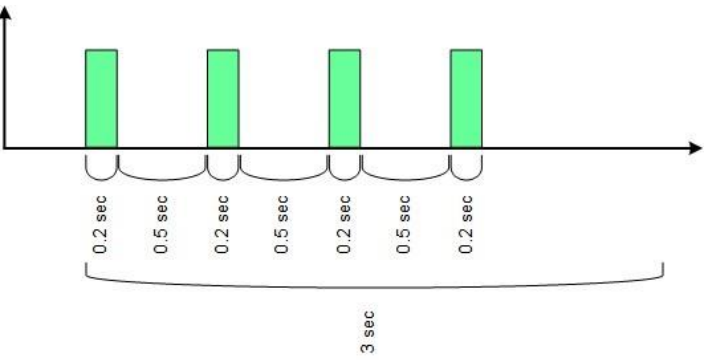
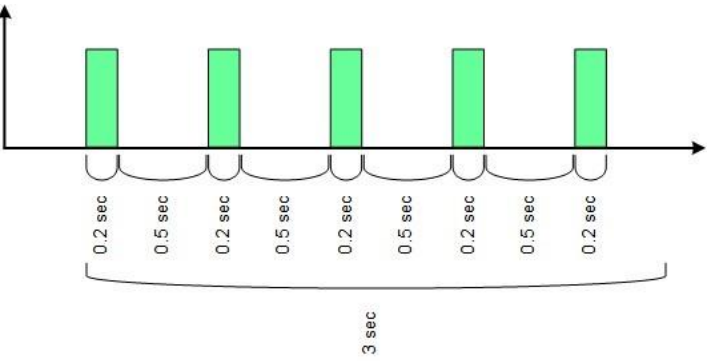

Status	Blinking pattern
Registered in Home GSM network (not attached to GPRS)	
Registered in Roaming GSM network (not attached to GPRS)	
Attached to GPRS/home	
Attached to GPRS/roaming	



# CelloTrack LTE Plus Overview



## 4.2.3 GNSS Monitoring Zone

Status	Blinking pattern
GNSS Off	Off
GNSS is unplugged/faulty	
GNSS communicating, but not navigating	
GNSS is in navigation mode	
GNSS is in GYRO mode (only for compatible models)	

Note: To save energy, the COMM LED performs only 10 indications cycles (total time 120 seconds) upon unit activation and/or upon unit reset, and is then shut off.



## 4.3 User Features

### 4.3.1 Activation

When the unit is not active, upon pressing the front button for 5 seconds (long press), the unit is activated. The SYS LED lights for 5 seconds in **Green**, to indicate the user that the unit is active. The COMM LED performs 10 GSM/GPS indication cycles, and then is shut off.

Note that after battery replacement, the unit shall be automatically activated, i.e. with no need of activation by button as described above. After automatic activation, the SYS LED behaves as described above.

**NOTE:** Consecutive presses are ignored, if started before the SYS LED indication of the previous press/sequence ended.

### 4.3.2 De-Activation

When the unit is active, upon pressing the front button for 5 seconds (long press), the unit is de-activated. The SYS LED shall light for 5 seconds in **Red**, to indicate the user that the unit is not active. In the case of enabled logged or distress events, the de-activation is postponed until the events are transmitted (or until Modem Max On Time expiration). In the postpone time, the SYS LED shall blink (200msec on every 1 second) in **Red**.

**NOTE:** Consecutive presses are ignored, if started before the SYS LED indication of the previous press/sequence ended.

### 4.3.3 Panic/Distress

When the unit is active, upon pressing the front button for a period of between 0 and 5 seconds (short press), a panic/distress press is recognized. The SYS LED then reflects the battery SOH (State of Health):

- ◆ If the SOH is above the preprogrammed minimum - the SYS LED lights for 2 seconds in **Green**.
- ◆ If the SOH is below (or equal to) the preprogrammed minimum - the SYS LED lights for 2 seconds in **Red**.

**NOTE:** Consecutive presses are ignored, if started before the SYS LED indication of the previous press/sequence ended.

### 4.3.4 Battery Status Manual Check

A maintenance operator can manually check the battery status.

For doing it, when the unit is active, the maintenance operator will perform panic/distress press the front button for a period of between 0 and 5 seconds (short press). The SYS LED shall then reflect the battery SOH (State of Health):

- ◆ If the SOH is above the preprogrammed minimum - the SYS LED lights for 2 seconds in **Green**.

- ◆ If the SOH is below (or equal to) the preprogrammed minimum - the SYS LED lights for 2 seconds in **Red**.

### 4.4 BLE Functionality

The method of communication between the CelloTrack 10y and MultiSense devices is *BLE* (Bluetooth Low Energy) *2.4 GHz short range low energy wireless communication*. This method of communication is intended to provide considerably reduced power consumption, footprint and cost, with these three parameters the most important values within the IoT world.

**NOTE:** BT SIG certification is currently in the product evolution process.

Using *BLE*, the CelloTrack 10y can communicate with up to 16 MultiSense devices in a *Master* and *Slave* type setup. However, in order to function correctly as a WSN, the 10y unit and MultiSense devices must be paired, as described on page 22.

Using 10y and paired MultiSense devices as a local WSN enables you to leverage an environment, within which you can sense where different measurements are expected such as inside cooled cargo boxes, or in a long trailer where the environmental conditions inside the trailer may be different from those closer to the door.

Another form of communication between the 10y and MultiSense devices is via *transparent* (guest) mode. In this mode, no pairing process is required and thus the CelloTrack 10y does not manage or save MultiSense device data or thresholds. As a result, in transparent mode the CelloTrack 10y can be used as a gateway to unlimited MultiSense devices.

In situations where only MultiSense MAC addresses are required, Tag mode (similar to iBeacon mode) can be activated.

For further information about the configurable BLE parameters, refer to the *Programming Manual*.

### 4.5 MultiSense and MultiSense-TH



The MultiSense is a remote peripheral sensor, communicating and configured by the CelloTrack 10y via a short-range RF link.



## CelloTrack LTE Plus Overview



There are 2 models of MultiSense: regular devices that can measure temperature called "MultiSense", and "MultiSense-TH" devices which have a combined temperature and humidity sensor.

The MultiSense device has the following sensors:

- ◆ Temperature sensor
- ◆ Humidity sensor (only in the MultiSense-TH model)
- ◆ Hall effect magnetic sensor
- ◆ Ambient Light Sensor (ALS)
- ◆ Accelerometer sensor

The CelloTrack 10y supports up to 16 fully programmable MultiSense devices.

If "Guest mode" is enabled (via the *Guest and Tag MultiSense reporting* parameter), the unit will also connect with MultiSense units not in its list, read their sensors and pass the data (in raw format) to the server. Only listed MultiSense units also get configuration blocks and their readings are fully processed by the 10y.

If "Tag mode" is enabled, the 10y unit will only report on existence (reception of advertisements) of unpaired MultiSense units, not reading their sensors.

MultiSense devices can be paired with the unit by entering the MultiSense MAC address, which is written on the MultiSense, in the MultiSense Editor window accessed via the Cellocator Programmer.

## 4.6 CelloTrack Feature List

The following list details the features and capabilities of the CelloTrack family. These features are actually a combination of the Fleet management capabilities derived from Cellocator's Cello product line and specific asset management capabilities designed solely for the CelloTrack family.

- ◆ Geo-Fences (100)
- ◆ Way Points
- ◆ Roaming List (100)
- ◆ Usage counters (PTO)
- ◆ Server authentication
- ◆ Automatic SIM PIN lock
- ◆ DNS support
- ◆ Virtual odometer
- ◆ Jamming detection
- ◆ Road curve smoothing
- ◆ Cell-ID report
- ◆ Offline Tracking
- ◆ Wake up event
- ◆ Movement detection
- ◆ Crash detection
- ◆ Time based events (adaptive to movement status)
- ◆ Specific time (in day) reporting



## CelloTrack LTE Plus Overview



- ◆ Distance based events
- ◆ Velocity Adaptive message rate
- ◆ Home/Roam adaptive message rate
- ◆ Distress reporting mode (higher priority)
- ◆ Over speeding alerts
- ◆ Go/Halt reports
- ◆ Internal excessive temp
- ◆ A/D threshold events
- ◆ Frequency threshold events
- ◆ GNSS status events
- ◆ Watchdog
- ◆ Battery level reporting
- ◆ Network dependent traffic Opt
- ◆ Cellocator+ (Maintenance) server support
- ◆ OTA/Serial Firmware upgrade
- ◆ OTA/Serial configuration update
- ◆ Nested Output activation
- ◆ Gradual Output activation
- ◆ Programmed Output activation

The CelloTrack Power support also the following features:

- ◆ External Power monitoring
- ◆ Temp dependent Backup Battery charging





## 5 CelloTrack Operational States

The unit operates in one of the following three operational states:

- ◆ **Error! Reference source not found.** (for storage and battery conservation)
- ◆ **Error! Reference source not found.**
- ◆ **Error! Reference source not found.** (fully operational)

Each operational state is comprised of a number of operational modes.

There is an additional BOD/EOD Tracking Mode that the CelloTrack 10y can be programmed to support.

### 5.1 Not Activated State

The *Not Activated* operational state enables storage of a fully assembled unit (including battery connection and SIM card insertion) but prevents unnecessary battery drainage and self-discharging. This state is designed for maximum battery conservation and can prove especially useful, for example, when transporting multiple pre-installed units to an installation plant.

When the CelloTrack unit is in the *Not Activated* state, it remains in sleep mode most of the time. Once per second, however, it exits sleep mode, checks for an activation attempt by checking whether the front button and/or temper switch is depressed, and returns to sleep (assuming the main button is not depressed).

In this state, the unit does not respond to input triggers, nor does it perform or react to **Error! Reference source not found.**, and the unit's GNSS and GSM modules remain unpowered.

**Entering this state:** Upon Deactivation Procedure

**Leaving this state:** Upon Activation Procedure

### 5.2 Hibernation State

When the CelloTrack unit is in the *Hibernation* state, it remains in sleep mode most of the time and awakens once per second to check for inputs, button state changes, and motion. Typically, the *Hibernation* state is used for asset or cargo tracking, when maximum battery life is the primary consideration and infrequent updates are sufficient.

In addition to checking inputs, button state changes, and motion once per second, the CelloTrack unit awakens periodically, powers up all its modules, communicates with the server, and transmits a unit location update. This is known as *glancing* (see the following section).

The *Hibernation* state employs a number of modes and functionalities, as shown in the following table.

Mode	Description
Sleep	For battery conservation.
Sensor checking	Once per second.
Glancing	Occurs periodically or at a specific time of day; refer to the following <b>Error! Reference source not found.</b> section.



## CelloTrack LTE Plus Overview



Offline tracking data upload session	If offline tracking is enabled, the unit transmits all messages collected during the trip at the end of the trip (and after a preprogrammed time has elapsed). Refer to the <b>Error! Reference source not found.</b> section on page <b>Error! Bookmark not defined.</b>
Maintenance server sessions	The unit periodically connects to a maintenance server for firmware and configuration upgrades. Typically this is done once per day.
Not live tracking	The unit never enters the <i>Tracking</i> state, but does, however, send start and stop messages when movement is detected or ends. Refer to the <b>Error! eference source not found.</b> section on page <b>Error! Bookmark not defined.</b>

During *Hibernation*, GPRS messages are not received by the unit and not stored in the cellular network – thus they are lost. However, SMS messages that are sent by the system are received by the unit during glancing.

### 5.2.1 Glancing

The periodical wake up and location update process is known as *Glancing*. During *Glancing*, the unit is fully operational, the GSM and GNSS modules are powered up (when the GNSS is powered the navigation SYS LED blinks every 2 seconds), and the RS232 port is operational.

By default, *Glancing* occurs according to a configurable time period. Alternatively, you can configure *Glancing* to occur at a specified time of the day (see the **Error! eference source not found.** section on page **Error! Bookmark not defined.**) or enable both modes. If both modes are enabled they are maintained in parallel and independently.

The *Glancing* frequency depends on the following two periods (for more information, refer to the *CelloTrack Programming Manual*):

- ◆ The glancing duration (programmable).
- ◆ The sleep period between location updates – this is dependent on whether the unit is in motion.

This combination is known as *adaptive glancing frequency*.

The GNSS module remains active until a successful GNSS acquisition occurs or until the dedicated GNSS timeout expires.

The GSM module is activated for a pre-programmed time. When this ends, the next *Glancing* cycle begins. Thus it is the GSM duration which actually defines the duration of the *Glancing* cycle.

Typically, the GSM duration must be no shorter than two minutes in order to accomplish GSM registration, GPRS dial up, and reception of SMS commands sent from the back end application during *Hibernation*.

30 seconds before the end of *Glancing*, the unit sends an update message and the GNSS data. If GNSS acquisition fails during the current *Glancing* session, the last known GNSS data is sent. This message can either be sent as a regular event and/or configured as a distress session.

The following figure shows the stages of *Glancing*.

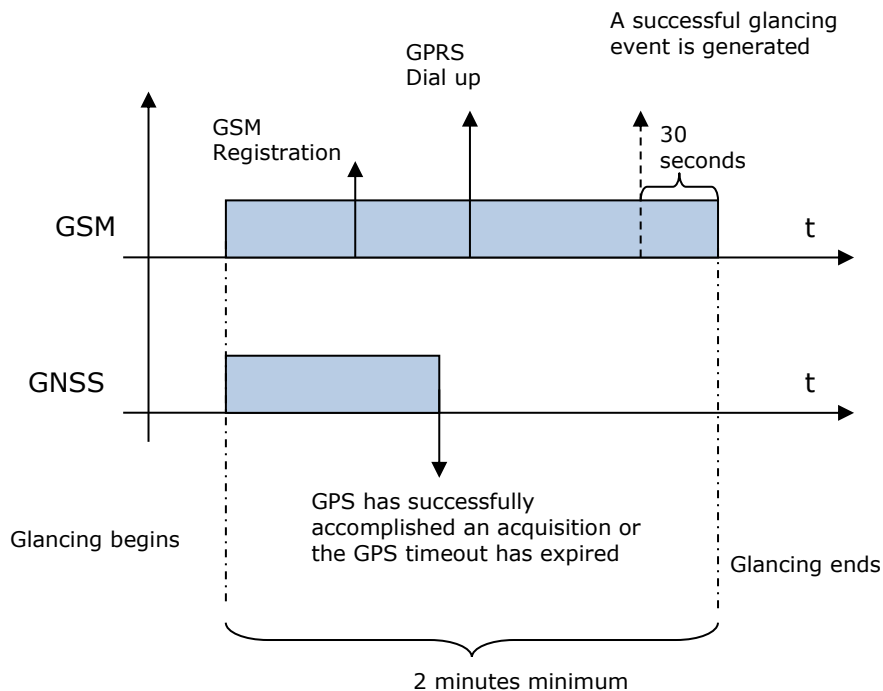

The current consumption in *Glancing* depends on the distance to the GSM communication base and communication network conditions.

If there is a GSM registration fault, the modem is switched off before the programmed time in order to conserve power. The *Glancing* event messages that were not transmitted are stored in the unit's message queue for the next *Glancing* session (if storing to memory is enabled).

## 5.2.2 Specific Time Glancing

*Glancing* can be configured to occur at a specific time of the day to enable the reception of status updates from all the units of the fleet concurrently. To prevent communication server overload due to multiple simultaneous transmissions, a randomization algorithm is implemented: when the appointed time arrives, each unit calculates a random time offset and transmits its update. The result is that all the transmissions are grouped around the specified time, some before, some after.

**NOTE:** *Specific Time Glancing* can only be enabled if the GNSS has acquired a valid fix (location and time) at least once in the past.

If the unit is not in the *Hibernation* state when the specified time occurs (for example, it is in the *Tracking* state), the *Glancing* message is still transmitted.

## 5.2.3 Not Live Tracking

In *Not Live Tracking* the unit does not enter the *Tracking* state; however, it sends start and stop messages when motion is detected or ends.

If both *Not Live Tracking* and **Error! Reference source not found.** are enabled, and the unit is in the *Hibernation* state, then when motion is detected the unit immediately

opens a distress session, sends a "start motion" message, and returns to *Hibernation*. When no further motion is detected, the unit opens a distress session, sends a "stop motion" message, and returns to *Hibernation*. This is known as *start-stop reporting* during *Hibernation*.

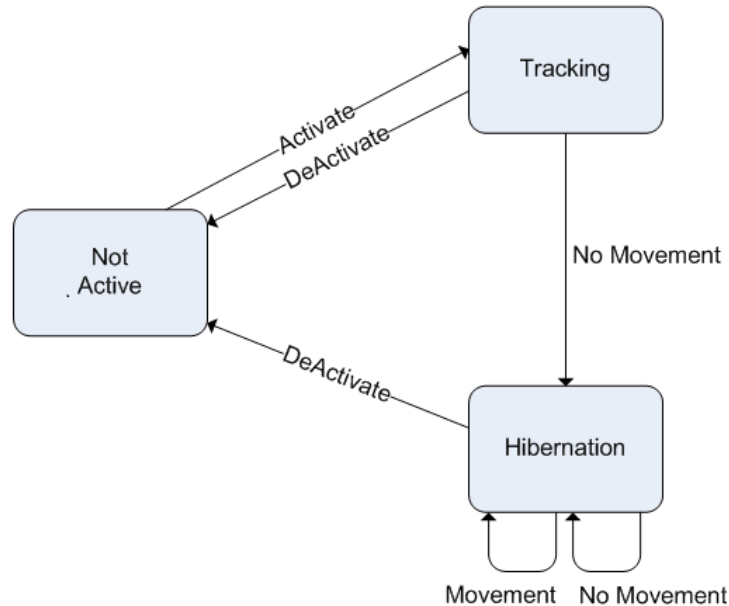

## 5.3 Tracking State

By default, the unit is configured to enter the *Tracking* state when motion is detected and to exit *Tracking* when motion ends. This is done to conserve battery power.

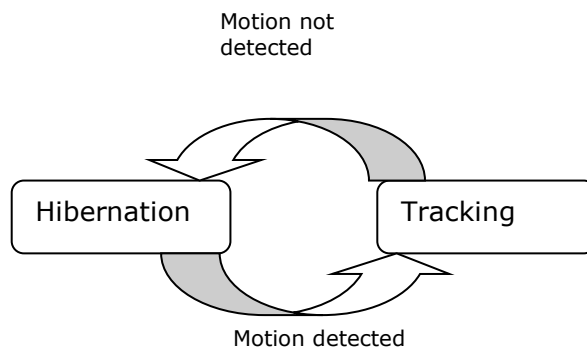

In the *Tracking* state the unit does the following:

- ◆ Powers up its GNSS module.
- ◆ Powers up its GSM module.
- ◆ Sends regular location updates to the server.
- ◆ Provides full CelloTrack functionality, including: periodical and distance events, geo-fence related events, speed related events, and maintenance events.
- ◆ Activates its interfaces.

In the *Tracking* state, the unit provides the best tracking and communication features, generates time/location updates (known as time events), and behaves as a standard fleet management oriented unit. This is the most energy-intensive state.

You can configure the unit to work in one of the following tracking modes, and which are described in the following sections:

- ◆ **Error! Reference source not found.**
- ◆ **Error! Reference source not found.**
- ◆ **Error! Reference source not found.**
- ◆ **Improved (Take Location) Tracking Mode**
- ◆ **BOD/EOD Tracking Mode**

## 5.3.1 *Live Tracking*

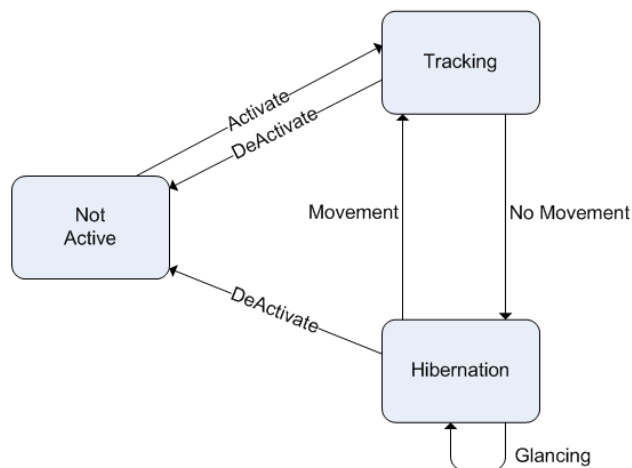

The unit is fully active and sends periodic updates to the server. This is not the default tracking mode.

## 5.3.2 *Tracking with GNSS Peeking*

This tracking mode is similar to live tracking but uses less battery power: the GNSS module operates in peeks just before each time event (instead of permanent activation) and only if:

- ◆ Time events are enabled and the time event interval is longer than 90 seconds.
- ◆ One valid GNSS fix has already been set.

The GNSS module is switched off immediately after the time event message is generated.

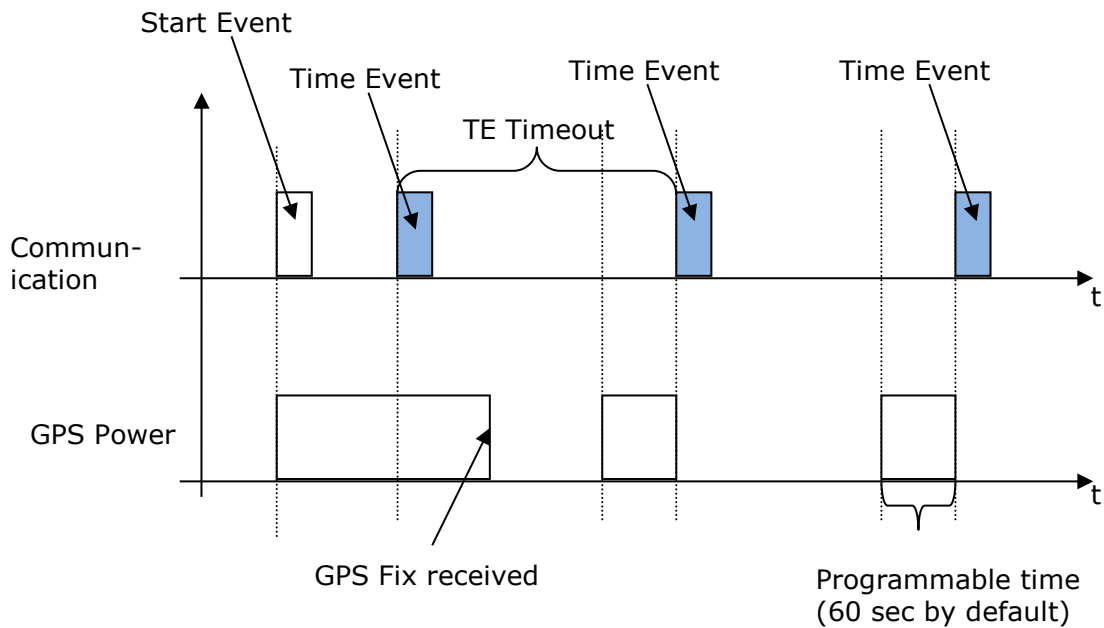

### 5.3.3 Offline Tracking

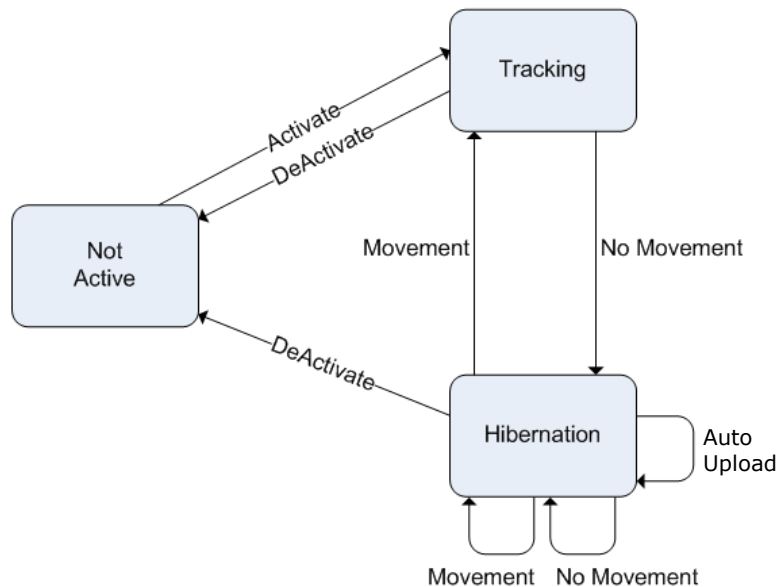

In this tracking mode the unit collects all updates during a trip and sends them all together at the end of the trip (the GNSS remains active). When motion is detected and offline tracking has been enabled, the unit powers up its modem and sends a *start motion* update. The unit then powers down its modem (the modem is a major current consumer) and generates and saves status updates until the end of motion is detected (end of trip). It then powers up its modem again and sends all the interim messages to the server in a single transmission.

This transmission session is known as *Offline tracking data upload* session which is one of the *Hibernation* state modes as explained in the **Error! Reference source not found.** section.



## 5.3.4 Improved (Take Location) Tracking Mode

This mode is based on the not-live-tracking mode and allows the unit to add and log extra locations between transmissions. Since the entire system is hibernating most of the time, the battery life is prolonged.

In this mode, the unit behaves as follows:

- ◆ Checks power lines, button state changes, motion and MultiSenses (if programmed to) once per second and logs them efficiently. Looks for distress (critical) events (such as tamper, sensor reading crossed some predefined critical threshold) to report them immediately.
- ◆ Takes GNSS locations extra configurable times a day and logs them internally as Type-0 and/or Type-11 with the same message but encapsulated.
- ◆ GNSS and cellular modems are also activated upon distress event occurrences to immediately report the position of the event. A transmission is sent even if the GNSS has not got a fix after the timeout. If no fix is reached the Cell-ID transmission logic is used.
- ◆ The GNSS module is shut down, disregarding any applicative constraints to preserve energy.
- ◆ Turns on the cellular modem, at configurable times, and transmits the logged messages, including the logged positions, measurements and events, to the server.
- ◆ For all cellular transmissions, the entire log memory is transferred/uploaded, and then cleared upon an ACK from the server.
- ◆ At all other times, the unit is sleeping (hibernating).

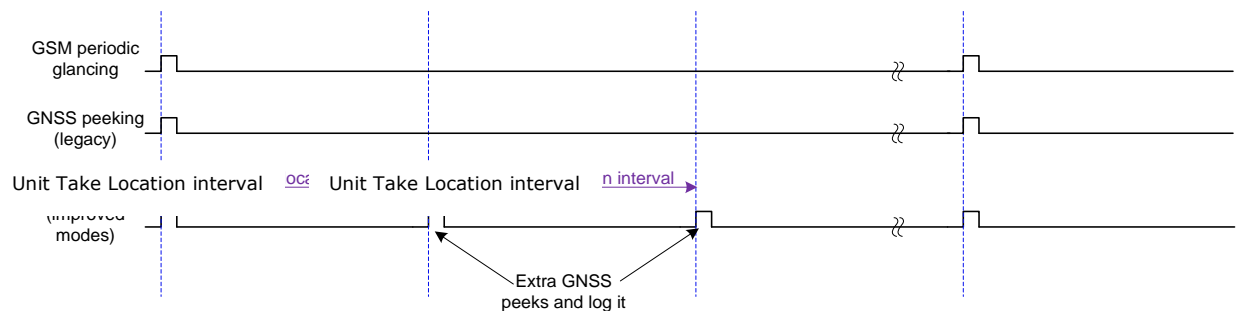

## 5.3.5 BOD/EOD Tracking Mode

CelloTrack 10y can be programmed to support the **BOD (Beginning of Day)/EOD (End of Day) Tracking** mode.

This mode enables reporting on the leaving of the pick-up location (BOD) and arriving to the destination location (EOD), supporting a minimal number of transmissions.

To support this mode, the unit maintains the BOD (BOD was recognized) /EOD (EOD was recognized) states; the last EOD location is also kept.

The unit uses the accelerometer for movement detection. The unit can be programmed to communicate periodically with the MultiSense devices and log the sensor states.

The reporting policy of the BOD/EOD Tracking Mode is as follows:

- ◆ Upon movement detection (short time) – start event is logged.



## CelloTrack LTE Plus Overview



- ◆ If the movement continues for more than the programmed time and the distance from the latest known EOD location is larger than the programmed value – the BOD is detected. The unit transmits a BOD message as well as all logged messages.
- ◆ During the trips, short stops generate stop and start events which are logged.
- ◆ When movement is stopped for more than the programmed time - EOD is detected. The unit transmits an EOD message as well as all logged messages and keeps the EOD (destination) location for the next BOD detection.
- ◆ The unit can be programmed to take locations and log the messages periodically according to a programmable time on each trip (BOD state).

The unit also supports the entering and exiting Theft Mode (Periodic Glancing), which can be activated by OTA command.

On Periodic Glancing the unit performs full glancing (GPS, Modem) according to the period defined in the OTA command.

### 5.4 Radio-Off

The unit enters *Radio-Off* mode when the CelloTrack battery voltage falls below 3.4 volts for 30 consecutive seconds. When this happens, the unit initiates the following:

- ◆ A Radio-Off event is generated and logged.
- ◆ All log history is saved to nonvolatile memory.
- ◆ The cellular modem and GNSS are turned off.

The unit does not send messages until power is resumed.

These actions ensure the integrity of the logged history and facilitate a smooth restart when power is reapplied.

The unit exits *Radio-Off* mode and resumes tracking when the battery voltage exceeds 3.5 volts for 30 consecutive seconds.

### 5.5 Motion Detection

In CelloTrack units, *Motion Detection* is used to detect the unit movement; the ignition signal is not required for asset tracking. Motion is detected via the unit's built-in accelerometer, which only operates when *Motion Detection* is enabled.

Two seconds of continuous accelerometer motion is recognized by the unit as valid motion detection. When motion is detected continuously for a preprogrammed duration (typically two seconds from the initial valid motion detection), the unit reports a *start* event, which indicates engine-on/movement.

Two seconds of continuous lack of accelerometer motion is recognized by the unit as a valid lack of motion detection. When lack of motion is detected continuously for a preprogrammed duration (typically 40 seconds from the initial valid lack of motion detection), the unit reports a *stop* event, which indicates end of movement.





# CelloTrack LTE Plus Overview

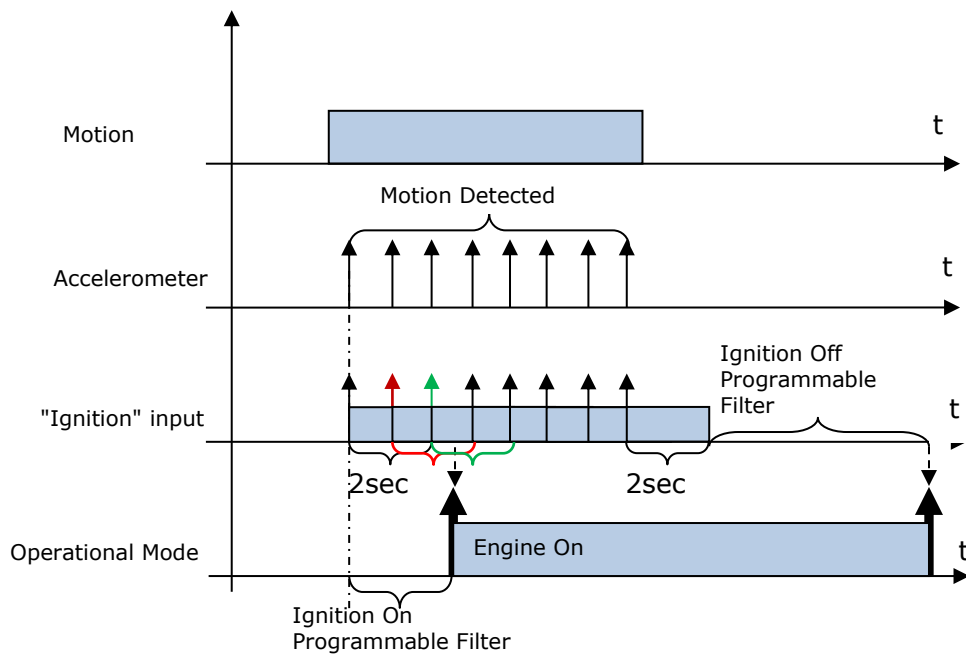

**NOTE:** *Motion Detection* is operable when the unit is in any state other than *Not Activated*.



# 6 CelloTrack Power Features

CelloTrack Power includes a built-in CCCV battery charger (not included in the standard CelloTrack unit).

The charger charges the unit's back-up battery whenever an external energy source is available and the temperature is within the charging range.

The CelloTrack Power unit also does the following:

- ◆ Indicates the charger status in its update messages.
- ◆ Continually reports the unit's temperature.
- ◆ Enables increased time and distance event frequency while powered by an external power source.

The CelloTrack Power activates the charger when all the following conditions are met:

- ◆ The temperature is between -20°C and 60°C (note that during charging, the unit generates heat that might increase the temperature by 5-6°C).
- ◆ An external power source is detected.
- ◆ The unit is running in the *Tracking* state (this is the default setting; it is also possible to enable charging in the *Hibernation* state).

The unit terminates charging when any of the following conditions are met:

- ◆ The temperature is out of the permitted range.
- ◆ The external power source is disconnected.
- ◆ The unit enters the *Hibernation* state (if charging in *Hibernation* is disabled).



## 7 CelloTrack LTE Plus Specifications

- ◆ Battery charging temperature range -20°C to 60°C

Communication	
Cellular communication	<p>LTE Cat 1 NA with 3G Fallback</p> <p><b>LTE NA:</b> Bands 2, 4, 5, 12 (700, 850, 1700/2100 (AWS), 1900 MHz), data rates: 10.2[DL] / 5.2[UL] Mbps</p> <p><b>3G NA:</b> UMTS Bands 5, 4, 2 (850, 1700/2100 (AWS), 1900); HSPA 5.76[UL]/7.2[DL] Mbps</p> <p>Packet Data: TCP/IP, UDP/IP</p> <p>SMS: PDU mode</p>
SIM	<p>Internal, Micro Sim, replaceable, 1.8/3V</p> <p>Optional SIM on chip</p> <p>Remote PIN code management</p>
Antenna	Internal, multi band antenna
GNSS	
Technology	Internal module, CSR SiRFstarV™ based GPS and GLONSS supported.
Sensitivity (tracking)	-165dBm
Acquisition (normal)	Cold <27 Sec, Warm<10 Sec, Hot<1 Sec
Antenna	Internal, on board patch antenna
Inputs & Outputs	
I/O	<p>Two configurable ports supporting true GPIO (General Purpose Input Output). Each I/O port supports:</p> <ul style="list-style-type: none"> <li>✓ Discrete Dry Input</li> <li>✓ Discrete Wet Input</li> <li>✓ Analog 0-2.5V Input</li> <li>✓ Analog 0-30V Input</li> <li>✓ Frequency Counter Input</li> <li>✓ Output</li> </ul> <p><b>Discrete Dry</b> – Ground sensing. Configurable ground threshold.</p> <p><b>Discrete wet</b> – Logic 1 and 0 Configurable thresholds.</p> <p><b>Analog inputs with variable resolution -</b></p> <p>8bit - 0-2.5V: 20mV resolution, accuracy ±30mV;</p> <p>8bit - 0-30V: 100mV resolution, accuracy ±100mV</p>



## CelloTrack LTE Plus Overview



	12bit - 0-2.5V: 3mV resolution, worst case accuracy <10mV; max 20mV. 12bit : 0-30V: 8mV resolution, worst case accuracy <40mV <b>Frequency counters</b> – Up to 5kHz input signal; Signal level (3V < Vin ≤ 30V); Accuracy ±2% <b>Output</b> - Open collector	
<b>Interfaces</b>		
COM port	Cellocator Serial Protocol Debug, Configuration, FW upgrade RS232, CMOS levels	
3D Accelerometer	3D, ±8g range, 12 Bit representation, 4mg resolution Movement detection	
MMI	2 dual colored LED status indication Activation / Distress button Tamper switch	
Connectors	CelloTrack	CelloTrack Power
	6 pin Molex, Automotive	Pigtail
<b>Power</b>		
Input voltage:	CelloTrack	CelloTrack Power
	4.2V 1A CCCV Charger	9-32V DC
Internal Battery	Li-Polymer, 3.7V, 5.3Ah, rechargeable	
<b>Environment</b>		
Temp, operating	Discharging: -30°C – 70°C. Charging: -20°C – 60°C	
Temp, storage	-20°C – 60°C	
Ingress Protection	IP67	
Vibration, Impact, Humidity, chemical	ISO 16750 part 3 & 4	
Mounting	Magnetic or screw mounted cradle Tampering detection	
<b>Regulatory compliance / certification</b>		
CE	CE Safety EN60950-1:2001+A11:2004	
FCC	Part 15 Subpart B, part 22/24 compliant	



## CelloTrack LTE Plus Overview



IC	ICES-003, Issue 5:2012 Class B. CAN/CSA-CEI/IEC CISPR 22:10
PTCRB	TRP, TIS, Spurious and harmonics emission
AT&T	Yes
Environment	ISO 16750 part 3 & 4
UL	compliant
Reliability assessment	Annual Failed Ratio <0.5%
RoHS and conflict minerals	compliant
<b>Dimensions &amp; Weight</b>	
Dimensions	~155mm x 81mm x 45mm
Weight	CelloTrack XT ~ 330gr CelloTrack Power XT ~ 370gr

## 8 CelloTrack Release Package

The release package of the CelloTrack LTE includes, in addition to the components mentioned in the *CelloTrack 10y Hardware Components* section, a number of software tools and documents, as described in the following sections.

### 8.1 Evaluation Suite

The Evaluation Suite is the application which contains all the software components necessary for the evaluation of any Cellocator unit. The software components required for evaluating the CelloTrack LTE are described below.

#### 8.1.1 Communication Center

The Communication Center also supports the KML generator. The **Keyhole Markup Language (KML)** is an XML notation for expressing geographic annotations and visualizations within Internet-based, two-dimensional maps and three-dimensional Earth browsers, such as **Google Earth, Google Maps, and Google Maps for Mobile.**

For more details about the new Communication Center capabilities and usage during the integration process, refer to the *Cellocator Evaluation Suite Manual*.

#### 8.1.2 Cellocator Programmer

The concept of operation and parameters flow between the four entities of HW, Programmer screen, storage and CelloTrack LTE Editor is shown below:

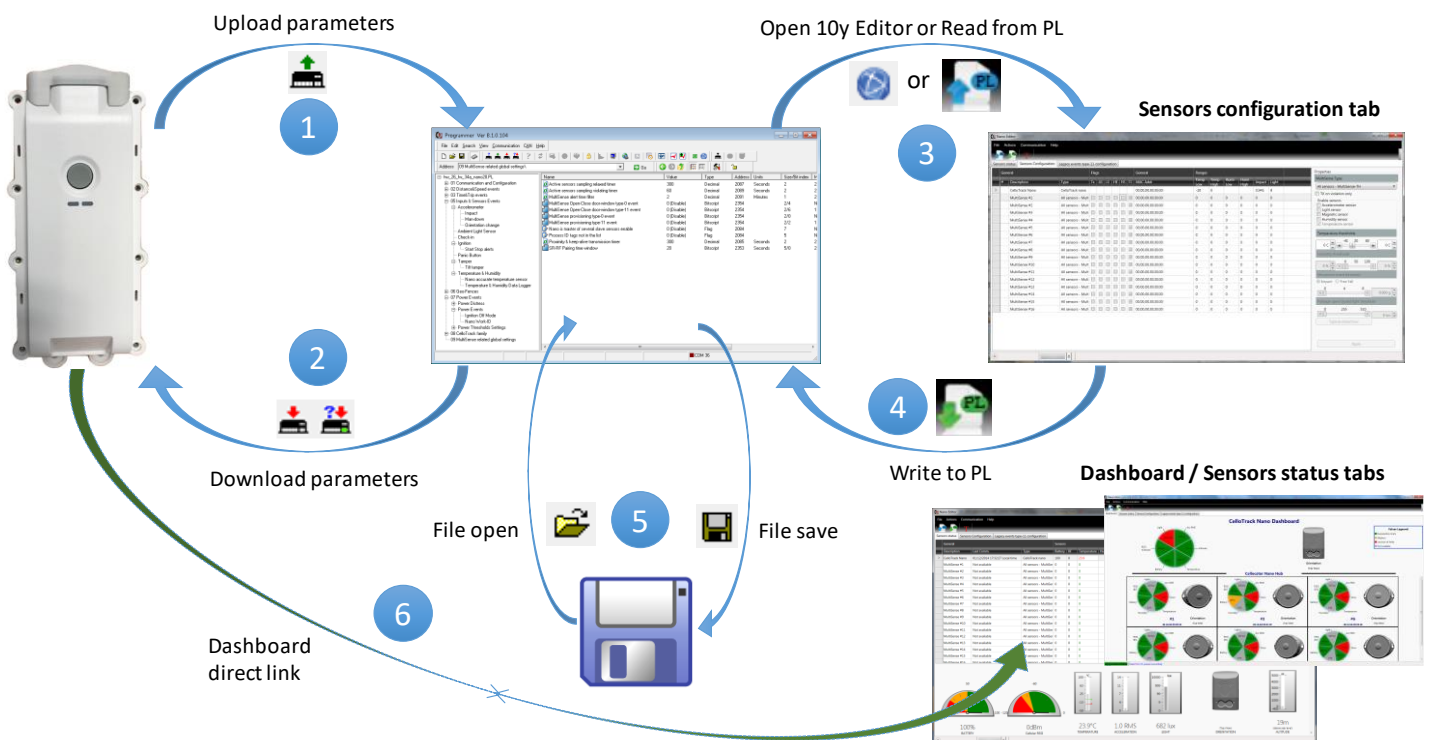

Figure 1: Operation Flow

The Cellocator Programmer supports the CelloTrack LTE Editor which can read, edit and write PL parameters for CelloTrack LTE and MultiSense devices.



The CelloTrack LTE Editor has four main tabs:

- ◆ **Dashboard:** This tab provides you with a real-time overview of the entire system when the CelloTrack LTE is connected to the Cellocator Programmer.
- ◆ **Sensors Status:** This tab is a dashboard where all relevant CelloTrack and Multisense data is presented. When selecting one of the listed devices, its data is shown graphically in the lower part of the window, providing a visual overview of the selected device.
- ◆ **Sensors Configuration:** This tab provides the ability to activate sensors (i.e. accelerometer, light, magnetic, humidity, temperature, proximity) and sensor thresholds per device (CelloTrack, MultiSense) which can be downloaded as a PL afterwards via the standard PL OTA/Serial procedure.
- ◆ **Legacy events type-11 configuration:** This tab contains all type-0 fields related to the CelloTrack that can be transmitted over Type 11 protocol. The user can set each one of the fields, which can be sent as a PL afterwards via the standard PL OTA/Serial procedure.

## 8.2 Integration Package (Cellocator GW)

The Cellocator Gateway is a set of software components offered to Cellocator customers wishing to integrate the Cellocator OTA protocol into their production environment.

Customers using the Cellocator Gateway benefit from a quicker and easier integration process, and are also entitled to software upgrades, technical support and more.

Cellocator Gateway is built utilizing the latest MS-based technologies, and provides high availability and load balancing options, as well as enabling clients the opportunity to integrate and start working with Cellocator units without investing a large amount of time and resources.

The new version of Cellocator GW includes all new fields related to the CelloTrack solution.

## 8.3 Cellocator Wireless Communication Protocol

This document explains the unit's wireless communication protocols and concept. It describes every byte of the incoming/outgoing packets, which can be sent or received by the unit over-the-air.

## 8.4 Cellocator Integration Package Manual

This document provides a complete product description of the Integration Package solution and other integration related information, for the purposes of integrating the Cellocator OTA protocol within a new client's production environment.

## 8.5 Evaluation Suite Manual

The Cellocator Evaluation Suite Manual is a comprehensive guide that provides information required to run an initial appraisal and testing process of Cellocator units.

The Cellocator Evaluation Suite contains a complete set of components that simplify bench testing of the system and serve as a demonstration platform for people wishing to understand the operational aspects of the system. The Suite is also intended to facilitate the development of interfaces to the Cellocator system by integrators or service providers.



### **8.6 Cellocator Programmer Manual**

This document describes the features supported by the Cellocator unit and provides details about the configuration parameters.

### **8.7 Integration Manual**

This document provides the software integrator with information and hints on how to integrate an application with the CelloTrack.

### **8.8 Training Presentation**

This documentation provides preliminary Integration Manual information through the beta phase.