

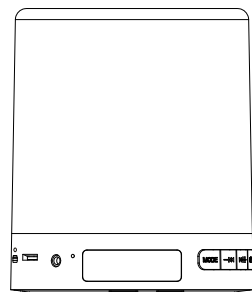

SLS-1

Packing list



speaker



user manual

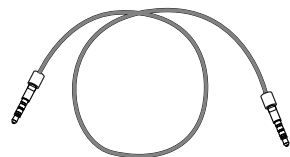

3.5mm audio cable

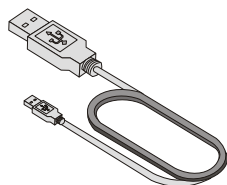

USB data cable

Introduction

Smart touch lamp speaker is a product which integrates touchable lamp and bluetooth speaker. The touchable lamp can be easily switched on/off and into different brightness level by hand touching on top centre of the product. The Bluetooth speaker is a smart device which integrates audio player(Bluetooth mode, SD mode, Line In mode), FM player and clock function. Please check detail operations in each function description in following paragraph.

Specifications

Product Name: Smart Light Speaker
 Model No.: SLS-1
 Power Input: Micro USB,DC5V 1000mA
 Battery Capacity: 3.7V/2200mA
 Charging Time: 2.5-4hours
 Speaker Spec: 2.5Inch,4ohm/5W
 Frequency Response: 70Hz-20KHz
 Distortion: $\leq 0.5\%$
 Signal to Noise Ratio: >math>\geq 65\text{db}</math>
 Material: ABS/Silica-gel
 Music Playing Time: 15 hours at volume level 15.
 Lighting Time: 15 hours at lowest brightness.

Button Functions

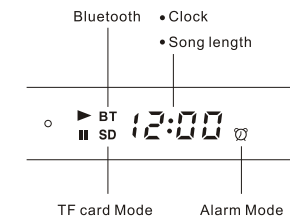
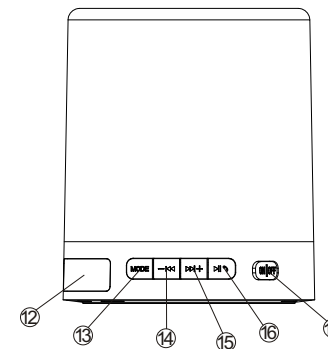
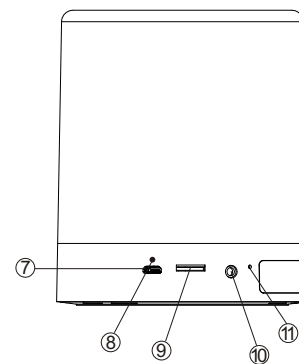
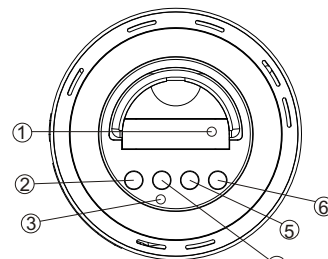

Button/Indicator List

- ① Power Switch: it's used to cut off the power supply under safety purpose in delivery. The product can't get power supply when this switch is off.
- ② Alarm Set: enter alarm set mode.
- ③ Sleep Indicator: it will light when sleep mode is turned on.
- ④ Sleep: turn on/off automatic sleep mode.
- ⑤ Alarm On: turn on/off the alarm.
- ⑥ Clock Set: enter clock set mode.
- ⑦ Charging Port: micro USB port as input power.
- ⑧ Charging Indicator: to show whether battery's charging?
- ⑨ TF Port: port to insert TF card.
- ⑩ Line In: 3.5mm port to connect line in signal.
- ⑪ Micro Phone: micro phone for hand free call in bluetooth mode.
- ⑫ LED Display
- ⑬ Mode: switch speaker in different mode: bluetooth, TF, line in, FM tuner.
- ⑭ \leftarrow : play back/volume down/number down.
- ⑮ \rightarrow : play forward/volume up/number up.
- ⑯ \equiv : play/pause/pick up
- ⑰ ON/OFF: switch to active/sleep mode.

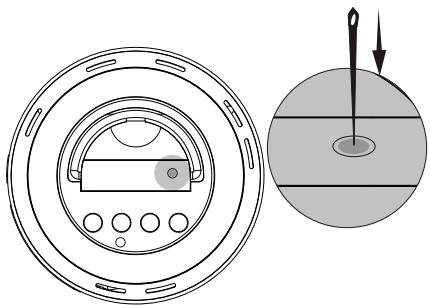

Power On and Charging

Caution: Turn on ① **power switch** before first use by pressing with a pin, this is the switch of product power supply, normally it's off before handing over, the product can't work if this switch is off.

Charge the speaker with the provided USB cable which is compatible with any cell phone charger(the output voltage is 5V, and output current should be 1000mA and above).

The charging indicator is red while charging and will be off when the speaker is fully charged.

ON/OFF

Slide the ⑰ **ON/OFF** switch to turn the speaker into Active or Sleep mode. In Active mode, all the function is available. In Sleep mode, only alarm/clock is running and battery consumes in lowest speed.

Automatic Sleep Mode

Press the ④ **sleep** button to turn on sleep mode, blue indicator(8)will light, speaker and lamp will automatically be in sleep mode after 20minutes.

Clock Setting

Long press ⑥ **Clock Set** button to get into Clock Setting Mode, the hour number displayed will flash. Press ⑯ ►||\ to switch hour or minutes setting. Press ⑮ ►||+ ⑭ ◀||◀ to set displayed numbers. Short press "Clock Set"(6) to finish and quit clock setting.

Alarm Setting

Long press ② **Alarm Setting** button to get into Alarm Setting Mode, the hour number displayed will flash. Press ⑯ ►||\ to switch hour or minutes setting. Press ⑮ ►||+ ⑭ ◀||◀ to set displayed numbers. Short press ② **Alarm Setting** to finish and quit alarm setting, the alarm will be effective then. ⑤ **Alarm On** button is to simply turn on and off the alarm.

Speaker Mode Selection

Press ⑬ **Mode** button once after once to cycle speaker in different mode: Bluetooth mode, TF card music mode, line in mode, FM tuner mode, standby mode. If there are no TF card inserted in TF port, the mode cycle will pass TF card music mode.

Bluetooth Mode

Press ⑬ **Mode** button to get into Bluetooth mode, the speaker will be ready for pairing, the screen displays "blue". Open Bluetooth setting on your Bluetooth device and search the speaker, click "LampSpk-SLS1" to choose and connect, the speaker will say " bluetooth is connected" when connection succeed.

Volume Up: long press ⑮ ►||+
 Volume Down: long press ⑭ ◀||◀
 Last Song: short press ⑭ ◀||◀
 Next Song : short press ⑭ ◀||◀
 Play/Pause: short press ⑯ ►||\

Note:

- When the Bluetooth device connected last time is open, the speaker will connect it ① automatically.
- New Bluetooth connection can't be built if last connection is not cut off.
- ② If the Bluetooth connection can't be built successfully, try to forget the speaker Bluetooth ③ name in your phone and reboot the speaker by turning on and turning off ① **Power** Switch.

Bluetooth Hand Free Call

In bluetooth connection, the speaker will read the calling number when a call is coming in, press ⑯ ►||\ to pick up a hand free call. Closer to micro phone to get better voice quality.

TF Card Music Mode

Insert a TF card with stored music, press "Mode" button to get into "TF Card Music Mode", the speaker will automatically play music in priority of stored date.

Volume Up: long press ⑮ ►||+
 Volume Down: long press ⑭ ◀||◀
 Last Song: short press ⑭ ◀||◀
 Next Song : short press ⑭ ◀||◀
 Play/Pause: short press ⑯ ►||\

Line In Mode

Press "Mode" button to get into "Line In Mode", connect speaker to an audio source with 3.5mm connector.
 Volume Up: ⑮ ►||+ long press
 Volume Down: ⑭ ◀||◀ long press

USB data cable
as FM antenna

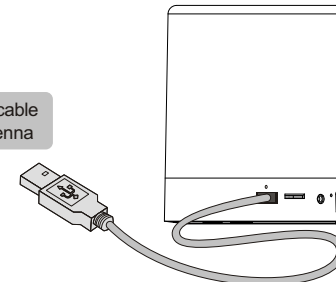

FM Tuner Mode

Press ⑬ **Mode** button to get into "FM Tuner Mode", connect USB cable to power port as FM radio antenna. Press ⑯ ►||\ , the speaker will automatically search and store available FM radio channel. Press ⑭ ◀||◀ to switch and play stored channel. The speaker can store up to 99 channels.

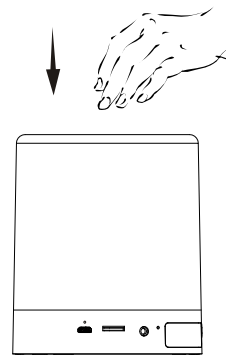

Touch Lamp

Touch the top centre of the speaker grill, the lamp will switch different lighting level after each touch. There are 3 lighting levels and off level.

FCC Caution:

This device complies with part 15 of the FCC Rules. Operation is subject to the following two conditions: (1) This device may not cause harmful interference, and (2) this device must accept any interference received, including interference that may cause undesired operation.

Any Changes or modifications not expressly approved by the party responsible for compliance could void the user's authority to operate the equipment.

Note: This equipment has been tested and found to comply with the limits for a Class B digital device, pursuant to part 15 of the FCC Rules. These limits are designed to provide reasonable protection against harmful interference in a residential installation. This equipment generates uses and can radiate radio frequency energy and, if not installed and used in accordance with the instructions, may cause harmful interference to radio communications. However, there is no guarantee that interference will not occur in a particular installation. If this equipment does cause harmful interference to radio or television reception, which can be determined by turning the equipment off and on, the user is encouraged to try to correct the interference by one or more of the following measures:

- Reorient or relocate the receiving antenna.
- Increase the separation between the equipment and receiver.
- Connect the equipment into an outlet on a circuit different from that to which the receiver is connected.
- Consult the dealer or an experienced radio/TV technician for help.