



FCC Part 15C Test Report

FCC ID:2AG62SLS-1

Product Name:	Smart Light Speaker
Trademark:	N/A
Model Name :	SLS-1 SLS-2, SLS-3, SLS-4, SLS-5, SLS-6, SLS-7, SLS-8.
Prepared For :	Lumi Legend Corporation
Address :	22/F., Building 1, Lisi Plaza, Huifeng East Road, Ningbo, China 315100
Prepared By :	Shenzhen BCTC Technology Co., Ltd.
Address :	No.101, Yousong Road, Longhua New District, Shenzhen, China
Test Date:	Dec. 26 - Dec. 31, 2015
Date of Report :	Dec. 31, 2015
Report No.:	BCTC-151215034



VERIFICATION OF COMPLIANCE

Applicant's name..... : **Lumi Legend Corporation**
 Address..... : 22/F., Building 1, Lisi Plaza, Huifeng East Road, Ningbo, China 315100

Manufacturer's Name..... : **Lumi Legend Corporation**
 Address..... : 22/F., Building 1, Lisi Plaza, Huifeng East Road, Ningbo, China 315100

Product description

Product name.....: Smart Light Speaker
 Trademark: N/A
 Model Name: SLS-1
 Test procedure FCC Part15.249
 Standards ANSI C63.10-2013

This device described above has been tested by BCTC, and the test results show that the equipment under test (EUT) is in compliance with the FCC requirements. And it is applicable only to the tested sample identified in the report.

This report shall not be reproduced except in full, without the written approval of BCTC, this document may be altered or revised by BCTC, personal only, and shall be noted in the revision of the document.

Test Result : **Pass**

Testing Engineer : Eric Yang
 (Eric Yang)

Technical Manager : Sophie Lee
 (Sophia Lee)

Authorized Signatory : Carson Zhang
 (Carson. Zhang)





Table of Contents	Page
1 . SUMMARY OF TEST RESULTS	5
1.1 TEST FACILITY	5
1.2 MEASUREMENT UNCERTAINTY	5
2 . GENERAL INFORMATION	6
2.1 GENERAL DESCRIPTION OF EUT	6
2.2 DESCRIPTION OF TEST MODES	7
2.3 TABLE OF PARAMETERS OF TEXT SOFTWARE SETTING	7
2.4 BLOCK DIGRAM SHOWING THE CONFIGURATION OF SYSTEM TESTED	8
2.5 DESCRIPTION OF SUPPORT UNITS(CONDUCTED MODE)	8
2.6 EQUIPMENTS LIST FOR ALL TEST ITEMS	9
3 . EMC EMISSION TEST	10
3.1 CONDUCTED EMISSION MEASUREMENT	10
3.1.1 POWER LINE CONDUCTED EMISSION LIMITS	10
3.1.2 TEST PROCEDURE	11
3.1.3 DEVIATION FROM TEST STANDARD	11
3.1.4 TEST SETUP	11
3.1.5 EUT OPERATING CONDITIONS	11
3.1.6 TEST RESULTS	12
3.2 RADIATED EMISSION MEASUREMENT	14
3.2.1 RADIATED EMISSION LIMITS	14
3.2.2 TEST PROCEDURE	15
3.2.3 DEVIATION FROM TEST STANDARD	15
3.2.4 TEST SETUP	16
3.2.5 EUT OPERATING CONDITIONS	17
3.2.6 TEST RESULTS	18
4 . BANDWIDTH TEST	23
4.1 APPLIED PROCEDURES / LIMIT	23
4.1.1 TEST PROCEDURE	23
4.1.2 DEVIATION FROM STANDARD	23
4.1.3 TEST SETUP	23
4.1.4 EUT OPERATION CONDITIONS	23
4.1.5 TEST RESULTS	24
5 . 100 KHZ BANDWIDTH OF FREQUENCY BAND EDGE	29
5.1 DEVIATION FROM STANDARD	30
5.2 TEST SETUP	30
5.3 EUT OPERATION CONDITIONS	30



Table of Contents

Page

5.4 TEST RESULTS	30
6 . ANTENNA REQUIREMENT	34
6.1 STANDARD REQUIREMENT	34
6.2 EUT ANTENNA	34
7 . EUT TEST PHOTO	35
8 . EUT PHOTO	37



1. SUMMARY OF TEST RESULTS

Test procedures according to the technical standards:

FCC Part15 (15.249) , Subpart C			
Standard Section	Test Item	Judgment	Remark
15.207	Conducted Emission	PASS	
15.249	Fundamental & Radiated Spurious Emission Measurement	PASS	
15.249	Bandwidth	PASS	
15.205	Band Edge Emission	PASS	
15.203	Antenna Requirement	PASS	

NOTE:

(1) "N/A" denotes test is not applicable in this Test Report

1.1 TEST FACILITY

Shenzhen BCTC Technology Co., Ltd.

Add.:No.101,Yousong Road,Longhua New District, Shenzhen,China

FCC Registration No.:187086

1.2 MEASUREMENT UNCERTAINTY

The reported uncertainty of measurement $y \pm U$, where expanded uncertainty U is based on a standard uncertainty multiplied by a coverage factor of $k=2$, providing a level of confidence of approximately **95 %** .

No.	Item	Uncertainty
1	Conducted Emission Test	$\pm 1.38\text{dB}$
2	RF power,conducted	$\pm 0.16\text{dB}$
3	Spurious emissions,conducted	$\pm 0.21\text{dB}$
4	All emissions,radiated(<1G)	$\pm 4.68\text{dB}$
5	All emissions,radiated(>1G)	$\pm 4.89\text{dB}$
6	Temperature	$\pm 0.5^{\circ}\text{C}$
7	Humidity	$\pm 2\%$



2. GENERAL INFORMATION

2.1 GENERAL DESCRIPTION OF EUT

Equipment	Smart Light Speaker	
Trade Name	N/A	
Model Name	SLS-1	
Serial Model	SLS-2, SLS-3, SLS-4, SLS-5, SLS-6, SLS-7, SLS-8.	
Model Difference	All the same, Only model name is different.	
Product Description	Operation Frequency:	2402~2480 MHz
	Modulation Type:	GFSK,PI/4 DPSK,8DPSK
	Bit Rate of Transmitter	1M/2M/3Mbps
	Number Of Channel	79 CH
	Antenna Designation:	Please see Note 3.
	Based on the application, features, or specification exhibited in User's Manual, the EUT is considered as an ITE/Computing Device. More details of EUT technical specification, please refer to the User's Manual.	
Channel List	Please refer to the Note 2.	
Battery	DC 3.7V	
Connecting I/O Port(s)	Please refer to the User's Manual	
hardware version	--	
Software version	--	

Note:

1. For a more detailed features description, please refer to the manufacturer's specifications or the User's Manual.

2.

Channel List					
Channel	Frequency (MHz)	Channel	Frequency (MHz)	Channel	Frequency (MHz)
00	2402	27	2429	54	2456
01	2403	28	2430	55	2457
02	2404	29	2431	56	2458
03	2405	30	2432	57	2459
04	2406	31	2433	58	2460
05	2407	32	2434	59	2461
06	2408	33	2435	60	2462
07	2409	34	2436	61	2463
08	2410	35	2437	62	2464
09	2411	36	2438	63	2465
10	2412	37	2439	64	2466
11	2413	38	2440	65	2467



12	2414	39	2441	66	2468
13	2415	40	2442	67	2469
14	2416	41	2443	68	2470
15	2417	42	2444	69	2471
16	2418	43	2445	70	2472
17	2419	44	2446	71	2473
18	2420	45	2447	72	2474
19	2421	46	2448	73	2475
20	2422	47	2449	74	2476
21	2423	48	2450	75	2477
22	2424	49	2451	76	2478
23	2425	50	2452	77	2479
24	2426	51	2453	78	2480
25	2427	52	2454		
26	2428	53	2455		

3.

Table for Filed Antenna

Ant	Brand	Model Name	Antenna Type	Connector	Gain (dBi)	NOTE
1	N/A	N/A	PCB Antenna	N/A	0	

2.2 DESCRIPTION OF TEST MODES

To investigate the maximum EMI emission characteristics generates from EUT, the test system was pre-scanning tested base on the consideration of following EUT operation mode or test configuration mode which possible have effect on EMI emission level. Each of these EUT operation mode(s) or test configuration mode(s) mentioned above was evaluated respectively.

For All Mode	Description	Modulation Type
Mode 1	CH00	GFSK,PI/4 DPSK,8DPSK
Mode 2	CH39	
Mode 3	CH78	
Mode 4	Link mode(conducted emission and Radiated emission)	

Note:

- (1) The measurements are performed at the highest, middle, lowest available channels.
- (2) Fully-charged battery is used during the test

2.3 TABLE OF PARAMETERS OF TEXT SOFTWARE SETTING

During testing channel & power controlling software provided by the customer was used to control the operating channel as well as the output power level. The RF output power selection is for the setting of RF output power expected by the customer and is going to be fixed on the firmware of the final end product power parameters of FHSS

Frequency	2402 MHz	2441 MHz	2480 MHz
Channel	Low	Middle	High



2.4 BLOCK DIGRAM SHOWING THE CONFIGURATION OF SYSTEM TESTED

Radiated Spurious Emission Test



Conducted Emission Test

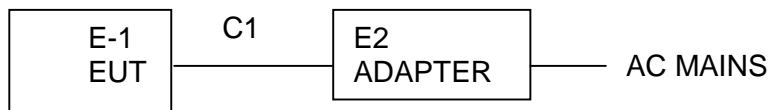

2.5 DESCRIPTION OF SUPPORT UNITS(CONDUCTED MODE)

The EUT has been tested as an independent unit together with other necessary accessories or support units. The following support units or accessories were used to form a representative test configuration during the tests.

Item	Equipment	Mfr/Brand	Model/Type No.	Series No.	Note
E-1	Smart Light Speaker	N/A	SLS-1	N/A	EUT
E-2	Adapter	N/A	JX-B050100-1	N/A	Input:100-240V~ 50/60Hz 0.2A Output: 5.0V $\overline{\text{---}}$ 1A

Item	Shielded Type	Ferrite Core	Length	Note
C1	NO	NO	0.8M	USB cable Un-Shielded

Note:

- (1) The support equipment was authorized by Declaration of Confirmation.
- (2) For detachable type I/O cable should be specified the length in cm in 『Length』 column.
- (3) “YES” is means “shielded” “with core”; “NO” is means “unshielded” “without core”.



2.6 EQUIPMENTS LIST FOR ALL TEST ITEMS

Conduction Test equipment

Item	Kind of Equipment	Manufacturer	Type No.	Serial No.	Last calibration	Calibrated until	Calibration period
1	Test Receiver	R&S	ESCI	1166.5950K03-101165-ha	2015.06.06	2016.06.05	1 year
2	LISN	R&S	NSLK8126	8126466	2015.08.24	2016.08.23	1 year
3	LISN	R&S	NSLK8126	8126487	2015.08.24	2016.08.23	1 year
4	50Ω Coaxial Switch	Anritsu	MP59B	6200264417	2015.06.07	2016.06.06	1 year
5	RF cables	R&S	R204	R20X	2015.07.06	2016.07.05	1 year

Radiation test, Band-edge test and 20db bandwidth test equipment

Item	Kind of Equipment	Manufacturer	Type No.	Serial No.	Last calibration	Calibrated until	Calibration period
1	Spectrum Analyzer	Agilent	E4407B	MY45108040	2015.07.06	2016.07.05	1 year
2	Test Receiver	R&S	ESPI	101318	2015.06.07	2016.06.06	1 year
3	Bilog Antenna	R&S	VULB9168	VULB9168-438	2015.07.06	2016.07.05	1 year
4	50Ω Coaxial Switch	Anritsu	MP59B	6200264416	2015.06.07	2016.06.06	1 year
5	Spectrum Analyzer	ADVANTEST	R3132	150900201	2015.06.07	2016.06.06	1 year
6	Horn Antenna	R&S	HF906	10027	2015.07.06	2016.07.05	1 year
7	Horn Ant	Schwarzbeck	BBHA 9170	9170-181	2015.07.06	2016.07.05	1 year
8	Amplifier	R&S	BBV9743	9743-019	2015.08.24	2016.08.23	1 year
9	Loop Antenna	ARA	PLA-1030/B	1029	2015.06.08	2016.06.07	1 year
10	RF cables	R&S	R203	R20X	2015.07.06	2016.07.05	1 year
11	Antenna connector	Florida RFLabs	Lab-Fle	RF 01#	2015.07.06	2016.07.05	1 year



3. EMC EMISSION TEST

3.1 CONDUCTED EMISSION MEASUREMENT

3.1.1 POWER LINE CONDUCTED EMISSION Limits (Frequency Range 150KHz-30MHz)

FREQUENCY (MHz)	Class A (dBuV)		Class B (dBuV)		Standard
	Quasi-peak	Average	Quas -peak	Average	
0.15 -0.5	79.00	66.00	66 - 56 *	56 - 46 *	CISPR
0.50 -5.0	73.00	60.00	56.00	46.00	CISPR
5.0 -30.0	73.00	60.00	60.00	50.00	CISPR

0.15 -0.5	79.00	66.00	66 - 56 *	56 - 46 *	FCC
0.50 -5.0	73.00	60.00	56.00	46.00	FCC
5.0 -30.0	73.00	60.00	60.00	50.00	FCC

Note:

- (1) The tighter limit applies at the band edges.
- (2) The limit of " * " marked band means the limitation decreases linearly with the logarithm of the frequency in the range.

The following table is the setting of the receiver

Receiver Parameters	Setting
Attenuation	10 dB
Start Frequency	0.15 MHz
Stop Frequency	30 MHz
IF Bandwidth	9 kHz

3.1.2 TEST PROCEDURE

- The EUT was placed 0.8 meters from the horizontal ground plane with EUT being connected to the power mains through a line impedance stabilization network (LISN). All other support equipments powered from additional LISN(s). The LISN provide 50 Ohm/ 50uH of coupling impedance for the measuring instrument.
- Interconnecting cables that hang closer than 40 cm to the ground plane shall be folded back and forth in the center forming a bundle 30 to 40 cm long.
- I/O cables that are not connected to a peripheral shall be bundled in the center. The end of the cable may be terminated, if required, using the correct terminating impedance. The overall length shall not exceed 1 m.
- LISN at least 80 cm from nearest part of EUT chassis.
- For the actual test configuration, please refer to the related Item –EUT Test Photos.

3.1.3 DEVIATION FROM TEST STANDARD

No deviation

3.1.4 TEST SETUP

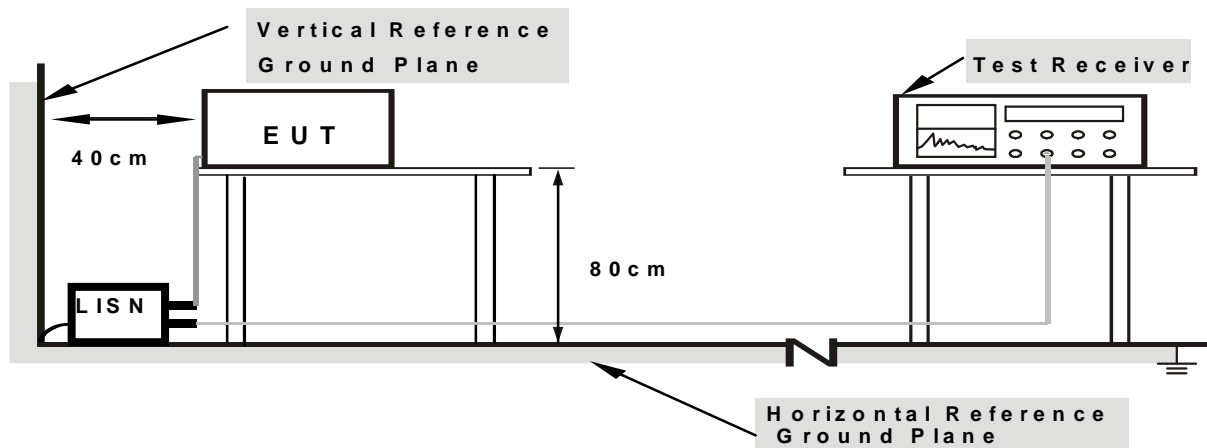

- Note: 1.Support units were connected to second LISN .
2.Both of LISNs (AMN) are 80 cm from EUT and at least 80 from other units and other metal planes

3.1.5 EUT OPERATING CONDITIONS

The EUT was configured for testing in a typical fashion (as a customer would normally use it). The EUT has been programmed to continuously transmit during test. This operating condition was tested and used to collect the included data.

We pretest AC 120V and AC 240V, the worst voltage was AC 120V and the data recording in the report.



3.1.6 TEST RESULTS

EUT :	Smart Light Speaker	Model Name :	SLS-1
Temperature :	25 °C	Relative Humidity :	54%
Pressure :	1010hPa	Phase :	L
Test Voltage :	AC120V from adapter	Test Mode :	Mode 4(Worst Mode)

Frequency (MHz)	Meter Reading (dBμV)	Factor (dB)	Emission Level (dBμV)	Limits (dBμV)	Margin (dB)	Detector Type
0.1582	38.99	10.05	49.04	65.55	-16.51	QP
0.1582	22.41	10.05	32.46	55.55	-23.09	AVG
0.3596	31.70	10.10	41.80	58.74	-16.94	QP
0.3596	18.22	10.10	28.32	48.74	-20.42	AVG
0.8540	21.84	10.15	31.99	56.00	-24.01	QP
0.8540	8.03	10.15	18.18	46.00	-27.82	AVG
2.1860	23.13	10.18	33.31	56.00	-22.69	QP
2.1860	10.49	10.18	20.67	46.00	-25.33	AVG
4.4820	25.04	10.16	35.20	56.00	-20.80	QP
4.4820	14.02	10.16	24.18	46.00	-21.82	AVG
18.7139	20.15	10.17	30.32	60.00	-29.68	QP
18.7139	10.17	10.17	20.34	50.00	-29.66	AVG

Remark:

1. All readings are Quasi-Peak and Average values.
2. Factor = Insertion Loss + Cable Loss.

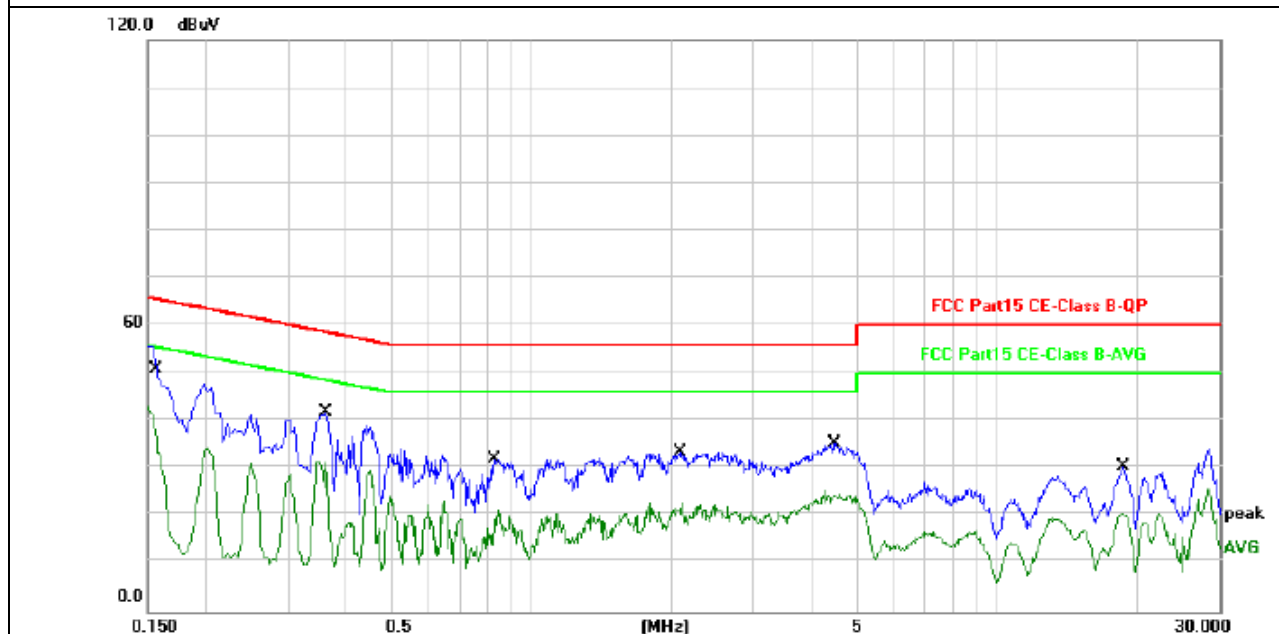



EUT :	Smart Light Speaker	Model Name :	SLS-1
Temperature :	25 °C	Relative Humidity :	54%
Pressure :	1010hPa	Phase :	N
Test Voltage :	AC120V from adapter	Test Mode :	Mode 4(Worst Mode)

Frequency (MHz)	Meter Reading (dBμV)	Factor (dB)	Emission Level (dBμV)	Limits (dBμV)	Margin (dB)	Detector Type
0.1665	37.44	10.06	47.50	65.15	-17.65	QP
0.1665	6.38	10.06	16.44	55.15	-38.71	AVG
0.3558	32.43	10.10	42.53	58.82	-16.29	QP
0.3558	22.45	10.10	32.55	48.82	-16.27	AVG
0.4760	25.96	10.11	36.07	56.58	-20.51	QP
0.4760	12.15	10.11	22.26	46.58	-24.32	AVG
2.1299	21.79	10.18	31.97	56.00	-24.03	QP
2.1299	10.58	10.18	20.76	46.00	-25.24	AVG
5.3820	20.38	10.13	30.51	60.00	-29.49	QP
5.3820	9.05	10.13	19.18	50.00	-30.82	AVG
28.4780	24.67	10.21	34.88	60.00	-25.12	QP
28.4780	11.89	10.21	22.10	50.00	-27.90	AVG

Remark:

1. All readings are Quasi-Peak and Average values.
2. Factor = Insertion Loss + Cable Loss.

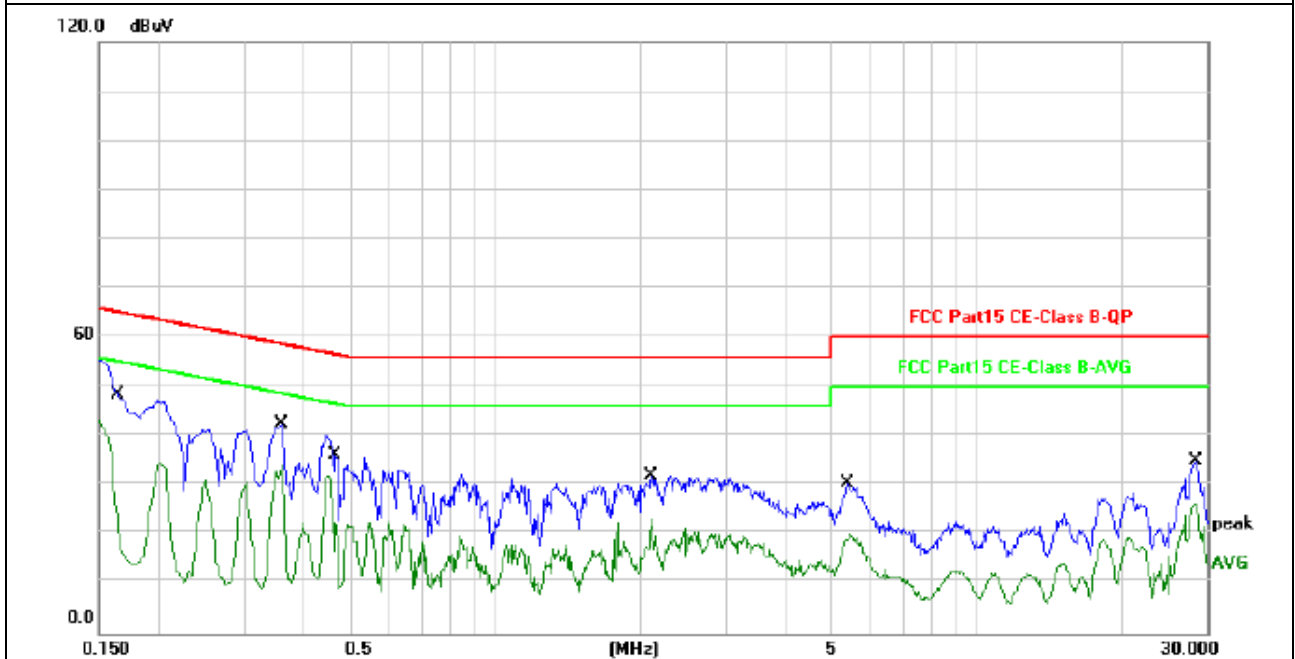



3.2 RADIATED EMISSION MEASUREMENT

3.2.1 RADIATED EMISSION LIMITS (Frequency Range 9kHz-1000MHz)

20dBc in any 100 kHz bandwidth outside the operating frequency band. In case the emission fall within the restricted band specified on 15.205(a), then the 15.209(a) limit in the table below has to be followed.

Frequencies (MHz)	Field Strength (micorvolts/meter)	Measurement Distance (meters)
0.009~0.490	2400/F(KHz)	300
0.490~1.705	24000/F(KHz)	30
1.705~30.0	30	30
30~88	100	3
88~216	150	3
216~960	200	3
Above 960	500	3

LIMITS OF RADIATED EMISSION MEASUREMENT (Above 1000MHz)

FREQUENCY (MHz)	Class B (dBuV/m) (at 3M)	
	PEAK	AVERAGE
Above 1000	74	54

Notes:

- (1) The limit for radiated test was performed according to FCC PART 15C.
- (2) The tighter limit applies at the band edges.
- (3) Emission level (dBuV/m)=20log Emission level (uV/m).

FREQUENCY RANGE OF RADIATED MEASUREMENT (For unintentional radiators)

Highest frequency generated or Upper frequency of measurement used in the device or on which the device operates or tunes (MHz)	Range (MHz)
Below 1.705	30
1.705 – 108	1000
108 – 500	2000
500 – 1000	5000
Above 1000	5 th harmonic of the highest frequency or 40 GHz, whichever is lower



Spectrum Parameter	Setting
Attenuation	Auto
Start Frequency	1000 MHz
Stop Frequency	10th carrier harmonic
RB / VB (emission in restricted band)	1 MHz / 1 MHz for Peak, 1 MHz / 10Hz for Average

Receiver Parameter	Setting
Attenuation	Auto
Start ~ Stop Frequency	9kHz~150kHz / RB 200Hz for QP
Start ~ Stop Frequency	150kHz~30MHz / RB 9kHz for QP
Start ~ Stop Frequency	30MHz~1000MHz / RB 120kHz for QP

3.2.2 TEST PROCEDURE

- a. The measuring distance of at 3 m shall be used for measurements at frequency up to 25GHz. For frequencies above 1GHz, any suitable measuring distance may be used.
- b. The EUT was placed on the top of a rotating table 1.5 meters above the ground at a 3 meter open area test site. The table was rotated 360 degrees to determine the position of the highest radiation.
- c. The height of the equipment or of the substitution antenna shall be 1.5 m; the height of the test antenna shall vary between 1 m to 4 m. Both horizontal and vertical polarizations of the antenna are set to make the measurement.
- d. The initial step in collecting conducted emission data is a spectrum analyzer peak detector mode pre-scanning the measurement frequency range. Significant peaks are then marked and then Quasi Peak detector mode re-measured.
- e. If the Peak Mode measured value compliance with and lower than Quasi Peak Mode Limit, the EUT shall be deemed to meet QP Limits and then no additional QP Mode measurement performed.
- f. For the actual test configuration, please refer to the related Item –EUT Test Photos.
- g. For the radiated emission test above 1GHz:
Place the measurement antenna away from each area of the EUT determined to be a source of emissions at the specified measurement distance, while keeping the measurement antenna aimed at the source of emissions at each frequency of significant emissions, with polarization oriented for maximum response.
The measurement antenna may have to be higher or lower than the EUT, depending on the radiation pattern of the emission and staying aimed at the emission source for receiving the maximum signal. The final measurement antenna elevation shall be that which maximizes the emissions. The measurement antenna elevation for maximum emissions shall be restricted to a range of heights of from 1 m to 4 m above the ground or reference ground plane.

Note:

Both horizontal and vertical antenna polarities were tested and performed pretest to three orthogonal axis. The worst case emissions were reported

3.2.3 DEVIATION FROM TEST STANDARD

No deviation

3.2.4 TEST SETUP

(A) Radiated Emission Test-Up Frequency Below 30MHz

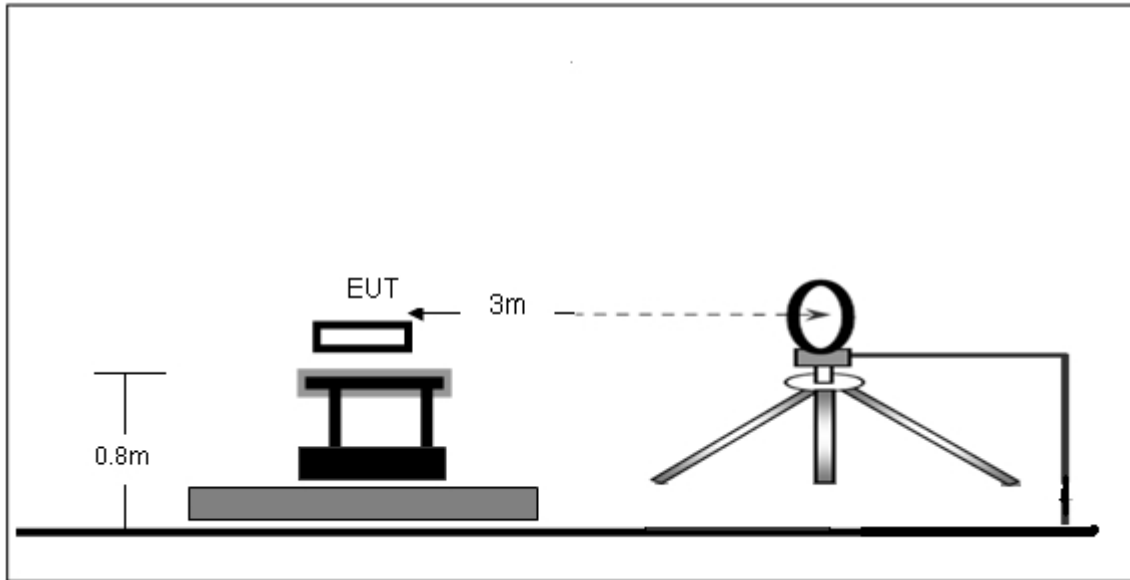

(B) Radiated Emission Test-Up Frequency 30MHz~1GHz

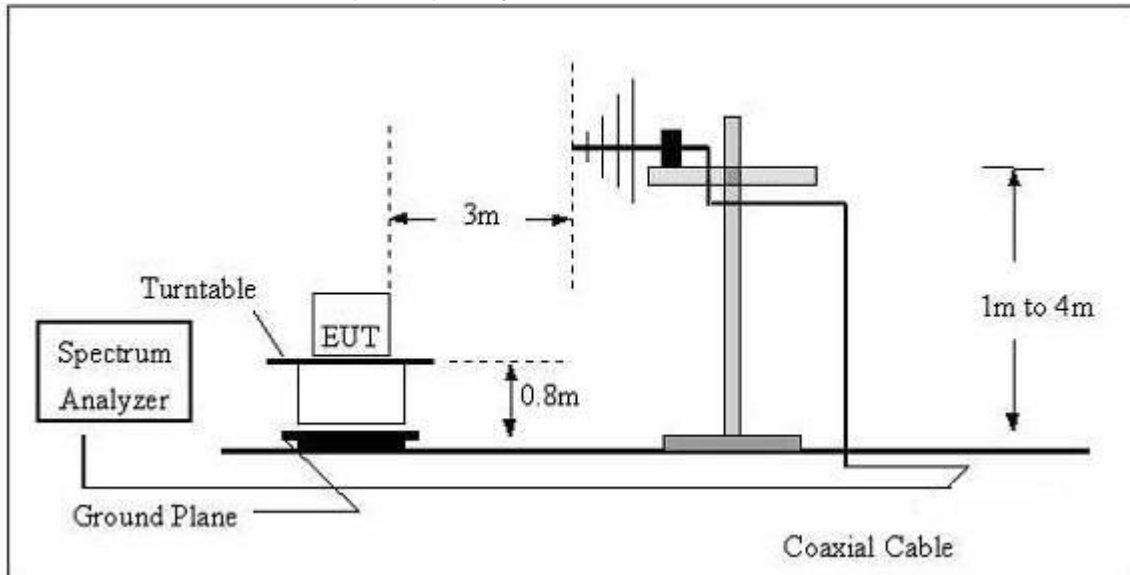

(C) Radiated Emission Test-Up Frequency Above 1GHz

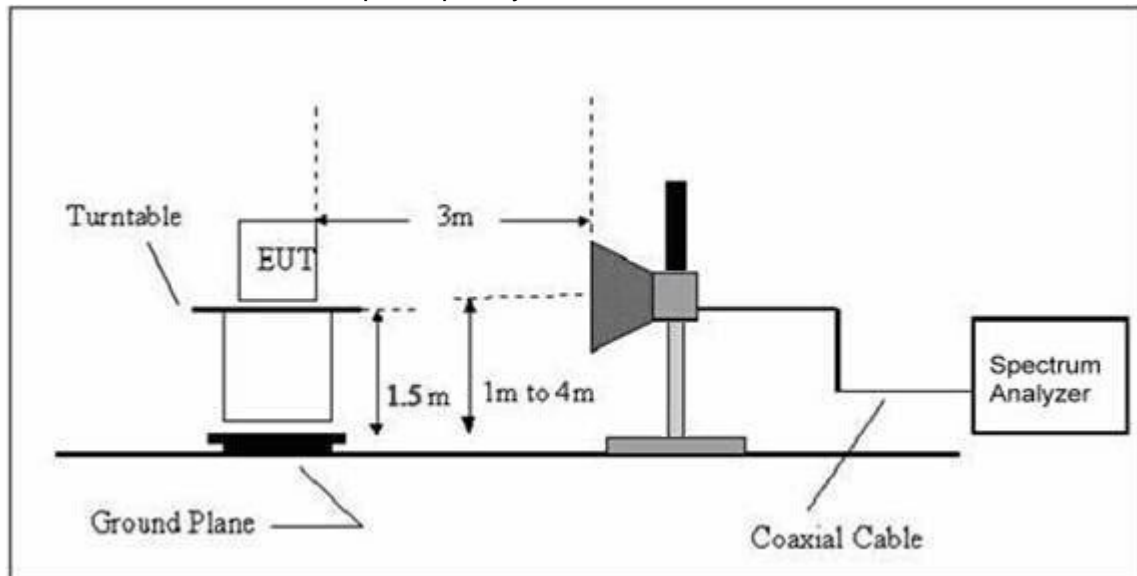
**3.2.5 EUT OPERATING CONDITIONS**

The EUT tested system was configured as the statements of 2.4 Unless otherwise a special operating condition is specified in the follows during the testing.



3.2.6 TEST RESULTS

Radiated Spurious Emission (Below 30MHz)

EUT :	Smart Light Speaker	Model Name :	SLS-1
Temperature :	25 °C	Relative Humidity :	55%
Pressure :	1010 hPa	Polarization :	---
Test Voltage :	DC3.7V		
Test Mode :	TX		

Freq.	Reading	Limit	Margin	State
(MHz)	(dBuV/m)	(dBuV/m)	(dB)	P/F
--	--	--	--	PASS
--	--	--	--	PASS

NOTE:

The amplitude of spurious emissions which are attenuated by more than 20dB below the permissible value has no need to be reported.

Distance extrapolation factor = $40 \log(\text{specific distance}/\text{test distance})$ (dB);

Limit line = specific limits(dBuv) + distance extrapolation factor.



Radiated Spurious Emission (Between 30MHz – 1GHz)

EUT :	Smart Light Speaker	Model Name :	SLS-1
Temperature :	25 °C	Relative Humidity :	55%
Pressure :	1010 hPa	Polarization :	Horizontal
Test Voltage :	DC 3.7V		
Test Mode : (Worst)	Link mode		

Frequency (MHz)	Meter Reading (dBµV)	Factor (dB)	Emission Level (dBµV/m)	Limits (dBµV/m)	Margin (dB)	Detector Type
53.8818	29.89	-10.93	18.96	40.00	-21.04	QP
154.2786	31.52	-12.86	18.66	43.50	-24.84	QP
300.3672	43.21	-12.57	30.64	46.00	-15.36	QP
360.4476	45.16	-11.20	33.96	46.00	-12.04	QP
420.5803	46.18	-9.73	36.45	46.00	-9.55	QP
942.1305	29.90	-0.63	29.27	46.00	-16.73	QP

Remark:
 Factor = Antenna Factor + Cable Loss – Pre-amplifier.
 All interfaces was connected, and BT TX mode was link.

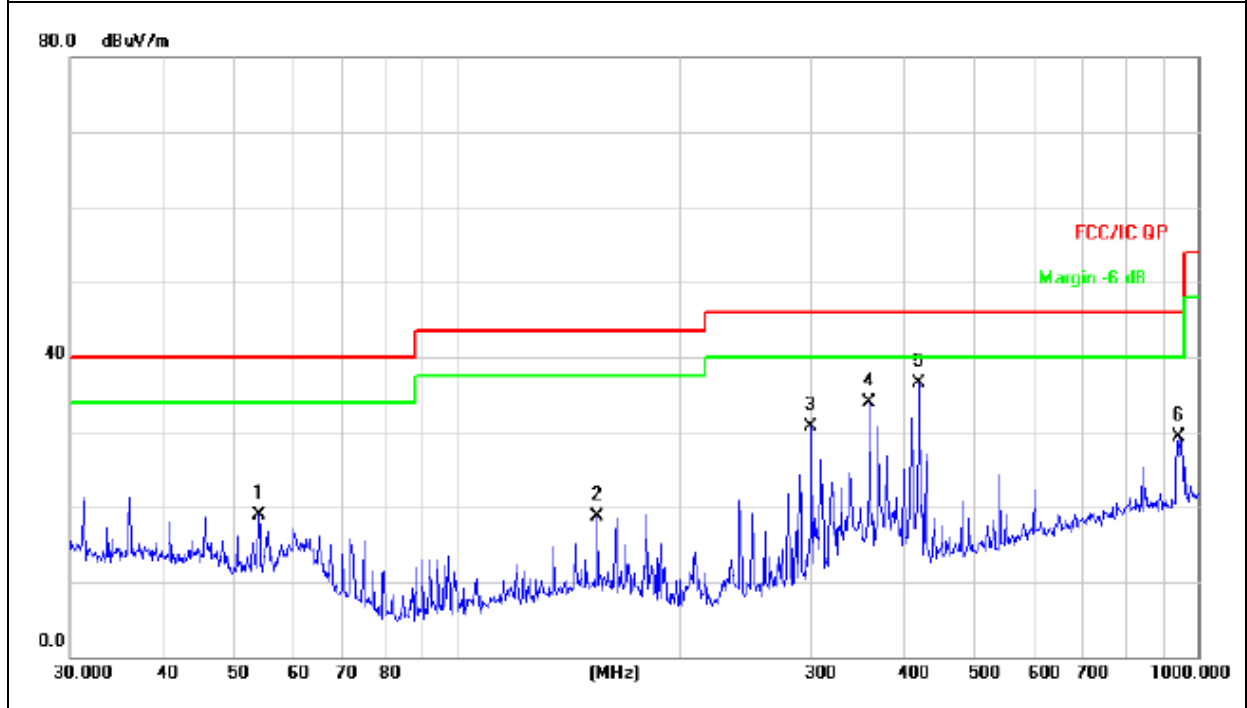



EUT :	Smart Light Speaker	Model Name :	SLS-1
Temperature :	25 °C	Relative Humidity :	55%
Pressure :	1010 hPa	Polarization :	Vertical
Test Voltage :	DC3.7V		
Test Mode : (Worst)	Link mode		

Frequency (MHz)	Meter Reading (dBμV)	Factor (dB)	Emission Level (dBμV/m)	Limits (dBμV/m)	Margin (dB)	Detector Type
31.1798	44.91	-8.19	36.72	40.00	-3.28	QP
64.6594	45.98	-12.45	33.53	40.00	-6.47	QP
140.8351	37.00	-13.34	23.66	43.50	-19.84	QP
211.5265	43.80	-15.87	27.93	43.50	-15.57	QP
420.5803	43.55	-9.73	33.82	46.00	-12.18	QP
601.4265	32.07	-5.66	26.41	46.00	-19.59	QP

Remark:

Factor = Antenna Factor + Cable Loss – Pre-amplifier.

All interfaces was connected, and BT TX mode was link.

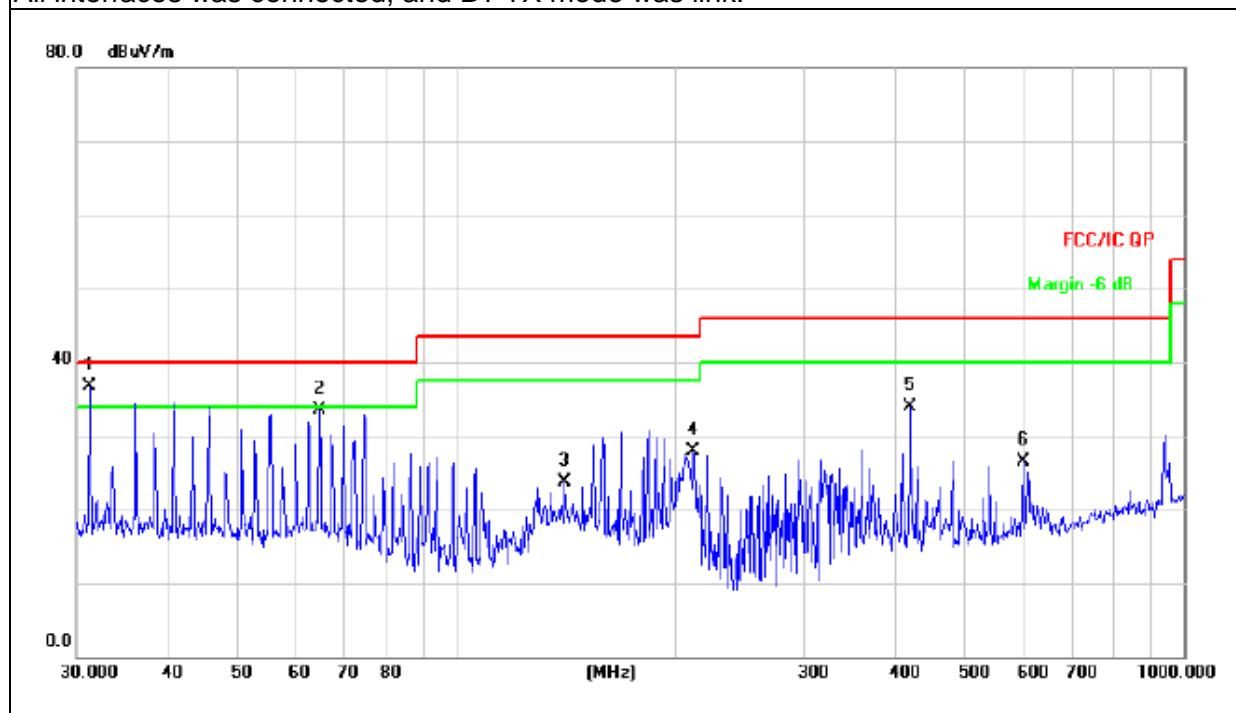



Radiated Spurious Emission (1GHz to 10th harmonics)
GFSK

	Freq.	Receiver Reading	Detector	Polar	Corrected Factor	Emission Level	Limit	Result
	(MHz)	(dBμV)	(PK/QP/Ave)	(H/V)	(dB)	(dBμV/m)	(dBμV/m)	
Lower Channel 2402MHz	2402	102.65	PK	H	1.31	103.96	114	Pass
	2402	88.25	Ave	H	1.31	89.56	94	Pass
	4804	55.52	PK	H	-1.06	54.46	74	Pass
	4804	45.57	Ave	H	-1.06	44.51	54	Pass
	2402	102.36	PK	V	1.31	103.67	114	Pass
	2402	88.75	Ave	V	1.31	90.06	94	Pass
	4804	54.68	PK	V	-1.06	53.62	74	Pass
	4804	45.37	Ave	V	-1.06	44.31	54	Pass
	Middle Channel 2441MHz	2441	102.56	PK	H	0.85	103.41	114
2441		88.71	Ave	H	0.85	89.56	94	Pass
4882		57.36	PK	H	-0.62	56.74	74	Pass
4882		48.45	Ave	H	-0.62	47.83	54	Pass
2441		102.42	PK	V	0.85	103.27	114	Pass
2441		88.31	Ave	V	0.85	89.16	94	Pass
4882		57.43	PK	V	-0.62	56.81	74	Pass
4882		48.85	Ave	V	-0.62	48.23	54	Pass
Upper Channel 2480MHz	2480	103.61	PK	H	0.53	104.14	114	Pass
	2480	87.87	Ave	H	0.53	88.4	94	Pass
	4960	57.52	PK	H	-0.24	57.28	74	Pass
	4960	48.63	Ave	H	-0.24	48.39	54	Pass
	2480	103.24	PK	V	0.53	103.77	114	Pass
	2480	88.24	Ave	V	0.53	88.77	94	Pass
	4960	57.28	PK	V	-0.24	57.04	74	Pass
	4960	47.32	Ave	V	-0.24	47.08	54	Pass

Remark:

Factor = Antenna Factor + Cable Loss – Pre-amplifier.

Emission Level = Meter Reading + Factor

Margin = Emission Level - Limit

Other harmonics emissions are lower than 20dB below the allowable limit.



8DPSK

	Freq.	Receiver Reading	Detector	Polar	Corrected Factor	Emission Level	Limit	Result
	(MHz)	(dBμV)	(PK/QP/Ave)	(H/V)	(dB)	(dBμV/m)	(dBμV/m)	
Lower Channel 2402MHz	2402.00	103.15	PK	H	1.31	104.46	114	Pass
	2402.00	88.45	Ave	H	1.31	89.76	94	Pass
	4804.00	56.58	PK	H	-1.06	55.52	74	Pass
	4804.00	48.74	Ave	H	-1.06	47.68	54	Pass
	2402.00	103.31	PK	V	1.31	104.62	114	Pass
	2402.00	88.79	Ave	V	1.31	90.1	94	Pass
	4804.00	57.06	PK	V	-1.06	56	74	Pass
	4804.00	48.25	Ave	V	-1.06	47.19	54	Pass
	Middle Channel 2441MHz	2441.00	102.77	PK	H	0.85	103.62	114
2441.00		88.32	Ave	H	0.85	89.17	94	Pass
4882.00		57.23	PK	H	-0.62	56.61	74	Pass
4882.00		48.33	Ave	H	-0.62	47.71	54	Pass
2441.00		103.22	PK	V	0.85	104.07	114	Pass
2441.00		87.27	Ave	V	0.85	88.12	94	Pass
4882.00		56.86	PK	V	-0.62	56.24	74	Pass
4882.00		48.04	Ave	V	-0.62	47.42	54	Pass
Upper Channel 2480MHz	2480.00	102.43	PK	H	0.53	102.96	114	Pass
	2480.00	88.76	Ave	H	0.53	89.29	94	Pass
	4960.00	57.23	PK	H	-0.24	56.99	74	Pass
	4960.00	48.14	Ave	H	-0.24	47.9	54	Pass
	2480.00	102.71	PK	V	0.53	103.24	114	Pass
	2480.00	88.62	Ave	V	0.53	89.15	94	Pass
	4960.00	57.73	PK	V	-0.24	57.49	74	Pass
	4960.00	48.55	Ave	V	-0.24	48.31	54	Pass

Remark:

Factor = Antenna Factor + Cable Loss – Pre-amplifier.

Emission Level = Meter Reading + Factor

Margin = Emission Level - Limit

Other harmonics emissions are lower than 20dB below the allowable limit.



4. BANDWIDTH TEST

4.1 APPLIED PROCEDURES / LIMIT

FCC Part15 (15.249) , Subpart C				
Section	Test Item	Limit	Frequency Range (MHz)	Result
15.249	Bandwidth	(20dB bandwidth)	2400-2483.5	PASS

Spectrum Parameter	Setting
Attenuation	Auto
Span Frequency	> Measurement Bandwidth or Channel Separation
RB	30KHz
VB	\geq RBW
Detector	Peak
Trace	Max Hold
Sweep Time	Auto

4.1.1 TEST PROCEDURE

- The EUT was directly connected to the spectrum analyzer and antenna output port as show in the block diagram below,
- Spectrum Setting : RBW= 30KHz, VBW \geq RBW, Sweep time = Auto.

4.1.2 DEVIATION FROM STANDARD

No deviation.

4.1.3 TEST SETUP

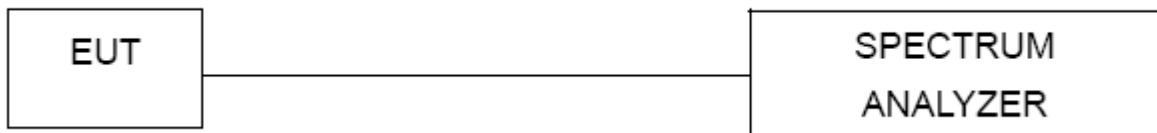

4.1.4 EUT OPERATION CONDITIONS

The EUT tested system was configured as the statements of 2.4 Unless otherwise a special operating condition is specified in the follows during the testing.



4.1.5 TEST RESULTS

EUT :	Smart Light Speaker	Model Name :	SLS-1
Temperature :	25 °C	Relative Humidity :	55%
Pressure :	1012 hPa	Test Voltage :	DC 3.7V
Test Mode :	CH00/CH39/C78		

	Frequency	20dB Bandwidth (kHz)	Result
GFSK	2402 MHz	839.926	PASS
	2441 MHz	722.859	PASS
	2480 MHz	821.017	PASS
PI/4 DPSK	2402 MHz	1112	PASS
	2441 MHz	1078	PASS
	2480 MHz	1126	PASS
8DPSK	2402 MHz	1097	PASS
	2441 MHz	1131	PASS
	2480 MHz	1134	PASS



GFSK

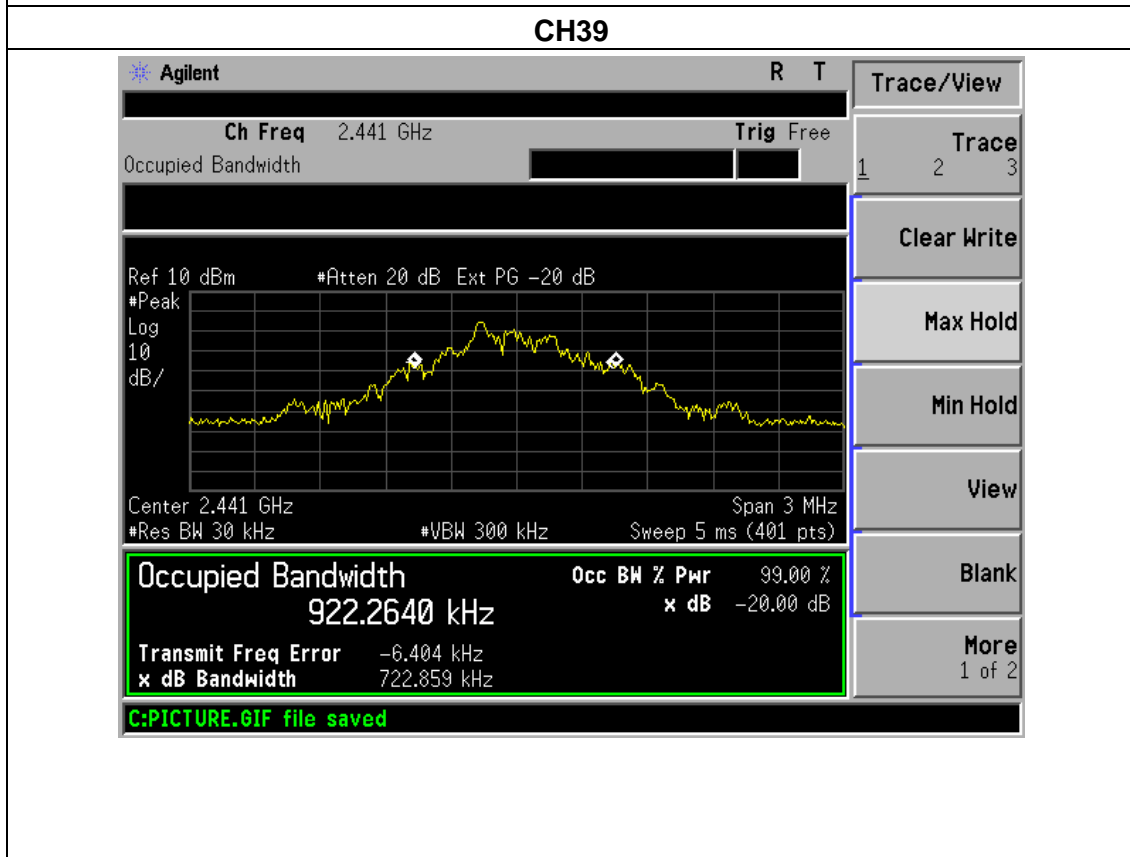
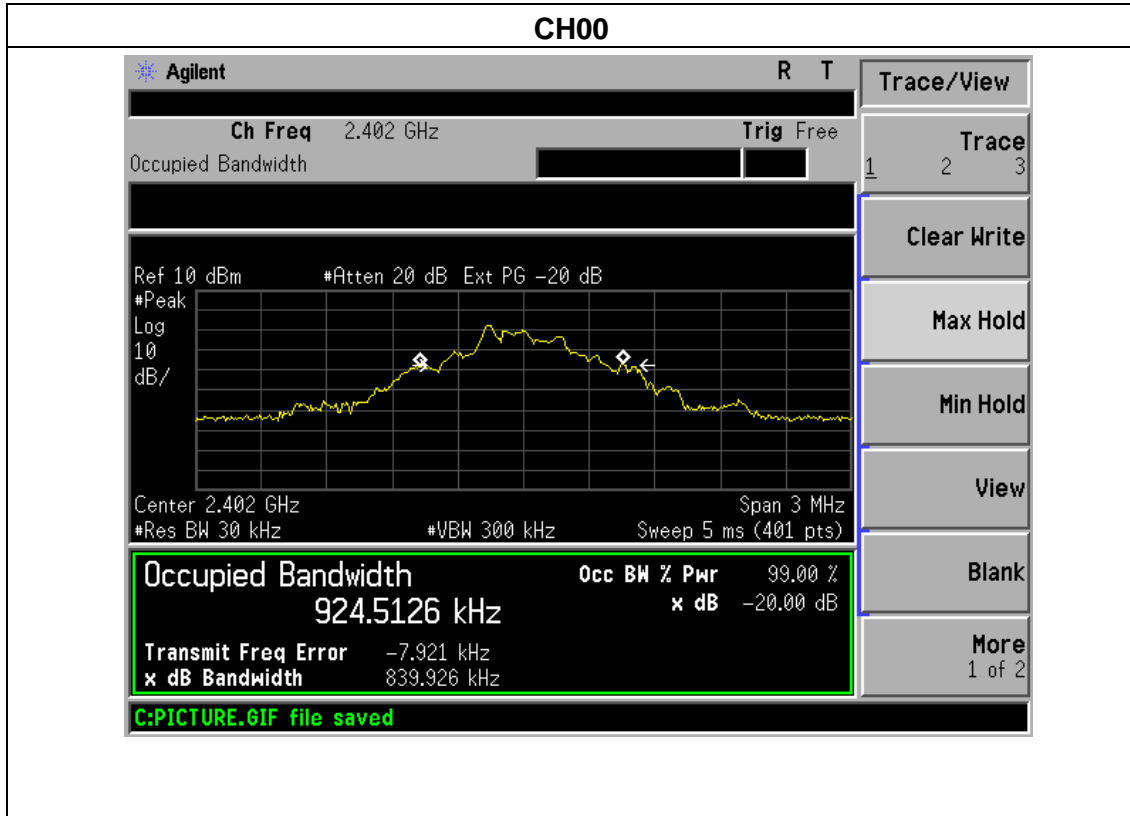

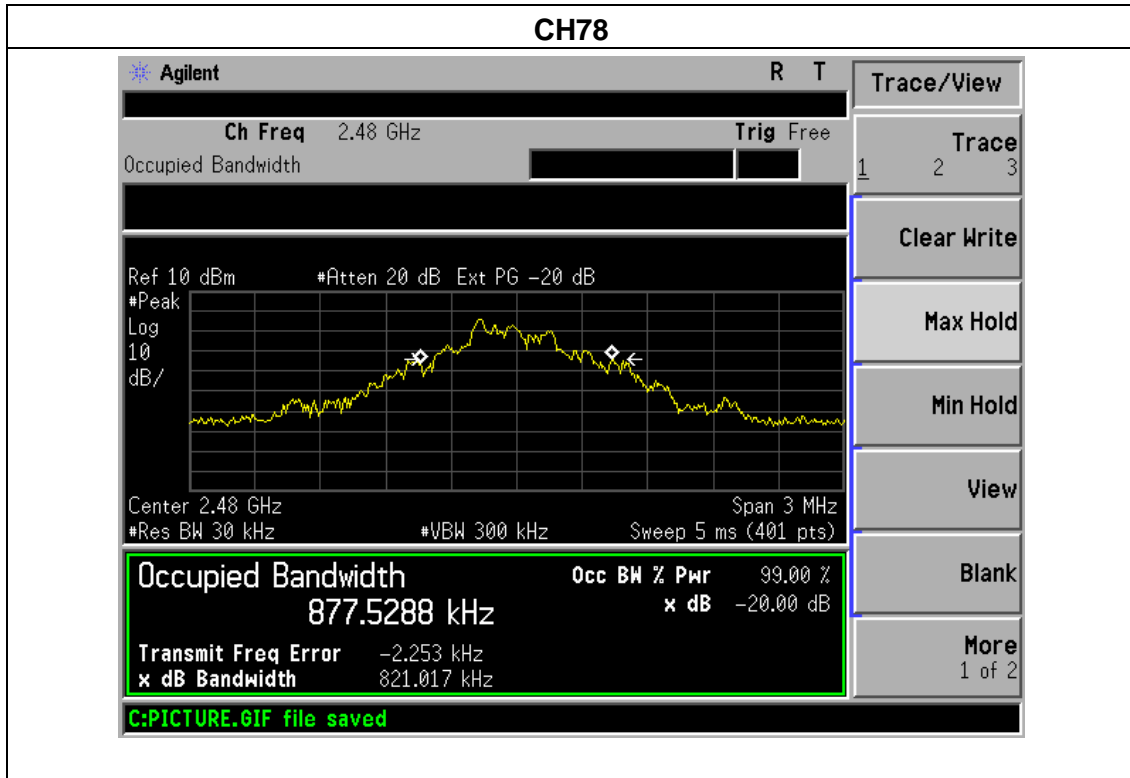



8DPSK

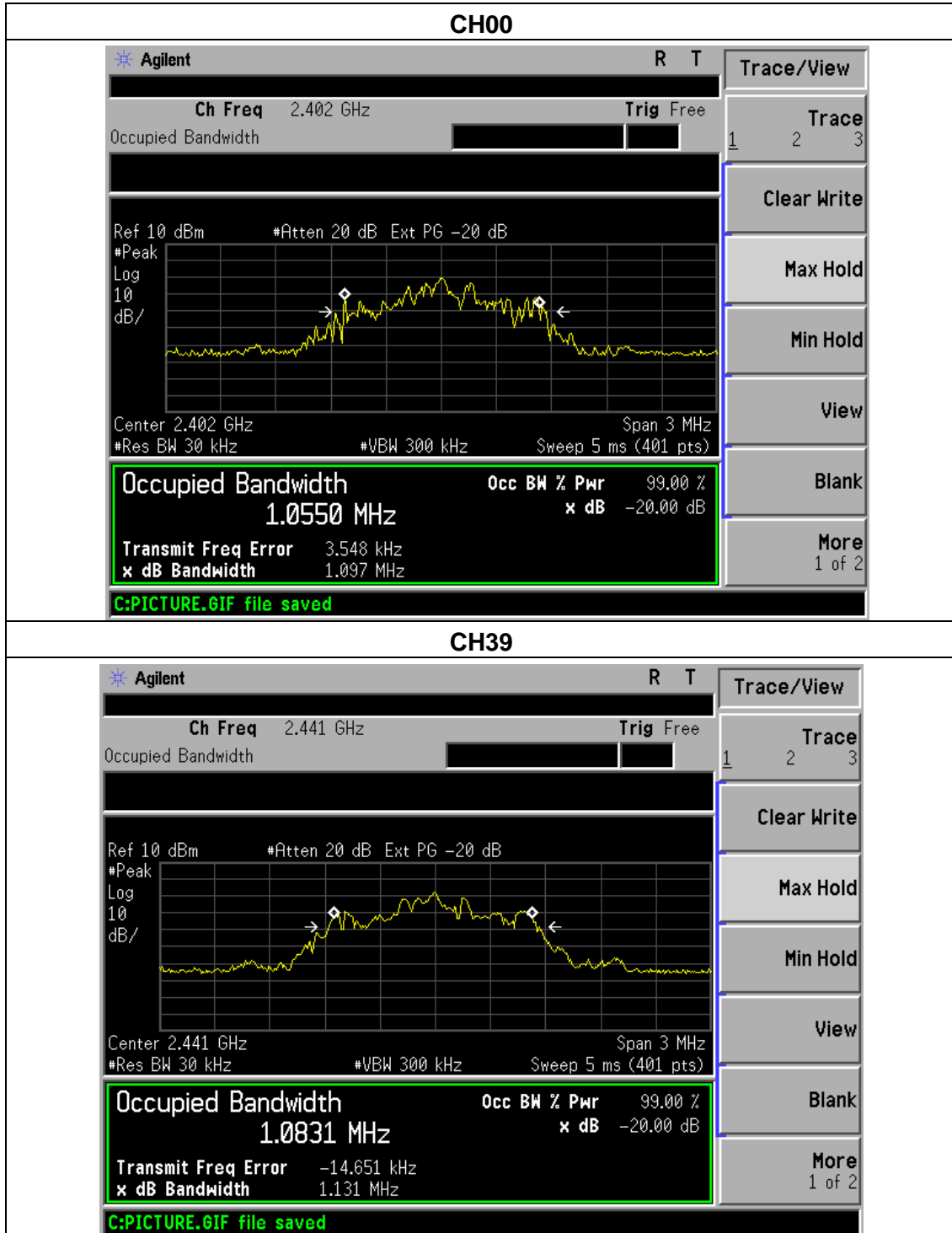

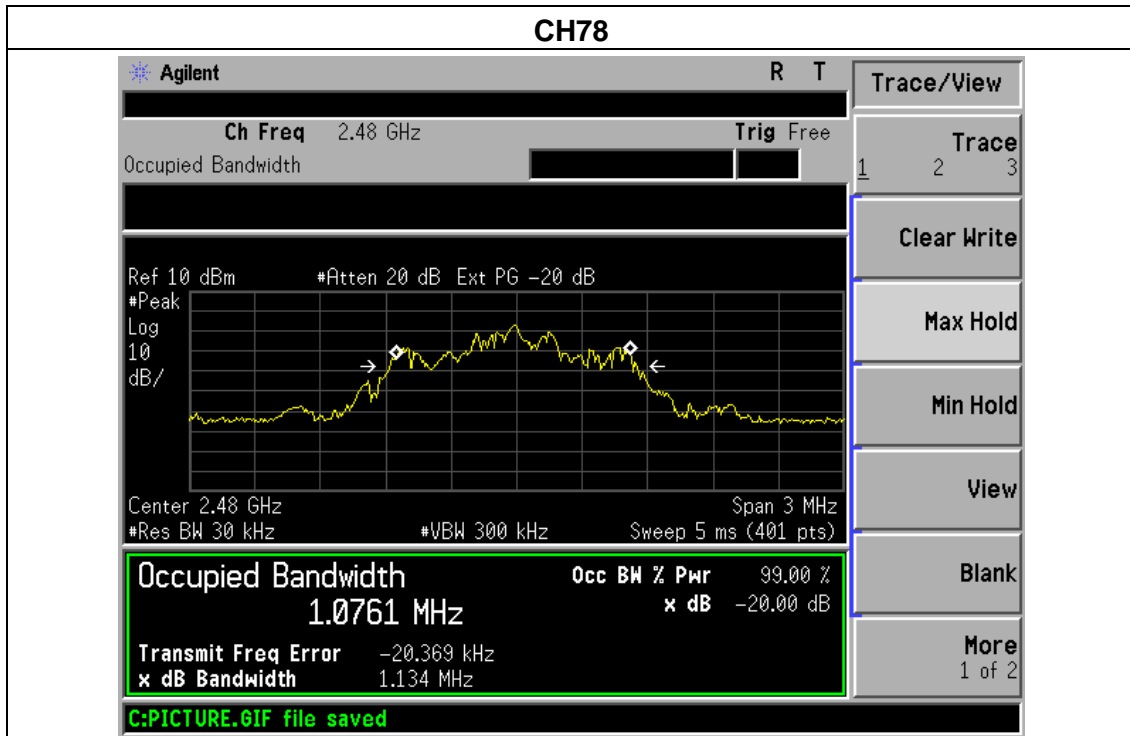



5. 100 KHZ BANDWIDTH OF FREQUENCY BAND EDGE APPLICABLE STANDARD

In any 100 kHz bandwidth outside the frequency band in which the spread spectrum or digitally modulated intentional radiator is operating, the radio frequency power that is produced by the intentional radiator shall be at least 20 dB below that in the 100 kHz bandwidth within the band that contains the highest level of the desired power, based on either an RF conducted or a radiated measurement, provided the transmitter demonstrates compliance with the peak conducted power limits. If the transmitter complies with the conducted power limits based on the use of RMS averaging over a time interval, as permitted under paragraph (b)(3) of this section, the attenuation required under this paragraph shall be 30 dB instead of 20 dB. Attenuation below the general limits specified in §15.209(a) is not required. In addition, radiated emissions which fall in the restricted bands, as defined in §15.205(a), must also comply with the radiated emission limits specified in §15.209(a) (see §15.205(c)).

TEST PROCEDURE

- a. The measuring distance of at 3 m shall be used for measurements at frequency up to 25GHz. For frequencies above 1GHz, any suitable measuring distance may be used.
- b. The EUT was placed on the top of a rotating table 1.5 meters above the ground at a 3 meter open area test site. The table was rotated 360 degrees to determine the position of the highest radiation.
- c. The height of the equipment or of the substitution antenna shall be 1.5 m; the height of the test antenna shall vary between 1 m to 4 m. Both horizontal and vertical polarizations of the antenna are set to make the measurement.
- d. The initial step in collecting conducted emission data is a spectrum analyzer peak detector mode pre-scanning the measurement frequency range. Significant peaks are then marked and then Quasi Peak detector mode re-measured.
- e. If the Peak Mode measured value compliance with and lower than Quasi Peak Mode Limit, the EUT shall be deemed to meet QP Limits and then no additional QP Mode measurement performed.
- f. For the actual test configuration, please refer to the related Item –EUT Test Photos.
- g. For the radiated emission test above 1GHz:
Place the measurement antenna away from each area of the EUT determined to be a source of emissions at the specified measurement distance, while keeping the measurement antenna aimed at the source of emissions at each frequency of significant emissions, with polarization oriented for maximum response.
The measurement antenna may have to be higher or lower than the EUT, depending on the radiation pattern of the emission and staying aimed at the emission source for receiving the maximum signal. The final measurement antenna elevation shall be that which maximizes the emissions. The measurement antenna elevation for maximum emissions shall be restricted to a range of heights of from 1 m to 4 m above the ground or reference ground plane.

Note:

Both horizontal and vertical antenna polarities were tested and performed pretest to three orthogonal axis. The worst case emissions were reported



5.1 DEVIATION FROM STANDARD

No deviation.

5.2 TEST SETUP

5.3 EUT OPERATION CONDITIONS

The EUT tested system was configured as the statements of 2.4 Unless otherwise a special operating condition is specified in the follows during the testing.

5.4 TEST RESULTS

EUT :	Smart Light Speaker	Model Name :	SLS-1
Temperature :	25 °C	Relative Humidity :	55%
Pressure :	1012 hPa	Test Voltage :	DC 3.7V
Test Mode :	CH00/ CH78		

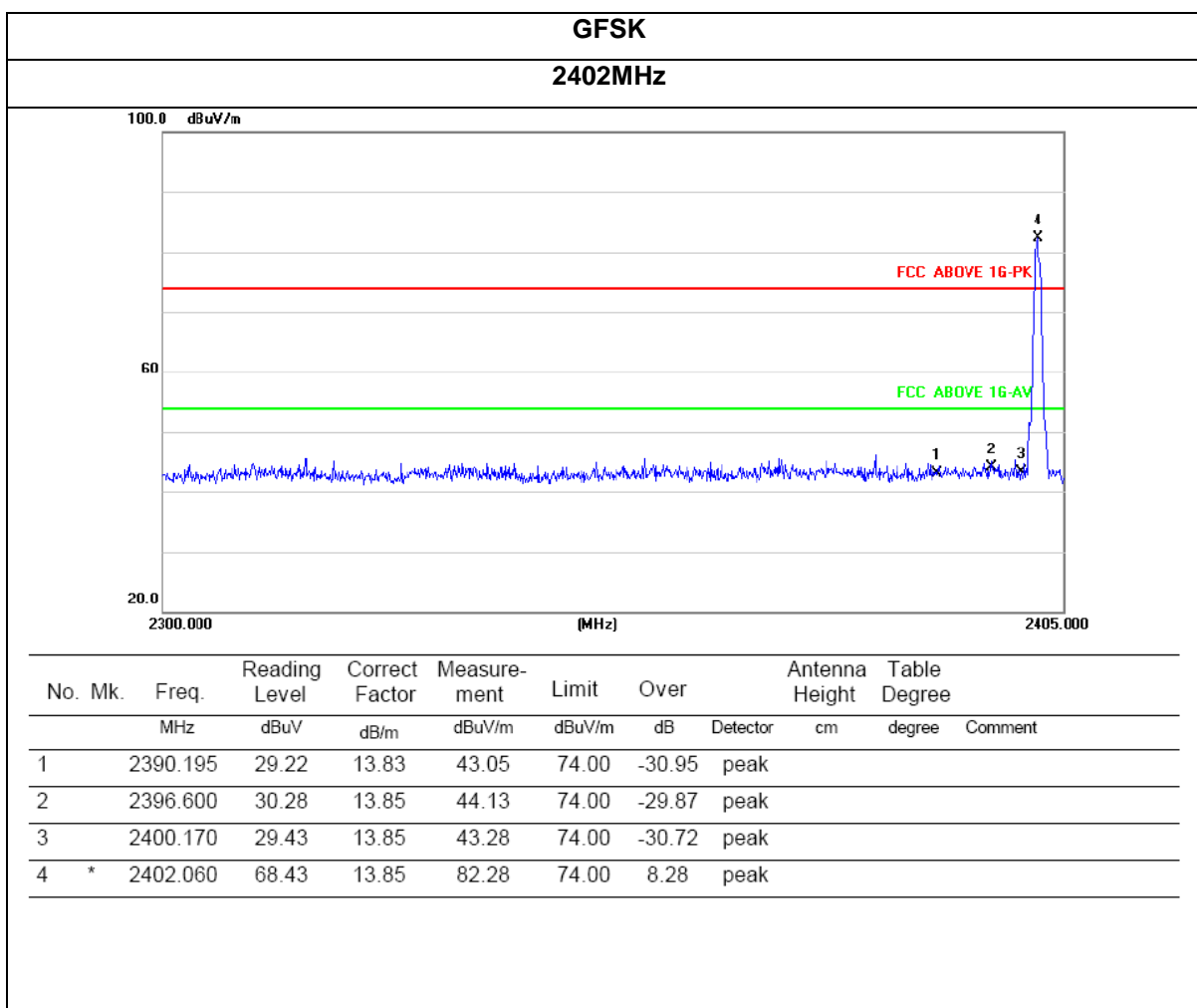

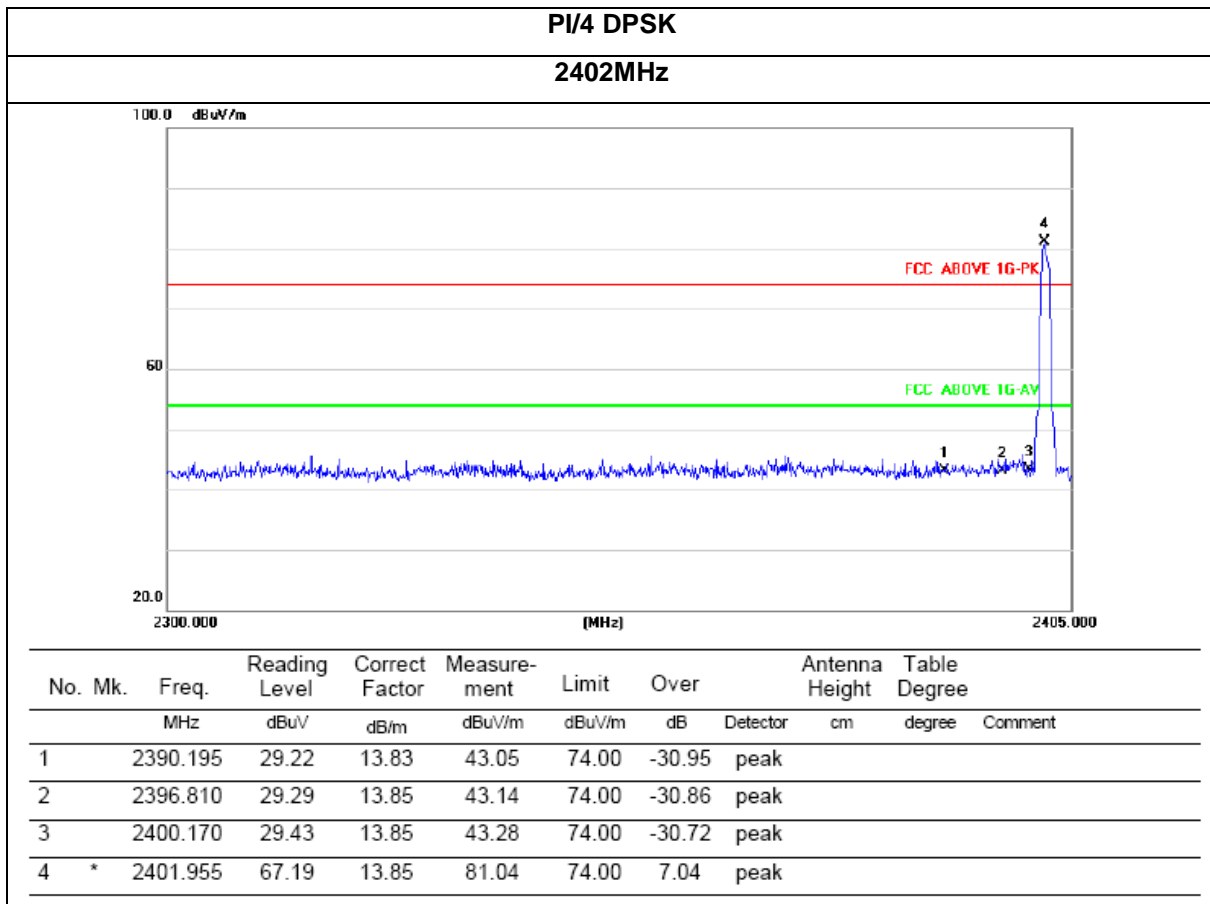
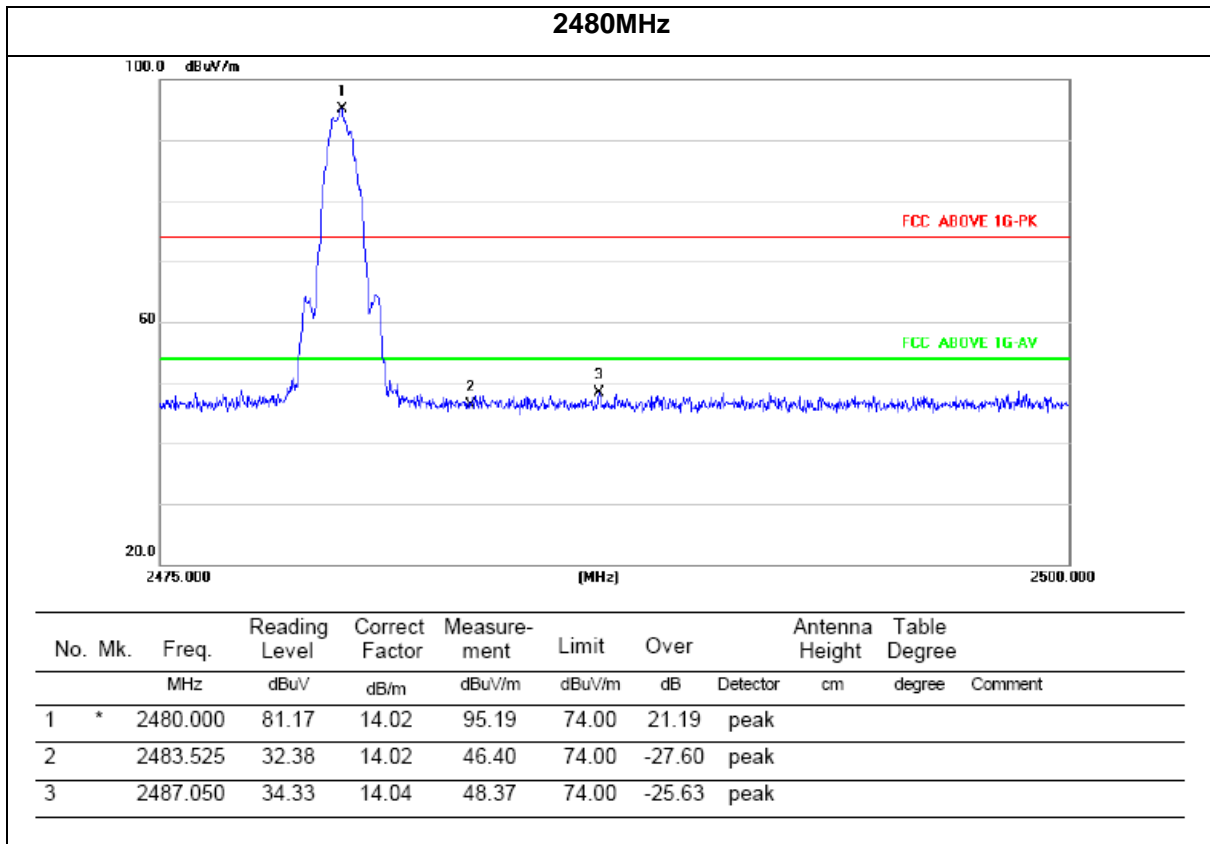

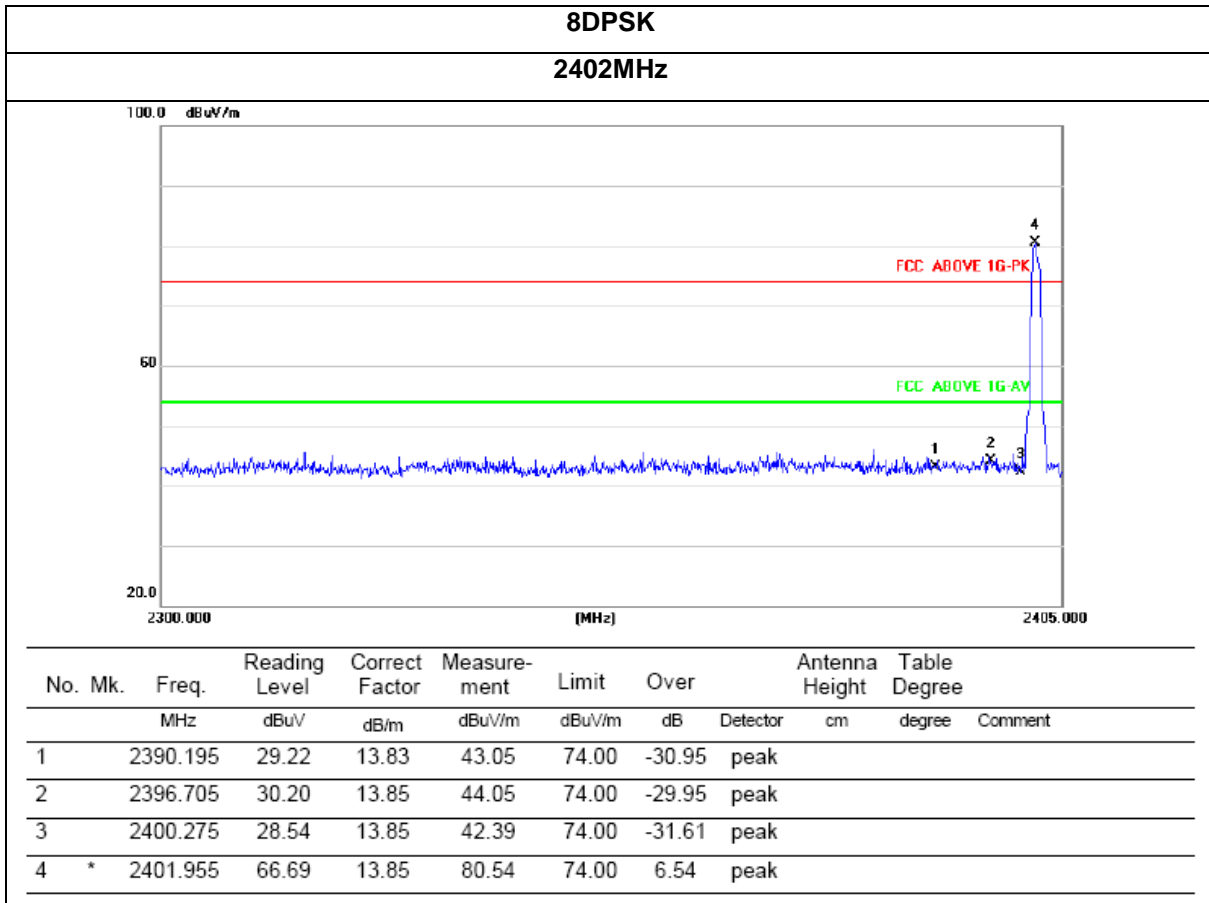
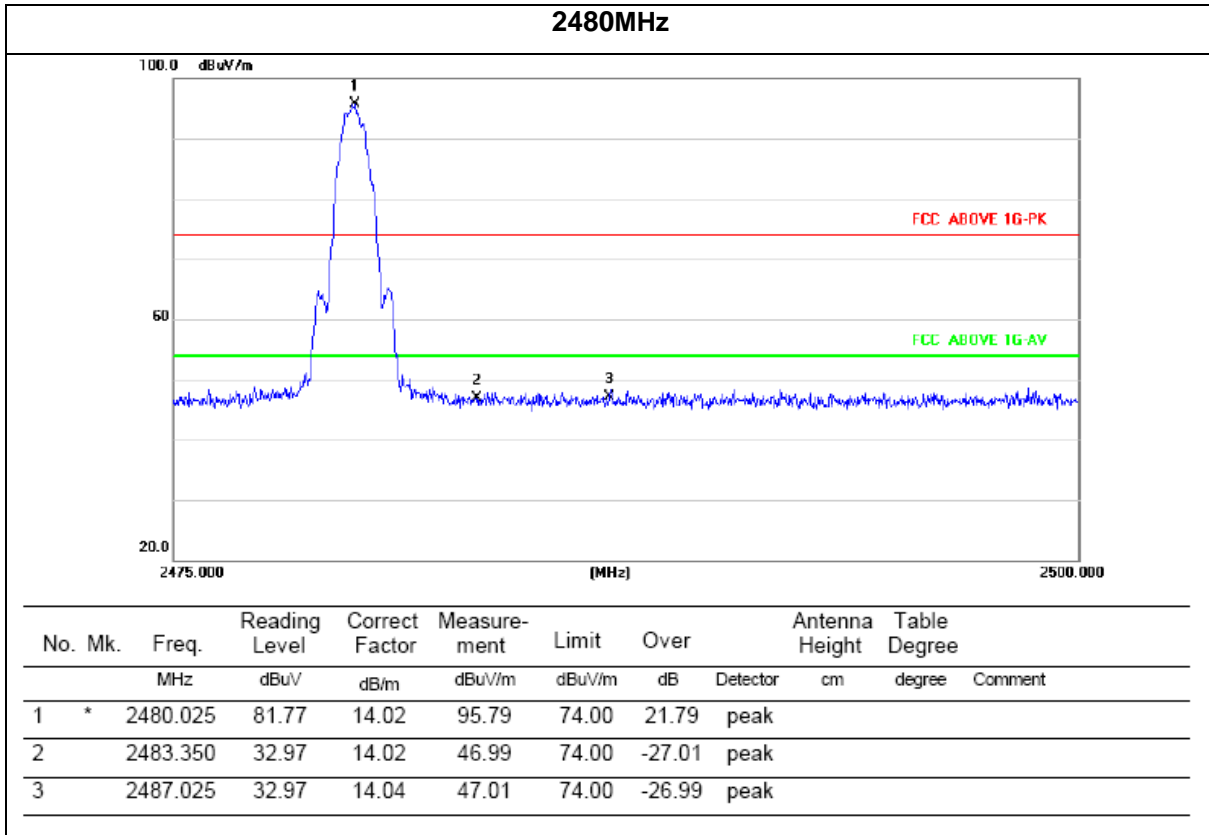

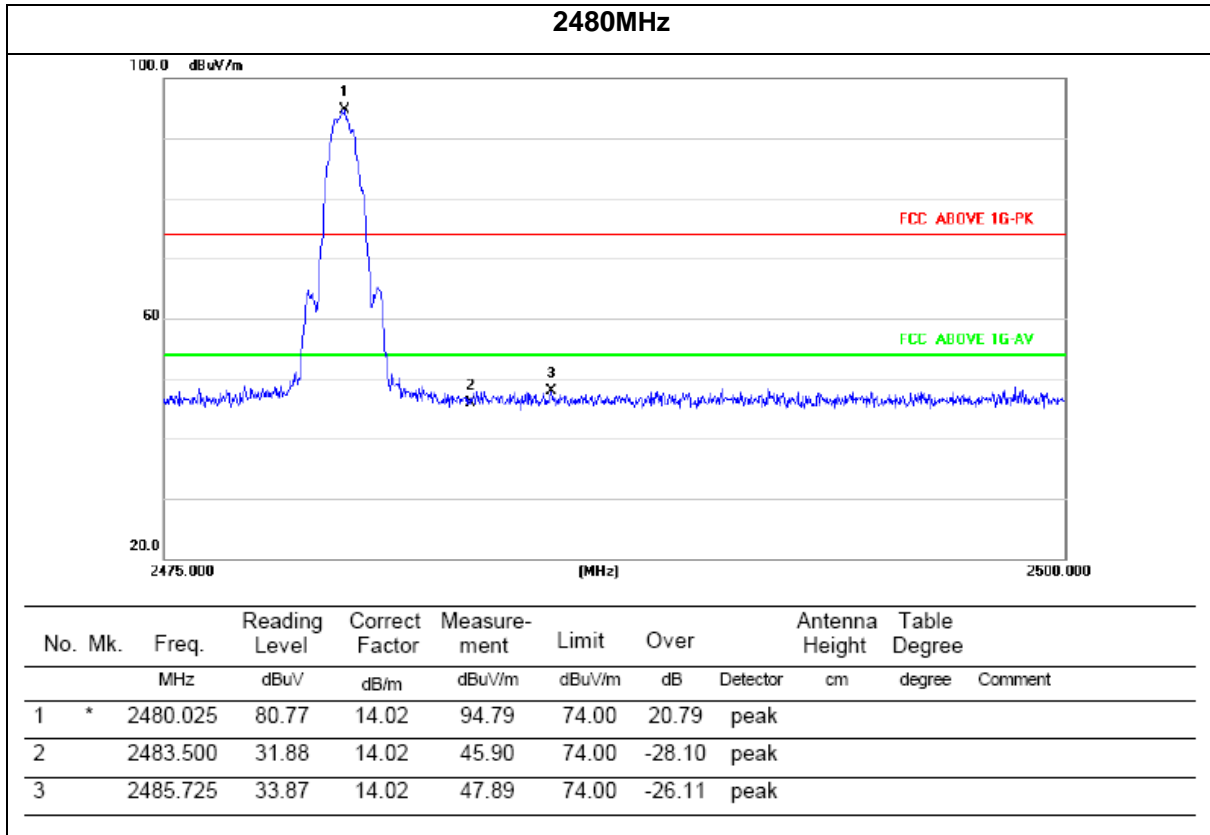

If the PK measured levels comply with average limit, then the average level were deemed to comply with average limit.



6. ANTENNA REQUIREMENT

6.1 STANDARD REQUIREMENT

15.203 requirement: For intentional device, according to 15.203: an intentional radiator shall be designed to ensure that no antenna other than that furnished by the responsible party shall be used with the device.

6.2 EUT ANTENNA

The EUT antenna is PCB antenna. It complies with the standard requirement.

7. EUT TEST PHOTO

conducted Emission





Radiated Measurement Photos

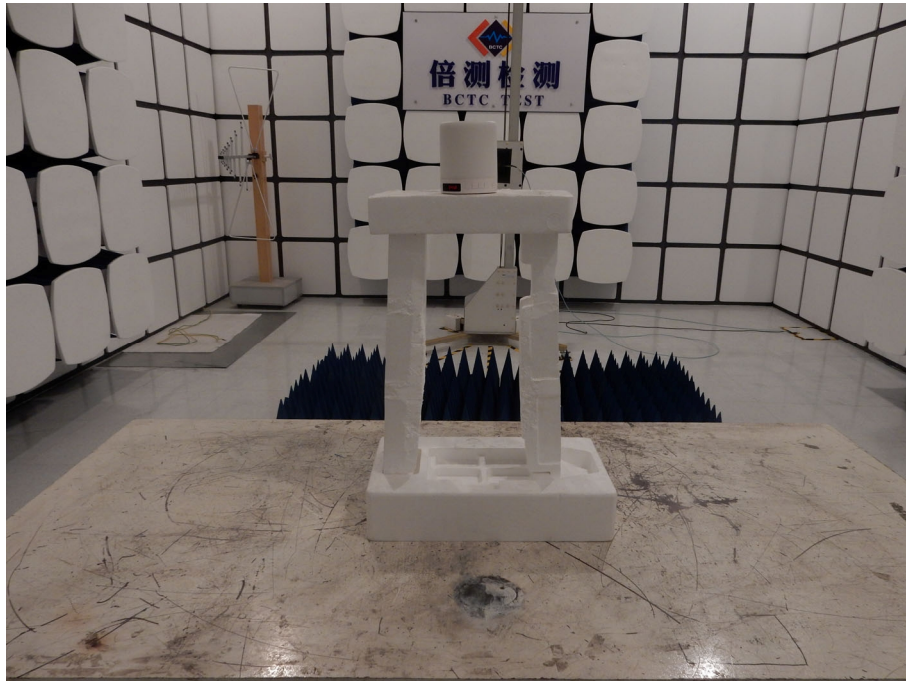
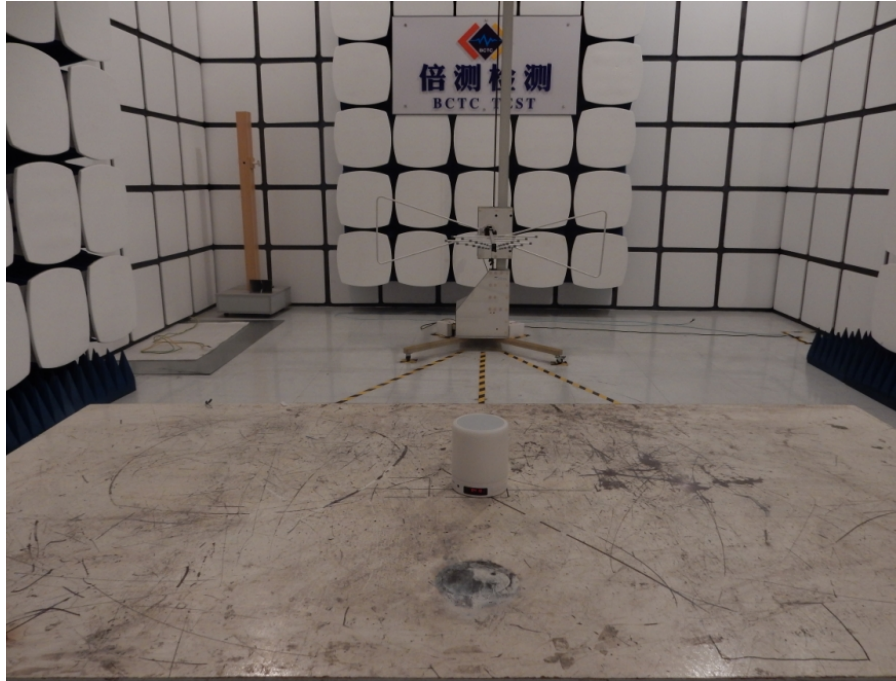



8. EUT PHOTO

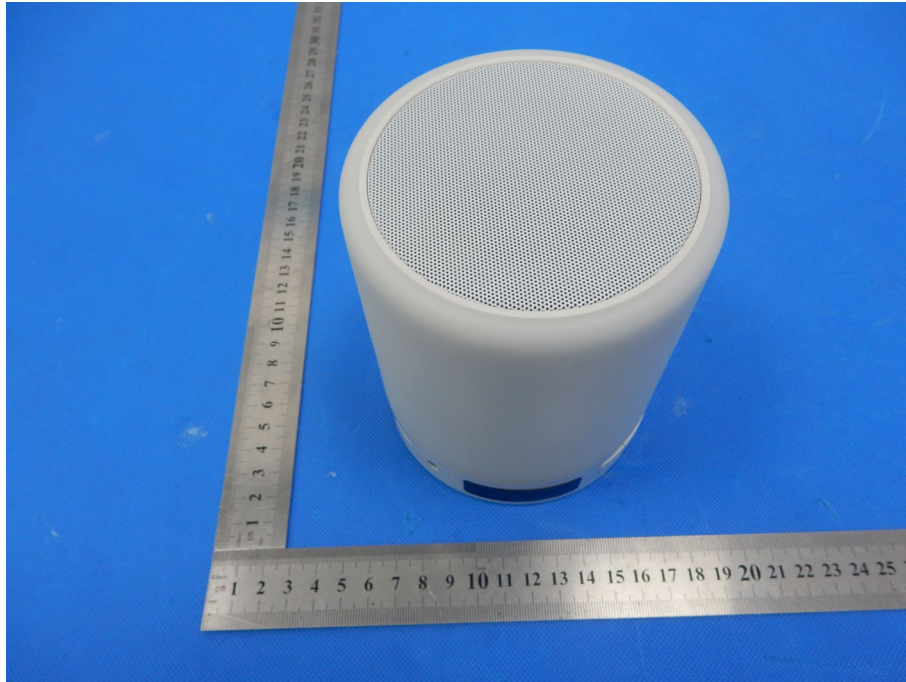

***** END OF REPORT *****