

FCC - TEST REPORT

Report Number : **68.910.22.0034.01** Date of Issue: June 6, 2022

Model : **RMT-03**

Product Type : Remote Control

Applicant : Lumi Legend Corporation

Address : 22/F., Building 1, Lisi Plaza, Huifeng East Road, Ningbo 315100, China

Production Facility : Lumi Legend Corporation

Address : 22/F., Building 1, Lisi Plaza, Huifeng East Road, Ningbo 315100, China

Test Result : **Positive** **Negative**

Total pages including Appendices : 23

Any use for advertising purposes must be granted in writing. This technical report may only be quoted in full. This report is the result of a single examination of the object in question and is not generally applicable evaluation of the quality of other products in regular production. For further details, please see testing and certification regulation, chapter A-3.4.



1 Table of Contents

- 1 Table of Contents 2
- 2 Details about the Test Laboratory 3
- 3 Description of the Equipment under Test 4
- 4 Summary of Test Standards..... 5
- 5 Summary of Test Results 6
- 6 General Remarks 7
- 7 Test Setups 8
- 8 Systems test configuration 9
- 9 Technical Requirement 10
 - 9.1 Conducted Emission..... 10
 - 9.2 Conducted peak output power 11
 - 9.3 6dB bandwidth 12
 - 9.4 Power spectral density..... 13
 - 9.5 Spurious RF conducted emissions 14
 - 9.6 Band edge 16
 - 9.7 Spurious radiated emissions for transmitter..... 17
- 10 Test Equipment List 22
- 11 System Measurement Uncertainty 23



2 Details about the Test Laboratory

Details about the Test Laboratory

Test Site 1

Company name: TÜV SÜD Certification and Testing (China) Co., Ltd. Shenzhen Branch
Building 12&13, Zhiheng Wisdomland Business Park,
Nantou Checkpoint Road 2, Nanshan District,
Shenzhen City, 518052,
P. R. China

FCC Registration Number: 514049

FCC Designation Number: CN5009

Telephone: 86 755 8828 6998
Fax: 86 755 8828 5299

3 Description of the Equipment under Test

Product:	Remote Control
Model no.:	RMT-03
FCC ID:	2AG62RMT-03
Ratings:	2 x 1.5VDC AAA batteries
RF Transmission Frequency:	2402MHz
No. of Operated Channel:	1
Modulation:	GFSK
Antenna Type:	Integral Antenna
Antenna Gain:	0dBi
Description of the EUT:	The Equipment Under Test (EUT) is a Remote Control supports 2.402GHz wireless functions.



4 Summary of Test Standards

Test Standards	
FCC Part 15 Subpart C 10-1-2020 Edition	PART 15 - RADIO FREQUENCY DEVICES Subpart C - Intentional Radiators

All the test methods were according to KDB558074 D01 DTS Meas Guidance v05r02 and ANSI C63.10 (2013).

5 Summary of Test Results

Technical Requirements				
FCC Part 15 Subpart C				
Test Condition		Pages	Test Result	Test Site
§15.207	Conducted emission AC power port	--	N/A	--
§15.247(b)(1)	Conducted AV output power for FHSS	--	N/A	--
§15.247(b)(3)	Conducted peak output power for DTS	10	Pass	Site 1
§15.247(e)	Power spectral density	13	Pass	Site 1
§15.247(a)(2)	6dB bandwidth	11	Pass	Site 1
§15.247(a)(1)	20dB Occupied bandwidth	--	N/A	--
§15.247(a)(1)	Carrier frequency separation	--	N/A	--
§15.247(a)(1)(iii)	Number of hopping frequencies	--	N/A	--
§15.247(a)(1)(iii)	Dwell Time	--	N/A	--
§15.247(d)	Spurious RF conducted emissions	14	Pass	Site 1
§15.247(d)	Band edge	16	Pass	Site 1
§15.247(d) & §15.209 & §15.205	Spurious radiated emissions for transmitter	17	Pass	Site 1
§15.203	Antenna requirement	See note 1	Pass	--

Remark 1: N/A – Not Applicable.

Note 1: The EUT uses an Integral Antenna 0dBi max. According to §15.203, it is considered sufficiently to comply with the provisions of this section.

6 General Remarks

Remarks

This submittal(s) (test report) is intended for FCC ID: 2AG62RMT-03 complies with Section 15.205, 15.209, 15.247 of the FCC Part 15, Subpart C Rules.

SUMMARY:

All tests according to the regulations cited on page 5 were

- Performed

- **Not** Performed

The Equipment under Test

- **Fulfills** the general approval requirements.

- **Does not** fulfill the general approval requirements.

Sample Received Date: May 17, 2022

Testing Start Date: May 20, 2022

Testing End Date: June 01, 2022

- TÜV SÜD Certification and Testing (China) Co., Ltd. Shenzhen Branch -

Reviewed by:

Prepared by:

Tested by:

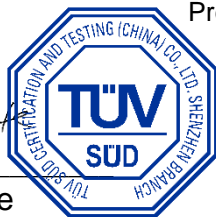
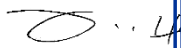

Jessie He
EMC Project Manager



Myron Yu
EMC Project Engineer



Louise Liu
EMC Test Engineer

7 Test Setups

7.1 Radiated test setups

Below 1GHz

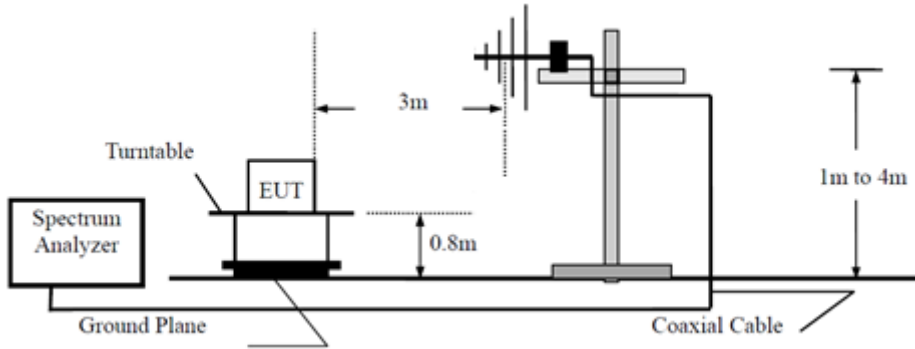

Above 1GHz

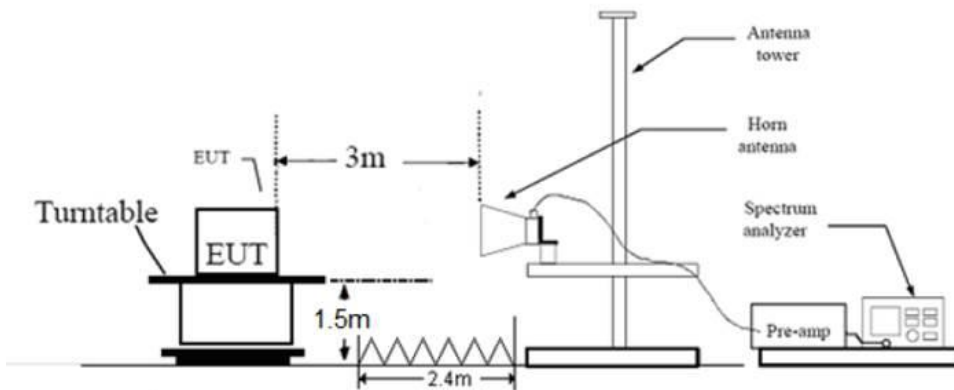

7.2 Conducted RF test setups

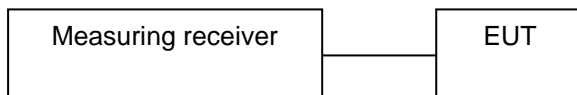

7.3 AC Power Line Conducted Emission test setups

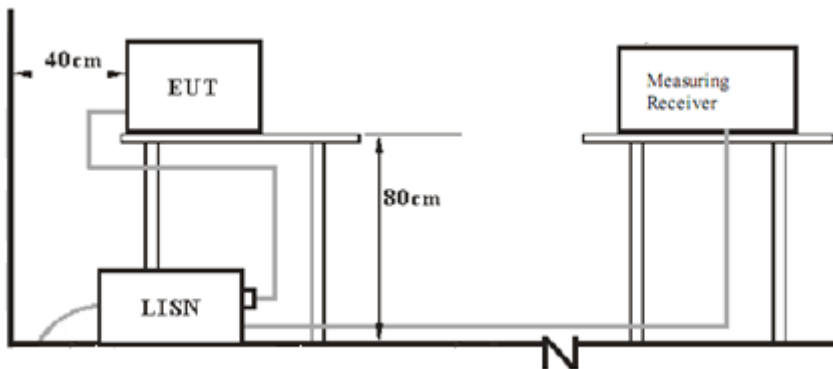

8 Systems test configuration

Auxiliary Equipment Used during Test:

Description	Manufacturer	Model no.	S/N
---	---	---	---
---	---	---	---

Test software information:

Test Software Version	EMI Test Tool	
Modulation	Setting TX Power	Packet Type
GFSK	3	---

The system was configured to channel 0 for the test.

9 Technical Requirement

9.1 Conducted Emission

Test Method

1. The EUT was placed on a table, which is 0.8m above ground plane
2. The power line of the EUT is connected to the AC mains through a Artificial Mains Network (A.M.N.).
3. Maximum procedure was performed to ensure EUT compliance
4. An EMI test receiver is used to test the emissions from both sides of AC line

Limit

Frequency MHz	QP Limit dB μ V	AV Limit dB μ V
0.150-0.500	66-56*	56-46*
0.500-5	56	46
5-30	60	50

*Decreasing line

Test Result

Not applicable

9.2 Conducted peak output power

Test Method

1. The EUT was placed on 0.8m height table, the RF output of EUT was connected to the test receiver by RF cable. The path loss was compensated to the results for each measurement.
2. Use the following spectrum analyzer settings:
RBW > the 6dB bandwidth of the emission being measured, VBW≥3RBW, Span≥3RBW
Sweep = auto, Detector function = peak, Trace = max hold.
3. Allow the trace to stabilize. Use the marker-to-peak function to set the marker to the peak of the emission. The indicated level is the peak output power.

Limits

According to §15.247 (b) (1), conducted peak output power limit as below:

Frequency Range MHz	Limit W	Limit dBm
2400-2483.5	≤1	≤30

Test Result

Frequency MHz	Conducted peak Output Power dBm	Result
2402MHz	-2.57	Pass

Test Graphs

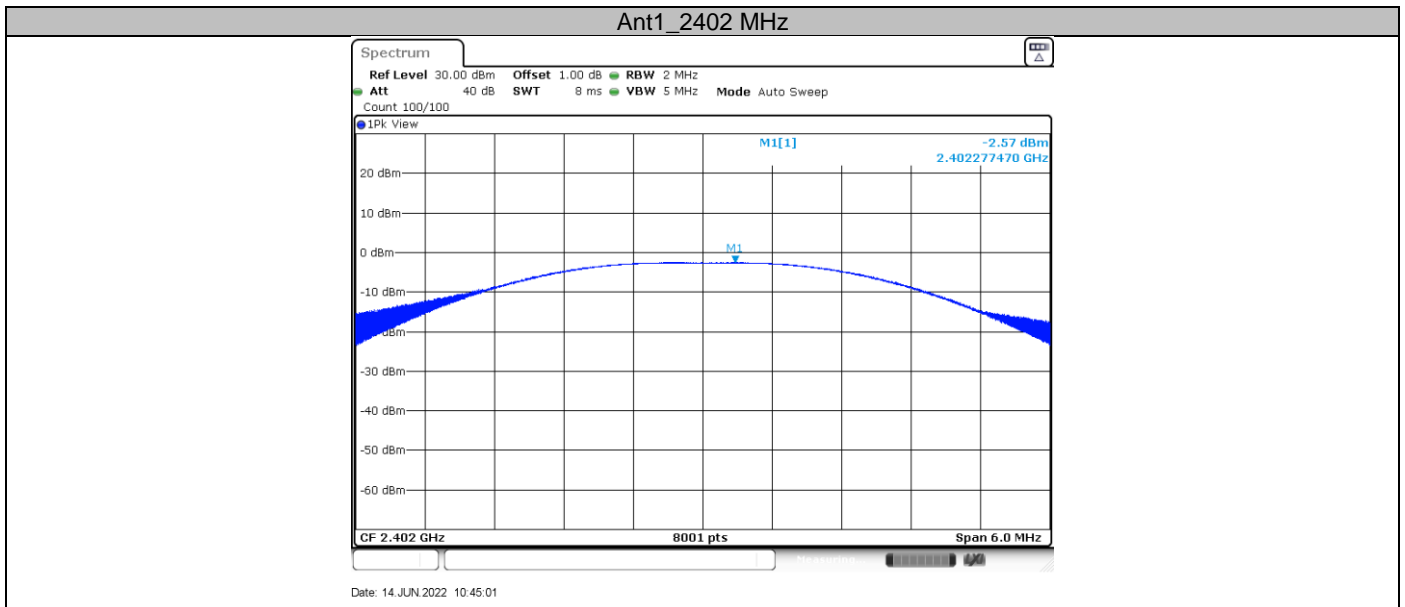

9.3 6dB bandwidth

Test Method

1. Use the following spectrum analyzer settings:
RBW=100K, VBW≥3RBW, Sweep = auto, Detector function = peak, Trace = max hold
2. Use the automatic bandwidth measurement capability of an instrument, may be employed using the X dB bandwidth mode with X set to 6 dB, care shall be taken so that the bandwidth measurement is not influenced by any intermediate power nulls in the fundamental emission that might be ≥ 6 dB.
3. Allow the trace to stabilize, record the X dB Bandwidth value.

Limit

Limit [kHz]

≥500

Test Result

Test Mode	Channel [MHz]	Result [kHz]	Limit [kHz]	Verdict
GFSK	2402	792	≥500	PASS

Test Graphs

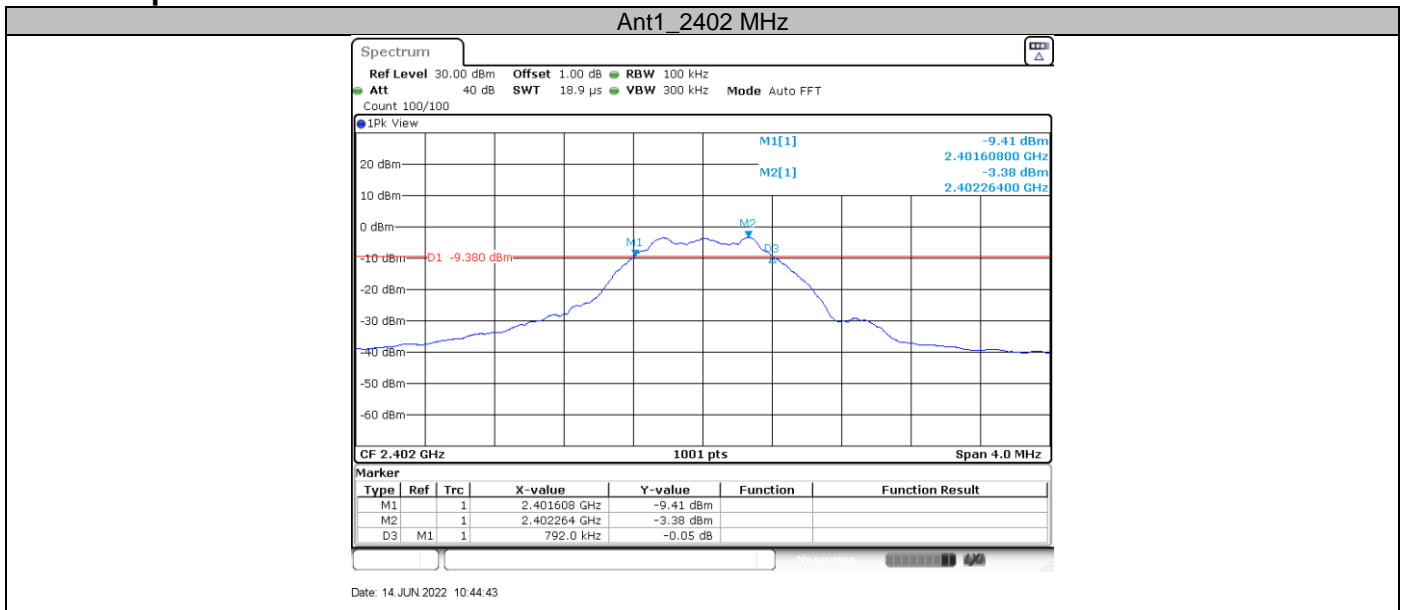

9.4 Power spectral density

Test Method

This procedure shall be used if maximum peak conducted output power was used to demonstrate compliance:

1. Set analyzer center frequency to DTS channel center frequency. RBW=3kHz, VBW≥3RBW, Span=1.5 times DTS bandwidth, Detector=Peak, Sweep=auto, Trace= max hold.
2. Allow trace to fully stabilize, use the peak marker function to determine the maximum amplitude level within the RBW.
3. Repeat above procedures until other frequencies measured were completed.

Limit

Limit [dBm/3KHz]

≤8

Test Result

Test Mode	Channel [MHz]	Result [dBm/3kHz]	Limit [dBm/3kHz]	Verdict
GFSK	2402	-18.93	8	PASS

Test Graph

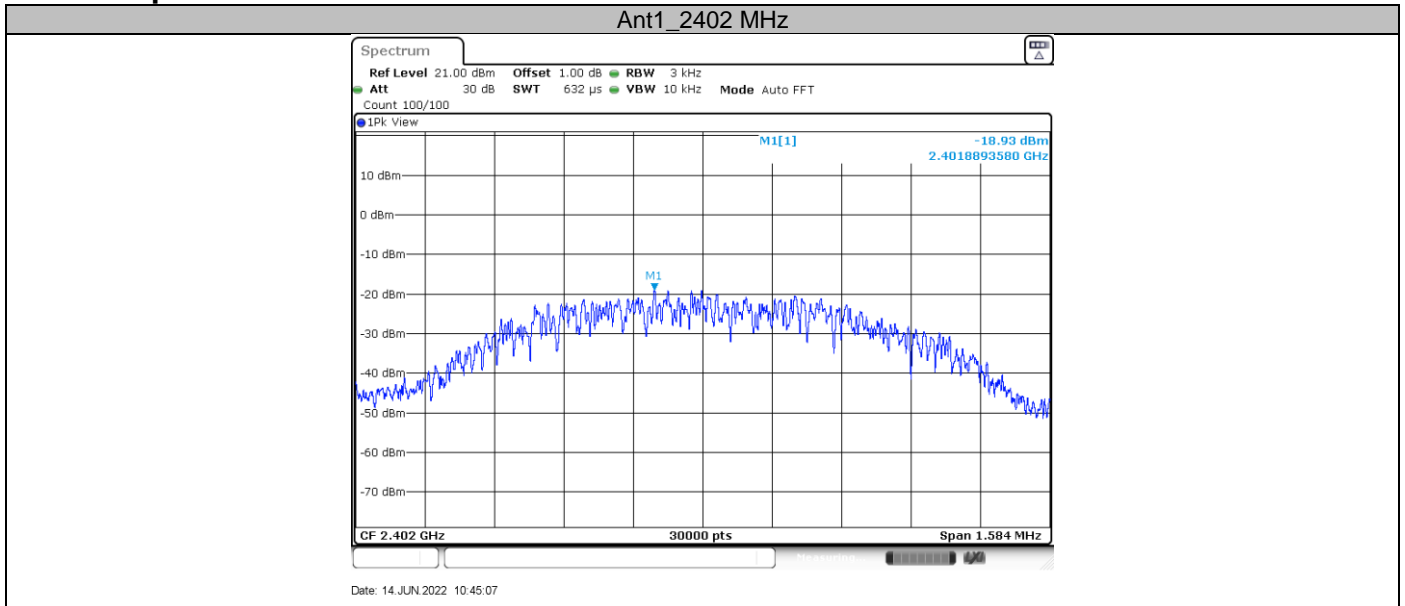

9.5 Spurious RF conducted emissions

Test Method

1. Establish a reference level by using the following procedure:
 - a. Set RBW=100 kHz. VBW \geq 3RBW. Detector =peak, Sweep time = auto couple, Trace mode = max hold.
 - b. Allow trace to fully stabilize, use the peak marker function to determine the maximum PSD level.
2. Use the maximum PSD level to establish the reference level.
 - a. Set the center frequency and span to encompass frequency range to be measured.
 - b. Use the peak marker function to determine the maximum amplitude level. Ensure that the amplitude of all unwanted emissions outside of the authorized frequency band (excluding restricted frequency bands) are attenuated by at least the minimum requirements, report the three highest emissions relative to the limit.
3. Repeat above procedures until other frequencies measured were completed.

Limit

Frequency Range MHz	Limit (dBc)
30-25000	-20

Test Result

Test Mode	Antenna	Channel [MHz]	Freq Range [MHz]	Ref Level [dBm]	Result [dBm]	Limit [dBm]	Verdict
GFSK	Ant1	2402	Reference	-3.45	-3.45	---	PASS
			30~1000	---	-55.17	\leq -23.45	PASS
			1000~26500	---	-41.21	\leq -23.45	PASS

Test Graphs

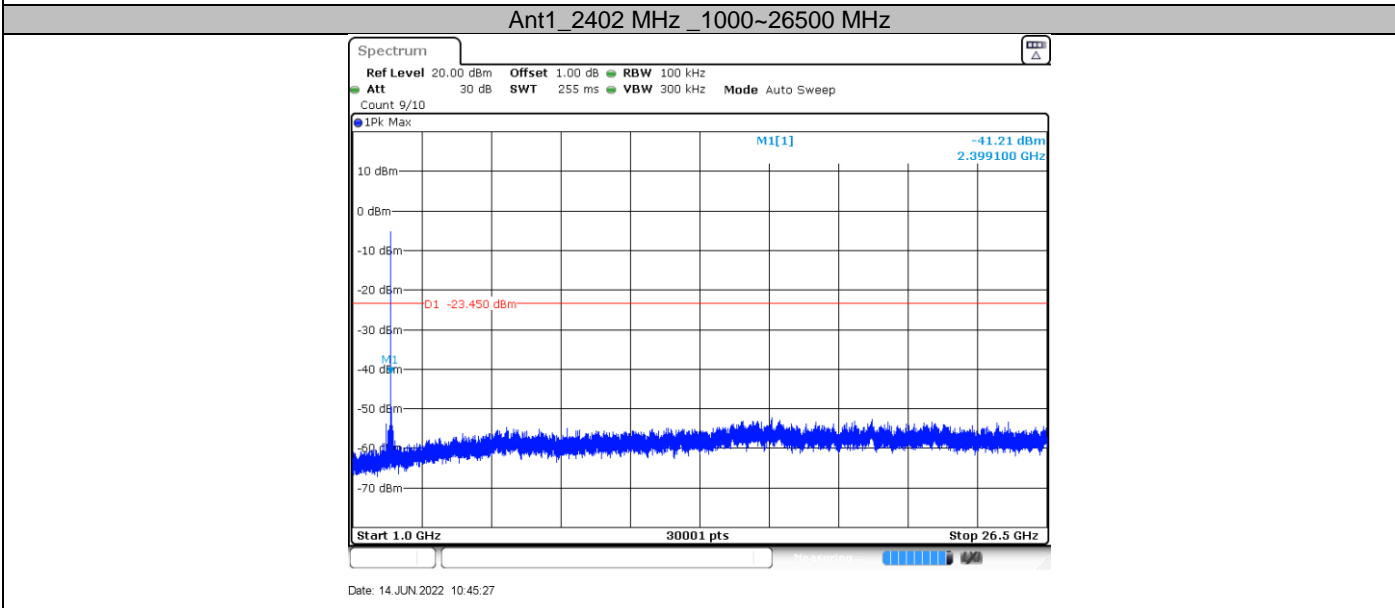
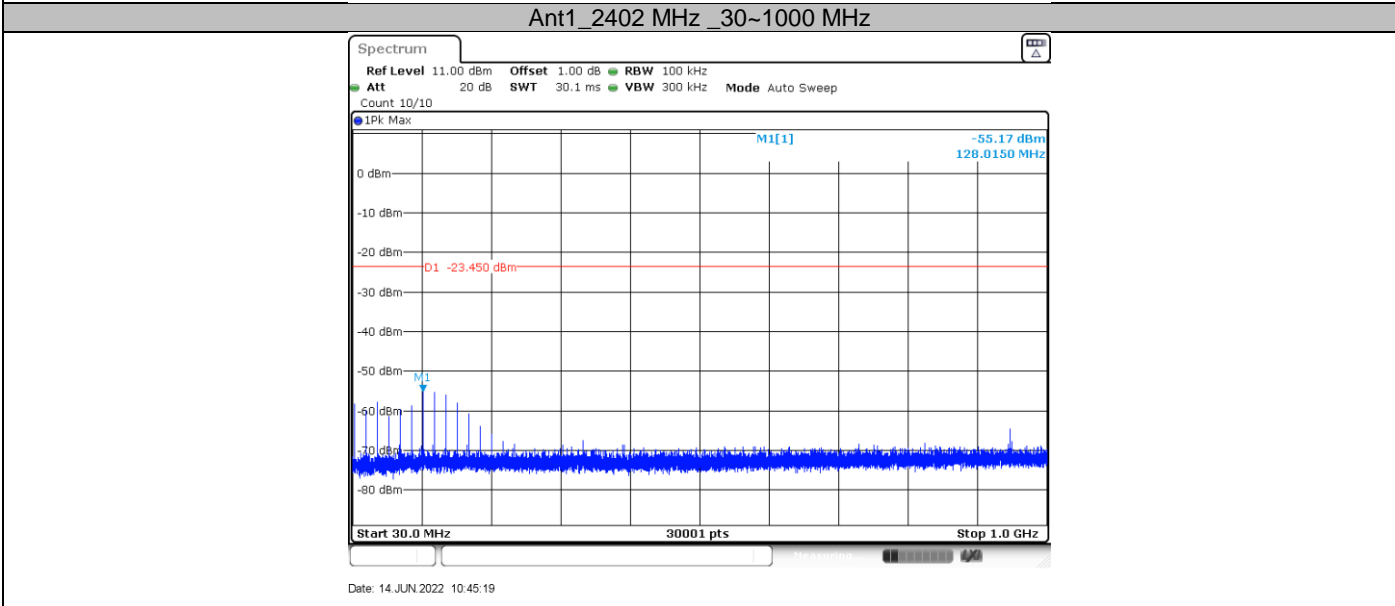
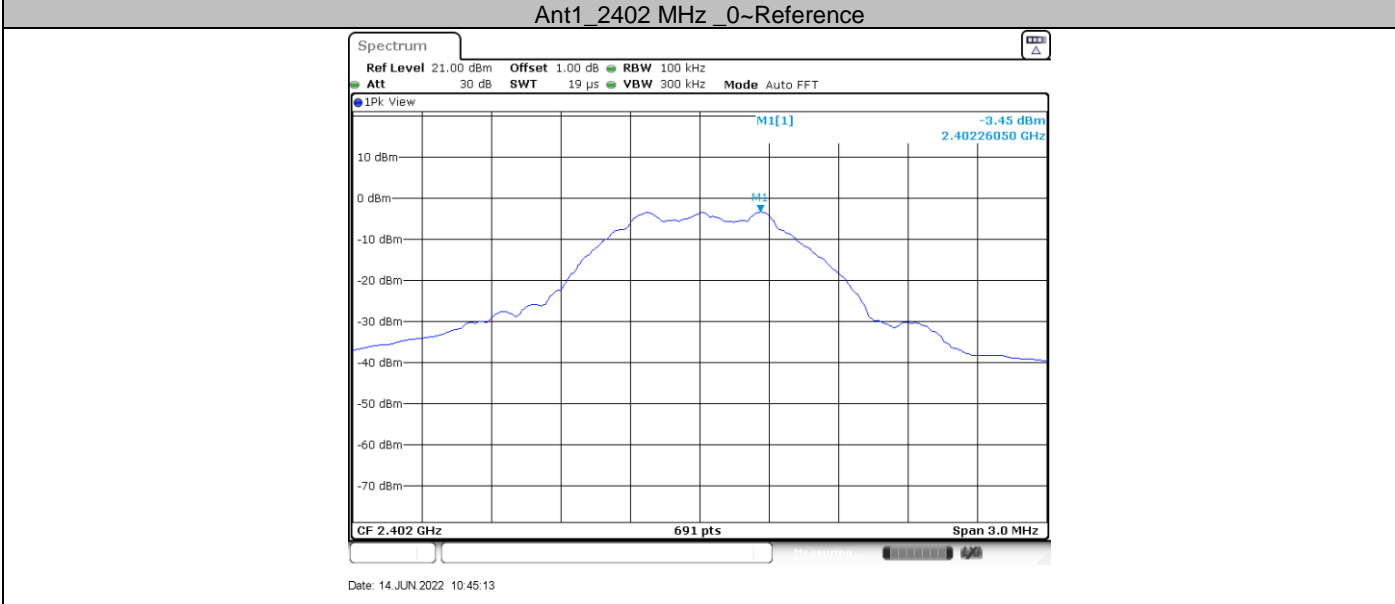

9.6 Band edge

Test Method

1. Use the following spectrum analyzer settings:
Span = wide enough to capture the peak level of the in-band emission and all spurious
RBW = 100 kHz, VBW \geq RBW, Sweep = auto, Detector function = peak, Trace = max hold.
2. Allow the trace to stabilize, use the peak and delta measurement to record the result.
3. The level displayed must comply with the limit specified in this Section.

Limit

Frequency Range	Limit (dBc)
MHz	
30-25000	-20

Test result

Test Mode	Antenna	Ch Name	Channel [MHz]	Ref Level [dBm]	Result [dBm]	Limit [dBm]	Verdict
GFSK	Ant1	Low	2402	-3.91	-43.76	≤ -23.91	PASS

Test Graphs

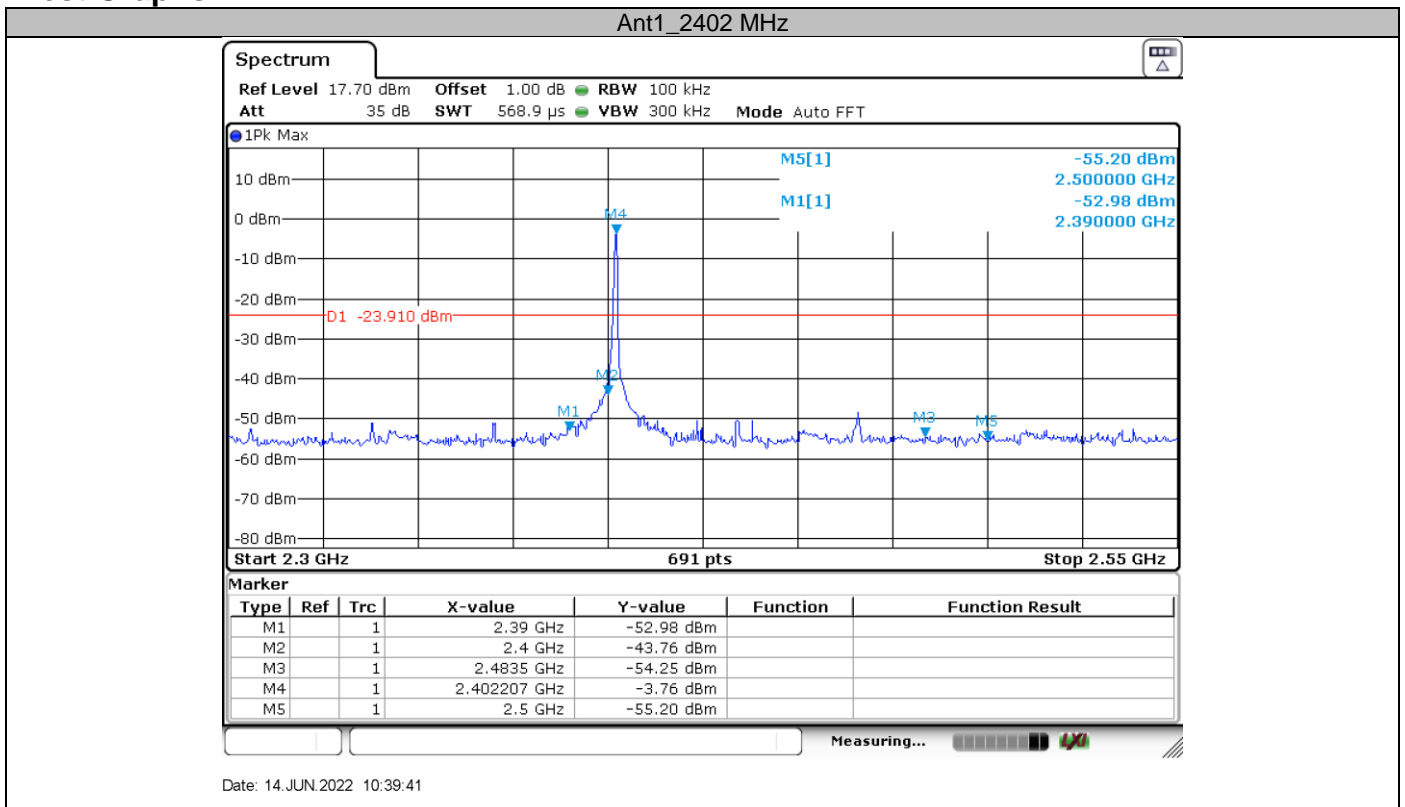

9.7 Spurious radiated emissions for transmitter

Test Method

- 1: The EUT was placed on a turn table which is 1.5m above ground plane for above 1GHz and 0.8m above ground for below 1GHz at 3 meter chamber room for test. The table was rotated 360 degrees to determine the position of the highest radiation.
- 2: The EUT was set 3 meters away from the interference – receiving antenna, which was mounted on the top of a variable – height antenna tower.
- 3: The height of antenna is varied from one meter to four meters above the ground to determine the maximum value of the field strength. Both horizontal and vertical polarizations of the antenna are set to make the measurement.
- 4: For each suspected emission, the EUT was arranged to its worst case and then the antenna was tuned to heights from 1 meter to 4 meters and the rotatable table was turned from 0 degrees to 360 degrees to find the maximum reading.
- 5: Use the following spectrum analyzer settings According to C63.10:

For Below 1GHz

Use the following spectrum analyzer settings:

Span = wide enough to capture the peak level of the in-band emission and all spurious
 RBW = 100 KHz to 120KHz, VBW ≥ RBW for peak measurement, Sweep = auto, Detector function = peak, Trace = max hold.

For Peak unwanted emissions Above 1GHz:

Span = wide enough to capture the peak level of the in-band emission and all spurious
 RBW = 1MHz, VBW ≥ RBW for peak measurement, Sweep = auto, Detector function = peak, Trace = max hold.

Procedures for average unwanted emissions measurements above 1000 MHz

- a) RBW = 1 MHz.
- b) VBW ≥ [3 × RBW].
- c) Detector = RMS (power averaging), if $[\text{span} / (\# \text{ of points in sweep})] \leq \text{RBW} / 2$. Satisfying this condition can require increasing the number of points in the sweep or reducing the span. If the condition is not satisfied, then the detector mode shall be set to peak.
- d) Averaging type = power (i.e., rms) (As an alternative, the detector and averaging type may be set for linear voltage averaging. Some instruments require linear display mode to use linear voltage averaging. Log or dB averaging shall not be used.)
- e) Sweep time = auto.
- f) Perform a trace average of at least 100 traces if the transmission is continuous. If the transmission is not continuous, then the number of traces shall be increased by a factor of $1 / D$, where D is the duty cycle. For example, with 50% duty cycle, at least 200 traces shall be averaged. (If a specific emission is demonstrated to be continuous—i.e., 100% duty cycle—then rather than turning ON and OFF with the transmit cycle, at least 100 traces shall be averaged.)
- g) If tests are performed with the EUT transmitting at a duty cycle less than 98%, then a correction factor shall be added to the measurement results prior to comparing with the emission limit, to compute the emission level that would have been measured had the test been performed at 100% duty cycle. The correction factor is computed as follows:
 - 1) If power averaging (rms) mode was used in the preceding step e), then the correction factor is $[10 \log (1 / D)]$, where D is the duty cycle. For example, if the transmit duty cycle was 50%, then 3 dB shall be added to the measured emission levels.
 - 2) If linear voltage averaging mode was used in the preceding step e), then the correction

factor is $[20 \log (1 / D)]$, where D is the duty cycle. For example, if the transmit duty cycle was 50%, then 6 dB shall be added to the measured emission levels.

3) If a specific emission is demonstrated to be continuous (100% duty cycle) rather than turning ON and OFF with the transmit cycle, then no duty cycle correction is required for that emission.

Limit

The radio emission outside the operating frequency band shall be at least 20 dB below that in the 100 kHz bandwidth within the band that contains the highest level of the desired power. Radiated emissions which fall in the restricted bands, as defined in section 15.205, must comply with the radiated emission limits specified in section 15.209.

Frequency MHz	Field Strength uV/m	Field Strength dBµV/m	Detector
30-88	100	40	QP
88-216	150	43.5	QP
216-960	200	46	QP
960-1000	500	54	QP
Above 1000	500	54	AV
Above 1000	5000	74	PK

Spurious radiated emissions for transmitter

According to C63.10, if the peak (or quasi-peak) measured value complies with the average limit, it is unnecessary to perform an average measurement, so AV emission value did not show in below table if the peak value complies with average limit.

Transmitting spurious emission test result as below:

2402MHz (30MHz – 1GHz)

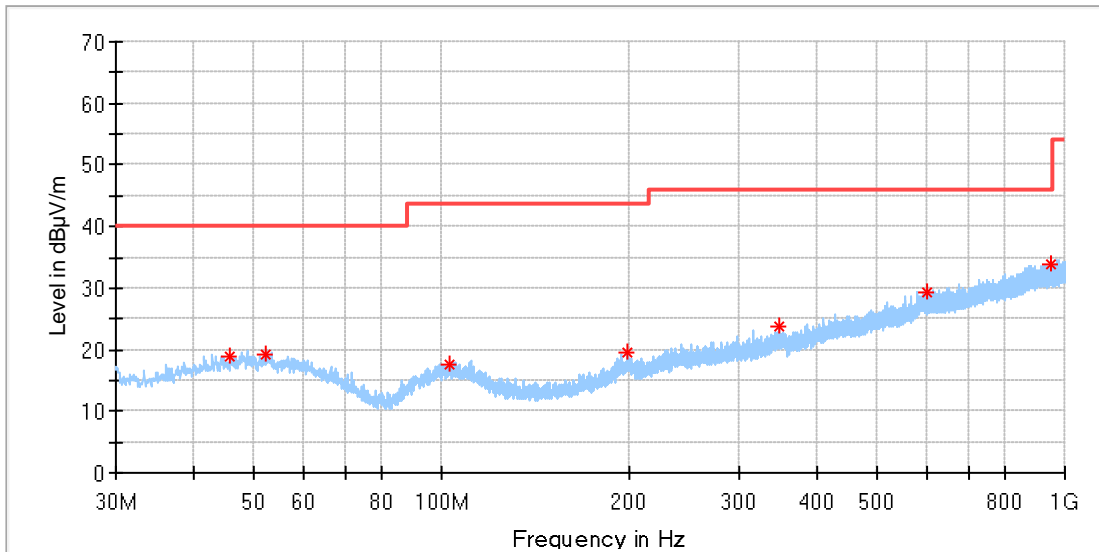

Frequency (MHz)	MaxPeak (dBµV/m)	Limit (dBµV/m)	Margin (dB)	Height (cm)	Pol	Azimuth (deg)	Corr. (dB/m)
45.823125	18.80	40.00	21.20	200.0	H	9.0	20.84
52.006875	19.37	40.00	20.63	100.0	H	96.0	20.89
102.689375	17.61	43.50	25.89	200.0	H	9.0	19.40
198.052500	19.42	43.50	24.08	200.0	H	203.0	19.63
347.008125	23.83	46.00	22.17	100.0	H	24.0	23.36
602.542500	29.24	46.00	16.76	200.0	H	341.0	28.58
952.833750	33.70	46.00	12.30	100.0	H	0.0	32.67

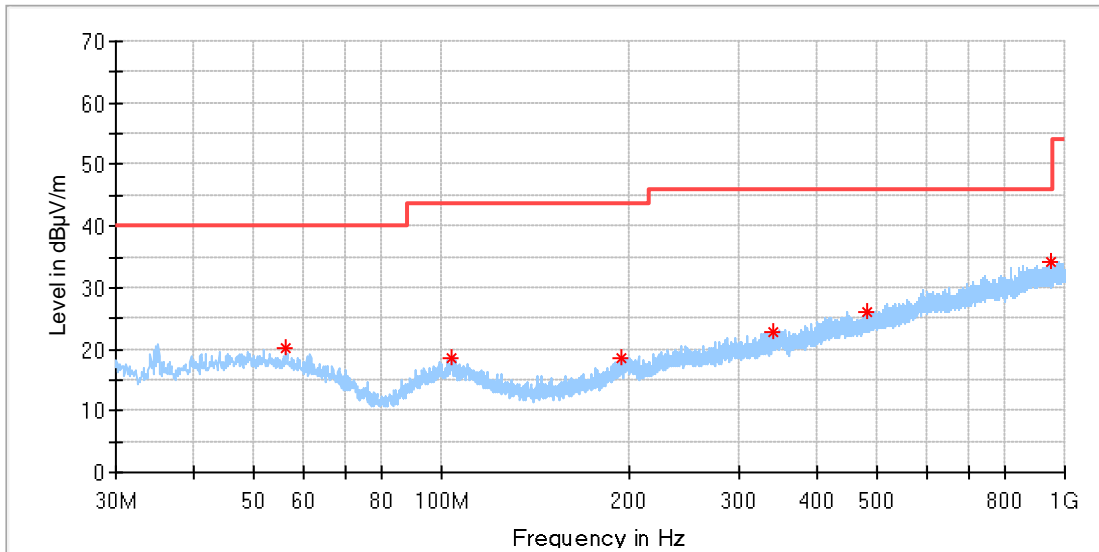

Frequency (MHz)	MaxPeak (dBµV/m)	Limit (dBµV/m)	Margin (dB)	Height (cm)	Pol	Azimuth (deg)	Corr. (dB/m)
56.311250	20.35	40.00	19.65	100.0	V	331.0	20.52
103.659375	18.41	43.50	25.09	200.0	V	77.0	19.38
194.778750	18.58	43.50	24.92	100.0	V	313.0	18.99
339.672500	22.77	46.00	23.23	200.0	V	0.0	23.01
481.413750	26.16	46.00	19.84	100.0	V	0.0	25.75
946.468125	34.10	46.00	11.90	200.0	V	0.0	32.74

2402MHz (Above 1GHz)

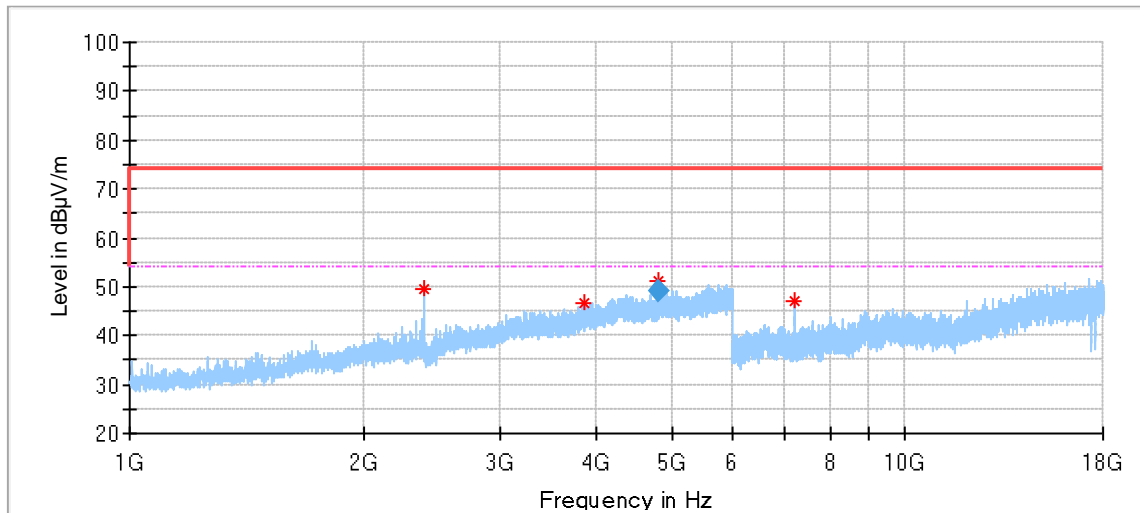

Frequency (MHz)	MaxPeak (dBµV/m)	Limit (dBµV/m)	Margin (dB)	Height (cm)	Pol	Azimuth (deg)	Corr. (dB/m)
2392.500000	49.68	74.00	24.32	150.0	H	5.0	-5.61
3851.500000	46.82	74.00	27.18	150.0	H	318.0	1.03
4804.500000	51.31	74.00	22.69	150.0	H	318.0	3.80
7205.500000	46.99	74.00	27.01	150.0	H	315.0	8.83

Final Result

Frequency (MHz)	Average (dBµV/m)	Limit (dBµV/m)	Margin (dB)	Height (cm)	Pol	Azimuth (deg)	Corr. (dB/m)
4804.500000	48.93	54.00	5.07	150.0	H	318.0	3.80

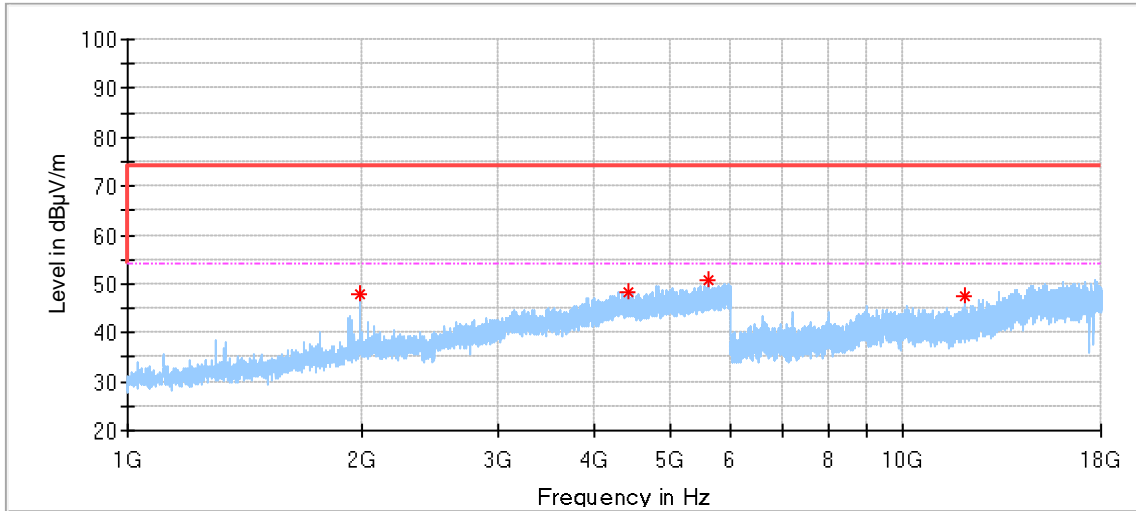

Frequency (MHz)	MaxPeak (dBµV/m)	Limit (dBµV/m)	Margin (dB)	Height (cm)	Pol	Azimuth (deg)	Corr. (dB/m)
1993.000000	48.05	74.00	25.95	150.0	V	116.0	-6.54
4417.500000	48.48	74.00	25.52	150.0	V	69.0	3.37
5595.500000	50.82	74.00	23.18	150.0	V	16.0	6.02
12009.000000	47.40	74.00	26.60	150.0	V	197.0	13.82

Remark:

- (1) "*" means the emission(s) appear within the restrict bands shall follow the requirement of section 15.205.
- (2) Data of measurement within frequency range 18-26GHz are the noise floor or attenuated more than 20dB below the permissible limits or the field strength is too small to be measured, so test data does not present in this report.
- (3) Level=Reading Level + Correction Factor
 Above 1GHz: Corrector factor = Antenna Factor + Cable Loss- Amplifier Gain
 Below 1GHz: Corrector factor = Antenna Factor + Cable Loss
 (The Reading Level is recorded by software which is not shown in the sheet)

10 Test Equipment List

Radiated Emission 2# Test

DESCRIPTION	MANUFACTURER	MODEL NO.	EQUIPMENT ID	SERIAL NO.	CAL INTERVAL (YEAR)	CAL. DUE DATE
EMI Test Receiver	Rohde & Schwarz	ESR 26	68-4-74-14-002	101269	1	2023-5-28
Trilog Super Broadband Test Antenna	Schwarzbeck	VULB 9162	68-4-80-19-003	284	1	2023-1-17
Wave Guide Antenna	ETS	3117	68-4-80-19-001	00218954	1	2023-5-9
Pre-amplifier	Rohde & Schwarz	SCU 18F	68-4-29-19-001	100745	1	2023-5-28
Pre-amplifier	Rohde & Schwarz	SCU 18F	68-4-29-19-002	100746	1	2023-5-28
Sideband Horn Antenna	Q-PAR	QWH-SL-18-40-K-SG	68-4-80-14-008	12827	1	2022-7-21
Pre-amplifier	Rohde & Schwarz	SCU 40A	68-4-29-14-002	100432	1	2022-7-27
Attenuator	Mini-circuits	UNAT-6+	68-4-81-21-002	15542	1	2023-5-27
3m Semi-anechoic chamber	TDK	SAC-3 #2	68-4-90-19-006	----	2	2023-5-28
Test software	Rohde & Schwarz	EMC32	68-4-90-19-006-A01	Version10.35.02	N/A	N/A
EMI Test Receiver	Rohde & Schwarz	ESR 26	68-4-74-14-002	101269	1	2023-5-28

RF Conducted Test

DESCRIPTION	MANUFACTURER	MODEL NO.	EQUIPMENT ID	SERIAL NO.	CAL INTERVAL (YEAR)	CAL. DUE DATE
Signal Generator	Rohde & Schwarz	SMB100A	68-4-48-14-001	108272	1	2023-5-27
Vector Signal Generator	Rohde & Schwarz	SMBV100A	68-4-48-18-001	262825	1	2023-5-27
Communication Synthetical Test Instrument	Rohde & Schwarz	CMW 270	68-4-48-18-003	101251	1	2023-5-27
Signal Analyzer	Rohde & Schwarz	FSV40	68-4-74-14-004	101030	1	2023-5-27
Vector Signal Generator	Rohde & Schwarz	SMU 200A	68-4-48-14-003	105324	1	2023-5-27
RF Switch Module	Rohde & Schwarz	OSP120/OSP-B157	68-4-93-14-003	101226/100851	1	2023-5-27
Power Splitter	Weinschel	1580	68-4-85-14-001	SC319	1	2023-5-28
10dB Attenuator	Weinschel	4M-10	68-4-81-14-003	43152	1	2023-5-28
10dB Attenuator	R&S	DNF	68-4-81-14-004	DNF-001	1	2023-5-27
10dB Attenuator	R&S	DNF	68-4-81-14-005	DNF-002	1	2023-5-27
10dB Attenuator	R&S	DNF	68-4-81-14-006	DNF-003	1	2023-5-27
10dB Attenuator	R&S	DNF	68-4-81-14-007	DNF-004	1	2023-5-27
Test software	Rohde & Schwarz	EMC32	68-4-48-14-003-A10	Version 10.60.10	N/A	N/A
Test software	Tonscend	System for BT/WIFI	68-4-74-14-006-A13	Version 2.6.77.0518	N/A	N/A
Shielding Room	TDK	TS8997	68-4-90-19-003	----	3	2022-11-07

11 System Measurement Uncertainty

For a 95% confidence level, the measurement expanded uncertainties for defined systems, in accordance with the recommendations of ISO 17025 were:

System Measurement Uncertainty

System Measurement Uncertainty	
Items	Extended Uncertainty
Uncertainty for Radiated Spurious Emission 25MHz-3000MHz	Horizontal: 4.35dB; Vertical: 4.44dB;
Uncertainty for Radiated Spurious Emission 3000MHz-18000MHz	Horizontal: 4.30dB; Vertical: 4.29dB;
Uncertainty for Radiated Spurious Emission 18000MHz-40000MHz	Horizontal: 4.51dB; Vertical: 4.50dB;
Uncertainty for Conducted RF test with TS 8997	RF Power Conducted: 1.31dB Frequency test involved: 0.6×10^{-7} or 1%
Uncertainty for Conducted Emission in new shielding room (68-4-90-19-005) 150kHz-30MHz (for test using AMN ENV216)	3.20dB

Measurement Uncertainty Decision Rule

Determination of conformity with the specification limits is based on the decision rule according to IEC Guide 115: 2007, clause 4.4.3 and 4.5.1.