

FCC Radio Test Report

FCC ID: 2AG5OPB-711-B

Report No. : BTL-FCCP-3-2007T023B
Equipment : Pebblebee Found
Model Name : PB-711-B
Brand Name : Found
Applicant : PB Inc.
Address : PO Box 2962 Renton Washington United States 98056

Radio Function : LTE Cat-M1 Band 4, 12

FCC Rule Part(s) : 47 CFR FCC Part 27 Subpart L
47 CFR FCC Part 27 Subpart H
47 CFR FCC Part 2
ANSI/TIA/EIA-603-E-2016
KDB 971168 D01 Power Meas License Digital Systems v03r01

Measurement Procedure(s) : ANSI C63.10-2013

Date of Receipt : 2020/7/9
2021/11/10

Date of Test : 2020/7/9 ~ 2020/7/29
2021/11/10 ~ 2021/12/8

Issued Date : 2021/12/29

The above equipment has been tested and found in compliance with the requirement of the above standards by BTL Inc.

Prepared by : Eric Lee
Eric Lee, Engineer

Approved by : Jerry Chuang
Jerry Chuang, Supervisor

**BTL Inc.**

No.18, Ln. 171, Sec. 2, Jiuzong Rd., Neihu Dist., Taipei City 114, Taiwan

Tel: +886-2-2657-3299

Fax: +886-2-2657-3331

Web: www.newbtl.com

Declaration

BTL represents to the client that testing is done in accordance with standard procedures as applicable and that test instruments used has been calibrated with standards traceable to international standard(s) and/or national standard(s).

BTL's reports apply only to the specific samples tested under conditions. It is manufacture's responsibility to ensure that additional production units of this model are manufactured with the identical electrical and mechanical components. **BTL** shall have no liability for any declarations, inferences or generalizations drawn by the client or others from **BTL** issued reports.

This report is the confidential property of the client. As a mutual protection to the clients, the public and ourselves, the test report shall not be reproduced, except in full, without our written approval.

BTL's laboratory quality assurance procedures are in compliance with the **ISO/IEC 17025** requirements, and accredited by the conformity assessment authorities listed in this test report.

BTL is not responsible for the sampling stage, so the results only apply to the sample as received.

The information, data and test plan are provided by manufacturer which may affect the validity of results, so it is manufacturer's responsibility to ensure that the apparatus meets the essential requirements of applied standards and in all the possible configurations as representative of its intended use.

Limitation

For the use of the authority's logo is limited unless the Test Standard(s)/Scope(s)/Item(s) mentioned in this test report is (are) included in the conformity assessment authorities acceptance respective.

Please note that the measurement uncertainty is provided for informational purpose only and are not use in determining the Pass/Fail results.

Table of Contents	Page
REVISION HISTORY	6
1 . SUMMARY OF TEST RESULTS	7
1.1 TEST FACILITY	8
1.2 MEASUREMENT UNCERTAINTY	8
1.3 TEST ENVIRONMENT CONDITIONS	8
2 . GENERAL INFORMATION	9
2.1 GENERAL DESCRIPTION OF EUT	9
2.2 DESCRIPTION OF TEST MODES	11
2.3 BLOCK DIGRAM SHOWING THECONFIGURATIONOFSYSTEMTESTED	12
2.4 DESCRIPTION OF SUPPORT UNITS	12
3 . AC POWER LINE CONDUCTED EMISSIONS TEST	13
3.1 LIMIT	13
3.2 TEST PROCEDURE	13
3.3 DEVIATION FROM TEST STANDARD	13
3.4 TEST SETUP	14
3.5 TEST RESULT	14
4 . OUTPUT POWER MEASUREMENT	15
4.1 LIMIT	15
4.2 TEST PROCEDURES	15
4.3 TEST SETUP LAYOUT	15
4.4 TEST DEVIATION	15
4.5 TEST RESULTS	15
5 . OCCUPIED BANDWIDTH MEASUREMENT	16
5.1 TEST PROCEDURES	16
5.2 TEST SETUP LAYOUT	16
5.3 TEST DEVIATION	16
5.4 TEST RESULTS	16
6 . CONDUCTED SPURIOUS EMISSIONS MEASUREMENT	17
6.1 LIMIT	17
6.2 TEST PROCEDURES	17
6.3 TEST SETUP LAYOUT	17
6.4 TEST DEVIATION	17

Table of Contents	Page
6.5 TEST RESULTS	17
7 . RADIATED SPURIOUS EMISSIONS MEASUREMENT	18
7.1 LIMIT	18
7.2 TEST PROCEDURES	18
7.3 TEST SETUP LAYOUT	18
7.4 TEST RESULTS (30MHZ TO 1000MHZ)	19
7.5 TEST RESULTS (ABOVE 1000MHZ)	19
8 . BAND EDGE MEASUREMENT	20
8.1 LIMIT	20
8.2 TEST PROCEDURES	20
8.3 TEST SETUP LAYOUT	20
8.4 TEST DEVIATION	20
8.5 TEST RESULTS	20
9 . PEAK TO AVERAGE RATIO MEASUREMENT	21
9.1 LIMIT	21
9.2 TEST PROCEDURES	21
9.3 TEST SETUP LAYOUT	21
9.4 TEST DEVIATION	21
9.5 TEST RESULTS	21
10 . FREQUENCY STABILITY MEASUREMENT	22
10.1 LIMIT	22
10.2 TEST PROCEDURES	22
10.3 TEST SETUP LAYOUT	22
10.4 TEST DEVIATION	22
10.5 TEST RESULTS	22
11 . LIST OF MEASUREMENT EQUIPMENTS	23
12 . EUT TEST PHOTOS	25
13 . EUT PHOTOS	25
APPENDIX A - AC POWER LINE CONDUCTED EMISSIONS	26
APPENDIX B - RADIATED POWER	31
APPENDIX C - OCCUPIED BANDWIDTH	36
APPENDIX D - CONDUCTED SPURIOUS EMISSIONS	49
APPENDIX E - RADIATED SPURIOUS EMISSIONS (30MHZ TO 1GHZ)	56

Table of Contents	Page
APPENDIX F - RADIATED SPURIOUS EMISSIONS (ABOVE 1GHZ)	65
APPENDIX G - BAND EDGE	74
APPENDIX H - PEAK TO AVERAGE RATIO	81
APPENDIX I - FREQUENCY STABILITY	88

REVISION HISTORY

Report No.	Version	Description	Issued Date
BTL-FCCP-3-2007T023	R00	Original Report.	2020/9/7
BTL-FCCP-3-2007T023	R01	Revised report to address TCB's comments.	2020/9/14
BTL-FCCP-3-2007T023	R02	Revised report to address TCB's comments.	2020/9/18
BTL-FCCP-3-2007T023B	R00	Change bluetooth chip and battery.	2021/12/16
BTL-FCCP-3-2007T023B	R01	Change model name.	2021/12/29

1. SUMMARY OF TEST RESULTS

Test procedures according to the technical standard(s):

Standard(s) Section	Test Item	Judgment	Remark
15.207	AC Power Line Conducted Emissions	PASS	-----
2.1046 27.50(d)(4) 27.50(c)(10)	Effective Radiated Power & Equivalent Isotropic Radiated Power	PASS	-----
2.1049	Occupied Bandwidth	PASS	-----
2.1051 27.53(h) 27.53(g) 27.53(c)(2)(4)	Conducted Spurious Emissions	PASS	-----
2.1053 27.53(h) 27.53(g) 27.53(c)(2)(4)	Radiated Spurious Emissions	PASS	-----
2.1051 27.53(h) 27.53(g) 27.53(c)(2)(4)	Band Edge Measurements	PASS	-----
-	Peak To Average Ratio	PASS	Record Only
2.1055 27.54	Frequency Stability	PASS	-----

Note:

- (1) "N/A" denotes test is not applicable in this test report.
- (2) The report format version is TP.1.1.1

1.1 TEST FACILITY

The test facilities used to collect the test data in this report:

No. 68-1, Ln. 169, Sec. 2, Datong Rd., Xizhi Dist., New Taipei City 221, Taiwan
 The test sites and facilities are covered under FCC RN: 674415 and DN: TW0659.

C05 CB08 CB11 CB15 CB16
 SR06

1.2 MEASUREMENT UNCERTAINTY

The reported uncertainty of measurement $y \pm U$, where expanded uncertainty U is based on a standard uncertainty multiplied by a coverage factor of $k = 2$, providing a level of confidence of approximately **95 %**. The measurement instrumentation uncertainty considerations contained in CISPR 16-4-2. The BTL measurement uncertainty is less than the CISPR 16-4-2 U_{cispr} requirement.

A. AC power line conducted emissions test:

Test Site	Method	Measurement Frequency Range	U (dB)
C05	CISPR	150 kHz ~ 30MHz	3.44

B. Radiated emissions test :

Test Site	Measurement Frequency Range	U,(dB)
CB15	0.03 GHz ~ 0.2 GHz	4.17
	0.2 GHz ~ 1 GHz	4.72
	1 GHz ~ 6 GHz	5.21
	6 GHz ~ 18 GHz	5.51
	18 GHz ~ 26 GHz	3.69
	26 GHz ~ 40 GHz	4.23

NOTE:

Unless specifically mentioned, the uncertainty of measurement has not been taken into account to declare the compliance or non-compliance to the specification.

1.3 TEST ENVIRONMENT CONDITIONS

Test Item	Environment Condition	Test Voltage	Tested by
AC Power Line Conducted Emissions	24 °C, 57 %	AC 120V/60Hz	William Wei
Output Power	24.3 °C, 42 %	DC 5V	Paul Shen
ERP & EIRP	24.3 °C, 42 %	DC 5V	Paul Shen
Occupied Bandwidth	24.3 °C, 45 %	DC 5V	William Wei
Conducted Spurious Emissions	24.3 °C, 45 %	DC 5V	William Wei
Radiated Spurious Emissions	20 °C, 65 %	DC 5V	Eddie Lee
Band Edge	24.3 °C, 45 %	DC 5V	William Wei
Peak to Average Ratio	24.3 °C, 45 %	DC 5V	William Wei
Frequency Stability	Normal and Extreme		William Wei

2. GENERAL INFORMATION

2.1 GENERAL DESCRIPTION OF EUT

Equipment	Pebblebee Found
Model Name	PB-711-B
Brand Name	Found
Model Difference	N/A
Power Source	#1 DC Voltage supplied from USB port. #2 Battery supplied
Power Rating	#1 DC 5V 1A #2 3.7V, 770mAh 2.849Wh
Products Covered	Rechargeable Li-ion polymer battery / LIP603033
Hardware Version	PB_GO_DVT
Software Version	Firmware Ver: N.3.1.7
Test Model	PB-711-B
Sample Status	Engineering Sample
EUT Modification(s)	N/A
Modulation Type	UL: QPSK,16QAM DL: QPSK,16QAM
Maximum EIRP Power	Band 4: 14.82 dBm (0.0303 W)
Maximum ERP Power	Band 12: 13.42 dBm (0.0220 W)

Note:

- For a more detailed features description, please refer to the manufacturer's specifications or the user's manual.
- Channel List:

LTE Cat-M1 Band 4					
Test Frequency ID	Bandwidth (MHz)	N _{UL}	Frequency of Uplink (MHz)	N _{DL}	Frequency of Downlink (MHz)
Low Range	5	19975	1712.5	1975	2112.5
	10	20000	1715	2000	2115
	15	20025	1717.5	2025	2117.5
	20	20050	1720	2050	2120
Mid Range	5/10/15/20	20175	1732.5	2175	2132.5
High Range	5	20375	1752.5	2375	2152.5
	10	20350	1750	2350	2150
	15	20325	1747.5	2325	2147.5
	20	20300	1745	2300	2145

LTE Cat-M1 Band 12					
Test Frequency ID	Bandwidth (MHz)	N _{UL}	Frequency of Uplink (MHz)	N _{DL}	Frequency of Downlink (MHz)
Low Range	5	23035	701.5	5035	731.5
	10	23060	704	5060	734
Mid Range	5/10	23095	707.5	5095	737.5
High Range	5	23155	713.5	5155	743.5
	10	23130	711	5130	741

3. In this report, the test results of below items refer to BTL-FCCP-3-2007T023 report due to the device is identical to the original device of the referencing report, except change bluetooth chip and battery.

- a. Effective Radiated Power & Equivalent Isotropic Radiated Power
- b. Occupied Bandwidth
- c. Conducted Spurious Emissions
- d. Radiated Spurious Emissions
- e. Band Edge Measurements
- f. Peak To Average Ratio
- g. Frequency Stability

Spot checks are applied to below items:

- a. AC Power Line Conducted Emissions
- b. Effective Radiated Power & Equivalent Isotropic Radiated Power
- c. Radiated Spurious Emissions

2.2 DESCRIPTION OF TEST MODES

Following mode(s) is (were) found to be the worst case(s) and selected for the final test.

Test Items	Band	Test Mode	Note
AC Power Line Conducted Emissions	-	Normal/Idle	-

LTE BAND 4 MODE					
Test Item	Available Channel	Tested Channel	Channel Bandwidth	Modulation	Mode
Output Power	19975 to 20375	19975, 20175, 20375	5MHz	QPSK, 16QAM	1RB/6RB
	20000 to 20350	20000, 20175, 20350	10MHz	QPSK, 16QAM	1RB/6RB
	20025 to 20325	20025, 20175, 20325	15MHz	QPSK, 16QAM	1RB/6RB
	20050 to 20300	20050, 20175, 20300	20MHz	QPSK, 16QAM	1RB/6RB
Occupied Bandwidth	19975 to 20375	19975, 20175, 20375	5MHz	QPSK, 16QAM	1RB/6RB
	20000 to 20350	20000, 20175, 20350	10MHz	QPSK, 16QAM	1RB/6RB
	20025 to 20325	20025, 20175, 20325	15MHz	QPSK, 16QAM	1RB/6RB
	20050 to 20300	20050, 20175, 20300	20MHz	QPSK, 16QAM	1RB/6RB
Conducted Spurious Emissions	19975 to 20375	20175	5MHz	QPSK	1RB
	20000 to 20350	20175	10MHz	QPSK	1RB
	20025 to 20325	20175	15MHz	QPSK	1RB
	20050 to 20300	20175	20MHz	QPSK	1RB
Radiated Spurious Emissions	Cat-M1				
Band Edge	19975 to 20375	19975, 20375	5MHz	QPSK	1RB/6RB
	20000 to 20350	20000, 20350	10MHz	QPSK	1RB/6RB
	20025 to 20325	20025, 20325	15MHz	QPSK	1RB/6RB
	20050 to 20300	20050, 20300	20MHz	QPSK	1RB/6RB
Peak To Average Ratio	19975 to 20375	19975, 20175, 20375	5MHz	QPSK, 16QAM	1RB
	20000 to 20350	20000, 20175, 20350	10MHz	QPSK, 16QAM	1RB
	20025 to 20325	20025, 20175, 20325	15MHz	QPSK, 16QAM	1RB
	20050 to 20300	20050, 20175, 20300	20MHz	QPSK, 16QAM	1RB
Frequency Stability	5MHz				
	10MHz				
	15MHz				
	20MHz				

LTE BAND 12 MODE					
Test Item	Available Channel	Tested Channel	Channel Bandwidth	Modulation	Mode
Output Power	23035 to 23155	23035, 23095, 23155	5MHz	QPSK, 16QAM	1RB/6RB
	23060 to 23130	23060, 23095, 23130	10MHz	QPSK, 16QAM	1RB/6RB
Occupied Bandwidth	23035 to 23155	23035, 23095, 23155	5MHz	QPSK, 16QAM	1RB/6RB
	23060 to 23130	23060, 23095, 23130	10MHz	QPSK, 16QAM	1RB/6RB
Conducted Spurious Emissions	23035 to 23155	23095	5MHz	QPSK	1RB
	23060 to 23130	23095	10MHz	QPSK	1RB
Radiated Spurious Emissions	Cat-M1				
Band Edge	23035 to 23155	23035, 23155	5MHz	QPSK, 16QAM	1RB/6RB
	23060 to 23130	23060, 23130	10MHz	QPSK, 16QAM	1RB/6RB
Peak To Average Ratio	23035 to 23155	23035, 23095, 23155	5MHz	QPSK, 16QAM	1RB/6RB
	23060 to 23130	23060, 23095, 23130	10MHz	QPSK, 16QAM	1RB/6RB
Frequency Stability	5MHz				
	10MHz				

2.3 BLOCK DIGRAM SHOWING THE CONFIGURATION OF SYSTEM TESTED

AC Power Line Conducted Emissions

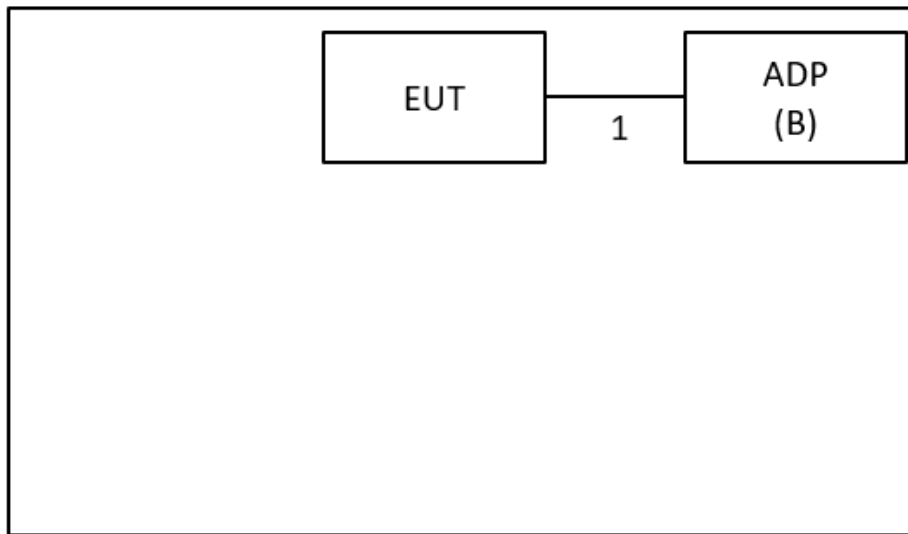

Radiated Emissions

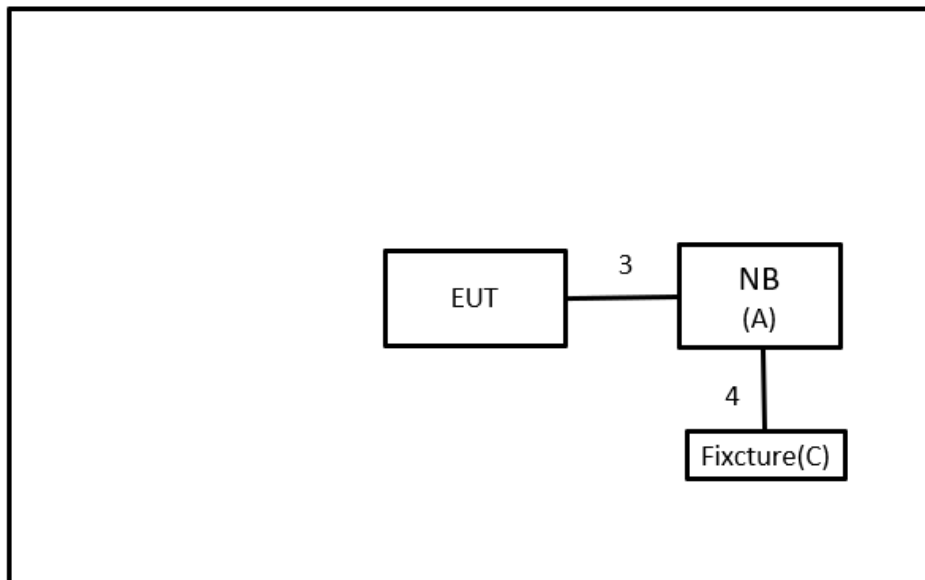

2.4 DESCRIPTION OF SUPPORT UNITS

The EUT has been tested as an independent unit together with other necessary accessories or support units. The following support units or accessories were used to form a representative test configuration during the tests.

Item	Equipment	Brand	Model No.	Series No.	Remarks
A	NB	HP	TPN-I119	NA	Furnished by test lab.
B	Adapter	Apple	A1385	NA	Furnished by test lab.
C	Fixture	ESPRESSIF	ESP-WROOM-32 D	NA	Supplied by test requester

Item	Cable Type	Shielded	Ferrite Core	Length	Remarks
1	USB Cable	NA	NA	0.15m	Supplied by test requester
3	USB Cable	NA	NA	0.8m	Supplied by test requester
4	USB Cable	NA	NA	0.15m	Supplied by test requester

3. AC POWER LINE CONDUCTED EMISSIONS TEST

3.1 LIMIT

Frequency (MHz)	Limit (dB μ V)	
	Quasi-peak	Average
0.15 - 0.5	66 - 56 *	56 - 46 *
0.50 - 5.0	56	46
5.0 - 30.0	60	50

NOTE:

- (1) The tighter limit applies at the band edges.
- (2) The limit of " * " marked band means the limitation decreases linearly with the logarithm of the frequency in the range.
- (3) The test result calculated as following:
 Measurement Value = Reading Level + Correct Factor
 Correct Factor = Insertion Loss + Cable Loss + Attenuator Factor (if use)
 Margin Level = Measurement Value – Limit Value

Calculation example:

Reading Level		Correct Factor		Measurement Value
38.22	+	3.45	=	41.67

Measurement Value		Limit Value		Margin Level
41.67	-	60	=	-18.33

The following table is the setting of the receiver.

Receiver Parameter	Setting
Attenuation	10 dB
Start Frequency	0.15 MHz
Stop Frequency	30 MHz
IF Bandwidth	9 KHz

3.2 TEST PROCEDURE

- a. The EUT was placed 0.8 m above the horizontal ground plane with the EUT being connected to the power mains through a line impedance stabilization network (LISN).
 All other support equipment were powered from an additional LISN(s).
 The LISN provides 50 Ohm/50uH of impedance for the measuring instrument.
- b. Interconnecting cables that hang closer than 40 cm to the ground plane shall be folded back and forth in the center forming a bundle to keep the cable above 40 cm.
- c. Excess I/O cables that are not connected to a peripheral shall be bundled in the center.
 The end of the cable will be terminated, using the correct terminating impedance.
 The overall length shall not exceed 1 m.
- d. The LISN is spaced at least 80 cm from the nearest part of the EUT chassis.
- e. For the actual test configuration, please refer to the related Item - 錯誤! 找不到參照來源。 .

NOTE:

- (1) In the results, each reading is marked as Peak, QP or AVG per the detector used.
 BW=9 kHz (6 dB Bandwidth)
- (2) All readings are Peak unless otherwise stated QP or AVG in column of Note. Both the QP and the AVG readings must be less than the limit for compliance.

3.3 DEVIATION FROM TEST STANDARD

No deviation.

3.4 TEST SETUP

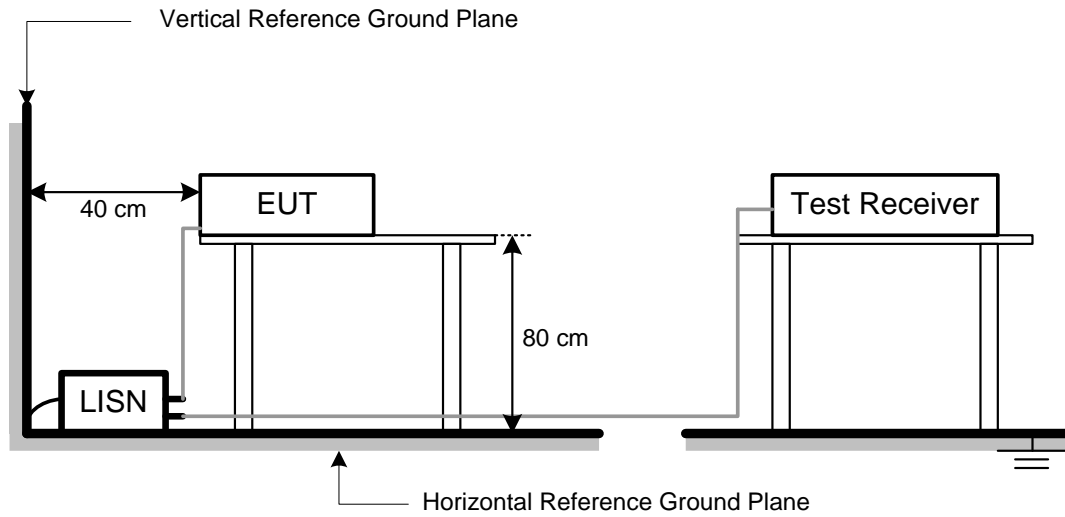

3.5 TEST RESULT

Please refer to the APPENDIX A.

4. OUTPUT POWER MEASUREMENT

4.1 LIMIT

Mobile / Portable station are limited to 1 watts e.i.r.p. (Part 27 Subpart L)

Mobile / Portable station are limited to 3 watts e.r.p. (Part 27 Subpart H)

4.2 TEST PROCEDURES

1. Substitution method is used for E.I.R.P measurement. In the semi-anechoic chamber, EUT placed on the 0.8m height of Turn Table, rotated the table around 360 degrees to search the maximum radiation power and receiver antenna shall be rotated vertical and horizontal polarization and moved height from 1m to 4m to find the maximum polar radiated power. The "Read Value" is the spectrum reading the maximum power value.
2. The substitution horn antenna is substituted for EUT at the same position and signals generator export the CW signal to the substitution antenna via a TX cable. Rotated the Turn Table and moved receiving antenna to find the maximum radiation power. Adjust output power level of S.G to get a Value of spectrum reading equal to "Read Value " of step a. Record the power level of S.G
3. $EIRP = \text{Output power level of S.G} - \text{TX cable loss} + \text{Antenna gain of substitution horn}.$
4. E.R.P power can be calculated form E.I.R.P power by subtracting the gain of dipole, $E.R.P \text{ power} = E.I.R.P \text{ power} - 2.15\text{dBi}.$
5. The resolution bandwidth and video bandwidth of test receiver/spectrum analyzer is 1MHz/3MHz.

4.3 TEST SETUP LAYOUT

Radiated Power Measurement

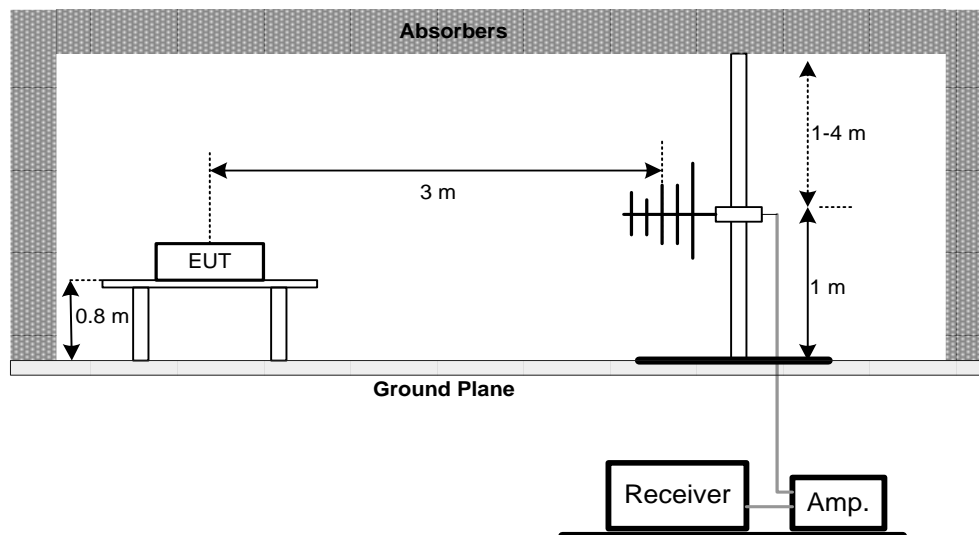

4.4 TEST DEVIATION

No deviation

4.5 TEST RESULTS

Please refer to the APPENDIX B.

5. OCCUPIED BANDWIDTH MEASUREMENT

5.1 TEST PROCEDURES

The testing follows FCC KDB 971168 v03r01 Section 4.

1. The EUT makes a call to the communication simulator. All measurements were done at low, middle and high operational frequency range. The communication simulator station system controlled a EUT to export maximum output power under transmission mode and specific channel frequency. Use OBW measurement function of Spectrum analyzer to measure 99 % occupied bandwidth and 26dB bandwidth.
2. The EUT was connected to spectrum analyzer and system simulator via a power divider.
3. $RBW=(1\% \sim 5\%)*EBW$
 $VBW \geq 3* RBW$
4. Set spectrum analyzer with Peak detector.

5.2 TEST SETUP LAYOUT

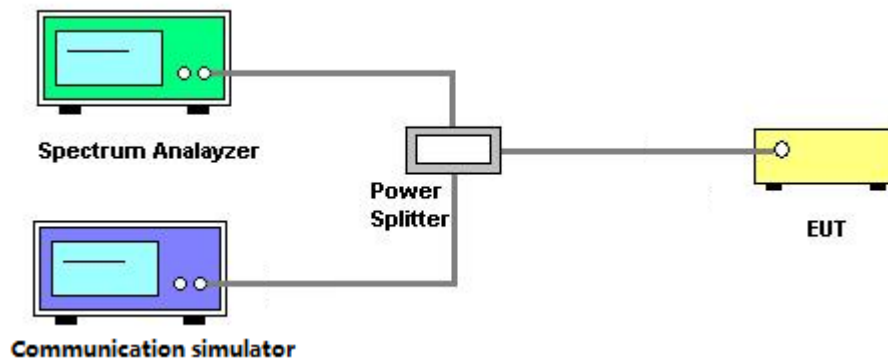

5.3 TEST DEVIATION

No deviation

5.4 TEST RESULTS

Please refer to the APPENDIX C.

6. CONDUCTED SPURIOUS EMISSIONS MEASUREMENT

6.1 LIMIT

The power of any emission outside of the authorized operating frequency ranges must be attenuated below the transmitting power (P) by a factor of at least $43 + 10 \log(P)$ dB. The emission limit equal to -13dBm. (Part 27 Subpart L & H)

6.2 TEST PROCEDURES

The testing follows FCC KDB 971168 v03r01 Section 6.

1. The EUT was connected to spectrum analyzer and system simulator via a power divider.
2. The band edges of low and high channels for the highest RF powers were measured. Set RBW \geq 1% EBW in the 1MHz band immediately outside and adjacent to the band edge.
3. Set spectrum analyzer with Peak detector.
4. The RF fundamental frequency should be excluded against the limit line in the operating frequency band.

6.3 TEST SETUP LAYOUT

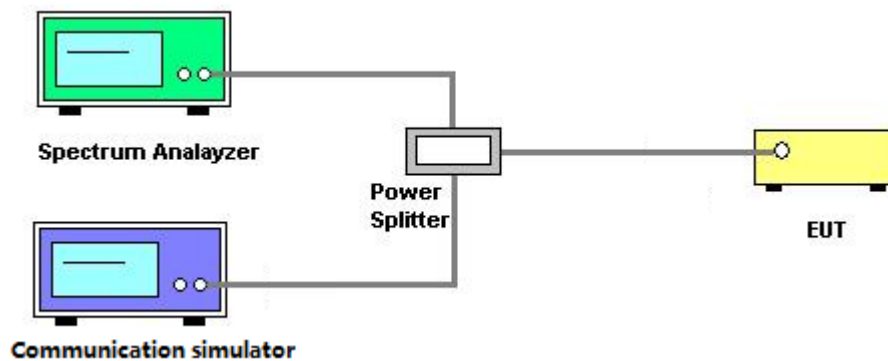

6.4 TEST DEVIATION

No deviation

6.5 TEST RESULTS

Please refer to the APPENDIX D.

7. RADIATED SPURIOUS EMISSIONS MEASUREMENT

7.1 LIMIT

The power of any emission outside of the authorized operating frequency ranges must be attenuated below the transmitting power (P) by a factor of at least $43 + 10 \log(P)$ dB. The emission limit equal to -13dBm. (Part 27 Subpart L & H)

7.2 TEST PROCEDURES

The testing follows FCC KDB 971168 v03r01 Section 6.2.

1. In the semi-anechoic chamber, EUT placed on the 0.8m height of Turn Table, rotated the table around 360 degrees to search the maximum radiation power and receiver antenna shall be rotated vertical and horizontal polarization and moved height from 1m to 4m to find the maximum polar radiated power. The "Read Value" is the spectrum reading the maximum power value.
2. The substitution horn antenna is substituted for EUT at the the same position and signals generator export the CW signal to the substitution antenna via a TX cable. Rotated the Turn Table and moved receiving antenna to find the maximum radiation power. Adjust output power level of S.G to get a Value of spectrum reading equal to "Read Value " of step a. Record the power level of S.G
3. $EIRP = \text{Output power level of S.G} - \text{TX cable loss} + \text{Antenna gain of substitution horn.}$
4. ERP can be calculated form EIRP by subtracting the gain of dipole, $ERP = EIPR - 2.15\text{dBi.}$
5. The resolution bandwidth and video bandwidth of test receiver/spectrum analyzer is 1MHz/3MHz.

7.3 TEST SETUP LAYOUT

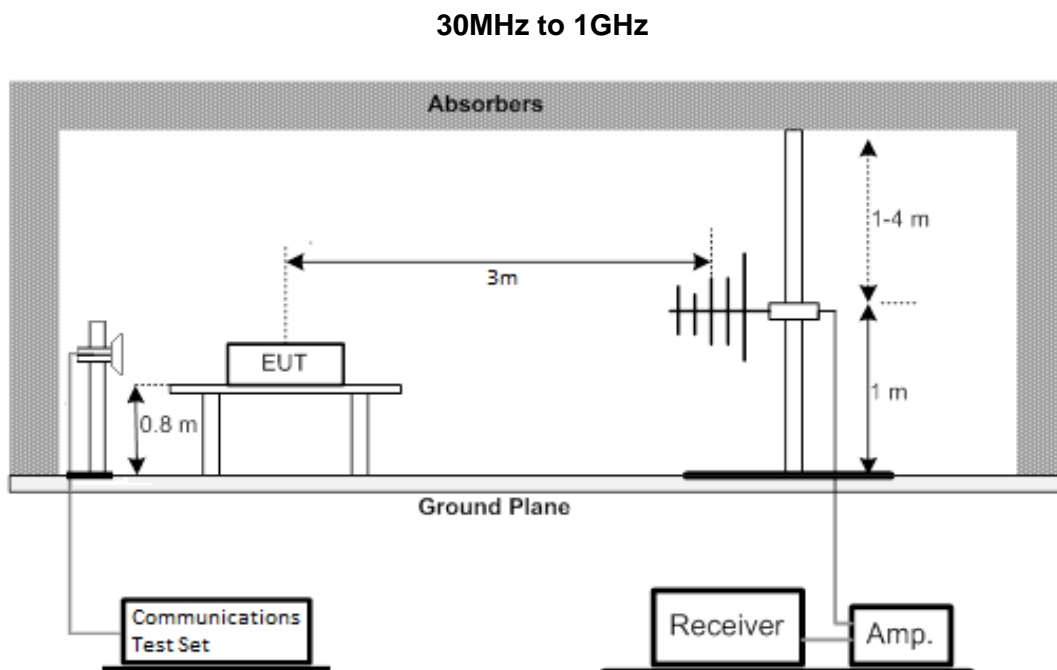

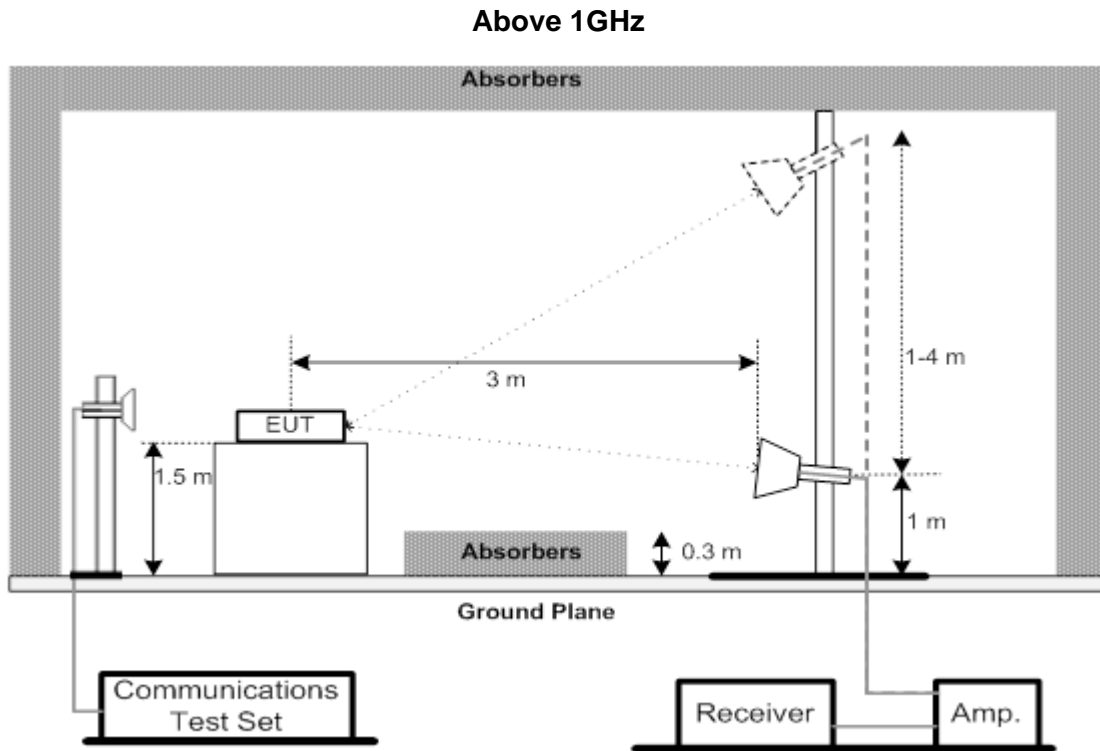

7.4 TEST RESULTS (30MHZ TO 1000MHZ)

Please refer to the APPENDIX E.

7.5 TEST RESULTS (ABOVE 1000MHZ)

Please refer to the APPENDIX F.

8. BAND EDGE MEASUREMENT

8.1 LIMIT

The power of any emission outside a licensee's frequency band(s) of operation shall be attenuated below the transmitter power (P) within the licensed band(s) of operation, measured in watts, by at least $43 + 10 \log (P)$ dB. Compliance with this provision is based on the use of measurement instrumentation employing a resolution bandwidth of 100 kilohertz or greater. However, in the 100 kilohertz bands immediately outside and adjacent to a licensee's frequency block, a resolution bandwidth of at least 30 kHz may be employed. (Part 27 Subpart L & H)

8.2 TEST PROCEDURES

The testing follows FCC KDB 971168 v03r01 Section 6.

1. All measurements were done at low and high operational frequency range.
2. Record the max trace plot into the test report.

8.3 TEST SETUP LAYOUT

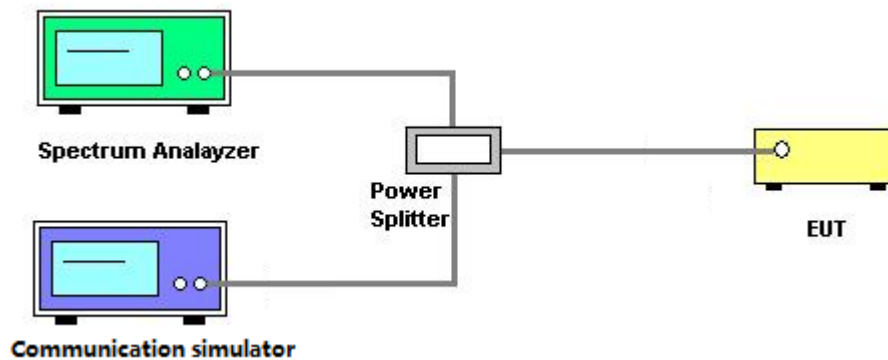

8.4 TEST DEVIATION

No deviation

8.5 TEST RESULTS

Please refer to the APPENDIX G.

9. PEAK TO AVERAGE RATIO MEASUREMENT

9.1 LIMIT

In measuring transmissions in this band using an average power technique, the peak to-average ratio (PAR) of the transmission may not exceed 13 dB.

9.2 TEST PROCEDURES

The testing follows FCC KDB 971168 v03r01 Section 5.7.

1. Set resolution/measurement bandwidth \geq signal's occupied bandwidth;
2. Set the number of counts to a value that stabilizes the measured CCDF curve;
3. Record the maximum PAPR level associated with a probability of 0.1%.

9.3 TEST SETUP LAYOUT

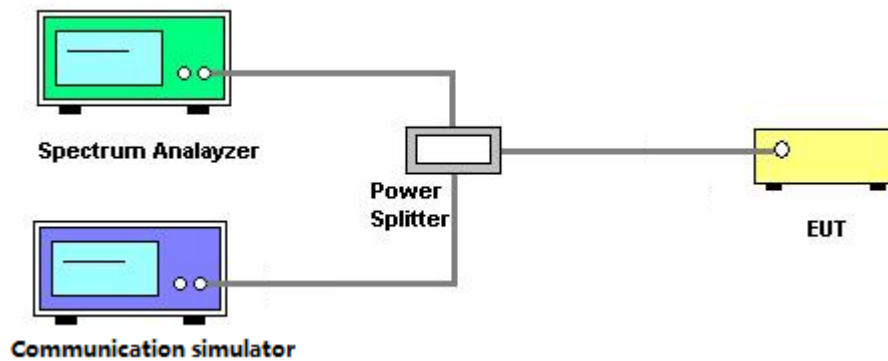

9.4 TEST DEVIATION

No deviation

9.5 TEST RESULTS

Please refer to the APPENDIX H.

10. FREQUENCY STABILITY MEASUREMENT

10.1 LIMIT

± 1.5 ppm is for base and fixed station. ± 2.5 ppm is for mobile station.

10.2 TEST PROCEDURES

The testing follows FCC KDB 971168 v03r01 Section 9.

1. Device is placed at the oven room. The oven room could control the temperatures and humidity. Power warm up is at least 15 min and power applied should perform before recording frequency error.
2. EUT is connected the external power supply to control the DC input power. The test voltage range is from minimum to maximum working voltage. Each step shall be record the frequency error rate.
3. The temperature range step is 10 degrees in this test items. All temperature levels shall be hold the $\pm 0.5^{\circ}\text{C}$ during the measurement testing. The each temperature step shall be at least 0.5 hours, consider the EUT could be test under the stability condition.
4. The frequency error was recorded frequency error from the communication simulator.

10.3 TEST SETUP LAYOUT

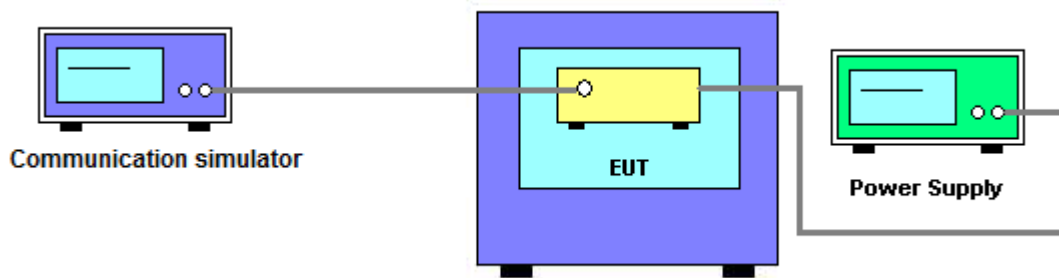

10.4 TEST DEVIATION

No deviation

10.5 TEST RESULTS

Please refer to the APPENDIX I.

11. LIST OF MEASUREMENT EQUIPMENTS

ERIP Power Measurement						
Item	Kind of Equipment	Manufacturer	Type No.	Serial No.	Calibrated Date	Calibrated Until
1	Radio Communication Analyzer	Anritsu	MT8821C	6262044728	2019/12/3	2020/12/2

Radiated Emissions Measurement						
Item	Kind of Equipment	Manufacturer	Type No.	Serial No.	Calibrated Date	Calibrated Until
1	Preamplifier	EMCI	EMC001340	980555	2020/4/10	2021/4/9
2	Preamplifier	EMCI	EMC02325B	980217	2020/4/10	2021/4/9
3	Preamplifier	EMCI	EMC012645B	980267	2020/4/10	2021/4/9
4	Test Cable	EMCI	EMC104-SM-SM-800	150207	2020/4/10	2021/4/9
5	Test Cable	EMCI	EMC104-SM-SM-3000	151205	2020/4/10	2021/4/9
6	Test Cable	EMCI	EMC-SM-SM-7000	180408	2020/4/10	2021/4/9
7	MXE EMI Receiver	Agilent	N9038A	MY554200087	2020/6/10	2021/6/9
8	Signal Analyzer	Agilent	N9010A	MY56480554	2020/6/4	2021/6/3
9	Loop Ant	EMCO	6502	274	2020/6/16	2021/6/15
10	Horn Ant	SCHWARZBECK	BBHA 9120D	9120D-01783	2019/8/14	2020/8/13
11	Trilog-Broadband Antenna	Schwarzbeck	VULB 9168	0992	2020/7/10	2021/7/9
12	5dB Attenuator	EMCI	EMCI-N-6-05	AT-N0508	2020/7/10	2021/7/9

Frequency Stability Measurement						
Item	Kind of Equipment	Manufacturer	Type No.	Serial No.	Calibrated Date	Calibrated Until
1	Radio Communication Analyzer	Anritsu	MT8821C	6262044728	43802	2020/12/2
2	Thermal Chamber	HOLINK	H-T-1F-D	BA03101701	2020/7/2	2021/7/1

Others Conducted Measurement						
Item	Kind of Equipment	Manufacturer	Type No.	Serial No.	Calibrated Date	Calibrated Until
1	Spectrum Analyzer	Agilent	N9010A	MY54200240	2019/11/19	2020/11/18

Spot check test:

AC Power Line Conducted Emissions						
Item	Kind of Equipment	Manufacturer	Type No.	Serial No.	Calibrated Date	Calibrated Until
1	TWO-LINE V-NETWORK	R&S	ENV216	101339	2021/3/10	2022/3/9
2	Test Cable	EMCI	EMCCFD300-BM-BMR-6000	170714	2021/6/7	2022/6/6
3	EMI Test Receiver	R&S	ESR 7	101433	2021/11/24	2022/11/23
4	Measurement Software	EZ	EZ EMC (Version NB-03A1-01)	N/A	N/A	N/A

ERIP Power Measurement						
Item	Kind of Equipment	Manufacturer	Type No.	Serial No.	Calibrated Date	Calibrated Until
1	Radio Communication Analyzer	Anritsu	MT8821C	6262044728	2020/12/15	2021/12/14

Radiated Emissions Measurement						
Item	Kind of Equipment	Manufacturer	Type No.	Serial No.	Calibrated Date	Calibrated Until
1	Preamplifier	EMCI	EMC02325	980217	2021/4/8	2022/4/7
2	Preamplifier	EMCI	EMC012645B	980222	2021/4/8	2022/4/7
3	Test Cable	EMCI	EMC104-SM-1000	180809	2021/4/8	2022/4/7
4	Test Cable	EMCI	EMC104-SM-SM-3000	151205	2021/4/8	2022/4/7
5	Test Cable	EMCI	EMC-SM-SM-7000	180408	2021/4/8	2022/4/7
6	MXE EMI Receiver	Agilent	N9038A	MY56400087	2021/5/27	2022/5/26
7	Signal Analyzer	Agilent	N9010A	MY56480554	2021/8/25	2022/8/24
8	Horn Ant	SCHWARZBECK	BBHA 9120D	9120D-1342	2021/6/2	2022/6/1
9	Horn Ant	Schwarzbeck	BBHA 9170	340	2021/7/9	2022/7/8
10	Trilog-Broadband Antenna	Schwarzbeck	VULB 9168	9168-352	2021/8/11	2022/8/10
11	5dB Attenuator	EMCI	EMCI-N-6-05	AT-N0625	2021/8/11	2022/8/10
12	Measurement Software	EZ	EZ EMC (Version NB-03A1-01)	N/A	N/A	N/A
13	8960 Series 10 Wireless Com Test Set	Agilent	E5515C	GB47390193	2021/7/23	2022/7/22
14	Radio Communication Analyzer (LTE)	Anritsu	MT8821C	6262044728	2022/11/28	2023/11/27

Remark: "N/A" denotes no model name, no serial no. or no calibration specified.
All calibration period of equipment list is one year.

12. EUT TEST PHOTOS

Please refer to document Appendix No.: TP-2007T023B-FCCP-2 (APPENDIX-TEST PHOTOS).

13. EUT PHOTOS

Please refer to document Appendix No.: EP-2007T023B-2 (APPENDIX-EUT PHOTOS).

APPENDIX A - AC POWER LINE CONDUCTED EMISSIONS

Test Mode	Normal	Tested Date	2021/12/8
Test Voltage	AC 120V/60Hz	Phase	Line

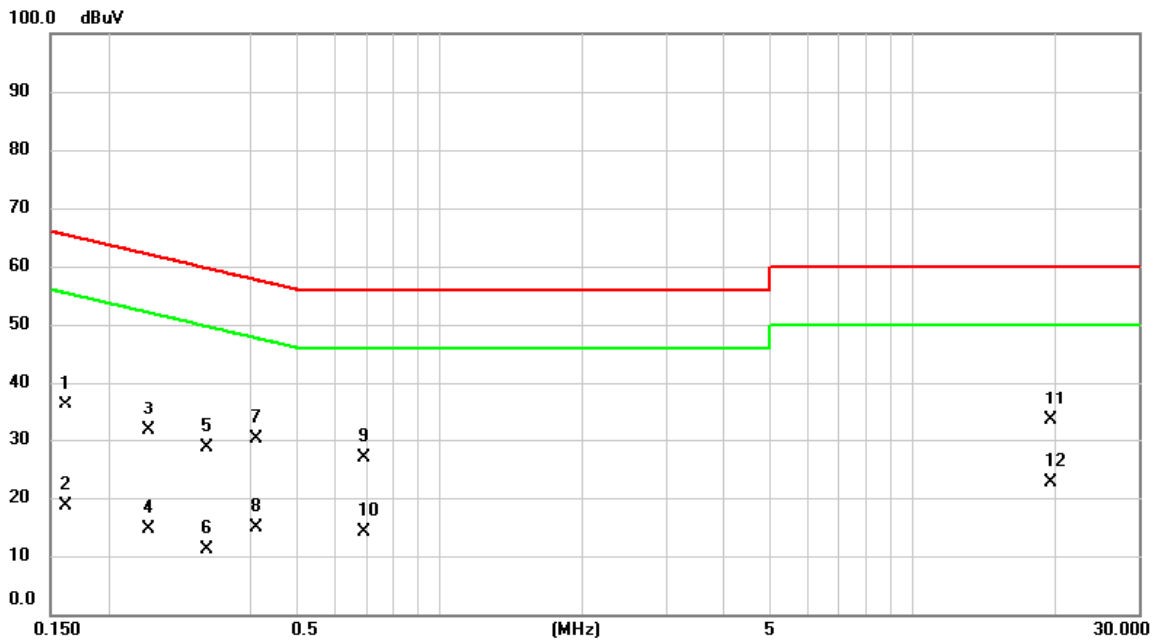

No.	Mk.	Freq. MHz	Reading Level dBuV	Correct Factor dB	Measure- ment dBuV	Limit		Detector	Comment
						dBuV	dB		
1		0.1613	26.38	9.68	36.06	65.40	-29.34	QP	
2		0.1613	8.94	9.68	18.62	55.40	-36.78	AVG	
3		0.2423	21.94	9.68	31.62	62.02	-30.40	QP	
4		0.2423	5.04	9.68	14.72	52.02	-37.30	AVG	
5		0.3232	18.94	9.68	28.62	59.62	-31.00	QP	
6		0.3232	1.43	9.68	11.11	49.62	-38.51	AVG	
7		0.4110	20.47	9.68	30.15	57.63	-27.48	QP	
8		0.4110	5.15	9.68	14.83	47.63	-32.80	AVG	
9		0.6945	17.18	9.68	26.86	56.00	-29.14	QP	
10		0.6945	4.42	9.68	14.10	46.00	-31.90	AVG	
11	*	19.5068	23.40	9.96	33.36	60.00	-26.64	QP	
12		19.5068	12.61	9.96	22.57	50.00	-27.43	AVG	

REMARKS:

- (1) Measurement Value = Reading Level + Correct Factor.
- (2) Margin Level = Measurement Value - Limit Value.

Test Mode	Normal	Tested Date	2021/12/8
Test Voltage	AC 120V/60Hz	Phase	Neutral

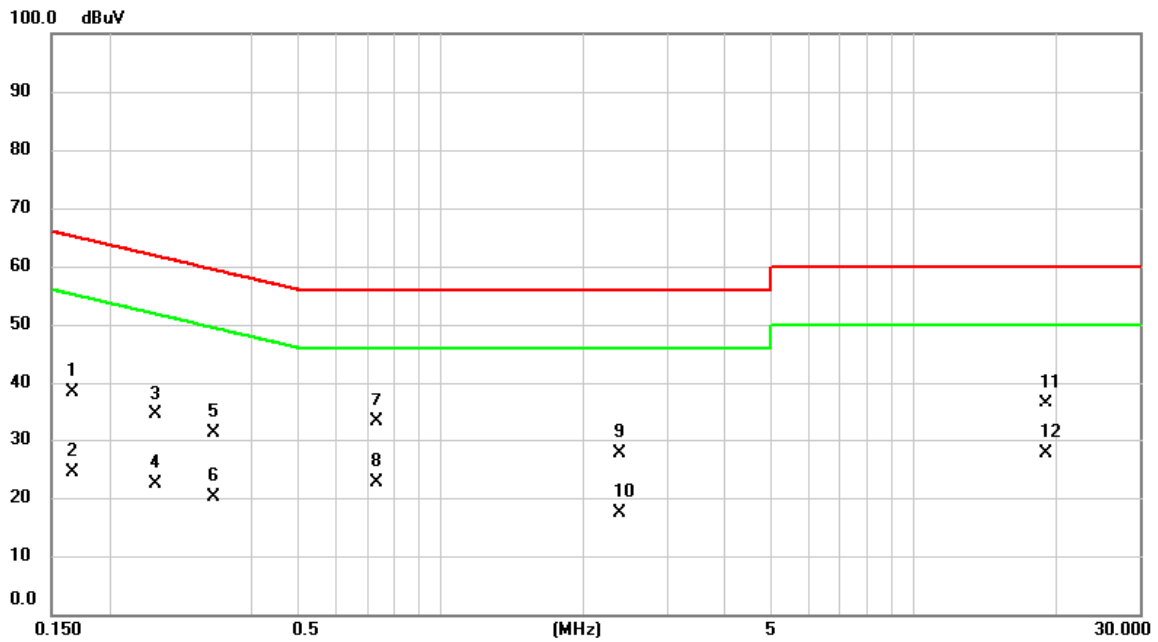

No.	Mk.	Freq. MHz	Reading Level dBuV	Correct Factor dB	Measure- ment dBuV	Limit dBuV	Over dB	Detector	Comment
1		0.1658	28.59	9.68	38.27	65.17	-26.90	QP	
2		0.1658	14.66	9.68	24.34	55.17	-30.83	AVG	
3		0.2490	24.64	9.68	34.32	61.79	-27.47	QP	
4		0.2490	12.67	9.68	22.35	51.79	-29.44	AVG	
5		0.3322	21.33	9.68	31.01	59.40	-28.39	QP	
6		0.3322	10.57	9.68	20.25	49.40	-29.15	AVG	
7		0.7327	23.39	9.68	33.07	56.00	-22.93	QP	
8		0.7327	12.89	9.68	22.57	46.00	-23.43	AVG	
9		2.3820	17.96	9.74	27.70	56.00	-28.30	QP	
10		2.3820	7.62	9.74	17.36	46.00	-28.64	AVG	
11		19.0275	26.43	9.96	36.39	60.00	-23.61	QP	
12	*	19.0275	17.59	9.96	27.55	50.00	-22.45	AVG	

REMARKS:

- (1) Measurement Value = Reading Level + Correct Factor.
- (2) Margin Level = Measurement Value - Limit Value.

Test Mode	Idle	Tested Date	2021/12/8
Test Voltage	AC 120V/60Hz	Phase	Line

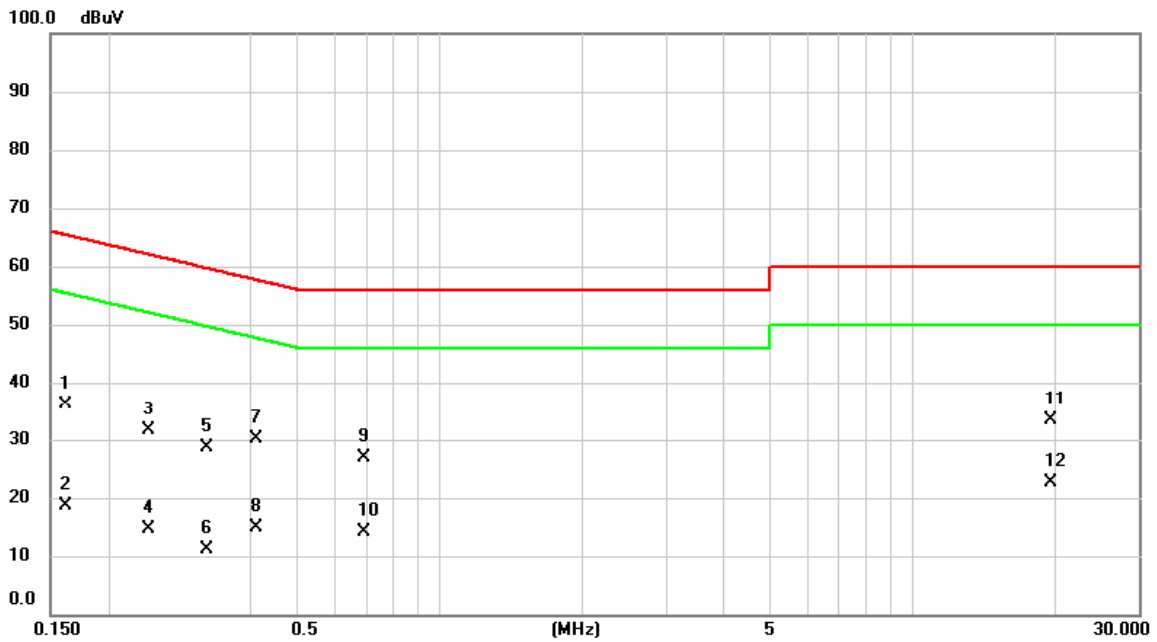

No.	Mk.	Freq. MHz	Reading Level dBuV	Correct Factor dB	Measure- ment dBuV	Limit		Detector	Comment
						dBuV	dB		
1		0.1613	26.38	9.68	36.06	65.40	-29.34	QP	
2		0.1613	8.94	9.68	18.62	55.40	-36.78	AVG	
3		0.2423	21.94	9.68	31.62	62.02	-30.40	QP	
4		0.2423	5.04	9.68	14.72	52.02	-37.30	AVG	
5		0.3232	18.94	9.68	28.62	59.62	-31.00	QP	
6		0.3232	1.43	9.68	11.11	49.62	-38.51	AVG	
7		0.4110	20.47	9.68	30.15	57.63	-27.48	QP	
8		0.4110	5.15	9.68	14.83	47.63	-32.80	AVG	
9		0.6945	17.18	9.68	26.86	56.00	-29.14	QP	
10		0.6945	4.42	9.68	14.10	46.00	-31.90	AVG	
11	*	19.5068	23.40	9.96	33.36	60.00	-26.64	QP	
12		19.5068	12.61	9.96	22.57	50.00	-27.43	AVG	

REMARKS:

- (1) Measurement Value = Reading Level + Correct Factor.
- (2) Margin Level = Measurement Value - Limit Value.

Test Mode	Idle	Tested Date	2021/12/8
Test Voltage	AC 120V/60Hz	Phase	Neutral

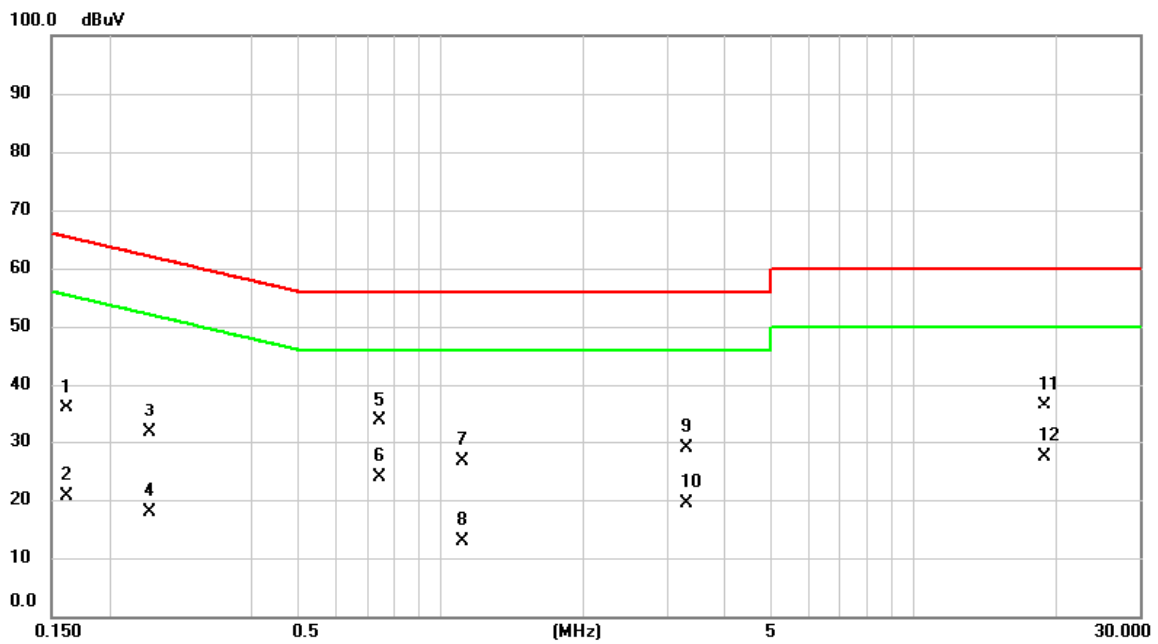

No.	Mk.	Freq. MHz	Reading Level dBuV	Correct Factor dB	Measure- ment dBuV	Limit dBuV	Over dB	Detector	Comment
1		0.1613	26.31	9.68	35.99	65.40	-29.41	QP	
2		0.1613	11.01	9.68	20.69	55.40	-34.71	AVG	
3		0.2423	22.05	9.68	31.73	62.02	-30.29	QP	
4		0.2423	8.23	9.68	17.91	52.02	-34.11	AVG	
5		0.7417	23.98	9.68	33.66	56.00	-22.34	QP	
6	*	0.7417	14.12	9.68	23.80	46.00	-22.20	AVG	
7		1.1130	16.97	9.69	26.66	56.00	-29.34	QP	
8		1.1130	3.17	9.69	12.86	46.00	-33.14	AVG	
9		3.2888	19.16	9.77	28.93	56.00	-27.07	QP	
10		3.2888	9.59	9.77	19.36	46.00	-26.64	AVG	
11		18.8858	26.49	9.96	36.45	60.00	-23.55	QP	
12		18.8858	17.52	9.96	27.48	50.00	-22.52	AVG	

REMARKS:

- (1) Measurement Value = Reading Level + Correct Factor.
- (2) Margin Level = Measurement Value - Limit Value.

APPENDIX B - RADIATED POWER

Test Mode	LTE Cat-M1 Band 4	Test Date	2020/7/24
-----------	-------------------	-----------	-----------

Band	BW (MHz)	Channel	Frequency (MHz)	Mode	Narrowband Index	UL RB Allocation	UL RB Offset	Average power (dBm)	EIRP power (dBm)
4	5	19975	1712.5	QPSK	0	1	0	21.20	14.67
					0	6	0	21.12	14.59
				16QAM	0	1	0	20.77	14.24
					0	6	0	20.71	14.18
		20175	1732.5	QPSK	0	1	0	20.96	14.43
					0	6	0	20.86	14.33
				16QAM	0	1	0	20.50	13.97
					0	6	0	20.37	13.84
		20375	1752.5	QPSK	0	1	5	20.60	14.07
					0	6	0	20.50	13.97
				16QAM	3	1	5	20.13	13.60
					3	6	0	20.07	13.54
Band	BW (MHz)	Channel	Frequency (MHz)	Mode	Narrowband Index	UL RB Allocation	UL RB Offset	Average power (dBm)	EIRP power (dBm)
4	10	20000	1715.0	QPSK	0	1	0	21.25	14.72
					0	6	0	21.17	14.64
				16QAM	0	1	0	20.82	14.29
					0	6	0	20.76	14.23
		20175	1732.5	QPSK	0	1	0	21.01	14.48
					0	6	0	20.91	14.38
				16QAM	0	1	0	20.55	14.02
					0	6	0	20.42	13.89
		20350	1750.0	QPSK	7	1	5	20.65	14.12
					7	6	0	20.55	14.02
				16QAM	7	1	5	20.18	13.65
					7	6	0	20.12	13.59
Band	BW (MHz)	Channel	Frequency (MHz)	Mode	Narrowband Index	UL RB Allocation	UL RB Offset	Average power (dBm)	EIRP power (dBm)
4	15	20025	1717.5	QPSK	0	1	0	21.30	14.77
					0	6	0	21.22	14.69
				16QAM	0	1	0	20.87	14.34
					0	6	0	20.81	14.28
		20175	1732.5	QPSK	0	1	0	21.06	14.53
					0	6	0	20.96	14.43
				16QAM	0	1	0	20.60	14.07
					0	6	0	20.47	13.94
		20325	1747.5	QPSK	11	1	5	20.70	14.17
					11	6	0	20.60	14.07
				16QAM	11	1	5	20.23	13.70
					11	6	0	20.17	13.64
Band	BW (MHz)	Channel	Frequency (MHz)	Mode	Narrowband Index	UL RB Allocation	UL RB Offset	Average power (dBm)	EIRP power (dBm)
4	20	20050	1720.0	QPSK	0	1	0	21.35	14.82
					0	6	0	21.27	14.74
				16QAM	0	1	0	20.92	14.39
					0	6	0	20.86	14.33
		20175	1732.5	QPSK	0	1	0	21.11	14.58
					0	6	0	21.01	14.48
				16QAM	0	1	0	20.65	14.12
					0	6	0	20.52	13.99
		20300	1745.0	QPSK	15	1	5	20.75	14.22
					15	6	0	20.65	14.12
				16QAM	15	1	5	20.28	13.75
					15	6	0	20.22	13.69

Antenna Gain: -6.53 dBi

Test Mode	LTE Cat-M1 Band 12	Test Date	2020/7/24
-----------	--------------------	-----------	-----------

Band	BW (MHz)	Channel	Frequency (MHz)	Mode	Narrowband Index	UL RB Allocation	UL RB Offset	Average power (dBm)	ERP power (dBm)
12	5	23035	701.5	QPSK	0	1	0	21.98	11.37
					0	6	0	21.04	10.43
				16QAM	0	1	0	21.41	10.80
					0	6	0	20.67	10.06
		23095	707.5	QPSK	0	1	0	22.06	11.45
					0	6	0	21.13	10.52
				16QAM	0	1	0	21.51	10.90
					0	6	0	20.69	10.08
		23155	713.5	QPSK	3	1	5	22.13	11.52
					3	6	0	21.17	10.56
				16QAM	3	1	5	21.61	11.00
					3	6	0	20.63	10.02
12	10	23060	704.0	QPSK	0	1	0	22.0	11.42
					0	6	0	21.1	10.48
				16QAM	0	1	0	21.5	10.85
					0	6	0	20.7	10.11
		23095	707.5	QPSK	0	1	0	22.1	11.50
					0	6	0	21.2	10.57
				16QAM	0	1	0	21.6	10.95
					0	6	0	20.7	10.13
		23130	711.0	QPSK	7	1	5	22.2	11.57
					7	6	0	21.2	10.61
				16QAM	7	1	5	21.7	11.05
					7	6	0	20.7	10.07

Antenna Gain: -8.46 dBi

Spot check test:

Test Mode	LTE Cat-M1 Band 4	Test Date	2021/12/6
-----------	-------------------	-----------	-----------

Band	BW (MHz)	Channel	Frequency (MHz)	Mode	Narrowband Index	UL RB Allocation	UL RB Offset	Average power (dBm)	EIRP power (dBm)	
4	5	19975	1712.5	QPSK	0	1	0	20.97	14.44	
					0	6	0	20.88	14.35	
				16QAM	0	1	0	20.47	13.94	
		0	6		0	20.46	13.93			
		20175	1732.5	QPSK	0	1	0	20.71	14.18	
					0	6	0	20.55	14.02	
	16QAM			0	1	0	20.21	13.68		
		0	6	0	20.07	13.54				
	20375	1752.5	QPSK	0	1	5	20.38	13.85		
				0	6	0	20.24	13.71		
			16QAM	3	1	5	19.87	13.34		
	3	6		0	19.85	13.32				
4	10	20000	1715.0	QPSK	0	1	0	20.97	14.44	
					0	6	0	20.88	14.35	
				16QAM	0	1	0	20.51	13.98	
					0	6	0	20.54	14.01	
		20175	1732.5	QPSK	0	1	0	20.75	14.22	
					0	6	0	20.69	14.16	
				16QAM	0	1	0	20.24	13.71	
					0	6	0	20.10	13.57	
		20350	1750.0	QPSK	7	1	5	20.37	13.84	
					7	6	0	20.26	13.73	
				16QAM	7	1	5	19.93	13.40	
					7	6	0	19.88	13.35	
	4	15	20025	1717.5	QPSK	0	1	0	21.03	14.50
						0	6	0	20.92	14.39
					16QAM	0	1	0	20.61	14.08
						0	6	0	20.56	14.03
			20175	1732.5	QPSK	0	1	0	20.82	14.29
						0	6	0	20.69	14.16
16QAM					0	1	0	20.32	13.79	
					0	6	0	20.18	13.65	
20325			1747.5	QPSK	11	1	5	20.46	13.93	
					11	6	0	20.31	13.78	
				16QAM	11	1	5	19.99	13.46	
					11	6	0	19.94	13.41	
4	20	20050	1720.0	QPSK	0	1	0	21.09	14.56	
					0	6	0	21.01	14.48	
				16QAM	0	1	0	20.61	14.08	
					0	6	0	20.61	14.08	
		20175	1732.5	QPSK	0	1	0	20.83	14.30	
					0	6	0	20.73	14.20	
				16QAM	0	1	0	20.34	13.81	
					0	6	0	20.29	13.76	
		20300	1745.0	QPSK	15	1	5	20.50	13.97	
					15	6	0	20.33	13.80	
				16QAM	15	1	5	20.01	13.48	
					15	6	0	19.93	13.40	

Antenna Gain: -6.53 dBi

Test Mode	LTE Cat-M1 Band 12	Test Date	2021/12/6
-----------	--------------------	-----------	-----------

Band	BW (MHz)	Channel	Frequency (MHz)	Mode	Narrowband Index	UL RB Allocation	UL RB Offset	Average power (dBm)	EIRP power (dBm)	
12	5	23035	701.5	QPSK	0	1	0	21.72	13.26	
				16QAM	0	6	0	20.75	12.29	
		23095	707.5	QPSK	0	1	0	21.13	12.67	
				16QAM	0	6	0	20.39	11.93	
		23155	713.5	QPSK	0	1	0	21.82	13.36	
				16QAM	0	6	0	20.90	12.44	
	12	10	23060	704.0	QPSK	0	1	0	21.26	12.80
					16QAM	0	6	0	20.44	11.98
			23095	707.5	QPSK	3	1	5	21.84	13.38
					16QAM	3	6	0	20.93	12.47
			23130	711.0	QPSK	3	1	5	21.30	12.84
					16QAM	3	6	0	20.38	11.92
12	5	23060	704.0	QPSK	0	1	0	21.80	13.34	
				16QAM	0	6	0	20.83	12.37	
		23095	707.5	QPSK	0	1	0	21.22	12.76	
				16QAM	0	6	0	20.49	12.03	
		23130	711.0	QPSK	0	1	0	21.85	13.39	
				16QAM	0	6	0	20.86	12.40	
	12	10	23095	707.5	QPSK	0	1	0	21.33	12.87
					16QAM	0	6	0	20.48	12.02
			23130	711.0	QPSK	7	1	5	21.88	13.42
					16QAM	7	6	0	21.16	12.70
			23130	711.0	QPSK	7	1	5	21.41	12.95
					16QAM	7	6	0	20.43	11.97

Antenna Gain: -6.53 dBi

APPENDIX C - OCCUPIED BANDWIDTH

Test Mode	LTE Cat-M1 Band 4	Test Date	2020/7/24
-----------	-------------------	-----------	-----------

LTE Cat-M1 Band 4_5M					
QPSK					
Channel	Frequency (MHz)	99% Occupied Bandwidth (MHz)	Channel	Frequency (MHz)	26dB Bandwidth (MHz)
19975	1712.5	1.0839	19975	1712.5	1.341
20175	1732.5	1.0922	20175	1732.5	1.391
20375	1752.5	1.0891	20375	1752.5	1.424
16QAM					
Channel	Frequency (MHz)	99% Occupied Bandwidth (MHz)	Channel	Frequency (MHz)	26dB Bandwidth (MHz)
19975	1712.5	1.0878	19975	1712.5	1.373
20175	1732.5	1.0879	20175	1732.5	1.409
20375	1752.5	1.0911	20375	1752.5	1.462

Spectrum Plot

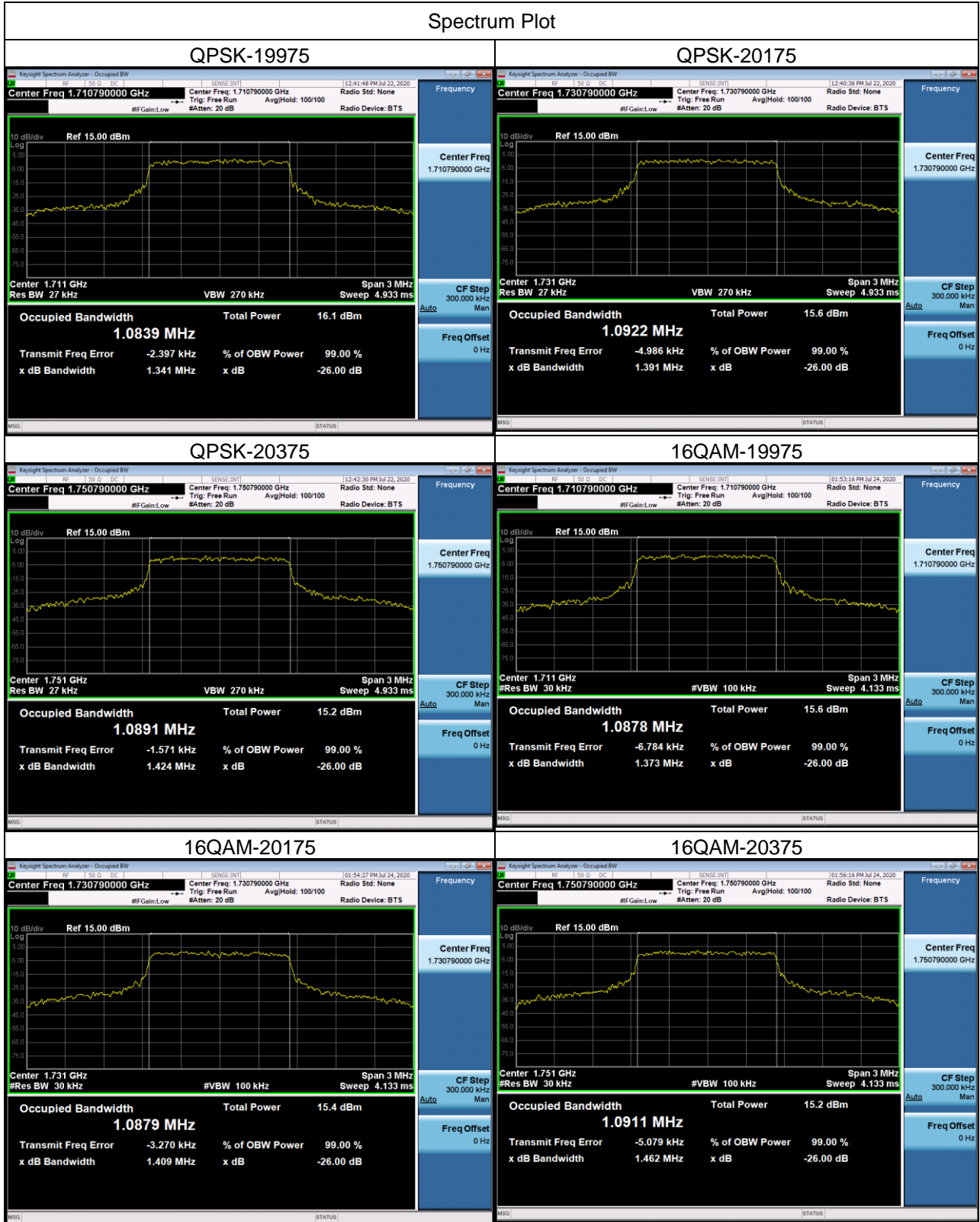

LTE Cat-M1 Band 4_10M					
QPSK					
Channel	Frequency (MHz)	99% Occupied Bandwidth (MHz)	Channel	Frequency (MHz)	26dB Bandwidth (MHz)
20000	1715	1.0927	20000	1715	1.404
20175	1732.5	1.0876	20175	1732.5	1.359
20350	1750	1.0947	20350	1750	1.463
16QAM					
Channel	Frequency (MHz)	99% Occupied Bandwidth (MHz)	Channel	Frequency (MHz)	26dB Bandwidth (MHz)
20000	1715	1.0919	20000	1715	1.386
20175	1732.5	1.0932	20175	1732.5	1.414
20350	1750	1.0900	20350	1750	1.438

Spectrum Plot

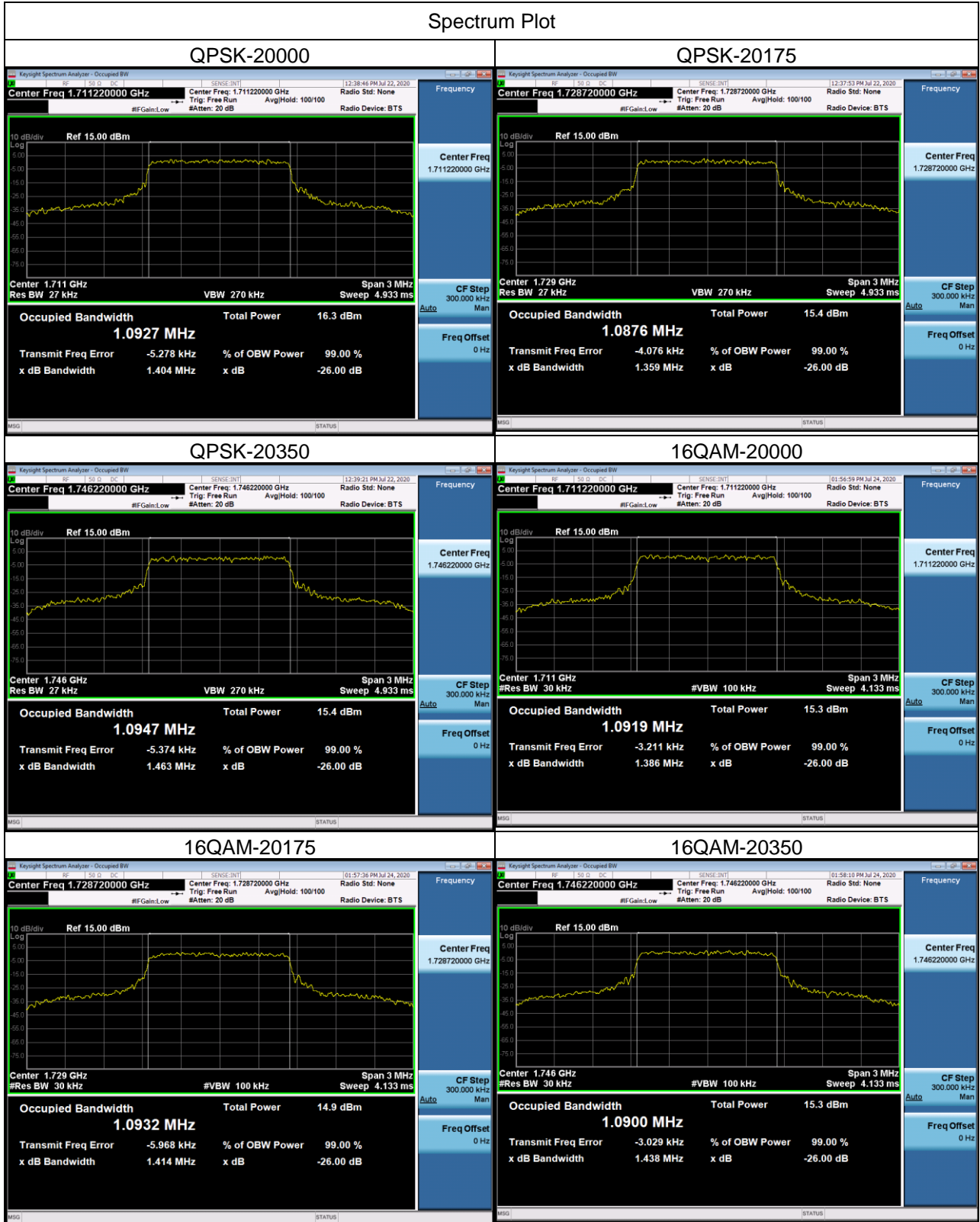

LTE Cat-M1 Band 4_15M					
QPSK					
Channel	Frequency (MHz)	99% Occupied Bandwidth (MHz)	Channel	Frequency (MHz)	26dB Bandwidth (MHz)
20025	1717.5	1.0902	20025	1717.5	1.446
20175	1732.5	1.0922	20175	1732.5	1.401
20325	1747.5	1.0922	20325	1747.5	1.561
16QAM					
Channel	Frequency (MHz)	99% Occupied Bandwidth (MHz)	Channel	Frequency (MHz)	26dB Bandwidth (MHz)
20025	1717.5	1.0956	20025	1717.5	1.435
20175	1732.5	1.0920	20175	1732.5	1.422
20325	1747.5	1.0953	20325	1747.5	1.496

Spectrum Plot

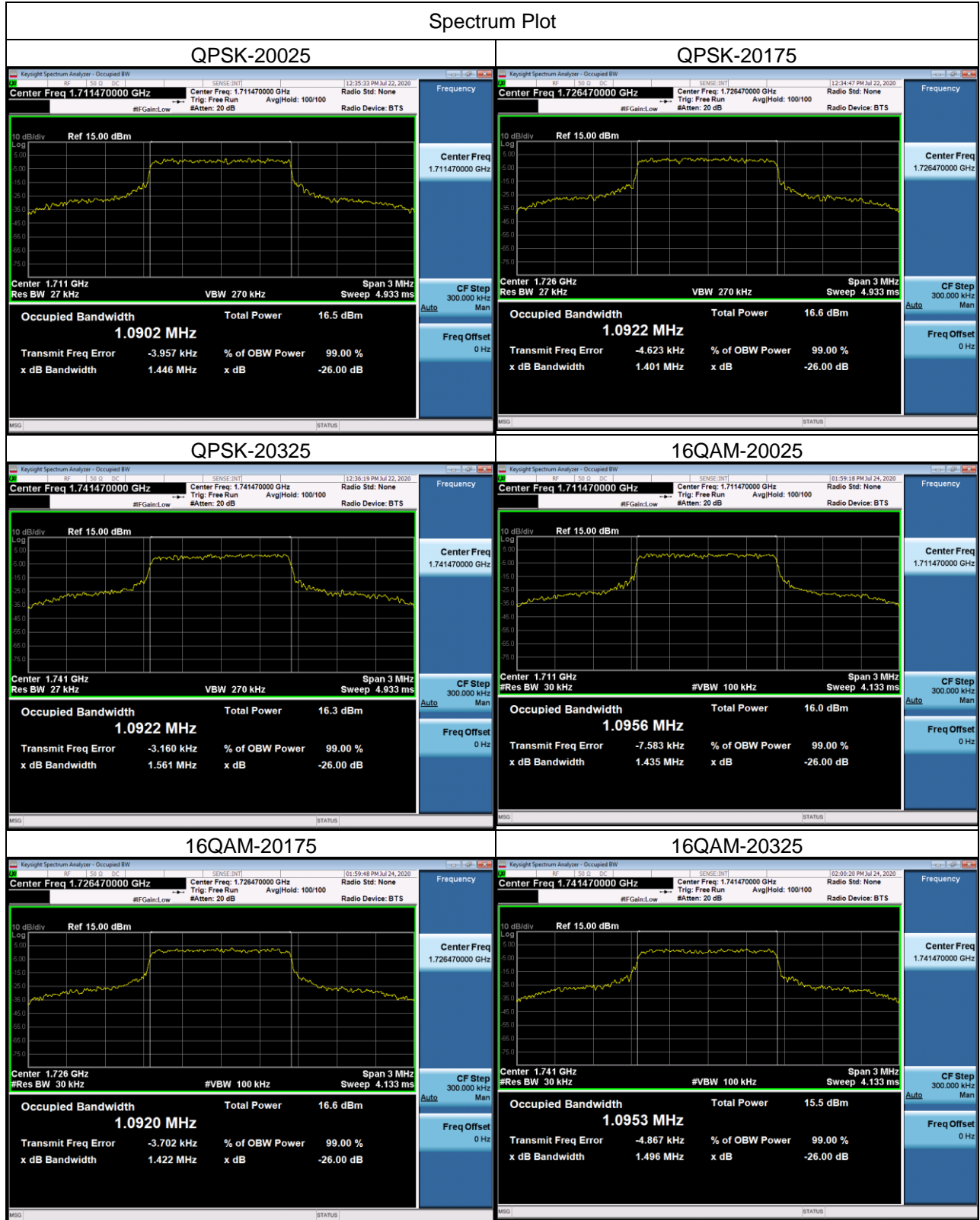

LTE Cat-M1 Band 4_20M					
QPSK					
Channel	Frequency (MHz)	99% Occupied Bandwidth (MHz)	Channel	Frequency (MHz)	26dB Bandwidth (MHz)
20050	1720	1.0912	20050	1720	1.452
20175	1732.5	1.0987	20175	1732.5	1.523
20300	1745	1.0981	20300	1745	1.629
16QAM					
Channel	Frequency (MHz)	99% Occupied Bandwidth (MHz)	Channel	Frequency (MHz)	26dB Bandwidth (MHz)
20050	1720	1.0953	20050	1720	1.438
20175	1732.5	1.0967	20175	1732.5	1.476
20300	1745	1.0990	20300	1745	1.659

Spectrum Plot

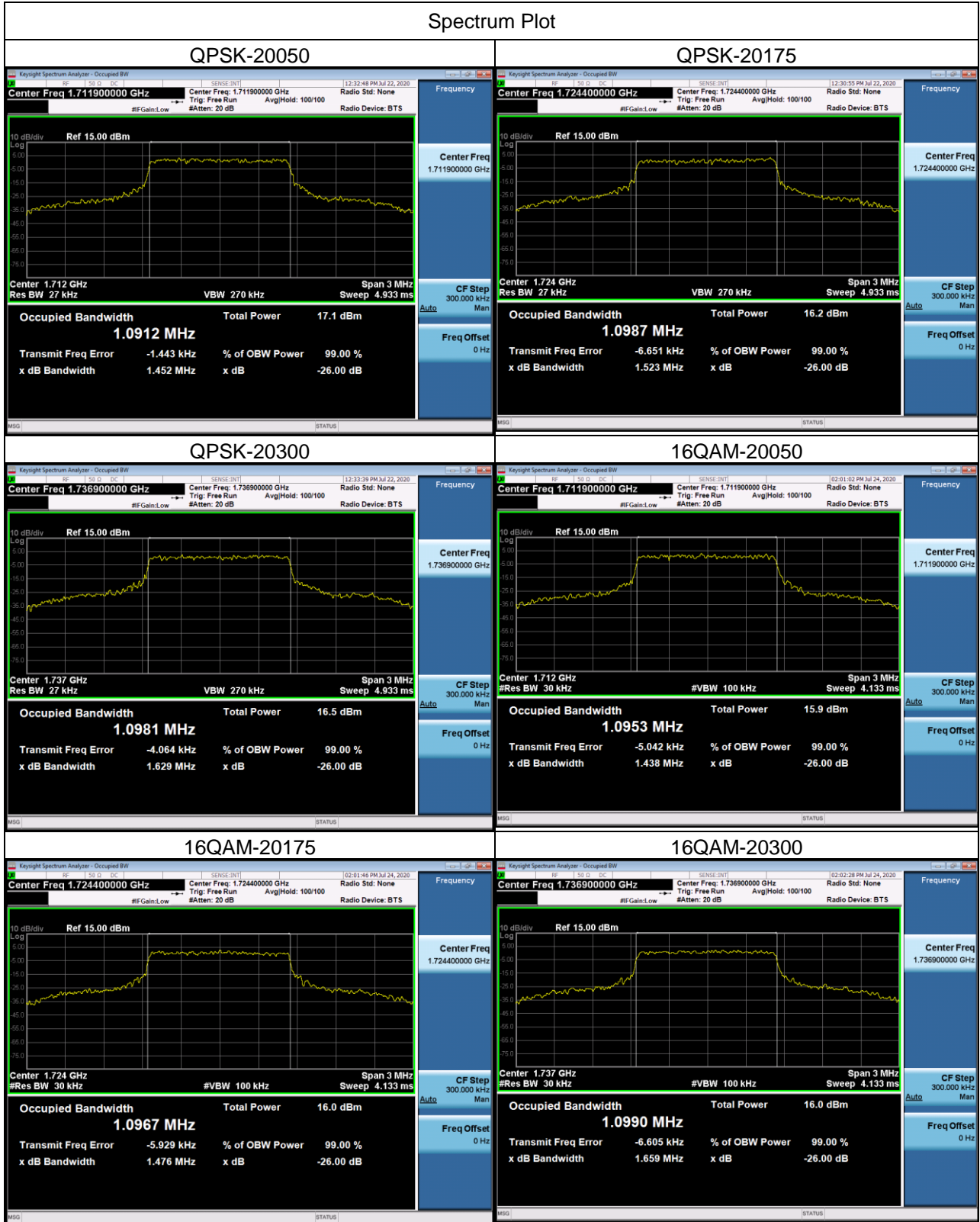

Test Mode	LTE Cat-M1 Band 12	Test Date	2020/7/24
-----------	--------------------	-----------	-----------

LTE Cat-M1 Band 12_5M					
QPSK					
Channel	Frequency (MHz)	99% Occupied Bandwidth (MHz)	Channel	Frequency (MHz)	26dB Bandwidth (MHz)
23035	701.5	1.0893	23035	701.5	1.425
23095	707.5	1.0895	23095	707.5	1.430
23155	713.5	1.0898	23155	713.5	1.395
16QAM					
Channel	Frequency (MHz)	99% Occupied Bandwidth (MHz)	Channel	Frequency (MHz)	26dB Bandwidth (MHz)
23035	701.5	1.0954	23035	701.5	1.431
23095	707.5	1.0940	23095	707.5	1.366
23155	713.5	1.0968	23155	713.5	1.414

Spectrum Plot



LTE Cat-M1 Band 12_10M					
QPSK					
Channel	Frequency (MHz)	99% Occupied Bandwidth (MHz)	Channel	Frequency (MHz)	26dB Bandwidth (MHz)
23060	704.0	1.0952	23060	704.0	1.454
23095	707.5	1.0907	23095	707.5	1.409
23130	711.0	1.0907	23130	711.0	1.429
16QAM					
Channel	Frequency (MHz)	99% Occupied Bandwidth (MHz)	Channel	Frequency (MHz)	26dB Bandwidth (MHz)
23060	704.0	1.0951	23060	704.0	1.457
23095	707.5	1.0945	23095	707.5	1.381
23130	711.0	1.0882	23130	711.0	1.408

Spectrum Plot

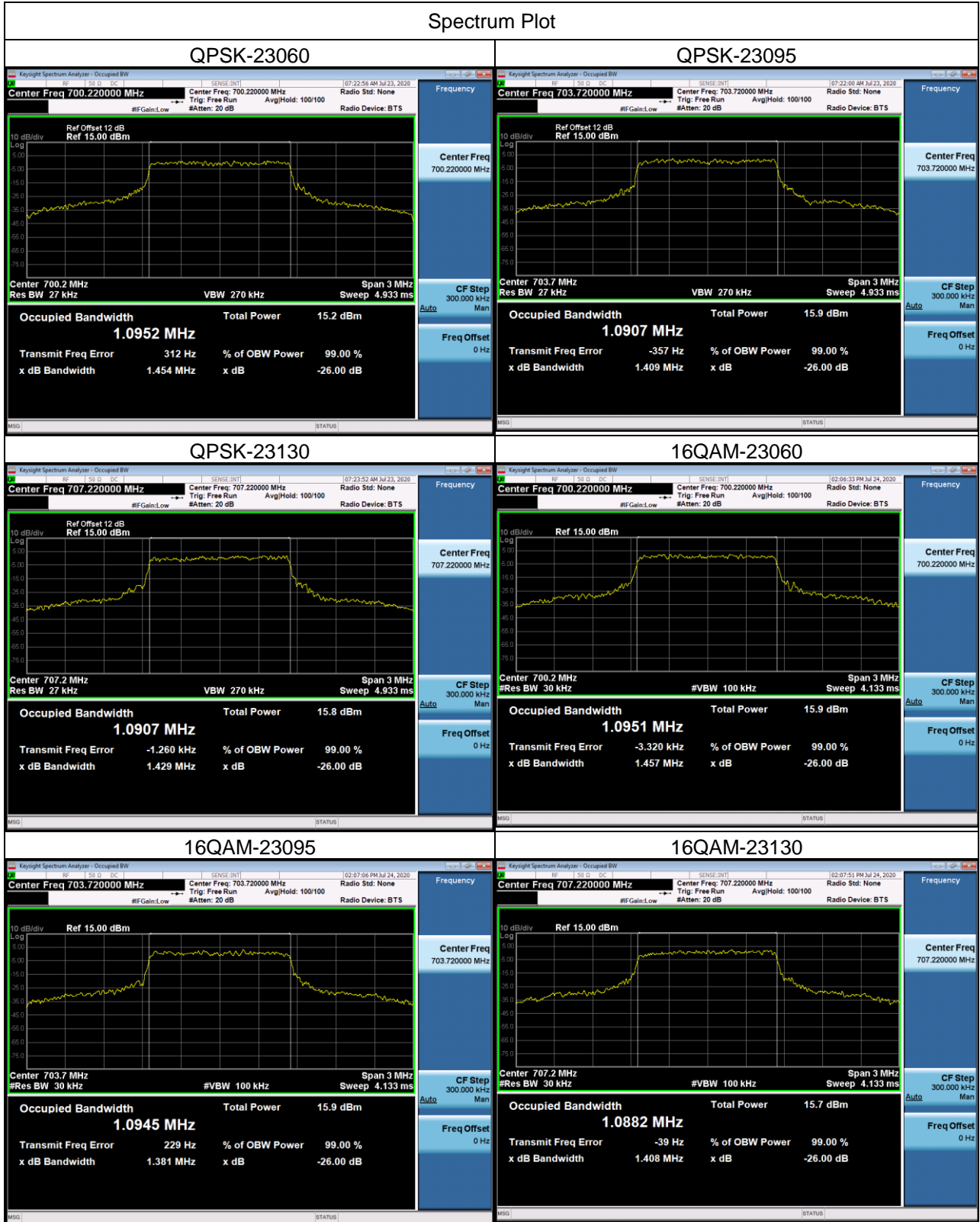

APPENDIX D - CONDUCTED SPURIOUS EMISSIONS

Test Mode	LTE Cat-M1 Band 4	Test Date	2020/7/24
-----------	-------------------	-----------	-----------

LTE Cat-M1 Band 4_5M Spectrum Plot	
Channel	Frequency(MHz)
20175	1732.5

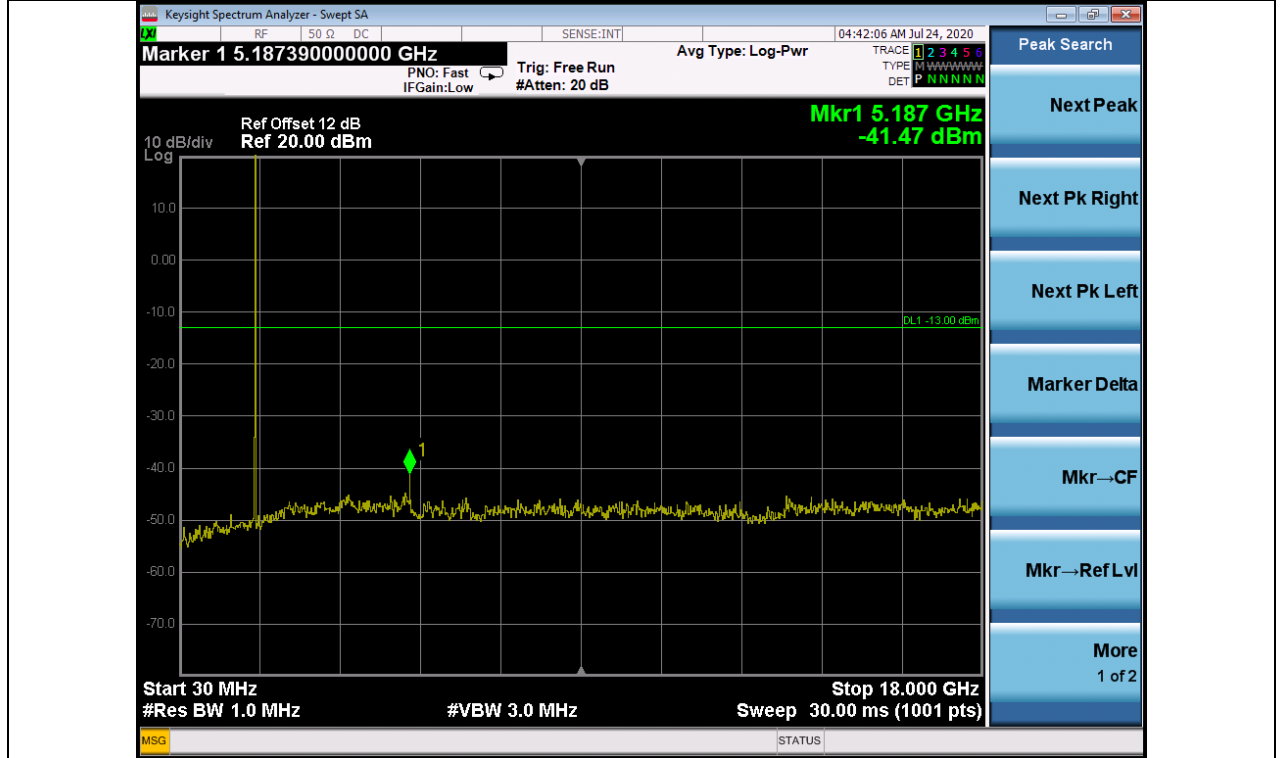

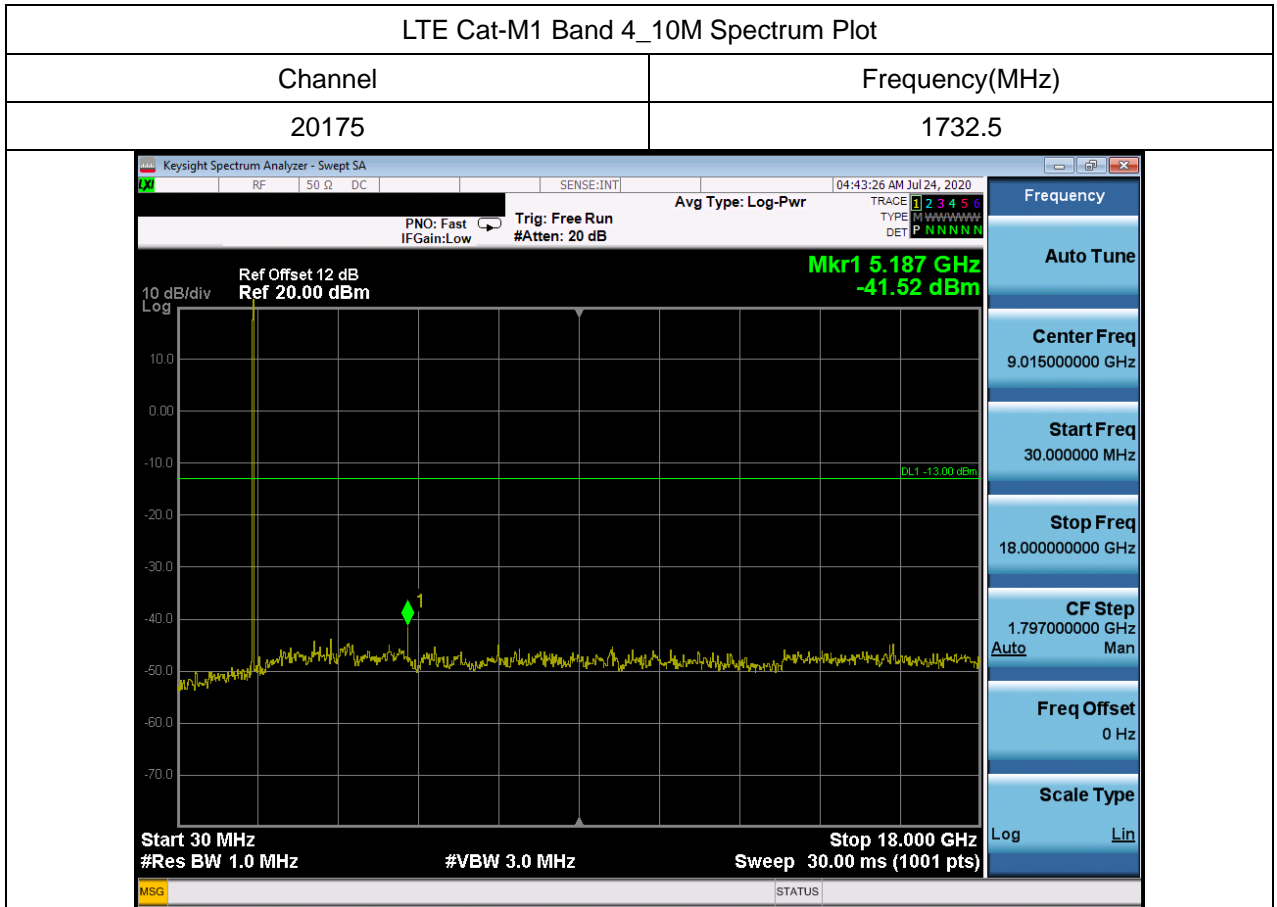

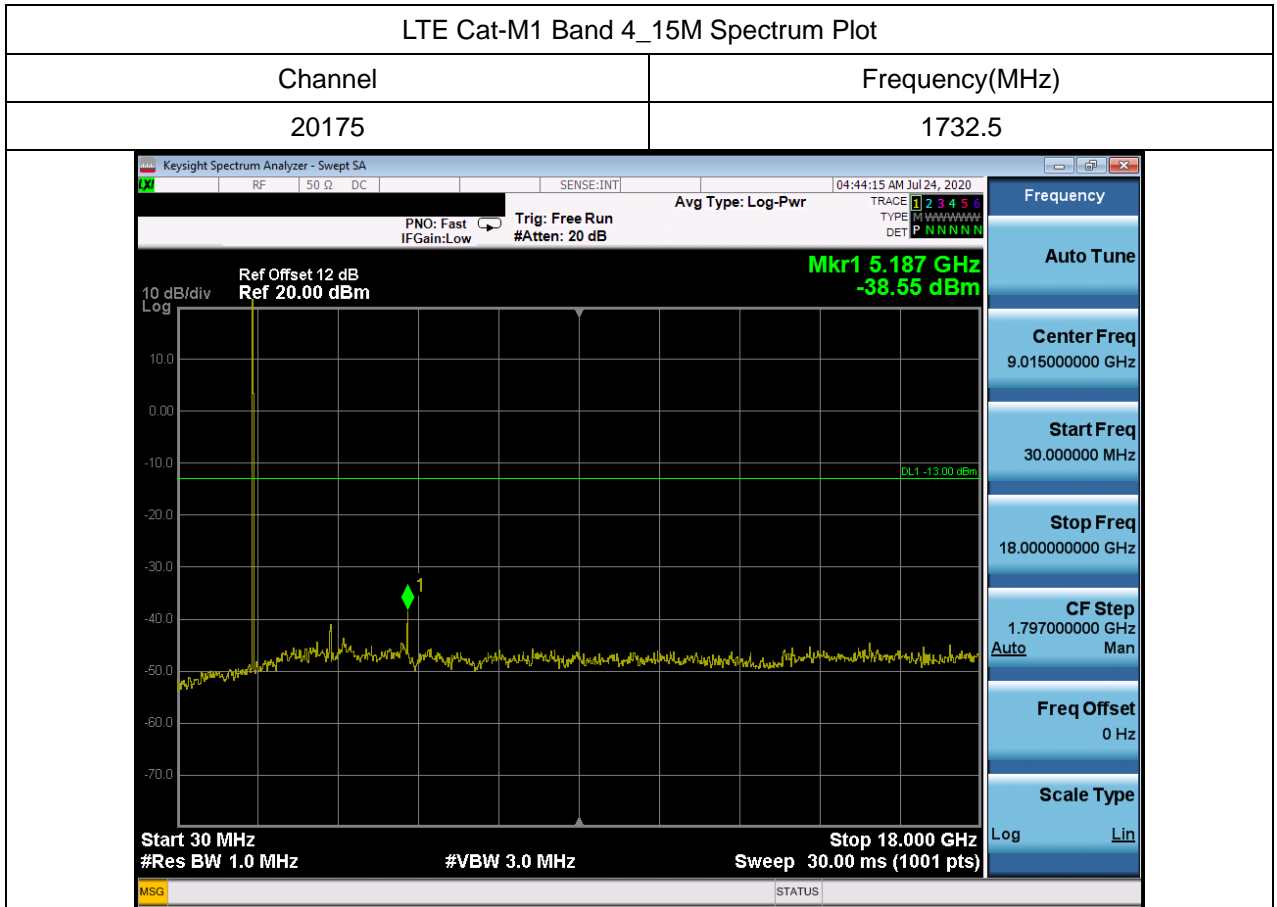

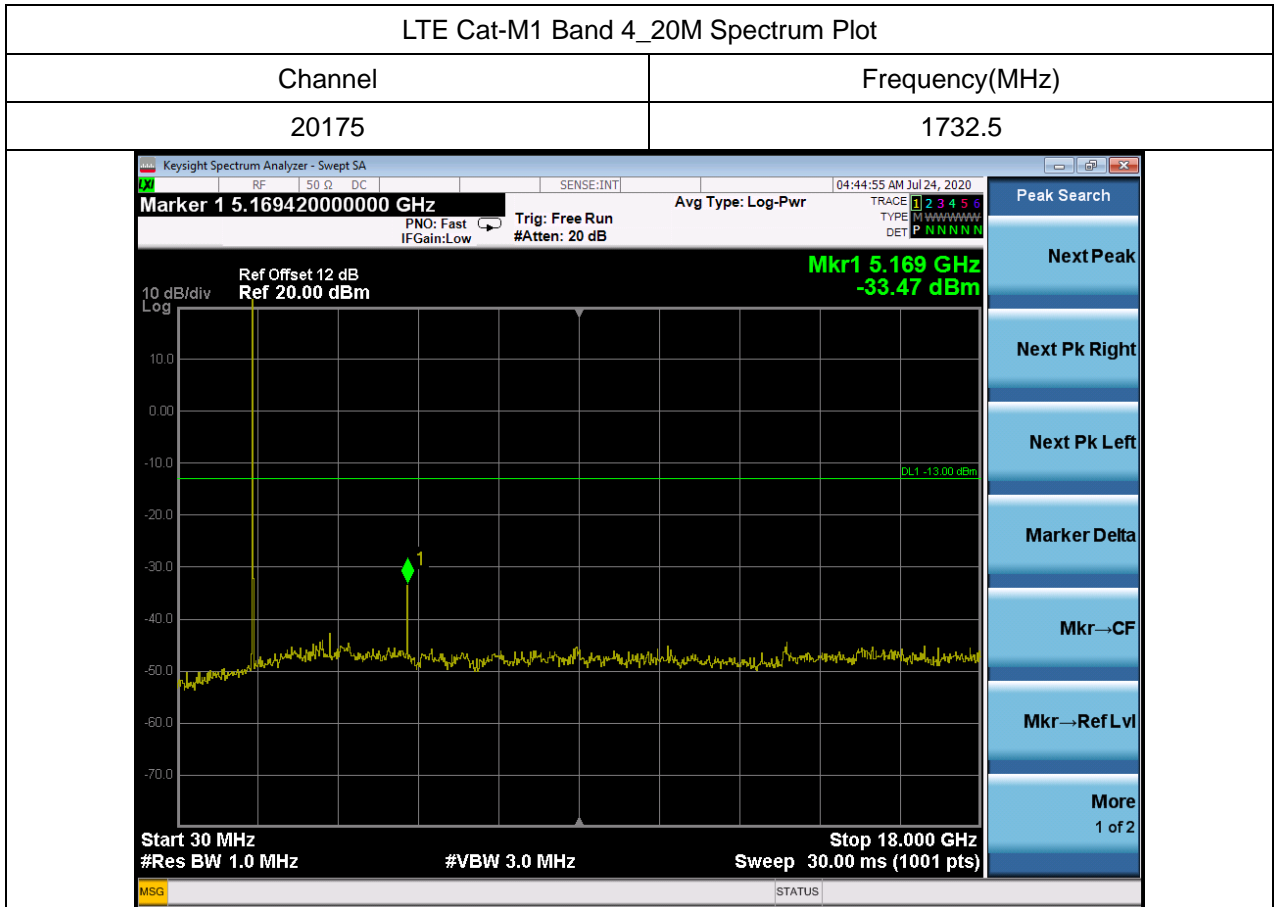

Test Mode	LTE Cat-M1 Band 12	Test Date	2020/7/24
-----------	--------------------	-----------	-----------

LTE Cat-M1 Band 12_5M Spectrum Plot	
Channel	Frequency(MHz)
23095	707.5

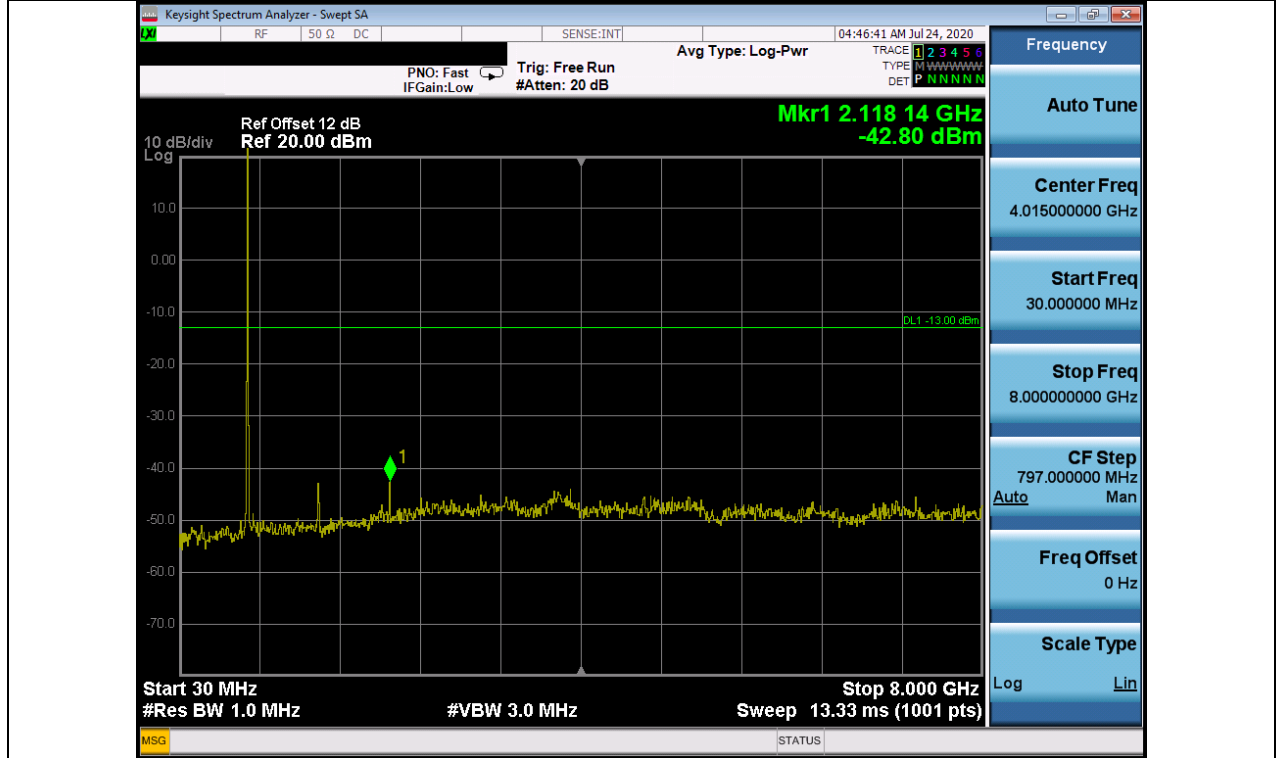

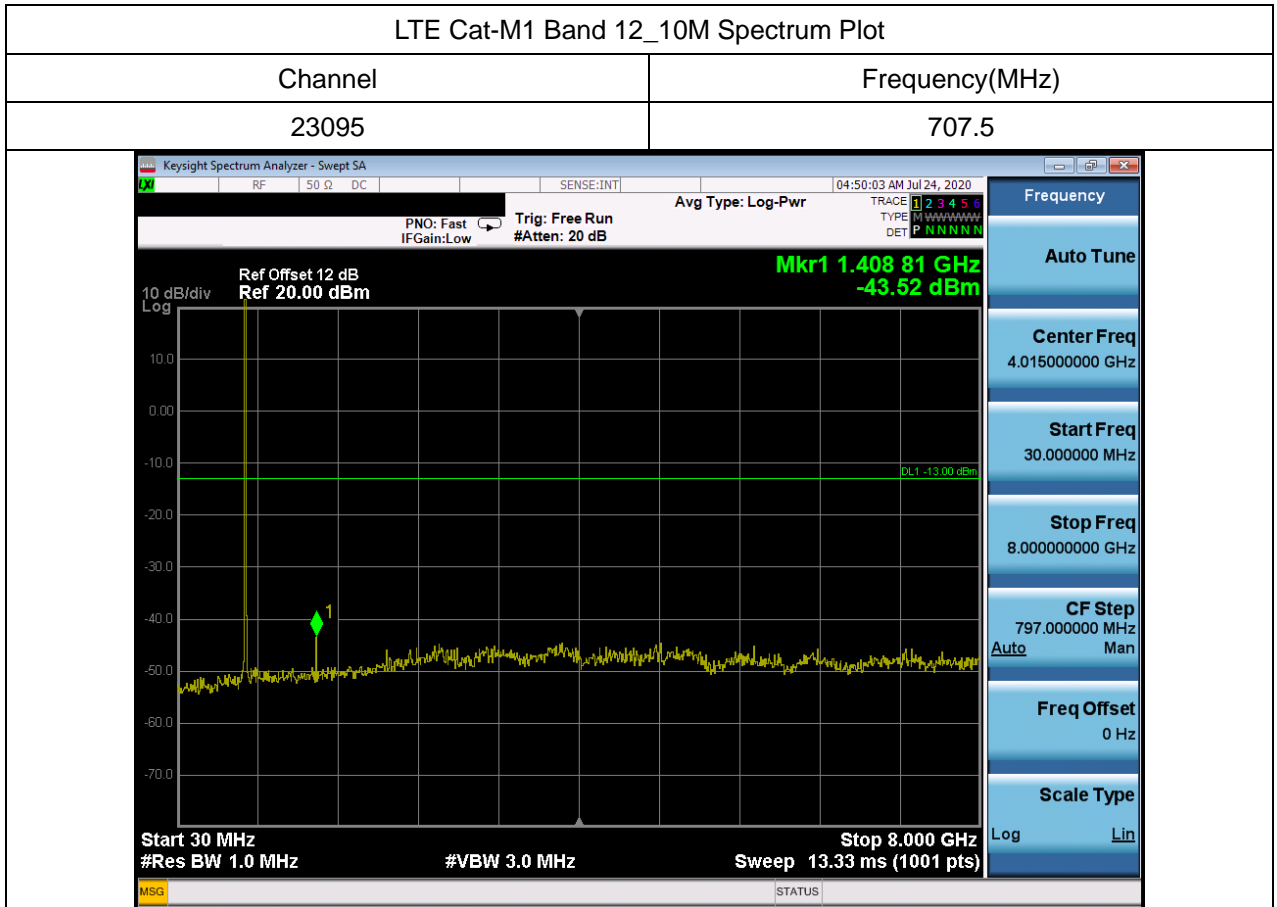

APPENDIX E - RADIATED SPURIOUS EMISSIONS (30MHZ TO 1GHZ)

Test Mode	LTE Cat-M1 Band 4	Test Date	2020/7/24
-	-	Polarization	Vertical

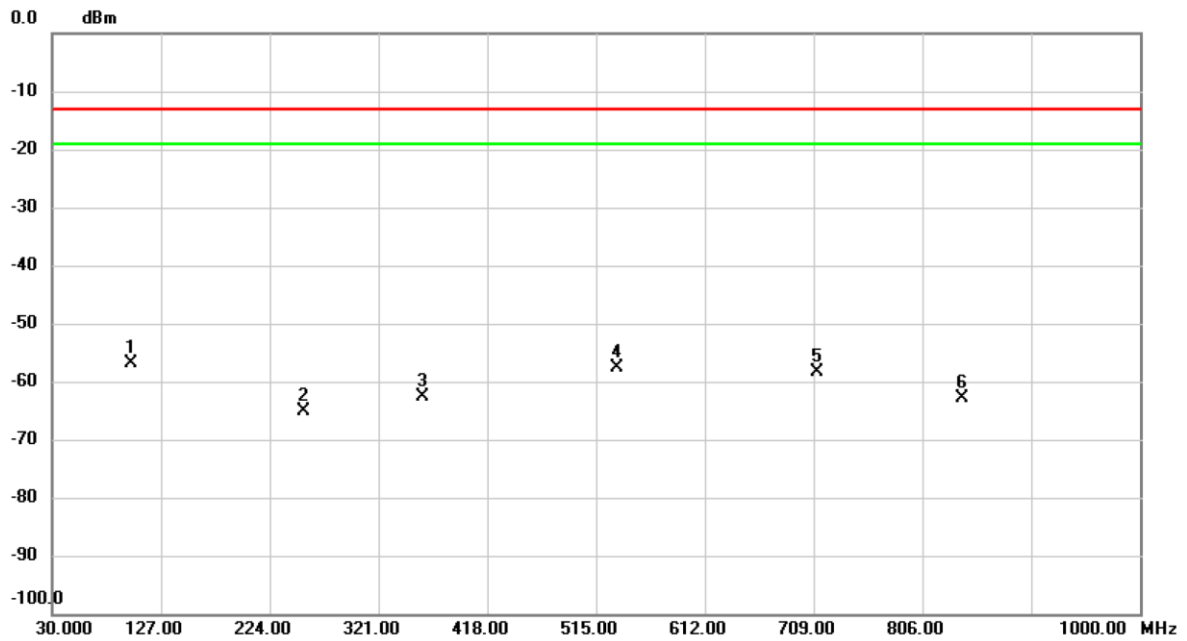

No.	Mk.	Freq. MHz	Reading Level dBm	Correct Factor dB	Measure- ment dBm	Limit dBm	Over dB	Detector	Comment
1	*	100.8100	-57.57	0.75	-56.82	-13.00	-43.82	peak	
2		254.0700	-72.86	7.72	-65.14	-13.00	-52.14	peak	
3		359.8000	-69.12	6.40	-62.72	-13.00	-49.72	peak	
4		533.4300	-66.07	8.36	-57.71	-13.00	-44.71	peak	
5		711.9100	-70.86	12.40	-58.46	-13.00	-45.46	peak	
6		841.8900	-72.65	9.69	-62.96	-13.00	-49.96	peak	

REMARKS:

- (1) Measurement Value = Reading Level + Correct Factor.
- (2) Margin Level = Measurement Value - Limit Value.

Test Mode	LTE Cat-M1 Band 4	Test Date	2020/7/24
-	-	Polarization	Horizontal

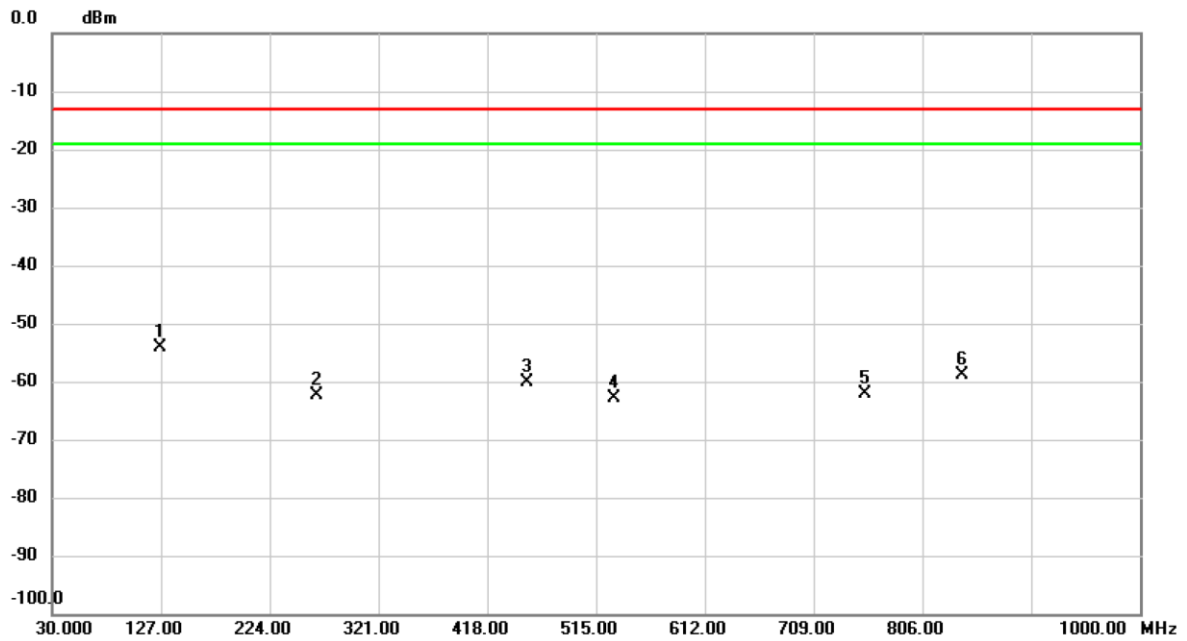

No.	Mk.	Freq. MHz	Reading Level dBm	Correct Factor dB	Measure- ment dBm	Limit dBm	Over dB	Detector	Comment
1	*	126.0300	-56.91	2.73	-54.18	-13.00	-41.18	peak	
2		265.7100	-62.17	-0.21	-62.38	-13.00	-49.38	peak	
3		453.8900	-75.13	15.12	-60.01	-13.00	-47.01	peak	
4		531.4900	-72.98	10.09	-62.89	-13.00	-49.89	peak	
5		754.5900	-75.15	12.98	-62.17	-13.00	-49.17	peak	
6		840.9200	-75.06	16.20	-58.86	-13.00	-45.86	peak	

REMARKS:

- (1) Measurement Value = Reading Level + Correct Factor.
- (2) Margin Level = Measurement Value - Limit Value.

Test Mode	LTE Cat-M1 Band 12	Test Date	2020/7/24
-	-	Polarization	Vertical

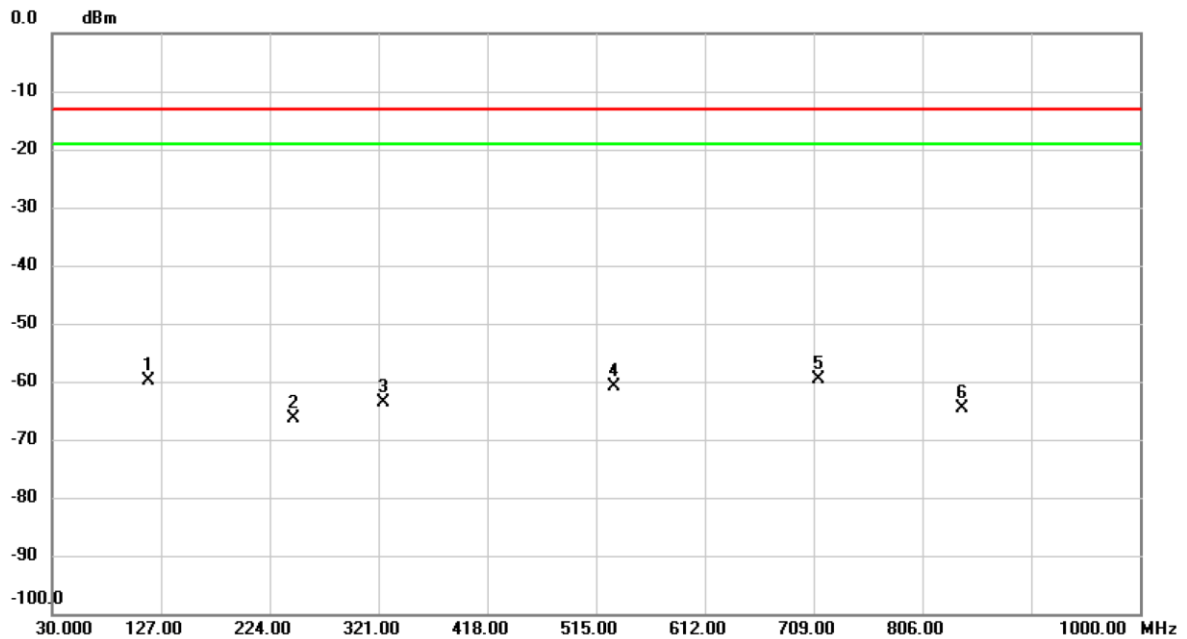

No.	Mk.	Freq. (MHz)	Reading Level (dBm)	Correct Factor (dB)	Measurement (dBm)	Limit (dBm)	Over (dB)	Detector	Comment
1		115.3600	-59.55	-0.36	-59.91	-13.00	-46.91	peak	
2		245.3400	-73.90	7.54	-66.36	-13.00	-53.36	peak	
3		324.8800	-70.69	7.13	-63.56	-13.00	-50.56	peak	
4		531.4900	-69.08	8.28	-60.80	-13.00	-47.80	peak	
5	*	713.8500	-71.86	12.36	-59.50	-13.00	-46.50	peak	
6		841.8900	-74.36	9.69	-64.67	-13.00	-51.67	peak	

REMARKS:

- (1) Measurement Value = Reading Level + Correct Factor.
- (2) Margin Level = Measurement Value - Limit Value.

Test Mode	LTE Cat-M1 Band 12	Test Date	2020/7/24
-	-	Polarization	Horizontal

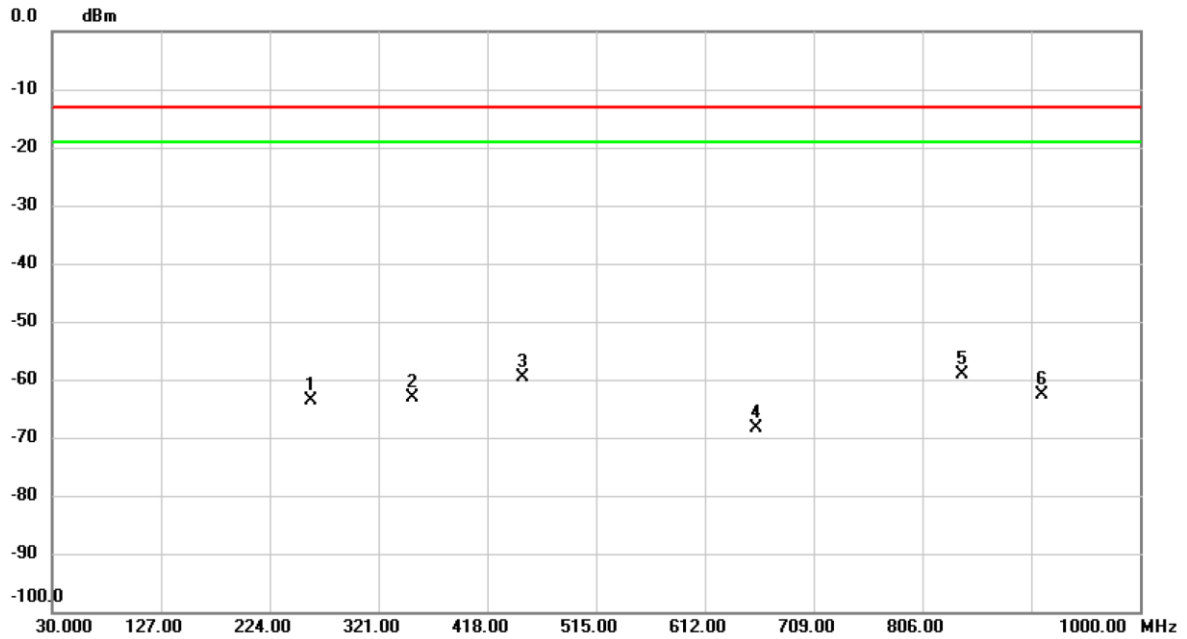

No.	Mk.	Freq. (MHz)	Reading Level (dBm)	Correct Factor (dB)	Measurement (dBm)	Limit (dBm)	Over (dB)	Detector	Comment
1		260.8600	-63.22	-0.36	-63.58	-13.00	-50.58	peak	
2		351.0700	-67.40	4.19	-63.21	-13.00	-50.21	peak	
3		449.0400	-74.82	15.23	-59.59	-13.00	-46.59	peak	
4		657.5900	-75.93	7.49	-68.44	-13.00	-55.44	peak	
5	*	841.8900	-75.44	16.22	-59.22	-13.00	-46.22	peak	
6		912.7000	-77.67	14.99	-62.68	-13.00	-49.68	peak	

REMARKS:

- (1) Measurement Value = Reading Level + Correct Factor.
- (2) Margin Level = Measurement Value - Limit Value.

Spot check test:

Test Mode	LTE Cat-M1 Band 4	Test Date	2021/12/3
Test Channel	20175	Polarization	Vertical
Temp	20°C	Hum.	65%

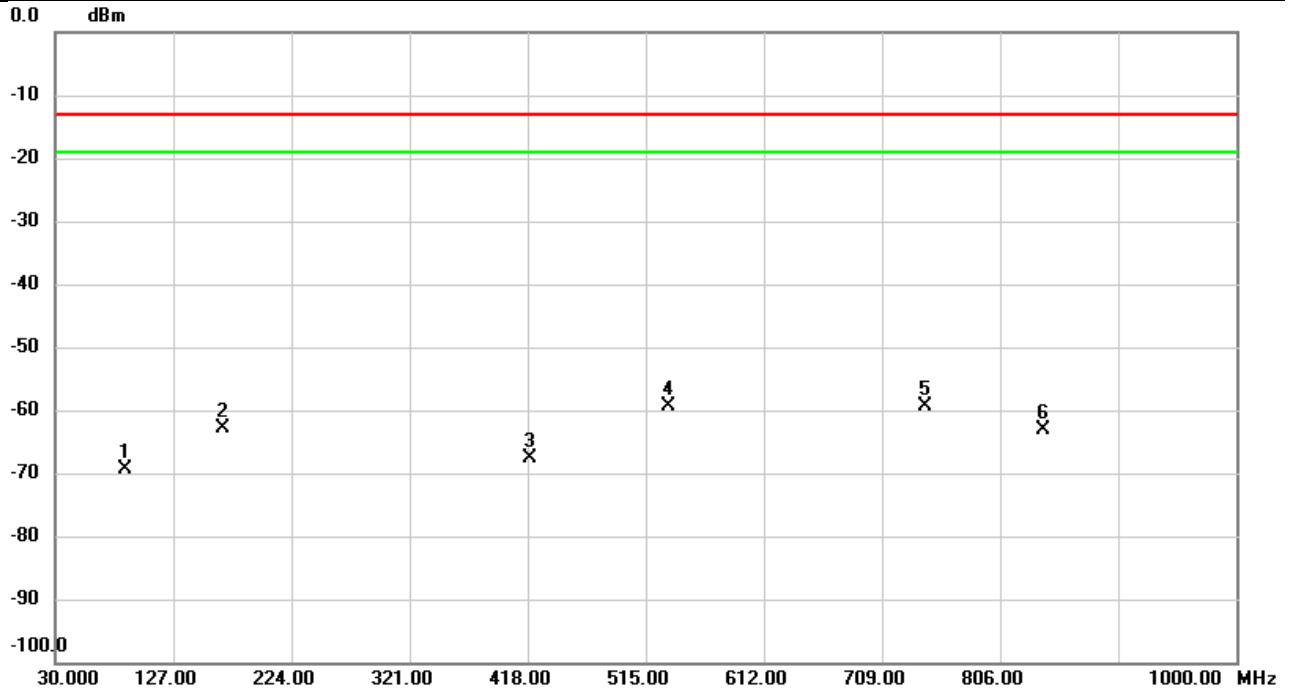

No.	Mk.	Freq. MHz	Reading Level dBm	Correct Factor dB	Measure- ment dBm	Limit dBm	Over dB	Detector	Comment
1		87.5857	-67.45	-1.89	-69.34	-13.00	-56.34	peak	
2		167.9987	-65.84	3.01	-62.83	-13.00	-49.83	peak	
3		419.3257	-70.22	2.58	-67.64	-13.00	-54.64	peak	
4	*	533.2037	-66.67	7.39	-59.28	-13.00	-46.28	peak	
5		743.9847	-70.73	11.40	-59.33	-13.00	-46.33	peak	
6		841.4050	-72.37	9.17	-63.20	-13.00	-50.20	peak	

REMARKS:

- (1) Measurement Value = Reading Level + Correct Factor.
- (2) Margin Level = Measurement Value - Limit Value.

Test Mode	LTE Cat-M1 Band 4	Test Date	2021/12/3
Test Channel	20175	Polarization	Horizontal
Temp	20°C	Hum.	65%

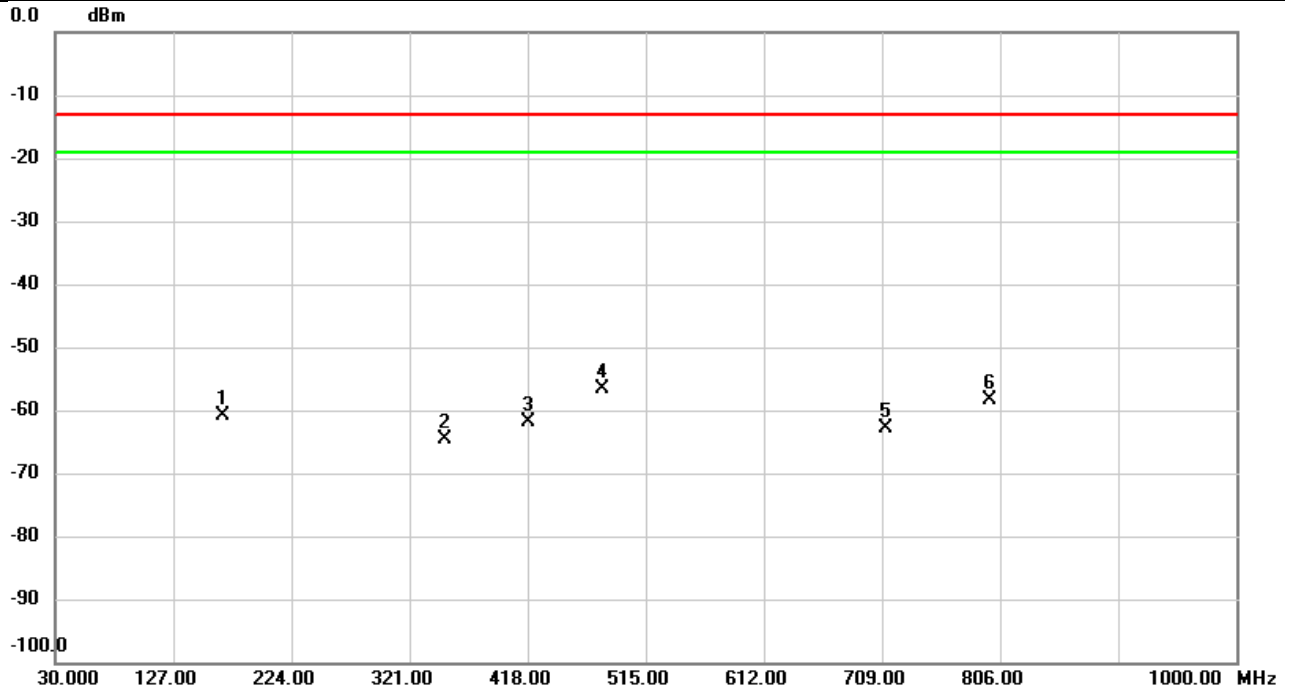

No.	Mk.	Freq. MHz	Reading Level dBm	Correct Factor dB	Measure- ment dBm	Limit dBm	Over dB	Detector	Comment
1		168.0310	-63.15	2.25	-60.90	-13.00	-47.90	peak	
2		350.3910	-68.83	4.10	-64.73	-13.00	-51.73	peak	
3		418.7112	-70.41	8.49	-61.92	-13.00	-48.92	peak	
4	*	480.0153	-68.31	11.71	-56.60	-13.00	-43.60	peak	
5		711.6836	-73.14	10.17	-62.97	-13.00	-49.97	peak	
6		797.4316	-73.51	15.07	-58.44	-13.00	-45.44	peak	

REMARKS:

- (1) Measurement Value = Reading Level + Correct Factor.
- (2) Margin Level = Measurement Value - Limit Value.

Test Mode	LTE Cat-M1 Band 12	Test Date	2021/12/3
Test Channel	23095	Polarization	Vertical
Temp	20°C	Hum.	65%

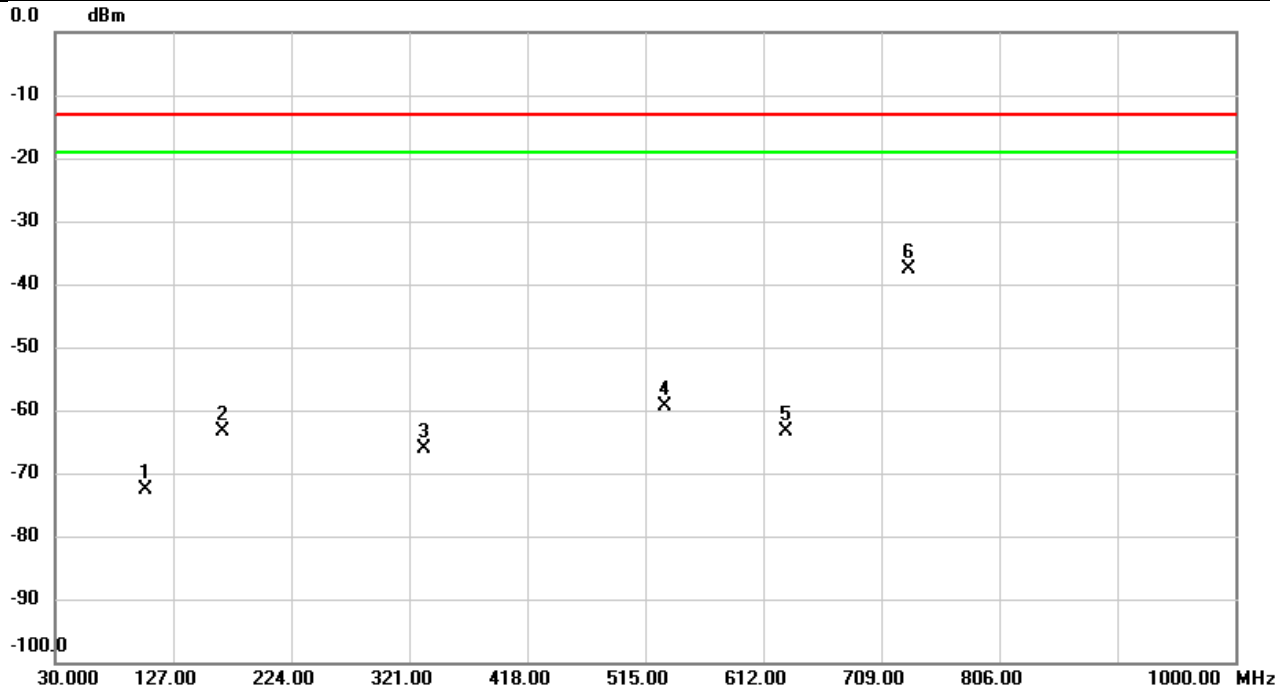

No.	Mk.	Freq. (MHz)	Reading Level (dBm)	Correct Factor (dB)	Measurement (dBm)	Limit (dBm)	Over (dB)	Detector	Comment
1		103.7523	-73.09	0.50	-72.59	-13.00	-59.59	peak	
2		167.9987	-66.31	3.01	-63.30	-13.00	-50.30	peak	
3		332.9633	-73.33	7.26	-66.07	-13.00	-53.07	peak	
4		531.3607	-66.68	7.20	-59.48	-13.00	-46.48	peak	
5		630.4300	-76.54	13.05	-63.49	-13.00	-50.49	peak	
6	*	732.1830	-49.35	11.84	-37.51	-13.00	-24.51	peak	

REMARKS:

- (1) Measurement Value = Reading Level + Correct Factor.
- (2) Margin Level = Measurement Value - Limit Value.

Test Mode	LTE Cat-M1 Band 12	Test Date	2021/12/3
Test Channel	23095	Polarization	Horizontal
Temp	20°C	Hum.	65%

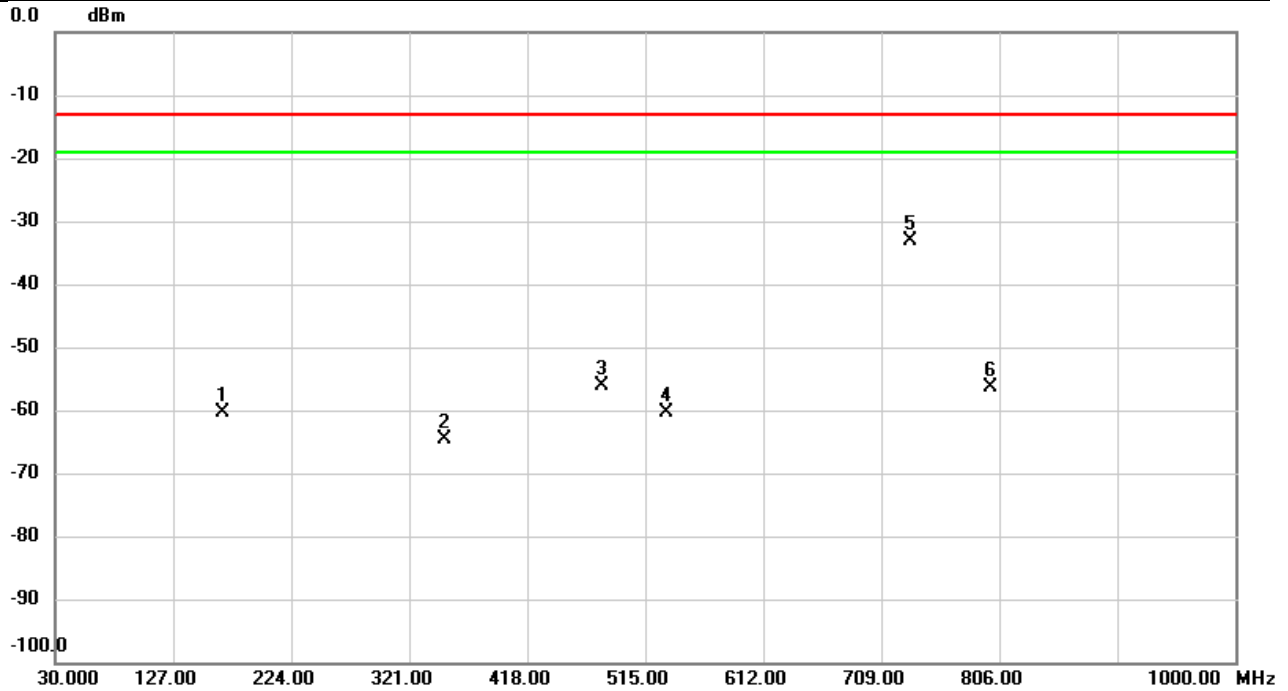

No.	Mk.	Freq. MHz	Reading Level dBm	Correct Factor dB	Measure- ment dBm	Limit dBm	Over dB	Detector	Comment
1		167.9986	-62.53	2.26	-60.27	-13.00	-47.27	peak	
2		350.5850	-68.65	4.10	-64.55	-13.00	-51.55	peak	
3		480.0153	-67.86	11.71	-56.15	-13.00	-43.15	peak	
4		532.3953	-69.75	9.48	-60.27	-13.00	-47.27	peak	
5	*	732.7003	-44.62	11.59	-33.03	-13.00	-20.03	peak	
6		798.8866	-71.56	15.14	-56.42	-13.00	-43.42	peak	

REMARKS:

- (1) Measurement Value = Reading Level + Correct Factor.
- (2) Margin Level = Measurement Value - Limit Value.

APPENDIX F - RADIATED SPURIOUS EMISSIONS (ABOVE 1GHZ)

Test Mode	LTE Cat-M1 Band 4	Test Date	2020/7/9
-	-	Polarization	Vertical

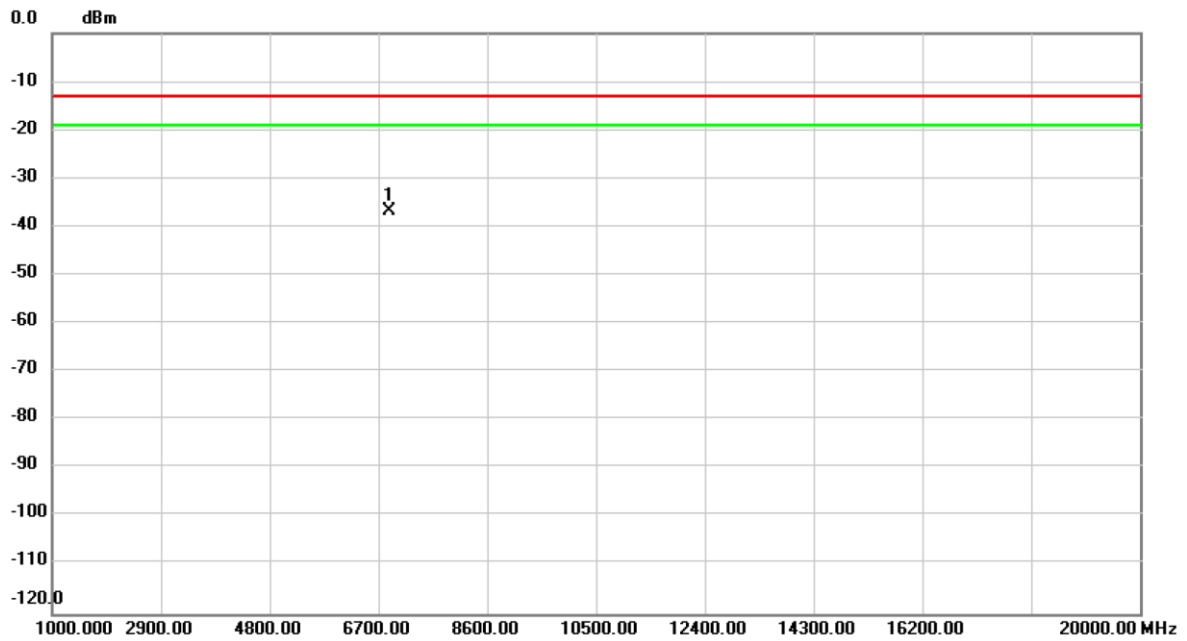

No.	Mk.	Freq.	Reading Level	Correct Factor	Measurement	Limit	Over	Detector	Comment
		MHz	dBm	dB	dBm	dBm	dB		
1	*	6897.540	-41.00	4.37	-36.63	-13.00	-23.63	peak	

REMARKS:

- (1) Measurement Value = Reading Level + Correct Factor.
- (2) Margin Level = Measurement Value - Limit Value.

Test Mode	LTE Cat-M1 Band 4	Test Date	2020/7/9
-	-	Polarization	Horizontal

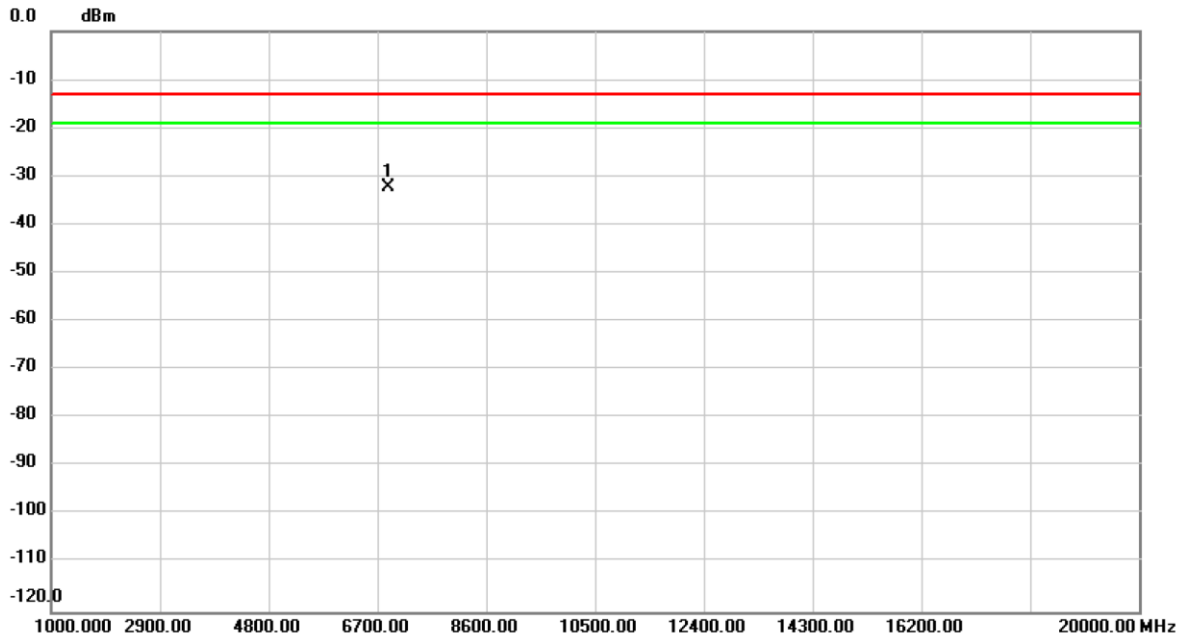

No.	Mk.	Freq.	Reading Level	Correct Factor	Measurement	Limit	Over	Detector	Comment
		MHz	dBm	dB	dBm	dBm	dB		
1	*	6897.480	-38.97	6.58	-32.39	-13.00	-19.39	peak	

REMARKS:

- (1) Measurement Value = Reading Level + Correct Factor.
- (2) Margin Level = Measurement Value - Limit Value.

Test Mode	LTE Cat-M1 Band 12	Test Date	2020/7/9
-	-	Polarization	Vertical

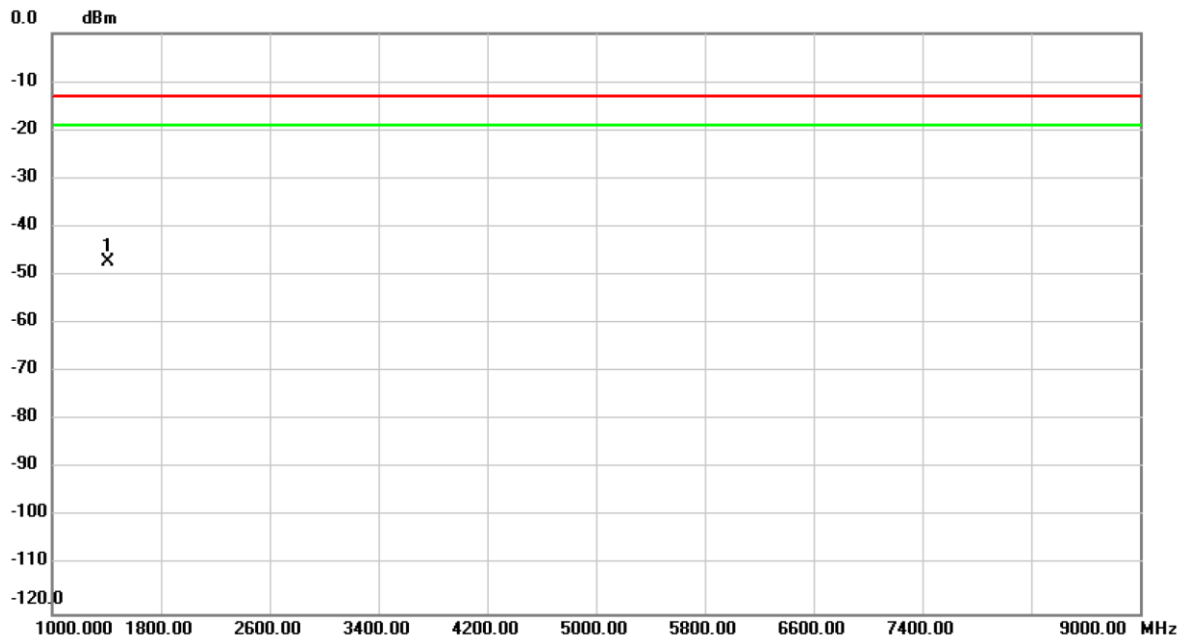

No.	Mk.	Freq.	Reading Level	Correct Factor	Measurement	Limit	Over	Detector	Comment
		MHz	dBm	dB	dBm	dBm	dB		
1	*	1407.160	-40.41	-6.98	-47.39	-13.00	-34.39	peak	

REMARKS:

- (1) Measurement Value = Reading Level + Correct Factor.
- (2) Margin Level = Measurement Value - Limit Value.

Test Mode	LTE Cat-M1 Band 12	Test Date	2020/7/9
-	-	Polarization	Horizontal

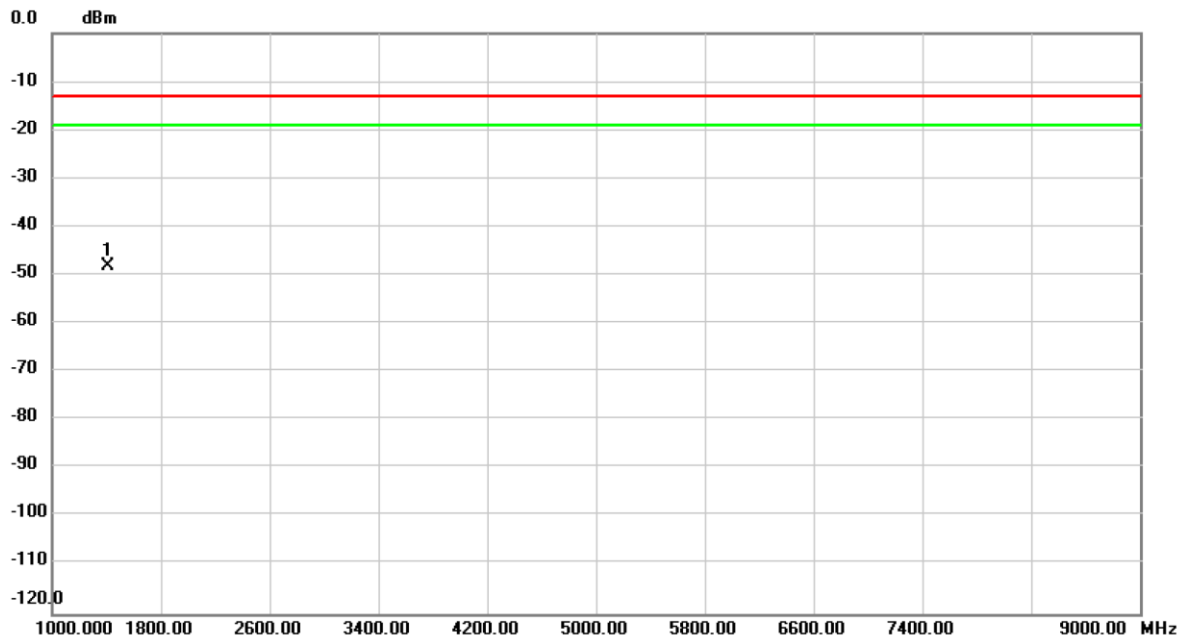

No.	Mk.	Freq.	Reading Level	Correct Factor	Measurement	Limit	Over	Detector	Comment
		MHz	dBm	dB	dBm	dBm	dB		
1	*	1407.660	-41.56	-6.71	-48.27	-13.00	-35.27	peak	

REMARKS:

- (1) Measurement Value = Reading Level + Correct Factor.
- (2) Margin Level = Measurement Value - Limit Value.

Spot check test:

Test Mode	LTE Cat-M1 Band 4	Test Date	2021/12/3
Test Channel	20175	Polarization	Vertical
Temp	20°C	Hum.	65%

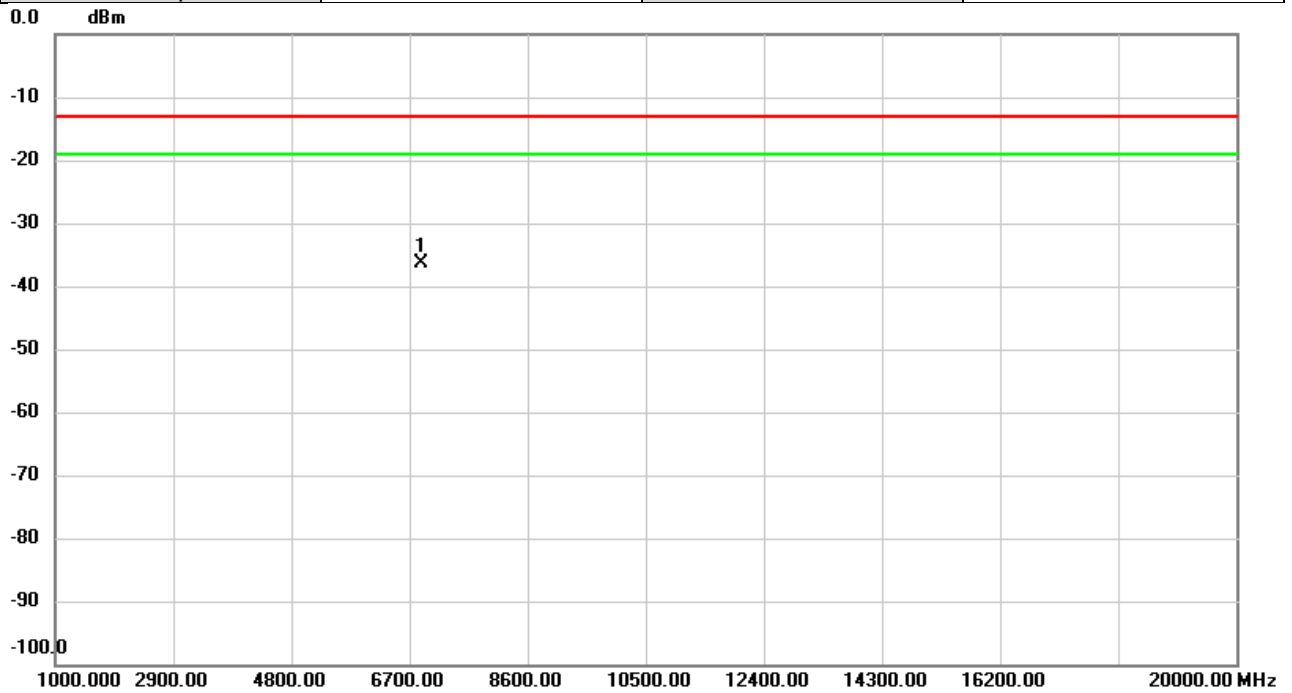

No.	Mk.	Freq.	Reading Level	Correct Factor	Measurement	Limit	Over	Detector	Comment
		MHz	dBm	dB	dBm	dBm	dB		
1	*	6895.700	-41.81	5.43	-36.38	-13.00	-23.38	peak	

REMARKS:

- (1) Measurement Value = Reading Level + Correct Factor.
- (2) Margin Level = Measurement Value - Limit Value.

Test Mode	LTE Cat-M1 Band 4	Test Date	2021/12/3
Test Channel	20175	Polarization	Horizontal
Temp	20°C	Hum.	65%

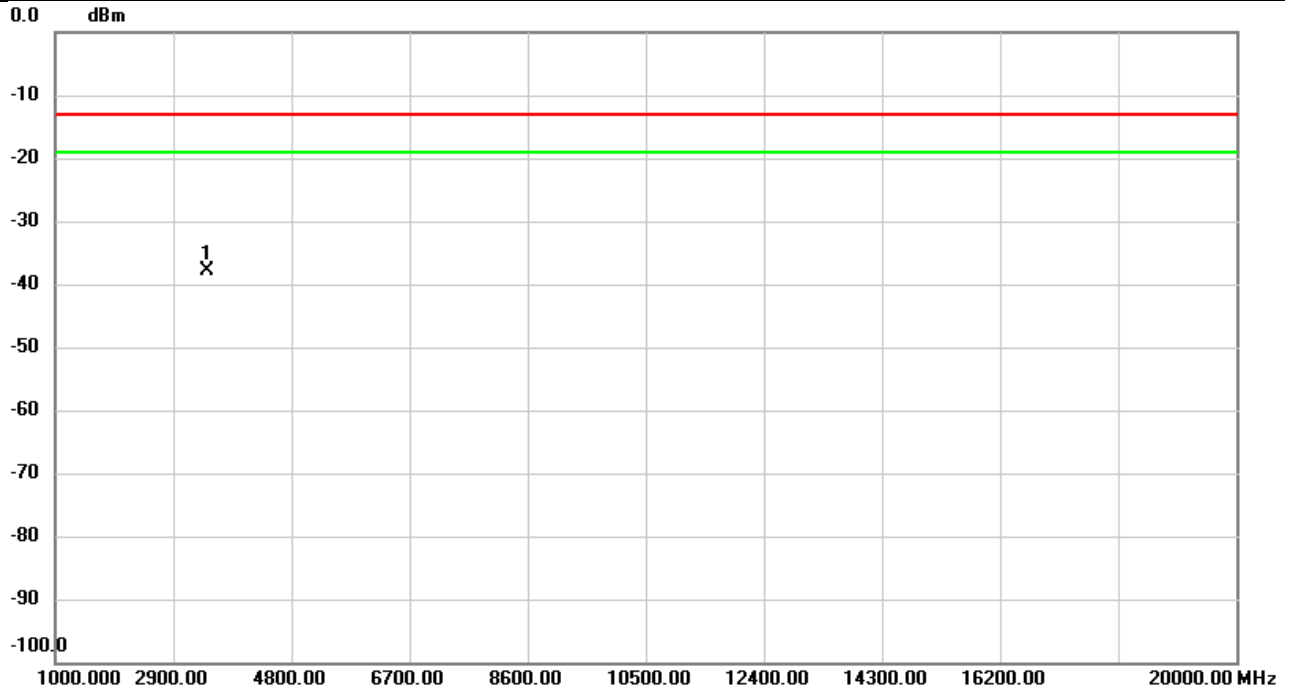

No.	Mk.	Freq.	Reading Level	Correct Factor	Measurement	Limit	Over	Detector	Comment
		MHz	dBm	dB	dBm	dBm	dB		
1	*	3447.833	-35.45	-2.37	-37.82	-13.00	-24.82	peak	

REMARKS:

- (1) Measurement Value = Reading Level + Correct Factor.
- (2) Margin Level = Measurement Value - Limit Value.

Test Mode	LTE Cat-M1 Band 12	Test Date	2021/12/3
Test Channel	23095	Polarization	Vertical
Temp	20°C	Hum.	65%

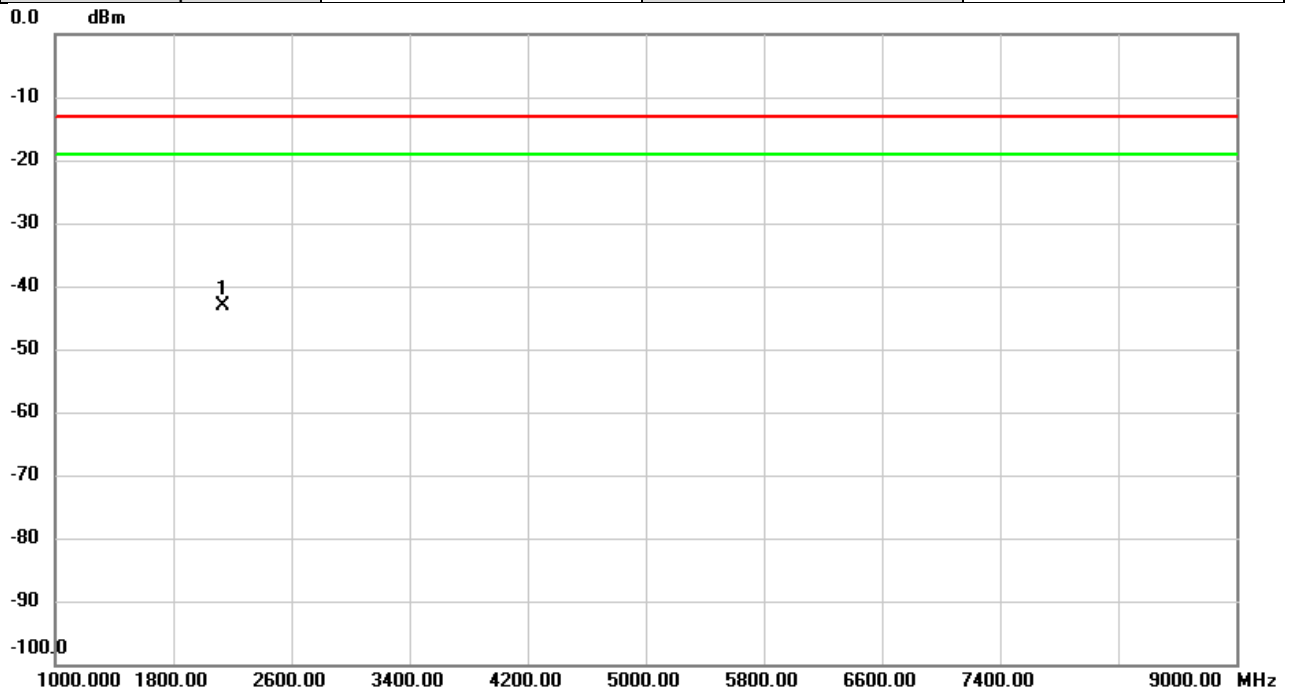

No.	Mk.	Freq.	Reading Level	Correct Factor	Measurement	Limit	Over	Detector	Comment
		MHz	dBm	dB	dBm	dBm	dB		
1	*	2130.933	-38.51	-4.69	-43.20	-13.00	-30.20	peak	

REMARKS:

- (1) Measurement Value = Reading Level + Correct Factor.
- (2) Margin Level = Measurement Value - Limit Value.

Test Mode	LTE Cat-M1 Band 12	Test Date	2021/12/3
Test Channel	23095	Polarization	Horizontal
Temp	20°C	Hum.	65%

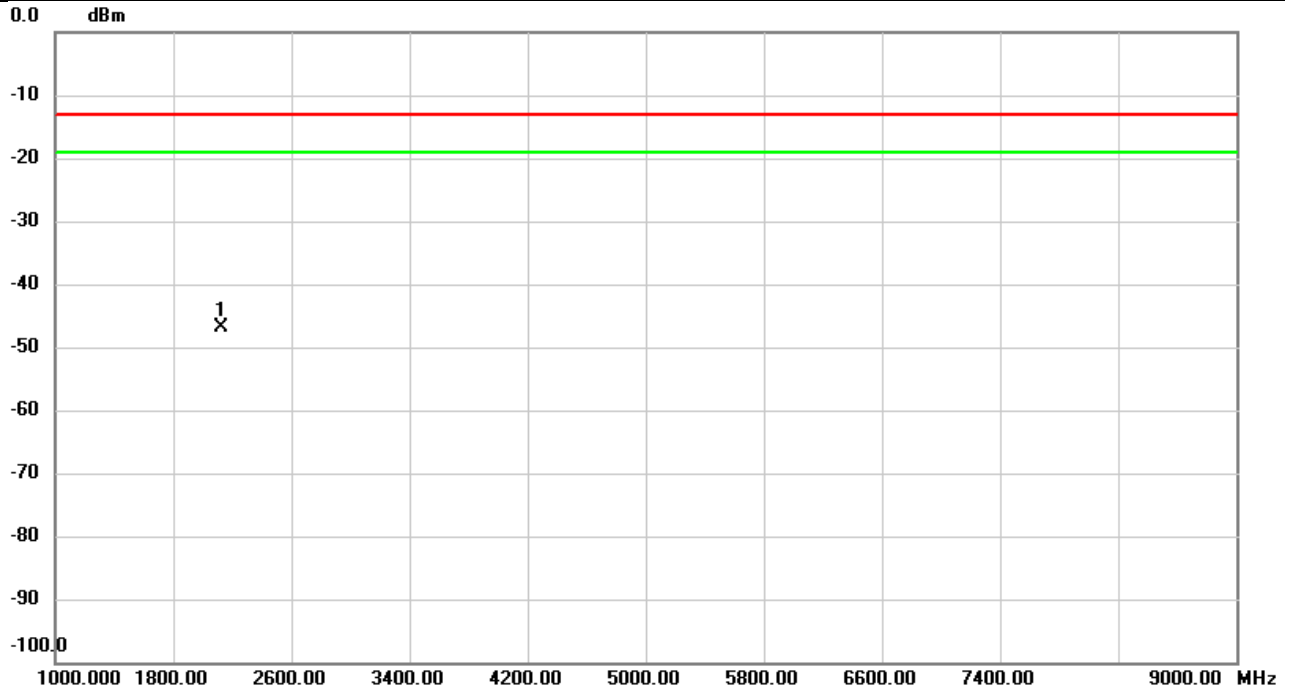

No.	Mk.	Freq.	Reading Level	Correct Factor	Measurement	Limit	Over	Detector	Comment
		MHz	dBm	dB	dBm	dBm	dB		
1	*	2128.267	-41.93	-4.98	-46.91	-13.00	-33.91	peak	

REMARKS:

- (1) Measurement Value = Reading Level + Correct Factor.
- (2) Margin Level = Measurement Value - Limit Value.

APPENDIX G - BAND EDGE