

FCC 47 CFR PART 15 SUBPART E

CERTIFICATION TEST REPORT

For

FIMI X8 SE Drone

MODEL No.: FMWRJ02A5

FCC ID: 2AG53FMWRJ02A5

Trade Mark: 

REPORT NO: ES190308959W

ISSUE DATE: April 8, 2019

Prepared for

BEIJING FIMI TECHNOLOGY LIMITED

1#Complex Building, Yongtaiyuan Jia, Qinghe, Haidian District, Beijing, China

Prepared by

EMTEK(SHENZHEN) CO., LTD.

Bldg 69, Majialong Industry Zone, Nanshan District,
Shenzhen, Guangdong, China

TEL: 86-755-26954280

FAX: 86-755-26954282

1 TEST RESULT CERTIFICATION

Applicant : BEIJING FIMI TECHNOLOGY LIMITED
 Address : 1#Complex Building, Yongtaiyuan Jia, Qinghe, Haidian District, Beijing, China
 Manufacturer : BEIJING FIMI TECHNOLOGY LIMITED
 Address : 1#Complex Building, Yongtaiyuan Jia, Qinghe, Haidian District, Beijing, China
 EUT : FIMI X8 SE Drone
 Model Name : FMWRJ02A5
 Trademark : 

Measurement Procedure Used:

APPLICABLE STANDARDS	
STANDARD	TEST RESULT
FCC 47 CFR Part 2, Subpart J FCC 47 CFR Part 15, Subpart E	PASS

The above equipment was tested by EMTEK (SHENZHEN) CO., LTD. The test data, data evaluation, test procedures, and equipment configurations shown in this report were made in accordance with the procedures given in ANSI C63.10 (2013) and the energy emitted by the sample EUT tested as described in this report is in compliance with the requirements of FCC Rules Part 2 and Part 15.407

The test results of this report relate only to the tested sample identified in this report.

Date of Test : March 7, 2019 to April 2, 2019

Prepared by: 
Sewen Guo /Editor

Reviewer: 
Joe Xia /Supervisor

Approve & Authorized Signer : 
Lisa Wang/Manager



TABLE OF CONTENTS

1 TEST RESULT CERTIFICATION 2

2 EUT TECHNICAL DESCRIPTION 4

3 SUMMARY OF TEST RESULT 5

4 TEST METHODOLOGY 6

4.1 GENERAL DESCRIPTION OF APPLIED STANDARDS 6

4.2 MEASUREMENT EQUIPMENT USED 6

4.3 DESCRIPTION OF TEST MODES 7

5 FACILITIES AND ACCREDITATIONS 8

5.1 FACILITIES..... 8

5.2 LABORATORY ACCREDITATIONS AND LISTINGS 8

6 TEST SYSTEM UNCERTAINTY 9

7 SETUP OF EQUIPMENT UNDER TEST 10

7.1 RADIO FREQUENCY TEST SETUP 10

7.2 RADIO FREQUENCY TEST SETUP 10

7.3 CONDUCTED EMISSION TEST SETUP 12

7.4 BLOCK DIAGRAM CONFIGURATION OF TEST SYSTEM..... 13

7.5 SUPPORT EQUIPMENT..... 13

8 TEST REQUIREMENTS 14

8.1 BANDWIDTH MEASUREMENT 14

8.2 MAXIMUM CONDUCTED OUTPUT POWER..... 20

8.3 MAXIMUM PEAK POWER DENSITY 22

8.4 FREQUENCY STABILITY 27

8.5 UNDESIRABLE RADIATED SPURIOUS EMISSION..... 29

8.6 POWER LINE CONDUCTED EMISSIONS..... 42

8.7 ANTENNA APPLICATION 45

2 EUT TECHNICAL DESCRIPTION

Characteristics	Description
Product	FIMI X8 SE Drone
Model Number	FMWRJ02A5
Wifi Type	<input type="checkbox"/> UNII-1: 5150MHz-5250MHz Band <input type="checkbox"/> UNII-2A: with 5250MHz-5350MHz Band <input type="checkbox"/> UNII-2C: with 5470MHz-5725MHz Band <input checked="" type="checkbox"/> UNII-3 with 5725MHz-5850MHz Band
WLAN Supported	<input checked="" type="checkbox"/> 802.11a <input type="checkbox"/> 802.11n(20MHz channel bandwidth) <input type="checkbox"/> 802.11n(40MHz channel bandwidth) <input type="checkbox"/> 802.11ac(20MHz channel bandwidth) <input type="checkbox"/> 802.11ac(40MHz channel bandwidth) <input type="checkbox"/> 802.11ac(80MHz channel bandwidth)
Data Rate	<input checked="" type="checkbox"/> 802.11a:54/48/36/24/18/12/9/6Mbps <input type="checkbox"/> 802.11n:up to 600 Mbps <input type="checkbox"/> 802.11ac:up to 1.733Gbps
Modulation	<input checked="" type="checkbox"/> OFDM with BPSK/QPSK/16QAM/64QAM for 802.11a; <input type="checkbox"/> OFDM with BPSK/QPSK/16QAM/64QAM/256QAM for 802.11ac;
Frequency Range	<input checked="" type="checkbox"/> UNII-3 with 5725MHz-5850MHz Band <input checked="" type="checkbox"/> 5745-5825MHz for 802.11a; <input type="checkbox"/> 5745-5825MHz for 802.11n(HT20); <input type="checkbox"/> 5745-5825MHz for 802.11ac(HT20); <input type="checkbox"/> 5755-5795MHz for 802.11n(HT40); <input type="checkbox"/> 5755-5795MHz for 802.11ac(HT40); <input type="checkbox"/> 5775MHz for 802.11ac(HT80);
TCP Function	<input type="checkbox"/> Applicable <input checked="" type="checkbox"/> Not Applicable
Antenna Type	Internal Antenna
Antenna Gain	4.5 dBi
Transmit Power	22.88 dBm
Power supply	<input checked="" type="checkbox"/> DC 11.4V for adapter <input checked="" type="checkbox"/> Adapter : Model: CDQ02A5 Input: 100-240V,50/60Hz,1.5A Output: 13.05V,3A
Battery:	4500mAh/11.4V, lithium battery

Note: for more details, please refer to the User's manual of the EUT.

3 SUMMARY OF TEST RESULT

FCC Part Clause	Test Parameter	Verdict	Remark
15.407 (a) 15.407 (e)	99% , 6dB and 26dB Bandwidth	PASS	
15.407 (a)	Maximum Conducted Output Power	PASS	
15.407 (a)	Peak Power Spectral Density	PASS	
15.407 (b)	Radiated Spurious Emission	PASS	
15.407(g)	Frequency Stability	PASS	
15.407 (b)(6) 15.207	Power Line Conducted Emission	PASS	
15.407(a) 15.203	Antenna Application	PASS	
NOTE1: N/A (Not Applicable) NOTE2: According to FCC OET KDB 789033 D2 General UNII Test Procedures New Rules v02r01, In addition, the radiated test is also performed to ensure the emissions emanating from the device cabinet also comply with the applicable limits.			

RELATED SUBMITTAL(S) / GRANT(S):

This submittal(s) (test report) is intended for FCC ID: 2AG53FMWRJ02A5 filing to comply with Section 15.247 of the FCC Part 15, Subpart E Rules.

The minimum use distance of EUT is 20cm

4 TEST METHODOLOGY

4.1 GENERAL DESCRIPTION OF APPLIED STANDARDS

According to its specifications, the EUT must comply with the requirements of the following standards:
 FCC 47 CFR Part 2, Subpart J
 FCC 47 CFR Part 15, Subpart E
 FCC KDB 789033 D02 General U-NII Test Procedures New Rules v02r01

4.2 MEASUREMENT EQUIPMENT USED

4.2.1 Conducted Emission Test Equipment

EQUIPMENT TYPE	MFR	MODEL NUMBER	SERIAL NUMBER	LAST CAL.
Test Receiver	Rohde & Schwarz	ESCI	26115-010-0027	May 20, 2019
L.I.S.N.	Rohde & Schwarz	ENV216	101161	May 20, 2019
50Ω Coaxial Switch	Anritsu	MP59B	6100175589	May 21, 2019
Voltage Probe	Rohde & Schwarz	ESH2-Z3	100122	May 21, 2019
Pulse Limiter	Rohde & Schwarz	ESH3-Z2	100006	May 20, 2019
I.S.N	Teseq GmbH	ISN T800	30327	May 21, 2019

4.2.2 Radiated Emission Test Equipment

EQUIPMENT TYPE	MFR	MODEL NUMBER	SERIAL NUMBER	LAST CAL.
EMI Test Receiver	Rohde & Schwarz	ESU	1302.6005.26	May 21, 2019
Pre-Amplifier	HP	8447F	2944A07999	May 20, 2019
Bilog Antenna	Schwarzbeck	VULB9163	142	May 20, 2019
Loop Antenna	ARA	PLA-1030/B	1029	May 20, 2019
Horn Antenna	Schwarzbeck	BBHA 9170	BBHA9170399	May 21, 2019
Horn Antenna	Schwarzbeck	BBHA 9120	D143	May 20, 2019
Cable	Schwarzbeck	AK9513	ACRX1	May 21, 2019
Cable	Rosenberger	N/A	FP2RX2	May 21, 2019
Cable	Schwarzbeck	AK9513	CRPX1	May 21, 2019
Cable	Schwarzbeck	AK9513	CRRX2	May 21, 2019

4.2.3 Radio Frequency Test Equipment

EQUIPMENT TYPE	MFR	MODEL NUMBER	SERIAL NUMBER	LAST CAL.
Spectrum Analyzer	Agilent	E4407B	88156318	May 21, 2019
Signal Analyzer	Agilent	N9010A	My53470879	May 21, 2019
Power meter	Anritsu	ML2495A	0824006	May 21, 2019
Power sensor	Anritsu	MA2411B	0738172	May 21, 2019
Spectrum Analyzer	Agilent	E4407B	88156318	May 21, 2019

Remark: Each piece of equipment is scheduled for calibration once a year.

4.3 DESCRIPTION OF TEST MODES

The EUT has been tested under its typical operating condition.

The EUT configuration for testing is installed on RF field strength measurement to meet the Commissions requirement and operating in a manner which intends to maximize its emission characteristics in a continuous normal application.

The Transmitter was operated in the normal operating mode. The TX frequency was fixed which was for the purpose of the measurements.

Test of channel included the lowest and middle and highest frequency to perform the test, then record on this report.

Pre-defined engineering program for regulatory testing used to control the EUT for staying in continuous transmitting and receiving mode is programmed.

Wifi 5G with U-NII -3

Frequency and Channel list for 802.11a:

Channel	Frequency (MHz)	Channel	Frequency (MHz)	Channel	Frequency (MHz)
149	5745	157	5785	165	5825
153	5765	161	5805		

Test Frequency and Channel for 802.11a:

Lowest Frequency		Middle Frequency		Highest Frequency	
Channel	Frequency (MHz)	Channel	Frequency (MHz)	Channel	Frequency (MHz)
149	5745	157	5785	165	5825

5 FACILITIES AND ACCREDITATIONS

5.1 FACILITIES

All measurement facilities used to collect the measurement data are located at

Bldg 69, Majialong Industry Zone District, Nanshan District, Shenzhen, China

The sites are constructed in conformance with the requirements of ANSI C63.7, ANSI C63.10 and CISPR Publication 22.

5.2 LABORATORY ACCREDITATIONS AND LISTINGS

Site Description

EMC Lab.

: Accredited by CNAS,2016.10.24

The certificate is valid until 2022.10.28

The Laboratory has been assessed and proved to be in compliance with CNAS-CL01:2006 (identical to ISO/IEC 17025:2005)

The Certificate Registration Number is L2291.

Accredited by TUV Rheinland Shenzhen 2016.05.19

The Laboratory has been assessed according to the requirements ISO/IEC 17025.

Accredited by FCC, August 06, 2018

The certificate is valid until August 07, 2020

Designation Number: CN1204

Test Firm Registration Number: 882943

Accredited by Industry Canada, November 09, 2018

The Conformity Assessment Body Identifier is CN0008.

Name of Firm

: EMTEK(SHENZHEN) CO., LTD.

Site Location

: Bldg 69, Majialong Industry Zone,
Nanshan District, Shenzhen, Guangdong, China

6 TEST SYSTEM UNCERTAINTY

The following measurement uncertainty levels have been estimated for tests performed on the apparatus:

Parameter	Uncertainty
Radio Frequency	$\pm 1 \times 10^{-5}$
Maximum Peak Output Power Test	$\pm 1.0\text{dB}$
Conducted Emissions Test	$\pm 2.0\text{dB}$
Radiated Emission Test	$\pm 2.0\text{dB}$
Power Density	$\pm 2.0\text{dB}$
Occupied Bandwidth Test	$\pm 1.0\text{dB}$
Band Edge Test	$\pm 3\text{dB}$
All emission, radiated	$\pm 3\text{dB}$
Antenna Port Emission	$\pm 3\text{dB}$
Temperature	$\pm 0.5^\circ\text{C}$
Humidity	$\pm 3\%$

Measurement Uncertainty for a level of Confidence of 95%

7 SETUP OF EQUIPMENT UNDER TEST

7.1 RADIO FREQUENCY TEST SETUP

The WLAN component's antenna ports(s) of the EUT are connected to the measurement instrument per an appropriate attenuator. The EUT is controlled by PC/software to emit the specified signals for the purpose of measurements.

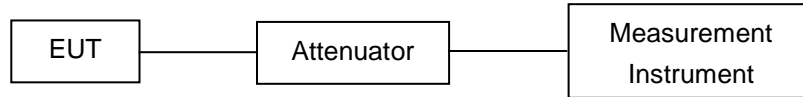

7.2 RADIO FREQUENCY TEST SETUP

The test site semi-anechoic chamber has met the requirement of NSA tolerance 4 dB according to the standards: ANSI C63.10. The test distance is 3m. The setup is according to the requirements in Section 13.1.4.1 of ANSI C63.10-2013 and CAN/CSA-CEI/IEC CISPR 22.

Below 30MHz:

The EUT is placed on a turntable 0.8 meters above the ground in the chamber, 3 meter away from the antenna (loop antenna). The Antenna should be positioned with its plane vertical at the specified distance from the EUT and rotated about its vertical axis for maximum response at each azimuth about the EUT. The center of the loop shall be 1 m above the ground. For certain applications, the loop antenna plane may also need to be positioned horizontally at the specified distance from the EUT.

Above 30MHz:

The EUT is placed on a turntable 0.8 meters above the ground in the chamber, 3 meter away from the antenna. The maximal emission value is acquired by adjusting the antenna height, polarisation and turntable azimuth. Normally, the height range of antenna is 1 m to 4 m, the azimuth range of turntable is 0° to 360°, and the receive antenna has two polarizations Vertical (V) and Horizontal (H).

Above 1GHz:

(Note: the FCC's permission to use 1.5m as an alternative per TCBC Conf call of Dec. 2, 2014.)

The EUT is placed on a turntable 1.5 meters above the ground in the chamber, 3 meter away from the antenna. The maximal emission value is acquired by adjusting the antenna height, polarisation and turntable azimuth. Normally, the height range of antenna is 1 m to 4 m, the azimuth range of turntable is 0° to 360°, and the receive antenna has two polarizations Vertical (V) and Horizontal (H).

(a) Radiated Emission Test Set-Up, Frequency Below 30MHz

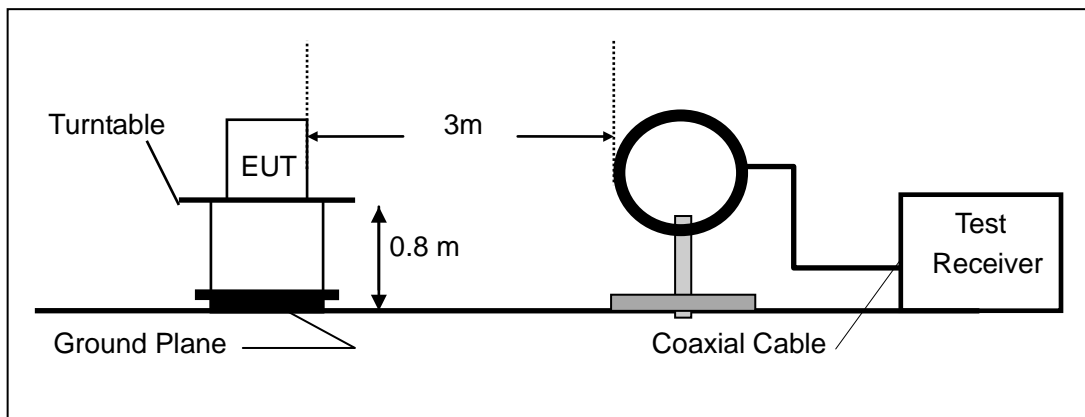

(b) Radiated Emission Test Set-Up, Frequency Below 1000MHz

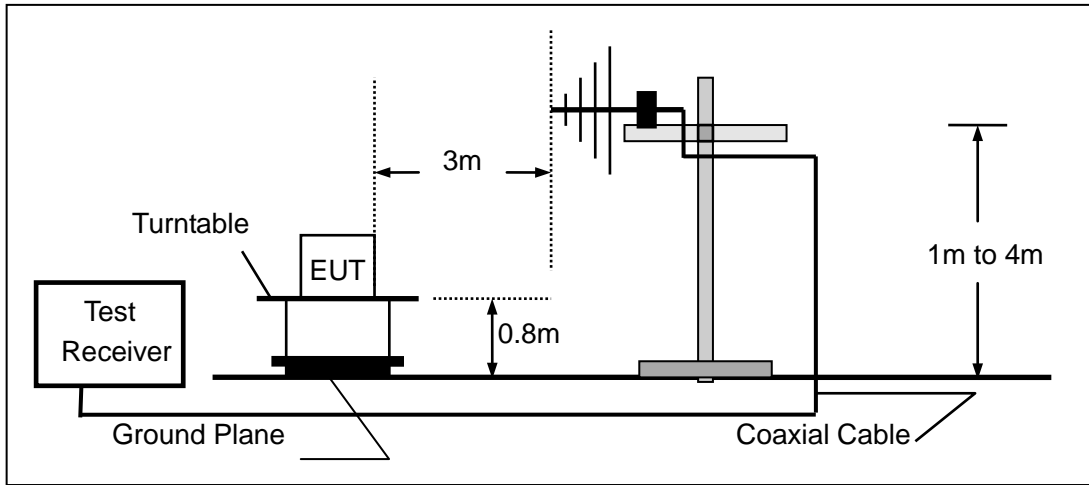

(c) Radiated Emission Test Set-Up, Frequency above 1000MHz

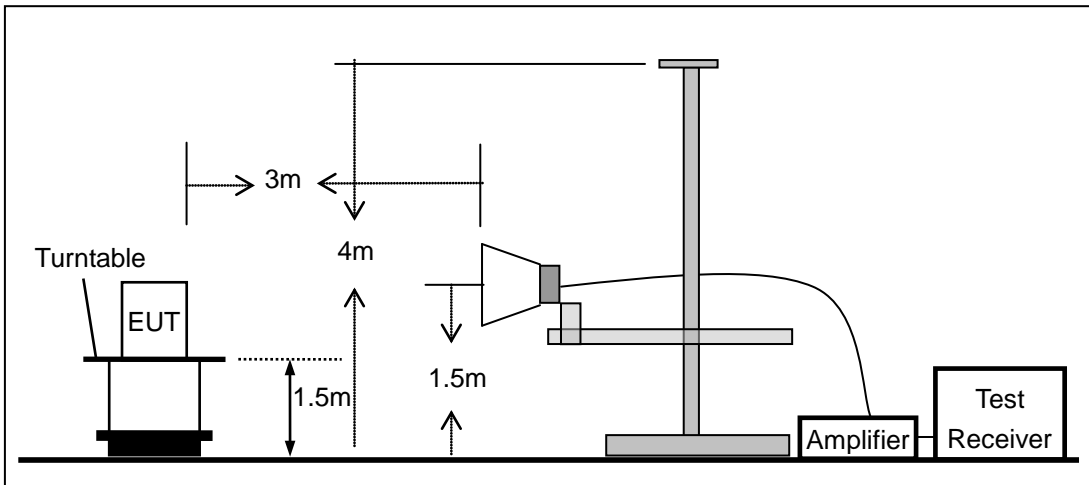

7.3 CONDUCTED EMISSION TEST SETUP

The mains cable of the EUT (maybe per AC/DC Adapter) must be connected to LISN. The LISN shall be placed 0.8 m from the boundary of EUT and bonded to a ground reference plane for LISN mounted on top of the ground reference plane. This distance is between the closest points of the LISN and the EUT. All other units of the EUT and associated equipment shall be at least 0.8m from the LISN.

Ground connections, where required for safety purposes, shall be connected to the reference ground point of the LISN and, where not otherwise provided or specified by the manufacturer, shall be of same length as the mains cable and run parallel to the mains connection at a separation distance of not more than 0.1 m.

According to the requirements in Section 13.1.4.1 of ANSI C63.10-2013 Conducted emissions from the EUT measured in the frequency range between 0.15 MHz and 30 MHz using CISPR Quasi-Peak and average detector mode.

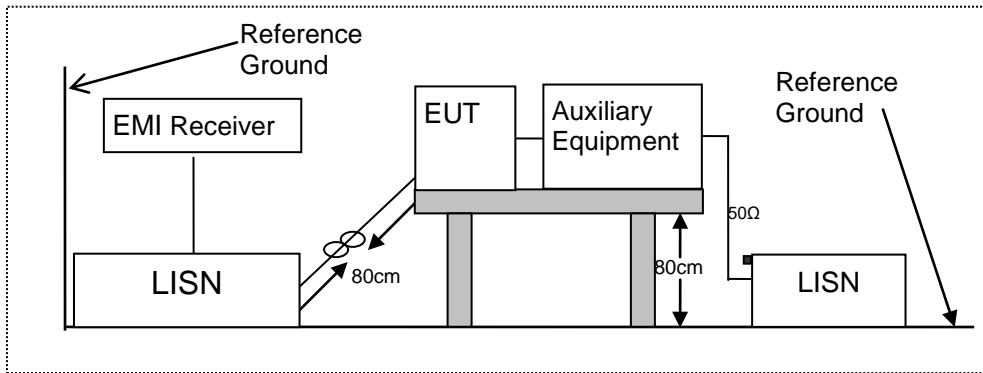

7.4 BLOCK DIAGRAM CONFIGURATION OF TEST SYSTEM

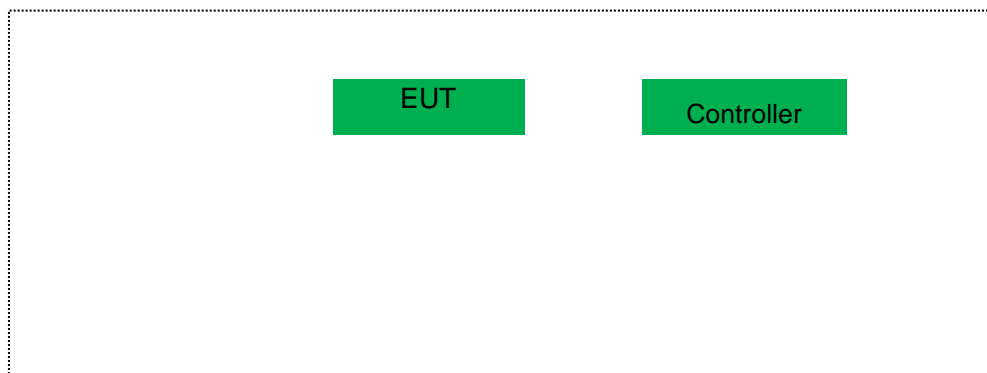

7.5 SUPPORT EQUIPMENT

EUT Cable List and Details			
Cable Description	Length (m)	Shielded/Unshielded	With / Without Ferrite
AC cable	1.5	Unshielded	Without Ferrite
DC cable	1.0	Unshielded	Without Ferrite
USB cable	0.1	Shielded	Without Ferrite

Auxiliary Cable List and Details			
Cable Description	Length (m)	Shielded/Unshielded	With / Without Ferrite
/	/	/	/

Auxiliary Equipment List and Details			
Description	Manufacturer	Model	Serial Number
Notebook	acer	ZR1	LXTECOCO76643158 372500
iPhone 5C	Apple	A1526	CE, FCC ID

Notes:

- 1.All the equipment/cables were placed in the worst-case configuration to maximize the emission during the test.
- 2.Grounding was established in accordance with the manufacturer's requirements and conditions for the intended use.

8 TEST REQUIREMENTS

8.1 BANDWIDTH MEASUREMENT

8.1.1 Applicable Standard

According to FCC Part 15.407(a)(1) for UNII Band I
According to FCC Part 15.407(a)(2) for UNII Band II-A and UNII Band II-C
According to FCC Part 15.407(a)(3) for UNII Band III
According to FCC Part 15.407(e) for UNII Band III
According to 789033 D02 Section II(C)
According to 789033 D02 Section II(D)

8.1.2 Conformance Limit

(1) For the band 5.15-5.25 GHz.

(iv) For mobile and portable client devices in the 5.15-5.25 GHz band, the maximum conducted output power over the frequency band of operation shall not exceed 250 mW provided the maximum antenna gain does not exceed 6 dBi. In addition, the maximum power spectral density shall not exceed 11 dBm in any 1 megahertz band. If transmitting antennas of directional gain greater than 6 dBi are used, both the maximum conducted output power and the maximum power spectral density shall be reduced by the amount in dB that the directional gain of the antenna exceeds 6 dBi.

(2) For the 5.25-5.35 GHz and 5.47-5.725 GHz bands, the maximum conducted output power over the frequency bands of operation shall not exceed the lesser of 250 mW or 11 dBm + 10 log B, where B is the 26 dB emission bandwidth in megahertz. In addition, the maximum power spectral density shall not exceed 11 dBm in any 1 megahertz band. If transmitting antennas of directional gain greater than 6 dBi are used, both the maximum conducted output power and the maximum power spectral density shall be reduced by the amount in dB that the directional gain of the antenna exceeds 6 dBi.

(3) For the band 5.725-5.85 GHz, the maximum conducted output power over the frequency band of operation shall not exceed 1 W. In addition, the maximum power spectral density shall not exceed 30 dBm in any 500-kHz band. If transmitting antennas of directional gain greater than 6 dBi are used, both the maximum conducted output power and the maximum power spectral density shall be reduced by the amount in dB that the directional gain of the antenna exceeds 6 dBi. However, fixed point-to-point U-NII devices operating in this band may employ transmitting antennas with directional gain greater than 6 dBi without any corresponding reduction in transmitter conducted power. Fixed, point-to-point operations exclude the use of point-to-multipoint systems, omnidirectional applications, and multiple collocated transmitters transmitting the same information. The operator of the U-NII device, or if the equipment is professionally installed, the installer, is responsible for ensuring that systems employing high gain directional antennas are used exclusively for fixed, point-to-point operations.

(e) Within the 5.725-5.85 GHz band, the minimum 6 dB bandwidth of U-NII devices shall be at least 500 kHz.

8.1.3 Test Configuration

Test according to clause 6.1 radio frequency test setup

8.1.4 Test Procedure

According to 789033 D02 v02r01 section C&D, the following is the measurement procedure.

1. Emission Bandwidth (EBW)

- a) Set RBW = approximately 1% of the emission bandwidth.
- b) Set the VBW > RBW.
- c) Detector = Peak.
- d) Trace mode = max hold.
- e) Measure the maximum width of the emission that is 26 dB down from the maximum of the emission. Compare this with the RBW setting of the analyzer. Readjust RBW and repeat measurement as needed until the RBW/EBW ratio is approximately 1%.

2. Minimum Emission Bandwidth for the band 5.725-5.85 GHz

Section 15.407(e) specifies the minimum 6 dB emission bandwidth of at least 500 KHz for the band 5.715-5.85 GHz. The following procedure shall be used for measuring this bandwidth:

- a) Set RBW = 100 kHz.
- b) Set the video bandwidth (VBW) $\geq 3 \times$ RBW.
- c) Detector = Peak.
- d) Trace mode = max hold.
- e) Sweep = auto couple.
- f) Allow the trace to stabilize.
- g) Measure the maximum width of the emission that is constrained by the frequencies associated with the two outermost amplitude points (upper and lower frequencies) that are attenuated by 6 dB relative to the maximum level measured in the fundamental emission.

Note: The automatic bandwidth measurement capability of a spectrum analyzer or EMI receiver may be employed if it implements the functionality described above.

D. 99 Percent Occupied Bandwidth

The 99-percent occupied bandwidth is the frequency bandwidth such that, below its lower and above its upper frequency limits, the mean powers are each equal to 0.5 % of the total mean power of the given emission. Measurement of the 99-percent occupied bandwidth is required only as a condition for using the optional band-edge measurement techniques described in section II.G.3.d). Measurements of 99-percent occupied bandwidth may also optionally be used in lieu of the EBW to 789033 D02 v01r02 General UNII Test Procedures New Rules v01 define the minimum frequency range over which the spectrum is integrated when measuring maximum conducted output power as described in section II.E. However, the EBW must be measured to determine bandwidth dependent limits on maximum conducted output power in accordance with 15.407(a).

The following procedure shall be used for measuring (99 %) power bandwidth:

1. Set center frequency to the nominal EUT channel center frequency.
2. Set span = 1.5 times to 5.0 times the OBW.
3. Set RBW = 1 % to 5 % of the OBW
4. Set VBW $\geq 3 \cdot$ RBW
5. Video averaging is not permitted. Where practical, a sample detection and single sweep mode shall be used. Otherwise, peak detection and max hold mode (until the trace stabilizes) shall be used.
6. Use the 99 % power bandwidth function of the instrument (if available).
7. If the instrument does not have a 99 % power bandwidth function, the trace data points are recovered and directly summed in power units. The recovered amplitude data points, beginning at the lowest frequency, are placed in a running sum until 0.5 % of the total is reached; that frequency is recorded as the lower frequency. The process is repeated until 99.5 % of the total is reached; that frequency is recorded as the upper frequency. The 99% occupied bandwidth is the difference between these two frequencies.

8.1.5 Test Results

5725-5850MHz

Test Mode	Test Channel MHz		6 dB Bandwidth MHz	99% Bandwidth MHz	Limit kHz
802.11a	CH149	5745	15.96	16.895	≥500
	CH157	5785	16.33	16.904	≥500
	CH165	5825	16.08	16.887	≥500

6 dB Bandwidth

Test Model

802.11a

U-NII - 3

Frequency(MHz)

5745

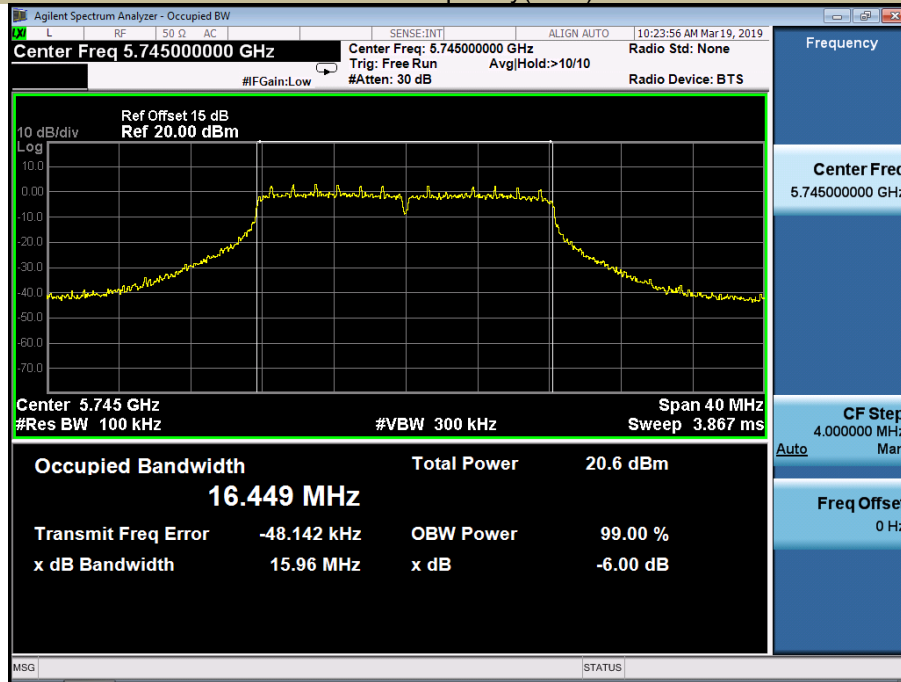

6 dB Bandwidth

Test Model

802.11a

U-NII - 3

Frequency(MHz)

5785

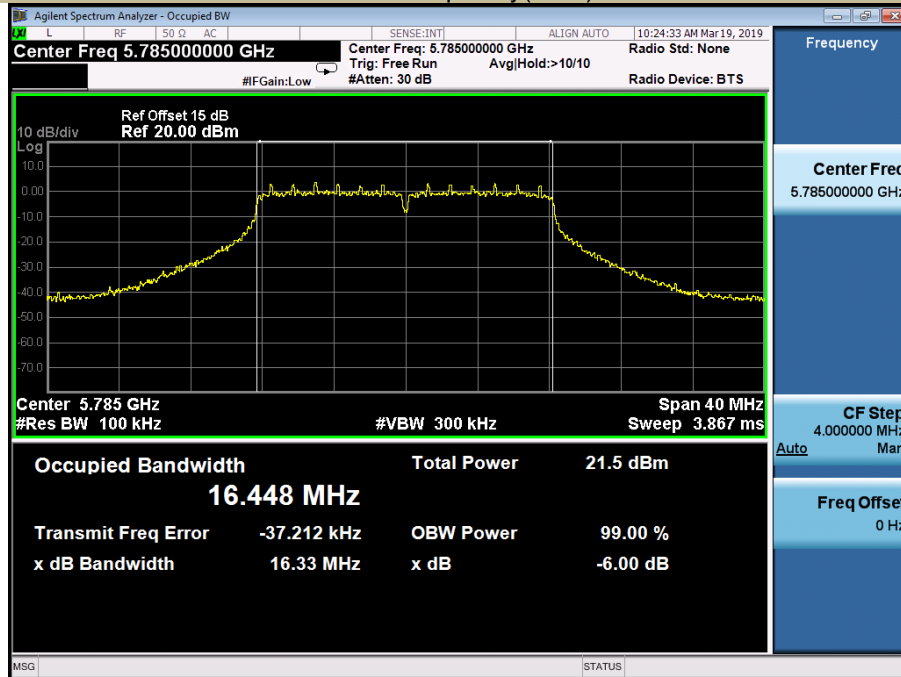

6 dB Bandwidth

Test Model

802.11a

U-NII - 3

Frequency(MHz)

5825

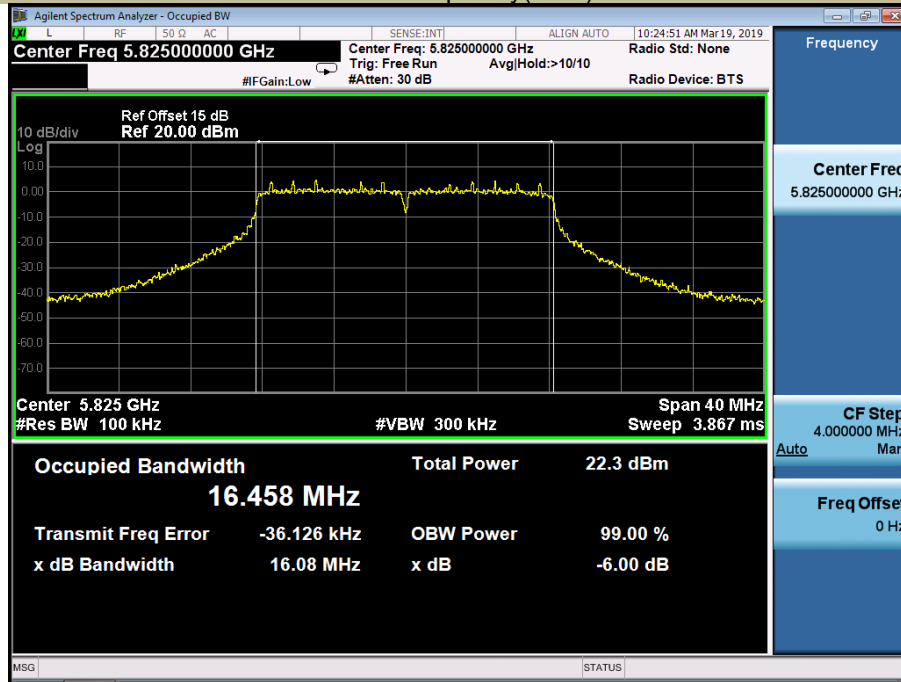

99% Occupied Bandwidth

Test Model

802.11a

U-NII - 3

Frequency(MHz)

5745

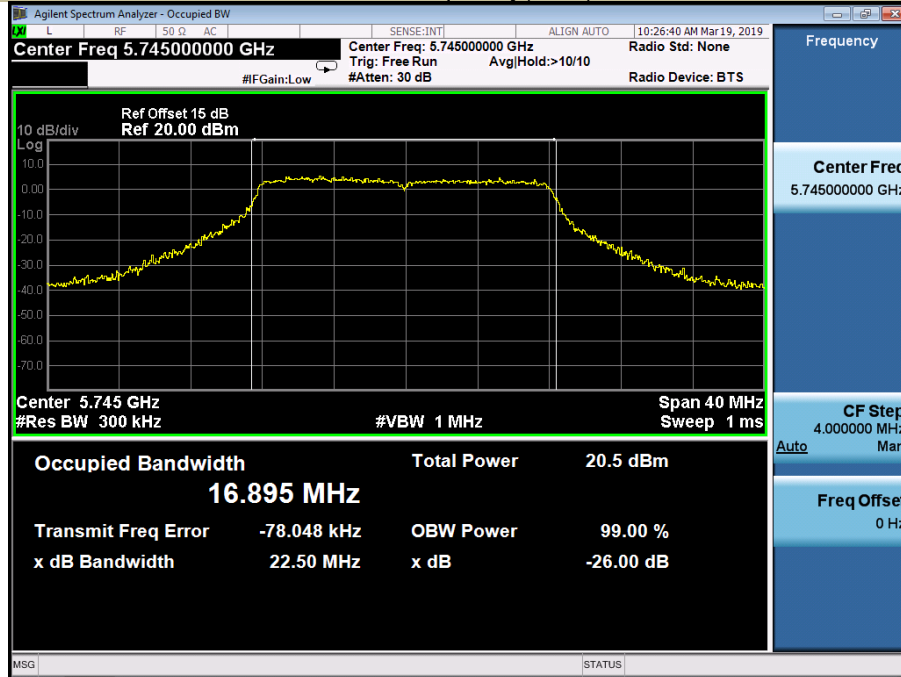

99% Occupied Bandwidth
Test Model 802.11a

U-NII - 3
Frequency(MHz) 5785

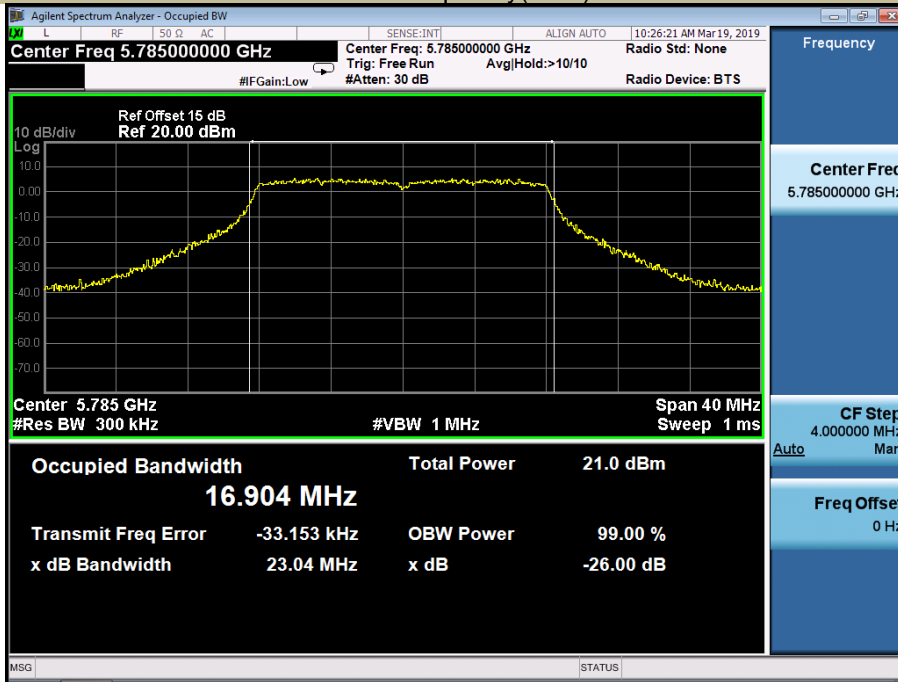

99% Occupied Bandwidth
Test Model 802.11a

U-NII - 3
Frequency(MHz) 5825

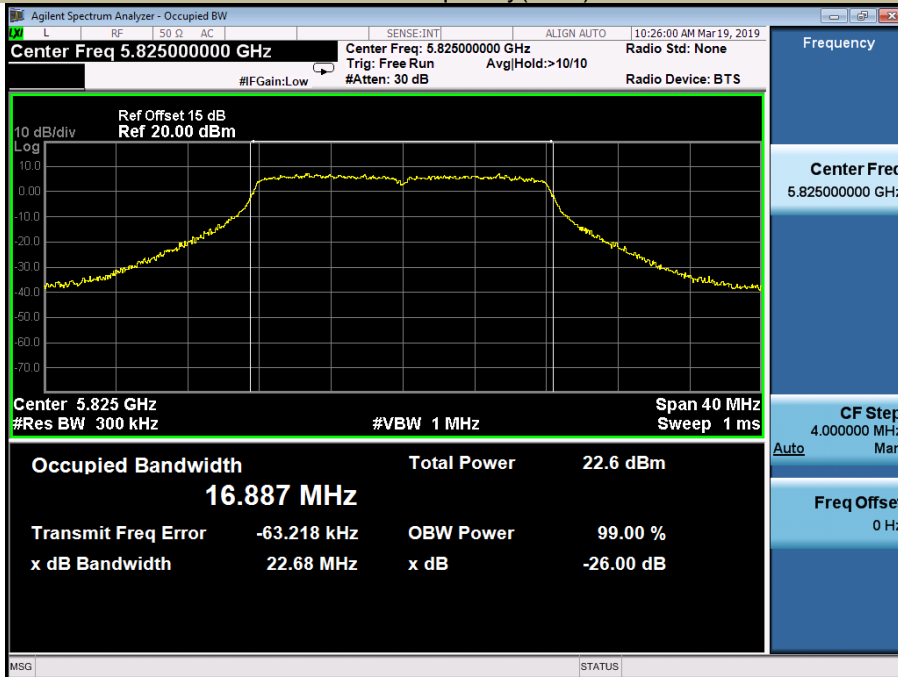

8.2 MAXIMUM CONDUCTED OUTPUT POWER

8.2.1 Applicable Standard

According to FCC Part 15.407(a)(1) for UNII Band I
According to FCC Part 15.407(a)(2) for UNII Band II-A and UNII Band II-C
According to FCC Part 15.407(a)(3) for UNII Band III
According to 789033 D02 Section II(E)

8.2.2 Conformance Limit

■ For the band 5.15-5.25 GHz,

(a) (1) (i) For an outdoor access point operating in the band 5.15-5.25 GHz, the maximum conducted output power over the frequency band of operation shall not exceed 1 W provided the maximum antenna gain does not exceed 6 dBi. If transmitting antennas of directional gain greater than 6 dBi are used, both the maximum conducted output power and the maximum power spectral density shall be reduced by the amount in dB that the directional gain of the antenna exceeds 6 dBi. The maximum e.i.r.p. at any elevation angle above 30 degrees as measured from the horizon must not exceed 125 mW (21 dBm).

(a) (1) (ii) For an indoor access point operating in the band 5.15-5.25 GHz, the maximum conducted output power over the frequency band of operation shall not exceed 1 W provided the maximum antenna gain does not exceed 6 dBi. If transmitting antennas of directional gain greater than 6 dBi are used, both the maximum conducted output power and the maximum power spectral density shall be reduced by the amount in dB that the directional gain of the antenna exceeds 6 dBi.

(a) (1) (iii) For fixed point-to-point access points operating in the band 5.15-5.25 GHz, the maximum conducted output power over the frequency band of operation shall not exceed 1 W. Fixed point-to-point U-NII devices may employ antennas with directional gain up to 23 dBi without any corresponding reduction in the maximum conducted output power or maximum power spectral density. For fixed point-to-point transmitters that employ a directional antenna gain greater than 23 dBi, a 1 dB reduction in maximum conducted output power and maximum power spectral density is required for each 1 dB of antenna gain in excess of 23 dBi. Fixed, point-to-point operations exclude the use of point-to-multipoint systems, omnidirectional applications, and multiple collocated transmitters transmitting the same information. The operator of the U-NII device, or if the equipment is professionally installed, the installer, is responsible for ensuring that systems employing high gain directional antennas are used exclusively for fixed, point-to-point operations.

(a) (1) (iv) For mobile and portable client devices in the 5.15-5.25 GHz band, the maximum conducted output power over the frequency band of operation shall not exceed 250 mW provided the maximum antenna gain does not exceed 6 dBi. If transmitting antennas of directional gain greater than 6 dBi are used, both the maximum conducted output power and the maximum power spectral density shall be reduced by the amount in dB that the directional gain of the antenna exceeds 6 dBi.

■ For the 5.25-5.35 GHz and 5.47-5.725 GHz bands

(a) (2) the maximum conducted output power over the frequency bands of operation shall not exceed the lesser of 250 mW or $11 \text{ dBm} + 10 \log B$, where B is the 26 dB emission bandwidth in megahertz. In addition, the maximum power spectral density shall not exceed 11 dBm in any 1 megahertz band. If transmitting antennas of directional gain greater than 6 dBi are used, both the maximum conducted output power and the maximum power spectral density shall be reduced by the amount in dB that the directional gain of the antenna exceeds 6 dBi.

■ For the band 5.725-5.85 GHz

(a) (3) For the band 5.725-5.85 GHz, the maximum conducted output power over the frequency band of operation shall not exceed 1 W. In addition, the maximum power spectral density shall not exceed 30 dBm in any 500-kHz band. If transmitting antennas of directional gain greater than 6 dBi are used, both the maximum conducted output power and the maximum power spectral density shall be reduced by the amount in dB that the directional gain of the antenna exceeds 6 dBi.

8.2.3 Test Configuration

Test according to clause 6.1 radio frequency test setup

8.2.4 Test Procedure

The maximum average conducted output power can be measured using Method PM-G (Measurement using

a gated RF average power meter):

Measurements may be performed using a wideband gated RF power meter provided that the gate parameters are adjusted such that the power is measured only when the EUT is transmitting at its maximum power control level. Since the measurement is made only during the ON time of the transmitter, no duty cycle correction factor is required.

- a. The Transmitter output (antenna port) was connected to the power meter.
- b. Turn on the EUT and power meter and then record the power value.
- c. Repeat above procedures on all channels needed to be tested.

8.2.5 Test Results

☒ 802.11a mode					
Band	Channel Number	Channel Freq. (MHz)	Conducted Output Power(dBm)	Limit (dBm)	Verdict
U-NII – 3	CH149	5745	21.11	30	Pass
	CH157	5785	21.69	30	Pass
	CH165	5825	22.88	30	Pass

8.3 MAXIMUM PEAK POWER DENSITY

8.3.1 Applicable Standard

According to FCC Part 15.407(a)(1) for UNII Band I

According to FCC Part 15.407(a)(2) for UNII Band II-A and UNII Band II-C

According to FCC Part 15.407(a)(3) for UNII Band III

According to 789033 D02 Section II(F)

8.3.2 Conformance Limit

■ For the band 5.15-5.25 GHz,

(a) (1) (i) For an outdoor access point operating in the band 5.15-5.25 GHz, the maximum conducted output power over the frequency band of operation shall not exceed 1 W provided the maximum antenna gain does not exceed 6 dBi. If transmitting antennas of directional gain greater than 6 dBi are used, both the maximum conducted output power and the maximum power spectral density shall be reduced by the amount in dB that the directional gain of the antenna exceeds 6 dBi. The maximum e.i.r.p. at any elevation angle above 30 degrees as measured from the horizon must not exceed 125 mW (21 dBm).

(a) (1) (ii) For an indoor access point operating in the band 5.15-5.25 GHz, the maximum conducted output power over the frequency band of operation shall not exceed 1 W provided the maximum antenna gain does not exceed 6 dBi. If transmitting antennas of directional gain greater than 6 dBi are used, both the maximum conducted output power and the maximum power spectral density shall be reduced by the amount in dB that the directional gain of the antenna exceeds 6 dBi.

(a) (1) (iii) For fixed point-to-point access points operating in the band 5.15-5.25 GHz, the maximum conducted output power over the frequency band of operation shall not exceed 1 W. Fixed point-to-point U-NII devices may employ antennas with directional gain up to 23 dBi without any corresponding reduction in the maximum conducted output power or maximum power spectral density. For fixed point-to-point transmitters that employ a directional antenna gain greater than 23 dBi, a 1 dB reduction in maximum conducted output power and maximum power spectral density is required for each 1 dB of antenna gain in excess of 23 dBi. Fixed, point-to-point operations exclude the use of point-to-multipoint systems, omnidirectional applications, and multiple collocated transmitters transmitting the same information. The operator of the U-NII device, or if the equipment is professionally installed, the installer, is responsible for ensuring that systems employing high gain directional antennas are used exclusively for fixed, point-to-point operations.

(a) (1) (iv) For mobile and portable client devices in the 5.15-5.25 GHz band, the maximum conducted output power over the frequency band of operation shall not exceed 250 mW provided the maximum antenna gain does not exceed 6 dBi. If transmitting antennas of directional gain greater than 6 dBi are used, both the maximum conducted output power and the maximum power spectral density shall be reduced by the amount in dB that the directional gain of the antenna exceeds 6 dBi.

■ For the 5.25-5.35 GHz and 5.47-5.725 GHz bands

(b) (2) the maximum conducted output power over the frequency bands of operation shall not exceed the lesser of 250 mW or $11 \text{ dBm} + 10 \log B$, where B is the 26 dB emission bandwidth in megahertz. In addition, the maximum power spectral density shall not exceed 11 dBm in any 1 megahertz band. If transmitting antennas of directional gain greater than 6 dBi are used, both the maximum conducted output power and the maximum power spectral density shall be reduced by the amount in dB that the directional gain of the antenna exceeds 6 dBi.

■ For the band 5.725-5.85 GHz

(a) (3) For the band 5.725-5.85 GHz, the maximum conducted output power over the frequency band of operation shall not exceed 1 W. In addition, the maximum power spectral density shall not exceed 30 dBm in any 500-kHz band. If transmitting antennas of directional gain greater than 6 dBi are used, both the maximum conducted output power and the maximum power spectral density shall be reduced by the amount in dB that the directional gain of the antenna exceeds 6 dBi.

8.3.3 Test Configuration

Test according to clause 6.1 radio frequency test setup

8.3.4 Test Procedure

Methods refer to FCC KDB 789033

For devices operating in the bands 5.15-5.25 GHz, 5.25-5.35 GHz, and 5.47-5.725 GHz, the above procedures make use of 1 MHz RBW to satisfy directly the 1 MHz reference bandwidth specified in § 15.407(a)(5). For devices operating in the band 5.725-5.85 GHz, the rules specify a measurement bandwidth of 500 kHz. Many spectrum analyzers do not have 500 kHz RBW, thus a narrower RBW may need to be used. The rules permit the use of a RBWs less than 1 MHz, or 500 kHz, “provided that the measured power is integrated over the full reference bandwidth” to show the total power over the specified measurement bandwidth (i.e., 1 MHz, or 500 kHz). If measurements are performed using a reduced resolution bandwidth (< 1 MHz, or < 500 kHz) and integrated over 1 MHz, or 500 kHz bandwidth, the following adjustments to the procedures apply:

- a) Set $RBW \geq 1/T$, where T is defined in section II.B.I.a).
- b) Set $VBW \geq 3 RBW$.
- c) If measurement bandwidth of Maximum PSD is specified in 500 kHz, add $10\log(500\text{kHz}/RBW)$ to the measured result, whereas RBW (< 500 kHz) is the reduced resolution bandwidth of the spectrum analyzer set during measurement.
- d) If measurement bandwidth of Maximum PSD is specified in 1 MHz, add $10\log(1\text{MHz}/RBW)$ to the measured result, whereas RBW (< 1 MHz) is the reduced resolution bandwidth of spectrum analyzer set during measurement.
- e) Care must be taken to ensure that the measurements are performed during a period of continuous transmission or are corrected upward for duty cycle.

Note: As a practical matter, it is recommended to use reduced RBW of 100 kHz for the sections

5.c) and 5.d) above, since RBW=100 kHz is available on nearly all spectrum analyzers.

8.3.5 Test Results

5725-5850MHz

Operating mode	Test Channel	Power Spectral Density dBm/MHz	Limit (dBm/MHz)
802.11a	5745	-0.598	30
	5785	-0.213	30
	5825	1.426	30

Power Spectral Density U-NII - 3
Test Model 802.11a Frequency(MHz) 5745

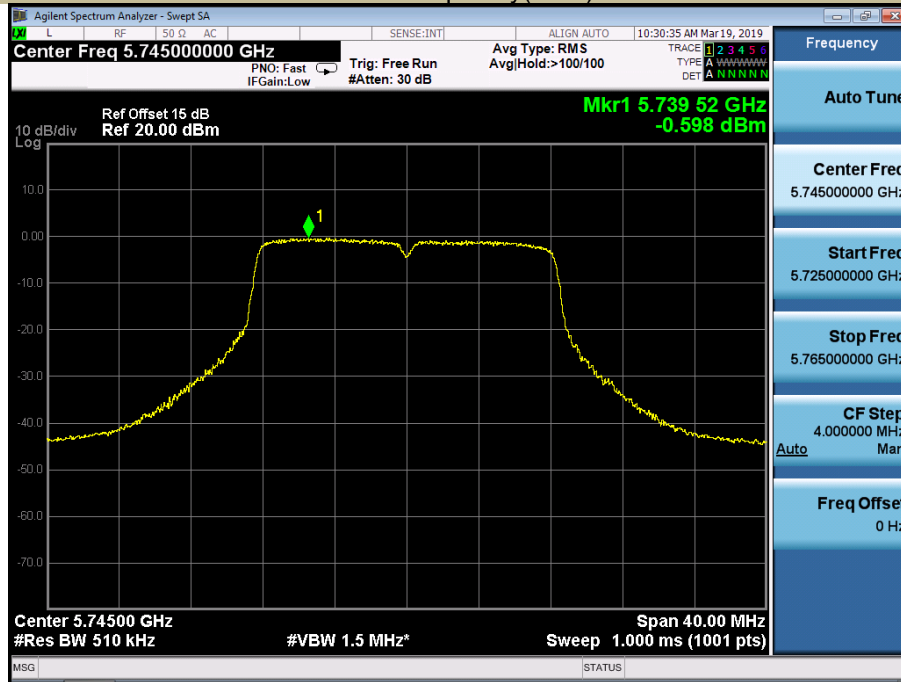

Power Spectral Density U-NII - 3
Test Model 802.11a Frequency(MHz) 5785

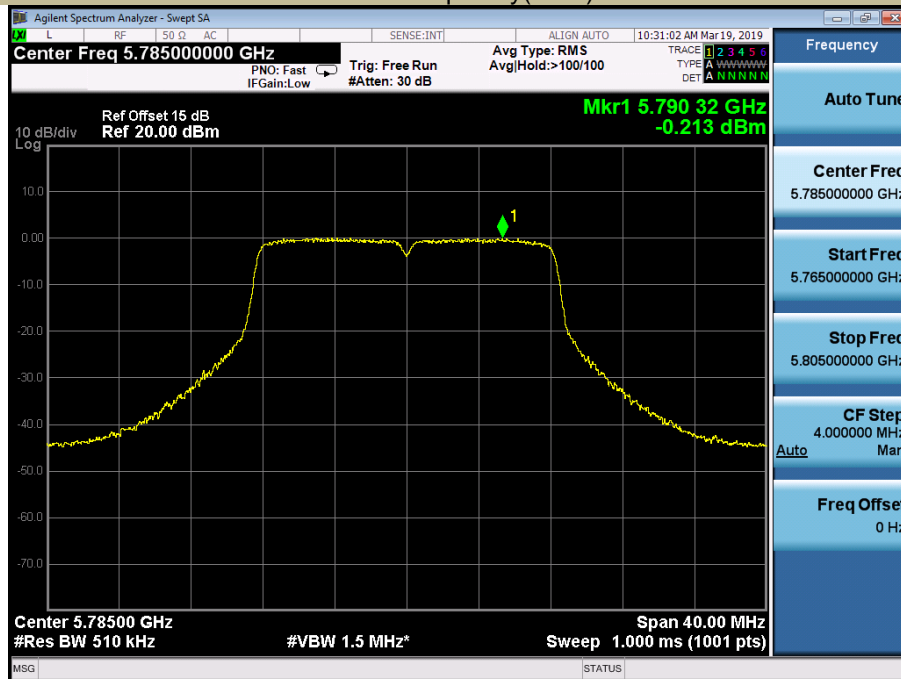

Power Spectral Density U-NII - 3
Test Model 802.11a Frequency(MHz) 5825

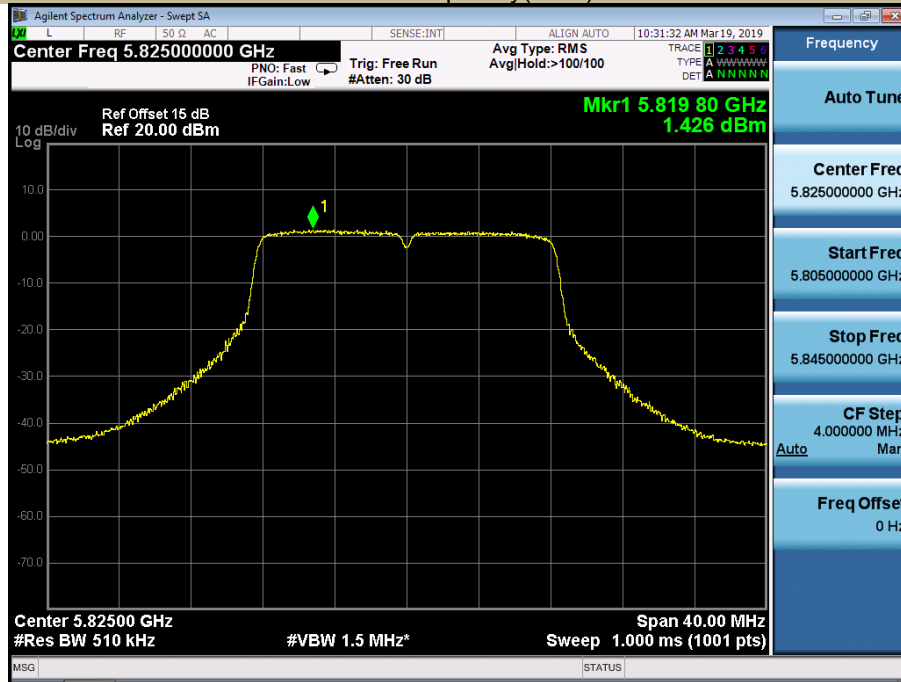

8.4 FREQUENCY STABILITY

8.4.1 Applicable Standard

According to FCC Part 15.407(g)
ANSI C63.10 Section 6.8

8.4.2 Conformance Limit

Manufacturers of U-NII devices are responsible for ensuring frequency stability such that an emission is maintained within the band of operation under all conditions of normal operation as specified in the users manual.

8.4.3 Test Configuration

Test according to clause 6.1 radio frequency test setup

8.4.4 Test Procedure

The RF output of EUT was connected to the spectrum analyzer by RF cable and attenuator. The path loss was compensated to the results for each measurement.

Set to the maximum power setting and enable the EUT transmit continuously

Set RBW = 10 kHz.

Set Span= Entire absence of modulation emissions band

Set the video bandwidth (VBW) =30 kHz. width

Set Detector = Peak.

Set Trace mode = max hold.

Set Sweep = auto couple.

Allow the trace to stabilize.

The test extreme voltage is to change the primary supply voltage from 85 to 115 percent of the nominal value.

Beginning at each temperature level specified in user manual , the frequency shall be measured within one minute after application of primary power to the transmitter and at intervals of no more than one minute thereafter until ten minutes have elapsed or until sufficient measurements are obtained to indicate clearly that the frequency has stabilized within the applicable tolerance, whichever time period is greater. During each test, the ambient temperature shall not be allowed to rise more than 10° centigrade above the respective beginning ambient temperature level

Measure and record the results in the test report.

8.4.5 Test Results

802.11a 5745

Voltage(V)	Temp(°C)	Test Frequency (MHz)	Max. Deviation (KHz)	Verdict
Vnom	-20	5744.9879	-12.1	Pass
	-10	5744.9902	-9.8	Pass
	0	5744.9841	-15.9	Pass
	10	5744.9885	-11.5	Pass
	20	5744.9847	-15.3	Pass
	30	5744.9938	-6.2	Pass
	40	5744.9929	-7.1	Pass
55	5744.9856	-14.4	Pass	
85% Vnom	25	5744.9814	-18.6	Pass
115% Vnom	25	5744.9942	-5.8	Pass

5785

Voltage(V)	Temp(°C)	Test Frequency (MHz)	Max. Deviation (KHz)	Verdict
Vnom	-20	5784.9817	-18.3	Pass
	-10	5784.9845	-15.5	Pass
	0	5784.9891	-10.9	Pass
	10	5784.9858	-14.2	Pass
	20	5784.9857	-14.3	Pass
	30	5784.9975	-2.5	Pass
	40	5784.9941	-5.9	Pass
55	5784.9833	-16.7	Pass	
85% Vnom	25	5784.986	-14	Pass
115% Vnom	25	5784.983	-17	Pass

5825

Voltage(V)	Temp(°C)	Test Frequency (MHz)	Max. Deviation (KHz)	Verdict
Vnom	-20	5824.9807	-19.3	Pass
	-10	5824.9823	-17.7	Pass
	0	5824.9825	-17.5	Pass
	10	5824.9989	-1.1	Pass
	20	5824.9978	-2.2	Pass
	30	5824.9916	-8.4	Pass
	40	5824.9912	-8.8	Pass
55	5824.9984	-1.6	Pass	
85% Vnom	25	5824.9875	-12.5	Pass
115% Vnom	25	5824.9903	-9.7	Pass

8.5 UNDESIRABLE RADIATED SPURIOUS EMISSION

8.5.1 Applicable Standard

According to FCC Part 15.407 (b)
According to 789033 D02 Section II(G)

8.5.2 Conformance Limit

For transmitters operating in the 5.15-5.25 GHz band: All emissions outside of the 5.15-5.35 GHz band shall not exceed an e.i.r.p. of -27 dBm/MHz.

For transmitters operating in the 5.25-5.35 GHz band: All emissions outside of the 5.15-5.35 GHz band shall not exceed an e.i.r.p. of -27 dBm/MHz.

For transmitters operating in the 5.47-5.725 GHz band: All emissions outside of the 5.47-5.725 GHz band shall not exceed an e.i.r.p. of -27 dBm/MHz.

For transmitters operating in the 5.725-5.85 GHz band: All emissions shall be limited to a level of -27 dBm/MHz at 75 MHz or more above or below the band edge increasing linearly to 10 dBm/MHz at 25 MHz above or below the band edge, and from 25 MHz above or below the band edge increasing linearly to a level of 15.6 dBm/MHz at 5 MHz above or below the band edge, and from 5 MHz above or below the band edge increasing linearly to a level of 27 dBm/MHz at the band edge.

The emission measurements shall be performed using a minimum resolution bandwidth of 1 MHz. A lower resolution bandwidth may be employed near the band edge, when necessary, provided the measured energy is integrated to show the total power over 1 MHz.

Unwanted emissions below 1 GHz must comply with the general field strength limits set forth in §15.209

The emissions from an intentional radiator shall not exceed the field strength levels specified in the following table 15.209(a):

Restricted Frequency(MHz)	Field Strength ($\mu\text{V}/\text{m}$)	Field Strength ($\text{dB}\mu\text{V}/\text{m}$)	Measurement Distance
0.009-0.490	2400/F(KHz)	20 log (uV/m)	300
0.490-1.705	2400/F(KHz)	20 log (uV/m)	30
1.705-30	30	29.5	30
30-88	100	40	3
88-216	150	43.5	3
216-960	200	46	3
Above 960	500	54	3

The provisions of §15.205 apply to intentional radiators operating under this section, 15.205 Restricted bands of operation

MHz	MHz	MHz	GHz
0.090-0.110	16.42-16.423	399.9-410	4.5-5.15
10.495-0.505	16.69475-16.69525	608-614	5.35-5.46
2.1735-2.1905	16.80425-16.80475	960-1240	7.25-7.75
4.125-4.128	25.5-25.67	1300-1427	8.025-8.5
4.17725-4.17775	37.5-38.25	1435-1626.5	9.0-9.2
4.20725-4.20775	73-74.6	1645.5-1646.5	9.3-9.5
6.215-6.218	74.8-75.2	1660-1710	10.6-12.7
6.26775-6.26825	123-138	2200-2300	14.47-14.5
8.291-8.294	149.9-150.05	2310-2390	15.35-16.2
8.362-8.366	156.52475-156.52525	2483.5-2500	17.7-21.4
8.37625-8.38675	156.7-156.9	2690-2900	22.01-23.12
8.41425-8.41475	162.0125-167.17	3260-3267	23.6-24.0
12.29-12.293	167.72-173.2	3332-3339	31.2-31.8
12.51975-12.52025	240-285	3345.8-3358	36.43-36.5
12.57675-12.57725	322-335.4	3600-4400	(2)
13.36-13.41			

- Remark:
1. Emission level in $\text{dB}\mu\text{V}/\text{m}=20 \log (\text{uV}/\text{m})$
 2. Measurement was performed at an antenna to the closed point of EUT distance of meters.
 3. Only spurious frequency is permitted to locate within the Restricted Bands specified in provision of § 15.205, and the emissions located in restricted bands also comply with 15.209 limit.

8.5.3 Test Configuration

Test according to clause 6.2 radio frequency test setup

8.5.4 Test Procedure

■ Unwanted Emissions Measurements below 1000 MHz

Compliance shall be demonstrated using CISPR quasi-peak detection; however, peak detection is permitted as an alternative to quasi-peak detection.

The EUT was placed on a turn table which is 0.8m above ground plane.

And also, each emission was to be maximized by changing the polarization of receiving antenna both horizontal and vertical.

Repeat above procedures until all frequency measured was complete.

We use software control the EUT, Let EUT hopping on and transmit with highest power, All the modes have been tested and the worst result was reported.

Use the following spectrum analyzer settings:

Set RBW=120kHz for $f < 1$ GHz(30MHz to 1GHz), 200Hz for $f < 150$ KHz(9KHz to 150KHz), 9KHz for < 30 MHz (150KHz to 30KHz).

Set the VBW > RBW.

Detector = Peak.

Trace mode = max hold.

Follow the guidelines in ANSI C63.10-2013 with respect to maximizing the emission by rotating the EUT, measuring the emission while the EUT is situated in three orthogonal planes (if appropriate), adjusting the measurement antenna height and polarization, etc. A pre-amp and a high pass filter are required for this test, in order to provide the measuring system with sufficient sensitivity. Allow the trace to stabilize. The peak reading of the emission, after being corrected by the antenna factor, cable loss, pre-amp gain, etc., is the peak field strength, which must comply with the limit specified in Section 15.35(b). Submit this data. Repeat above procedures until all frequency measured was complete.

■ Unwanted Maximum peak Emissions Measurements above 1000 MHz

Maximum emission levels are measured by setting the analyzer as follows:

RBW = 1 MHz.

VBW \geq 3 MHz.

Detector = Peak.

Sweep time = auto.

Trace mode = max hold.

Allow sweeps to continue until the trace stabilizes. Note that if the transmission is not continuous, the time required for the trace to stabilize will increase by a factor of approximately $1/x$, where x is the duty cycle. For example, at 50 percent duty cycle, the measurement time will increase by a factor of two relative to measurement time for continuous transmission.

■ Unwanted Average Emissions Measurements above 1000 MHz

Method VB (Averaging using reduced video bandwidth): Alternative method.

RBW = 1 MHz.

Video bandwidth. • If the EUT is configured to transmit with duty cycle \geq 98 percent, set $VBW \leq RBW/100$ (i.e., 10 kHz) but not less than 10 Hz.

• If the EUT duty cycle is $<$ 98 percent, set $VBW \geq 1/T$, where T is defined in section II.B.1.a).

Video bandwidth mode or display mode • The instrument shall be set to ensure that video filtering is applied in the power domain. Typically, this requires setting the detector mode to RMS and setting the Average-VBW Type to Power (RMS).

• As an alternative, the analyzer may be set to linear detector mode. Ensure that video filtering is applied in linear voltage domain (rather than in a log or dB domain). Some analyzers require linear display mode in order to accomplish this. Others have a setting for Average-VBW Type, which can be set to "Voltage" regardless of the display mode.

Detector = Peak.

Sweep time = auto.

Trace mode = max hold.

Allow max hold to run for at least 50 traces if the transmitted signal is continuous or has at least 98 percent duty cycle. For lower duty cycles, increase the minimum number of traces by a factor of $1/x$, where x is the duty cycle. For example, use at least 200 traces if the duty cycle is 25 percent. (If a specific emission is demonstrated to be continuous—i.e., 100 percent duty cycle—rather than turning on and off with the transmit cycle, at least 50 traces shall be averaged.)

■ Band edge measurements.

Unwanted band-edge emissions may be measured using either of the special band-edge measurement techniques (the marker-delta or integration methods) described below. Note that the marker-delta method is primarily a radiated measurement technique that requires the 99% occupied bandwidth edge to be within 2 MHz of the authorized band edge, whereas the integration method can be used in either a radiated or conducted measurement without any special requirement with regards to the displacement of the unwanted emission(s) relative to the authorized bandwidth.

Marker-Delta Method.

The marker-delta method, as described in ANSI C63.10, can be used to perform measurements of the radiated unwanted emissions level of emissions provided that the 99% occupied bandwidth of the fundamental is within 2 MHz of the authorized band-edge.

8.5.5 Test Results

The voltage 120V & 240V and the modes 802.11a has been tested and the worst result recorded as below

For Undesirable radiated Spurious Emission in U-NII -3

All the modes 802.11a have been tested and the worst result 802.11a recorded as below:

- Undesirable radiated Spurious Emission Above 1GHz (1GHz to 40GHz)

Test mode: 802.11a Frequency(MHz): 5745

Freq. (MHz)	Ant.Pol. H/V	Field Strength (dBuV/m)	E.I.R.P (dBm)	Limit (dBm)	Over(dB)
8106.89	V	61.61	-33.62	-27	-6.62
11490.00	V	57.59	-37.64	-27	-10.64
17235.00	V	57.82	-37.41	-27	-10.41
8114.39	H	62.79	-32.44	-27	-5.44
11490.00	H	57.96	-37.27	-27	-10.27
17235.00	H	62.58	-32.65	-27	-5.65

Test mode: 802.11a Frequency(MHz): 5785

Freq. (MHz)	Ant.Pol. H/V	Field Strength (dBuV/m)	E.I.R.P (dBm)	Limit (dBm)	Over(dB)
7808.98	V	63.87	-31.36	-27	-4.36
11570.00	V	62.46	-32.77	-27	-5.77
17355.00	V	61.04	-34.19	-27	-7.19
8120.48	H	66.75	-28.48	-27	-1.48
11570.00	H	57.47	-37.76	-27	-10.76
17355.00	H	59.04	-36.19	-27	-9.19

Test mode: 802.11a Frequency(MHz): 5825

Freq. (MHz)	Ant.Pol. H/V	Field Strength (dBuV/m)	E.I.R.P (dBm)	Limit (dBm)	Over(dB)
8038.13	V	60.59	-34.64	-27	-7.64
11650.00	V	59.01	-36.22	-27	-9.22
17475.00	V	59.95	-35.28	-27	-8.28
7700.35	H	61.75	-33.48	-27	-6.48
11650.00	H	64.82	-30.41	-27	-3.41
17475.00	H	57.19	-38.04	-27	-11.04

Note: (1) All Readings are Peak Value (VBW=3MHz) and AV Value (VBW=10Hz).

(2) Emission Level= Reading Level+Probe Factor +Cable Loss.

(3) $EIRP[dBm] = E[dB\mu V/m] + 20 \log(d[meters]) - 104.77$

d is the measurement distance in 3 meters

- Undesirable radiated Spurious Emission in band edge

Test mode: 802.11a Frequency: 5745

Freq. (MHz)	Ant.Pol. H/V	Field Strength (RBW=100KHz) (dBuV/m)	E.I.R.P (dBm)	Limit (dBm)	Verdict
5724.75	H	59.84	-35.39	26.43	PASS
5724.75	V	61.30	-33.93	26.43	PASS

Test mode: 802.11a Frequency: 5825

Freq. (MHz)	Ant.Pol. H/V	Field Strength (RBW=100KHz) (dBuV/m)	E.I.R.P (dBm)	Limit (dBm)	Verdict
5850.50	V	59.42	-35.81	25.86	PASS
5850.87	H	60.03	-35.20	26.00	PASS

- Note:** (1) All Readings are Peak Value (VBW=3MHz) and Peak Value (VBW=10Hz).
 (2) Emission Level= Reading Level+Correct Factor +Cable Loss.
 (3) Correct Factor= Ant_F + Cab_L - Preamp
 (4) EIRP[dBm] = E[dBμV/m] + 20 log(d[meters]) - 104.77
 d is the measurement distance in 3 meters

- Undesirable radiated Spurious Emission below 1GHz (30MHz to 1GHz)
All the modes 802.11a have been tested and the worst result 802.11a recorded as below:

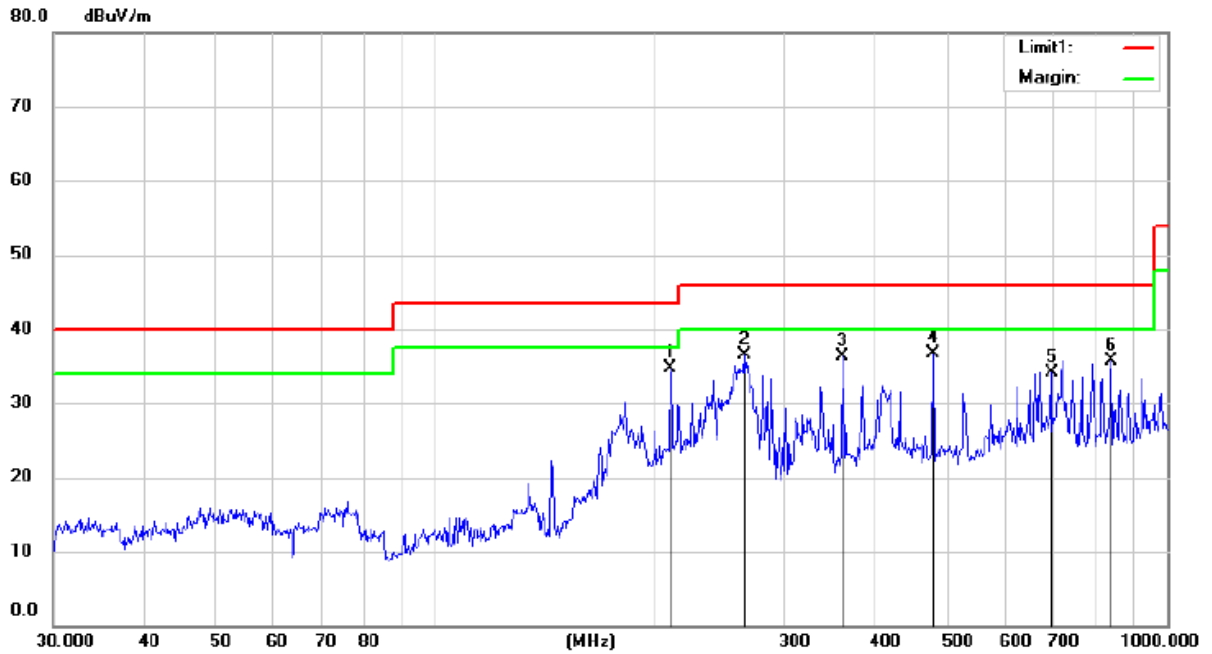

Site: 3m Chamber 3# Polarization: **Horizontal** Temperature: 25.1 C
 Limit: (RE)FCC PART 15 CLASS B Power: DC 11.4V Humidity: 38 %

Mode:TX-LOW

Note:

No.	Mk.	Freq. MHz	Reading Level dBuV	Correct Factor dB	Measure- ment dBuV/m	Limit dBuV/m	Over dB	Antenna Height cm	Table Degree degree	Detector	Comment
1	*	209.9745	49.23	-14.62	34.61	43.50	-8.89			QP	
2		264.0040	49.52	-13.08	36.44	46.00	-9.56			QP	
3		360.0686	47.39	-11.17	36.22	46.00	-9.78			QP	
4		480.0221	45.44	-8.78	36.66	46.00	-9.34			QP	
5		696.1240	38.85	-4.74	34.11	46.00	-11.89			QP	
6		840.0650	38.28	-2.56	35.72	46.00	-10.28			QP	

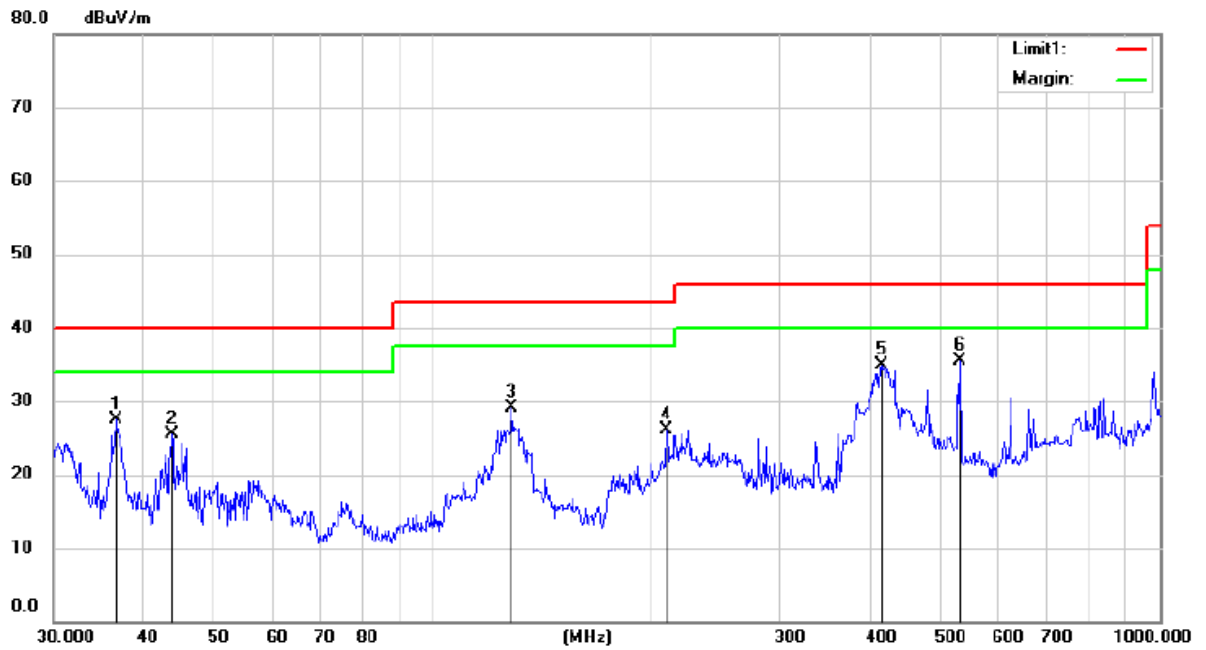

Site 3m Chamber 3# Polarization: **Vertical** Temperature: 25.1 C
 Limit: (RE)FCC PART 15 CLASS B Power: DC 11.4V Humidity: 38 %

Mode:TX-LOW
 Note:

No.	Mk.	Freq.	Reading Level	Correct Factor	Measurement	Limit	Over	Antenna Height	Table Degree	
		MHz	dBuV	dB	dBuV/m	dBuV/m	dB	cm	degree	Comment
1		36.5990	43.46	-16.00	27.46	40.00	-12.54	QP		
2		43.7965	40.45	-14.87	25.58	40.00	-14.42	QP		
3		128.4275	46.18	-17.10	29.08	43.50	-14.42	QP		
4		209.9745	40.81	-14.62	26.19	43.50	-17.31	QP		
5		414.7223	44.81	-9.82	34.99	46.00	-11.01	QP		
6	*	530.4732	42.59	-7.10	35.49	46.00	-10.51	QP		

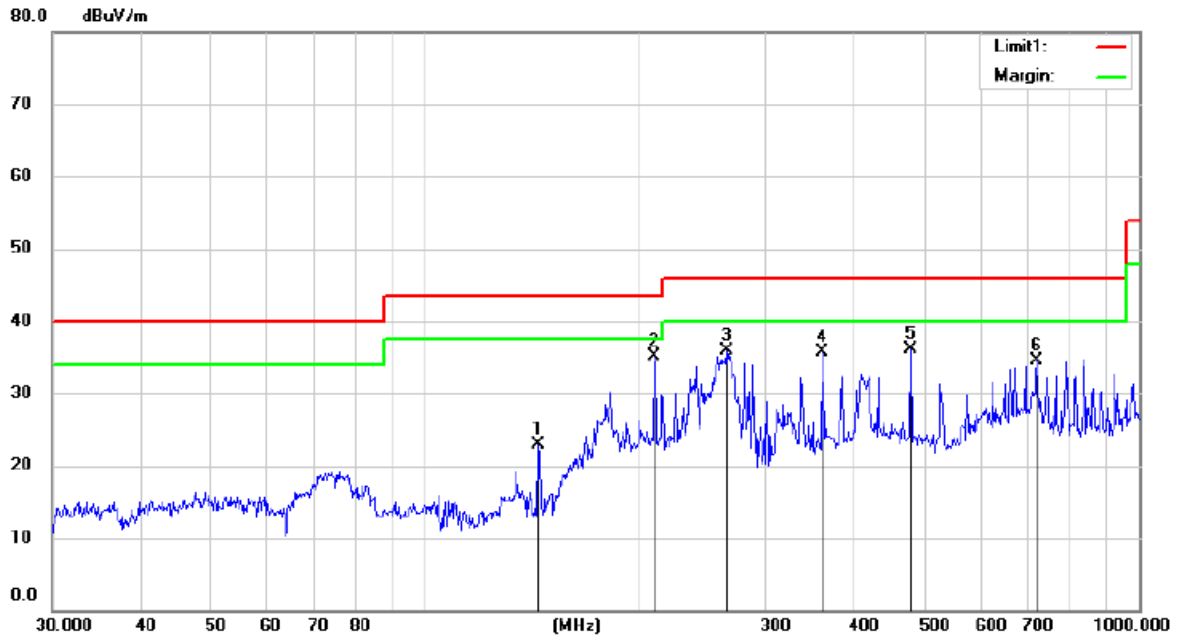

Site: 3m Chamber 3# Polarization: **Horizontal** Temperature: 25.1 C
 Limit: (RE)FCC PART 15 CLASS B Power: DC 11.4V Humidity: 38 %

Mode: TX-Middle
 Note:

No.	Mk.	Freq. MHz	Reading Level dBuV	Correct Factor dB	Measure- ment dBuV/m	Limit dBuV/m	Over dB	Antenna Height cm	Table Degree	Comment
1		143.9810	41.57	-18.73	22.84	43.50	-20.66	QP		
2	*	209.9745	49.73	-14.62	35.11	43.50	-8.39	QP		
3		264.0040	49.02	-13.08	35.94	46.00	-10.06	QP		
4		360.0686	46.89	-11.17	35.72	46.00	-10.28	QP		
5		480.0221	44.94	-8.78	36.16	46.00	-9.84	QP		
6		720.2090	38.83	-4.23	34.60	46.00	-11.40	QP		

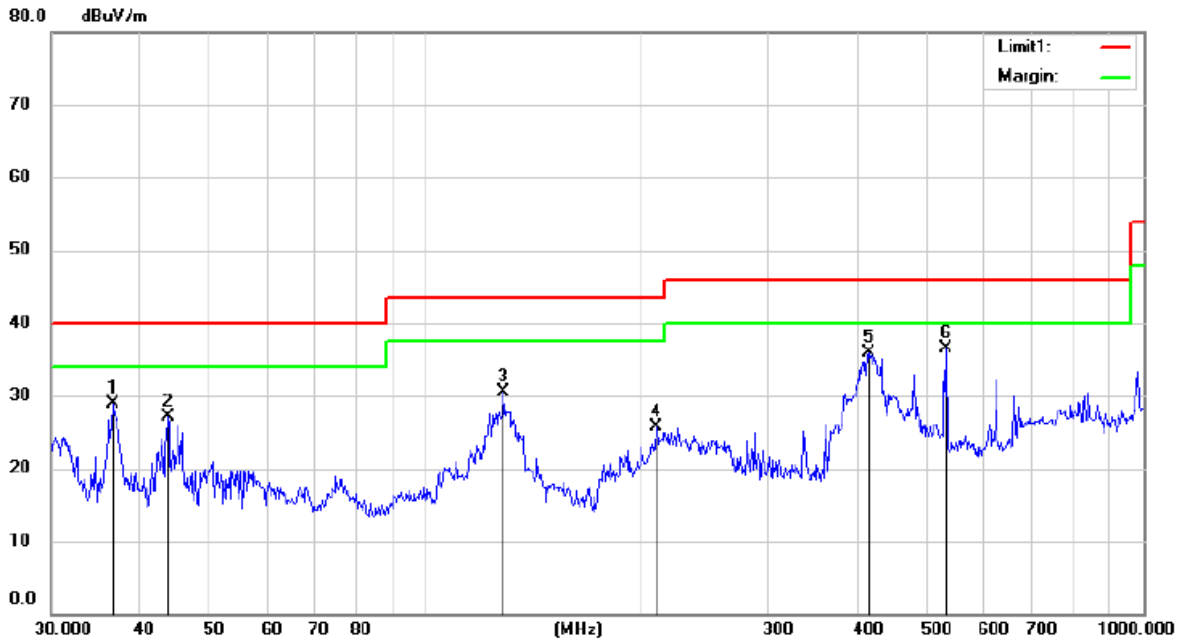

Site: 3m Chamber 3# Polarization: **Vertical** Temperature: 25.1 C
 Limit: (RE)FCC PART 15 CLASS B Power: DC 11.4V Humidity: 38 %

Mode: TX-Middle

Note:

No.	Mk.	Freq.	Reading Level	Correct Factor	Measurement	Limit	Over	Antenna Height	Table Degree	
		MHz	dBuV	dB	dBuV/m	dBuV/m	dB	cm	degree	Comment
1		36.5990	44.96	-16.00	28.96	40.00	-11.04	QP		
2		43.7965	41.95	-14.87	27.08	40.00	-12.92	QP		
3		128.4275	47.68	-17.10	30.58	43.50	-12.92	QP		
4		209.9745	40.31	-14.62	25.69	43.50	-17.81	QP		
5		414.7223	45.81	-9.82	35.99	46.00	-10.01	QP		
6	*	530.4732	43.59	-7.10	36.49	46.00	-9.51	QP		

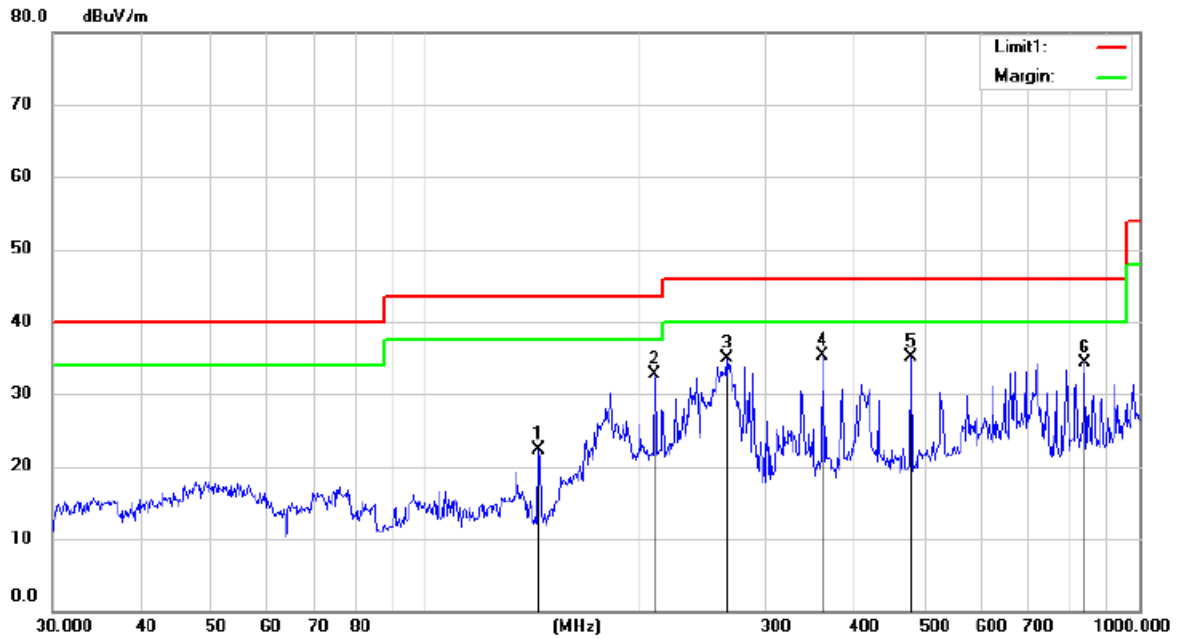

Site 3m Chamber 3# Polarization: **Horizontal** Temperature: 25.1 C
 Limit: (RE)FCC PART 15 CLASS B Power: DC 11.4V Humidity: 38 %

Mode:TX-High

Note:

No.	Mk.	Freq.	Reading Level	Correct Factor	Measurement	Limit	Over	Antenna Height	Table Degree	
		MHz	dBuV	dB	dBuV/m	dBuV/m	dB	cm	degree	Comment
1		143.9810	41.07	-18.73	22.34	43.50	-21.16			QP
2		209.9745	47.23	-14.62	32.61	43.50	-10.89			QP
3		264.0040	48.02	-13.08	34.94	46.00	-11.06			QP
4	*	360.0686	46.39	-11.17	35.22	46.00	-10.78			QP
5		480.0221	43.94	-8.78	35.16	46.00	-10.84			QP
6		840.0650	36.78	-2.56	34.22	46.00	-11.78			QP

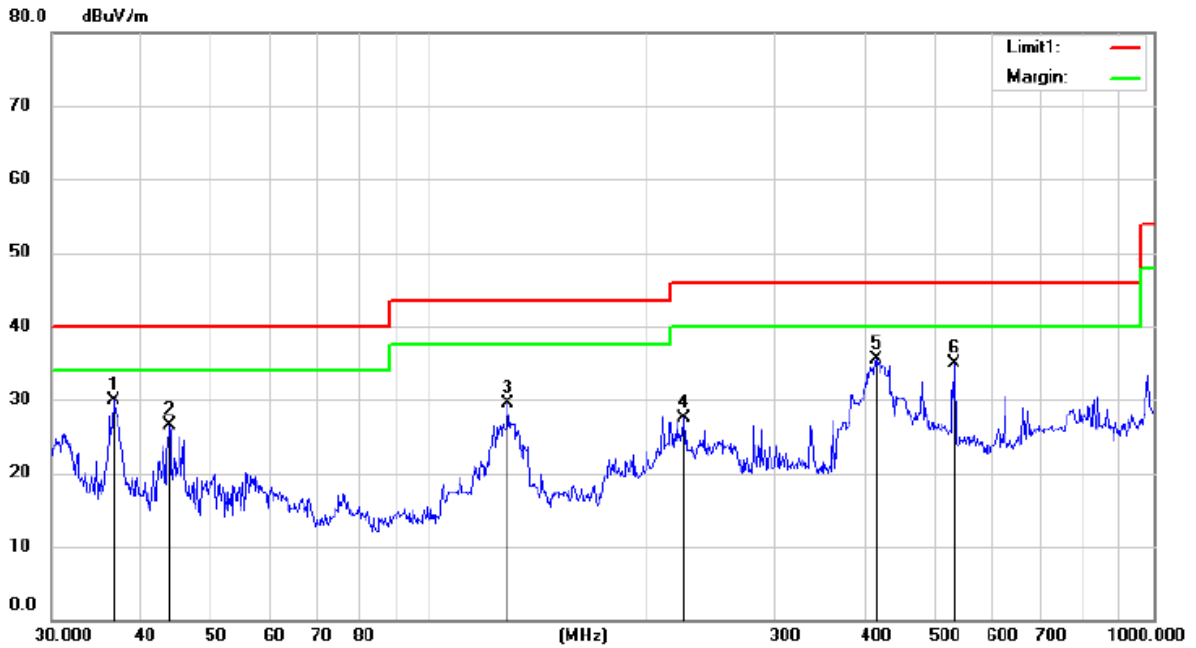

Site: 3m Chamber 3# Polarization: **Vertical** Temperature: 25.1 C
 Limit: (RE)FCC PART 15 CLASS B Power: DC 11.4V Humidity: 38 %

Mode: TX-High

Note:

No.	Mk.	Freq.	Reading Level	Correct Factor	Measure-ment	Limit	Over	Antenna Height	Table Degree	
		MHz	dBuV	dB	dBuV/m	dBuV/m	dB	cm	degree	Comment
1	*	36.5990	45.96	-16.00	29.96	40.00	-10.04	QP		
2		43.7965	41.45	-14.87	26.58	40.00	-13.42	QP		
3		128.4275	46.68	-17.10	29.58	43.50	-13.92	QP		
4		224.9920	41.75	-14.21	27.54	46.00	-18.46	QP		
5		414.7223	45.31	-9.82	35.49	46.00	-10.51	QP		
6		530.4732	42.09	-7.10	34.99	46.00	-11.01	QP		

8.6 POWER LINE CONDUCTED EMISSIONS

8.6.1 Applicable Standard

According to FCC Part 15.207(a)

8.6.2 Conformance Limit

Frequency(MHz)	Conducted Emission Limit	
	Quasi-peak	Average
0.15-0.5	66-56	56-46
0.5-5.0	56	46
5.0-30.0	60	50

Note: 1. The lower limit shall apply at the transition frequencies

2. The limit decreases in line with the logarithm of the frequency in the range of 0.15 to 0.50MHz.

8.6.3 Test Configuration

Test according to clause 6.3 conducted emission test setup

8.6.4 Test Procedure

The EUT was placed on a table which is 0.8m above ground plane.
Maximum procedure was performed on the highest emissions to ensure EUT compliance.
Repeat above procedures until all frequency measured were complete.

8.6.5 Test Results

Pass

The 120V & 240V voltage have been tested, and the worst result recorded was report as below:

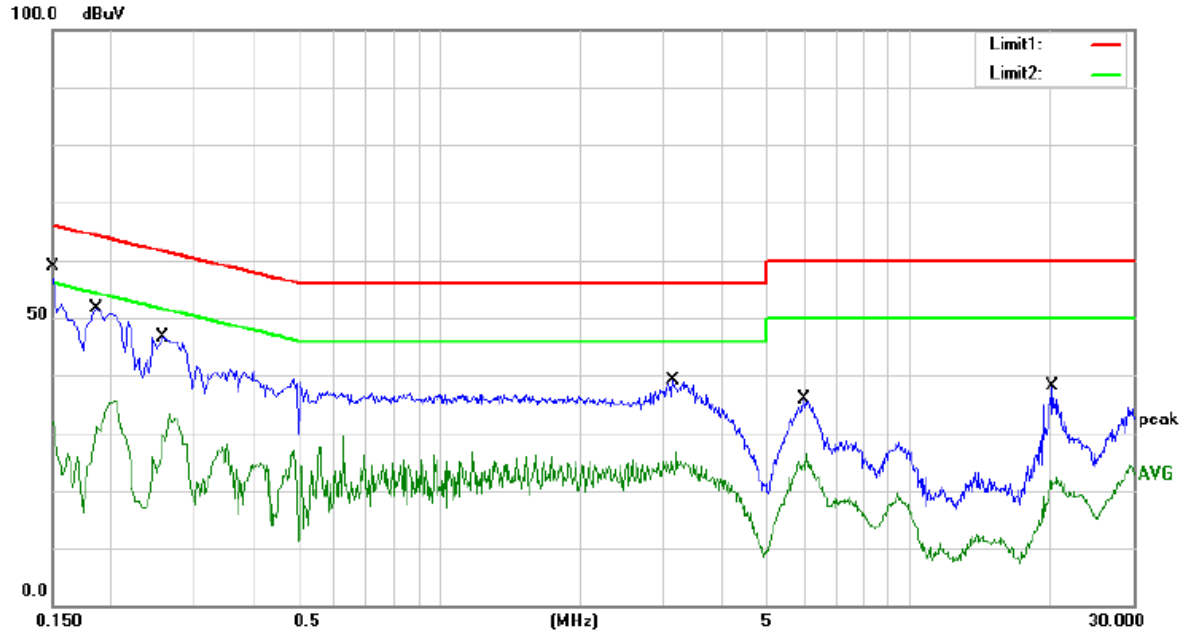

Site Conduction #2 Phase: **N** Temperature: 23.7
 Limit: (CE)FCC PART 15 class B_QP Power: AC 120V/60Hz Humidity: 41 %

Mode: Charging
 Note:

No.	Mk.	Freq.	Reading Level	Correct Factor	Measurement	Limit	Over	Detector	Comment
		MHz	dBuV	dB	dBuV	dBuV	dB		
1	*	0.1500	48.89	9.89	58.78	66.00	-7.22	QP	
2		0.1500	23.45	9.89	33.34	56.00	-22.66	AVG	
3		0.1860	41.74	9.90	51.64	64.21	-12.57	QP	
4		0.1860	25.70	9.90	35.60	54.21	-18.61	AVG	
5		0.2580	36.74	9.91	46.65	61.50	-14.85	QP	
6		0.2580	23.54	9.91	33.45	51.50	-18.05	AVG	
7		3.1500	29.07	9.94	39.01	56.00	-16.99	QP	
8		3.1500	16.80	9.94	26.74	46.00	-19.26	AVG	
9		5.9780	25.79	9.97	35.76	60.00	-24.24	QP	
10		5.9780	16.29	9.97	26.26	50.00	-23.74	AVG	
11		20.2660	28.03	10.09	38.12	60.00	-21.88	QP	
12		20.2660	12.30	10.09	22.39	50.00	-27.61	AVG	

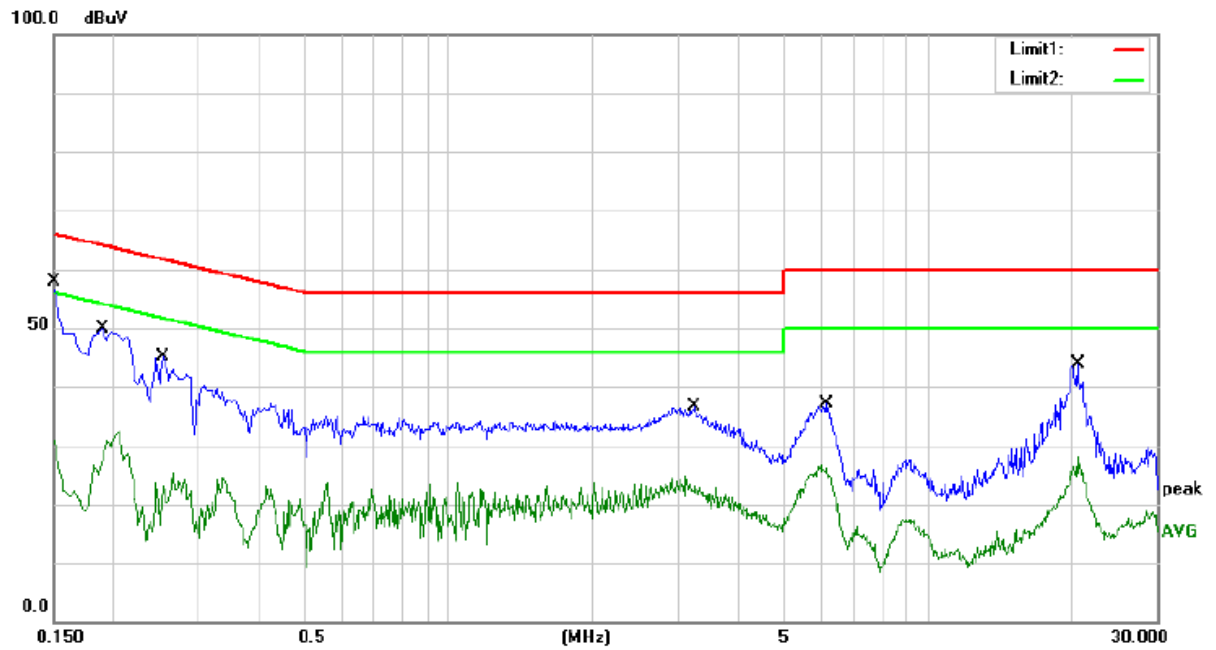

Site: Conduction #2 Phase: **L1** Temperature: 23.7
 Limit: (CE)FCC PART 15 class B_QP Power: AC 120V/60Hz Humidity: 41 %

Mode: Charging
 Note:

No.	Mk.	Freq.	Reading Level	Correct Factor	Measurement	Limit	Over	Detector	Comment
		MHz	dBuV	dB	dBuV	dBuV	dB		
1	*	0.1500	47.87	9.89	57.76	66.00	-8.24	QP	
2		0.1500	22.19	9.89	32.08	56.00	-23.92	AVG	
3		0.1900	40.10	9.90	50.00	64.04	-14.04	QP	
4		0.1900	22.46	9.90	32.36	54.04	-21.68	AVG	
5		0.2540	35.15	9.91	45.06	61.63	-16.57	QP	
6		0.2540	15.34	9.91	25.25	51.63	-26.38	AVG	
7		3.2740	26.64	9.94	36.58	56.00	-19.42	QP	
8		3.2740	14.87	9.94	24.81	46.00	-21.19	AVG	
9		6.1380	27.04	9.97	37.01	60.00	-22.99	QP	
10		6.1380	16.72	9.97	26.69	50.00	-23.31	AVG	
11		20.5420	33.78	10.10	43.88	60.00	-16.12	QP	
12		20.5420	17.94	10.10	28.04	50.00	-21.96	AVG	

8.7 ANTENNA APPLICATION

8.7.1 Antenna Requirement

Standard	Requirement
FCC CRF Part 15.203	An intentional radiator shall be designed to ensure that no antenna other than that furnished by the responsible party shall be used with the device. The use of a permanently attached antenna or of an antenna that uses a unique coupling to the intentional radiator shall be considered sufficient to comply with the provisions of this section. The manufacturer may design the unit so that a broken antenna can be replaced by the user, but the use of a standard antenna jack or electrical connector is prohibited. This requirement does not apply to carrier current devices or to devices operated under the provisions of §15.211, §15.213, §15.217, §15.219, or §15.221. Further, this requirement does not apply to intentional radiators that must be professionally installed, such as perimeter protection systems and some field disturbance sensors, or to other intentional radiators which, in accordance with §15.31(d), must be measured at the installation site. However, the installer shall be responsible for ensuring that the proper antenna is employed so that the limits in this part are not exceeded.

For intentional device, according to FCC 47 CFR Section 15.203, an intentional radiator shall be designed to ensure that no antenna other than that furnished by the responsible party shall be used with the device. And according to FCC 47 CFR Section 15.407 (a), if transmitting antennas of directional gain greater than 6dBi are used, the power shall be reduced by the amount in dB that the directional gain of the antenna exceeds 6dBi.

8.7.2 Result

PASS.

- The EUT has 1 antennas: an Internal Antenna for WIFI 5G, the gain is 4.5 dBi;
- Note:
- Antennas use a permanently attached antenna which is not replaceable.
 - Not using a standard antenna jack or electrical connector for antenna replacement
 - The antenna has to be professionally installed (please provide method of installation)

Which in accordance to section 15.203, please refer to the internal photos.

Detail of factor for radiated emission

Frequency(MHz)	Ant_F(dB)	Cab_L(dB)	Preamp(dB)	Correct Factor(dB)
0.009	20.6	0.03	\	20.63
0.15	20.7	0.1	\	20.8
1	20.9	0.15	\	21.05
10	20.1	0.28	\	20.38
30	18.8	0.45	\	19.25
30	11.7	0.62	27.9	-15.58
100	12.5	1.02	27.8	-14.28
300	12.9	1.91	27.5	-12.69
600	19.2	2.92	27	-4.88
800	21.1	3.54	26.6	-1.96
1000	22.3	4.17	26.2	0.27
1000	25.6	1.76	41.4	-14.04
3000	28.9	3.27	43.2	-11.03
5000	31.1	4.2	44.6	-9.3
8000	36.2	5.95	44.7	-2.55
10000	38.4	6.3	43.9	0.8
12000	38.5	7.14	42.3	3.34
15000	40.2	8.15	41.4	6.95
18000	45.4	9.02	41.3	13.12
18000	37.9	1.81	47.9	-8.19
21000	37.9	1.95	48.7	-8.85
25000	39.3	2.01	42.8	-1.49
28000	39.6	2.16	46.0	-4.24
31000	41.2	2.24	44.5	-1.06
34000	41.5	2.29	46.6	-2.81
37000	43.8	2.30	46.4	-0.3
40000	43.2	2.50	42.2	3.5