



FIMI X8 SE User Manual

Please read the user manual carefully before using and keep the manual for future reference.

Contents

Services & Support	·1
Product Instruction	·1
Package List	·2
Product Introduction	·3
Drone	·5
Assembly and Disassembly	·12
Gimbal and Camera	·14
Remote controller	·16
APP	·20
Prepare to Fly	·22
Maintenance and Calibration	·25
Basic Specification	·27

Services & Support

FIMI provides X8 SE users with tutorial videos and the following information:

1. *FIMI X8 SE User Manual*
2. *FIMI X8 SE Quick Start Manual*
3. *FIMI X8 SE Disclaimer and Safety Operation Instructions*

Users are advised to watch tutorial videos before using the product and read *FIMI X8 SE Disclaimer and Safety Operation Instructions* carefully and get to know the process of using by going through *FIMI X8 SE Quick Start Manual*. For more detailed product information, please refer to *FIMI X8 SE User Manual*. Please download the firmware and watch the tutorial videos on the link <https://www.fimi.com/fimi-x8-se.html>

4. Please scan the the following QR-code to download Fimi Navi app



Product Instruction

The FIMI X8 SE is an aerodynamic foldable drone equipped with intelligent control, wireless communication and other advanced technology which are necessary to realize functions like long-distance remote control, intelligent flight, precise landing, etc. The built-in 3-axis gimbal stabilizes the camera which is able to shoot 4K video at 30 fps and which performs HD real-time image transmission. The APP enriches the remote controller with more features and fast connection. The remote controller fits iPad Mini at the maximum range. The sticks are detachable.

Package List

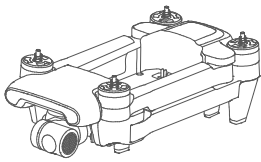

Drone x 1

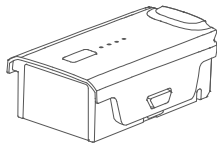

Battery x 1

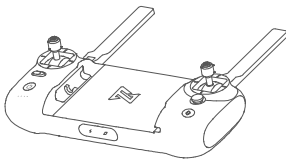

Remote controller x 1

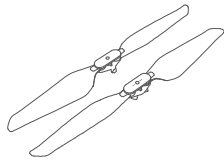

Positive propeller x 3
Reverse propeller x 3

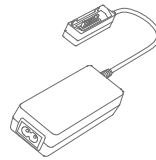

Charger x 1

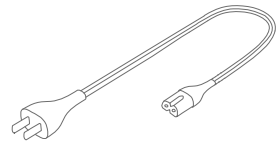

AC cable x 1



Instruction x 2

Product Introduction

1 Drone

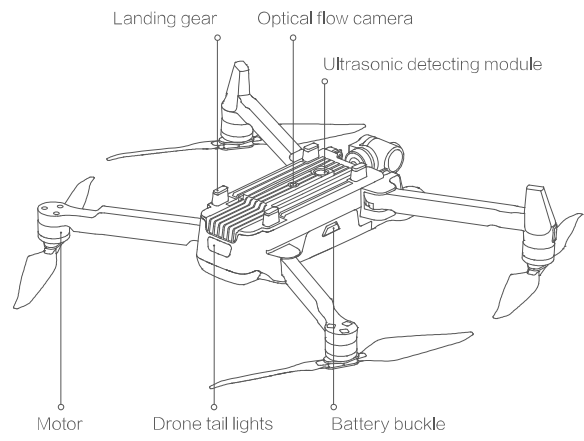
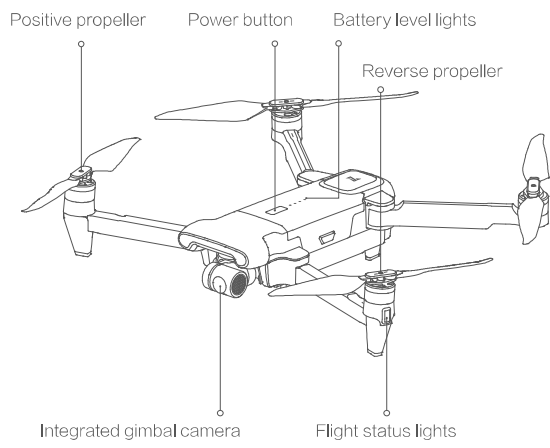

2 Remote controller

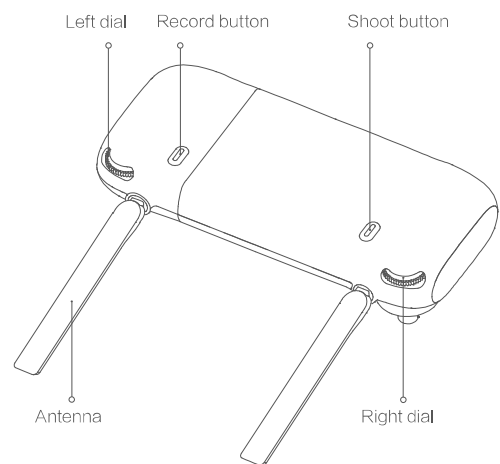
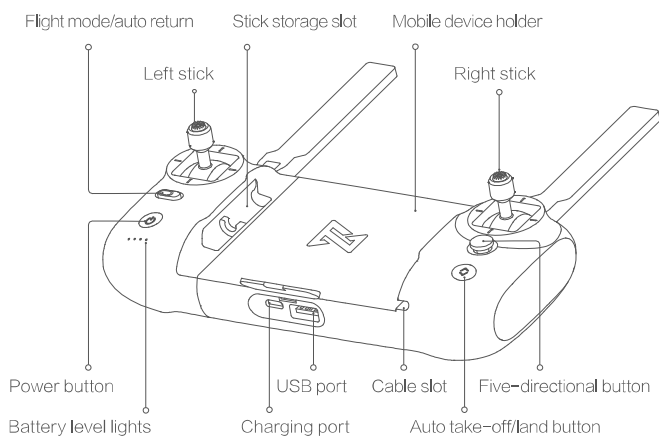

Drone

Flight Mode

GPS Mode

To achieve precise hovering, the drone is equipped with a GPS module. The intelligent flight function works in GPS mode. Users can enable Sport Mode or Beginner Mode in the flight settings. When the Beginner Mode is on, the flight speed, flight distance, flight altitude and RTH altitude will be limited. In sport mode, the maximum flight speed is 18m/s(65 km/h), the maximum ascending speed is 5m/s(18 km/h), and the maximum descending speed is 4m/s(14 km/h).

VPU Mode

An Optical Flow module is also built into the drone for precise hovering and landing at the home point. In VPU mode, the Intelligent flight function is not supported. The maximum flight speed is 10m/s(36 km/h), the maximum ascend speed is 3m/s(11 km/h), and the maximum descending speed is 2m/s (7 km/h). When the drone is flying above a well-lit ground with a clear texture and the GPS signal is poor, it will switch automatically to VPU mode.

ATTI Mode

When the GPS signal is poor or the compass has interference, the drone enters in ATTI mode. In this mode, the drone can start drifting horizontally and intelligent flight mode is not supported. Therefore, in case of any accidents, we recommend flying in an open area with good GPS signal reception. Once the drone enters in ATTI mode, please land in a safe place as soon as possible.

Note: Sport Mode will not be available when the drone is over 2400 meters above sea level.

Drone Lights

	Drone lights	Drone status
1	All lights are fading in and out	Self-checking
2	All lights are on	Drone on the ground: self-check fails
		Drone is flying: internal error
3	The red and green lights are on and the yellow light is flashing at regular intervals	Ready to fly / in flight
4	All lights flashing twice	Low battery alerts
5	All lights are flashing quickly	Very low battery alert: land as soon as possible
6	The yellow light is flashing	The firmware of the drone is updating

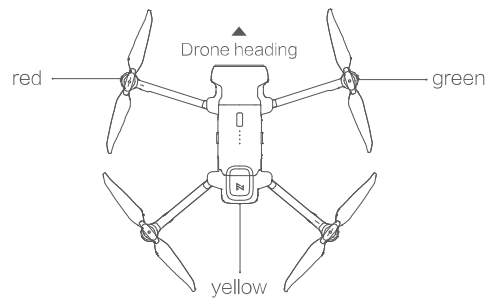

Safety Protection

Failsafe Return

Failsafe return is only supported in GPS mode. When the GPS signal is interrupted for more than 2 seconds, the flight control system built into the drone will take over the control of your drone, plan the return path according to the original flight path, then the drone will fly back and land at the home point. This function works precisely if there are enough GPS satellites are locked, the compass has no interference and the home point has been recorded correctly. If the wireless signal reconnects during the failsafe return, the pilot can turn off App return hint or toggle Auto Return switch to the left again to cancel, and the drone will hover at the current position.

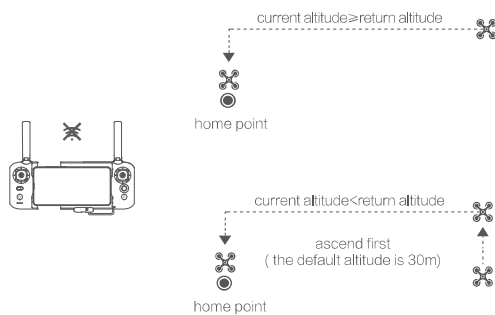

Low-power Protection

In flight, when the battery level is only enough for RTH, App advises users to return, and the drone will return automatically after 10 seconds countdown. When the battery level is only enough for landing, App advises users to land as soon as possible, and the drone will land automatically after 10 seconds countdown. When the battery level is at 10% usage left, the drone will be forced to land.

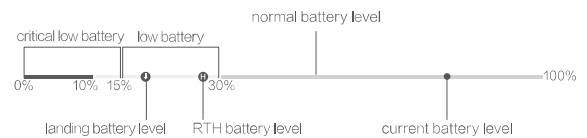

Hovering on the Edge of No-fly-zone

The drone will automatically hover in the restricted flight area designated by the state, such as the edge of airports, and the App will appear corresponding hints. The user can use sticks to fly the drone from the edge of the no-fly-zone, but the drone will not enter the no-fly-zone.



Intelligent Flight

Auto Take-off

When the conditions are right, press Auto Take-off/Landing button for 2 seconds to take off. In GPS mode, the drone will take off to an altitude of 4 meters and hover for sticks control. In VPU mode, the drone will take off to an altitude of 1.2 meters and hover for sticks control.

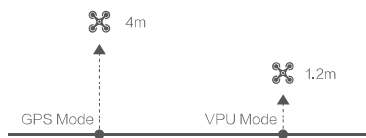

Auto Landing

When the conditions are right, press Auto Take-off/Landing button for 2 seconds to land vertically.

Note: Users can short press the auto take-off/land button to exit intelligent flight.

Auto Return

When the drone is in flight, the user can toggle the auto return switch to the right to return the drone. When the return distance is less than 10 meters and flight altitude is less than 3 meters, the drone will ascend to 3 meters first and return to the home point; if the flight altitude is greater than or equal to 3 meters, the drone will directly return to the home point. When the return distance of the drone is greater than or equal to 10 meters and the flight altitude is less than 30 meters, the drone will ascend to 30 meters and return to the home point; if the flight altitude is 30 meters or more, the drone will directly return to the home point. The user can toggle the Auto Return Switch to the left to exit.

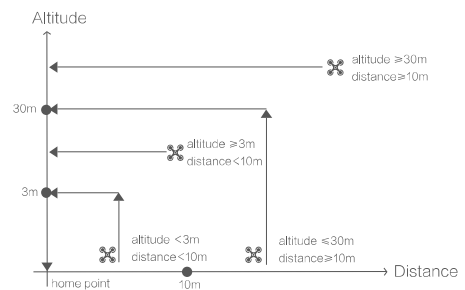

Smart Track

Smart Track is supported only in GPS mode. The user can choose Trace, Profile, or Lock in the App menu. The drone will trace the subject chosen at the App interface at a distance.

In Trace mode, the heading will always lock at the target and trace it from the back at a distance.



In Profile mode, the heading will always lock at the target and trace it from the side at a distance.



In Lock mode, the drone will hover at a place if flight speed is 0, following the target 360°. The user can also adjust flight speed, and the drone will fly around the target at a certain distance.

flight speed = 0m/s

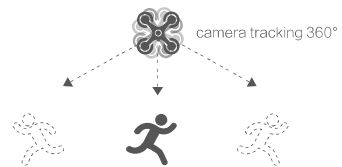

flight speed ≠ 0m/s

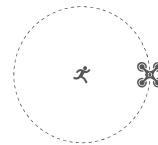

Note: In Smart Trace, users should always make sure to avoid people, animals and obstacles in the tracking path to ensure the flight safety. Users should comply with local laws and regulations when using the function.

Orbit

The user can select Orbit mode in the App. when a central point and a radius are set, the drone will fly around the central point at a default speed. If a point of interest is set, the camera will be locked at the POI.

- Fly to a central point to set the central point
- Fly away from the central point to set radius
- Set flight speed, move direction and heading. If the heading is free, the user can drag a rectangle around a POI

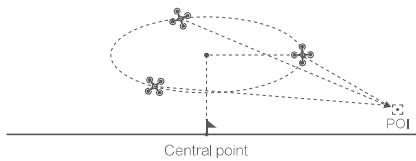

If sticks are moved in flight, the flight altitude or radius will be changed. Taking Mode 2 as example:



Tap-fly

The user can select Tap-fly in the App. Tap map to choose a destination and set flight speed, the drone will fly over there at a default speed in a straight line. If a point of interest is set, the camera will be locked at the POI

- Tap map to choose a destination
- Switch to image interface to drag a rectangle around the POI
- Set flight altitude and speed

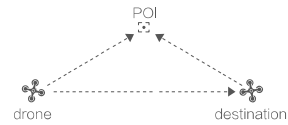

Dronie

The user can select Dronie, including Rocket and Invert, in the App. In Rocket mode, the drone flies upward with the camera pointing downward at the subject to shoot a video. In Invert mode, the drone flies backward and upward with the camera locking at the subject to shoot a video.

- Drag a rectangle around a POI
- Set flight speed and altitude, the flight control center will estimate flight time automatically
- The drone automatically adjusts its place
- 3 seconds count down to fly away to shoot a video once the drone completes adjustment

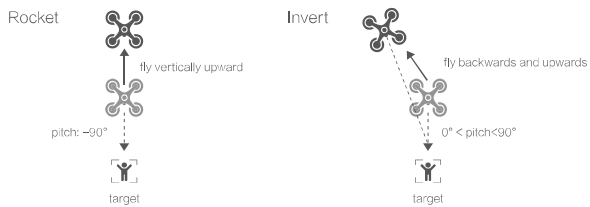

Course Lock

The user can select Course Lock mode in the App. The drone saves current fly direction as heading. The user can control sticks to adjust direction of head and gimbal, but the forward direction remains unchanged.

Tripod Mode

The max speed of the drone is 1m/s, and the max rotation speed is $60^\circ /s$. In Tripod Mode, operation sensitivity is lowered simultaneously to shoot more stable and smooth video.

Aerial Mode

The brake distance is lengthened and the angular speed of rotation is limited to make sure the shooting videos are more stable and smooth

Note: Course Lock is enabled in Aerial Mode, Users can turn it on in the APP

Spiral Mode

The user can select Spiral Mode in the App. Set the central point and radius, the drone will spirally fly upward and shoot a video simultaneously, showing a sense of space.

- Fly to a point to set as the central point
- Fly away the central point to set radius
- Set spiral direction and flight distance to start and shoot a video at the same time
- The mission interrupted if the user moves sticks

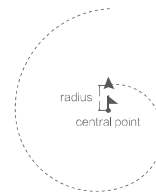

SAR Mode

The user can select SAR Mode in the APP. With real-time GPS coordinates, the drone could help user to search and rescue.

Image interface: show real-time coordinate and time of the drone, support digital zoom, screen shots to share online

Map interface: show real-time coordinate and time of the drone in ordinary map and satellite map, screen shots to share online

Waypoint

Choosing waypoint and drawing route both are available at map. The drone flies along waypoint route at a default speed. If a point of interest is set, the camera will be locked at the POI. The user can select a way to set waypoints, including choosing points in flight or on the map, historical routes.

Choosing points in flight:

1. control the drone to a point to set as a waypoint
2. using sticks to set flight altitude and heading direction, dials to set gimbal angle, and actions when reaching the waypoint
3. when all waypoints ready, please set waypoints routes attribute, including flight speed, heading direction, action at the destination
4. POI is enabled when executing waypoints

Choosing points on the map

1. tap map to add waypoint
2. set waypoint attribute, including flight altitude, action at the destination, rotate direction
3. drag the POI icon to the map, and set its altitude and relate waypoints
4. when all waypoints ready, please set flight speed, failsafe action, and action at the destination
5. POI is enabled when executing waypoints

Historical routes

1. preview the waypoints and its attribute by entering Favorite list
2. tap to start and show the real-time waypoints trace

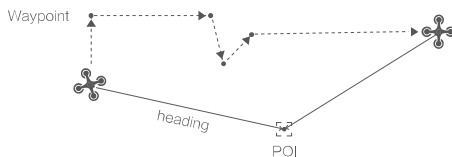

Precise Landing

In the process of Return to Home, the optical flow sensor will match landing pad features above the home point. Once matched successfully, the drone will land on the landing pad precisely.

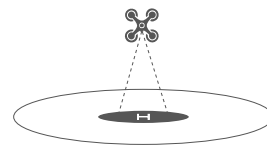

Note: Please enable precise landing in the app before use it.

Fix-wing Mode

In Fix-wing Mode, the drone can only fly forward, not backward. The user can use sticks to control flight speed and course as showed below (America Mode).

Left stick	push upward	up
	push downward	down
	toggle left	turn left
	toggle right	turn right
Right stick	push upward	accelerate
	push downward	decelerate
	toggle left	turn left
	toggle right	turn right

Assembly and Disassembly

1 Propellers

- Unfold the front and rear arms of the drone.
- Attach the gray marked propellers to the motor mounting base with gray marks on the arms.
- Ensure the propeller is pressed to the bottom of the mounting base.
- Rotate the propeller to the end of the lock direction until the propeller gets bounced and locked.
- Press the propeller forcefully and rotate the propeller along the unlock direction to remove the propeller.

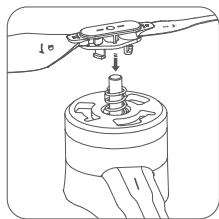

Safety tips:

If the propeller is damaged, please replace them to ensure flight safety and efficiency. Check if the propeller is properly installed and fastened before each flight. Stay away from the rotating propeller to avoid cutting.

Note: Take the installation of reverse propeller as an example.

Battery

The intelligent battery of FIMI X8 SE has a capacity of 4500mAh, a voltage of 13.05V. This type of battery employs high energy cell, advanced battery management system, and charge and discharge functionality.

Assemble and disassemble

- Push hard the battery, after the battery installed in place, there will be a "click" sound.
- To remove the battery, you need to press the battery buckle on both sides of the battery to pull out the battery.

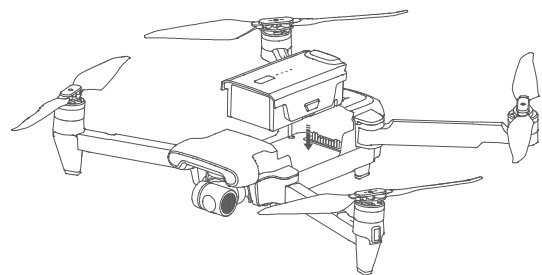

Charging

- Connect the battery, charger and AC cable as shown below, and plug the charger into a power outlet
- When the battery is in charge, the battery level lights are flashing
- When the battery is fully charged, the battery level lights go out
- It takes about 2 hours to fully charge the battery

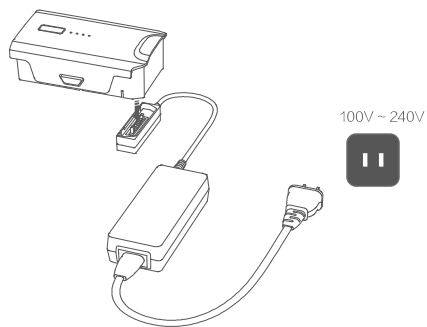

Turning on and off

- Short press+long press power button 2 seconds to power on/off
- Short press to check battery level

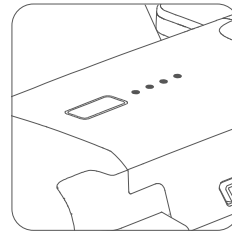

Gimbal and Camera

Camera

The camera, equipped with 1/2.3 inch CMOS and wide-angle lens with 26mm equivalent focal distance, supports 4K 30FPS HD videos and 12megapixel photos to shoot a blockbuster easier. It also owns various shooting modes, including single, burst, time lapse, panorama shot and slow motion, for different scenario.

Drone TF card

- When installing TF card to the drone, please unfold the arms of the drone first and open the interface protection cover
- Insert the TF card with the label upward into the TF card slot
- When removing TF card, press the TF card to pop out

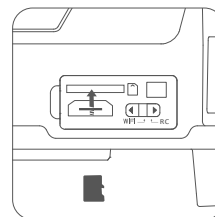

Note: Support Micro SD (U3 and above) 8 – 64GB, recommend to use
Sandisk Extreme Pro V30 32G Sandisk Extreme Pro V30 64G
Sandisk Extreme V30 32G Sandisk Extreme V30 64G
Samsung Pro Endurance 32G Toshiba Exceria Pro 64G
Lexar Professional 1000X 32G

Gimbal

FIMI X8 SE combines a light weight 3-axis mechanical gimbal with the latest professional control algorithms and $\pm 0.004^\circ$ control accuracy, which provides a stable shooting platform for camera. The pitch axis, default to tilt from 0° to -90° , can be adjusted by left dial of remote controller or App.

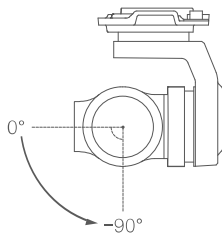

Operating Mode

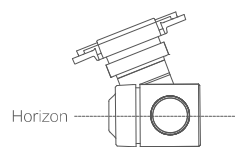

Follow Mode:

The roll axis does not move with the drone and always keep the gimbal horizontally, which suits for shooting stable videos

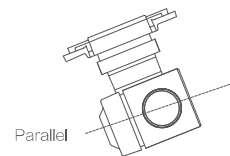

FPV Mode:

The roll axis rotates with the drone to provide a first person view

Remote controller

With ergonomic design, it is easier and more precise to control. There is no complicated operation to connect App, just plug in and it works. The remote controller fully charged can work about 4,5 hours.

Turning on and off

- Short press+long press power button 2 seconds to power on/off
- Short press to check battery level

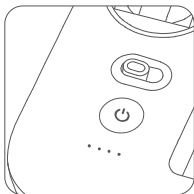

Charge

- Connect the remote controller to a power adapter as show below
- When the RC is in charge, the battery level lights are flashing
- when the RC is fully charged, the battery level lights go out
- It takes about 4 hours to fully charge the RC in the powered off condition

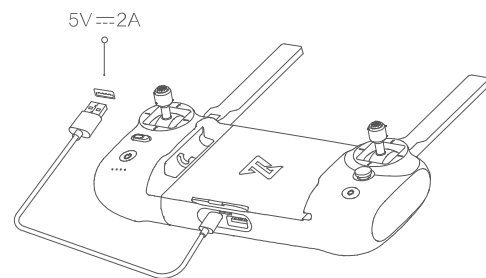

Assemble Device

- Tighten the mobile or pad on mobile device holder by extending the holder to the left.
- Open the interface protection cover on the RC bottom.
- Connect your phone and the RC with a USB cable.
- Connect the drone and update firmware according to instructions in Fimi Navi app.

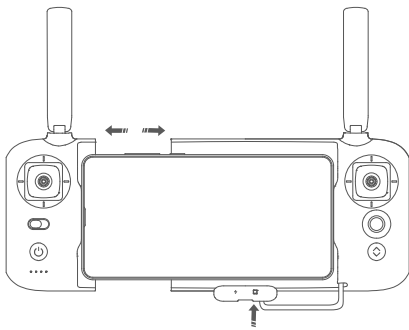

Note: The cable slot is reserved on the right side of the RC.

Shooting and Recording

- Press the shoot button to take a photo. A photo is taken when you hear 2 short sounds.
- Press the record button to record video. Recording starts when you hear 2 short sounds. Press again to stop recording with 4 short sounds.
- During recording, short press the shoot button to capture a photo (only support 1920x1080 25|30|50|60fps)
- The pitch angle of the gimbal can be controlled by toggling the left dial up and down.
- The right dial can adjust EV/ISO.

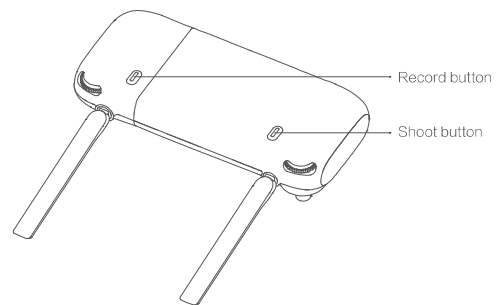

Shortcut Buttons

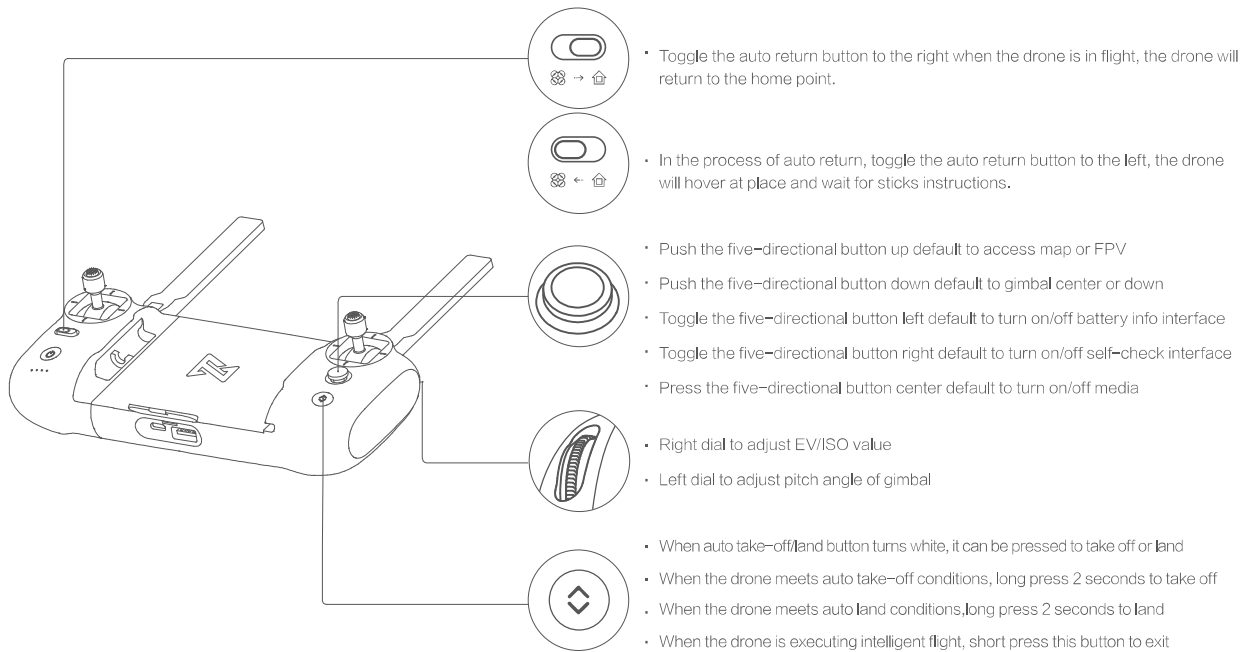

Sticks Control

Mode 1

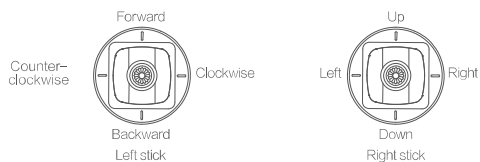

Mode 2

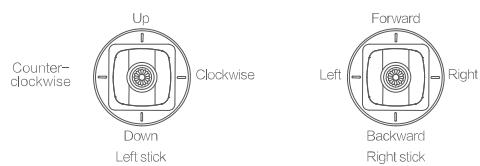

Mode 3

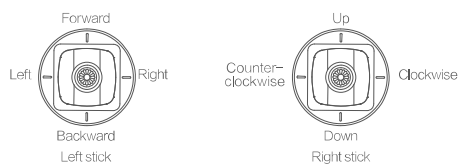

Remote Controller Pairing

When a new remote controller or drone is replaced, please pair the remote controller and the drone again as shown below:

- Turn on the drone
- Turn on the RC, long press the power button 15 seconds until hearing constant beep sound, and the power button red light flashes
- Short press the code pairing button on the drone, the yellow light on the drone goes out
- The code pairing succeeds when the power button on the RC turns white and the yellow light on the drone keeps on

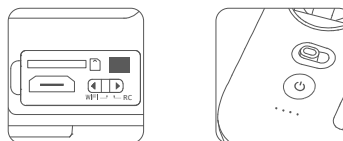

Remote lights

	Remote Lights	Remote status
1	Power button's red light is on	Weak signal or not connected to the drone
2	Power button's white light is on	Normal signal
3	Power button's red light flashes	RC Pairing or upgrading firmware
4	Power button's white light flashes	Recording videos
5	Auto take-off/landing button's red light is on	Auto take-off or landing not enabled
6	Auto take-off/landing button's white light on	Ready for auto take-off

APP

Download and install Fimi Navi app, register a FIMI user account before login, and select FIMI X8 SE to enter device

Image Interface



1. Real-time Flight Parameters

↑ 28.8m: vertical flight altitude from the home point

↔ 32.8m: horizontal distance from the home point

VS 1.23m/s: vertical speed

HS 1.80m/s: horizontal speed

⬇️ : Estimated landing battery

⬆️ : Estimated RTH battery

2. Drone Status

In flight: current flight status

GPS: current flight mode, including GPS, VPU, ATTI

⚡ : drone real-time power

3. Signal Status and General Settings

📶 : show GPS signal status, 0-6 indicates poor with red; 7-12 indicates good with yellow; 13 and above indicate excellent with white. Tap to enter flight control settings

📷 : show image transmission signal strength

📶 : show the RC signal strength, tap to enter RC setting

🔋 : show real-time battery level, tap to enter battery settings

⚙️ : tap to enter settings

⌚ : Real-time estimated flight time







4. Map Interface

Show the drone real-time location and support 3D zoom.
Tap to switch with image interface.





5. Metering Mode

tap any place in the image interface for metering, when appearing exposure lock button, click to lock the value.

6. Gimbal and Image Parameters

-  : Show the current gimbal angle
-  : Show the current EV value
-  : Show the current ISO value
-  : Show the current Shutter value
-  : Show current color mode
-  : Show the capacity of SD card and its residue
-  : Show video resolution and frame rate in video mode, or image size in photo mode















7. Camera Operation Area

- 3:26 : Video record length
-  : Camera parameter settings, tap to set EV,ISO,shutter,video or photo mode, resolution, video size, white balance, etc.
-  : Tap to switch between photo and video record
-  : Tap to start/stop shooting photos or record videos
-  : PIV button, only appear in video mode with 1080P

 : Media library, tap to download or preview videos and photos saved in Micro SD card





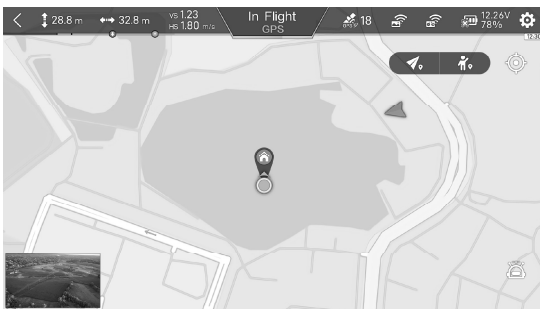

8 Intelligent Flight

Tap to enter intelligent flight interface

-  : Auto Take-off
-  : Auto Landing
-  : Auto Return
-  : Waypoints
-  : Smart Track, including Trace, Profile, Lock
-  : Orbit
-  : Tap-fly
-  : Dronie, including Rocket and Invert
-  : Spiral Mode
-  : SAR Mode
-  : Aerial Mode
-  : Tripod Mode
-  : Course Lock
-  : Fix-wing Mode

Map Interface



-  : Tap to switch between drone position in the screen center or both drone and phone position in the screen center
-  : Set current drone position as Home point
-  : Set current phone position as Home point
-  : Current drone position
-  : Home point
-  : Current phone position

Prepare to Fly

Check Before Taking off

- Make sure that the battery of the aircraft and remote controller is sufficient.
- Make sure that the propeller is properly installed and free from damage and aging.
- Make sure that the camera lens is clean.
- Make sure that the TF card is inserted.
- Keep antennas crossed as shown in the figure.

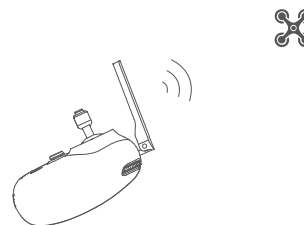

Note: To maintain stable signals, always keep antennas' longitudinal plane to the aircraft.

Confirm the drone heading

- The direction of integrated gimbal camera is the drone heading.
- Once the drone is turned on, the heading can be told by navigation lights.
- The red light and the green light indicate the heading, and the yellow light is the tail.

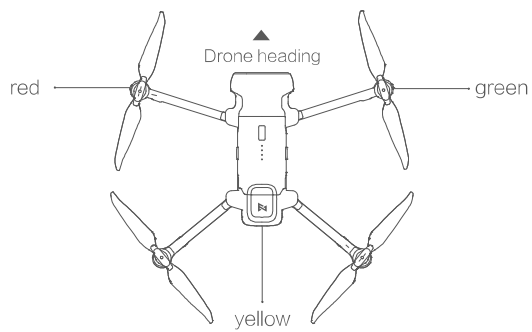

Safety tips: Always keep the tail pointed at the user to avoid direction misjudging.

Manual take off

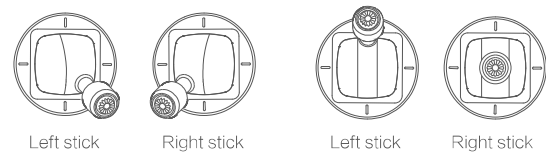

- Keep both sticks to the bottom inner still over 3 seconds, the propellers start spinning
- Release both sticks once propellers have been spinning, and firmly push the left stick upward to take off the drone
- During flight, release both sticks to hover
- At any time during controlled flight, release the sticks and the drone will hover automatically

Manual take landing

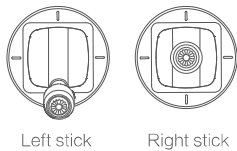

- Slowly move the left stick downward to land the drone
- Once the drone has landed, push and hold the left stick down over 5 seconds, the motors will stop

Safety tips: The drone has no waterproof function. Please be careful of landing environment. Do not land on an inclined plane for safety.

Stop propellers in an emergency

When motors can't properly turn off, please toggle the left stick to the bottom inner in maximum range, and press Auto take-off/landing button for 5 seconds simultaneously, the motors will stop.

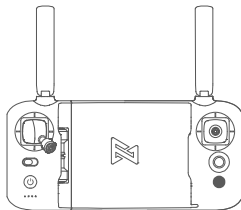

Safety tips: Do not do the above operation during normal flight to avoid motors being stopped in the air.

Flying Condition Requirement

1. The drone is suitable for people above 18 years who have full civil capacity.
2. Make sure to keep some distance from people, animals, trees, vehicles and buildings while using the drone. Please be careful when someone approaches.
3. Keep away from airports, railways, highways, high-rise buildings, utility poles and other dangerous environments when operating the drone.
4. Keep away from the areas with complex electromagnetic signals such as communication base stations and high-power antennas when operating the drone.
5. The flight altitude and distance of the drone corresponding to the take-off point will be limited based on relevant regulations and policies.
6. Do not use this product at the place and time prohibited by regulations and policies.
7. To protect the legitimate rights and interests of users, please follow the product safety instructions when using.
8. Do not operate the drone in bad weather such as strong winds, rain, snow, or fog.
9. Please operate the drone in a broad place with a good GPS signal.
10. It is suggested that user should make the first flight under the guidance of an experienced pro.

Maintenance and Calibration

Remote Controller Calibration

Please try to calibrate the remote controller when you detect inconsistencies between stick control and drone flying.

- Select "RC Calibration" in the remote controller menu
- Tap "Start" to calibrate the center, do not move sticks
- Skip to sticks calibration once the center calibration succeed
- Skip to dial calibration once the sticks calibration succeed

Note: Please turn off the power of the drone before calibrating the remote controller. RC calibration is not available in flight

Compass Calibration

If the magnetic field changes, the compass needs to be recalibrated to ensure flight safety. If the drone's compass needs to be calibrated, the App will give corresponding hints and guidance. After entering the flight control menu, please select "compass calibration", and then calibrate based on prompts on the App.

Note: Please connect the drone before calibration. Compass calibration is not available in flight.

Gimbal Calibration

- Click "gimbal calibration" and enter the calibration page in the gimbal settings menu.
- After the drone is placed smoothly, click to start calibration.
- Do not move the drone during the calibration process.
- After the calibration is completed, the App interface shows "Calibration succeed".
- If the App interface shows "Calibration failed", please recalibrate.

Note: Gimbal calibration is not available in flight.

Propellers Maintenance

Propellers are wearing parts. When they're damaged, replace them in time to ensure flight safety and efficiency.

Battery Maintenance

Do not throw the battery into fire; Do not batter the battery; Lithium battery's capacity reduces significantly in low temperature conditions. Do not use the battery when it is below 5 degrees. Do not place the battery under the burning sun.

Gimbal Maintenance

The gimbal of X8 SE, integrated with the drone, does not need to disassemble. Please be careful not to scratch the camera when store the drone. Please keep the camera clean for better image quality.

Drone Self-check

The drone enters the self-check when the drone is powered on. If the self-check failed, App will pop up corresponding hints.

Firmware Upgrade

Please check the firmware version regularly, new version will be pushed by Fimi Navi App to prompt users to update. Please download new firmware when the App is connected with the drone and remote controller

Basic Specification

Drone

Product model: FMWRJ02A5
Dimensions: 204×106×72.6mm
Diagonal size: 372mm
Take off weight: About 786g
Flight time: About 33min*
Max ascending speed: 5m/s
Max descending speed: 4m/s
Max flight speed: 18m/s
Satellite positioning systems: GPS/GLONASS
Hover accuracy:
Vertical: ±0.1m (Within the ultrasonic detecting range)
±0.5m (when GPS positioning is active) Horizontal: ±1.5m
Operating temperature: 0° C ~ 40° C
Suitable altitude: ≤5000m
Operating frequency: 5.725~5.850GHz

Charger

Rated input: 100~240V~50/60Hz 1.5A
Rated output: 13.05V = 3A
Rated power: 39.15W

Remote controller

Net weight: About 373g
Dimensions: 203,8×91×46.6mm
Operating frequency: 5.725~5.850GHz
Type: Rechargeable Lithium battery
Capacity: 3900mAh
Nominal voltage: 3.7V
Input: 5 V = 2A
Max transmission distance: About 5000m*
Operating temperature: 0 ~ 40° C
Suitable altitude: ≤5000m

Battery

Type: Rechargeable Lithium battery pack
Weight: About 275g
Capacity: 4500mAh
Voltage: 11.4V
Limit voltage: 13.05V
Energy: 51.3Wh
Charging ambient temperature: 0° C ~ 40° C

Gimbal

Controllable rotation range: 0° ~ -90° (Pitch)
Angular vibration range: ± 0.004°
Lens: FOV 78.8°
Camera aperture: f2.2
Camera focal distance: 4.73mm
Equivalent focal distance: 26mm
Sensor: 1/2.3" CMOS
Effective pixels: 12M
ISO range: 100 ~ 3200 (Video) , 100 ~ 1600 (Photo)
Shutter speed: 8 ~ 1/8000s
Max video resolution: 3840×2160 | 30fps | 25fps | 24fps
Max bitrate: 100Mbps
Max photo resolution: 4000×3000
File system: FAT32 / exFAT
Image format: JPG, JPG+DNG
Video format: MP4
Memory card type: Micro SD (U3 and above) 8 ~ 64GB

Note:

The 33 minutes flight time refers to constant speed at 7m/s (no wind) with fully charged and low cyclic battery. Remote control distance reach to 5km (FCC) in open area and no interference. All above testing and data come from FIMI laboratory, errors may occur in actual use for operating and environmental changes.

This device complies with Part 15 of the FCC Rules. Operation is subject to the following two conditions:

- (1) this device may not cause harmful interference, and
- (2) this device must accept any interference received, including interference that may cause undesired operation.

FCC warning:

Any Changes or modifications not expressly approved by the party responsible for compliance could void the user's authority to operate the equipment.

Note: This equipment has been tested and found to comply with the limits for a Class B digital device, pursuant to part 15 of the FCC Rules. These limits are designed to provide reasonable protection against harmful interference in a residential installation. This equipment generates uses and can radiate radio frequency energy and, if not installed and used in accordance with the instructions, may cause harmful interference to radio communications. However, there is no guarantee that interference will not occur in a particular installation. If this equipment does cause harmful interference to radio or television reception, which can be determined by turning the equipment off and on, the user is encouraged to try to correct the interference by one or more of the following measures:

- Reorient or relocate the receiving antenna.
- Increase the separation between the equipment and receiver.
- Connect the equipment into an outlet on a circuit different from that to which the receiver is connected.
- Consult the dealer or an experienced radio/TV technician for help.

This equipment complies with FCC radiation exposure limits set forth for an uncontrolled environment. This equipment should be installed and operated with minimum distance 20cm between the radiator & your body.