



中认信通
CHINA CERTIFICATION ICT CO., LTD (DONGGUAN)



TEST REPORT

Applicant: CLC HONG KONG LIMITED

Address: 802, 8/F., Harbour Centre Tower 1, No.1 Hok Cheung St., Hung Hom,
Kowloon, Hong Kong

FCC ID: 2AG4WE920

Product Name: Ram 10

Model Number: E920

Standard(s): 47 CFR Part 15, Subpart C(15.247)
ANSI C63.10-2013
KDB 558074 D01 15.247 Meas Guidance v05r02

The above equipment has been tested and found compliance with the requirement of the relative standards by China Certification ICT Co., Ltd (Dongguan)

Report Number: CR21110014-00A

Date Of Issue: 2021-12-17

Reviewed By: Sun Zhong

Sun Zhong

Title: Manager

Test Laboratory: China Certification ICT Co., Ltd (Dongguan)
No. 113, Pingkang Road, Dalang Town, Dongguan,
Guangdong, China
Tel: +86-769-82016888

Test Facility

The Test site used by China Certification ICT Co., Ltd (Dongguan) to collect test data is located on the No. 113, Pingkang Road, Dalang Town, Dongguan, Guangdong, China.

The lab has been recognized as the FCC accredited lab under the KDB 974614 D01 and is listed in the FCC Public Access Link (PAL) database, FCC Registration No. : 442868, the FCC Designation No. : CN1314.

The lab has been recognized by Innovation, Science and Economic Development Canada to test to Canadian radio equipment requirements, the CAB identifier: CN0123.

Declarations

China Certification ICT Co., Ltd (Dongguan) is not responsible for the authenticity of any test data provided by the applicant. Data included from the applicant that may affect test results are marked with a triangle symbol “▲”. Customer model name, addresses, names, trademarks etc. are not considered data.

Unless otherwise stated the results shown in this test report refer only to the sample(s) tested.

This report cannot be reproduced except in full, without prior written approval of the Company.

This report is valid only with a valid digital signature. The digital signature may be available only under the Adobe software above version 7.0.

This report may contain data that are not covered by the accreditation scope and shall be marked with an asterisk “★”.

CONTENTS

| | |
|---|-----------|
| TEST FACILITY | 2 |
| DECLARATIONS..... | 2 |
| 1. GENERAL INFORMATION | 5 |
| 1.1 PRODUCT DESCRIPTION FOR EQUIPMENT UNDER TEST (EUT) | 5 |
| 1.2 DESCRIPTION OF TEST CONFIGURATION..... | 6 |
| 1.2.2 Support Equipment List and Details | 6 |
| 1.2.3 Support Cable List and Details | 6 |
| 1.2.4 Block Diagram of Test Setup..... | 7 |
| 1.3 MEASUREMENT UNCERTAINTY | 9 |
| 2. SUMMARY OF TEST RESULTS | 10 |
| 3. REQUIREMENTS AND TEST PROCEDURES | 11 |
| 3.1 AC LINE CONDUCTED EMISSIONS..... | 11 |
| 3.1.1 Applicable Standard..... | 11 |
| 3.1.2 EUT Setup..... | 12 |
| 3.1.3 EMI Test Receiver Setup | 12 |
| 3.1.4 Test Procedure | 13 |
| 3.1.5 Corrected Amplitude & Margin Calculation..... | 13 |
| 3.2 RADIATION SPURIOUS EMISSIONS | 14 |
| 3.2.1 Applicable Standard..... | 14 |
| 3.2.2 EUT Setup..... | 14 |
| 3.2.3 EMI Test Receiver & Spectrum Analyzer Setup | 15 |
| 3.2.4 Test Procedure | 15 |
| 3.2.5 Corrected Amplitude & Margin Calculation..... | 15 |
| 3.3 20 DB BANDWIDTH..... | 16 |
| 3.3.1 Applicable Standard..... | 16 |
| 3.3.2 EUT Setup..... | 16 |
| 3.3.3 Test Procedure | 16 |
| 3.4 CHANNEL SEPARATION | 16 |
| 3.4.1 Applicable Standard..... | 16 |
| 3.4.2 EUT Setup..... | 17 |
| 3.4.3 Test Procedure | 17 |
| 3.5 NUMBER OF HOPPING FREQUENCY | 17 |
| 3.5.1 Applicable Standard..... | 17 |
| 3.5.2 EUT Setup..... | 17 |
| 3.5.3 Test Procedure | 18 |
| 3.6 TIME OF OCCUPANCY(DWELL TIME)..... | 18 |
| 3.6.1 Applicable Standard..... | 18 |
| 3.6.2 EUT Setup..... | 18 |
| 3.6.3 Test Procedure | 18 |
| 3.7 PEAK OUTPUT POWER..... | 19 |
| 3.7.1 Applicable Standard..... | 19 |

3.7.2 EUT Setup.....19

3.7.3 Test Procedure19

3.8 100 kHz BANDWIDTH OF FREQUENCY BAND EDGE.....19

3.8.1 Applicable Standard.....19

3.8.2 EUT Setup.....19

3.8.3 Test Procedure19

3.9 ANTENNA REQUIREMENT.....20

3.9.1 Applicable Standard.....20

3.9.2 Judgment.....20

4. TEST DATA AND RESULTS 21

4.1 AC LINE CONDUCTED EMISSIONS.....21

4.2 RADIATION SPURIOUS EMISSIONS24

4.3 20 dB EMISSION BANDWIDTH:30

4.4 CHANNEL SEPARATION:34

4.5 NUMBER OF HOPPING FREQUENCY:38

4.6 TIME OF OCCUPANCY(DWELL TIME):.....40

4.7 PEAK CONDUCTED OUTPUT POWER:44

4.8 100 kHz BANDWIDTH OF FREQUENCY BAND EDGE:45

5. RF EXPOSURE EVALUATION 52

5.1 APPLICABLE STANDARD.....52

5.2 PROCEDURE.....52

5.3 MEASUREMENT RESULT52

1. GENERAL INFORMATION

1.1 Product Description for Equipment under Test (EUT)

| | |
|---|--|
| EUT Name: | Ram 10 |
| EUT Model: | E920 |
| Operation Frequency: | 2402-2480 MHz |
| Maximum Peak Output Power (Conducted): | 2.10 dBm |
| Modulation Type: | GFSK, $\pi/4$ -DQPSK, 8DPSK |
| Rated Input Voltage: | DC 3.7V from battery or DC 5V from adapter |
| Serial Number: | CR21110014-RF-S1 |
| EUT Received Date: | 2021.11.10 |
| EUT Received Status: | GOOD |

Operation Frequency Detail:

| Channel | Frequency (MHz) | Channel | Frequency (MHz) |
|---------|-----------------|---------|-----------------|
| 0 | 2402 | 40 | 2442 |
| 1 | 2403 | 41 | 2443 |
| ... | ... | ... | ... |
| ... | ... | ... | ... |
| .. | ... | 78 | 2480 |
| 39 | 2441 | / | / |

Per section 15.31(m), the lowest frequency, middle frequency, and highest frequency were performed the test as below:

| Test Channel | Frequency (MHz) |
|--------------|-----------------|
| Lowest | 2402 |
| Middle | 2441 |
| Highest | 2480 |

Antenna Information Detail▲:

| Antenna Manufacturer | Antenna Type | input impedance (Ohm) | Antenna Gain /Frequency Range | §15.203 Requirement |
|-----------------------|--------------|-----------------------|-------------------------------|---------------------|
| CLC HONG KONG LIMITED | FPC | 50 | 0 dBi/ 2.4~2.5GHz | Compliance |

The Method of §15.203 Compliance:

- Antenna must be permanently attached to the unit.
- Antenna must use a unique type of connector to attach to the EUT.
- Unit must be professionally installed, and installer shall be responsible for verifying that the correct antenna is employed with the unit.

Accessory Information:

| Accessory Description | Manufacturer | Model | Parameters |
|-----------------------|--------------|-------|--|
| Adapter | plum | PMC43 | Input: 100-240V~50/60Hz Output: 5V 1A |

1.2 Description of Test Configuration

1.2.1 EUT Operation Condition:

| | | | |
|--|--|---------|---------|
| EUT Operation Mode: | The system was configured for testing in Engineering Mode, which was provided by the manufacturer. | | |
| Equipment Modifications: | No | | |
| EUT Exercise Software: | Engineering Mode | | |
| The software " Engineering Mode "was provided by manufacturer. The maximum power was configured as below, that was provided by the manufacturer ▲: | | | |
| Test Modes | Power Level Setting | | |
| | Lowest | Middle | Highest |
| GFSK | Default | Default | Default |
| $\pi/4$ -DQPSK | Default | Default | Default |
| 8DPSK | Default | Default | Default |

1.2.2 Support Equipment List and Details

| Manufacturer | Description | Model | Serial Number |
|--------------|-------------|---------|---------------|
| Unknown | Earphone | Unknown | Earphone 01 |

1.2.3 Support Cable List and Details

| Cable Description | Shielding Type | Ferrite Core | Length (m) | From Port | To |
|-------------------|----------------|--------------|------------|-----------|----------|
| Earphone Cable | No | No | 1.2 | EUT | Earphone |
| USB Cable | No | No | 1.2 | Adapter | EUT |

1.2.4 Block Diagram of Test Setup

AC line conducted emissions:

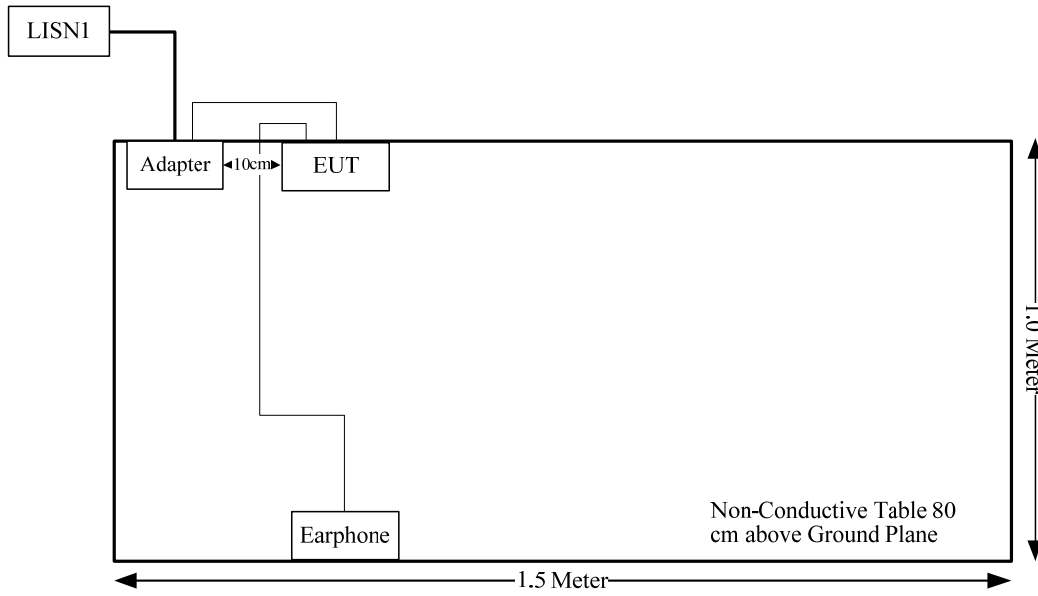

Spurious Emissions:
Below 1GHz:

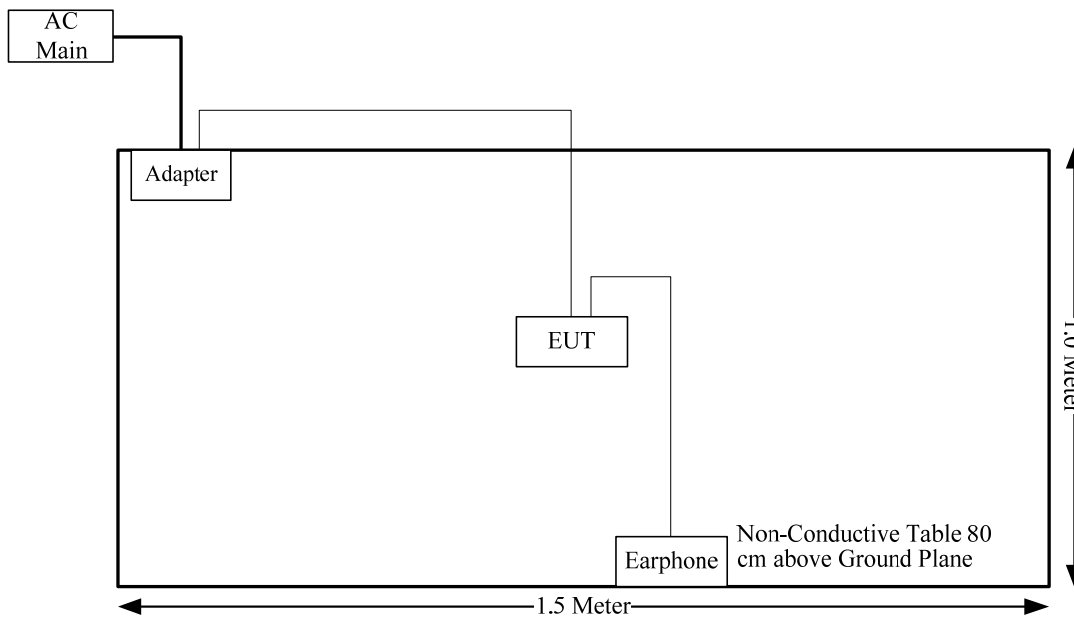

Above 1GHz:

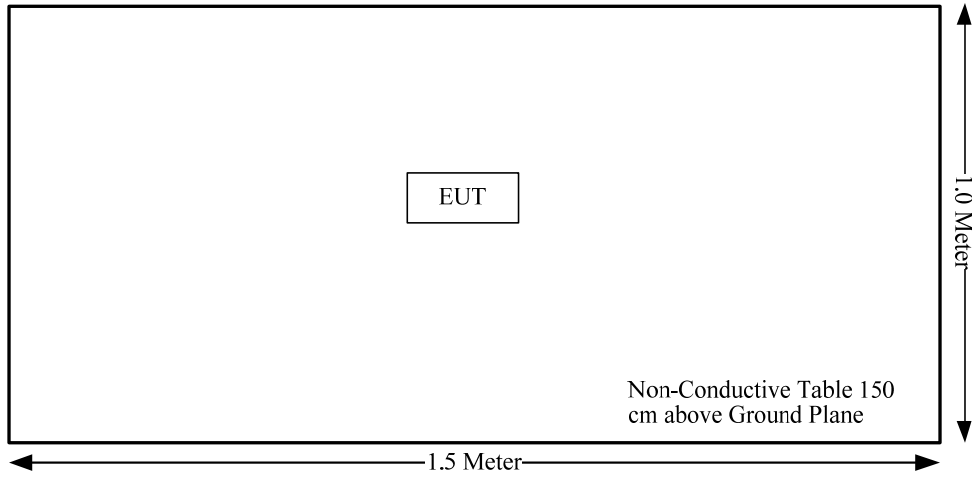

1.3 Measurement Uncertainty

Otherwise required by the applicant or Product Regulations, Decision Rule in this report did not consider the uncertainty. The extended uncertainty given in this report is obtained by combining the standard uncertainty times the coverage factor K with the 95% confidence interval.

| Parameter | Measurement Uncertainty |
|-----------------------------------|---|
| Occupied Channel Bandwidth | ±5 % |
| RF output power, conducted | ±0.61dB |
| Power Spectral Density, conducted | ±0.61 dB |
| Unwanted Emissions, radiated | 30M~200MHz: 4.15 dB,200M~1GHz: 5.61 dB,1G~6GHz: 5.14 dB, 6G~18GHz: 5.93 dB,18G~26.5G:5.47 dB,26.5G~40G:5.63 dB |
| Unwanted Emissions, conducted | ±1.26 dB |
| Temperature | ±1 °C |
| Humidity | ±5% |
| DC and low frequency voltages | ±0.4% |
| Duty Cycle | 1% |
| AC Power Lines Conducted Emission | 2.8 dB (150 kHz to 30 MHz) |

2. SUMMARY OF TEST RESULTS

| FCC Rules | Description of Test | Result |
|---------------------------------------|--------------------------------|------------|
| FCC §15.207(a) | AC line conducted emissions | Compliance |
| FCC §15.205, §15.209, §15.247(d) | Spurious emissions | Compliance |
| FCC §15.247(a)(1) | 20 dB bandwidth | Compliance |
| FCC §15.247(a)(1) | Channel separation | Compliance |
| FCC §15.247(a)(1)(iii) | Number of hopping Frequency | Compliance |
| FCC §15.247(a)(1)(iii) | Time of occupancy (dwell time) | Compliance |
| FCC §15.247(b)(1) | Peak output power measurement | Compliance |
| FCC §15.247(d) | Band edges | Compliance |
| FCC §15.203 | Antenna requirement | Compliance |
| FCC§15.247 (i) & §1.1310 & §2.1093 | RF Exposure | Compliance |

3. REQUIREMENTS AND TEST PROCEDURES

3.1 AC Line Conducted Emissions

3.1.1 Applicable Standard

FCC§15.207(a).

(a) Except as shown in paragraphs (b) and (c) of this section, for an intentional radiator that is designed to be connected to the public utility (AC) power line, the radio frequency voltage that is conducted back onto the AC power line on any frequency or frequencies, within the band 150 kHz to 30 MHz, shall not exceed the limits in the following table, as measured using a 50 μ H/50 ohms line impedance stabilization network (LISN). Compliance with the provisions of this paragraph shall be based on the measurement of the radio frequency voltage between each power line and ground at the power terminal. The lower limit applies at the boundary between the frequency ranges.

| Frequency of emission (MHz) | Conducted limit (dB μ V) | |
|-----------------------------|------------------------------|-----------|
| | Quasi-peak | Average |
| 0.15-0.5 | 66 to 56* | 56 to 46* |
| 0.5-5 | 56 | 46 |
| 5-30 | 60 | 50 |

*Decreases with the logarithm of the frequency.

(b) The limit shown in paragraph (a) of this section shall not apply to carrier current systems operating as intentional radiators on frequencies below 30 MHz. In lieu thereof, these carrier current systems shall be subject to the following standards:

(1) For carrier current system containing their fundamental emission within the frequency band 535-1705 kHz and intended to be received using a standard AM broadcast receiver: no limit on conducted emissions.

(2) For all other carrier current systems: 1000 μ V within the frequency band 535-1705 kHz, as measured using a 50 μ H/50 ohms LISN.

(3) Carrier current systems operating below 30 MHz are also subject to the radiated emission limits in §15.205, §15.209, §15.221, §15.223, or §15.227, as appropriate.

(c) Measurements to demonstrate compliance with the conducted limits are not required for devices which only employ battery power for operation and which do not operate from the AC power lines or contain provisions for operation while connected to the AC power lines. Devices that include, or make provisions for, the use of battery chargers which permit operating while charging, AC adapters or battery eliminators or that connect to the AC power lines indirectly, obtaining their power through another device which is connected to the AC power lines, shall be tested to demonstrate compliance with the conducted limits.

3.1.2 EUT Setup

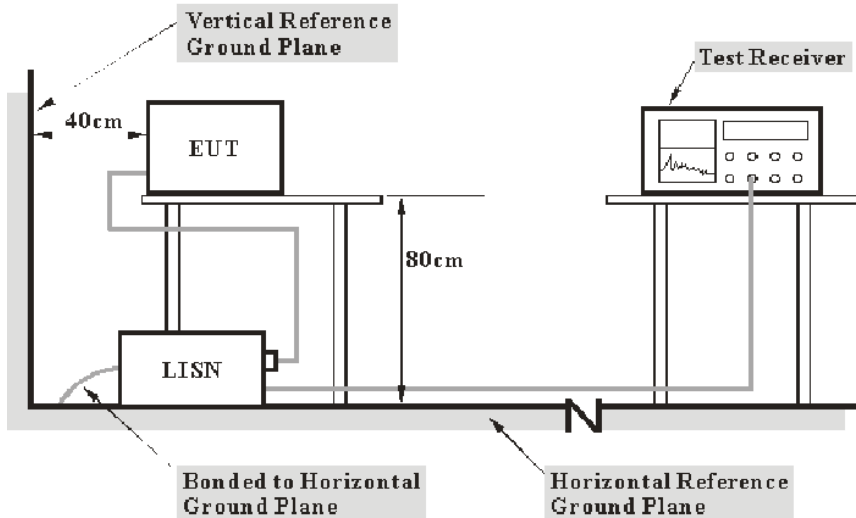

- Note: 1. Support units were connected to second LISN.
 2. Both of LISNs (AMN) 80 cm from EUT and at the least 80 cm from other units and other metal planes support units.

The setup of EUT is according with per ANSI C63.10-2013 measurement procedure. The specification used was with the FCC Part 15.207 limits.

The spacing between the peripherals was 10 cm.

The adapter or EUT was connected to the main LISN with a 120 V/60 Hz AC power source.

3.1.3 EMI Test Receiver Setup

The EMI test receiver was set to investigate the spectrum from 150 kHz to 30 MHz.

During the conducted emission test, the EMI test receiver was set with the following configurations:

| Frequency Range | IF B/W |
|------------------|--------|
| 150 kHz – 30 MHz | 9 kHz |

3.1.4 Test Procedure

The frequency and amplitude of the six highest ac power-line conducted emissions relative to the limit, measured over all the current-carrying conductors of the EUT power cords, and the operating frequency or frequency to which the EUT is tuned (if appropriate), should be reported, unless such emissions are more than 20 dB below the limit. AC power-line conducted emissions measurements are to be separately carried out only on each of the phase (“hot”) line(s) and (if used) on the neutral line(s), but not on the ground [protective earth] line(s). If less than six emission frequencies are within 20 dB of the limit, then the noise level of the measuring instrument at representative frequencies should be reported. The specific conductor of the power-line cord for each of the reported emissions should be identified. Measure the six highest emissions with respect to the limit on each current-carrying conductor of each power cord associated with the EUT (but not the power cords of associated or peripheral equipment that are part of the test configuration). Then, report the six highest emissions with respect to the limit from among all the measurements identifying the frequency and specific current-carrying conductor identified with the emission. The six highest emissions should be reported for each of the current-carrying conductors, or the six highest emissions may be reported over all the current-carrying conductors.

3.1.5 Corrected Amplitude & Margin Calculation

The basic equation is as follows:

Result = Reading + Factor

Factor = attenuation caused by cable loss + voltage division factor of AMN

The “**Margin**” column of the following data tables indicates the degree of compliance within the applicable limit. The equation for margin calculation is as follows:

Margin = Limit – Result

3.2 Radiation Spurious Emissions

3.2.1 Applicable Standard

FCC §15.247 (d);

In any 100 kHz bandwidth outside the frequency band in which the spread spectrum or digitally modulated intentional radiator is operating, the radio frequency power that is produced by the intentional radiator shall be at least 20 dB below that in the 100 kHz bandwidth within the band that contains the highest level of the desired power, based on either an RF conducted or a radiated measurement, provided the transmitter demonstrates compliance with the peak conducted power limits. If the transmitter complies with the conducted power limits based on the use of RMS averaging over a time interval, as permitted under paragraph (b)(3) of this section, the attenuation required under this paragraph shall be 30 dB instead of 20 dB. Attenuation below the general limits specified in §15.209(a) is not required. In addition, radiated emissions which fall in the restricted bands, as defined in §15.205(a), must also comply with the radiated emission limits specified in §15.209(a) (see §15.205(c)).

3.2.2 EUT Setup

Below 1GHz:

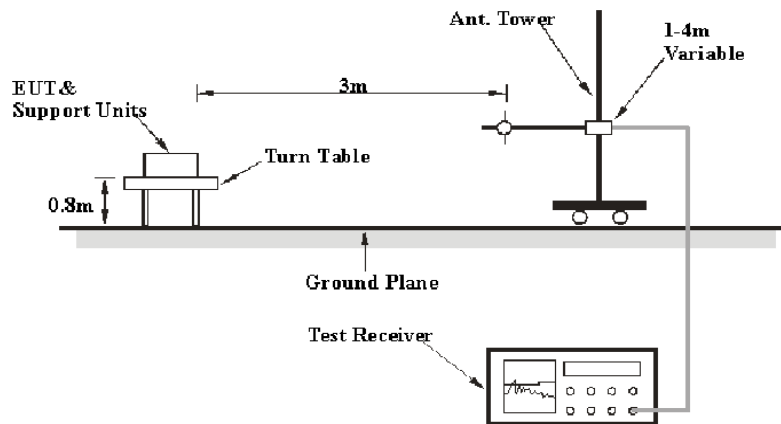

Above 1GHz:

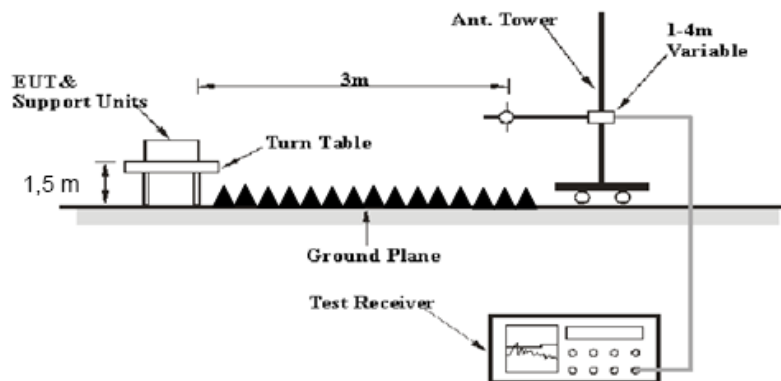

The radiated emissions were performed in the 3 meters distance, using the setup accordance with the ANSI C63.10-2013. The specification used was the FCC 15.209, and FCC 15.247 limits.

The external I/O cables were draped along the test table and formed a bundle 30 to 40 cm long in the middle.

The spacing between the peripherals was 10 cm.

3.2.3 EMI Test Receiver & Spectrum Analyzer Setup

During the radiated emission test, the EMI test receiver & Spectrum Analyzer Setup were set with the following configurations:

| Frequency Range | RBW | Video B/W | IF B/W | Measurement |
|-------------------|---------|-----------|---------|-------------|
| 30 MHz – 1000 MHz | 120 kHz | 300 kHz | 120 kHz | QP |
| Above 1 GHz | 1MHz | 3 MHz | / | PK |
| | 1MHz | 10 Hz | / | AV |

If the maximized peak measured value complies with under the QP/Average limit more than 6dB, then it is unnecessary to perform an QP/Average measurement.

3.2.4 Test Procedure

Maximizing procedure was performed on the highest emissions to ensure that the EUT complied with all installation combinations.

Data was recorded in Quasi-peak detection mode for frequency range of 30 MHz-1 GHz, peak and Average detection modes for frequencies above 1 GHz.

3.2.5 Corrected Amplitude & Margin Calculation

The basic equation is as follows:

Result = Reading + Factor

Factor = Antenna Factor + Cable Loss- Amplifier Gain

The “**Margin**” column of the following data tables indicates the degree of compliance within the applicable limit. The equation for margin calculation is as follows:

Margin = Limit – Result

3.3 20 dB Bandwidth

3.3.1 Applicable Standard

FCC §15.247 (a)(1)

Frequency hopping systems shall have hopping channel carrier frequencies separated by a minimum of 25 kHz or the 20 dB bandwidth of the hopping channel, whichever is greater. Alternatively, frequency hopping systems operating in the 2400-2483.5 MHz band may have hopping channel carrier frequencies that are separated by 25 kHz or two-thirds of the 20 dB bandwidth of the hopping channel, whichever is greater, provided the systems operate with an output power no greater than 125 mW. The system shall hop to channel frequencies that are selected at the system hopping rate from a pseudo randomly ordered list of hopping frequencies. Each frequency must be used equally on the average by each transmitter. The system receivers shall have input bandwidths that match the hopping channel bandwidths of their corresponding transmitters and shall shift frequencies in synchronization with the transmitted signals.

3.3.2 EUT Setup

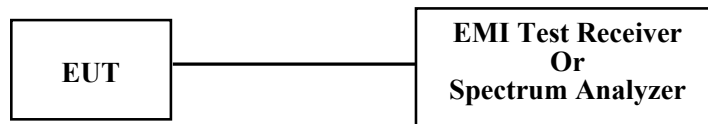

3.3.3 Test Procedure

1. Check the calibration of the measuring instrument using either an internal calibrator or a known signal from an external generator.
2. Position the EUT on the test table without connection to measurement instrument. Turn on the EUT. Then set it to any one convenient frequency within its operating range. Set a reference level on the measuring instrument equal to the highest peak value.
3. Measure the frequency difference of two frequencies that were attenuated 20 dB from the reference level. Record the frequency difference as the emission bandwidth.
4. Repeat above procedures until all frequencies measured were complete.

3.4 Channel Separation

3.4.1 Applicable Standard

FCC §15.247 (a)(1)

Frequency hopping systems shall have hopping channel carrier frequencies separated by a minimum of 25 kHz or the 20 dB bandwidth of the hopping channel, whichever is greater. Alternatively, frequency hopping systems operating in the 2400-2483.5 MHz band may have hopping channel carrier frequencies that are separated by 25 kHz or two-thirds of the 20 dB bandwidth of the hopping channel, whichever is greater, provided the systems operate with an output power no greater than 125 mW. The system shall hop to channel frequencies that are selected at the system hopping rate from a pseudo randomly ordered list of hopping frequencies. Each frequency must be used equally on the average by each transmitter. The system receivers shall have input bandwidths that match the hopping channel bandwidths of their corresponding transmitters and shall shift frequencies in synchronization with the transmitted signals.

3.4.2 EUT Setup

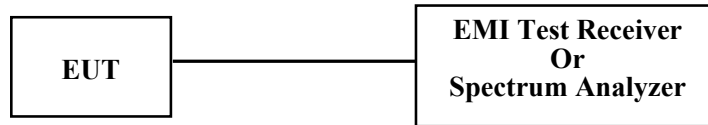

3.4.3 Test Procedure

According to ANSI C63.10-2013 Section 7.8.2

The EUT shall have its hopping function enabled. Use the following spectrum analyzer settings:

- a) Span: Wide enough to capture the peaks of two adjacent channels.
- b) RBW: Start with the RBW set to approximately 30% of the channel spacing; adjust as necessary to best identify the center of each individual channel.
- c) Video (or average) bandwidth (VBW) \geq RBW.
- d) Sweep: Auto.
- e) Detector function: Peak.
- f) Trace: Max hold.
- g) Allow the trace to stabilize.

Use the marker-delta function to determine the separation between the peaks of the adjacent channels. Compliance of an EUT with the appropriate regulatory limit shall be determined. A plot of the data shall be included in the test report.

3.5 Number Of Hopping Frequency

3.5.1 Applicable Standard

FCC §15.247 (a)(1)(iii)

Frequency hopping systems in the 2400–2483.5 MHz band shall use at least 15 channels. The average time of occupancy on any channel shall not be greater than 0.4 seconds within a period of 0.4 seconds multiplied by the number of hopping channels employed. Frequency hopping systems may avoid or suppress transmissions on a particular hopping frequency provided that a minimum of 15 channels are used.

3.5.2 EUT Setup

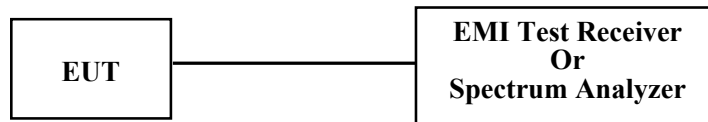

3.5.3 Test Procedure

According to ANSI C63.10-2013 Section 7.8.3

The EUT shall have its hopping function enabled. Use the following spectrum analyzer settings:

- a) Span: The frequency band of operation. Depending on the number of channels the device supports, it may be necessary to divide the frequency range of operation across multiple spans, to allow the individual channels to be clearly seen.
- b) RBW: To identify clearly the individual channels, set the RBW to less than 30% of the channel spacing or the 20 dB bandwidth, whichever is smaller.
- c) VBW \geq RBW.
- d) Sweep: Auto.
- e) Detector function: Peak.
- f) Trace: Max hold.
- g) Allow the trace to stabilize

It might prove necessary to break the span up into subranges to show clearly all of the hopping frequencies. Compliance of an EUT with the appropriate regulatory limit shall be determined for the number of hopping channels. A plot of the data shall be included in the test report.

3.6 Time Of Occupancy(Dwell Time)

3.6.1 Applicable Standard

Frequency hopping systems in the 2400-2483.5 MHz shall use at least 15 channels. The average time of occupancy on any channel shall not be greater than 0.4 seconds within a period of 0.4 seconds multiplied by the number of hopping channels employed. Frequency hopping systems may avoid or suppress transmissions on a particular hopping frequency provided that a minimum of 15 channels are used.

3.6.2 EUT Setup



3.6.3 Test Procedure

The EUT was worked in channel hopping; the time of single pulses was tested.

3.7 Peak Output Power

3.7.1 Applicable Standard

FCC §15.247 (b)(1)

For frequency hopping systems operating in the 2400–2483.5 MHz band employing at least 75 non-overlapping hopping channels, and all frequency hopping systems in the 5725-5850 MHz band: 1 watt. For all other frequency hopping systems in the 2400–2483.5 MHz band: 0.125 watts

3.7.2 EUT Setup

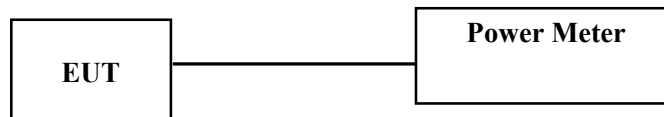

3.7.3 Test Procedure

1. Remove the antenna from the EUT and then connect a low loss RF cable from the antenna port to one test equipment.
2. Add a correction factor to the display.

3.8 100 kHz Bandwidth of Frequency Band Edge

3.8.1 Applicable Standard

FCC §15.247 (d);

In any 100 kHz bandwidth outside the frequency band in which the spread spectrum or digitally modulated intentional radiator is operating, the radio frequency power that is produced by the intentional radiator shall be at least 20 dB below that in the 100 kHz bandwidth within the band that contains the highest level of the desired power, based on either an RF conducted or a radiated measurement, provided the transmitter demonstrates compliance with the peak conducted power limits. If the transmitter complies with the conducted power limits based on the use of RMS averaging over a time interval, as permitted under paragraph (b)(3) of this section, the attenuation required under this paragraph shall be 30 dB instead of 20 dB. Attenuation below the general limits specified in §15.209(a) is not required. In addition, radiated emissions which fall in the restricted bands, as defined in §15.205(a), must also comply with the radiated emission limits specified in §15.209(a) (see §15.205(c)).

3.8.2 EUT Setup



3.8.3 Test Procedure

- a) Set the center frequency and span to encompass frequency range to be measured.
- b) Set the RBW = 100 kHz.
- c) Set the VBW $\geq [3 \times \text{RBW}]$.
- d) Detector = peak.
- e) Sweep time = auto couple.
- f) Trace mode = max hold.

g) Allow trace to fully stabilize.

h) Use the peak marker function to determine the maximum amplitude level.

Ensure that the amplitude of all unwanted emissions outside of the authorized frequency band (excluding restricted frequency bands) is attenuated by at least the minimum requirements specified in 11.11. Report the three highest emissions relative to the limit.

3.9 Antenna Requirement

3.9.1 Applicable Standard

FCC §15.203

An intentional radiator shall be designed to ensure that no antenna other than that furnished by the responsible party shall be used with the device. The use of a permanently attached antenna or of an antenna that uses a unique coupling to the intentional radiator shall be considered sufficient to comply with the provisions of this section. The manufacturer may design the unit so that a broken antenna can be replaced by the user, but the use of a standard antenna jack or electrical connector is prohibited. This requirement does not apply to carrier current devices or to devices operated under the provisions of §§15.211, 15.213, 15.217, 15.219, 15.221, or §15.236. Further, this requirement does not apply to intentional radiators that must be professionally installed, such as perimeter protection systems and some field disturbance sensors, or to other intentional radiators which, in accordance with §15.31(d), must be measured at the installation site. However, the installer shall be responsible for ensuring that the proper antenna is employed so that the limits in this part are not exceeded.

3.9.2 Judgment

Please refer to the Antenna Information detail in Section 1.

4. TEST DATA AND RESULTS

4.1 AC Line Conducted Emissions

| | | | |
|----------------|------------------|--------------|--------------|
| Serial Number: | CR21110014-RF-S1 | Test Date: | 2021-11-15 |
| Test Site: | CE | Test Mode: | Transmitting |
| Tester: | Nick Tang | Test Result: | Pass |

| Environmental Conditions: | | | | | |
|---------------------------|------|------------------------------|----|------------------------|-------|
| Temperature: (°C) | 21.8 | Relative Humidity: (%) | 63 | ATM Pressure: (kPa) | 101.5 |

Test Equipment List and Details:

| Manufacturer | Description | Model | Serial Number | Calibration Date | Calibration Due Date |
|--------------|-------------------|---------|---------------|------------------|----------------------|
| R&S | LISN | ENV216 | 101132 | 2021-04-25 | 2022-04-24 |
| R&S | EMI Test Receiver | ESR3 | 102726 | 2021-07-22 | 2022-07-21 |
| MICRO-COAX | Coaxial Cable | UTIFLEX | C-0200-01 | 2021-08-08 | 2022-08-07 |
| Audix | Test Software | E3 | 190306 (V9) | N/A | N/A |

* Statement of Traceability: China Certification ICT Co., Ltd (Dongguan) attests that all calibrations have been performed, traceable to National Primary Standards and International System of Units (SI).

Line:

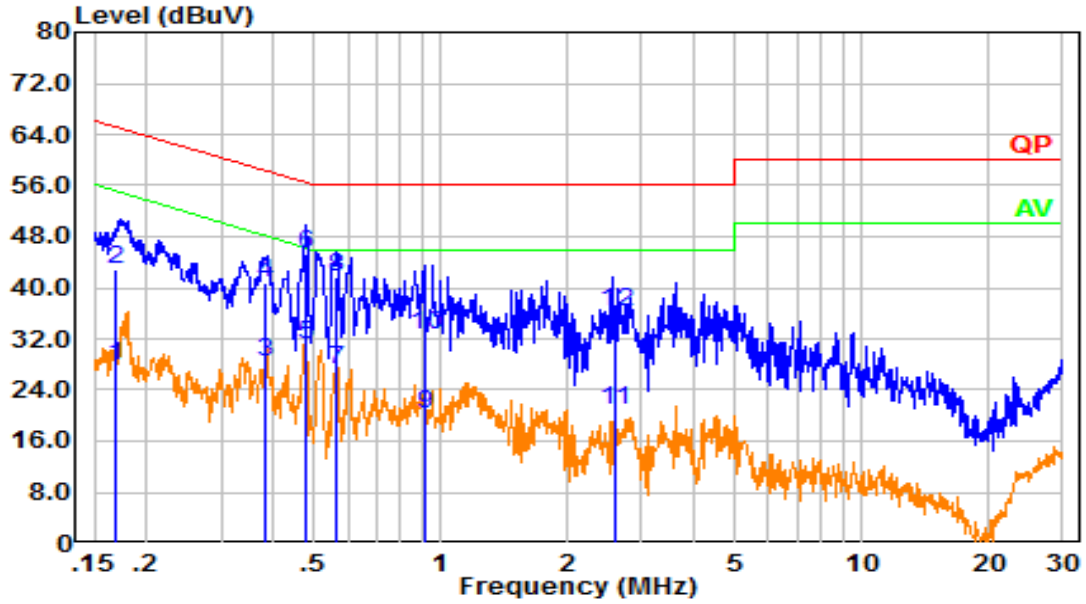

| No. | Frequency (MHz) | Reading (dBμV) | Factor (dB) | Result (dBμV) | Limit (dBμV) | Margin (dB) | Detector |
|-----|-----------------|----------------|-------------|---------------|--------------|-------------|----------|
| 1 | 0.169 | 18.11 | 9.61 | 27.72 | 55.02 | 27.30 | Average |
| 2 | 0.169 | 33.27 | 9.61 | 42.88 | 65.02 | 22.14 | QP |
| 3 | 0.385 | 18.82 | 9.61 | 28.43 | 48.18 | 19.76 | Average |
| 4 | 0.385 | 31.12 | 9.61 | 40.73 | 58.18 | 17.45 | QP |
| 5 | 0.477 | 21.42 | 9.61 | 31.03 | 46.40 | 15.37 | Average |
| 6 | 0.477 | 35.75 | 9.61 | 45.36 | 56.40 | 11.04 | QP |
| 7 | 0.565 | 17.47 | 9.62 | 27.09 | 46.00 | 18.91 | Average |
| 8 | 0.565 | 31.91 | 9.62 | 41.53 | 56.00 | 14.47 | QP |
| 9 | 0.913 | 10.54 | 9.62 | 20.16 | 46.00 | 25.84 | Average |
| 10 | 0.913 | 23.02 | 9.62 | 32.64 | 56.00 | 23.36 | QP |
| 11 | 2.597 | 11.27 | 9.64 | 20.92 | 46.00 | 25.08 | Average |
| 12 | 2.597 | 26.61 | 9.64 | 36.25 | 56.00 | 19.75 | QP |

Neutral:

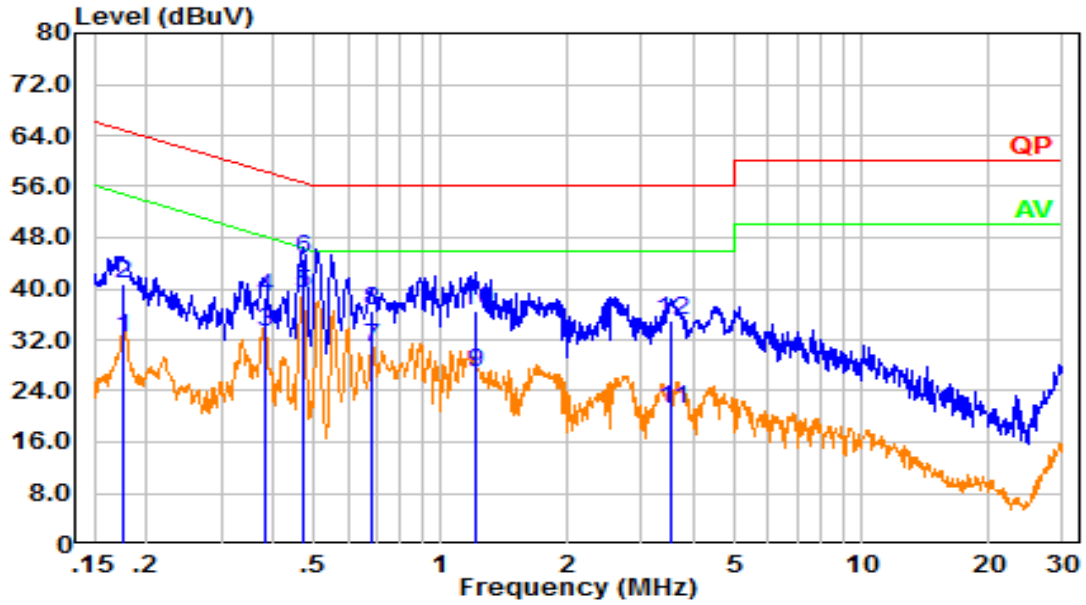

| No. | Frequency (MHz) | Reading (dBμV) | Factor (dB) | Result (dBμV) | Limit (dBμV) | Margin (dB) | Detector |
|-----|-----------------|----------------|-------------|---------------|--------------|-------------|----------|
| 1 | 0.176 | 22.75 | 9.61 | 32.36 | 54.66 | 22.29 | Average |
| 2 | 0.176 | 31.06 | 9.61 | 40.67 | 64.66 | 23.99 | QP |
| 3 | 0.381 | 23.51 | 9.61 | 33.12 | 48.25 | 15.13 | Average |
| 4 | 0.381 | 29.13 | 9.61 | 38.74 | 58.25 | 19.51 | QP |
| 5 | 0.468 | 29.64 | 9.61 | 39.25 | 46.55 | 7.31 | Average |
| 6 | 0.468 | 35.18 | 9.61 | 44.79 | 56.55 | 11.76 | QP |
| 7 | 0.687 | 21.25 | 9.62 | 30.87 | 46.00 | 15.13 | Average |
| 8 | 0.687 | 26.86 | 9.62 | 36.48 | 56.00 | 19.52 | QP |
| 9 | 1.217 | 17.10 | 9.62 | 26.72 | 46.00 | 19.28 | Average |
| 10 | 1.217 | 27.01 | 9.62 | 36.63 | 56.00 | 19.37 | QP |
| 11 | 3.531 | 11.40 | 9.65 | 21.05 | 46.00 | 24.95 | Average |
| 12 | 3.531 | 25.33 | 9.65 | 34.98 | 56.00 | 21.02 | QP |

4.2 Radiation Spurious Emissions

| | | | |
|----------------|-----------------------|--------------|-----------------------|
| Serial Number: | CR21110014-RF-S1 | Test Date: | 2021-11-15~2021-11-16 |
| Test Site: | 966-1/966-2 | Test Mode: | Transmitting |
| Tester: | Great Qiao, Tommy Luo | Test Result: | Pass |

Environmental Conditions:

| | | | | | |
|----------------------|-----------|------------------------------|-------|------------------------|-------------|
| Temperature: (°C) | 21.3~22.3 | Relative Humidity: (%) | 50~56 | ATM Pressure: (kPa) | 101.5~101.6 |
|----------------------|-----------|------------------------------|-------|------------------------|-------------|

Test Equipment List and Details:

| Manufacturer | Description | Model | Serial Number | Calibration Date | Calibration Due Date |
|-----------------|-----------------------|-----------------------|---------------|------------------|----------------------|
| Sunol Sciences | Antenna | JB6 | A082520-5 | 2020-10-19 | 2023-10-18 |
| R&S | EMI Test Receiver | ESR3 | 102724 | 2021-07-22 | 2022-07-21 |
| TIMES MICROWAVE | Coaxial Cable | LMR-600-UltraFlex | C-0470-02 | 2021-07-18 | 2022-07-17 |
| TIMES MICROWAVE | Coaxial Cable | LMR-600-UltraFlex | C-0780-01 | 2021-07-18 | 2022-07-17 |
| Sonoma | Amplifier | 310N | 186165 | 2021-07-18 | 2022-07-17 |
| ETS-Lindgren | Horn Antenna | 3115 | 9912-5985 | 2020-10-13 | 2023-10-12 |
| PASTERNAK | Horn Antenna | PE9852/2F-20 | 112002 | 2021-02-05 | 2024-02-04 |
| R&S | Spectrum Analyzer | FSV40 | 101591 | 2021-07-22 | 2022-07-21 |
| MICRO-COAX | Coaxial Cable | UFA210A-1-1200-70U300 | 217423-008 | 2021-08-08 | 2022-08-07 |
| MICRO-COAX | Coaxial Cable | UFA210A-1-2362-300300 | 235780-001 | 2021-08-08 | 2022-08-07 |
| MICRO-COAX | Coaxial Cable | UFB142A-1-2362-200200 | 235772-001 | 2021-08-08 | 2022-08-07 |
| Mini | Pre-amplifier | ZVA-183-S+ | 5969001149 | 2021-11-10 | 2022-11-09 |
| AH | Preamplifier | PAM-1840VH | 190 | 2020-11-20 | 2021-11-19 |
| Audix | Test Software | E3 | 201021 (V9) | N/A | N/A |
| E-Microwave | Band Rejection Filter | 2400-2483.5MHz | OE01902424 | 2021-08-08 | 2022-08-07 |
| Mini Circuits | High Pass Filter | VHF-6010+ | 31119 | 2021-08-08 | 2022-08-07 |

* Statement of Traceability: China Certification ICT Co., Ltd (Dongguan) attests that all calibrations have been performed, traceable to National Primary Standards and International System of Units (SI).

Test Data:

Please refer to the below table and plots.

Note: The device can be mounted in multiple orientations, test was performed with X, Y, Z Axis, the worst orientation was photographed and it's data was recorded.

1) 30MHz-1GHz(Low channel was the worst)

Horizontal:

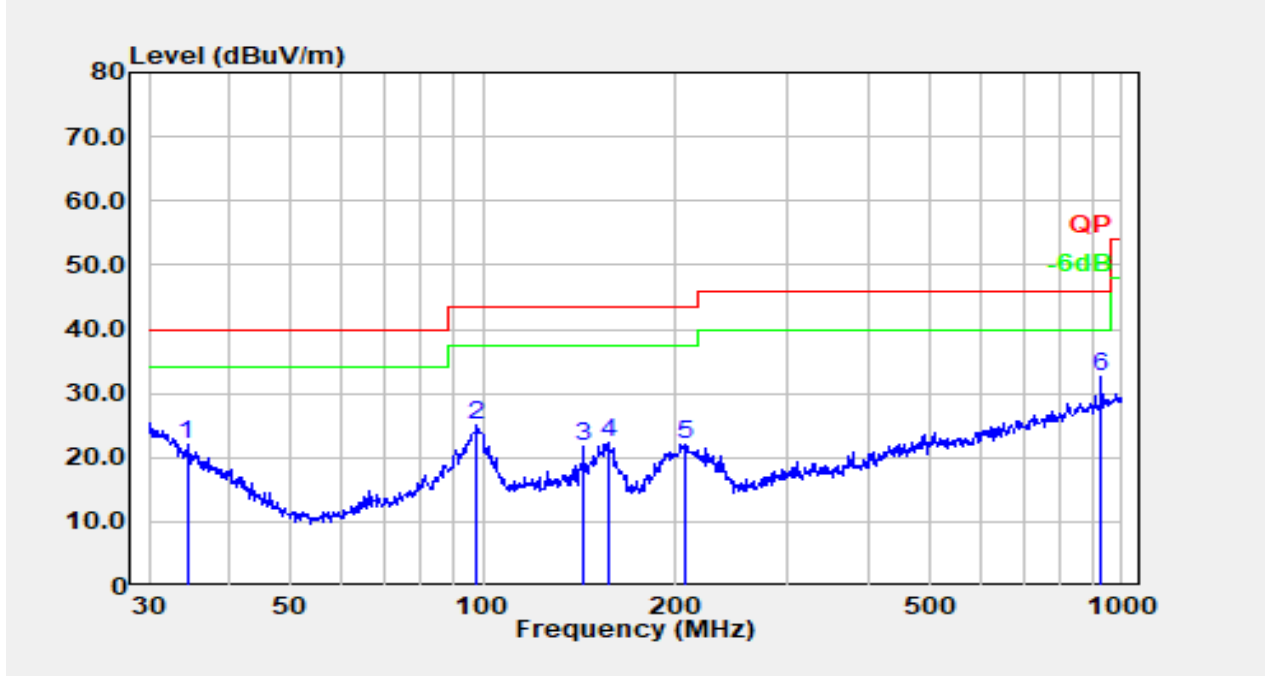

| No. | Frequency (MHz) | Reading (dBμV) | Factor (dB/m) | Result (dBμV/m) | Limit (dBμV/m) | Margin (dB) | Detector |
|-----|-----------------|----------------|---------------|-----------------|----------------|-------------|----------|
| 1 | 34.396 | 29.11 | -7.18 | 21.93 | 40.00 | 18.07 | Peak |
| 2 | 97.798 | 40.08 | -15.11 | 24.97 | 43.50 | 18.53 | Peak |
| 3 | 143.326 | 34.01 | -12.18 | 21.84 | 43.50 | 21.66 | Peak |
| 4 | 157.007 | 34.50 | -12.30 | 22.20 | 43.50 | 21.30 | Peak |
| 5 | 207.850 | 34.65 | -12.57 | 22.09 | 43.50 | 21.41 | Peak |
| 6 | 929.008 | 33.28 | -0.80 | 32.47 | 46.00 | 13.53 | Peak |

Vertical:

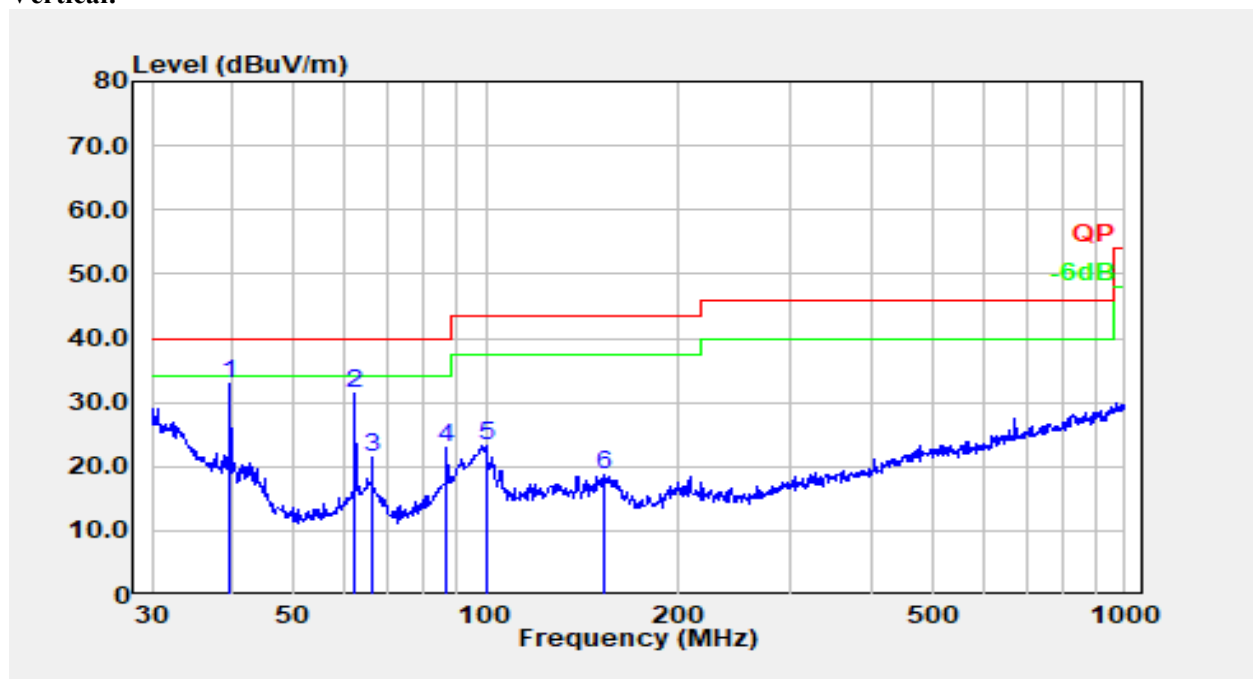

| No. | Frequency (MHz) | Reading (dBμV) | Factor (dB/m) | Result (dBμV/m) | Limit (dBμV/m) | Margin (dB) | Detector |
|-----|-----------------|----------------|---------------|-----------------|----------------|-------------|----------|
| 1 | 39.715 | 44.25 | -11.29 | 32.96 | 40.00 | 7.04 | Peak |
| 2 | 62.431 | 48.68 | -17.43 | 31.25 | 40.00 | 8.75 | Peak |
| 3 | 66.266 | 38.63 | -17.07 | 21.56 | 40.00 | 18.44 | Peak |
| 4 | 86.807 | 40.30 | -17.35 | 22.95 | 40.00 | 17.05 | Peak |
| 5 | 99.878 | 37.87 | -14.62 | 23.26 | 43.50 | 20.24 | Peak |
| 6 | 153.200 | 31.12 | -12.30 | 18.83 | 43.50 | 24.67 | Peak |

2) 1-25GHz:*BDR Mode(GFSK) was the worst:*

| Frequency (MHz) | Receiver | | Polar (H/V) | Factor (dB/m) | Result (dB μ V/m) | Limit (dB μ V/m) | Margin (dB) |
|--------------------------|----------------------|----------|-------------|---------------|-----------------------|----------------------|-------------|
| | Reading (dB μ V) | Detector | | | | | |
| Low Channel: 2402 MHz | | | | | | | |
| 2402.00 | 62.96 | PK | H | 31.51 | 94.47 | N/A | N/A |
| 2402.00 | 52.01 | AV | H | 31.51 | 83.52 | N/A | N/A |
| 2402.00 | 65.28 | PK | V | 31.51 | 96.79 | N/A | N/A |
| 2402.00 | 54.52 | AV | V | 31.51 | 86.03 | N/A | N/A |
| 2390.00 | 26.76 | PK | V | 31.46 | 58.22 | 74.00 | 15.78 |
| 2390.00 | 13.90 | AV | V | 31.46 | 45.36 | 54.00 | 8.64 |
| 4804.00 | 42.98 | PK | V | 10.91 | 53.89 | 74.00 | 20.11 |
| 4804.00 | 29.17 | AV | V | 10.91 | 40.08 | 54.00 | 13.92 |
| 7206.00 | 35.64 | PK | V | 14.22 | 49.86 | 74.00 | 24.14 |
| 7206.00 | 22.96 | AV | V | 14.22 | 37.18 | 54.00 | 16.82 |
| Middle Channel: 2441 MHz | | | | | | | |
| 2441.00 | 61.74 | PK | H | 31.61 | 93.35 | N/A | N/A |
| 2441.00 | 50.78 | AV | H | 31.61 | 82.39 | N/A | N/A |
| 2441.00 | 66.12 | PK | V | 31.61 | 97.73 | N/A | N/A |
| 2441.00 | 54.95 | AV | V | 31.61 | 86.56 | N/A | N/A |
| 4882.00 | 44.48 | PK | V | 11.07 | 55.55 | 74.00 | 18.45 |
| 4882.00 | 31.60 | AV | V | 11.07 | 42.67 | 54.00 | 11.33 |
| 7323.00 | 34.69 | PK | V | 14.80 | 49.49 | 74.00 | 24.51 |
| 7323.00 | 22.42 | AV | V | 14.80 | 37.22 | 54.00 | 16.78 |
| High Channel: 2480 MHz | | | | | | | |
| 2480.00 | 61.25 | PK | H | 31.64 | 92.89 | N/A | N/A |
| 2480.00 | 50.36 | AV | H | 31.64 | 82.00 | N/A | N/A |
| 2480.00 | 65.89 | PK | V | 31.64 | 97.53 | N/A | N/A |
| 2480.00 | 55.30 | AV | V | 31.64 | 86.94 | N/A | N/A |
| 2483.50 | 27.69 | PK | V | 31.64 | 59.33 | 74.00 | 14.67 |
| 2483.50 | 14.28 | AV | V | 31.64 | 45.92 | 54.00 | 8.08 |
| 4960.00 | 44.99 | PK | V | 11.23 | 56.22 | 74.00 | 17.78 |
| 4960.00 | 31.43 | AV | V | 11.23 | 42.66 | 54.00 | 11.34 |
| 7440.00 | 34.09 | PK | V | 15.26 | 49.35 | 74.00 | 24.65 |
| 7440.00 | 21.87 | AV | V | 15.26 | 37.13 | 54.00 | 16.87 |

**Worst Test plots(GFSK Middle channel was the worst)
Horizontal:**

Fundamental
Test with Band
Rejection Filter

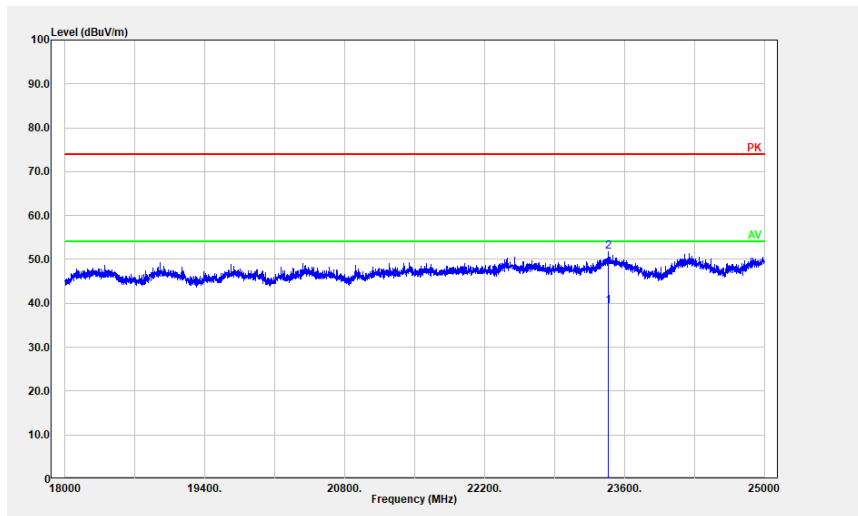
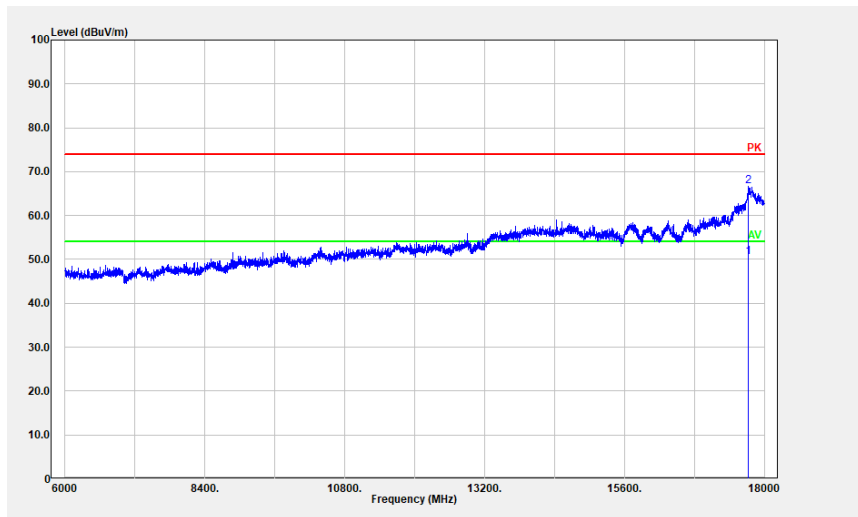
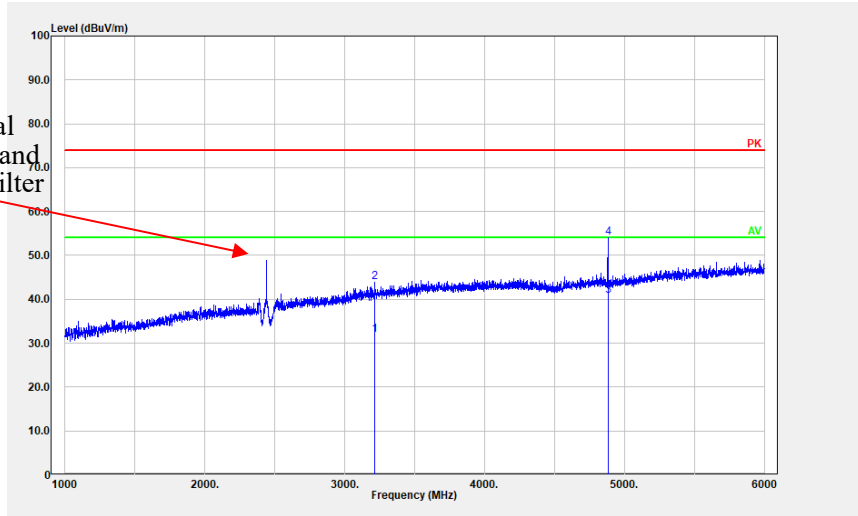

Vertical:

Fundamental
Test with Band
Rejection Filter

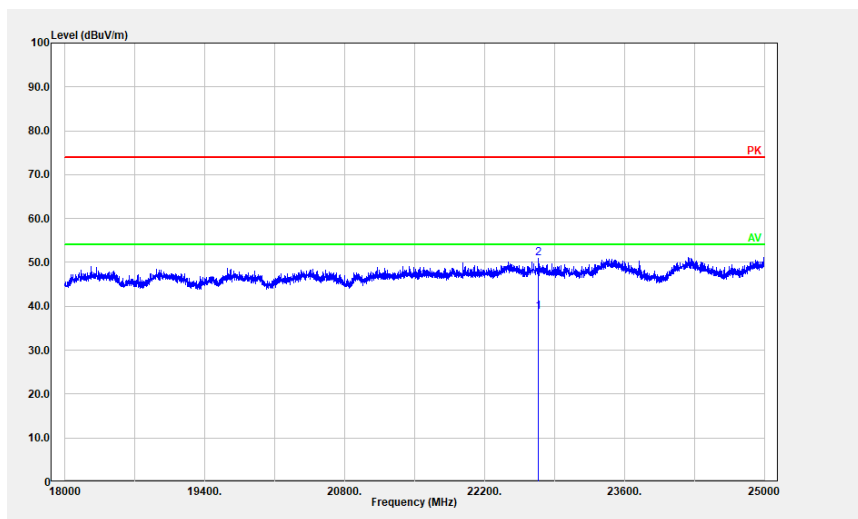
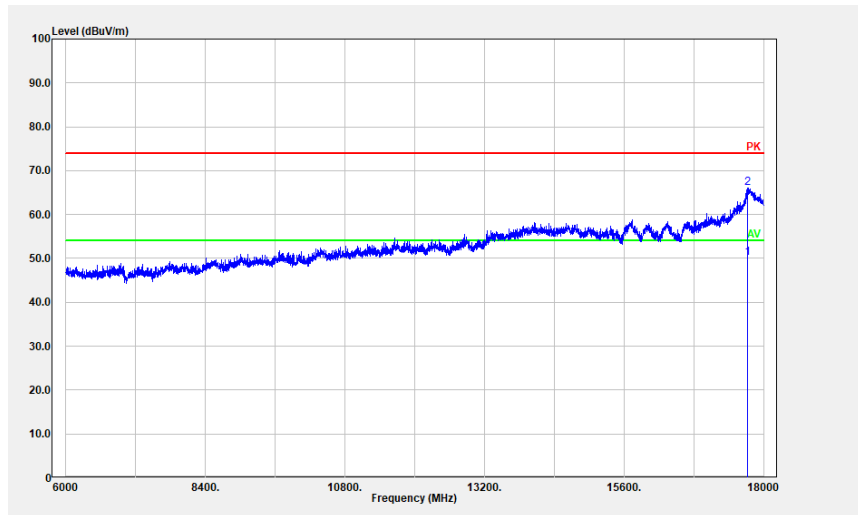
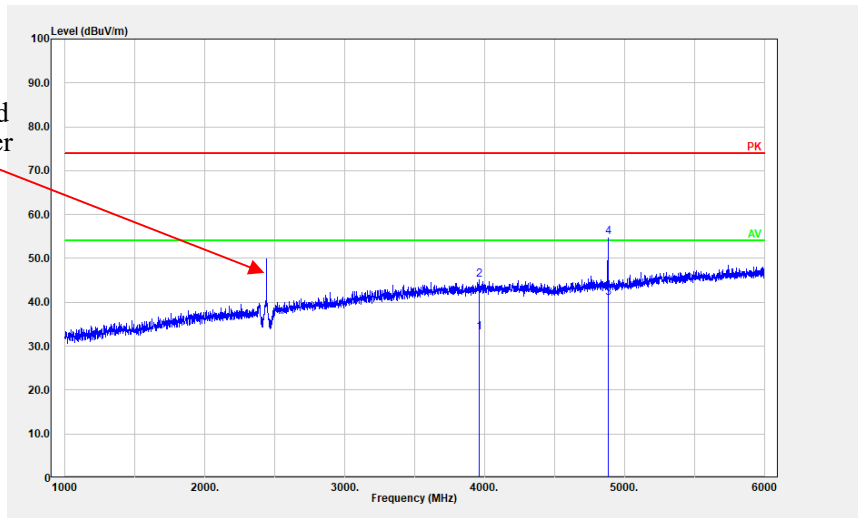

4.3 20 dB Emission Bandwidth:

| | | | |
|----------------|------------------|--------------|--------------|
| Serial Number: | CR21110014-RF-S1 | Test Date: | 2021/11/20 |
| Test Site: | RF | Test Mode: | Transmitting |
| Tester: | Le Qiao | Test Result: | N/A |

Environmental Conditions:

| | | | | | |
|----------------------|------|------------------------------|----|------------------------|-------|
| Temperature: (°C) | 24.3 | Relative Humidity: (%) | 47 | ATM Pressure: (kPa) | 100.7 |
|----------------------|------|------------------------------|----|------------------------|-------|

Test Equipment List and Details:

| Manufacturer | Description | Model | Serial Number | Calibration Date | Calibration Due Date |
|---------------|-------------------|-----------|---------------|------------------|----------------------|
| R&S | Spectrum Analyzer | FSV40 | 101474 | 2021-07-22 | 2022-07-21 |
| zhuoxiang | Coaxial Cable | SMA-178 | 211001 | Each time | N/A |
| Mini-Circuits | DC Block | BLK-18-S+ | 1554403 | Each time | N/A |

* Statement of Traceability: China Certification ICT Co., Ltd (Dongguan) attests that all calibrations have been performed, traceable to National Primary Standards and International System of Units (SI).

Test Data:

| Test Modes | Test Channel | Test Frequency (MHz) | 20 dB Bandwidth (MHz) |
|----------------------------|--------------|----------------------|-----------------------|
| BDR Mode (GFSK) | Lowest | 2402 | 0.872 |
| | Middle | 2441 | 1.000 |
| | Highest | 2480 | 0.952 |
| EDR Mode ($\pi/4$ -DQPSK) | Lowest | 2402 | 1.276 |
| | Middle | 2441 | 1.280 |
| | Highest | 2480 | 1.276 |
| EDR Mode (8DPSK) | Lowest | 2402 | 1.240 |
| | Middle | 2441 | 1.232 |
| | Highest | 2480 | 1.252 |

BDR Mode (GFSK)

| | |
|------------------------|---|
| <p>Lowest Channel</p> | <p>Spectrum</p> <p>Ref Level 20.00 dBm Offset 0.50 dB RBW 30 kHz Att 30 dB SWT 63.1 μs VBW 100 kHz Mode Auto FFT</p> <p>1Pk Max</p> <p>M1[1] -21.46 dBm 2.40155200 GHz -0.07 dB 872.00 kHz</p> <p>D1 -1.520 dBm D2 -21.520 dBm</p> <p>CF 2.402 GHz 501 pts Span 2.0 MHz</p> <p>Date: 20.NOV.2021 13:54:01</p> |
| <p>Middle Channel</p> | <p>Spectrum</p> <p>Ref Level 20.00 dBm Offset 0.50 dB RBW 30 kHz Att 30 dB SWT 63.1 μs VBW 100 kHz Mode Auto FFT</p> <p>1Pk Max</p> <p>M1[1] -19.22 dBm 2.44050000 GHz -0.01 dB 1.00000 MHz</p> <p>D1 0.780 dBm D2 -19.220 dBm</p> <p>CF 2.441 GHz 501 pts Span 2.0 MHz</p> <p>Date: 20.NOV.2021 13:52:30</p> |
| <p>Highest Channel</p> | <p>Spectrum</p> <p>Ref Level 20.00 dBm Offset 0.50 dB RBW 30 kHz Att 30 dB SWT 63.1 μs VBW 100 kHz Mode Auto FFT</p> <p>1Pk Max</p> <p>M1[1] -21.21 dBm 2.47954800 GHz 0.39 dB 952.00 kHz</p> <p>D1 -0.900 dBm D2 -20.900 dBm</p> <p>CF 2.48 GHz 501 pts Span 2.0 MHz</p> <p>Date: 20.NOV.2021 13:55:45</p> |

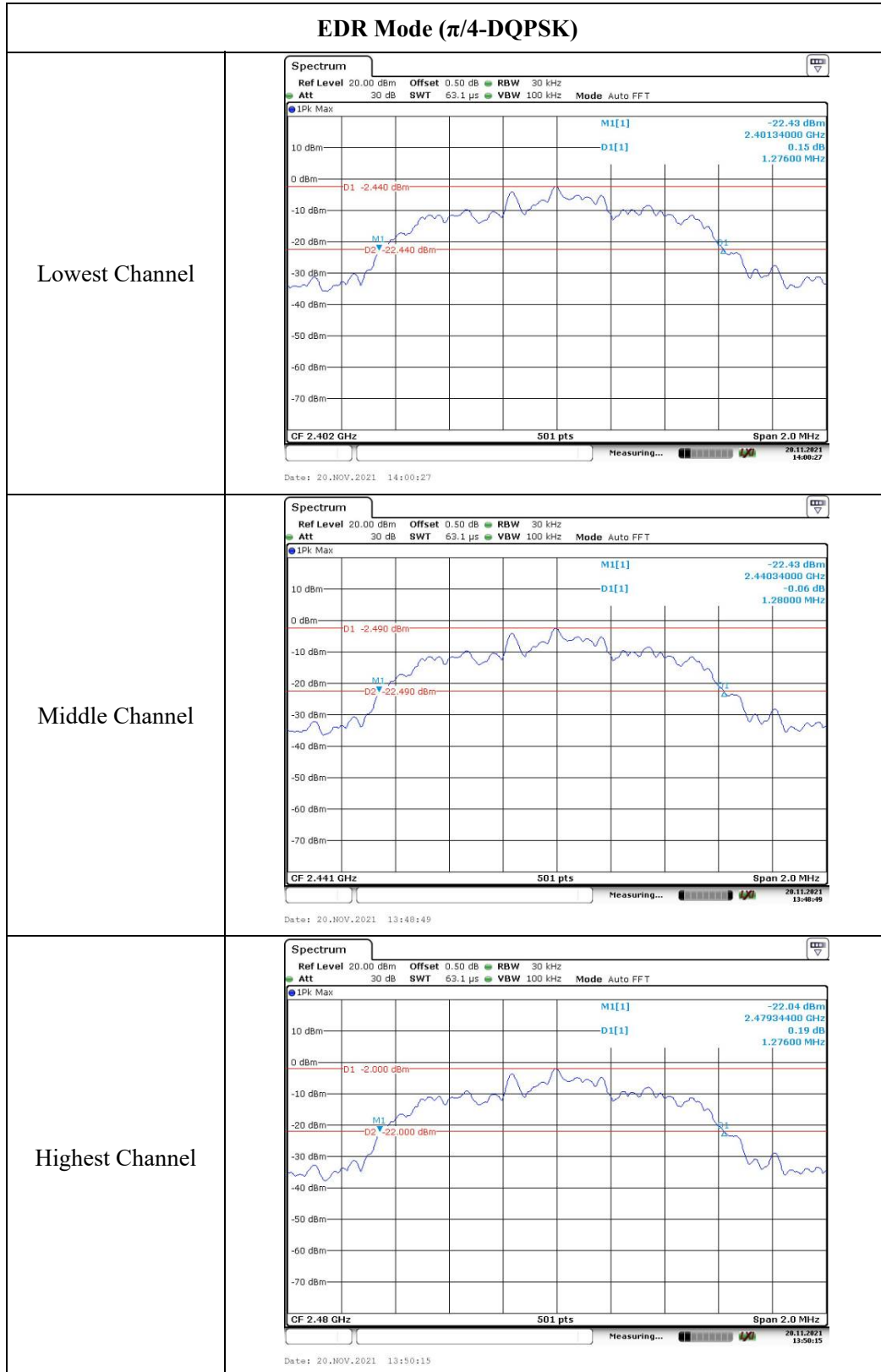

EDR Mode (8DPSK)

| | |
|------------------------|---|
| <p>Lowest Channel</p> | <p>Spectrum Ref Level 20.00 dBm Offset 0.50 dB RBW 30 kHz Att 30 dB SWT 63.1 μs VBW 100 kHz Mode Auto FFT 1Pk Max M1[1] -22.60 dBm 2.40139200 GHz D1[1] -0.08 dB 1.24000 MHz D1 -2.440 dBm D2 -23.440 dBm CF 2.402 GHz 501 pts Span 2.0 MHz Measuring... 20.NOV.2021 14:02:52</p> |
| <p>Middle Channel</p> | <p>Spectrum Ref Level 20.00 dBm Offset 0.50 dB RBW 30 kHz Att 30 dB SWT 63.1 μs VBW 100 kHz Mode Auto FFT 1Pk Max M1[1] -22.02 dBm 2.44040000 GHz D1[1] -0.63 dB 1.23200 MHz D1 -2.370 dBm D2 -22.370 dBm CF 2.441 GHz 501 pts Span 2.0 MHz Measuring... 20.NOV.2021 14:04:44</p> |
| <p>Highest Channel</p> | <p>Spectrum Ref Level 20.00 dBm Offset 0.50 dB RBW 30 kHz Att 30 dB SWT 63.1 μs VBW 100 kHz Mode Auto FFT 1Pk Max M1[1] -21.94 dBm 2.47938000 GHz D1[1] -0.10 dB 1.25200 MHz D1 -1.910 dBm D2 -21.910 dBm CF 2.48 GHz 501 pts Span 2.0 MHz Measuring... 20.NOV.2021 14:06:42</p> |

4.4 Channel Separation:

| | | | |
|----------------|------------------|--------------|--------------|
| Serial Number: | CR21110014-RF-S1 | Test Date: | 2021/11/20 |
| Test Site: | RF | Test Mode: | Transmitting |
| Tester: | Le Qiao | Test Result: | Pass |

Environmental Conditions:

| | | | | | |
|----------------------|------|------------------------------|----|------------------------|-------|
| Temperature: (°C) | 24.3 | Relative Humidity: (%) | 47 | ATM Pressure: (kPa) | 100.7 |
|----------------------|------|------------------------------|----|------------------------|-------|

Test Equipment List and Details:

| Manufacturer | Description | Model | Serial Number | Calibration Date | Calibration Due Date |
|---------------|-------------------|-----------|---------------|------------------|----------------------|
| R&S | Spectrum Analyzer | FSV40 | 101474 | 2021/7/22 | 2022/7/21 |
| zhuoxiang | Coaxial Cable | SMA-178 | 211001 | Each time | N/A |
| Mini-Circuits | DC Block | BLK-18-S+ | 1554403 | Each time | N/A |

* Statement of Traceability: China Certification ICT Co., Ltd (Dongguan) attests that all calibrations have been performed, traceable to National Primary Standards and International System of Units (SI).

Test Data:

| Test Modes | Test Frequency (MHz) | Channel Separation (MHz) | Limits (MHz) |
|----------------------------|----------------------|--------------------------|--------------|
| BDR Mode (GFSK) | 2402 | 1.000 | 0.581 |
| | 2441 | 1.000 | 0.667 |
| | 2480 | 1.000 | 0.635 |
| EDR Mode ($\pi/4$ -DQPSK) | 2402 | 0.994 | 0.851 |
| | 2441 | 1.000 | 0.853 |
| | 2480 | 1.000 | 0.851 |
| EDR Mode (8DPSK) | 2402 | 1.000 | 0.827 |
| | 2441 | 1.006 | 0.821 |
| | 2480 | 1.000 | 0.835 |

BDR Mode (GFSK)

| | |
|------------------------|---|
| <p>Lowest Channel</p> | <p>Spectrum</p> <p>Ref Level 20.00 dBm Offset 0.50 dB RBW 30 kHz Att 30 dB SWT 63.3 μs VBW 100 kHz Mode Auto FFT</p> <p>1Pk Max</p> <p>M1[1] 1.16 dBm D1[1] 2.40189530 GHz 0.00 dB 1.00000 MHz</p> <p>CF 2.4025 GHz 501 pts Span 3.0 MHz</p> <p>Date: 20.NOV.2021 13:55:12</p> |
| <p>Middle Channel</p> | <p>Spectrum</p> <p>Ref Level 20.00 dBm Offset 0.50 dB RBW 30 kHz Att 30 dB SWT 63.3 μs VBW 100 kHz Mode Auto FFT</p> <p>1Pk Max</p> <p>M1[1] 0.65 dBm D1[1] 2.44083530 GHz 0.19 dB 1.00000 MHz</p> <p>CF 2.4415 GHz 501 pts Span 3.0 MHz</p> <p>Date: 20.NOV.2021 13:53:16</p> |
| <p>Highest Channel</p> | <p>Spectrum</p> <p>Ref Level 20.00 dBm Offset 0.50 dB RBW 30 kHz Att 30 dB SWT 63.3 μs VBW 100 kHz Mode Auto FFT</p> <p>1Pk Max</p> <p>M1[1] -1.05 dBm D1[1] 2.47883530 GHz 1.71 dB 1.00000 MHz</p> <p>CF 2.4795 GHz 501 pts Span 3.0 MHz</p> <p>Date: 20.NOV.2021 13:57:28</p> |

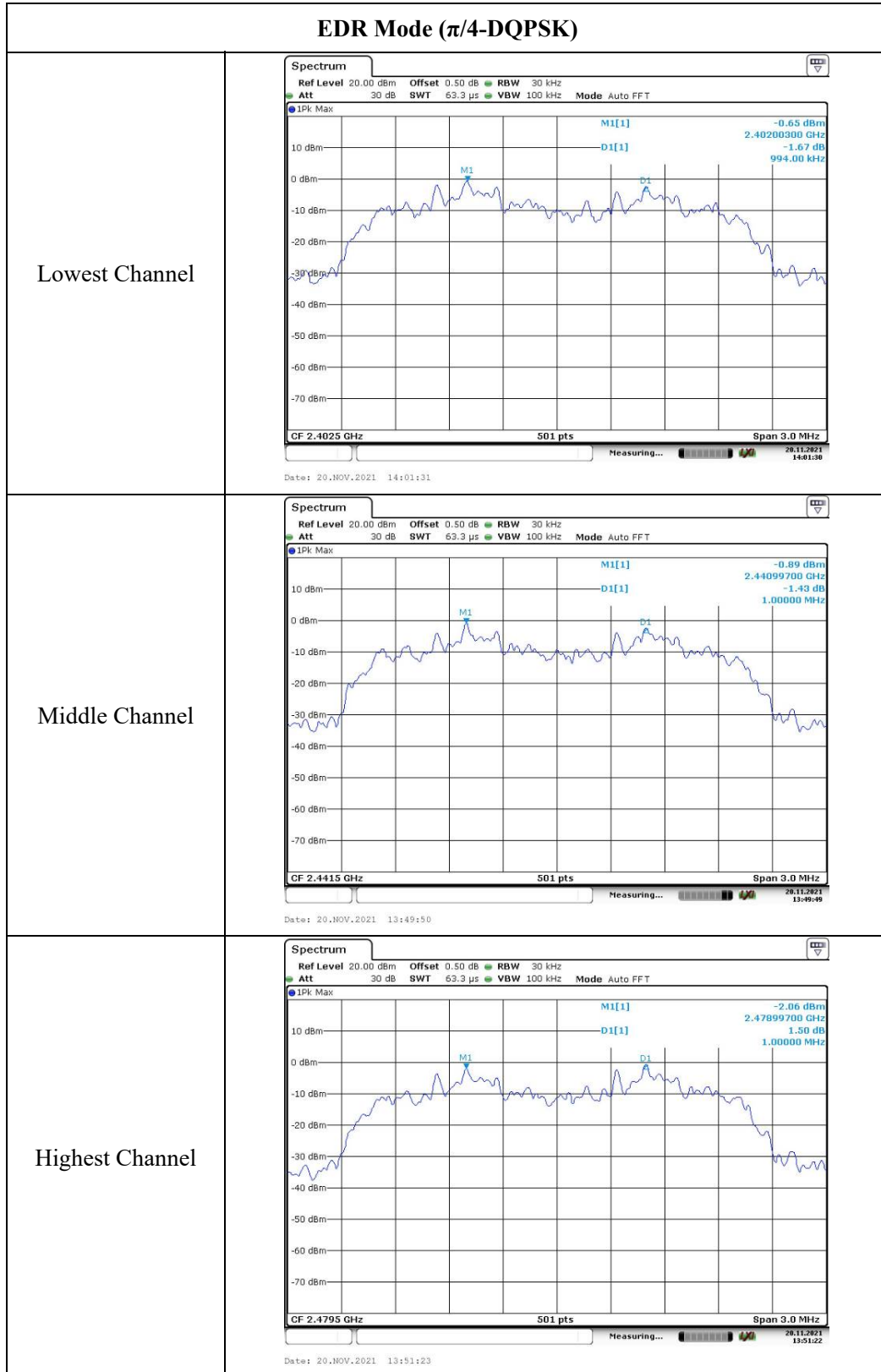

EDR Mode (8DPSK)

| | |
|------------------------|---|
| <p>Lowest Channel</p> | <p>Spectrum Ref Level 20.00 dBm Offset 0.50 dB RBW 30 kHz Att 30 dB SWT 63.3 μs VBW 100 kHz Mode Auto FFT 1Pk Max M1[1] -0.12 dBm D1[1] -2.25 dB 2.40199700 GHz 1.00000 MHz CF 2.4025 GHz 501 pts Span 3.0 MHz Measuring... 20.11.2021 14:04:26</p> |
| <p>Middle Channel</p> | <p>Spectrum Ref Level 20.00 dBm Offset 0.50 dB RBW 30 kHz Att 30 dB SWT 63.3 μs VBW 100 kHz Mode Auto FFT 1Pk Max M1[1] -0.87 dBm D1[1] -1.50 dB 2.44099100 GHz 1.00600 MHz CF 2.4415 GHz 501 pts Span 3.0 MHz Measuring... 20.11.2021 14:06:24</p> |
| <p>Highest Channel</p> | <p>Spectrum Ref Level 20.00 dBm Offset 0.50 dB RBW 30 kHz Att 30 dB SWT 63.3 μs VBW 100 kHz Mode Auto FFT 1Pk Max M1[1] -1.99 dBm D1[1] 0.25 dB 2.47899700 GHz 1.00000 MHz CF 2.4795 GHz 501 pts Span 3.0 MHz Measuring... 20.11.2021 14:08:57</p> |

4.5 Number Of Hopping Frequency:

| | | | |
|----------------|------------------|--------------|--------------|
| Serial Number: | CR21110014-RF-S1 | Test Date: | 2021/11/20 |
| Test Site: | RF | Test Mode: | Transmitting |
| Tester: | Le Qiao | Test Result: | Pass |

Environmental Conditions:

| | | | | | |
|----------------------|------|------------------------------|----|------------------------|-------|
| Temperature: (°C) | 24.3 | Relative Humidity: (%) | 47 | ATM Pressure: (kPa) | 100.7 |
|----------------------|------|------------------------------|----|------------------------|-------|

Test Equipment List and Details:

| Manufacturer | Description | Model | Serial Number | Calibration Date | Calibration Due Date |
|---------------|-------------------|-----------|---------------|------------------|----------------------|
| R&S | Spectrum Analyzer | FSV40 | 101474 | 2021/7/22 | 2022/7/21 |
| zhuoxiang | Coaxial Cable | SMA-178 | 211001 | Each time | N/A |
| Mini-Circuits | DC Block | BLK-18-S+ | 1554403 | Each time | N/A |

* Statement of Traceability: China Certification ICT Co., Ltd (Dongguan) attests that all calibrations have been performed, traceable to National Primary Standards and International System of Units (SI).

Test Data:

| Test Modes | Frequency Range (MHz) | Number of Hopping Channel | Limits |
|----------------|-----------------------|---------------------------|--------|
| GFSK | 2400-2483.5 | 79 | ≥15 |
| $\pi/4$ -DQPSK | 2400-2483.5 | 79 | ≥15 |
| 8DPSK | 2400-2483.5 | 79 | ≥15 |

| | |
|---|---|
| <p>BDR Mode (GFSK)</p> | <p>Spectrum Ref Level 20.00 dBm Offset 0.50 dB RBW 100 kHz Att 30 dB SWT 1 ms VBW 300 kHz Mode Sweep IPk Max 10 dBm 0 dBm -10 dBm -20 dBm -30 dBm -40 dBm -50 dBm -60 dBm -70 dBm Start 2.4 GHz 501 pts Stop 2.4835 GHz Measuring... 20.11.2021 14:56:01 Date: 20.NOV.2021 14:56:02</p> |
| <p>EDR Mode ($\pi/4$-DQPSK)</p> | <p>Spectrum Ref Level 20.00 dBm Offset 0.50 dB RBW 100 kHz Att 30 dB SWT 1 ms VBW 300 kHz Mode Sweep IPk Max 10 dBm 0 dBm -10 dBm -20 dBm -30 dBm -40 dBm -50 dBm -60 dBm -70 dBm Start 2.4 GHz 501 pts Stop 2.4835 GHz Measuring... 20.11.2021 14:57:28 Date: 20.NOV.2021 14:57:29</p> |
| <p>EDR Mode (8DPSK)</p> | <p>Spectrum Ref Level 20.00 dBm Offset 0.50 dB RBW 100 kHz Att 30 dB SWT 1 ms VBW 300 kHz Mode Sweep IPk Max 10 dBm 0 dBm -10 dBm -20 dBm -30 dBm -40 dBm -50 dBm -60 dBm -70 dBm Start 2.4 GHz 501 pts Stop 2.4835 GHz Measuring... 20.11.2021 14:59:55 Date: 20.NOV.2021 14:59:56</p> |

4.6 Time Of Occupancy(Dwell Time):

| | | | |
|----------------|------------------|--------------|--------------|
| Serial Number: | CR21110014-RF-S1 | Test Date: | 2021/11/20 |
| Test Site: | RF | Test Mode: | Transmitting |
| Tester: | Le Qiao | Test Result: | Pass |

Environmental Conditions:

| | | | | | |
|----------------------|------|------------------------------|----|------------------------|-------|
| Temperature: (°C) | 24.3 | Relative Humidity: (%) | 47 | ATM Pressure: (kPa) | 100.7 |
|----------------------|------|------------------------------|----|------------------------|-------|

Test Equipment List and Details:

| Manufacturer | Description | Model | Serial Number | Calibration Date | Calibration Due Date |
|---------------|-------------------|-----------|---------------|------------------|----------------------|
| R&S | Spectrum Analyzer | FSV40 | 101474 | 2021/7/22 | 2022/7/21 |
| zhuoxiang | Coaxial Cable | SMA-178 | 211001 | Each time | N/A |
| Mini-Circuits | DC Block | BLK-18-S+ | 1554403 | Each time | N/A |

* Statement of Traceability: China Certification ICT Co., Ltd (Dongguan) attests that all calibrations have been performed, traceable to National Primary Standards and International System of Units (SI).

Test Data:

| Test Modes | Packet Type | Test Frequency (MHz) | Pulse width (ms) | Result (s) | Limit (s) |
|----------------------------|-------------|----------------------|------------------|------------|-----------|
| BDR Mode (GFSK) | DH1 | 2441 | 0.450 | 0.144 | 0.400 |
| | DH3 | 2441 | 1.718 | 0.275 | 0.400 |
| | DH5 | 2441 | 2.983 | 0.318 | 0.400 |
| EDR Mode ($\pi/4$ -DQPSK) | 2DH1 | 2441 | 0.444 | 0.142 | 0.400 |
| | 2DH3 | 2441 | 1.718 | 0.275 | 0.400 |
| | 2DH5 | 2441 | 2.974 | 0.317 | 0.400 |
| EDR Mode (8DPSK) | 3DH1 | 2441 | 0.446 | 0.143 | 0.400 |
| | 3DH3 | 2441 | 1.706 | 0.273 | 0.400 |
| | 3DH5 | 2441 | 2.992 | 0.319 | 0.400 |

Note:

DH1:Dwell time=Pulse time (ms) \times (1600/2/79) \times 31.6 s

DH3:Dwell time=Pulse time (ms) \times (1600/4/79) \times 31.6 s

DH5:Dwell time=Pulse time (ms) \times (1600/6/79) \times 31.6 s

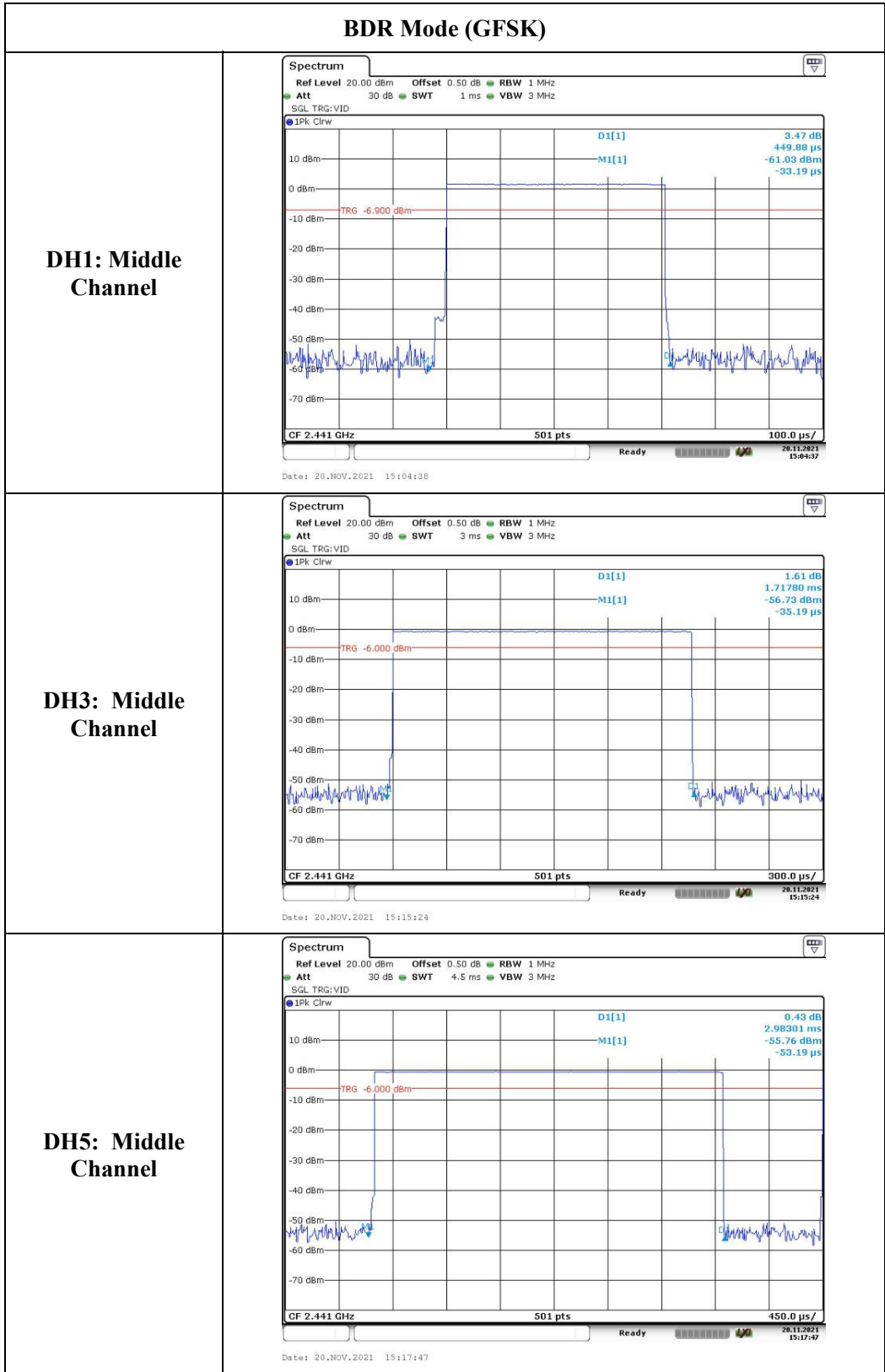

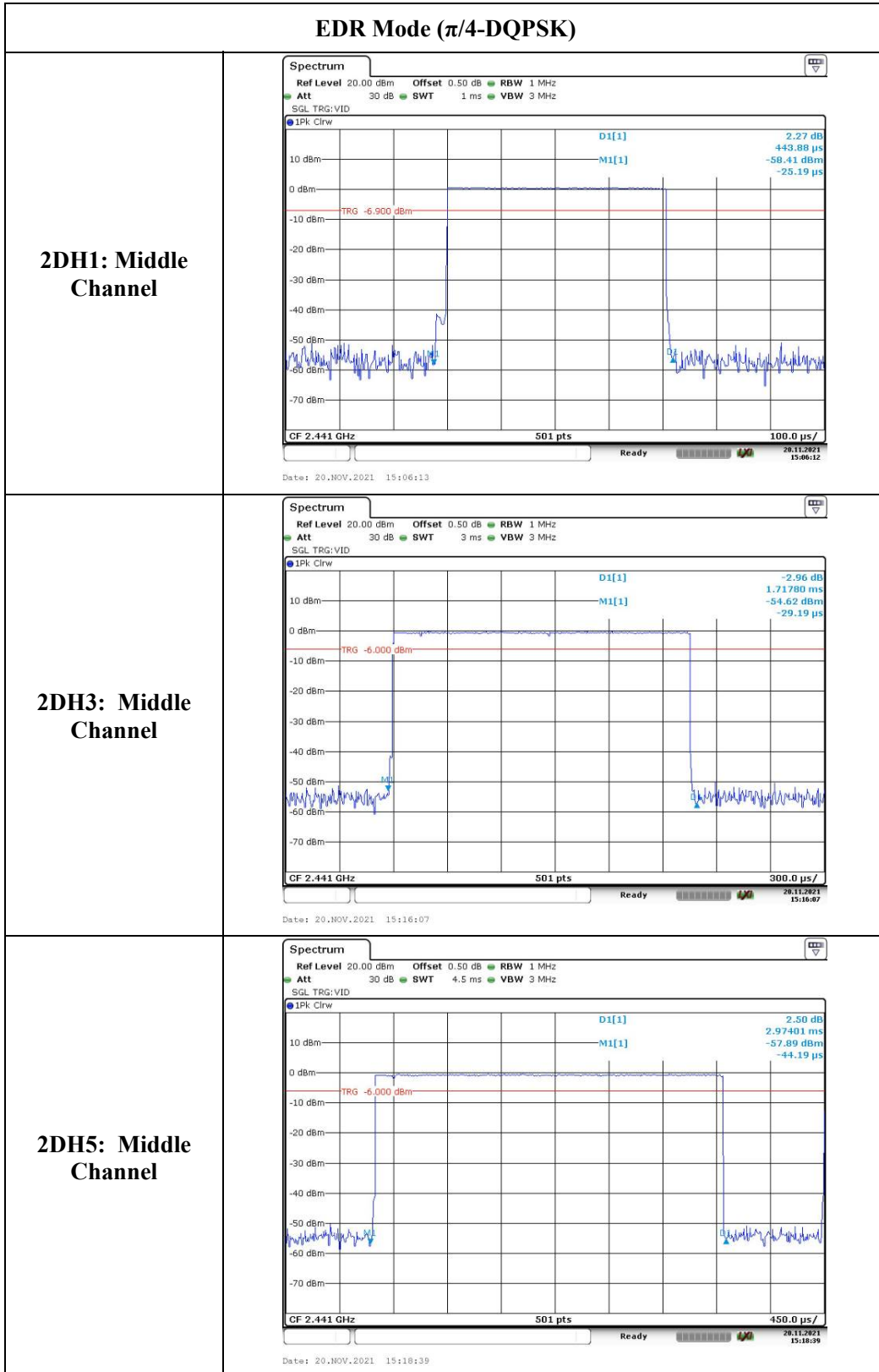

EDR Mode (8DPSK)

3DH1: Middle Channel

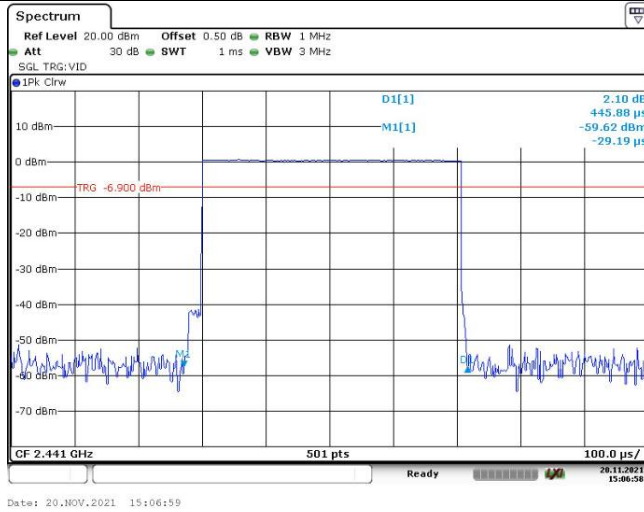

3DH3: Middle Channel



3DH5: Middle Channel

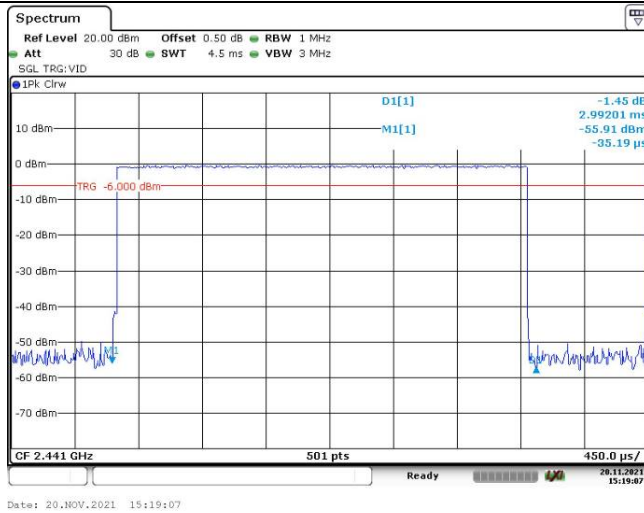

4.7 Peak Conducted Output Power:

| | | | |
|----------------|------------------|--------------|--------------|
| Serial Number: | CR21110014-RF-S1 | Test Date: | 2021/11/20 |
| Test Site: | RF | Test Mode: | Transmitting |
| Tester: | Le Qiao | Test Result: | Pass |

Environmental Conditions:

| | | | | | |
|----------------------|------|------------------------------|----|------------------------|-------|
| Temperature: (°C) | 24.3 | Relative Humidity: (%) | 47 | ATM Pressure: (kPa) | 100.7 |
|----------------------|------|------------------------------|----|------------------------|-------|

Test Equipment List and Details:

| Manufacturer | Description | Model | Serial Number | Calibration Date | Calibration Due Date |
|--------------|---------------------------|---------------|---------------|------------------|----------------------|
| eastsheep | Coaxial Attenuator | 2W-SMA-JK-18G | 21060301 | Each time | N/A |
| zhuoxiang | Coaxial Cable | SMA-178 | 211001 | Each time | N/A |
| Agilent | USB Wideband Power Sensor | U2021XA | MY54080015 | 2021-07-22 | 2022-07-21 |

* Statement of Traceability: China Certification ICT Co., Ltd (Dongguan) attests that all calibrations have been performed, traceable to National Primary Standards and International System of Units (SI).

Test Data:

| Test Modes | Test Frequency (MHz) | Peak Conducted Output Power (dBm) | Limits (dBm) |
|----------------------------|----------------------|-----------------------------------|--------------|
| BDR Mode (GFSK) | 2402 | 2.10 | 21 |
| | 2441 | 1.94 | 21 |
| | 2480 | 0.29 | 21 |
| EDR Mode ($\pi/4$ -DQPSK) | 2402 | -0.20 | 21 |
| | 2441 | -0.01 | 21 |
| | 2480 | 0.60 | 21 |
| EDR Mode (8DPSK) | 2402 | -0.21 | 21 |
| | 2441 | -0.03 | 21 |
| | 2480 | 0.74 | 21 |

4.8 100 kHz Bandwidth of Frequency Band Edge:

| | | | |
|----------------|------------------|--------------|--------------|
| Serial Number: | CR21110014-RF-S1 | Test Date: | 2021/11/20 |
| Test Site: | RF | Test Mode: | Transmitting |
| Tester: | Le Qiao | Test Result: | Pass |

Environmental Conditions:

| | | | | | |
|----------------------|------|------------------------------|----|------------------------|-------|
| Temperature: (°C) | 24.3 | Relative Humidity: (%) | 47 | ATM Pressure: (kPa) | 100.7 |
|----------------------|------|------------------------------|----|------------------------|-------|

Test Equipment List and Details:

| Manufacturer | Description | Model | Serial Number | Calibration Date | Calibration Due Date |
|---------------|-------------------|-----------|---------------|------------------|----------------------|
| R&S | Spectrum Analyzer | FSV40 | 101474 | 2021/7/22 | 2022/7/21 |
| zhuoxiang | Coaxial Cable | SMA-178 | 211001 | Each time | N/A |
| Mini-Circuits | DC Block | BLK-18-S+ | 1554403 | 2021/8/8 | 2022/8/7 |

** Statement of Traceability: China Certification ICT Co., Ltd (Dongguan) attests that all calibrations have been performed, traceable to National Primary Standards and International System of Units (SI).*

BDR Mode (GFSK)

**Band Edge,
Left Side**



**Band Edge,
Right Side**

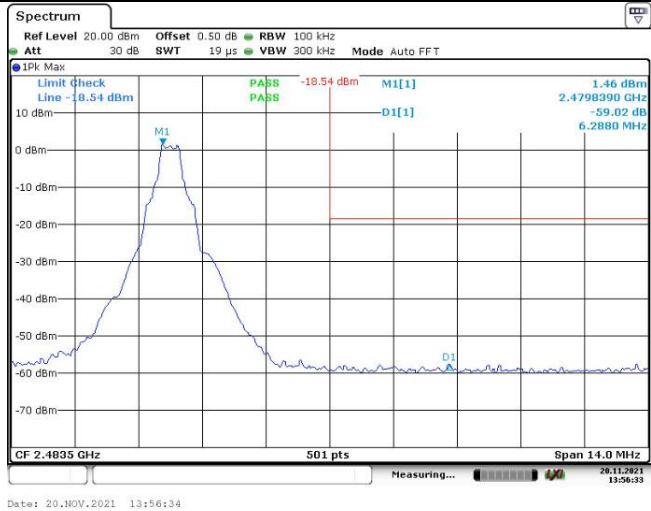

EDR Mode ($\pi/4$ -DQPSK)

**Band Edge,
Left Side**

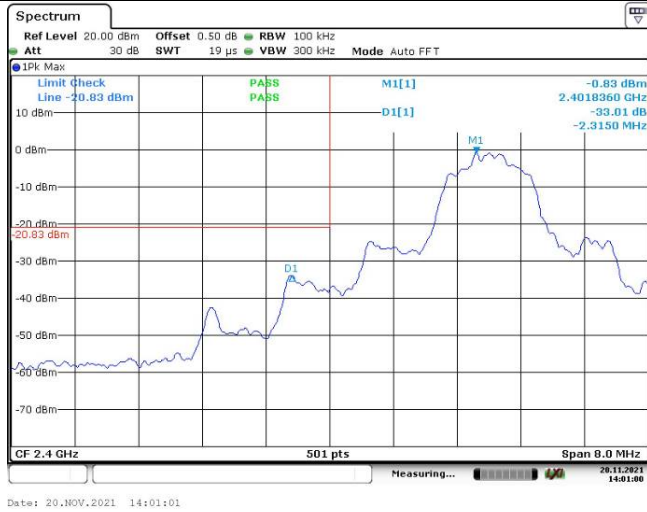

**Band Edge,
Right Side**



EDR Mode (8DPSK)

**Band Edge,
Left Side**



**Band Edge,
Right Side**



Hopping Mode, BDR Mode (GFSK)

**Band Edge,
Left Side**

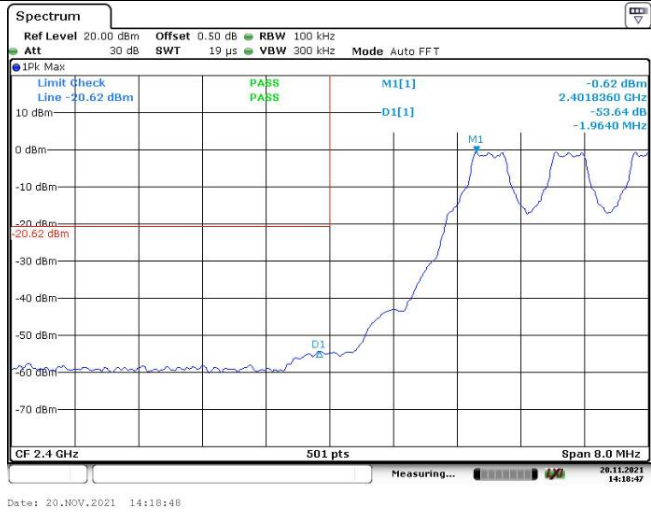

**Band Edge,
Right Side**

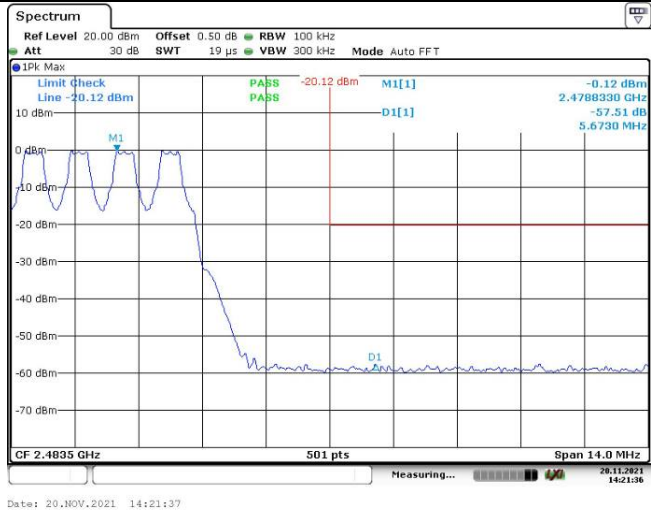

Hopping Mode, EDR Mode ($\pi/4$ -DQPSK)

**Band Edge,
Left Side**



**Band Edge,
Right Side**



Hopping Mode, EDR Mode (8DPSK)

**Band Edge,
Left Side**



**Band Edge,
Right Side**



5. RF EXPOSURE EVALUATION

5.1 Applicable Standard

FCC §15.247 (i)

Systems operating under the provisions of this section shall be operated in a manner that ensures that the public is not exposed to radio frequency energy levels in excess of the Commission's guidelines. See §1.1307(b)(1) of this chapter.

5.2 Procedure

According to KDB447498 D01 General RF Exposure Guidance v06:

The 1-g and 10-g SAR test exclusion thresholds for 100 MHz to 6 GHz at test separation distances ≤ 50 mm are determined by:

$[(\text{max. power of channel, including tune-up tolerance, mW})/(\text{min. test separation distance, mm})] \cdot [\sqrt{f(\text{GHz})}] \leq 3.0$ for 1-g SAR and ≤ 7.5 for 10-g extremity SAR, where

- $f(\text{GHz})$ is the RF channel transmit frequency in GHz
- Power and distance are rounded to the nearest mW and mm before calculation
- The result is rounded to one decimal place for comparison
- 3.0 and 7.5 are referred to as the numeric thresholds in the step 2 below

The test exclusions are applicable only when the minimum test separation distance is ≤ 50 mm and for transmission frequencies between 100 MHz and 6 GHz. When the minimum test separation distance is < 5 mm, a distance of 5 mm according to 5) in section 4.1 is applied to determine SAR test exclusion.

5.3 Measurement Result

The max conducted power including tune-up tolerance is 2.5 dBm (1.78 mW).

$[(\text{max. power of channel, mW})/(\text{min. test separation distance, mm})][\sqrt{f(\text{GHz})}]$
 $= 1.78/5 \cdot (\sqrt{2.480}) = 0.6 < 3.0$

Result: Compliance. The stand-alone SAR evaluation is not necessary.

***** END OF REPORT *****