



TEST REPORT

FCC PART 15.236

Report Reference No.: CTL18091920711-WF

Compiled by: (position+printed name+signature)	Allen Wang (File administrators)	<u>Allen Wang</u>
Tested by: (position+printed name+signature)	Nice Nong (Test Engineer)	<u>Nice Nong</u>
Approved by: (position+printed name+signature)	Ivan Xie (Manager)	<u>Ivan Xie</u>

Product Name.....: Audio transceiver

Model/Type reference: K380C

Listed Models.....: See next page

Trade Mark.....: N/A

FCC ID.....: **2AG40-K380C**

Applicant's name: **Shenzhen Skylark Audio Industry Co., Ltd.**

Address of applicant: 3rd Floor, Liyuan Building, No.177 Longcheng Avenue, Longgang District, Shenzhen, Guangdong, China

Test Firm.....: **Shenzhen CTL Testing Technology Co., Ltd.**

Address of Test Firm.....: Floor 1-A, Baisha Technology Park, No.3011, Shahexi Road, Nanshan District, Shenzhen, China 518055

Test specification.....:

Standard.....: **FCC Part 15.236:** Operation of wireless microphones in the bands 54-72 MHz, 76-88 MHz, 174-216 MHz, 470-608 MHz and 614-698 MHz

TRF Originator.....: Shenzhen CTL Testing Technology Co., Ltd.

Master TRF.....: Dated 2011-01

Date of Receipt.....: Oct. 08, 2018

Date of Test Date.....: Oct. 08, 2018–Nov. 08, 2018

Data of Issue.....: Nov. 08, 2018

Result.....: **Pass**

Shenzhen CTL Testing Technology Co., Ltd. All rights reserved.

This publication may be reproduced in whole or in part for non-commercial purposes as long as the Shenzhen CTL Testing Technology Co., Ltd. is acknowledged as copyright owner and source of the material. Shenzhen CTL Testing Technology Co., Ltd. takes no responsibility for and will not assume liability for damages resulting from the reader's interpretation of the reproduced material due to its placement and context.

TEST REPORT

Test Report No. :	CTL18091920711-WF	Nov. 08, 2018 Date of issue
--------------------------	--------------------------	--------------------------------

Equipment under Test : Audio transceiver

Model /Type : K380C

Listed Models : K380A, K380D, K380Q, B1, B2, B3, B6, B7, B9, K380G, K380J, K380K, K380L, K380M, K380N, K380P, K380R, K380S, K380X, K380F, K380T, K380H, K18U, K18V, K38C, K38, K28, K18, K380 K380E

Applicant : **Shenzhen Skylark Audio Industry Co., Ltd.**

Address : 3rd Floor, Liyuan Building, No.177 Longcheng Avenue, Longgang District, Shenzhen, Guangdong, China

Manufacturer : **Shenzhen Skylark Audio Industry Co., Ltd.**

Address : 3rd Floor, Liyuan Building, No.177 Longcheng Avenue, Longgang District, Shenzhen, Guangdong, China

Test result	Pass *
--------------------	---------------

*In the configuration tested, the EUT complied with the standards specified page 5.

The test report merely corresponds to the test sample.

It is not permitted to copy extracts of these test result without the written permission of the test laboratory.

**** Modified History ****

Revisions	Description	Issued Data	Report No.	Remark
Version 1.0	Initial Test Report Release	2018-11-08	CTL18091920711-WF	Tracy Qi



Table of Contents

Page

1. SUMMARY.....	5
1.1. TEST STANDARDS.....	5
1.2. TEST DESCRIPTION.....	5
1.3. TEST FACILITY.....	6
1.4. STATEMENT OF THE MEASUREMENT UNCERTAINTY.....	6
2. GENERAL INFORMATION.....	7
2.1. ENVIRONMENTAL CONDITIONS.....	7
2.2. GENERAL DESCRIPTION OF EUT.....	7
2.3. DESCRIPTION OF TEST MODES AND TEST FREQUENCY.....	7
2.4. EQUIPMENTS USED DURING THE TEST.....	8
2.5. RELATED SUBMITTAL(S) / GRANT (S).....	8
2.6. MODIFICATIONS.....	8
3. TEST CONDITIONS AND RESULTS.....	9
3.1. CONDUCTED EMISSIONS TEST.....	9
3.2. RADIATED EMISSIONS AND BAND EDGE.....	12
3.3. MAXIMUM OUTPUT POWER.....	15
3.4. OCCUPIED BANDWIDTH.....	16
3.5. NECESSARY BANDWIDTH.....	18
3.6. TRANSMITTER SPURIOUS EMISSIONS.....	21
3.7. FREQUENCY STABILITY.....	26
3.8. ANTENNA REQUIREMENT.....	28
4. TEST SETUP PHOTOS OF THE EUT.....	29
5. PHOTOS OF THE EUT.....	30

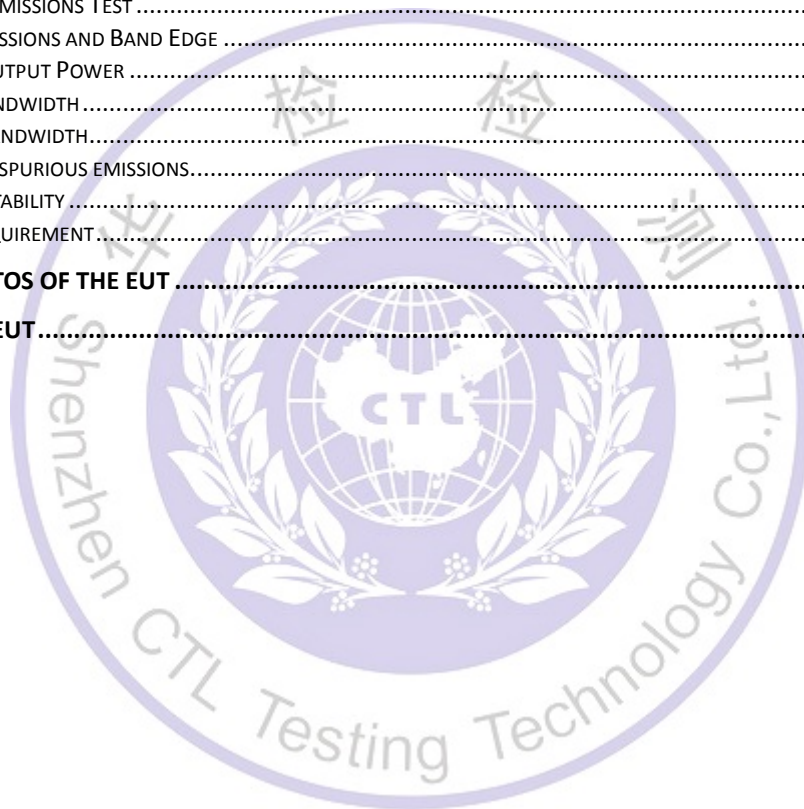

1. SUMMARY

1.1. TEST STANDARDS

The tests were performed according to following standards:

[FCC Rules Part 15.236](#): Operation of wireless microphones in the bands 54-72 MHz, 76-88 MHz, 174-216 MHz, 470-608 MHz and 614-698 MHz

[ANSI C63.10: 2013](#): American National Standard for Testing Unlicensed Wireless Devices

1.2. Test Description

FCC PART 15.247		
FCC Part 15.207	AC Power Conducted Emission	PASS
FCC Part 15.236(d)	RF Power Output	PASS
FCC Part 15.236(f)	Occupied Bandwidth	PASS
FCC Part 15.236(g) ETSI EN 300 422-1 v1.4.2	Necessary Bandwidth Spurious emissions	PASS
FCC Part 15.209	Radiated Emissions	PASS
FCC Part 15.236(f)(3)	Frequency Stability	PASS
FCC Part 15.203	Antenna Requirement	PASS

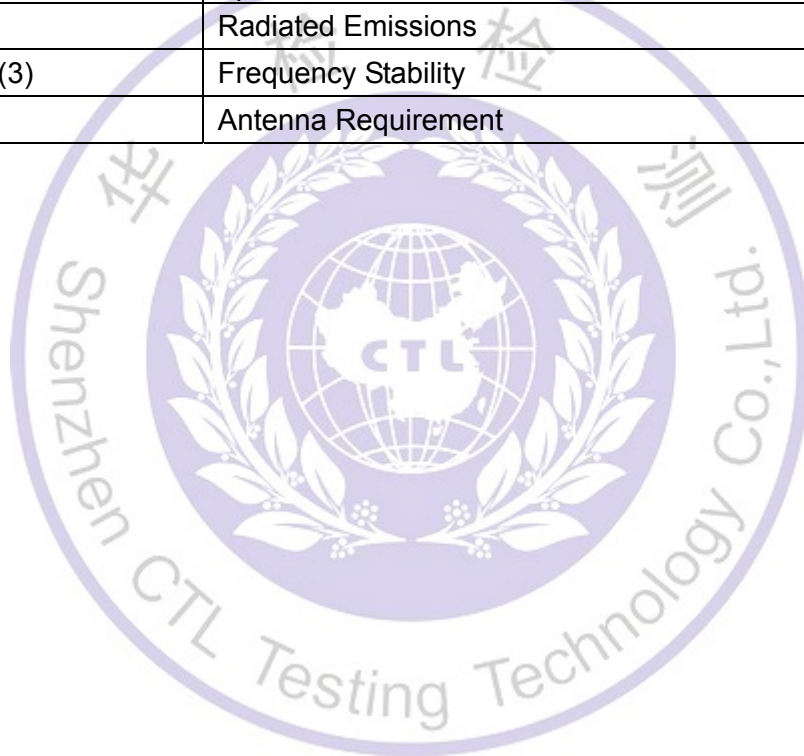

1.3. Test Facility

1.3.1 Address of the test laboratory

Shenzhen CTL Testing Technology Co., Ltd.

Floor 1-A, Baisha Technology Park, No. 3011, Shahexi Road, Nanshan, Shenzhen 518055 China

There is one 3m semi-anechoic chamber and two line conducted labs for final test. The Test Sites meet the requirements in documents ANSI C63.4 and CISPR 32/EN 55032 requirements.

1.3.2 Laboratory accreditation

The test facility is recognized, certified, or accredited by the following organizations:

IC Registration No.: 9618B

The 3m alternate test site of Shenzhen CTL Testing Technology Co., Ltd. EMC Laboratory has been registered by Certification and Engineer Bureau of Industry Canada for the performance of with Registration No.: 9618B on November 13, 2013.

FCC-Registration No.: 399832

Shenzhen CTL Testing Technology Co., Ltd. EMC Laboratory has been registered and fully described in a report filed with the (FCC) Federal Communications Commission. The acceptance letter from the FCC is maintained in our files. Registration 399832, December 08, 2017.

1.4. Statement of the measurement uncertainty

The data and results referenced in this document are true and accurate. The reader is cautioned that there may be errors within the calibration limits of the equipment and facilities. The measurement uncertainty was calculated for all measurements listed in this test report acc. to CISPR 16 - 4 "Specification for radio disturbance and immunity measuring apparatus and methods – Part 4: Uncertainty in EMC Measurements" and is documented in the Shenzhen CTL Testing Technology Co., Ltd. quality system acc. to DIN EN ISO/IEC 17025. Furthermore, component and process variability of devices similar to that tested may result in additional deviation. The manufacturer has the sole responsibility of continued compliance of the device.

Hereafter the best measurement capability for CTL laboratory is reported:

Test	Measurement Uncertainty	Notes
Transmitter power conducted	±0.57 dB	(1)
Transmitter power Radiated	±2.20 dB	(1)
Conducted spurious emission 9KHz-40 GHz	±2.20 dB	(1)
Occupied Bandwidth	±0.01ppm	(1)
Radiated Emission 30~1000MHz	±4.10dB	(1)
Radiated Emission Above 1GHz	±4.32dB	(1)
Conducted Disturbance 0.15~30MHz	±3.20dB	(1)

- (1) This uncertainty represents an expanded uncertainty expressed at approximately the 95% confidence level using a coverage factor of k=2.

2. GENERAL INFORMATION

2.1. Environmental conditions

During the measurement the environmental conditions were within the listed ranges:

Normal Temperature:	25°C
Relative Humidity:	55 %
Air Pressure:	101 kPa

2.2. General Description of EUT

Product Name:	Audio transceiver
Model/Type reference:	K380C
Power supply:	DC 3.7V from battery
Modulation:	4FSK
Operation frequency:	570MHz~579MHz
Channel number:	10
Channel spacing:	25KHz
Antenna type:	Internal antenna
Antenna gain:	1.0dBi

Note: For more details, please refer to the user's manual of the EUT.

2.3. Description of Test Modes and Test Frequency

The Applicant provides software tools to control the EUT for staying in continuous transmitting (Duty Cycle more than 98%) and receiving mode for testing. There are 10 channels provided to the EUT and Channel 01/05/10 were selected to test.

Operation Frequency :

Channel	Frequency (MHz)
01	570
02	571
03	572
04	573
05	574
06	575
07	576
08	577
09	578
10	579

2.4. Equipments Used during the Test

Test Equipment	Manufacturer	Model No.	Serial No.	Calibration Date	Calibration Due Date
LISN	R&S	ENV216	3560.6550.1 2	2018/05/20	2019/05/19
LISN	R&S	ESH2-Z5	860014/010	2018/05/20	2019/05/19
Bilog Antenna	Sunol Sciences Corp.	JB1	A061713	2018/05/20	2019/05/19
EMI Test Receiver	R&S	ESCI	103710	2018/05/20	2019/05/19
Spectrum Analyzer	Agilent	E4407B	MY41440676	2018/05/20	2019/05/19
Spectrum Analyzer	Agilent	N9020	US46220290	2018/05/20	2019/05/19
Controller	EM Electronics	Controller EM 1000	N/A	2018/05/20	2019/05/19
Horn Antenna	Sunol Sciences Corp.	DRH-118	A062013	2018/05/20	2019/05/19
Active Loop Antenna	SCHWARZBECK	FMZB1519	1519-037	2018/05/20	2019/05/19
Amplifier	Agilent	8349B	3008A02306	2018/05/20	2019/05/19
Amplifier	Agilent	8447D	2944A10176	2018/05/20	2019/05/19
Temperature/Humidity Meter	Gangxing	CTH-608	02	2018/05/20	2019/05/19
High-Pass Filter	K&L	9SH10-2700/X1 2750-O/O	N/A	2018/05/20	2019/05/19
High-Pass Filter	K&L	41H10-1375/U1 2750-O/O	N/A	2018/05/20	2019/05/19
Coaxial Cables	HUBER+SUHNER	SUCOFLEX 104PEA-10M	10m	2018/05/20	2019/05/19
Coaxial Cables	HUBER+SUHNER	SUCOFLEX 104PEA-3M	3m	2018/05/20	2019/05/19
Coaxial Cables	HUBER+SUHNER	SUCOFLEX 104PEA-3M	3m	2018/05/20	2019/05/19
RF Cable	Megalon	RF-A303	N/A	2018/05/20	2019/05/19
Power Meter	Anritsu	ML2487B	110553	2018/05/20	2019/05/19
Power Sensor	Anritsu	MA2411B	100345	2018/05/20	2019/05/19

The calibration interval was one year

2.5. Related Submittal(s) / Grant (s)

This submittal(s) (test report) is intended to comply with Section 15.236 of the FCC Part 15, Subpart C Rules.

2.6. Modifications

No modifications were implemented to meet testing criteria.

3. TEST CONDITIONS AND RESULTS

3.1. Conducted Emissions Test

LIMIT

FCC CFR Title 47 Part 15 Subpart C Section 15.207

Frequency range (MHz)	Limit (dBuV)	
	Quasi-peak	Average
0.15-0.5	66 to 56*	56 to 46*
0.5-5	56	46
5-30	60	50

* Decreases with the logarithm of the frequency.

TEST CONFIGURATION

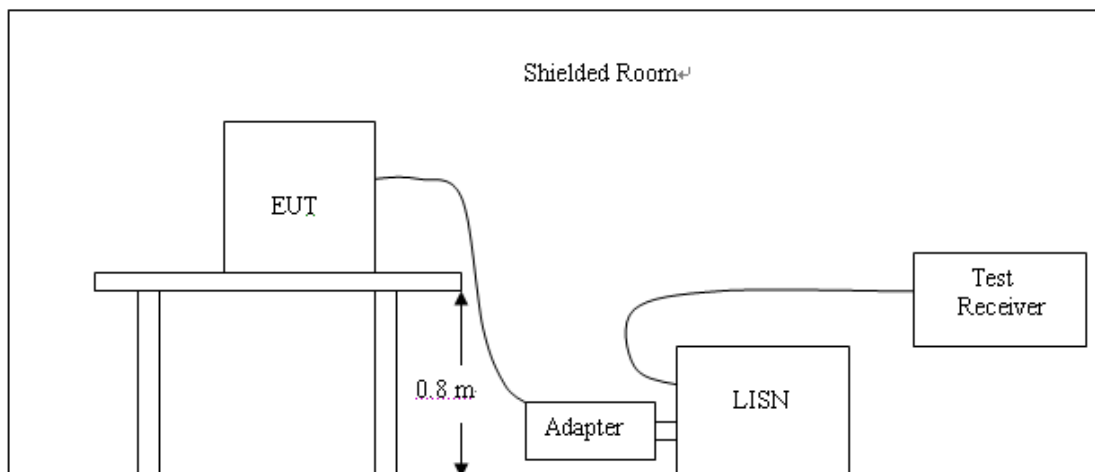

TEST PROCEDURE

1. The equipment was set up as per the test configuration to simulate typical actual usage per the user's manual. The EUT is a tabletop system; a wooden table with a height of 0.8 meters is used and is placed on the ground plane as per ANSI C63.10:2013.
2. Support equipment, if needed, was placed as per ANSI C63.10:2013.
3. All I/O cables were positioned to simulate typical actual usage as per ANSI C63.10:2013.
4. The adapter received AC120V/60Hz power through a Line Impedance Stabilization Network (LISN) which supplied power source and was grounded to the ground plane.
5. All support equipments received AC power from a second LISN, if any.
6. The EUT test program was started. Emissions were measured on each current carrying line of the EUT using a spectrum Analyzer / Receiver connected to the LISN powering the EUT. The LISN has two monitoring points: Line 1 (Hot Side) and Line 2 (Neutral Side). Two scans were taken: one with Line 1 connected to Analyzer / Receiver and Line 2 connected to a 50 ohm load; the second scan had Line 1 connected to a 50 ohm load and Line 2 connected to the Analyzer / Receiver.
7. Analyzer / Receiver scanned from 150 KHz to 30MHz for emissions in each of the test modes.
8. During the above scans, the emissions were maximized by cable manipulation.

TEST RESULTS

Remark: All modes at Low, Middle, and High channel; only the worst result Middle Channel was reported as below:

SCAN TABLE: "Voltage (9K-30M)FIN"
 Short Description: 150K-30M Voltage

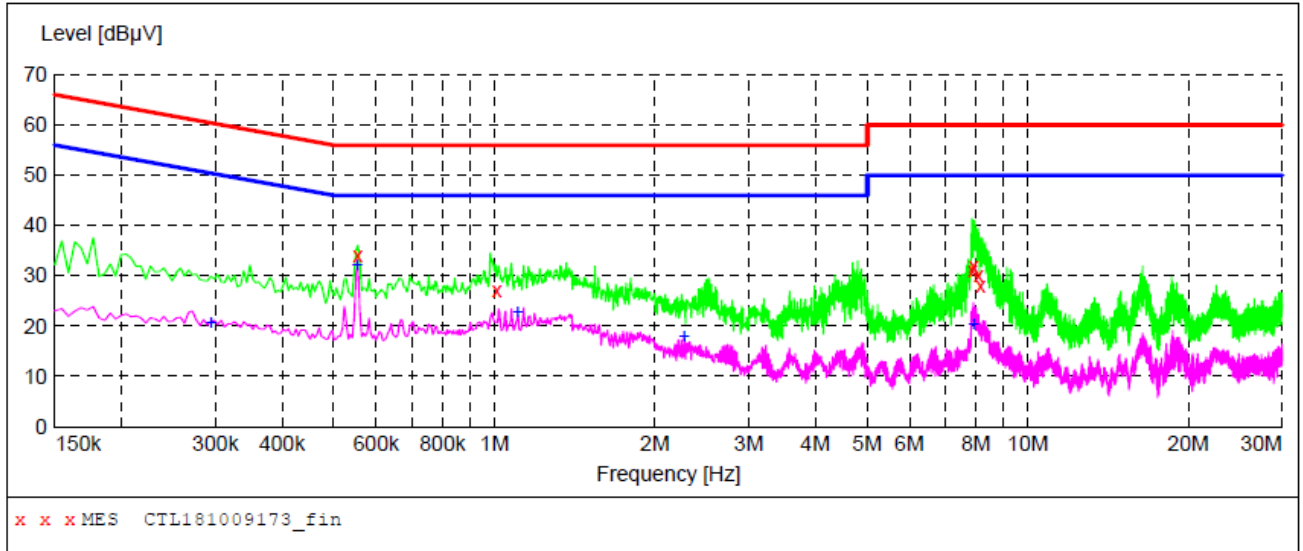

MEASUREMENT RESULT: "CTL181009173_fin"

2018-10-9 03:51??

Frequency MHz	Level dBµV	Transd dB	Limit dBµV	Margin dB	Detector	Line	PE
0.554000	34.00	10.2	56	22.0	QP	L1	GND
1.010000	27.00	10.3	56	29.0	QP	L1	GND
7.880000	31.10	10.5	60	28.9	QP	L1	GND
7.910000	32.10	10.5	60	27.9	QP	L1	GND
8.084000	30.00	10.5	60	30.0	QP	L1	GND
8.156000	27.90	10.5	60	32.1	QP	L1	GND

MEASUREMENT RESULT: "CTL181009173_fin2"

2018-10-9 03:51??

Frequency MHz	Level dBµV	Transd dB	Limit dBµV	Margin dB	Detector	Line	PE
0.294000	20.90	10.2	50	29.5	AV	L1	GND
0.554000	32.40	10.2	46	13.6	AV	L1	GND
1.106000	22.80	10.3	46	23.2	AV	L1	GND
2.270000	18.00	10.4	46	28.0	AV	L1	GND
7.910000	20.50	10.5	50	29.5	AV	L1	GND

SCAN TABLE: "Voltage (9K-30M) FIN"

Short Description: 150K-30M Voltage

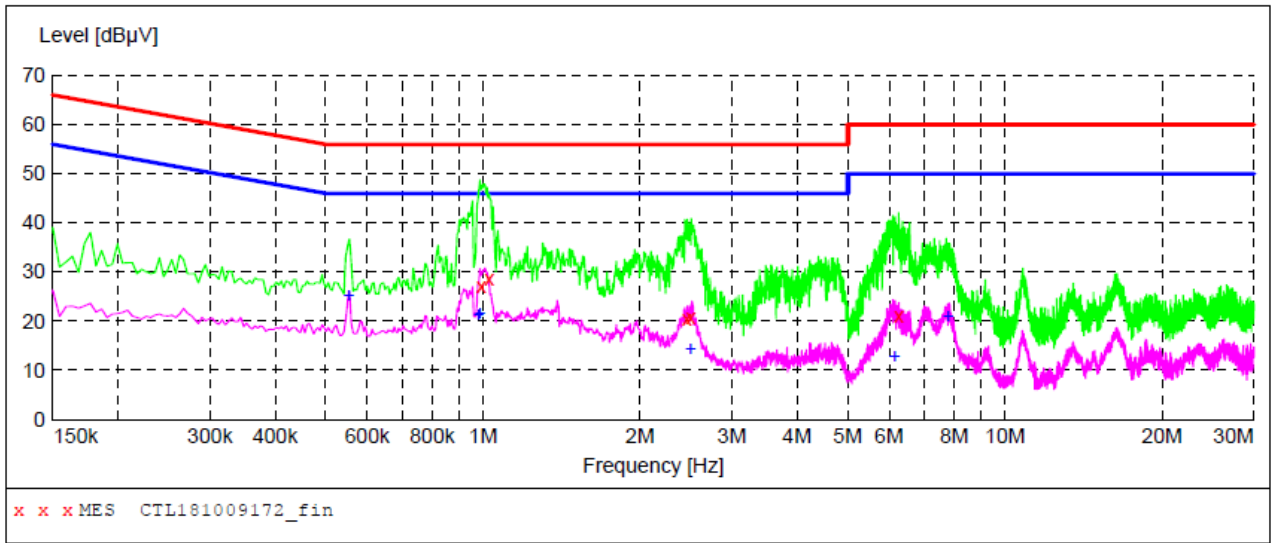

MEASUREMENT RESULT: "CTL181009172_fin"

2018-10-9 03:48??

Frequency MHz	Level dBµV	Transd dB	Limit dBµV	Margin dB	Detector	Line	PE
0.992000	27.00	10.3	56	29.0	QP	N	GND
1.028000	28.50	10.3	56	27.5	QP	N	GND
2.456000	20.50	10.4	56	35.5	QP	N	GND
2.504000	20.90	10.4	56	35.1	QP	N	GND
6.266000	21.00	10.4	60	39.0	QP	N	GND

MEASUREMENT RESULT: "CTL181009172_fin2"

2018-10-9 03:48??

Frequency MHz	Level dBµV	Transd dB	Limit dBµV	Margin dB	Detector	Line	PE
0.554000	25.40	10.2	46	20.6	AV	N	GND
0.980000	21.40	10.3	46	24.6	AV	N	GND
0.986000	21.70	10.3	46	24.3	AV	N	GND
2.498000	14.40	10.4	46	31.6	AV	N	GND
6.146000	12.90	10.4	50	37.1	AV	N	GND
7.778000	21.20	10.5	50	28.8	AV	N	GND

3.2. Radiated Emissions and Band Edge

Limit

For intentional device, according to § 15.209(a), the general requirement of field strength of radiated emission out of authorized band shall not exceed the following table at a 3 meters measurement distance.

In addition, radiated emissions which fall in the restricted bands, as defined in §15.205(a), must also comply with the radiated emission limits specified in §15.209(a)

Radiated emission limits

Frequency (MHz)	Distance (Meters)	Radiated (dB μ V/m)	Radiated (μ V/m)
0.009-0.49	3	$20\log(2400/F(\text{KHz}))+40\log(300/3)$	$2400/F(\text{KHz})$
0.49-1.705	3	$20\log(24000/F(\text{KHz}))+40\log(30/3)$	$24000/F(\text{KHz})$
1.705-30	3	$20\log(30)+40\log(30/3)$	30
30-88	3	40.0	100
88-216	3	43.5	150
216-960	3	46.0	200
Above 960	3	54.0	500

TEST CONFIGURATION

(A) Radiated Emission Test Set-Up, Frequency Below 30MHz

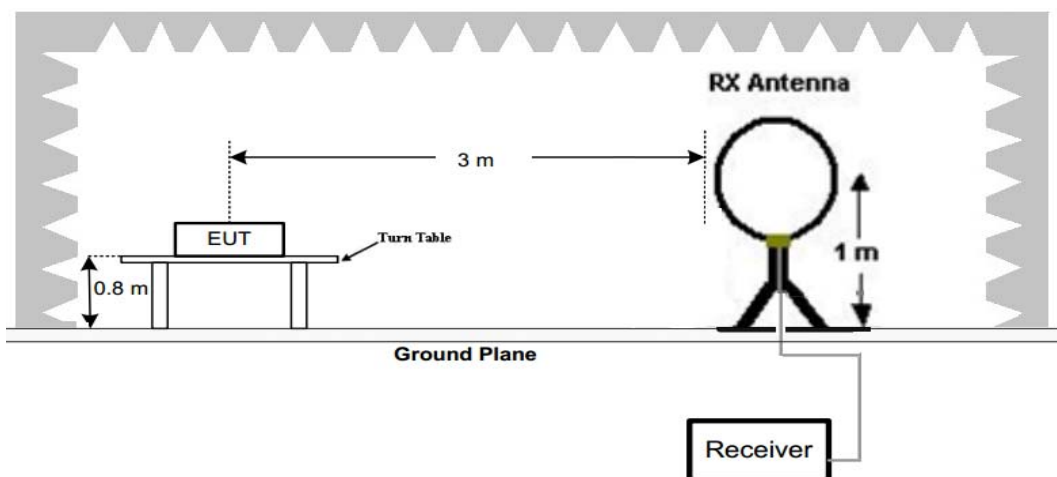

(B) Radiated Emission Test Set-Up, Frequency below 1000MHz

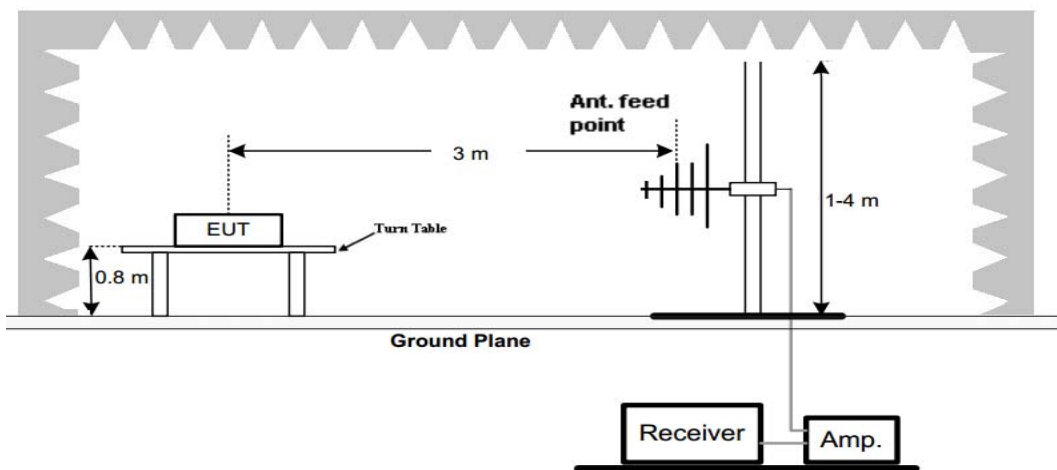

(C) Radiated Emission Test Set-Up, Frequency above 1000MHz

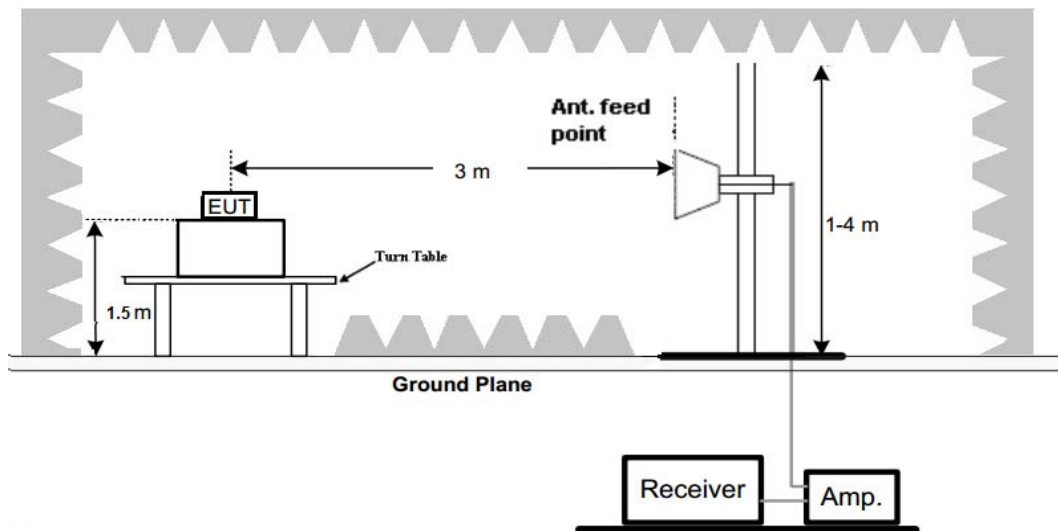

Test Procedure

1. Below 1GHz measurement the EUT is placed on a turntable which is 0.8m above ground plane, and above 1GHz measurement EUT was placed on a low permittivity and low loss tangent turn table which is 1.5m above ground plane.
2. Maximum procedure was performed by raising the receiving antenna from 1m to 4m and rotating the turn table from 0° to 360° to acquire the highest emissions from EUT
3. And also, each emission was to be maximized by changing the polarization of receiving antenna both horizontal and vertical.
4. Repeat above procedures until all frequency measurements have been completed.

TEST RESULTS

Remark:

1. We measured Radiated Emission at all mode Low, Middle, and High channel from 9 KHz to 25GHz and recorded worst case at low channel.
2. For below 1GHz testing recorded worst at low channel.
3. Radiated emission test from 9 KHz to 10th harmonic of fundamental was verified, and no emission found except system noise floor in 9 KHz to 30MHz and not recorded in this report.

For 30MHz-1GHz

Horizontal

SWEEP TABLE: "test (30M-1G)"

Short Description:		Field Strength			
Start	Stop	Detector	Meas. Time	IF Bandw.	Transducer
30.0 MHz	1.0 GHz	MaxPeak	200.0 ms	120 kHz	VULB 9168

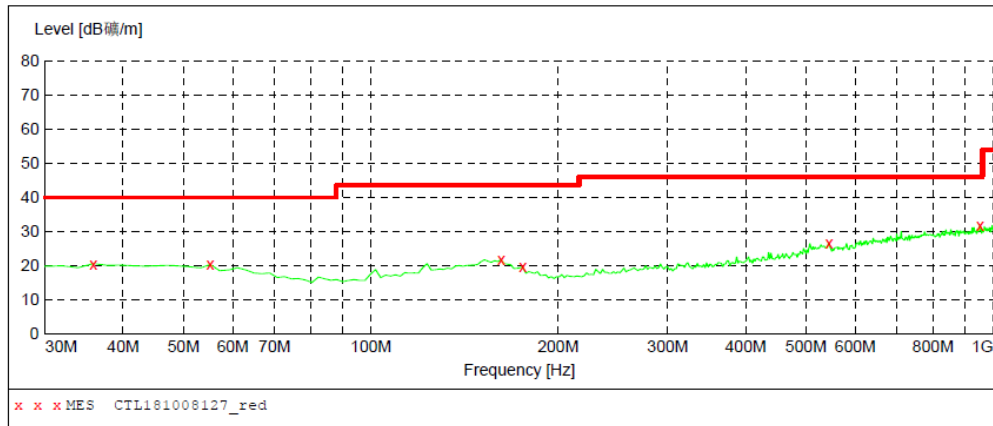

MEASUREMENT RESULT: "CTL181008127_red"

2018-10-8 9:49

Frequency MHz	Level dBμV/m	Transd dB	Limit dBμV/m	Margin dB	Det.	Height cm	Azimuth deg	Polarization
35.820000	20.50	14.2	40.0	19.5	---	0.0	0.00	HORIZONTAL
55.220000	20.30	13.8	40.0	19.7	---	0.0	0.00	HORIZONTAL
161.920000	21.70	15.0	43.5	21.8	---	0.0	0.00	HORIZONTAL
175.500000	19.60	13.4	43.5	23.9	---	0.0	0.00	HORIZONTAL
544.100000	26.70	19.0	46.0	19.3	---	0.0	0.00	HORIZONTAL
951.500000	31.60	24.2	46.0	14.4	---	0.0	0.00	HORIZONTAL

Vertical

SWEEP TABLE: "test (30M-1G)"

Short Description:		Field Strength			
Start	Stop	Detector	Meas. Time	IF Bandw.	Transducer
30.0 MHz	1.0 GHz	MaxPeak	200.0 ms	120 kHz	VULB 9168

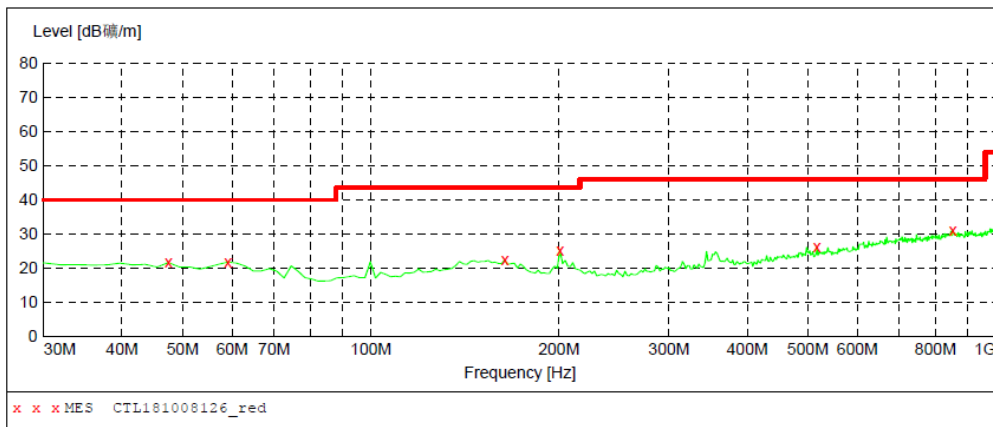

MEASUREMENT RESULT: "CTL181008126_red"

2018-10-8 9:47

Frequency MHz	Level dBμV/m	Transd dB	Limit dBμV/m	Margin dB	Det.	Height cm	Azimuth deg	Polarization
47.460000	21.60	14.3	40.0	18.4	---	0.0	0.00	VERTICAL
59.100000	21.70	13.5	40.0	18.3	---	0.0	0.00	VERTICAL
163.860000	22.30	14.8	43.5	21.2	---	0.0	0.00	VERTICAL
200.720000	25.20	11.1	43.5	18.3	---	0.0	0.00	VERTICAL
516.940000	26.10	18.5	46.0	19.9	---	0.0	0.00	VERTICAL
852.560000	31.00	23.1	46.0	15.0	---	0.0	0.00	VERTICAL

Note: Above 1-6GHz have been tested and found no emission except floor noise.

3.3. Maximum Output Power

Limit

The maximum radiated power shall not exceed the following values:

- (1) In the bands allocated and assigned for broadcast television and in the 600 MHz service band: 50 mW EIRP
- (2) In the 600 MHz guard band and the 600 MHz duplex gap: 20 mW EIRP.

Test Procedure

Remove the antenna from the EUT and then connect a low loss RF cable from the antenna port to the power sensor.

Test Configuration



Test Results

Type	Channel	Output power (dBm)	Ant. Gain (dBi)	EIRP (dBm)	Limit (dBm)	Result
4FSK	CH01	0.951	1.0	1.951	17	Pass
	CH05	0.333	1.0	1.333	17	Pass
	CH10	-0.022	1.0	0.978	17	Pass

Note: 1.The test results including the cable lose:

3.4. Occupied Bandwidth

Limit

One or more adjacent 25 kHz segments within the assignable frequencies may be combined to form a channel whose maximum bandwidth shall not exceed 200 kHz. The operating bandwidth shall not exceed 200 kHz.

Test Procedure

The transmitter output was connected to the spectrum analyzer through an attenuator. The bandwidth of the fundamental frequency was measured by spectrum analyzer with 3 KHz RBW and 10 KHz VBW.

Test Configuration



Test Results

Modulation	Channel	99% OBW (KHz)	Limit (KHz)	Result
4FSK	CH01	129.82	200	Pass
	CH05	129.44	200	
	CH10	131.45	200	

Test plot as follows:

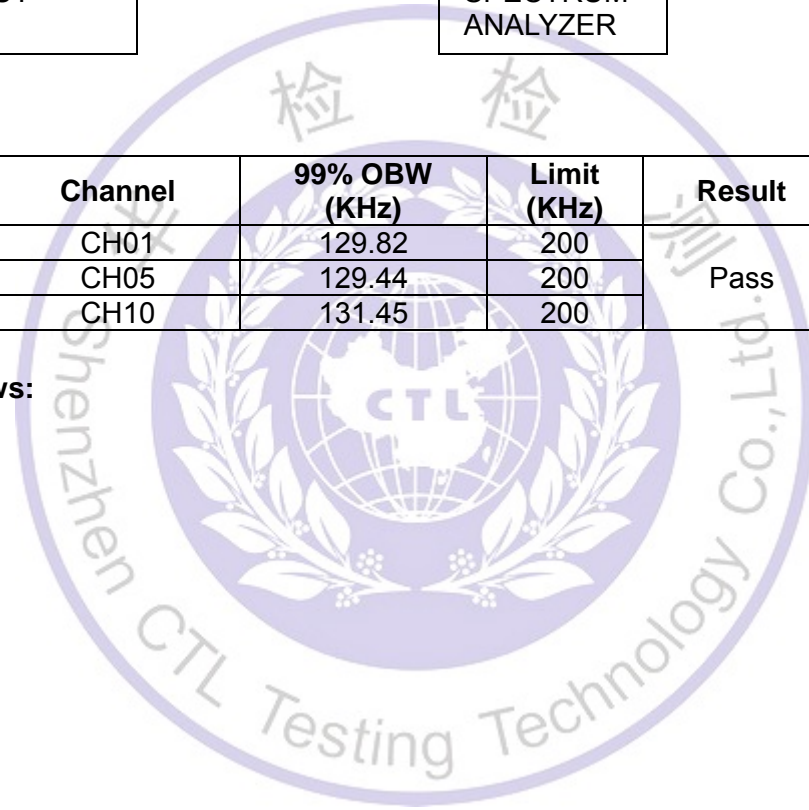



CH00

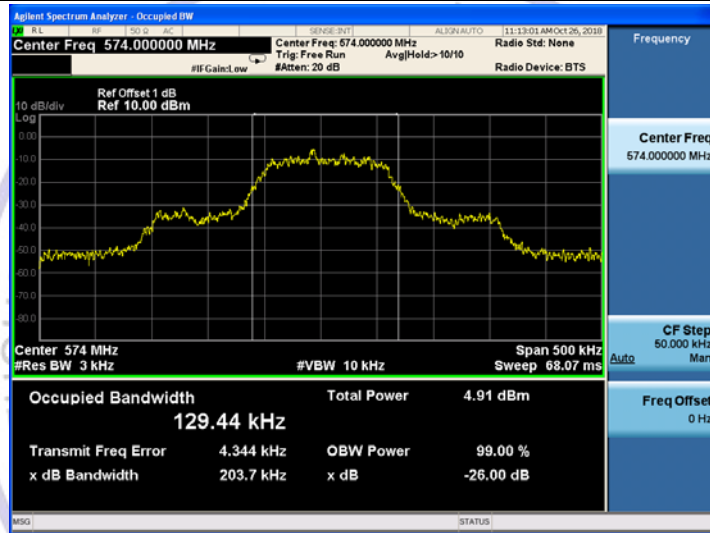

CH05

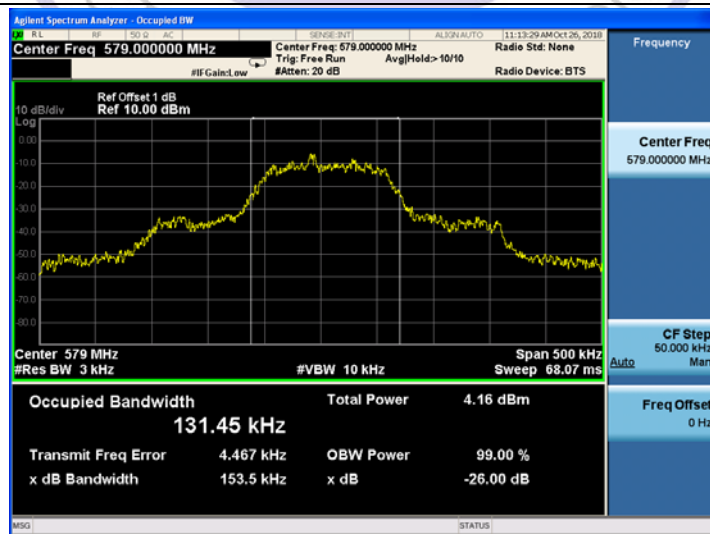

CH10

3.5. Necessary Bandwidth

LIMIT

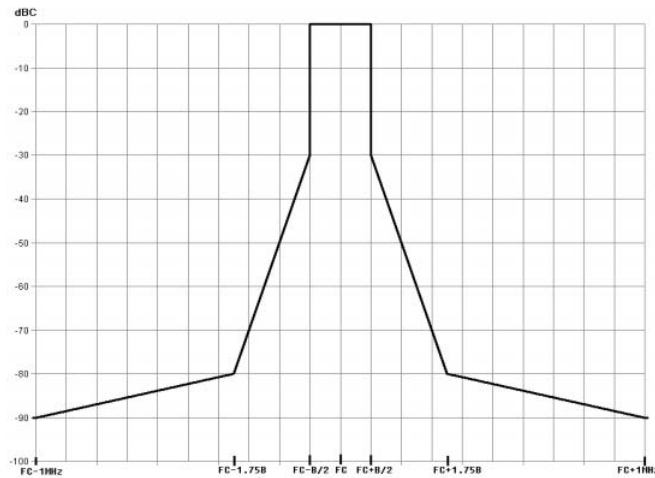

Figure 4: Spectrum mask for digital systems below 1 GHz

TEST PROCEDURE

The transmitter shall be modulated with the test signals defined in clause 7.1.2. In any case the mask shall not be exceeded.

- Step 1: Measure the "Carrier Power" with the spectrum analyzer setup:

- Center Frequency = f_c
- Span = Zero span
- Detector = RMS
- Trace Mode = Average
- RBW&VBW = $5 \times B$
- Sweep time ≥ 2 s

- Step 2: Measure the "Maximum Relative Level (dBc) at Specified Carrier Offsets" with the following spectrum analyzer setup:

- Center Frequency = f_c
- Span $\geq 5 \times B$
- Detector = RMS
- Trace Mode = Peak Hold
- RBW&VBW = 1 kHz
- Sweep time ≥ 2 s

Limits: Mask shall not be exceeded.

- Step 3: Measure the "transmitter wide band noise floor": The measurement of transmitter broad band noise floor shall be carried out according to clause 8.3.1.1.

- Start Frequency = $f_c + 1,75B$ and $f_c - 1$ MHz below 1 GHz,
Start Frequency = $f_c + B$ and $f_c - 1$ MHz above 1 GHz.
- Stop Frequency = $f_c + 1$ MHz and $f_c - 1,75 B$ below 1 GHz,
Stop Frequency = $f_c + 1$ MHz and $f_c - B$ above 1 GHz.
- Detector = RMS
- Trace Mode = Average
- RBW&VBW = 1 kHz
- Sweep time ≥ 2 s

NOTE 2: Two spectrum ranges are to be measured!

Limits: Mask shall not be exceeded.

TEST CONFIGURATION

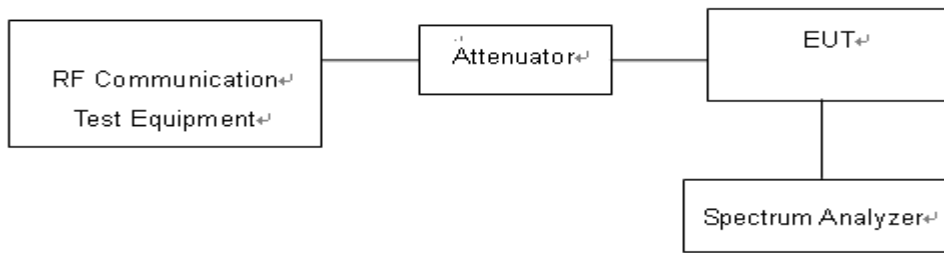

TEST RESULTS

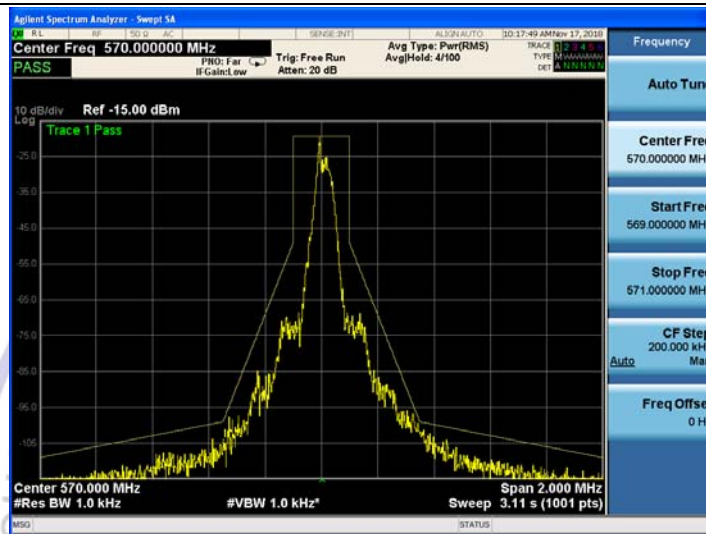

CH00

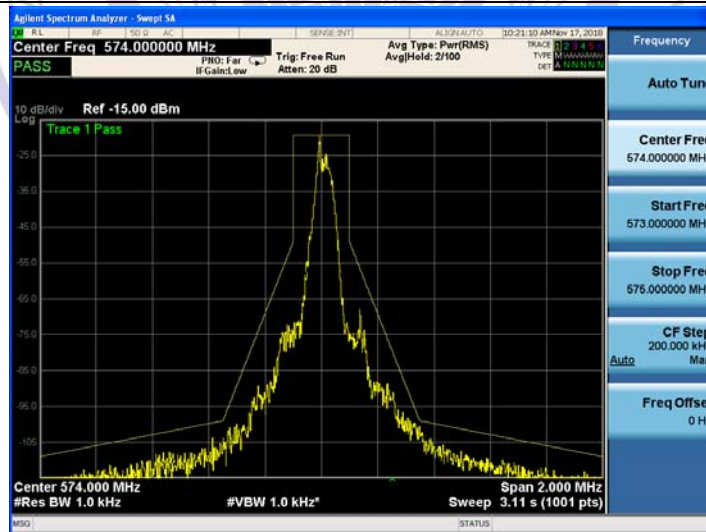

CH05

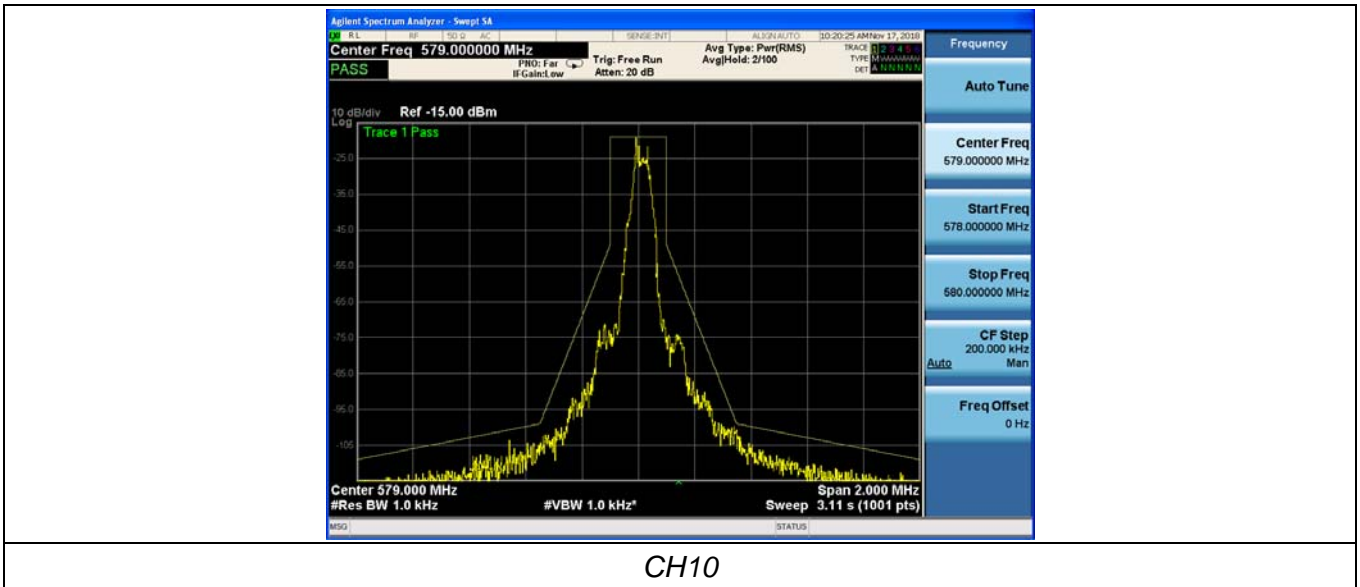

CH10



3.6. Transmitter spurious emissions

Limit

Spurious emissions are emissions outside the frequency range(s) of the equipment. The power of the spurious emissions shall not exceed the limits of table as below:

State	Frequency		
	47 MHz to 74 MHz 87,5 MHz to 137 MHz 174 MHz to 230 MHz 470 MHz to 862 MHz	Other Frequencies below 1 000 MHz	Frequencies above 1 000 MHz
Operation	4 nW	250 nW	1 μ W
Standby	2 nW	2 nW	20 nW

Test Procedure

The transmitter output was connected to the spectrum analyzer through an attenuator. Set spectrum analyzer start 2400MHz to 2483.5MHz with 100 KHz RBW and 300 KHz VBW.

Test Configuration

Effective Radiated Power measurement (30 MHz to 12.75 GHz)

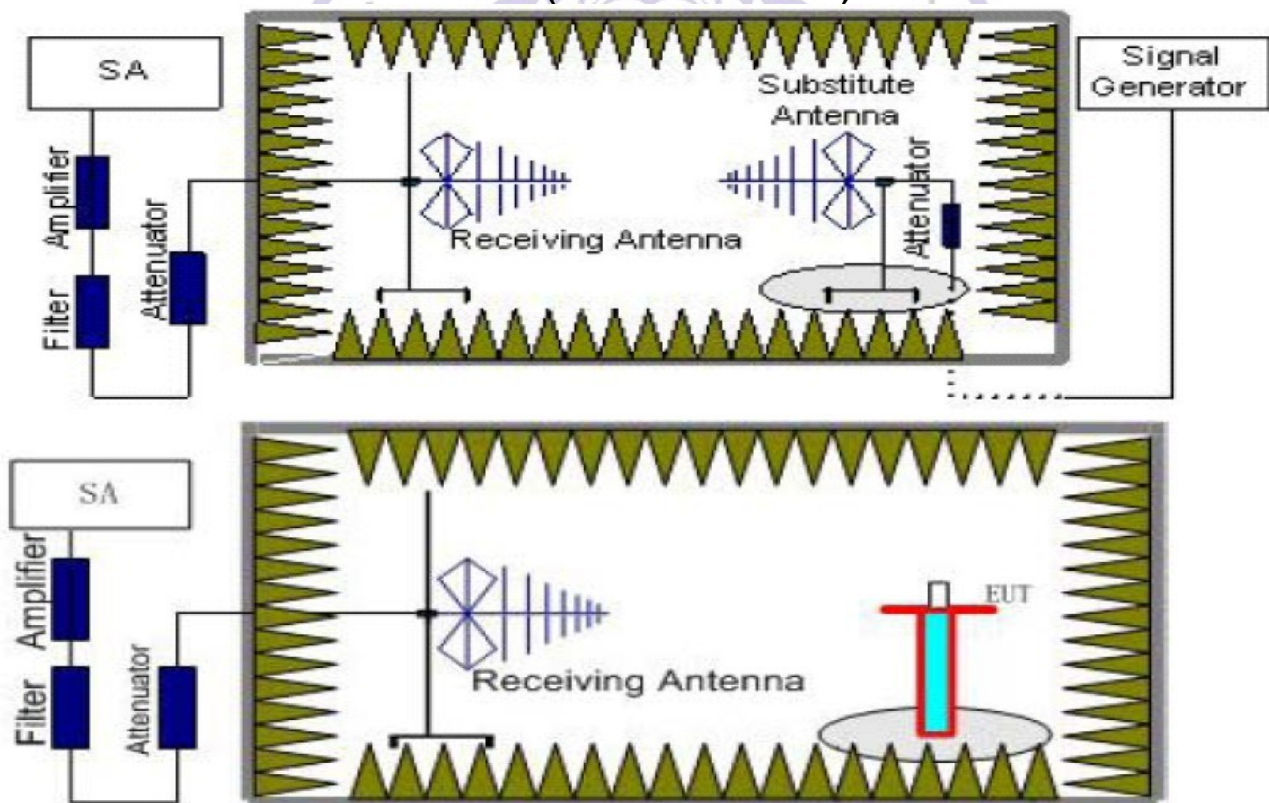

TEST PROCEDURE

1. Please refer to ETSI EN 300 422-1 V1.4.2 (2011-08) clause 6.1 for the test conditions.
2. Please refer to ETSI EN 300 422-1 V1.4.2 (2011-08) clause 8.4.2 for the measurement method.

Test Results

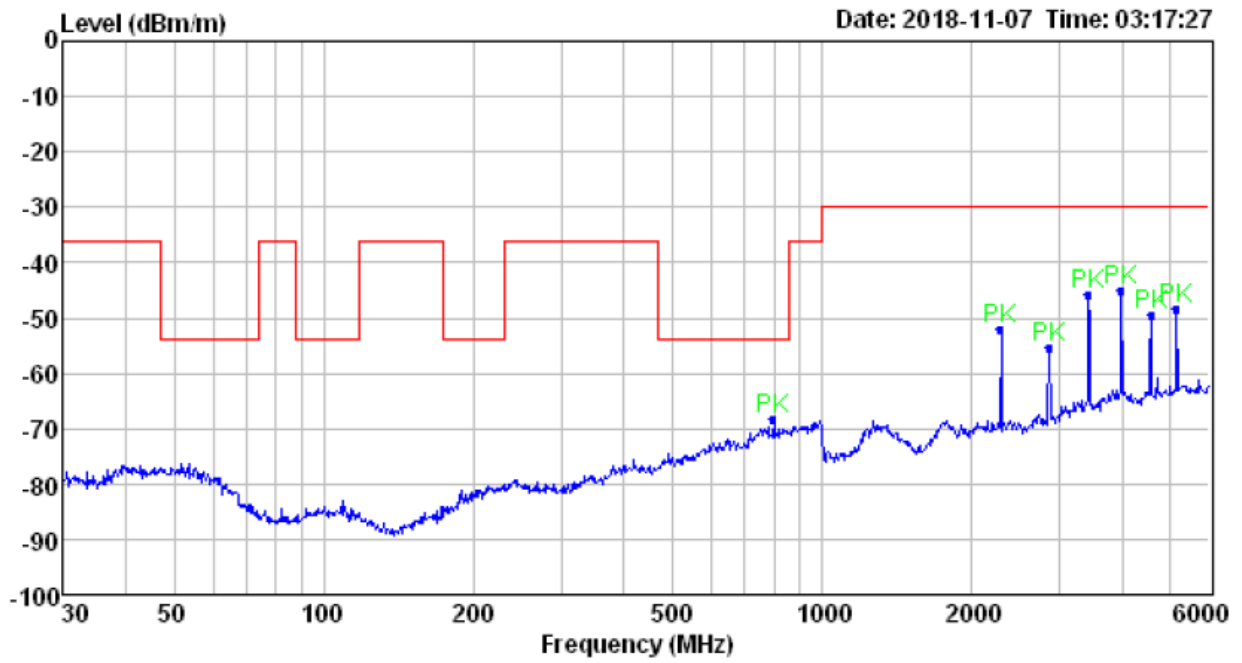

Mark	Frequency MHz	Level dBm	Factor dB	Reading dBm	Limit dB	Margin dB	Det.	Polarization
1	798.98	-68.40	4.95	-73.35	-54.00	14.40	Peak	HORIZONTAL
2	2278.00	-52.10	-3.76	-48.34	-30.00	22.10	Peak	HORIZONTAL
3	2851.65	-55.36	-1.52	-53.84	-30.00	25.36	Peak	HORIZONTAL
4	3419.07	-45.94	0.87	-46.81	-30.00	15.94	Peak	HORIZONTAL
5	3990.40	-44.92	3.38	-48.30	-30.00	14.92	Peak	HORIZONTAL
6	4566.06	-49.47	4.12	-53.59	-30.00	19.47	Peak	HORIZONTAL
7	5131.72	-48.34	5.80	-54.14	-30.00	18.34	Peak	HORIZONTAL



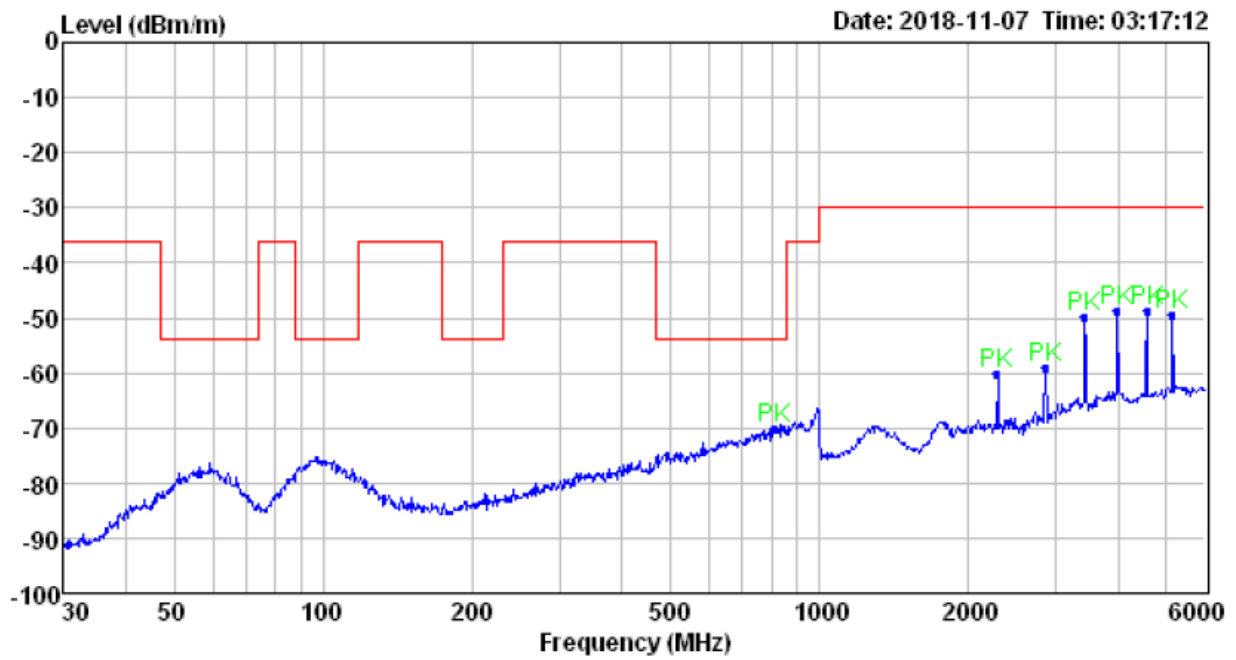

Mark	Frequency MHz	Level dBm	Factor dB	Reading dBm	Limit dB	Margin dB	Det.	Polarization
1	813.11	-70.02	5.35	-75.37	-54.00	16.02	Peak	VERTICAL
2	2278.00	-60.17	-3.76	-56.41	-30.00	30.17	Peak	VERTICAL
3	2851.65	-59.18	-1.52	-57.66	-30.00	29.18	Peak	VERTICAL
4	3419.07	-49.86	0.87	-50.73	-30.00	19.86	Peak	VERTICAL
5	3990.40	-48.83	3.38	-52.21	-30.00	18.83	Peak	VERTICAL
6	4566.06	-48.79	4.12	-52.91	-30.00	18.79	Peak	VERTICAL
7	5131.72	-49.30	5.80	-55.10	-30.00	19.30	Peak	VERTICAL



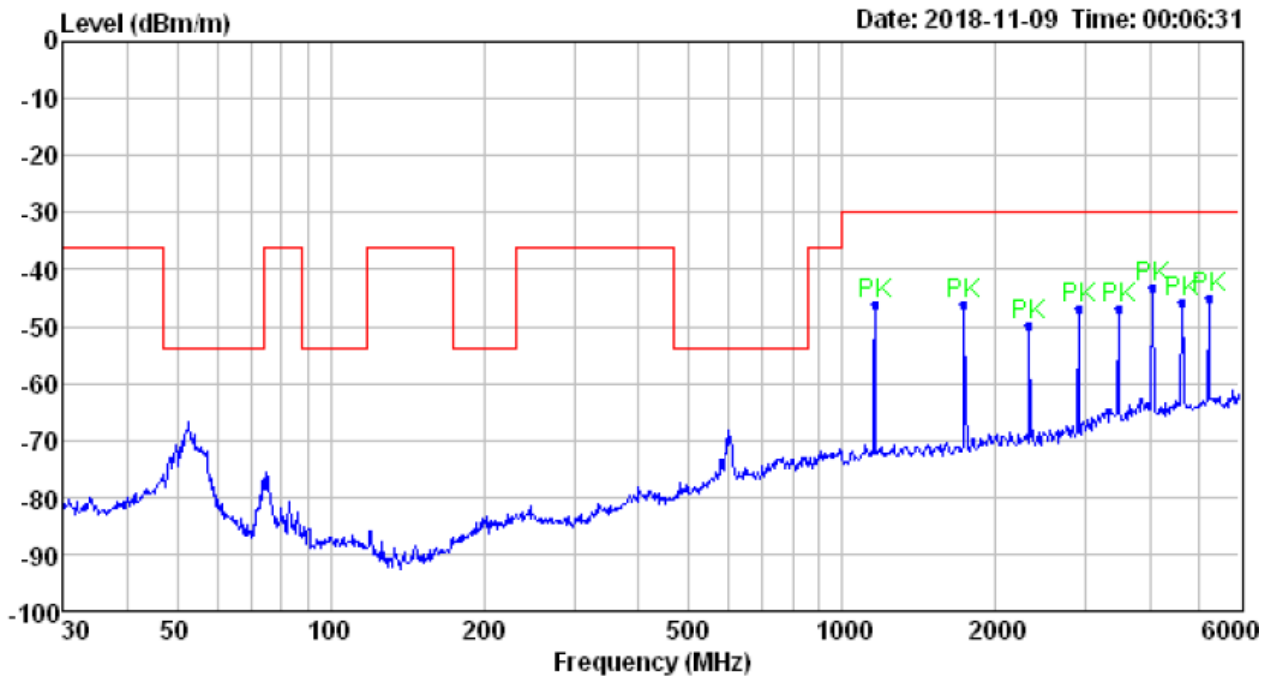

Mark	Frequency MHz	Level dBm	Factor dB	Reading dBm	Limit dB	Margin dB	Det.	Polarization
1	1157.10	-46.24	-8.04	-38.20	-30.00	16.24	Peak	HORIZONTAL
2	1736.70	-46.01	-5.65	-40.36	-30.00	16.01	Peak	HORIZONTAL
3	2315.14	-50.00	-3.62	-46.38	-30.00	20.00	Peak	HORIZONTAL
4	2898.13	-46.74	-1.18	-45.56	-30.00	16.74	Peak	HORIZONTAL
5	3474.81	-47.03	1.21	-48.24	-30.00	17.03	Peak	HORIZONTAL
6	4055.46	-43.25	3.28	-46.53	-30.00	13.25	Peak	HORIZONTAL
7	4632.17	-45.82	4.30	-50.12	-30.00	15.82	Peak	HORIZONTAL
8	5215.38	-44.88	5.91	-50.79	-30.00	14.88	Peak	HORIZONTAL



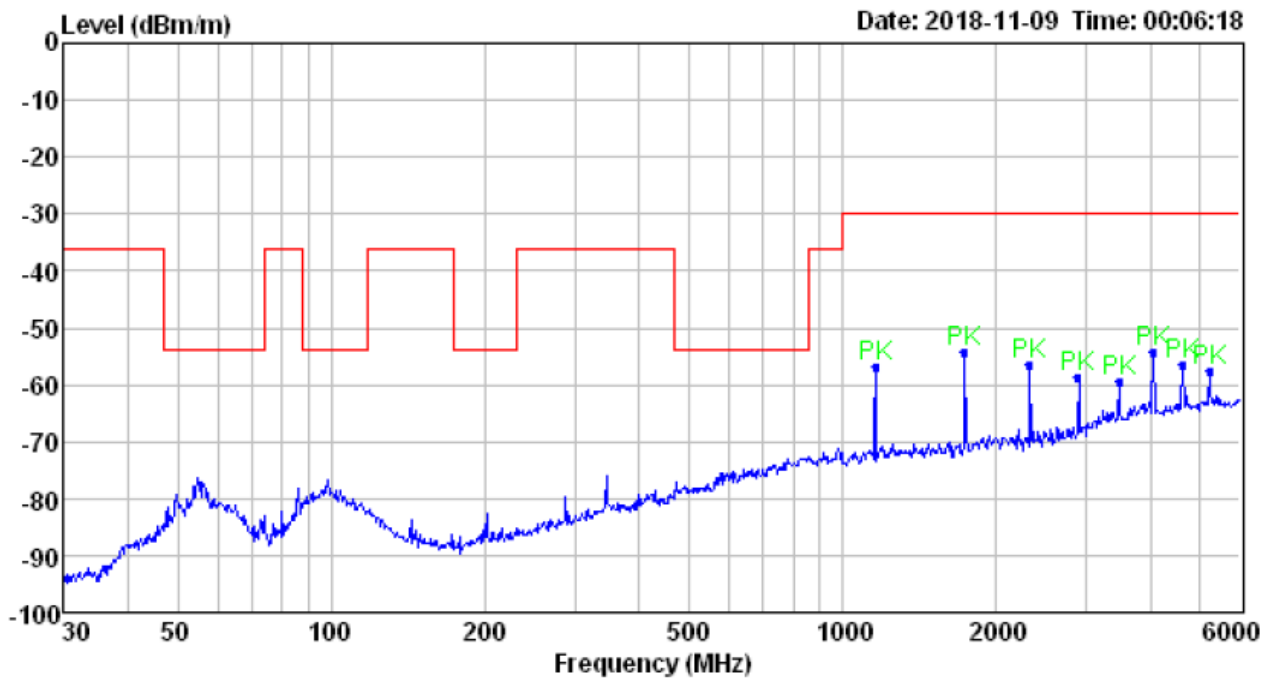

Mark	Frequency MHz	Level dBm	Factor dB	Reading dBm	Limit dB	Margin dB	Det.	Polarization
1	1157.10	-57.00	-8.04	-48.96	-30.00	27.00	Peak	VERTICAL
2	1736.70	-54.30	-5.65	-48.65	-30.00	24.30	Peak	VERTICAL
3	2315.14	-56.47	-3.62	-52.85	-30.00	26.47	Peak	VERTICAL
4	2892.93	-58.58	-1.28	-57.30	-30.00	28.58	Peak	VERTICAL
5	3474.81	-59.43	1.21	-60.64	-30.00	29.43	Peak	VERTICAL
6	4055.46	-54.41	3.28	-57.69	-30.00	24.41	Peak	VERTICAL
7	4632.17	-56.42	4.30	-60.72	-30.00	26.42	Peak	VERTICAL
8	5215.38	-57.39	5.91	-63.30	-30.00	27.39	Peak	VERTICAL



3.7. Frequency Stability

Limit

The frequency tolerance of the carrier signal shall be maintained within $\pm 0.005\%$ of the operating frequency over a temperature variation of -20 degrees to $+50$ degrees C at normal supply voltage, and for a variation in the primary supply voltage from 85% to 115% of the rated supply voltage at a temperature of 20 degrees C. Battery operated equipment shall be tested using a new battery.

Test Procedure

a) Frequency stability versus environmental temperature

1. Setup as Test Configuration for frequencies measured at ambient temperature if it is within 15°C to 25°C . Otherwise, an environmental chamber set for a temperature of 20°C shall be used.
2. Turn on EUT and set SA center frequency to the right frequency needs to be measured. Then set SA RBW to 3 kHz, VBW to 10kHz and frequency span to 500 kHz. Record this frequency to be a reference.
3. Set the temperature of chamber to 50°C . Allow sufficient time (approximately 30 min) for the temperature of the chamber to stabilize. While maintaining a constant temperature inside the chamber, turn the EUT on and measure the EUT operating frequency.
4. Repeat step 2 with a 10°C decreased per stage until the lowest temperature -20°C is measured, record all measurement frequencies.

b) Frequency stability versus input voltage

1. Setup as Test Configuration for frequencies measured at ambient temperature if it is within 15°C to 25°C . Otherwise, an environmental chamber set for a temperature of 20°C shall be used. Install new batteries in the EUT.
2. Set SA center frequency to the right frequency needs to be measured. Then set SA RBW to 3kHz, VBW to 10kHz and frequency span to 500 kHz. Record this frequency to be a reference.
3. For non hand carried, battery operated device, supply the EUT primary voltage with 85 and 115 percent of the nominal value and record the frequency.

Test Configuration

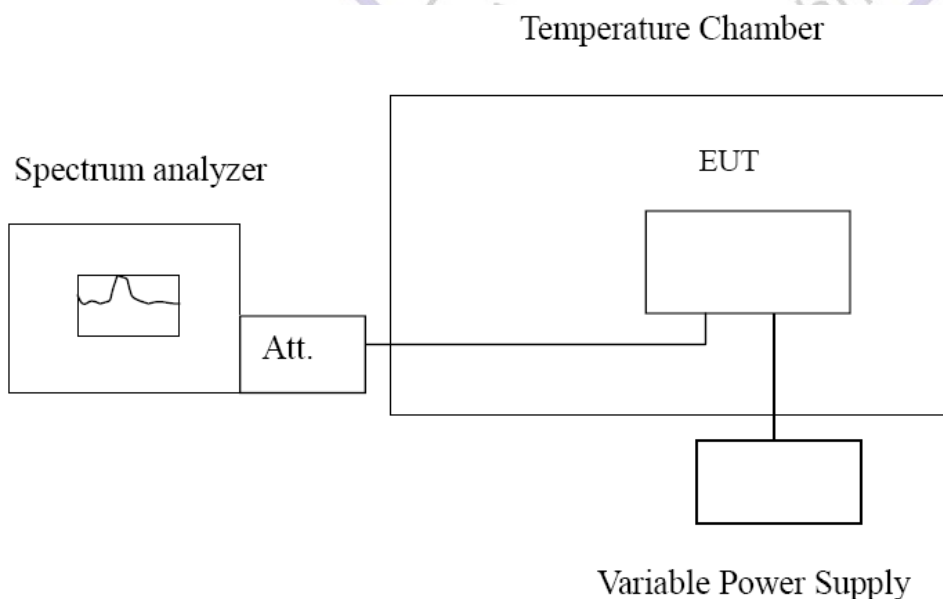

Test Results

Reference Frequency: 570.00MHz					
Voltage (V)	Temperature (°C)	Frequency error (MHz)	Frequency Tolerance (%)	Limit (%)	Result
3.7	-20	0.01847	0.00276%	±0.005	PASS
	-10	0.01823	0.00272%		
	0	0.01678	0.00250%		
	10	0.01796	0.00268%		
	20	0.01844	0.00275%		
	30	0.01721	0.00257%		
	40	0.01774	0.00265%		
	50	0.01832	0.00273%		
3.45	25	0.01811	0.00270%		
2.55	25	0.01837	0.00274%		

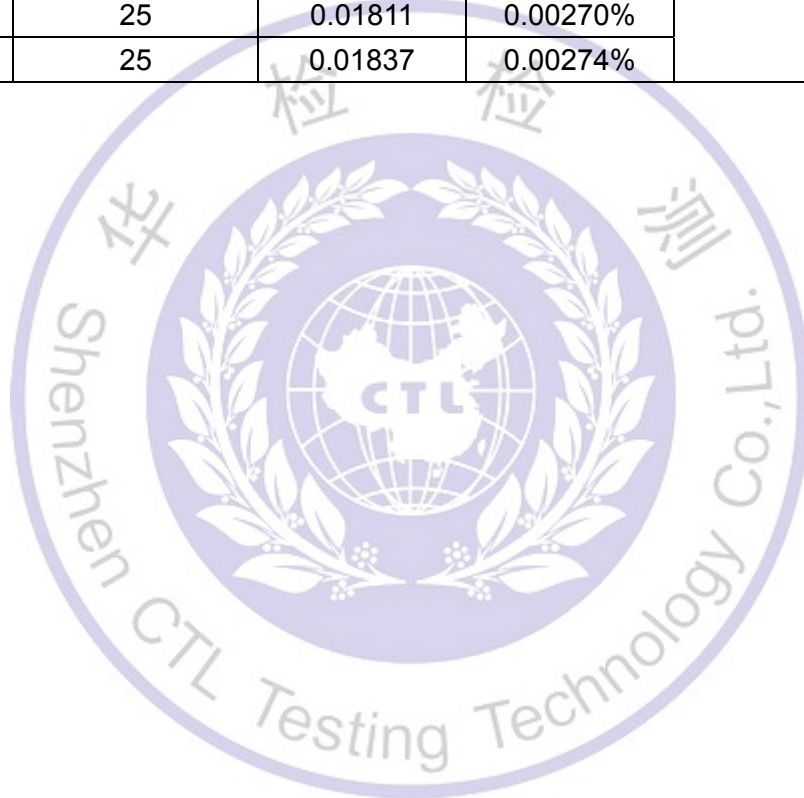

3.8. Antenna Requirement

Standard Applicable

For intentional device, according to FCC 47 CFR Section 15.203, an intentional radiator shall be designed to ensure that no antenna other than that furnished by the responsible party shall be used with the device.

Refer to statement below for compliance

The manufacturer may design the unit so that the user can replace a broken antenna, but the use of a standard antenna jack or electrical connector is prohibited. Further, this requirement does not apply to intentional radiators that must be professionally installed.

Antenna Connected Construction

The maximum gain of antenna was 1.0dBi.

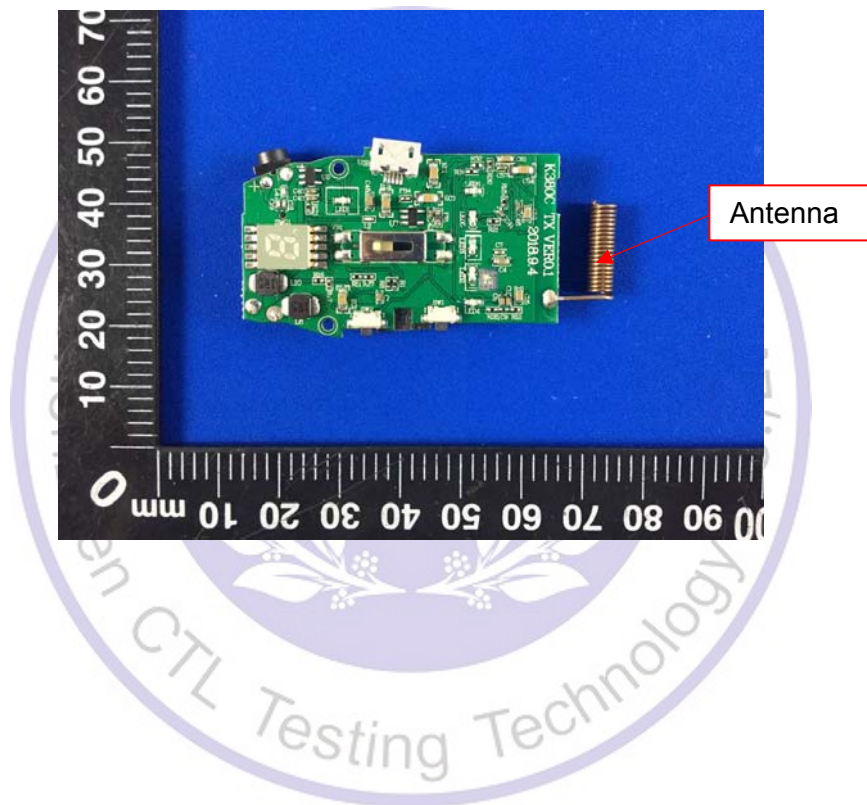

4. Test Setup Photos of the EUT



5. Photos of the EUT

External Photos

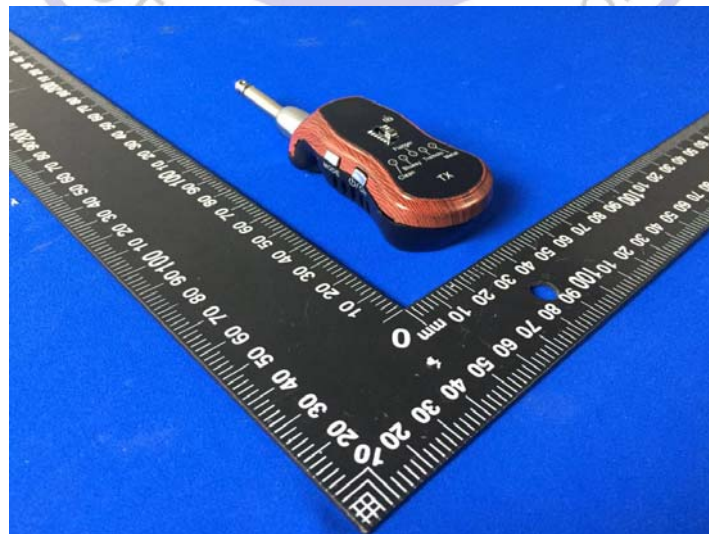

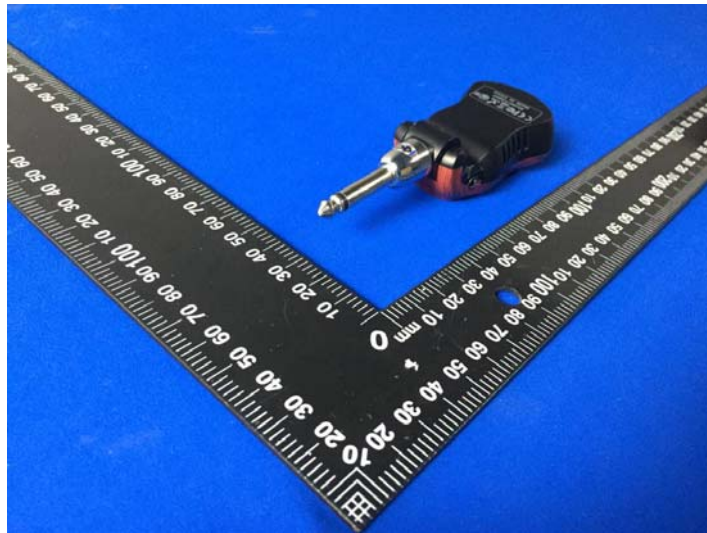

Internal Photos

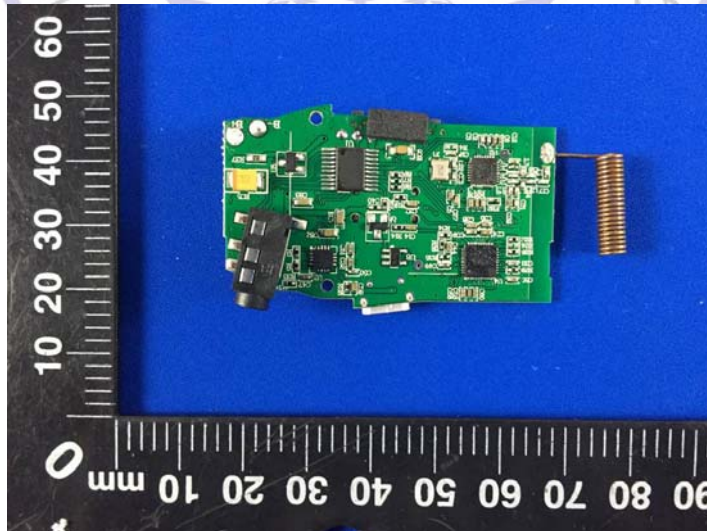
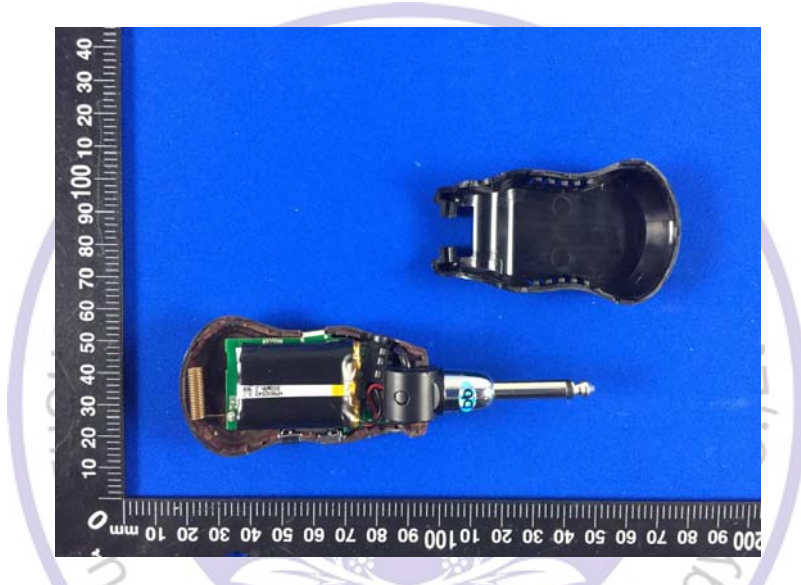

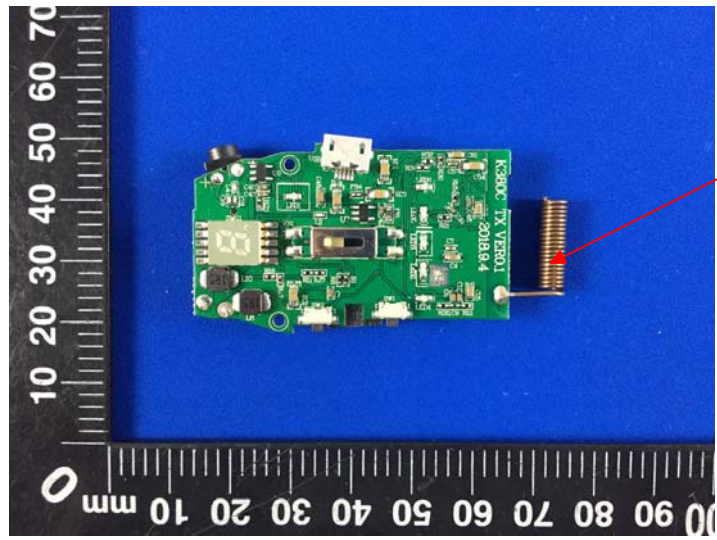

Antenna

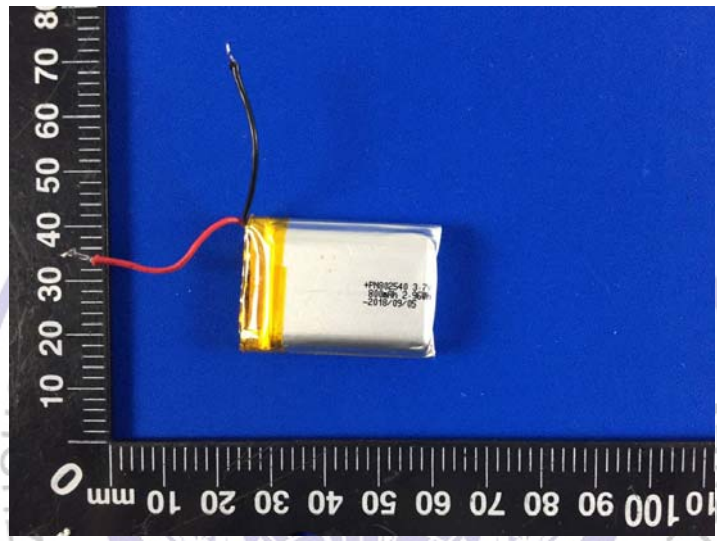

***** End of Report *****

