

Bandwidth=10MHz – 64QAM

ANT 1

ANT 2

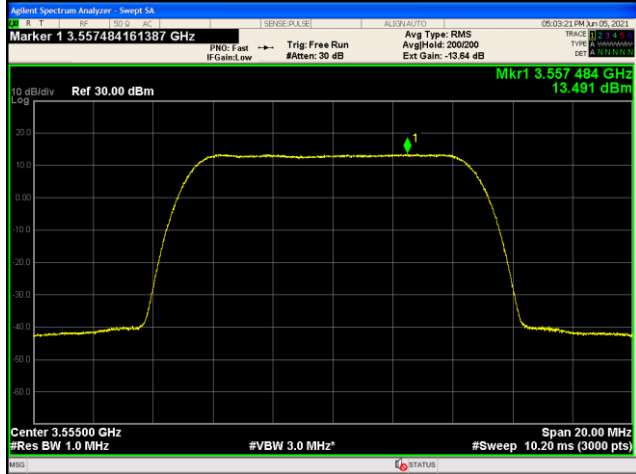

Lowest channel

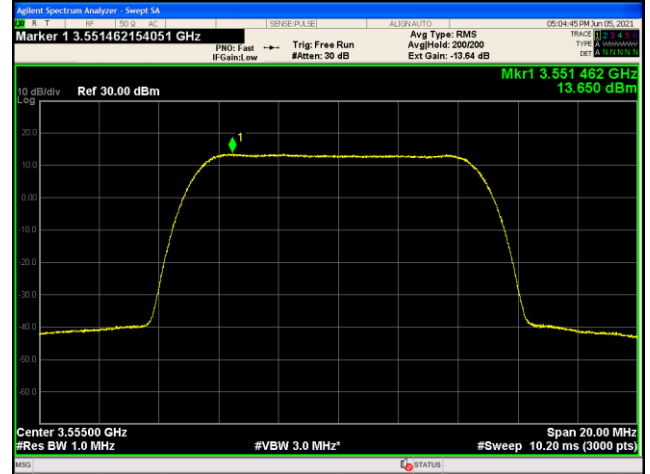

Lowest channel

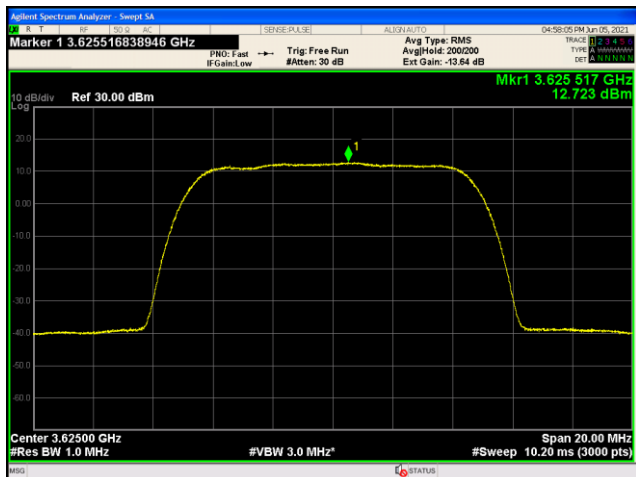

Middle channel

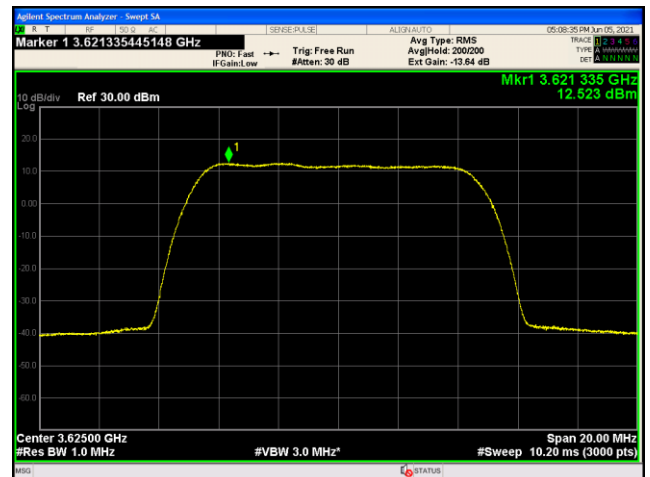

Middle channel

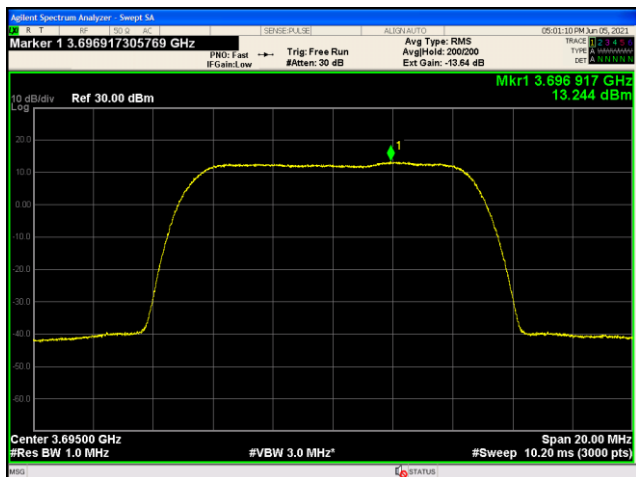

Highest channel

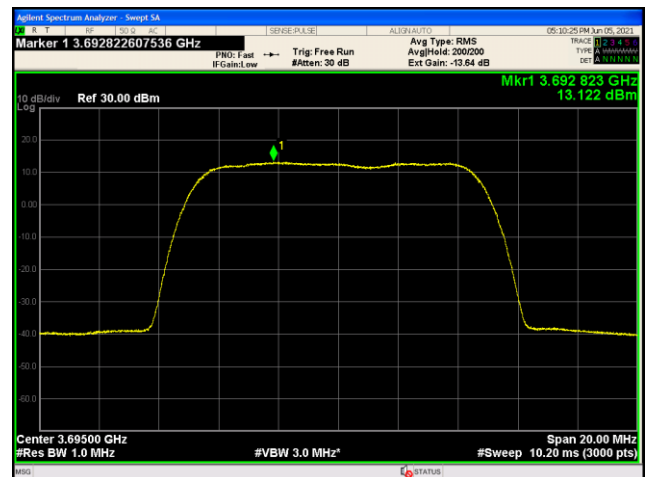

Highest channel

Bandwidth=10MHz – 64QAM

ANT 3

ANT 4

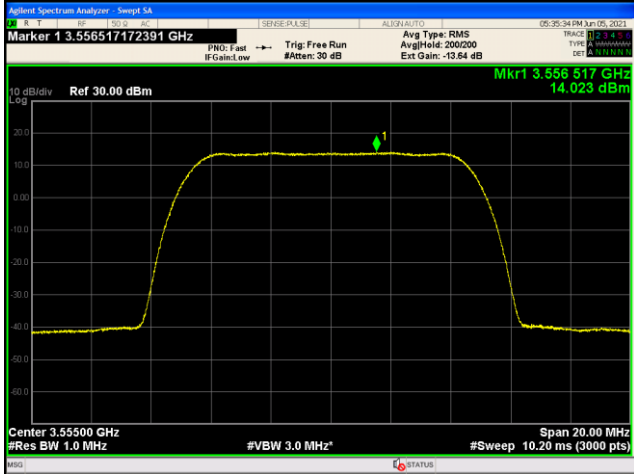

Lowest channel

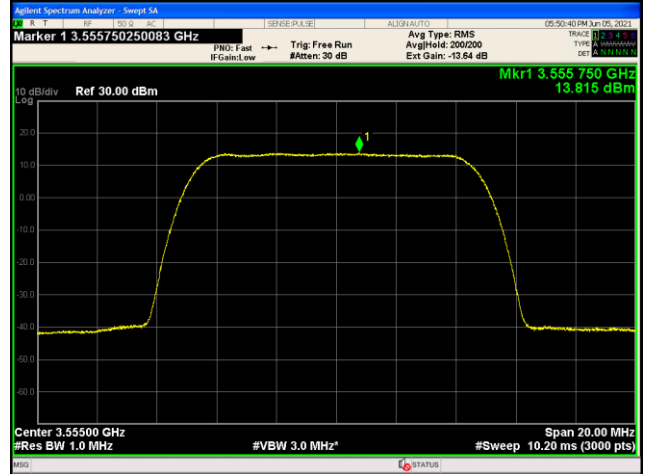

Lowest channel

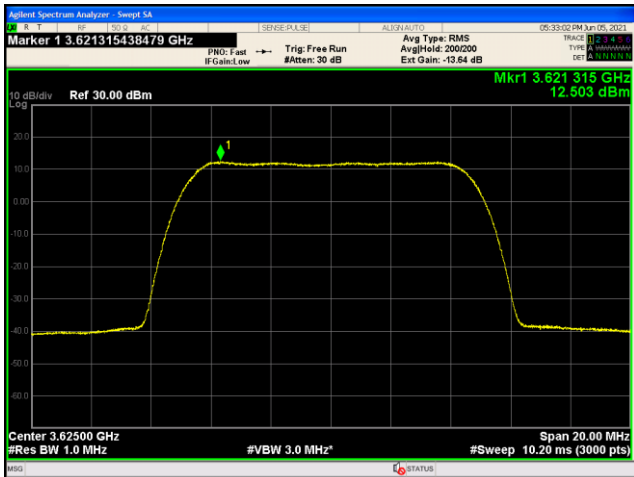

Middle channel

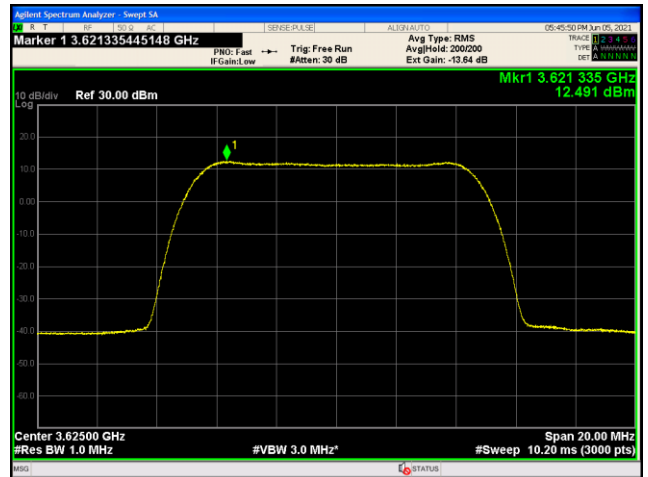

Middle channel

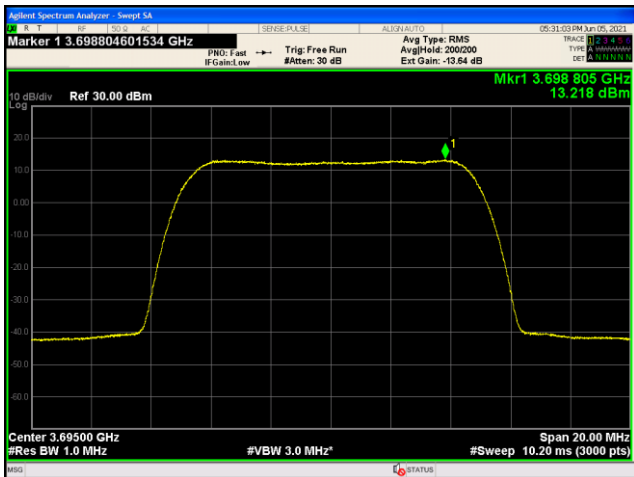

Highest channel

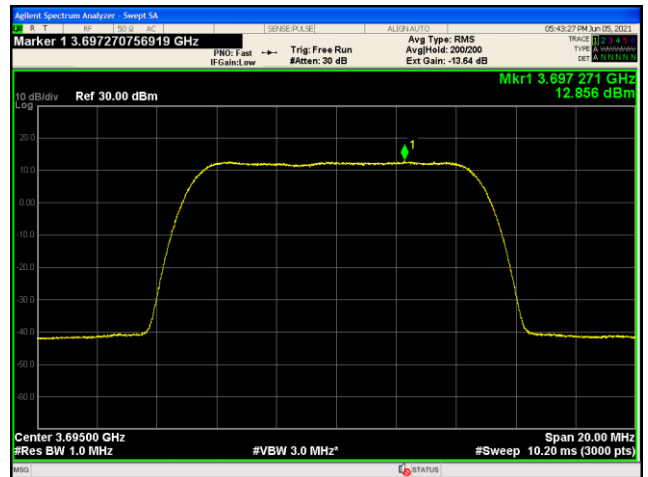

Highest channel

Bandwidth=20MHz – QPSK

ANT 1

ANT 2

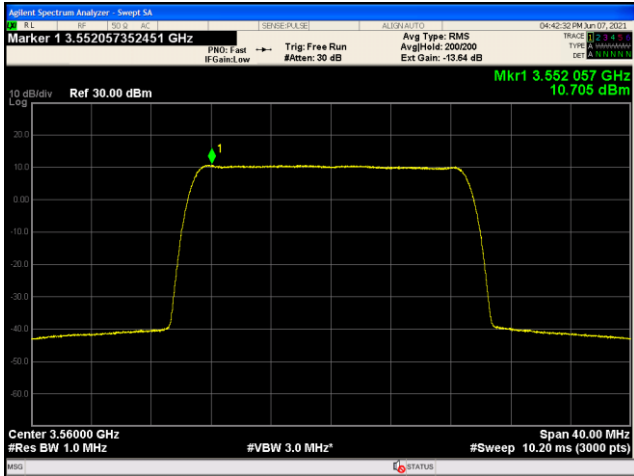

Lowest channel

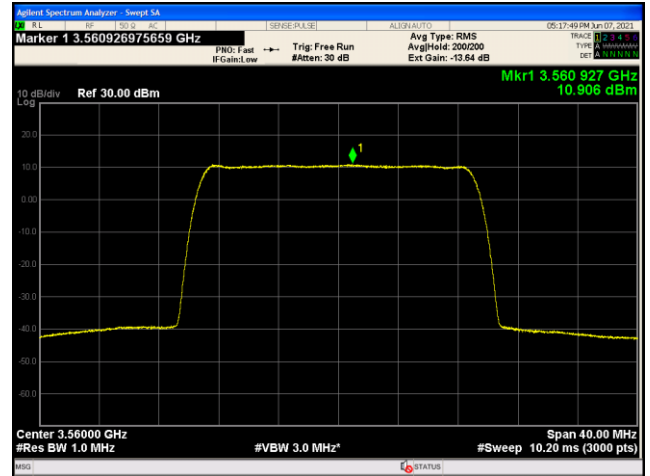

Lowest channel

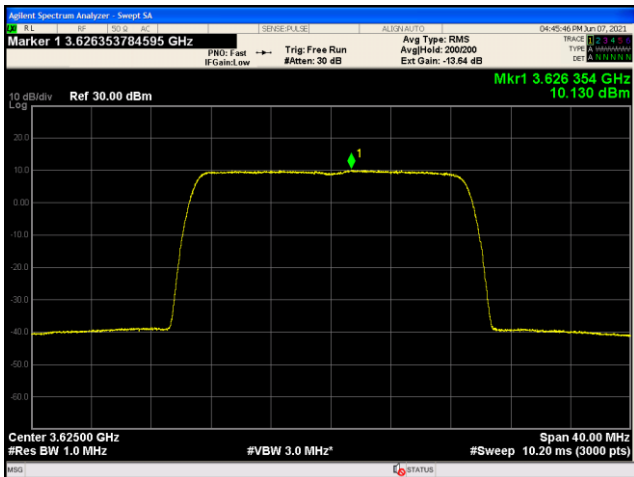

Middle channel

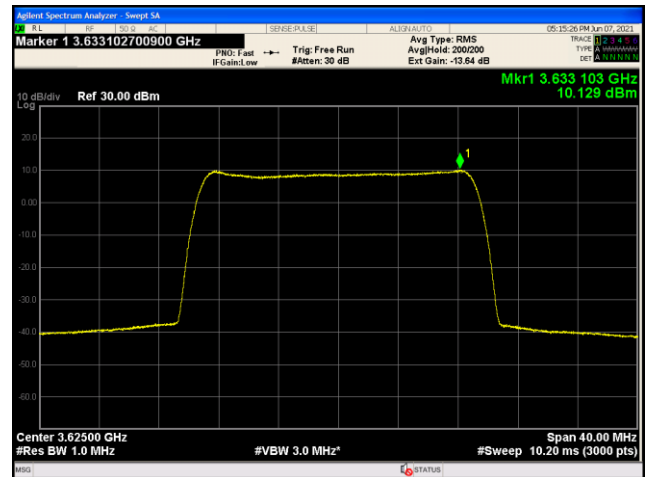

Middle channel

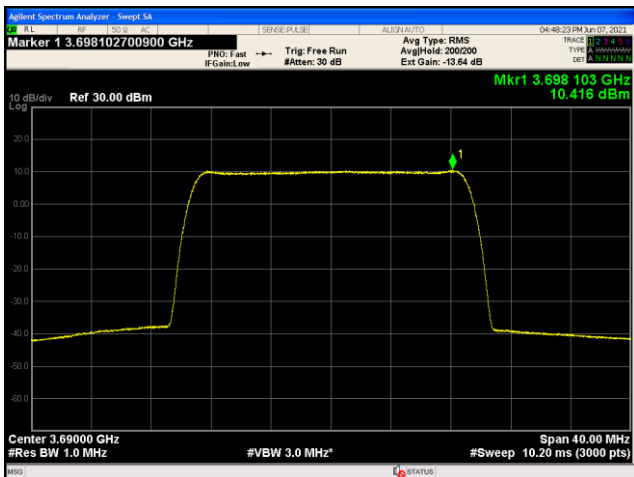

Highest channel

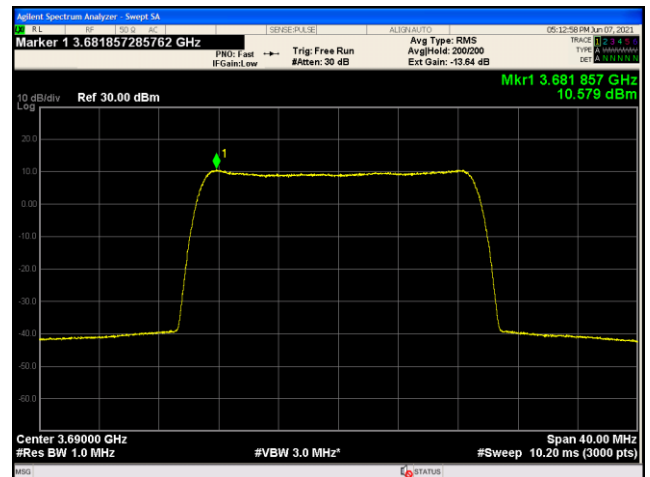

Highest channel

Bandwidth=20MHz – QPSK

ANT 3

ANT 4

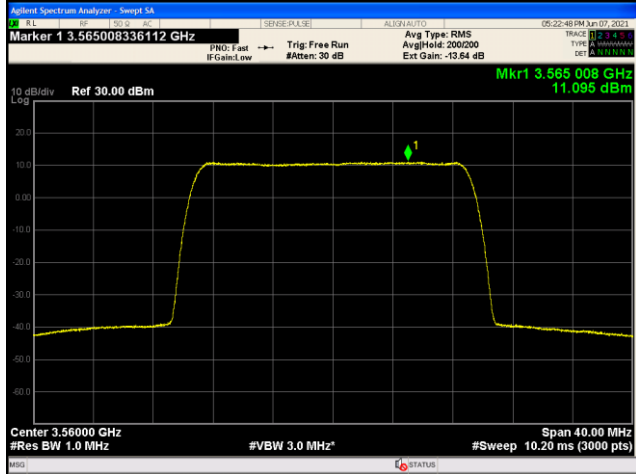

Lowest channel

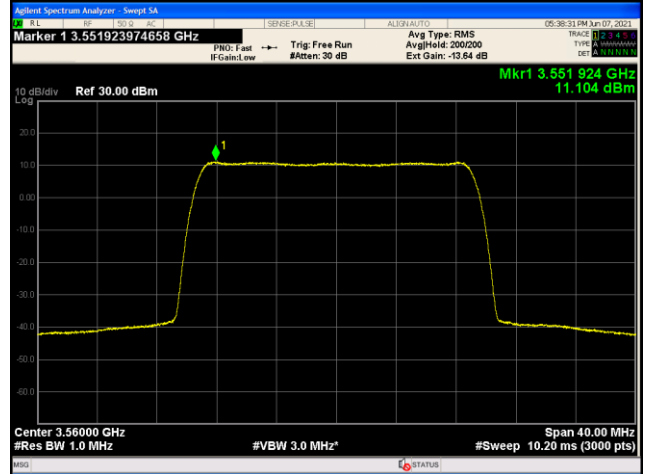

Lowest channel

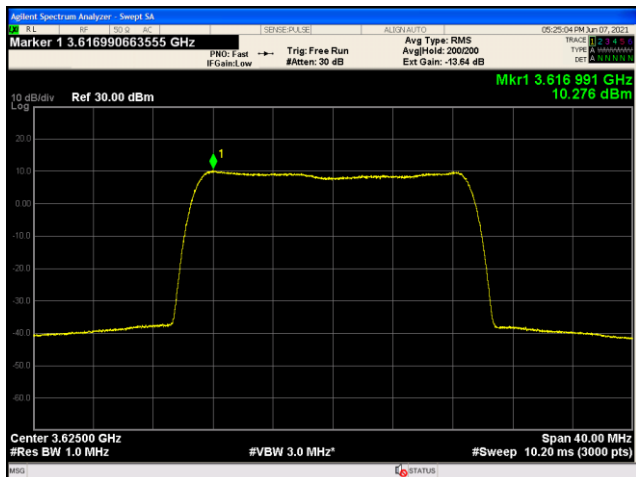

Middle channel

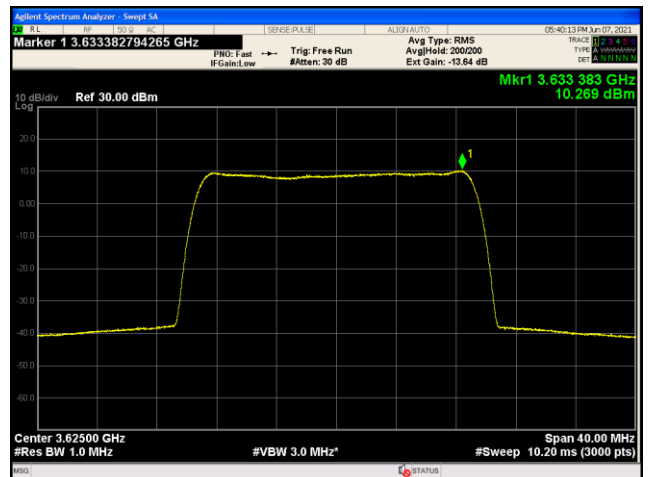

Middle channel

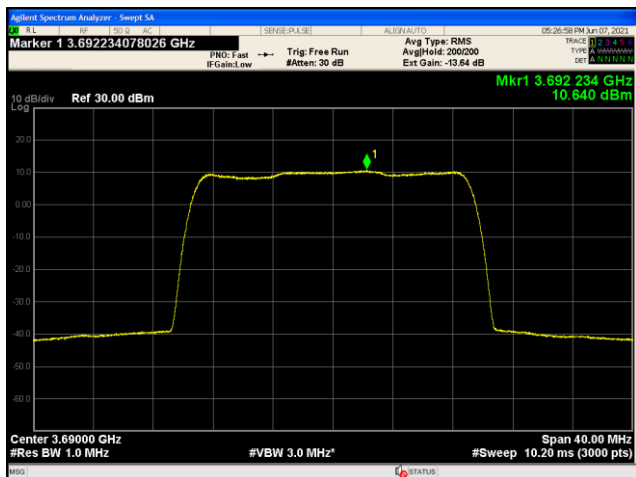

Highest channel

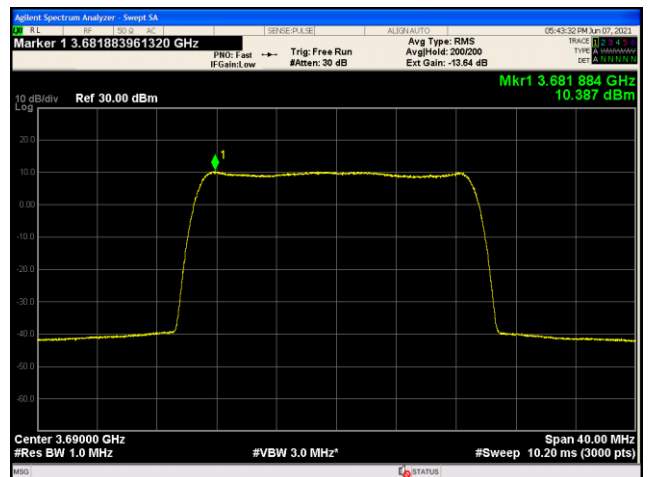

Highest channel

Bandwidth=20MHz – 64QAM

ANT 1

ANT 2

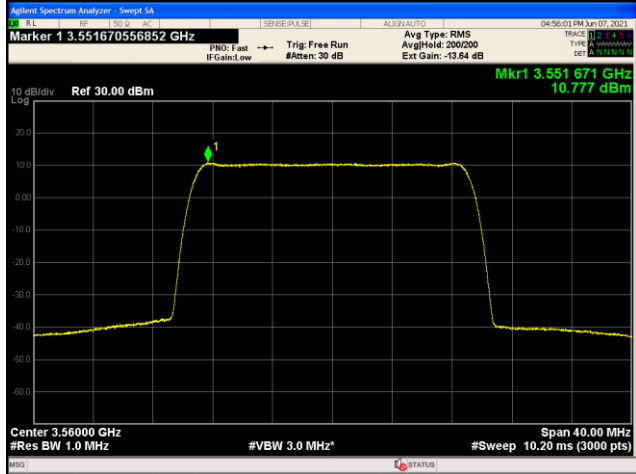

Lowest channel

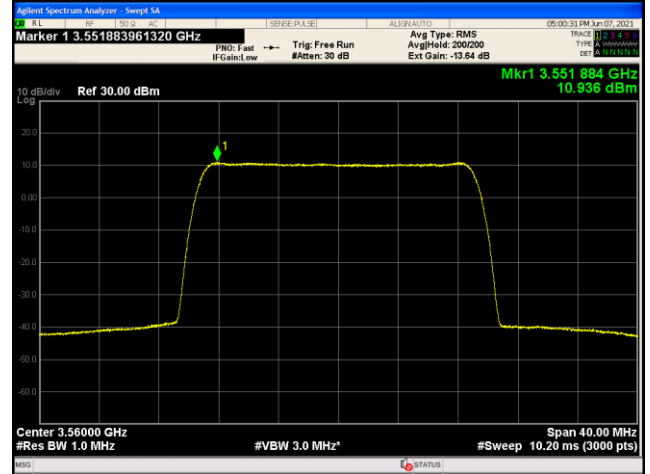

Lowest channel

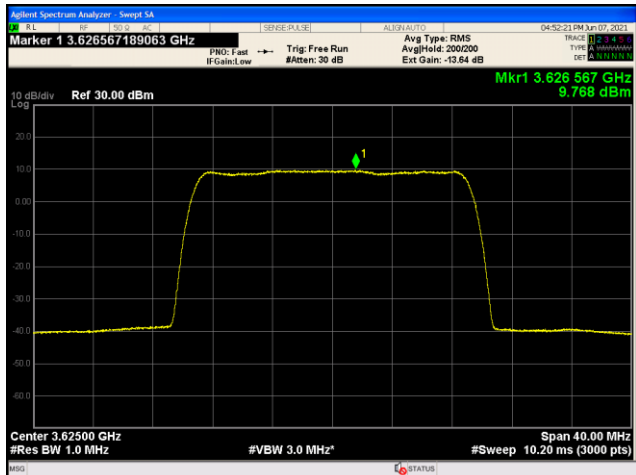

Middle channel

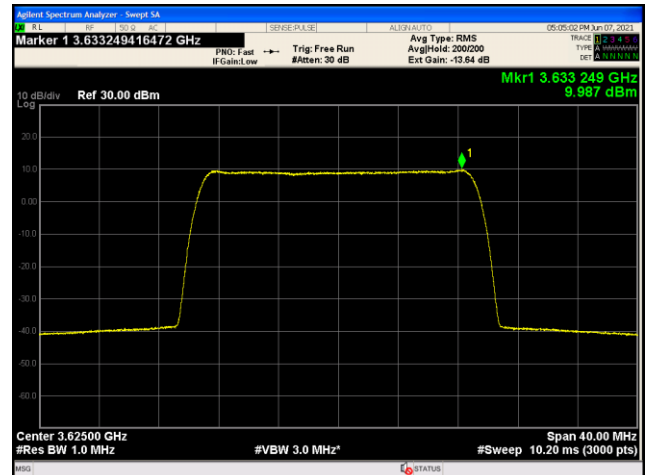

Middle channel

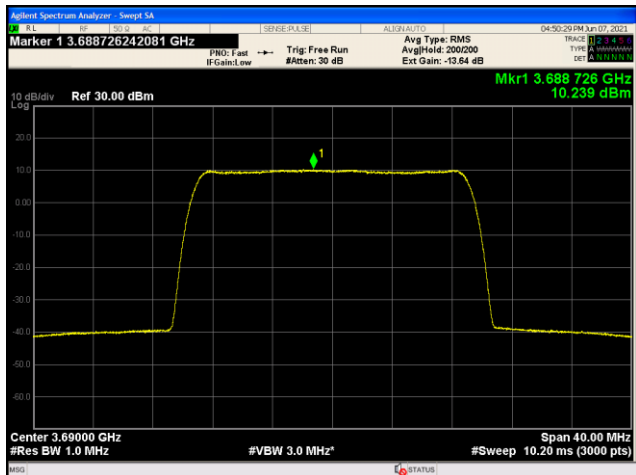

Highest channel

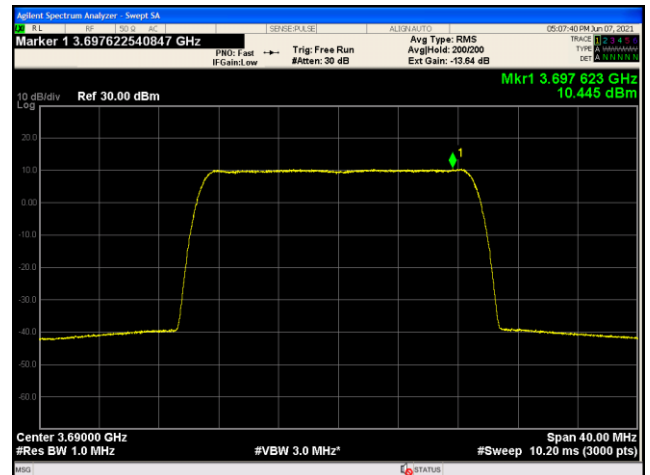

Highest channel

Bandwidth=20MHz – 64QAM

ANT 3

ANT 4

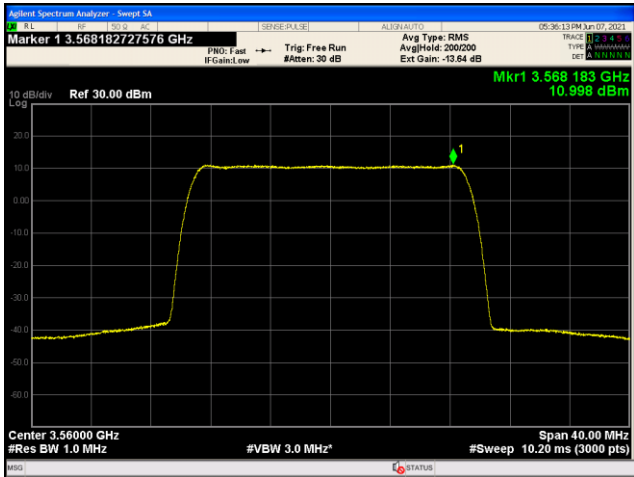

Lowest channel

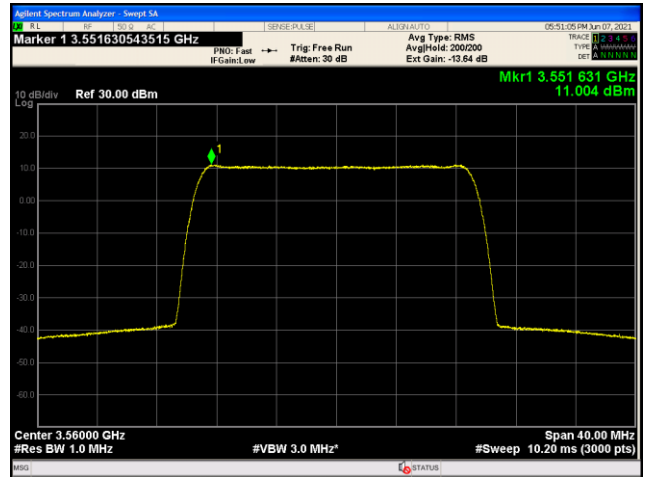

Lowest channel

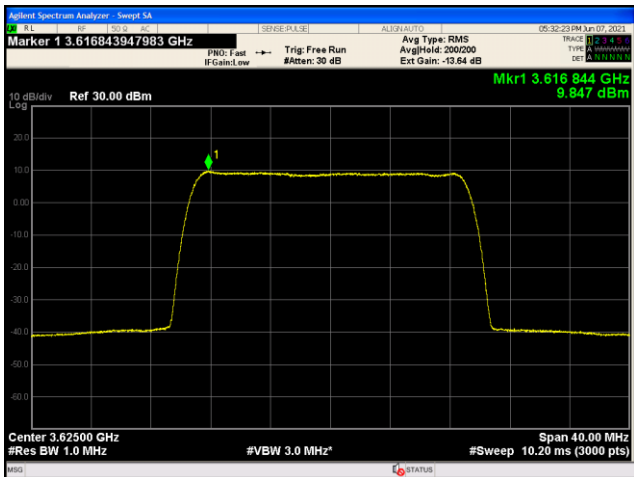

Middle channel

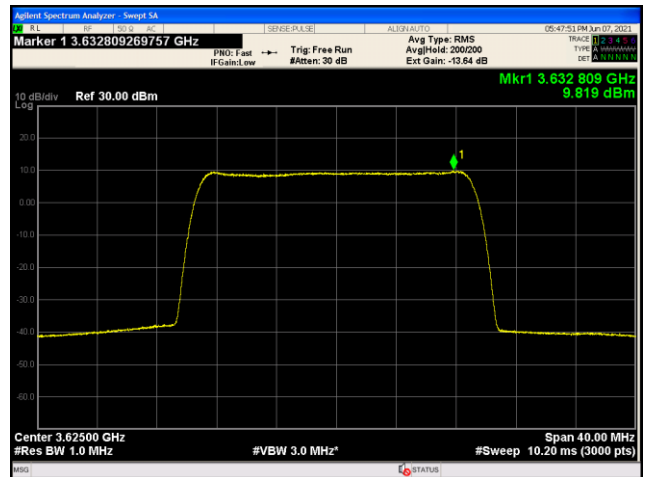

Middle channel

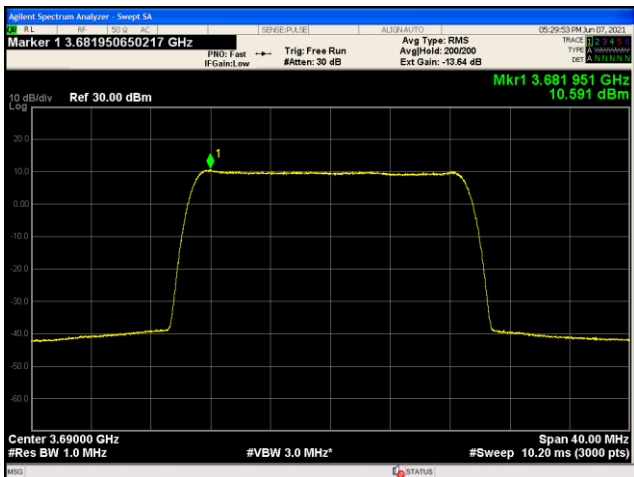

Highest channel

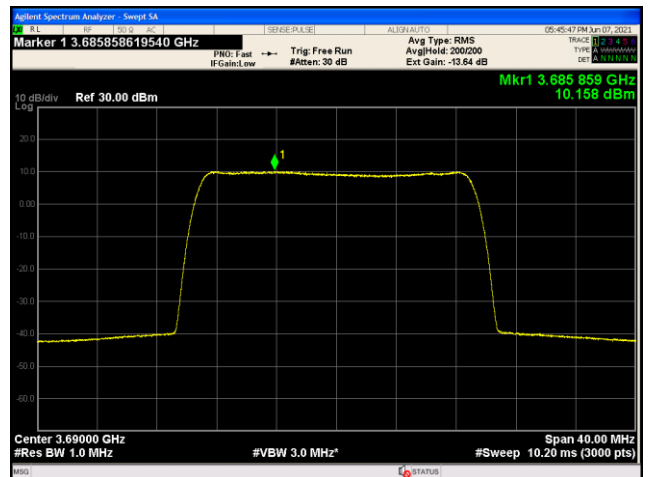

Highest channel

6.2 Peak-to-Average Power Ratio (PAPR)

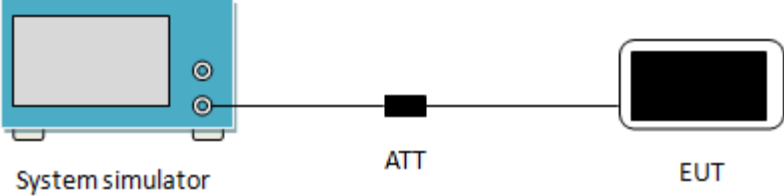
Test Requirement:	FCC part 96.41(g)
Limit:	The peak-to-average ratio (PAR) of the transmission may not exceed 13 dB.
Test setup:	 <p style="text-align: center;">System simulator ATT EUT</p>
Test Procedure:	<ol style="list-style-type: none"> 1 The RF output of the transceiver was connected to a spectrum analyzer through appropriate attenuation. 2 Set the CCDF option in spectrum analyzer, RBW= OBW, 3 Set the EUT working in highest power level, measured and recorded the 0.1% as PAPR level. 4 Repeat step 1~3 at other frequency and modulations.
Test Instruments:	Refer to section 5.8 for details
Test mode:	Refer to section 5.3 for details
Test results:	Passed (Pre-scan all modulation type (QPSK, 16-QAM, 64-QAM), and found the QPKS was the worst case. so only the worst case test data.)

Measurement Data:

Modulation	Frequency (MHz)	ANT. Port	PAPR(dB)	Limit(dB)	Result
10MHz – QPSK	3625.00	ANT 1	9.08	13.00	PASS
	3625.00	ANT 2	8.83		PASS
	3625.00	ANT 3	8.96		PASS
	3625.00	ANT 4	8.80		PASS
20MHz – QPSK	3625.00	ANT 1	8.70		PASS
	3625.00	ANT 2	8.99		PASS
	3625.00	ANT 3	8.73		PASS
	3625.00	ANT 4	8.76		PASS

Bandwidth=10MHz – QPSK

ANT 1

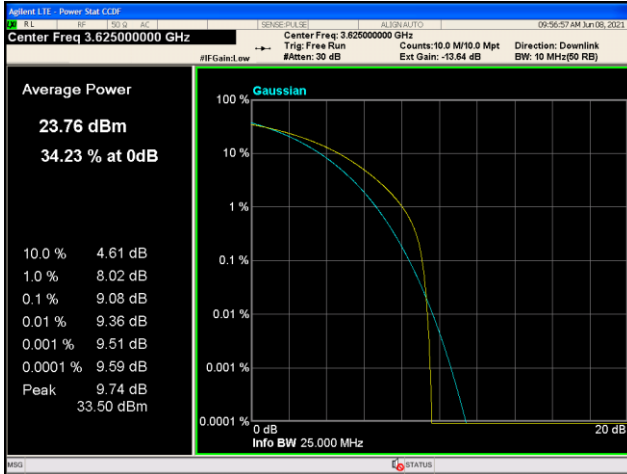

ANT 2

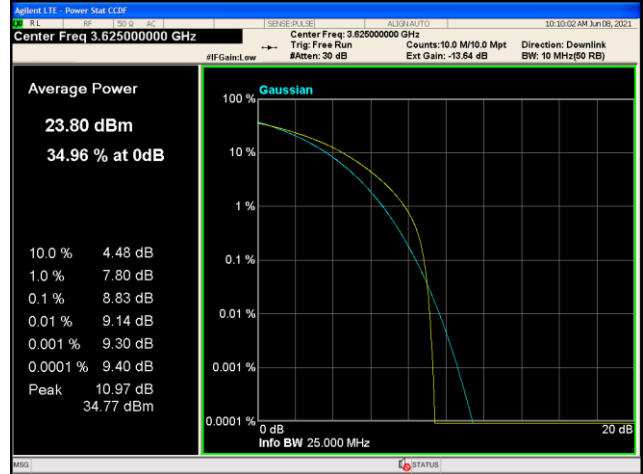

ANT 3

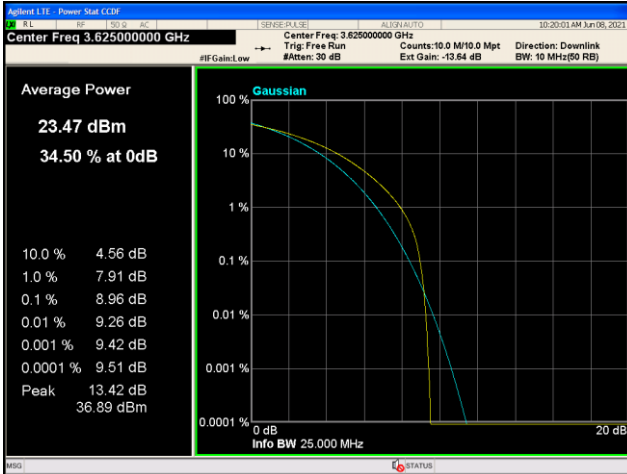

ANT 4

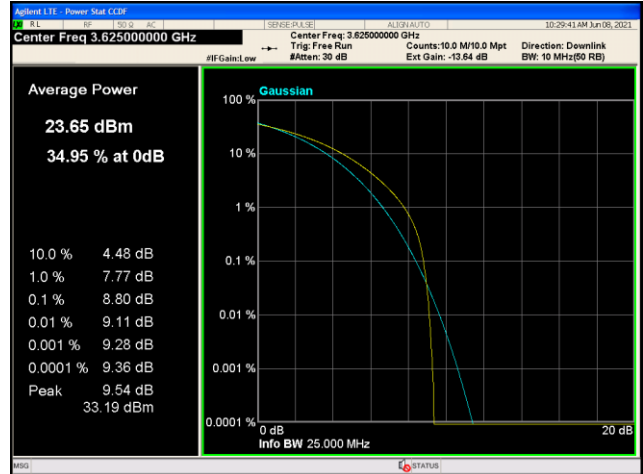

Bandwidth=20MHz – QPSK

ANT 1



ANT 2

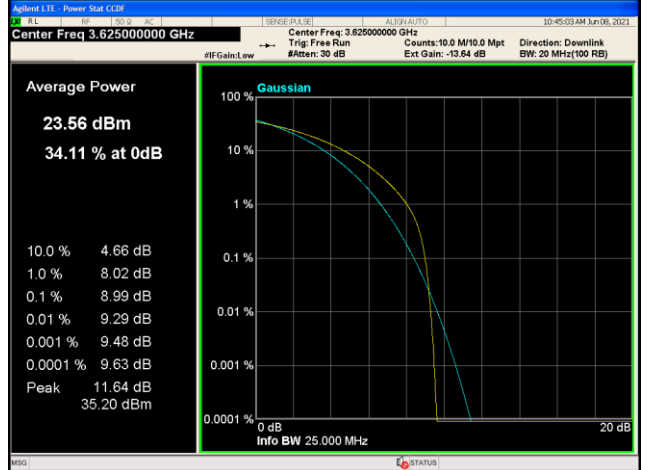

ANT 3



ANT 4

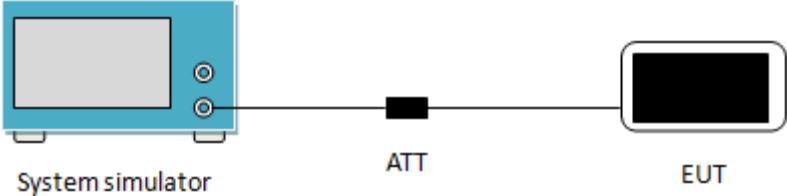

6.3 Occupy Bandwidth

Test Requirement:	FCC part 96.41(E)(3)
Test setup:	 <p>The diagram shows a blue 'System simulator' connected via a cable to a black 'ATT' (attenuator), which is then connected to a black 'EUT' (Equipment Under Test).</p>
Test Procedure:	<ol style="list-style-type: none"> 1. The EUT's output RF connector was connected with a short cable to the spectrum analyzer 2. The transmitter shall be operated at its maximum carrier power measured under normal test conditions. 3. The span of the analyzer shall be set to capture all products of the modulation process, including the emission skirts. 4. The resolution bandwidth (RBW) shall be in the range of 1% to 5% of the occupied bandwidth (OBW) and video bandwidth (VBW) shall be approximately 3x RBW.
Test Instruments:	Refer to section 5.10 for details
Test mode:	Refer to section 5.3 for details
Test results:	Passed

Measurement Data:

Test Channel	Bandwidth (MHz)	Modulation	Ant. Port	26dB Occupy bandwidth (MHz)	99% Occupy bandwidth (MHz)
Lowest	10	QPSK	ANT 1	9.283	8.903
			ANT 2	9.293	8.911
			ANT 3	9.293	8.909
			ANT 4	9.312	8.907
		64QAM	ANT 1	9.038	8.913
			ANT 2	9.309	8.913
			ANT 3	9.300	8.910
			ANT 4	9.305	8.917
Middle	10	QPSK	ANT 1	9.299	8.913
			ANT 2	9.286	8.912
			ANT 3	9.322	8.904
			ANT 4	9.320	8.912
		64QAM	ANT 1	9.283	8.904
			ANT 2	9.295	8.904
			ANT 3	9.319	8.906
			ANT 4	9.306	8.909
Highest	10	QPSK	ANT 1	9.291	8.909
			ANT 2	9.284	8.919
			ANT 3	9.296	8.911
			ANT 4	9.293	8.908
		64QAM	ANT 1	9.292	8.900
			ANT 2	9.297	8.898
			ANT 3	9.298	8.911
			ANT 4	9.298	8.917
Lowest	20	QPSK	ANT 1	18.500	17.827
			ANT 2	18.490	17.820
			ANT 3	18.510	17.807
			ANT 4	18.500	17.798
		64QAM	ANT 1	18.500	17.804
			ANT 2	18.490	17.803
			ANT 3	18.500	17.812
			ANT 4	18.500	17.794
Middle	20	QPSK	ANT 1	18.500	17.813
			ANT 2	18.500	17.818
			ANT 3	18.490	17.828
			ANT 4	18.520	17.812
		64QAM	ANT 1	18.510	17.799
			ANT 2	18.500	17.805
			ANT 3	18.490	17.806
			ANT 4	18.500	17.813
Highest	20	QPSK	ANT 1	18.510	17.809
			ANT 2	18.500	17.803
			ANT 3	18.500	17.817
			ANT 4	18.500	17.821
		64QAM	ANT 1	18.500	17.811
			ANT 2	18.490	17.804
			ANT 3	18.510	17.817
			ANT 4	18.500	17.819

Test plot as follows:

LTE Band 48
BW: 10MHz, QPSK

ANT 1

ANT 2

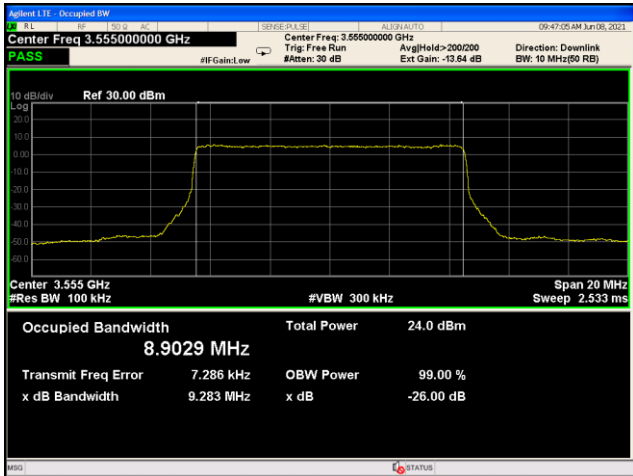

Lowest channel

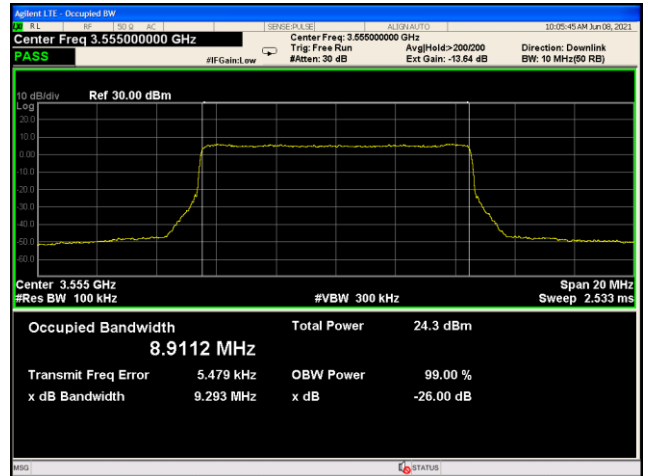

Lowest channel

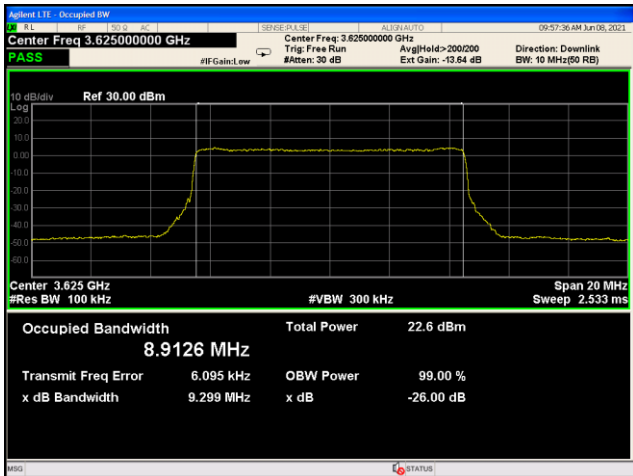

Middle channel

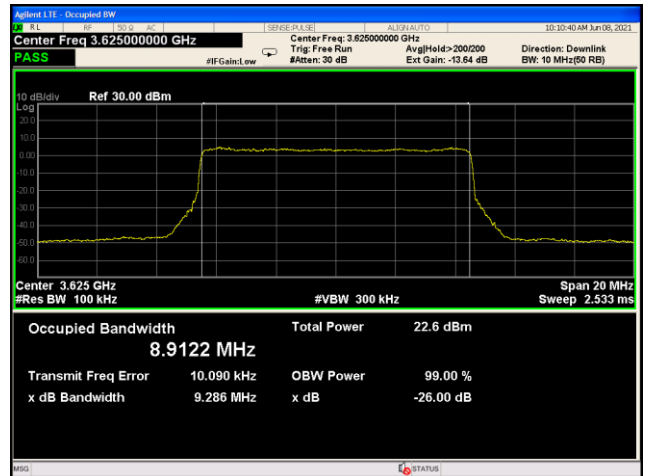

Middle channel

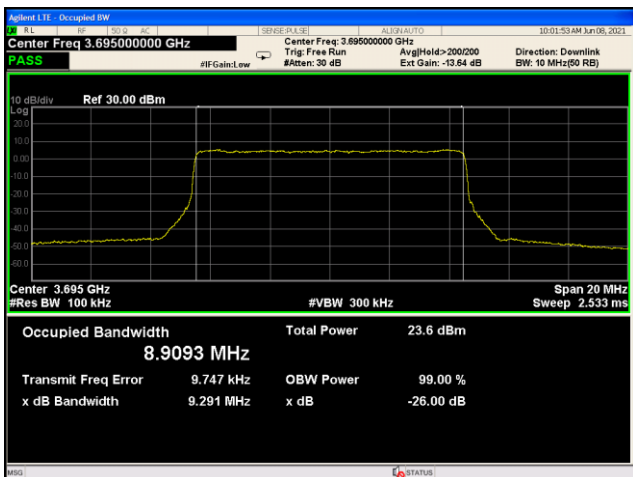

Highest channel

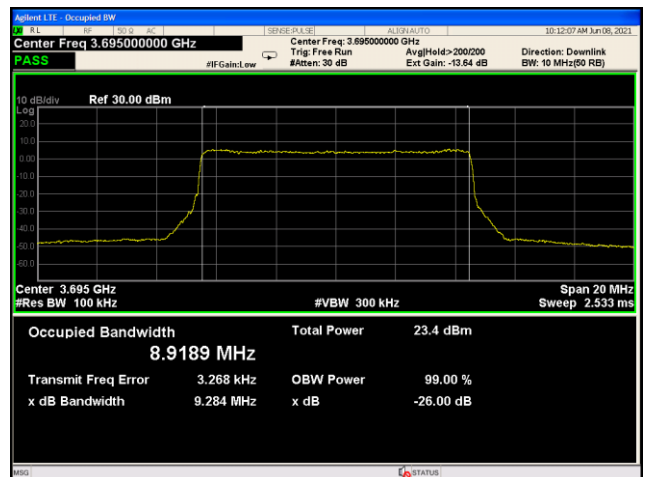

Highest channel

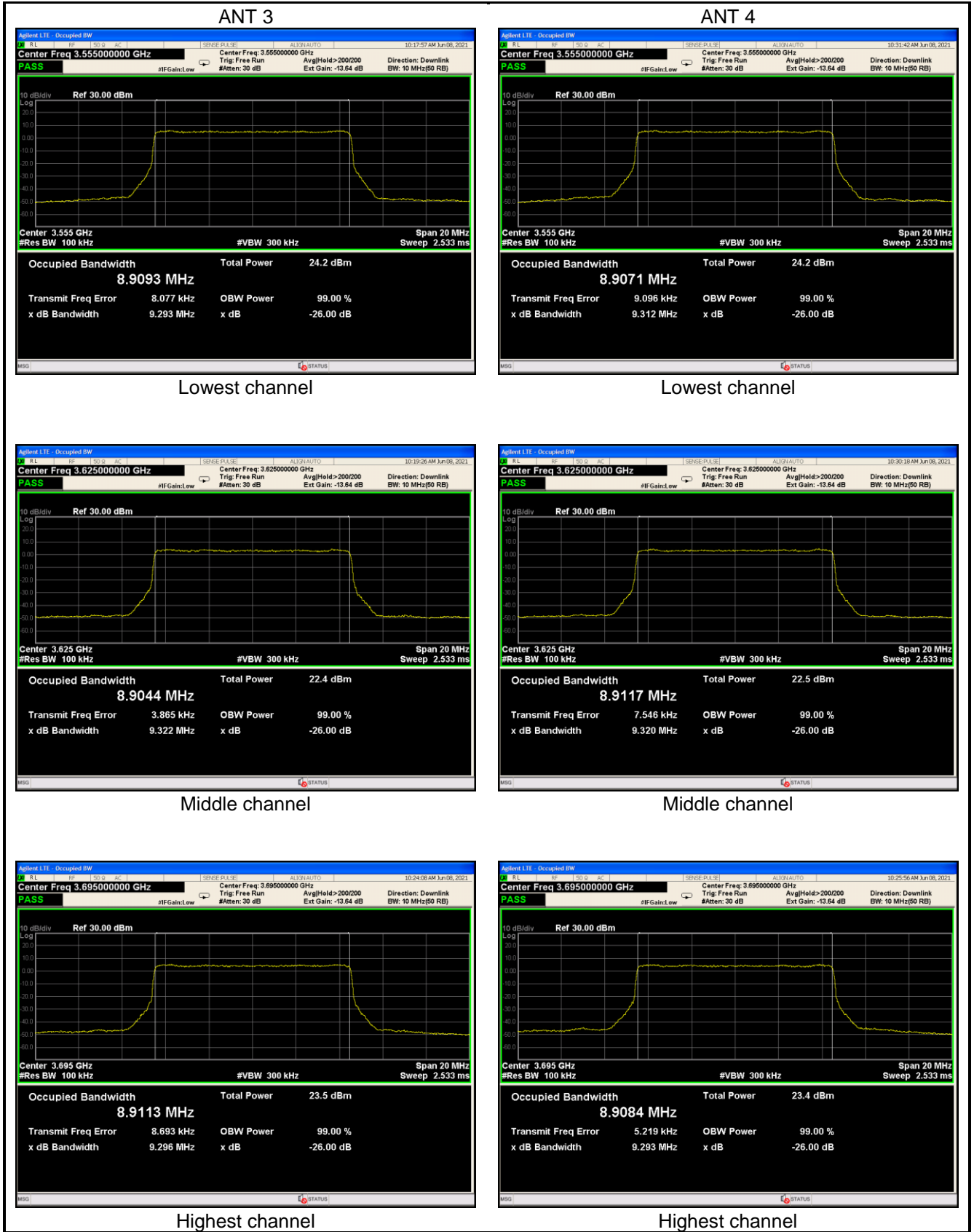

LTE Band 48
BW: 10MHz, 64QAM

ANT 1

ANT 2

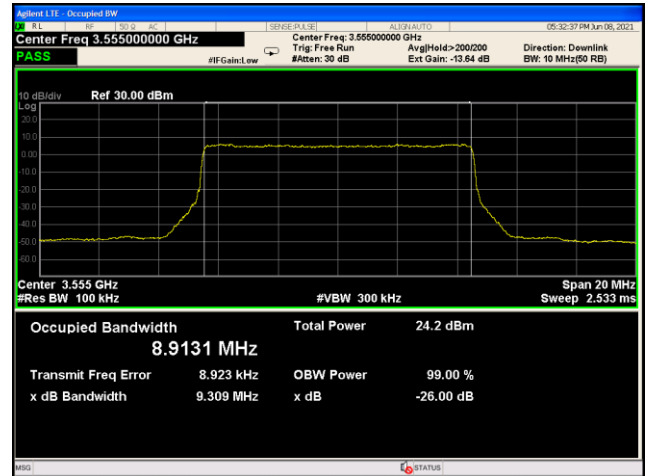
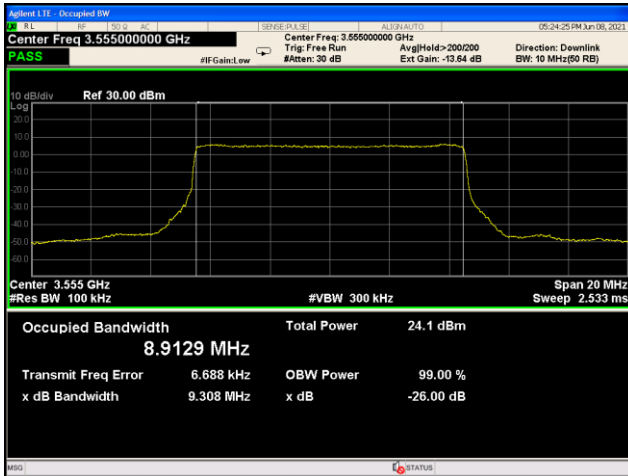

Lowest channel

Lowest channel

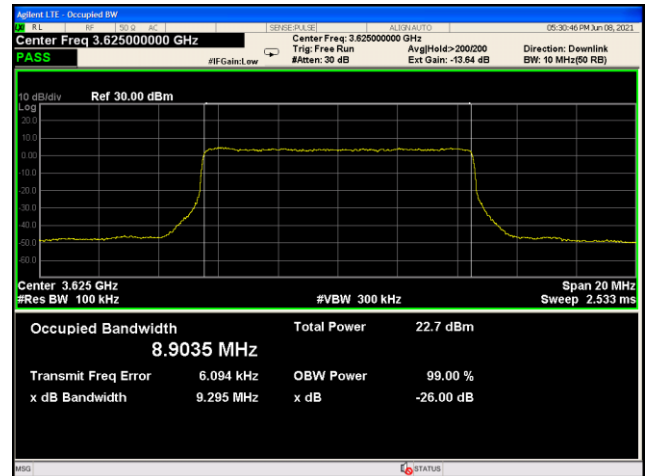
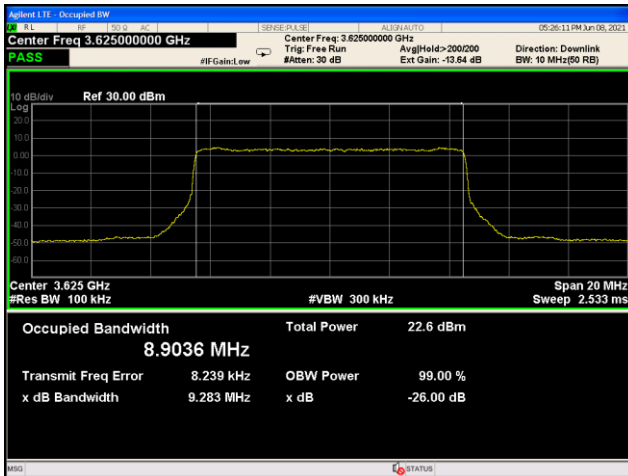

Middle channel

Middle channel

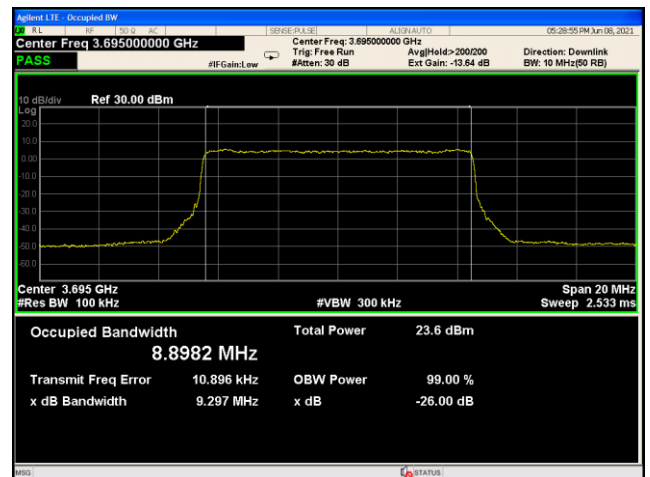
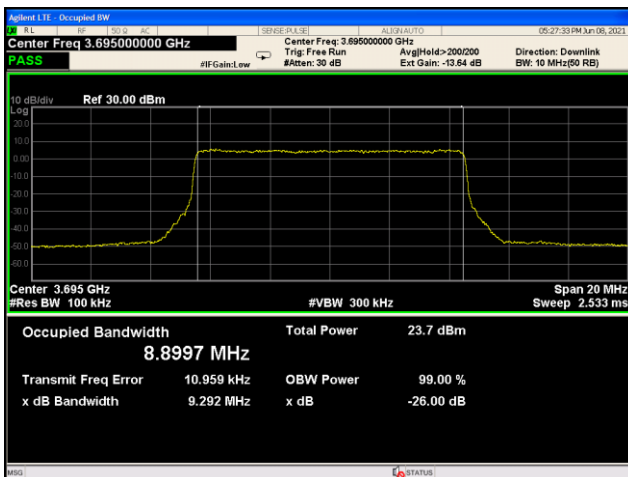

Highest channel

Highest channel

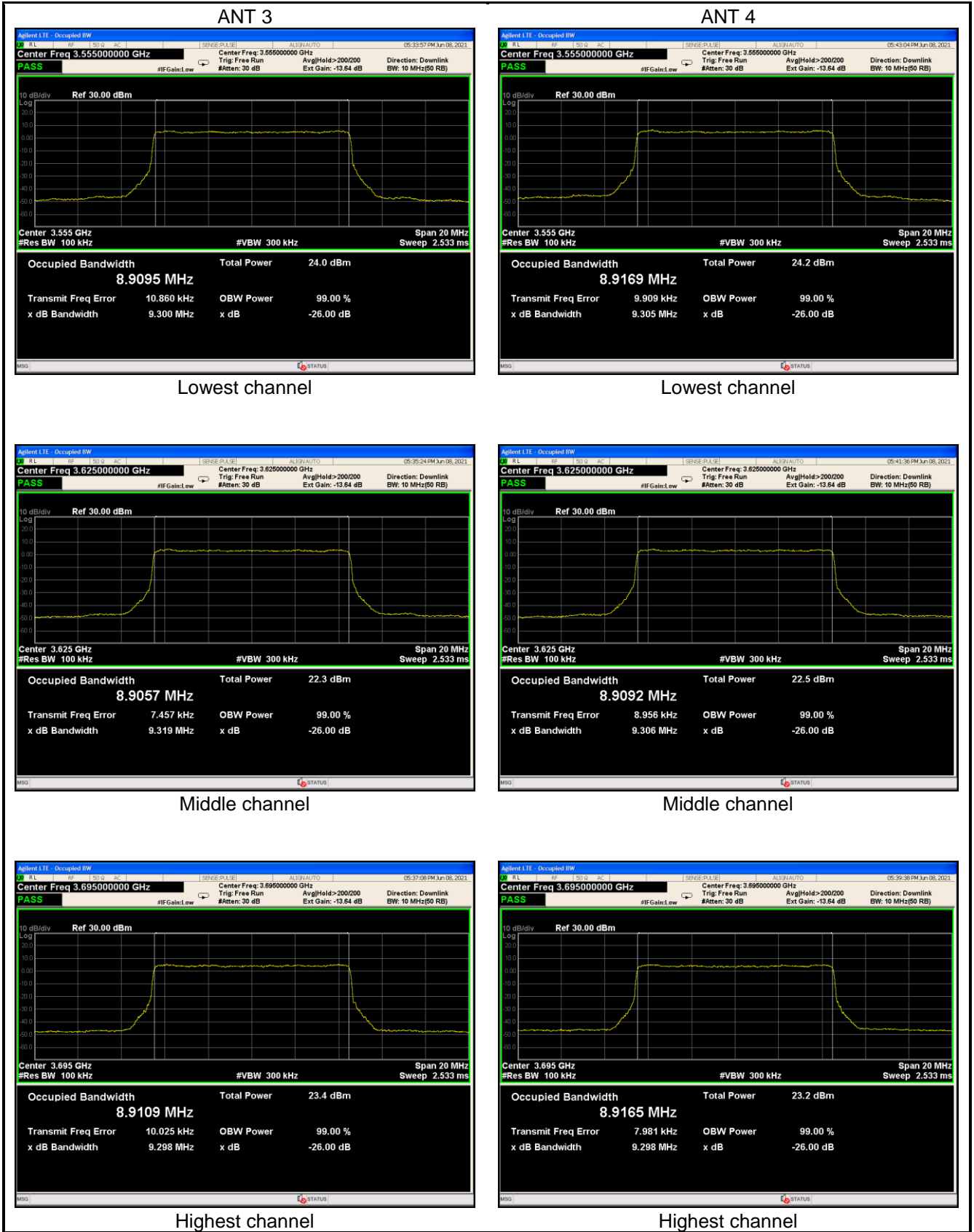

LTE Band 48:
BW: 20MHz QPSK

ANT 1

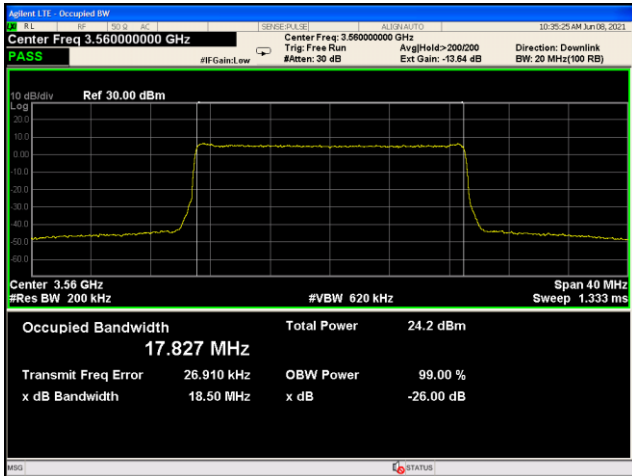

Lowest channel

ANT 2

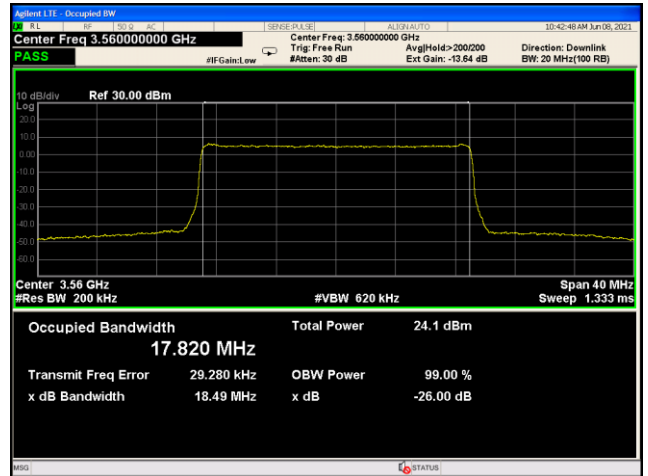

Lowest channel

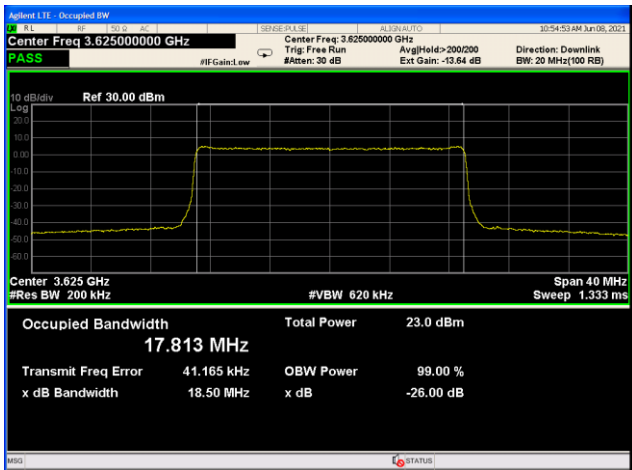

Middle channel

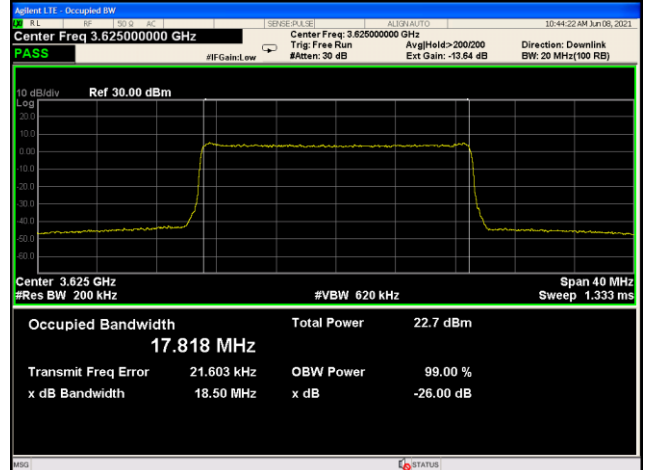

Middle channel

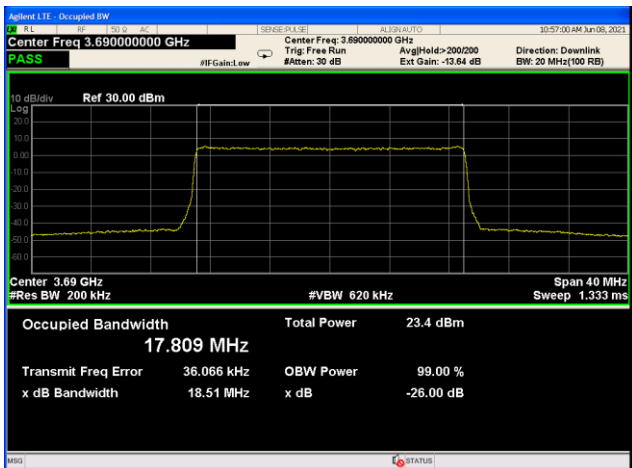

Highest channel

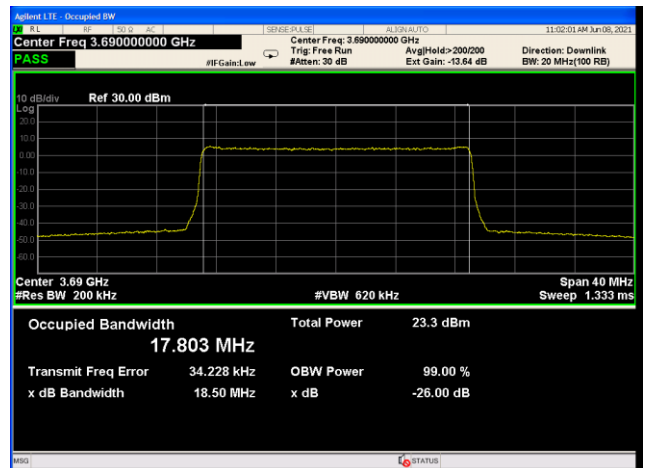

Highest channel

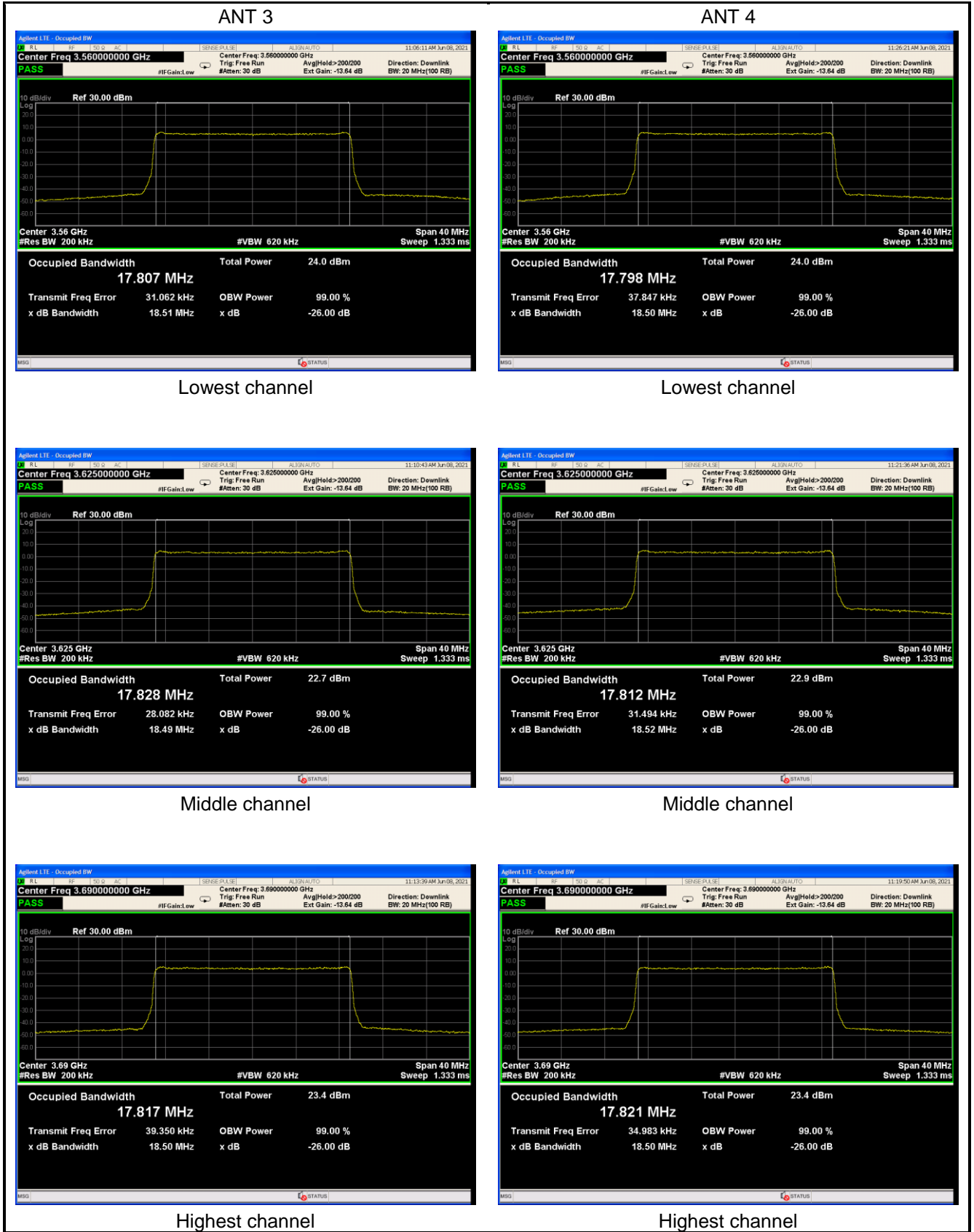

LTE Band 48
BW: 20MHz, 64QAM

ANT 1

ANT 2

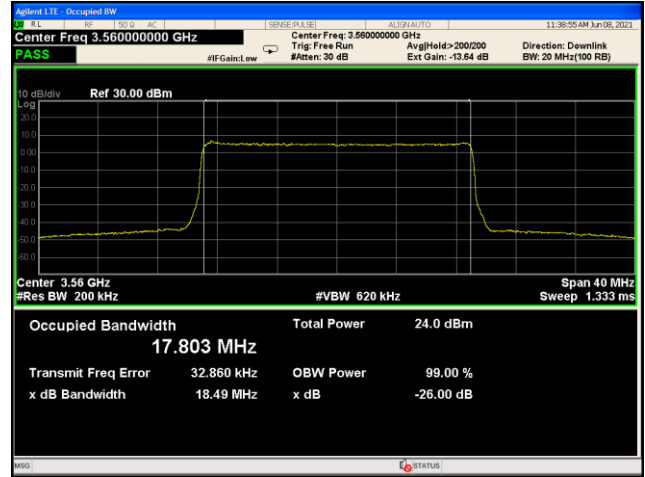
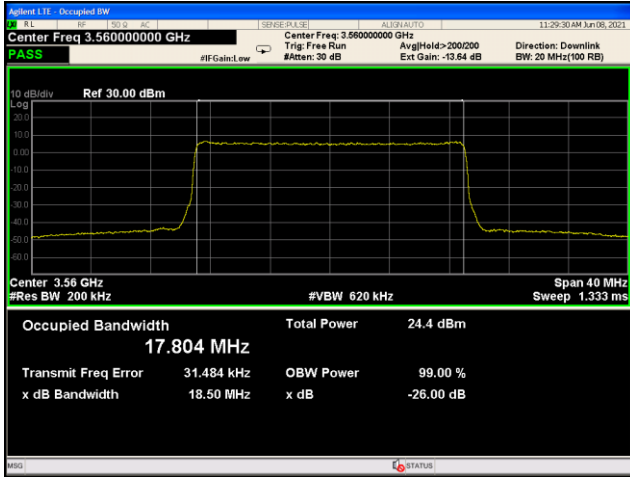

Lowest channel

Lowest channel

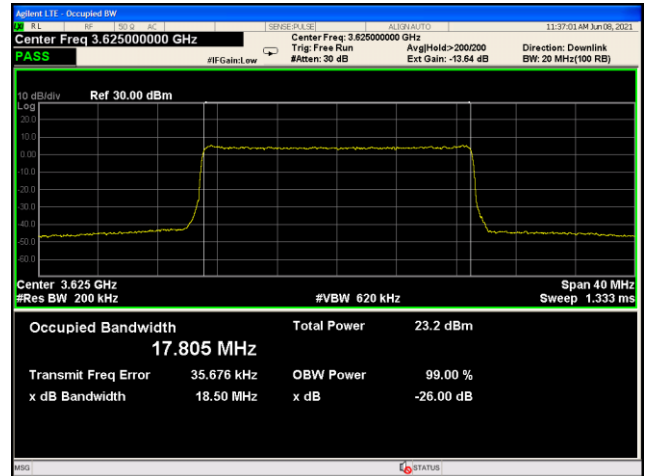
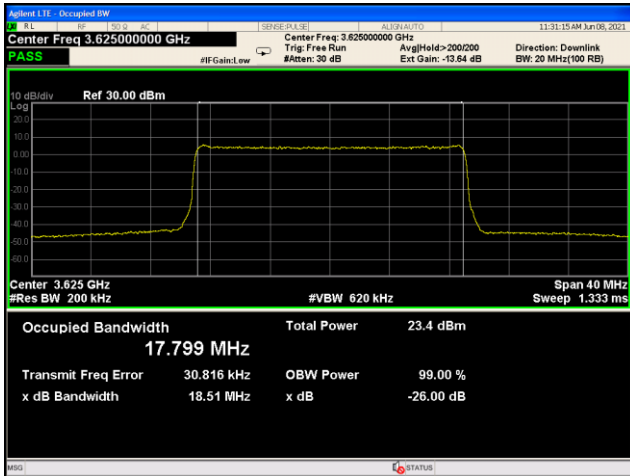

Middle channel

Middle channel

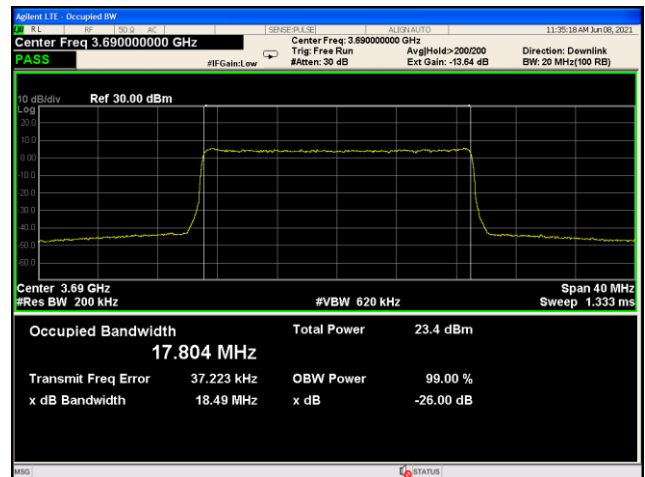
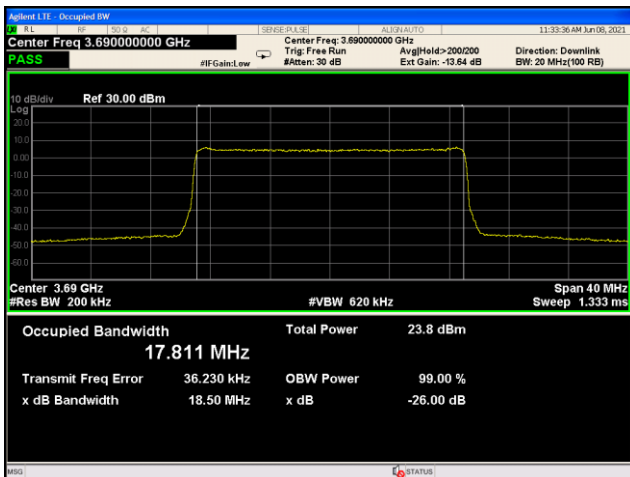

Highest channel

Highest channel

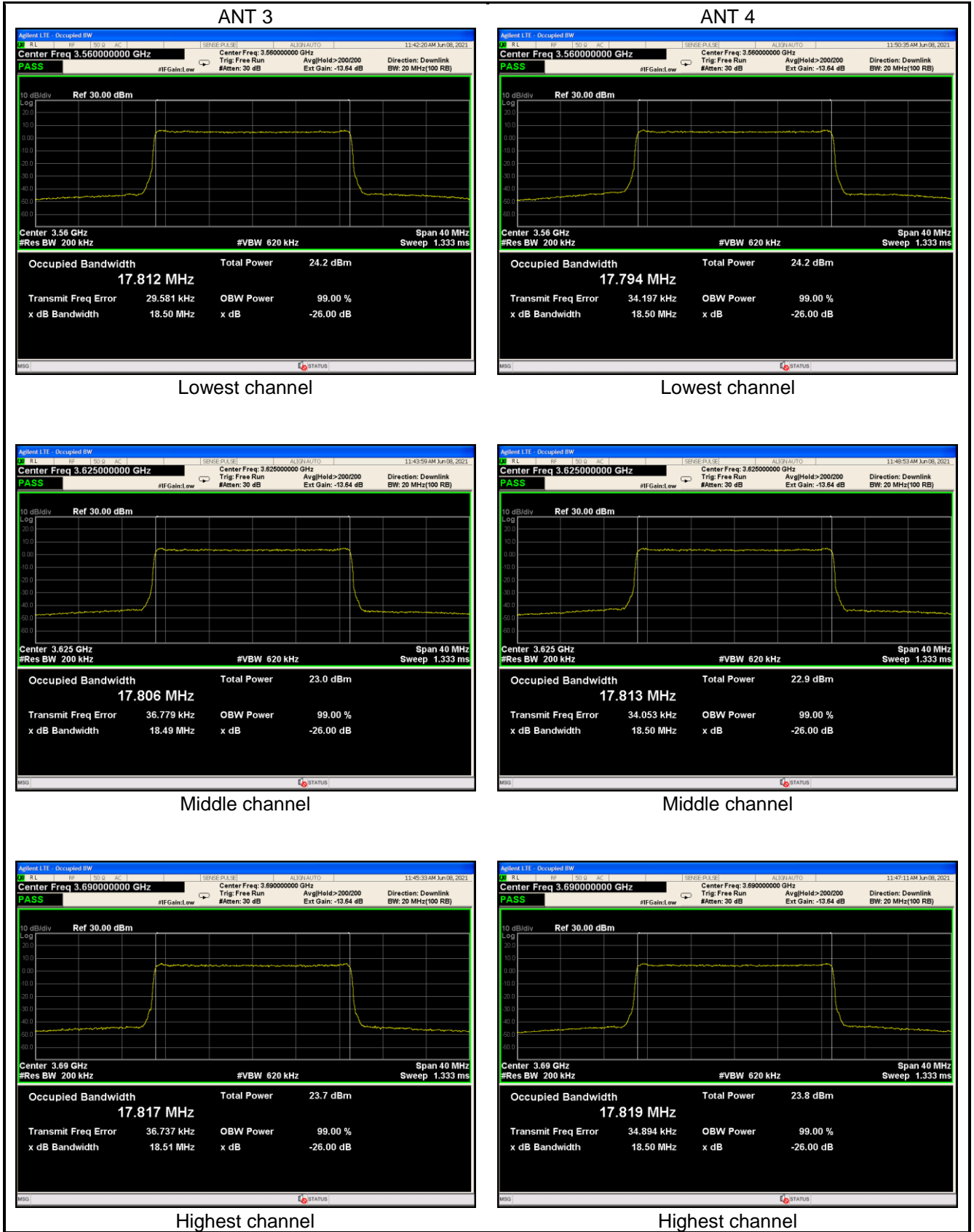

6.4 Emission Mask

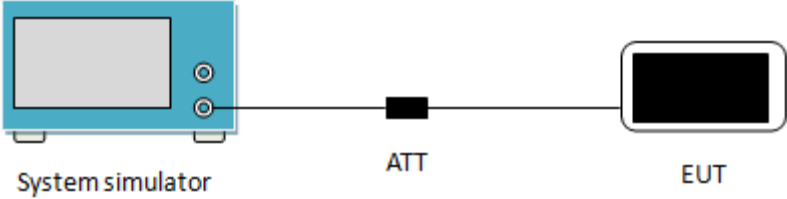
Test Requirement:	FCC part 96.41(e)(1)(2)
Limit:	-13 dBm/Mhz at frequencies within 0-10MHz of channel edge -25 dBm/MHz at frequencies greater than 10MHz above and below channel edge -40 dBm/MHz at frequencies below 3530 MHz and above 3720 MHz
Test setup:	 <p>The diagram shows a test setup where a blue 'System simulator' is connected via a cable to a black 'ATT' (attenuator), which is then connected to a black 'EUT' (Equipment Under Test).</p>
Test Procedure:	<ol style="list-style-type: none"> 1. The RF output of the transceiver was connected to a spectrum analyzer through appropriate attenuation. Measurements must be performed for low, mid, and high channels. 2. RBW=1% of fundamental for measurements within 1 MHz immediately outside the authorized channel; and 1 MHz for beyond 1 MHz outside the authorized channel. (eg.For 5MHz, RBW=51KHz within 1 MHz immediately outside the authorized channel) 3. Trace average at least 100 traces
Test Instruments:	Refer to section 5.10 for details
Test mode:	Refer to section 5.3 for details
Test results:	PASS (Pre-scan all modulation type (QPSK, 16-QAM, 64-QAM), and found the QPKS was the worst case. so only the worst case test data.)