



pBS11004 Base Station Installation Guide

01

All rights reserved © Baicells Technologies Co., Ltd.

About This Document

This document is a guidance of pBS11004 hardware installation for installation personnel, which includes the preparation of installation tools and supporting materials before installation, the demands of installation environment, installation of base station, connection of cable and power on.

Accomplish the installation of the device according to this guide, the installation personnel can avoid potential damage to the device during the installation procedure, which makes sure the subsequent good running of the device.

Copyright Notice

Baicells copyrights this specification. No part of this specification may be reproduced in any form or means, without the prior written consent of Baicells.

Disclaimer

This specification is preliminary and is subject to change at any time without notice. Baicells assumes no responsibility for any errors contained herein. For more information, please consult our technical engineers.

Disposal of Electronic and Electrical Waste



Pursuant to the WEEE EU Directive, electronic and electrical waste must not be disposed of with unsorted waste. Please contact your local recycling authority for disposal of this product.

Revision Record

Date	Version	Description
20 July, 2017	01	Initial Released.

Contact Us

Baicells Technologies Co., Ltd.North America

Address: 555 Republic Drive, Suite 200 Plano, TX 75074

E-mail: support_na@baicells.com

Phone: +1-972-800-1157

Website: <http://www.baicells.com/>

Contents

1. Product Overview	1
1.1 Introduction	1
1.2 Features.....	1
1.3 Appearance	2
1.4 Technical Specification	3
1.4.1 Hardware Specification.....	3
1.4.2 Software Specification	4
1.4.3 Environment Specification.....	4
2. Out-of-Box Audit	5
3. Installation Preparation	6
3.1 Support Materials.....	6
3.2 Installation Tools	6
3.3 Installation Environment.....	7
3.3.1 Locational Requirements.....	7
3.3.2 Environmental Requirements.....	7
3.4 Personnel Requirements	7
3.5 Grounding Protection.....	7
3.6 Regulatory Compliance	8
4. Base Station Installation.....	10
4.1 Install on Pole	10
4.2 Install on Wall.....	11
4.3 Connect Cable	11
4.3.1 Connect Ethernet Cable.....	11
4.3.2 Connect Ground Cable.....	12
5. Power On	13

1. Product Overview

1.1 Introduction

Baicells pBS11004 is a high performance outdoor 2496MHz-2690MHz micro base station based on TD-LTE technology, which is developed by Baicells. The pBS11004 supports wired backhaul connections to backbone networks, and provides LTE access to user terminals, implemented voice and data service transmissions.

The pBS11004 makes use of the current transmission resources to reduce the operator's investment, implement the low-cost construction of LTE networks and enhance indoor coverage, thereby providing high-speed broadband access for users in assembly occupations.

The pBS11004 can be widely used by telecom operators, broadband operators, enterprises, and so on.

1.2 Features

- Adopt the integration design of baseband and RF, flexible to deploy.
- Based on 3GPP international standard TD-LTE technology; provide high speed data service; support a maximum transfer rate of DL: 110Mbit/s, UL: 20Mbit/s.
- Support flexible uplink and downlink time slot ratio: 1(2:2), 2(1:3), and high speed data transmission.
- Support 10MHz/20MHz operation bandwidth.
- Support internal antenna and GPS.
- Support PoE+ power supply, only one Ethernet cable realize data transmission and power supply.
- Security services to provide timely protection against potential security risks and illegal intrusion.
- Support simple and convenient local and remote web management.
- Integration as required, easy to installation and deployment, accurate coverage and improved network capacity.
- Support network management functions, which includes the management, monitoring and maintenance.

1.3 Appearance

The pBS11004 base station appearance is shown in Figure 1-1.

Figure 1-1 pBS11004 Appearance



The pBS11004 interfaces and indicators are shown in Figure 1-2.

Figure 1-2 pBS11004 Interfaces and Indicators



The pBS11004 interfaces are described in Table 1-1.

Table 1-1 pBS11004 Interface Description

Interface Name	Description
ETH/POE+	RJ-45 interface, used for data configuration or data backhaul, and PoE+ power supply.

The pBS11004 interface indicators are described in Table 1-2.

Table 1-2 pBS11004 Interface Indicators

Identity	Color	Status	Description
PWR	Green	Steady On	Power On
		OFF	No Power Supply
ACT	Green	Steady On	The cell is activated.
		OFF	The cell is not activateated.
RUN	Green	Fast flash: 0.125s on,0.125s off	The board is loading.
		Slow flash: 1s on,1s off	The board is normal.
		OFF	No power input or board fault
ALM	Red	Steady On	Hardware alarm, e.g. VSWR alarm
		OFF	No alarm

1.4 Technical Specification

1.4.1 Hardware Specification

Item	Description
LTE Mode	LTE TDD
LTE Frequency	2496MHz-2690MHz
Channel Bandwidth	10 MHz, 20 MHz
Output Power	24 dBm \pm 2dB
Receiving sensitivity	-101 dBm
Synchronization Mode	GPS synchronization
Backhaul Mode	RJ-45 Ethernet backhaul
MIMO	2*2MIMO
Dimension	248mm (L) * 248mm (W) * 80mm (H)
Installation Method	Pole mounted, wall mounted
Antenna	Internal high gain antenna(9 dBi)
Overall Power	< 20 W
Weight	About 2.0kg

Note:

The test method of receiving sensitivity is proposed by the 3GPP TS 36.104, which is based on 5MHz bandwidth, FRC A1-3 in Annex A.1 (QPSK, R=1/3, 25RB) standard.

1.4.2 Software Specification

Item	Description
LTE Standard	LTE TDD 3GPP Release 9
Maximum Throughput	<ul style="list-style-type: none"> 20MHz: DL 110Mbps, UL 20Mbps 10MHz: DL 55Mbps, UL 9Mbps
Business Capacity	32 concurrent users (support software upgrading the users to 96)
Modulation Mode	QPSK, 16QAM, 64QAM
Traffic Offload	Support LIPA/SIPTO, which is Local IP Access and Selected IP Traffic Offload for short
SON	Self-organizing network: support plug and play, automatic start, optimization and configuration
RAN Sharing	Support
Network Management Interface	Support TR069 interface protocol
Northbound Interface	Support Web service, Socket, FTP and other interface modes
MTBF	≥ 50000 hours
MTTR	≤ 1 hour
Maintenance	Support remote/local maintenance, based on SSH protocol
	Support remote maintenance
	Support online status management
	Support performance statistics
	Support failure management
	Support configuration management
	Support local or remote software upgrading and loading
	Support log
	Support connectivity diagnosis
	Support automatic start and configuration
Support alarm reporting	

1.4.3 Environment Specification

Item	Description
Operating Temperature	-40°C ~ 55°C
Humidity	5% ~ 95%
Atmospheric Pressure	70kPa ~ 106kPa
IP Protection Grade	IP65

2. Out-of-Box Audit

Before opening the box, make sure the package is in good condition, undamaged and not wet. During the unpacking, avoid potential damaging impacts from hits or excessive force. Once unpacked, check the contents to see if they are consistent with that in the shipping list shown in Table 2-1.

Table 2-1 Shipping List

No.	Item	Quantity	Description
1	pBS11004 base station	1	Check whether the base station's tag is consistent with the requirement
2	Base station mounting bracket	1	Fixed with base station
3	Integrated bracket for on pole or on wall	1	Used for fix on pole or on wall
4	U shape clamp	1	Used for fix on pole
5	Omega		Used for fix on pole
6	Screw package	1	M6*12 combined screw * 8 M8 hex nut * 2
7	PoE power adaptor	1	-
8	Power cable	1	The length is 1m.
9	Ground terminal	1	Used for making ground cable.
10	Warranty	1	-
11	Certification	1	-
12	User guide	1	-

Note:

During the unpacking, if the outer package is damaged or wet, stop unpacking and find the cause. Report the issue to the vendor. For any shortage or damage that is identified, report the local vendor within 10 days.

3. Installation Preparation

3.1 Support Materials













Prepare the following support materials accordingly, as given in Table 3-1.

Table 3-1 Support Materials for Installing Base Station

Item	Description
Ethernet cable	Outdoor CAT6 Shorter than 100m (330 feet)
Ground cable	16mm ² yellow-green wire

3.2 Installation Tools

The following tools are needed during the installation.

				
Level bar	Marking pen	Knife	Vise	Wrench
				
Percussion drill and some drill heads	hammer	Cross screw driver	Cable vice	Tape measure
				
5mm L-shape allen wrench	T7 screwdriver head	Ladder		

3.3 Installation Environment

3.3.1 Locational Requirements

Environments with high-temperatures, harmful gases, unstable voltages, volatile vibrations, loud noises, flames, explosives, and electromagnetic interference (large radar stations, transmitting stations, transformer substations) are not suitable for the operation of pBS11004, and thus should be avoided.

Places prone to have impounded water, soaking, leakage, or condensation, should also be avoided.

Factors like climate, hydrology, geology, earthquake, electric power, and transportation should be taken into consideration in the construction process so that a proper location can be chosen to meet the communication engineering environmental requirements, as well as the technical requirements of network planning and communication equipment.

3.3.2 Environmental Requirements

Table 3-2 gives the base station's environmental requirements with regards to temperature, humidity, and voltage.

Table 3-2 Environmental Requirements of the Base Station

Item	Range
Humidity	-40° C ~ 55° C
Relative humidity (no condensation)	5% ~ 95%

3.4 Personnel Requirements

The installation personnel must master the basic safe operation knowledge, through the training, and having the corresponding qualifications.

3.5 Grounding Protection



CAUTION:

It is unlikely to happen but since the LTE eNodeB is very sophisticated equipment so we would recommend you to test it on the ground to make sure everything is functioning before install on the tower.

Grounding Notes:

- The ground wire adopts yellow-green wire that is no smaller than 16 mm².
- Grounding principle: as near as possible.
- The eNodeB connects to the reliable outdoor grounding point (earth) through one ground screw.
- The connection of the grounding points and the ground bar need to be tight and reliable. Rustproofing the terminals is required. This can be done with rust preventing paint, anti-oxidation coatings, grease, and so on.

3.6 Regulatory Compliance

FCC Compliance

This device complies with part 15 of the FCC Rules. Operation is subject to the following two conditions: (1) This device may not cause harmful interference, and (2) this device must accept any interference received, including interference that may cause undesired operation.

Any Changes or modifications not expressly approved by the party responsible for compliance could void the user's authority to operate the equipment.

This equipment has been tested and found to comply with the limits for a Class A digital device, pursuant to part 15 of the FCC Rules. These limits are designed to provide reasonable protection against harmful interference when the equipment is operated in a commercial environment. This equipment generates, uses, and can radiate radio frequency energy and, if not installed and used in accordance with the instruction manual, may cause harmful interference to radio communications. Operation of this equipment in a residential area is likely to cause harmful interference in which case the user will be required to correct the interference at his own expense.

Warning

This equipment complies with FCC radiation exposure limits set forth for an uncontrolled environment. This equipment should be installed and operated with minimum distance 30 cm between the radiator & your body.

ISED Compliance

This device complies with Innovation, Science, and Economic Development Canada licence-exempt RSS standard(s).

Operation is subject to the following two conditions: (1) This device may not

cause interference, and (2) This device must accept any interference, including interference that may cause undesired operation of the device.

Le présent appareil est conforme aux CNR d' Innovation, Science et Développement

économique Canada applicables aux appareils radio exempts de licence.

L'exploitation est autorisée aux deux conditions

suivantes:

- (1) l'appareil ne doit pas produire de brouillage, et
- (2) l'utilisateur de l'appareil doit accepter tout brouillage radioélectrique subi, même si le brouillage est susceptible d'en compromettre le fonctionnement.

The antenna(s) used for this transmitter must be installed to provide a separation distance of at least 30 cm from all persons and must not be collocated or operating in conjunction with any other antenna or transmitter, End-Users must be provided with transmitter operation conditions for satisfying RF exposure compliance.

4. Base Station Installation

4.1 Install on Pole

Required diameter of the pole: 40mm ~ 100mm.

1. As the following figure, assemble the bracket for pole installation, and fasten screws.

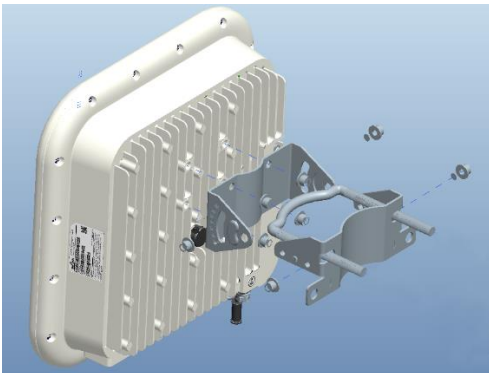

2. Mounting bracket installs is complete as shown in the following figure.

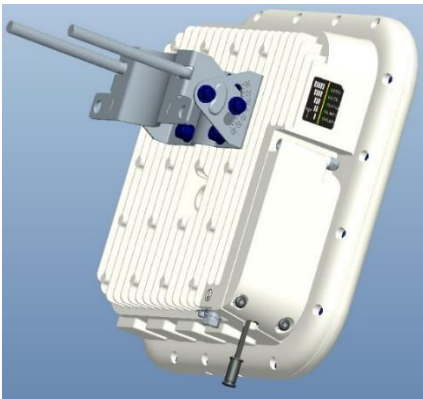

3. Fit the base station assembled bracket to the pole, pass the omega through the threaded rods, and then fasten the two nuts.



4. Adjust base station to proper angle and fasten the screws.

4.2 Install on Wall

The wall must bear four times of the base station weight.

1. Fit the base station on the wall, and mark the drilling locations.

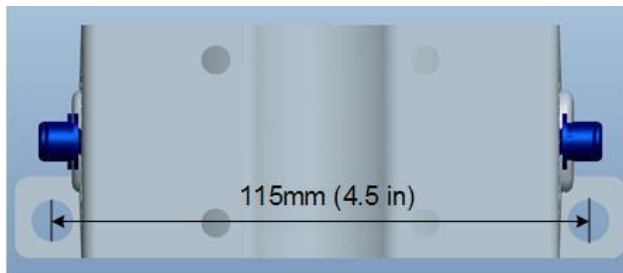

2. Drill four 12mm diameter and 80mm depth holes in the wall by following the marked locations.
3. Check the up/down direction of the installation rack, and then fix the base station to the wall using M8*80 expansion screws.
4. When install on wall, the U shape clamp is not needed.
5. Fix the base station on the bracket and adjust to proper angle.

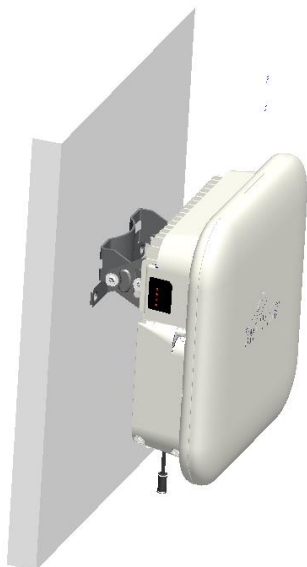

4.3 Connect Cable

4.3.1 Connect Ethernet Cable

1. Unscrew three screws on the cover of wiring cavity using M4 cross screwdriver and

open the wiring cavity.

2. Connect the Ethernet cable to **ETH** interface in the wiring cavity.
3. Lay Ethernet cable along the wire groove, and stretch out the wiring cavity from **ETH** hole.
4. The other end of the Ethernet cable connects to the PoE power adaptor.

4.3.2 Connect Ground Cable

Make the grounding cable according the actual situation of the installation site.

The grounding screws of pBS11004 located on the bottom of the base station, as shown in Figure 4-1.

Figure 4-1 Location of Grounding Screws

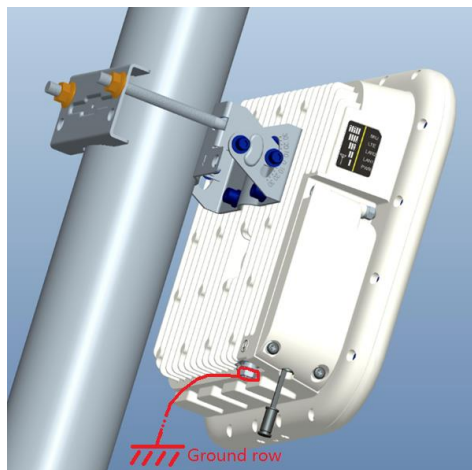

1. Unscrew the grounding screw, connect one end of the grounding cable to the grounding screw, and fasten it again.
2. The other end of the ground cable needs to connect to a good grounding point.

5. Power On

Power on the pBS11004, and the indicators will light up, as shown in Figure 5-1.

Figure 5-1 LED Indicators

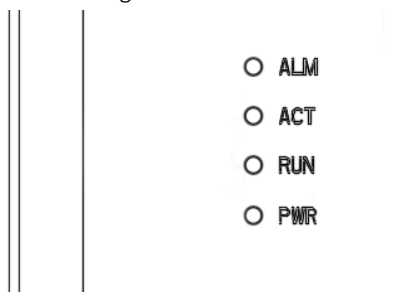

The explanation of the indicator signal is given in Table 5-1.

Table 5-1 pBS11004 Indicator Description

Identity	Color	Status	Description
PWR	Green	Steady On	Power On
		OFF	No Power Supply
ACT	Green	Steady On	The cell is activated.
		OFF	The cell is not activated.
RUN	Green	Fast flash: 0.125s on, 0.125s off	The board is loading.
		Slow flash: 1s on, 1s off	The board is normal.
		OFF	No power input or board fault
ALM	Red	Steady On	Hardware alarm, e.g. VSWR alarm
		OFF	No alarm