

FCC REPORT

(Base Station)

Applicant: Baicells Technologies Co., Ltd.

Address of Applicant: 3F, Hui Yuan Development Building, No.1 Shangdi Information Industry Base, Haidian Dist., Beijing, China

Equipment Under Test (EUT)

Product Name: LTE-TDD Base Station

Model No.: mBS1100

Trade mark: BaiCells

FCC ID: 2AG32MBS1100

Applicable standards: FCC CFR Title 47 Part 2
FCC CFR Title 47 Part 90 Subpart Z

Date of sample receipt: 14 Dec., 2015

Date of Test: 15 Dec., 2015 to 26 Dec., 2016

Date of report issued: 26 Dec., 2016

Test Result: PASS*

* In the configuration tested, the EUT complied with the standards specified above.

Authorized Signature:



Bruce Zhang
Laboratory Manager

This report details the results of the testing carried out on one sample. The results contained in this test report do not relate to other samples of the same product and does not permit the use of the CCIS product certification mark. The manufacturer should ensure that all products in series production are in conformity with the product sample detailed in this report.

This report may only be reproduced and distributed in full. If the product in this report is used in any configuration other than that detailed in the report, the manufacturer must ensure the new system complies with all relevant standards.

This document cannot be reproduced except in full, without prior written approval of the Company. Any unauthorized alteration, forgery or falsification of the content or appearance of this document is unlawful and offenders may be prosecuted to the fullest extent of the law. Unless otherwise stated the results shown in this test report refer only to the sample(s) tested and such sample(s) are retained for 90 days only.

2. Version

Version No.	Date	Description
00	26 Dec., 2016	<p><i>This report was amended on the report CCIS15120098001 which were tested and issued by Shenzhen Zhongjian Nanfang Testing Co., Ltd.</i></p> <p><i>The differences between them as below:</i></p> <p><i>Removed the SNF interface and the relevant module. Base on the differences description, Field strength of spurious radiation was retested.</i></p>

Tested by: Zora Lee **Date:** 26 Dec., 2016
Test Engineer

Reviewed by: M. Liang **Date:** 26 Dec., 2016
Project Engineer

3. Contents

Page

1. COVER PAGE	1
2. VERSION	2
3. CONTENTS	3
4. TEST SUMMARY	4
5. GENERAL INFORMATION	5
5.1 CLIENT INFORMATION.....	5
5.2 GENERAL DESCRIPTION OF E.U.T.....	5
5.3 TEST MODES.....	6
5.4 DESCRIPTION OF SUPPORT UNITS.....	6
5.5 RELATED SUBMITTAL(S) / GRANT (S).....	6
5.6 TEST METHODOLOGY.....	6
5.7 LABORATORY FACILITY.....	6
5.8 LABORATORY LOCATION.....	6
5.9 TEST INSTRUMENTS LIST.....	7
6. SYSTEM TEST CONFIGURATION	8
6.1 EUT CONFIGURATION.....	8
6.2 EUT EXERCISE.....	8
6.3 CONFIGURATION OF TESTED SYSTEM.....	8
6.4 DESCRIPTION OF TEST MODES.....	8
6.5 TRANSMIT OUTPUT POWER AND PSD.....	9
6.6 OCCUPY BANDWIDTH.....	19
6.7 EMISSION MASK.....	25
6.8 OUT OF BAND EMISSION AT ANTENNA TERMINALS.....	30
6.9 FIELD STRENGTH OF SPURIOUS RADIATION MEASUREMENT.....	39
6.10 FREQUENCY STABILITY V.S. TEMPERATURE MEASUREMENT.....	43
6.11 FREQUENCY STABILITY V.S. VOLTAGE MEASUREMENT.....	46
7 TEST SETUP PHOTO	48
8 EUT CONSTRUCTIONAL DETAILS	49

4. Test Summary

Test Item	Section in CFR 47	Result
	FCC	
RF Output Power	Part 2.1046 Part 90.1321	Pass*
Modulation Characteristics	Part 2.1047	Pass*
99% & -26 dB Occupied Bandwidth	Part 2.1049 Part 90.209	Pass*
Emission Mask	Part 90.210(b)	Pass*
Spurious Emissions at Antenna Terminal	Part 2.1051 Part 90.1323	Pass*
Field Strength of Spurious Radiation	Part 2.1053 Part 90.1323	Pass
Frequency stability vs. temperature	Part 2.1055(a)(1)(b) Part 90.213(a)	Pass*
Frequency stability vs. voltage	Part 2.1055(d)(1)(2) Part 90.213(a)	Pass*

Pass: The EUT complies with the essential requirements in the standard.

Pass: The test data refer to original report: CCIS15120098001*

5. General Information

5.1 Client Information

Applicant:	Baicells Technologies Co., Ltd.
Address of Applicant:	3F, Hui Yuan Development Building, No.1 Shangdi Information Industry Base, Haidian Dist., Beijing, China
Manufacturer	Baicells Technologies Co., Ltd.
Address of Manufacturer:	3F, Hui Yuan Development Building, No.1 Shangdi Information Industry Base, Haidian Dist., Beijing, China

5.2 General Description of E.U.T.

Product Name:	LTE-TDD Base Station
Model No.:	mBS1100
Operation Frequency range:	3655MHz~3695MHz
Modulation type:	BPSK, QPSK, 16QAM, 64QAM
Antenna type:	External antenna ("N" type)
Antenna gain:	7 dBi
Power supply:	DC 48V

Test Channel:

10MHz		20MHz	
Channel:	Frequency (MHz)	Channel:	Frequency (MHz)
Lowest	3655	Lowest	3660
Middle	3675	Middle	3675
Highest	3695	Highest	3690

5.3 Test modes

Data mode (QPSK)	Keep the EUT in data communicating mode (QPSK). (10MHz, 20MHz)
Data mode (64QAM)	Keep the EUT in data communicating mode (64QAM). (10MHz, 20MHz)

5.4 Description of Support Units

Manufacturer	Description	Model	Serial Number	FCC ID/DoC
INVENTRONICS	LED DRIVER	EUUV-200S048SV	N/A	N/A

5.5 Related Submittal(s) / Grant (s)

FCC: This submittal(s) (test report) is filing to comply with Section Part 90 subpart Z of the FCC CFR 47 Rules.
--

5.6 Test Methodology

FCC: Both conducted and radiated testing were performed according to the procedures document on TIA/EIA 603 and FCC CFR 47.1046, 2.1047, 2.1049, 2.1051, 2.1053, 2.1055 and 2.1057
--

5.7 Laboratory Facility

<p>The test facility is recognized, certified, or accredited by the following organizations:</p> <ul style="list-style-type: none"> FCC - Registration No.: 817957 Shenzhen Zhongjian Nanfang Testing Co., Ltd. EMC Laboratory has been registered and fully described in a report filed with the (FCC) Federal Communications Commission. The acceptance letter from the FCC is maintained in out files. Registration 817957, February 27, 2012. IC - Registration No.: 10106A-1 The 3m Semi-anechoic chamber of Shenzhen Zhongjian Nanfang Testing Co., Ltd. has been Registered by Certification and Engineering Bureau of Industry Canada for radio equipment testing with Registration No.: 10106A-1. CNAS - Registration No.: CNAS L6048 Shenzhen Zhongjian Nanfang Testing Co., Ltd. is accredited to ISO/IEC 17025:2005 General Requirements for the Competence of Testing and Calibration laboratories for the competence of testing. The Registration No. is CNAS L6048.

5.8 Laboratory Location

Shenzhen Zhongjian Nanfang Testing Co., Ltd. Address: No. B-C, 1/F., Building 2, Laodong No.2 Industrial Park, Xixiang Road, Bao'an District, Shenzhen, Guangdong, China Tel: +86-755-23118282 Fax: +86-755-23116366
--

5.9 Test Instruments list

Test Equipment	Manufacturer	Model No.	Inventory No.	Cal. Date (mm-dd-yy)	Cal. Due date (mm-dd-yy)
3m SAC	SAEMC	9(L)*6(W)* 6(H)	CCIS0001	08-23-2014	08-22-2017
BiConiLog Antenna	SCHWARZBECK	VULB9163	CCIS0005	03-25-2016	03-25-2017
Horn Antenna	SCHWARZBECK	BBHA9120D	CCIS0006	03-25-2016	03-25-2017
Pre-amplifier (10kHz-1.3GHz)	HP	8447D	CCIS0003	04-01-2016	03-31-2017
Pre-amplifier (1GHz-18GHz)	Compliance Direction Systems Inc.	PAP-1G18	CCIS0011	04-01-2016	03-31-2017
Pre-amplifier (18-26GHz)	Rohde & Schwarz	AFS33-18002 650-30-8P-44	GTS218	04-01-2016	03-31-2017
Horn Antenna	ETS-LINDGREN	3160	GTS217	04-01-2016	03-31-2017
Spectrum analyzer 9k-30GHz	Rohde & Schwarz	FSP30	CCIS0023	03-28-2016	03-28-2017
Spectrum Analyzer 20Hz-26.5GHz	Agilent	N9020A	CCIS0174	10-24-2016	10-24-2017
EMI Test Receiver	Rohde & Schwarz	ESRP7	CCIS0167	03-24-2016	03-24-2017
Loop antenna	Laplace instrument	RF300	EMC0701	04-01-2016	03-31-2017

6. System test configuration

6.1 EUT Configuration

The EUT configuration for testing is installed on RF field strength measurement to meet the commission's requirement and operating in a manner which intends to maximize its emission characteristics in a continuous normal application.

6.2 EUT Exercise

The EUT (Transmitter) was operated in the engineering mode to fix the Tx frequency which was for the purpose of the measurements.

6.3 Configuration of Tested System

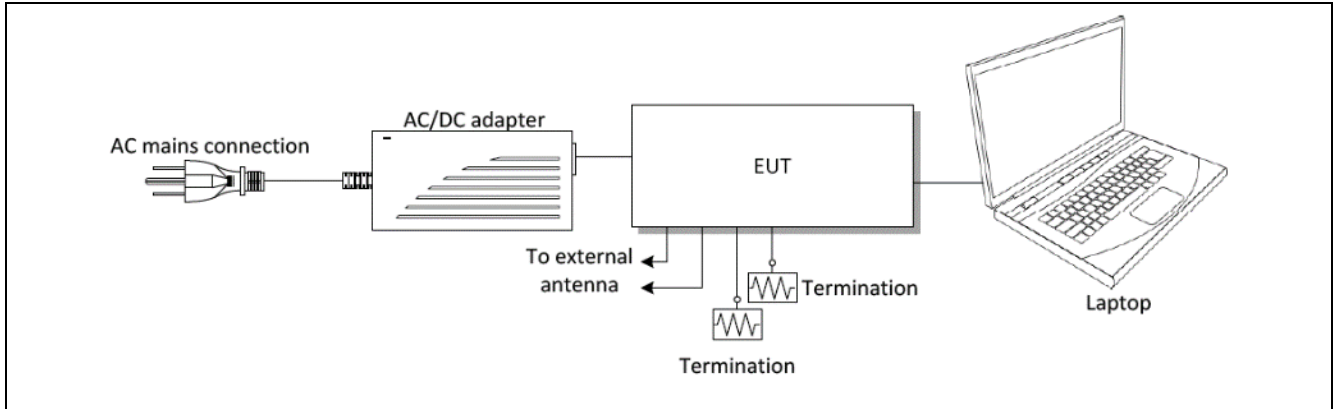

6.4 Description of Test Modes

The EUT has been tested under operating condition.

EUT staying in continuous transmitting mode. Channel Low, Mid and High for each type band with rated data rate were chosen for full testing.

The field strength of spurious radiation emission was measured as EUT stand-up position (H mode) and lie down position (E1, E2 mode) for three modes with power adaptor, earphone and Data cable. The worst-case H mode.

6.5 Transmit Output Power and PSD

Test Requirement:	FCC part 90.1321(a)
Test Method:	FCC part 2.1046
Limit:	<p>(a) Base and fixed stations are limited to 25 watts/25 MHz equivalent isotropically radiated power (EIRP). In any event, the peak EIRP power density shall not exceed 1 Watt in any one-megahertz slice of spectrum.</p> <p>(b) In addition to the provisions in paragraph (a) of this section, transmitters operating in the 3650-3700 MHz band that emit multiple directional beams, simultaneously or sequentially, for the purpose of directing signals to individual receivers or to groups of receivers provided the emissions comply with the following:</p> <p>(1) Different information must be transmitted to each receiver.</p> <p>(2) If the transmitter employs an antenna system that emits multiple directional beams but does not emit multiple directional beams simultaneously, the total output power conducted to the array or arrays that comprise the device, <i>i.e.</i>, the sum of the power supplied to all antennas, antenna elements, staves, etc. and summed across all carriers or frequency channels, shall not exceed the limit specified in paragraph (a) of this section, as applicable. The directional antenna gain shall be computed as follows:</p> <p>(i) The directional gain, in dBi, shall be calculated as the sum of 10 log (number of array elements or staves) plus the directional gain, in dBi, of the individual element or staff having the highest gain.</p> <p>(ii) A lower value for the directional gain than that calculated in paragraph (b)(2)(i) of this section will be accepted if sufficient evidence is presented, <i>e.g.</i>, due to shading of the array or coherence loss in the beam-forming.</p> <p>(3) If a transmitter employs an antenna that operates simultaneously on multiple directional beams using the same or different frequency channels and if transmitted beams overlap, the power shall be reduced to ensure that the aggregate power from the overlapping beams does not exceed the limit specified in paragraph (b)(2) of this section. In addition, the aggregate power transmitted simultaneously on all beams shall not exceed the limit specified in paragraph (b)(2) of this section by more than 8 dB.</p> <p>(4) Transmitters that emit a single directional beam shall operate under the provisions of paragraph (b) (2) of this section.</p>
Test Procedure:	RBW=1MHz, VBW=3MHz, Detector mode= RMS , Trace mode: Power averaging over 100 sweeps
Test Instruments:	Refer to section 5.8 for details
Test mode:	Refer to section 5.3 for details
Test results:	Passed

Measurement Data

Transmit Output Power								
Bandwidth (MHz)	Modulation	Test Channel	Chain 0 Output Power (dBm/10MHz)	Chain 1 Output Power (dBm/10MHz)	Total Power (dBm/10MHz)	Antenna Gain (dBi)	EIRP (dBm/10MHz)	EIRP Limit (dBm/10MHz)
10	QPSK	Lowest	25.69	25.66	28.69	10	38.69	40.00
		Middle	25.54	25.57	28.57	10	38.57	
		Highest	25.58	25.55	28.58	10	38.58	
	64QAM	Lowest	25.75	25.74	28.76	10	38.76	
		Middle	25.60	25.61	28.62	10	38.62	
		Highest	25.53	25.49	28.52	10	38.52	
Bandwidth (MHz)	Modulation	Test Channel	Chain 0 Output Power (dBm/20MHz)	Chain 1 Output Power (dBm/20MHz)	Total Power (dBm/20MHz)	Antenna Gain (dBi)	EIRP (dBm/20MHz)	EIRP Limit (dBm/20MHz)
20	QPSK	Lowest	28.55	28.53	31.55	10	41.55	43.01
		Middle	28.44	28.46	31.46	10	41.46	
		Highest	28.58	28.55	31.58	10	41.58	
	64QAM	Lowest	28.72	28.77	31.76	10	41.76	
		Middle	28.66	28.69	31.69	10	41.69	
		Highest	28.61	28.65	31.64	10	41.64	

PSD								
Bandwidth (MHz)	Modulation	Test Channel	Chain 0 PSD (dBm/MHz)	Chain 1 PSD (dBm/MHz)	Total PSD (dBm/MHz)	Antenna Gain (dBi)	EIRP density (dBm/MHz)	EIRP density Limit (dBm/MHz)
10	QPSK	Lowest	16.68	16.75	19.73	10	29.73	30.00
		Middle	16.76	16.66	19.72	10	29.72	
		Highest	16.60	16.71	19.67	10	29.67	
	64QAM	Lowest	16.60	16.44	19.53	10	29.53	
		Middle	16.49	16.64	19.58	10	29.58	
		Highest	16.42	16.53	19.49	10	29.49	
Bandwidth (MHz)	Modulation	Test Channel	Chain 0 PSD (dBm/MHz)	Chain 1 PSD (dBm/MHz)	Total PSD (dBm/MHz)	Antenna Gain (dBi)	EIRP density (dBm/MHz)	EIRP density Limit (dBm/MHz)
20	QPSK	Lowest	14.98	15.26	18.13	10	28.13	30.00
		Middle	14.94	15.16	18.06	10	28.06	
		Highest	15.12	15.13	18.14	10	28.14	
	64QAM	Lowest	15.16	15.17	18.18	10	28.18	
		Middle	15.28	15.10	18.20	10	28.20	
		Highest	15.06	15.02	18.05	10	28.05	

Remark: Directional antenna Gain = Antenna Gain + 10 lg (ANT_N) = 10 dBi

Test plot as follows:

Power

Chain 0:

10MHz

QPSK

64QAM

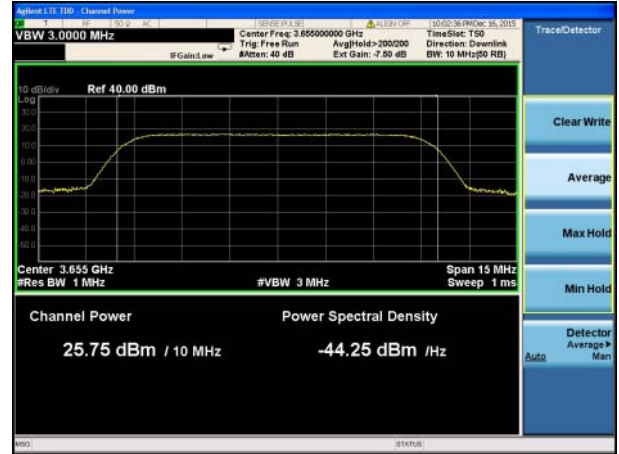
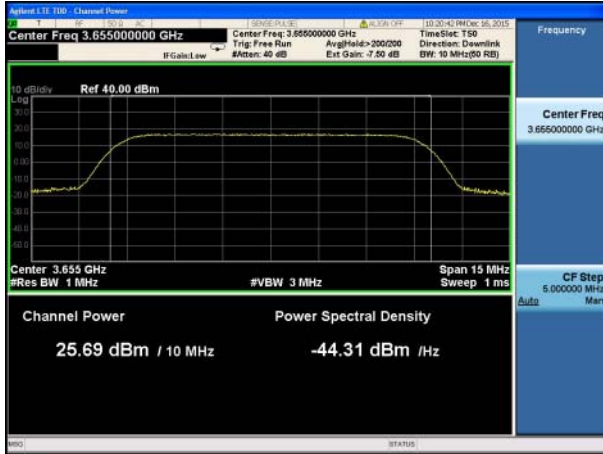

Lowest channel

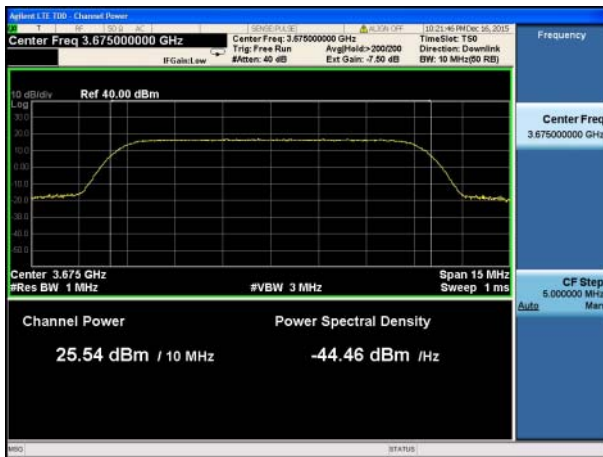

Middle channel

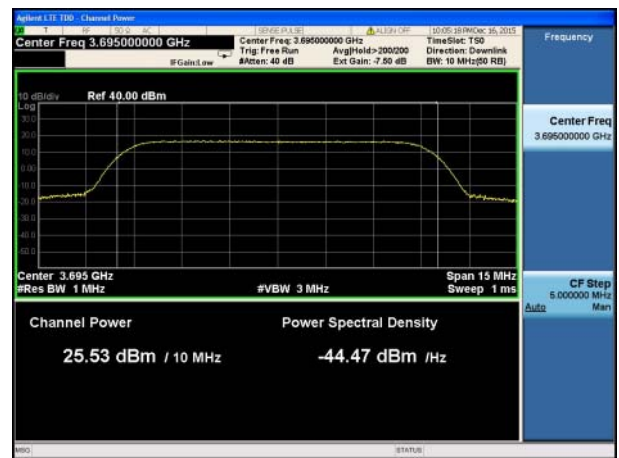
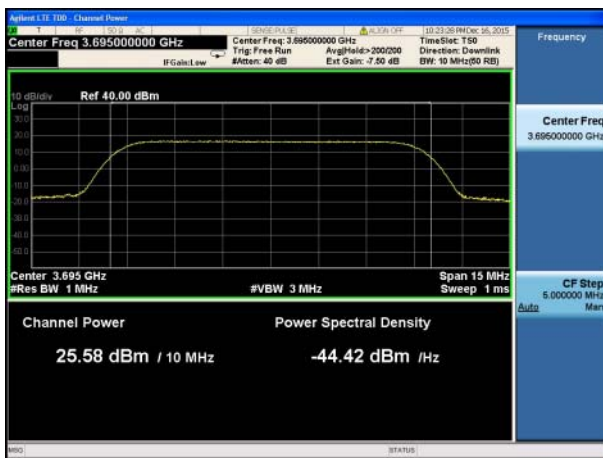

Highest channel

20MHz

QPSK

64QAM

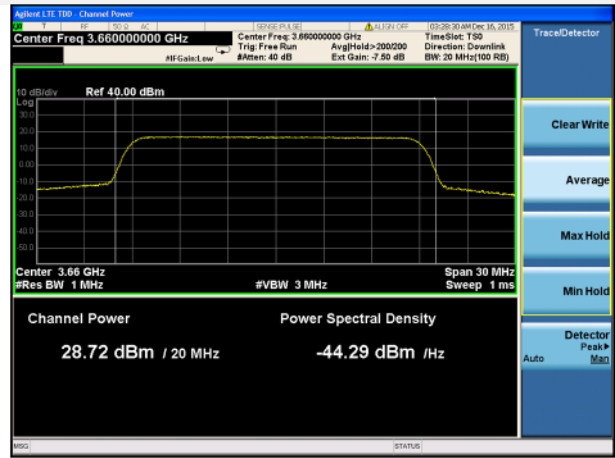
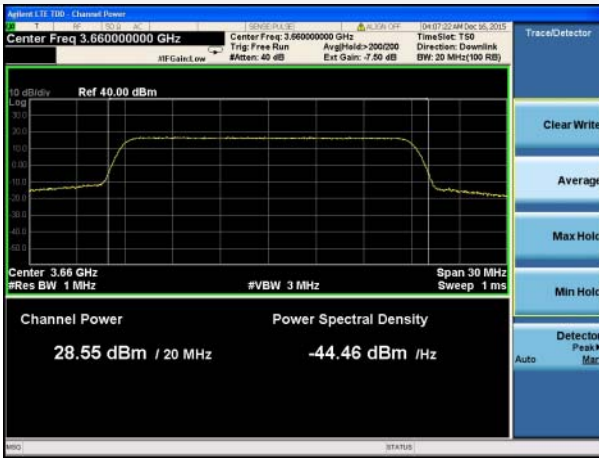

Lowest channel

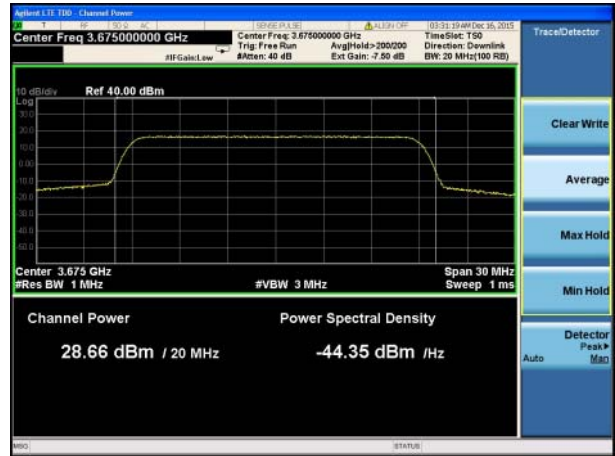
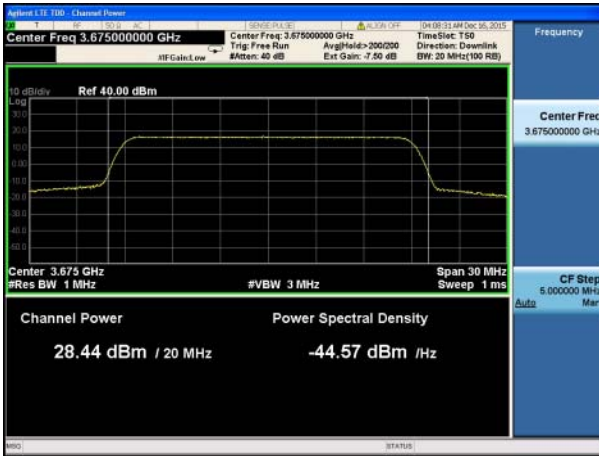

Middle channel

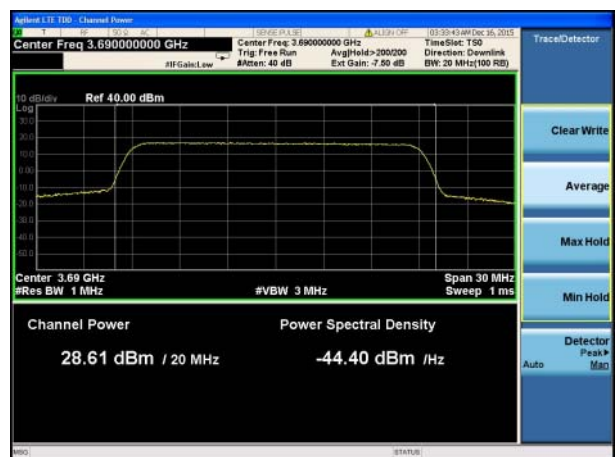
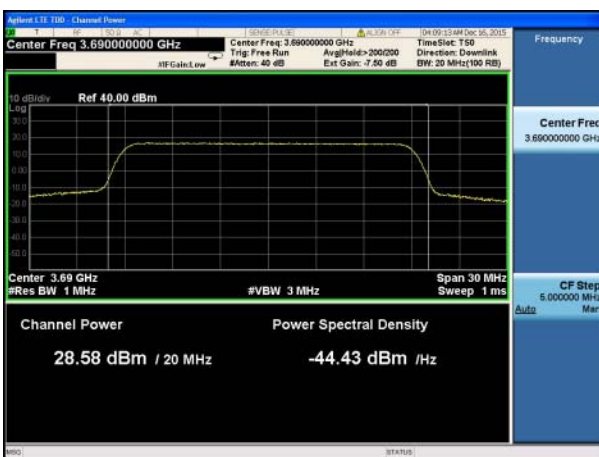

Highest channel

PSD

Chain 0:

10MHz

QPSK

64QAM



Lowest channel

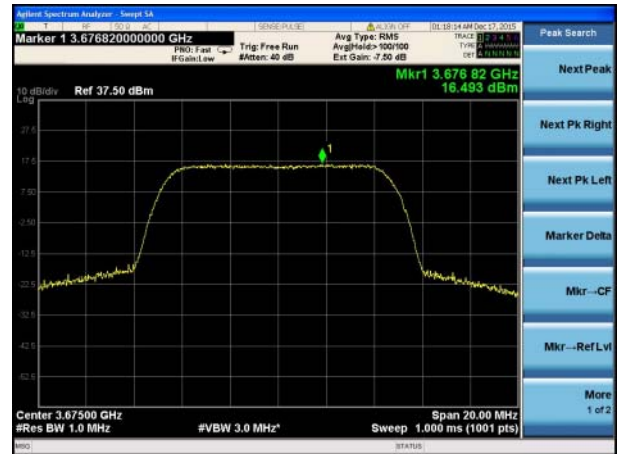
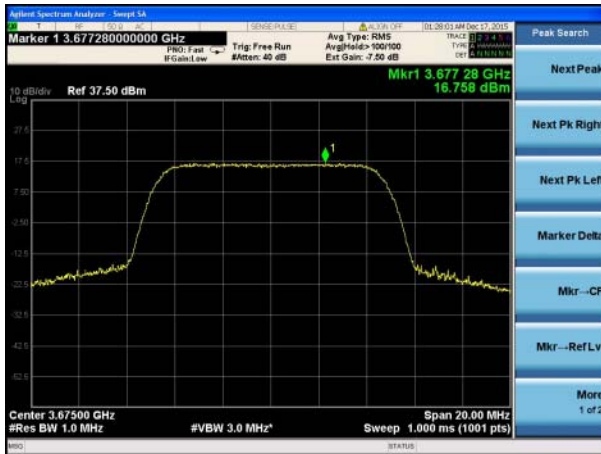

Middle channel

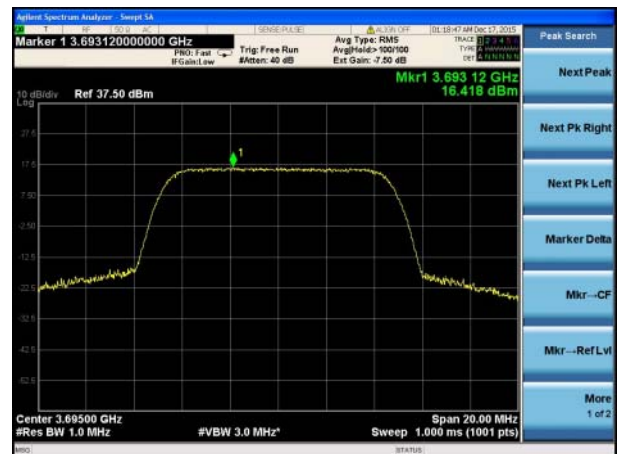
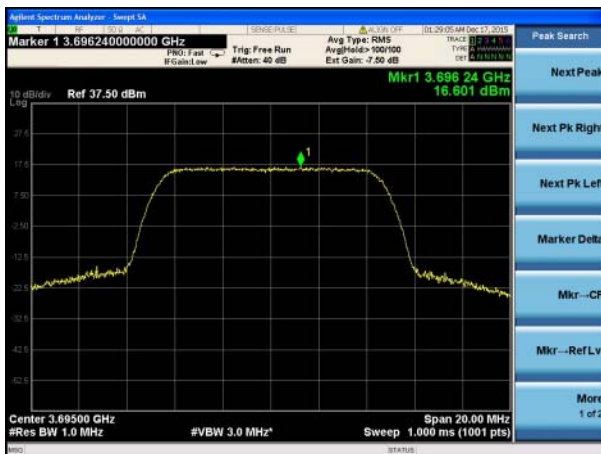

Highest channel

20MHz

QPSK



64QAM



Lowest channel

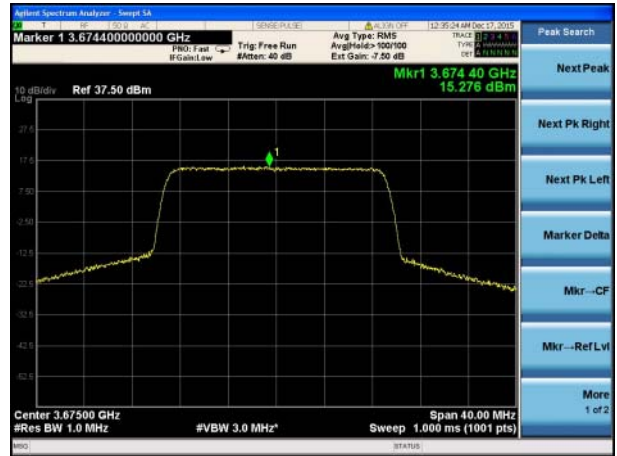

Middle channel

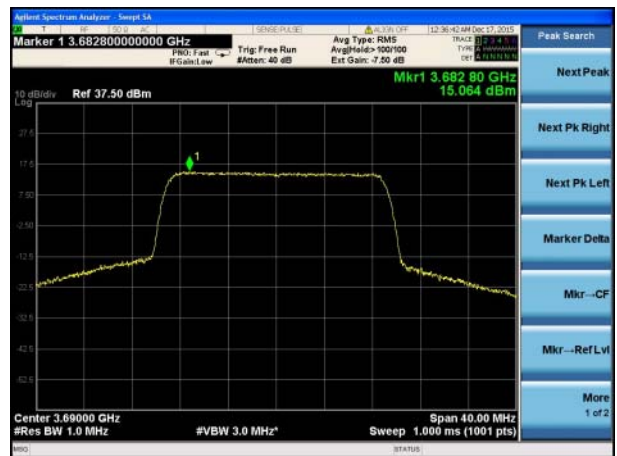

Highest channel

Power

Chain 1:

10MHz

QPSK

64QAM

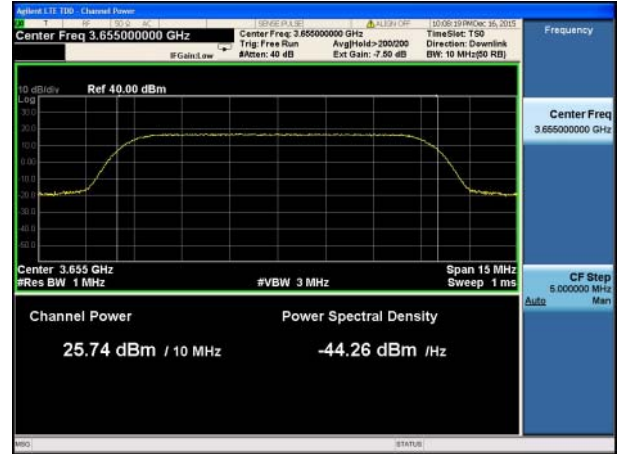
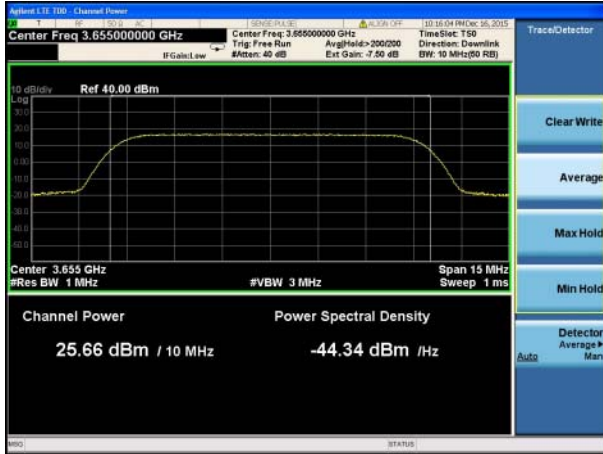

Lowest channel

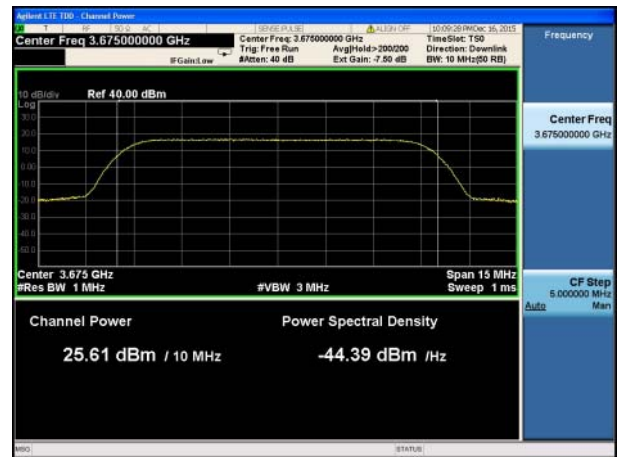
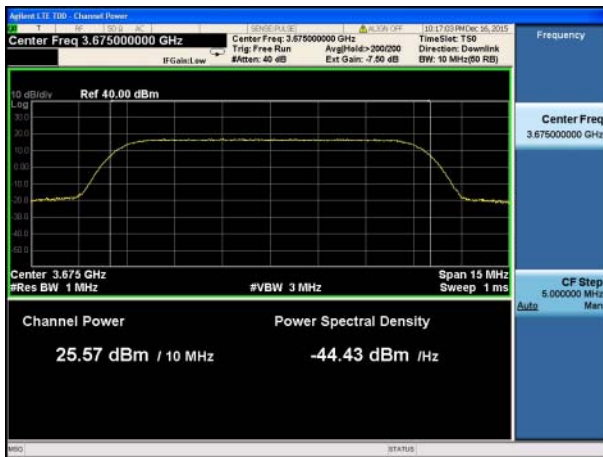

Middle channel

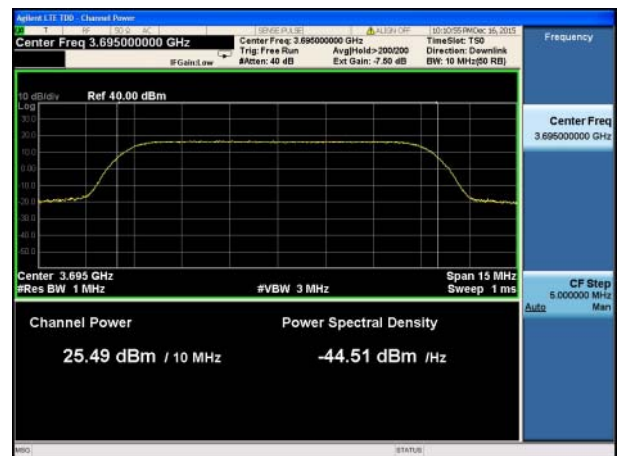
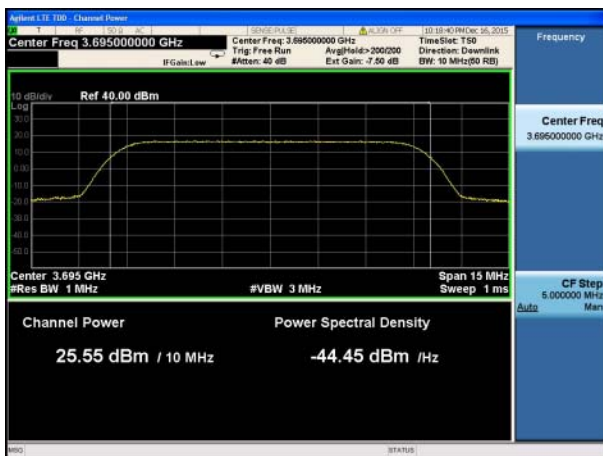

Highest channel

20MHz

QPSK

64QAM

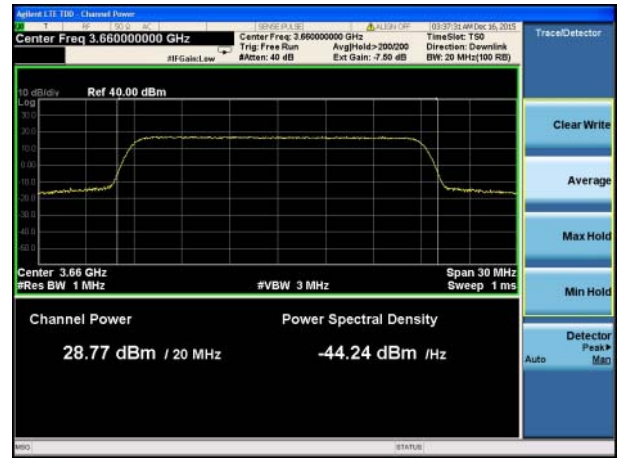
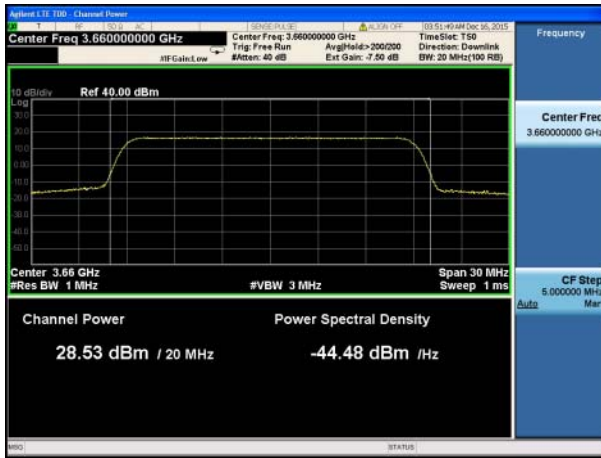

Lowest channel

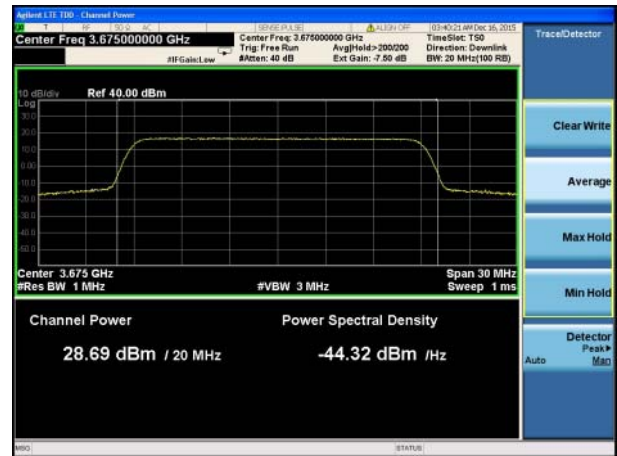
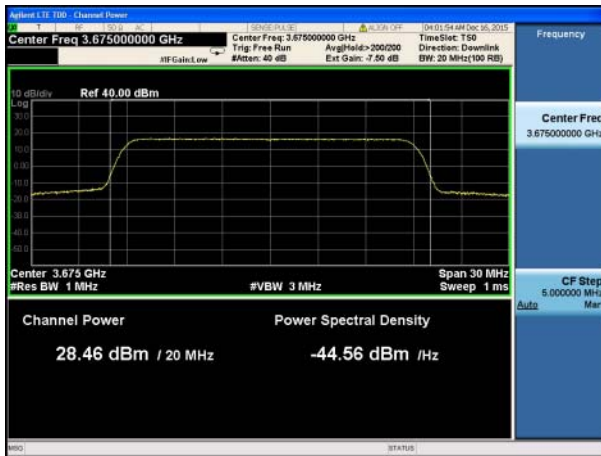

Middle channel

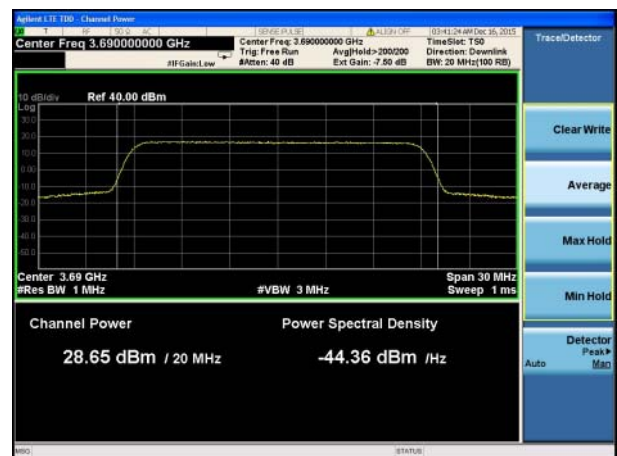
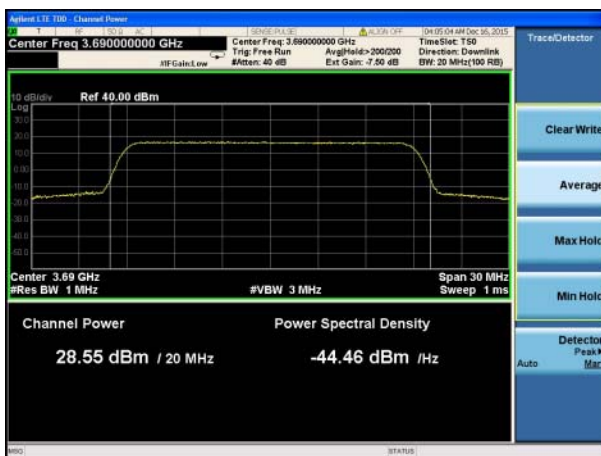

Highest channel

PSD

Chain 1:

10MHz

QPSK

64QAM



Lowest channel



Middle channel

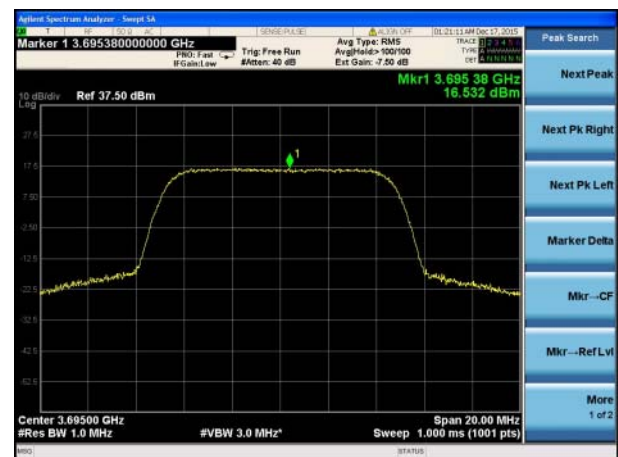
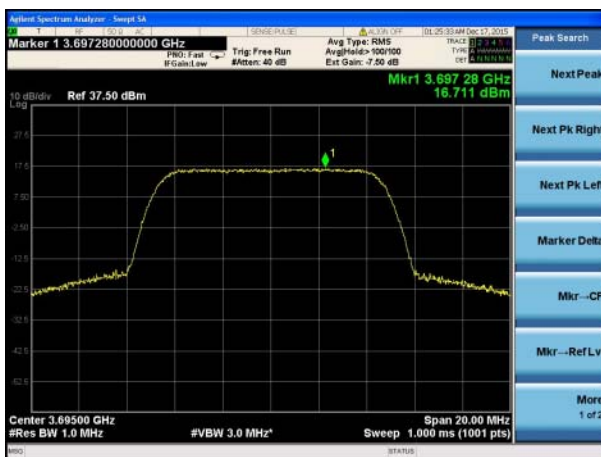

Highest channel

20MHz

QPSK



64QAM



Lowest channel

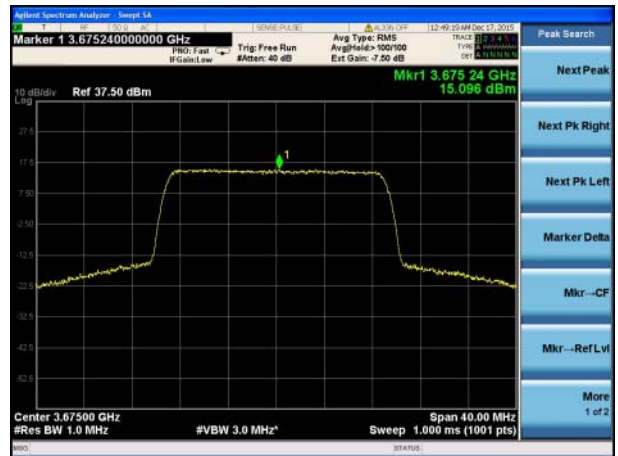

Middle channel

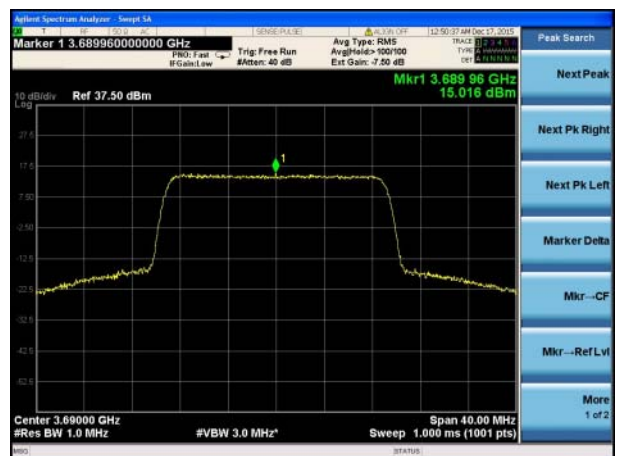
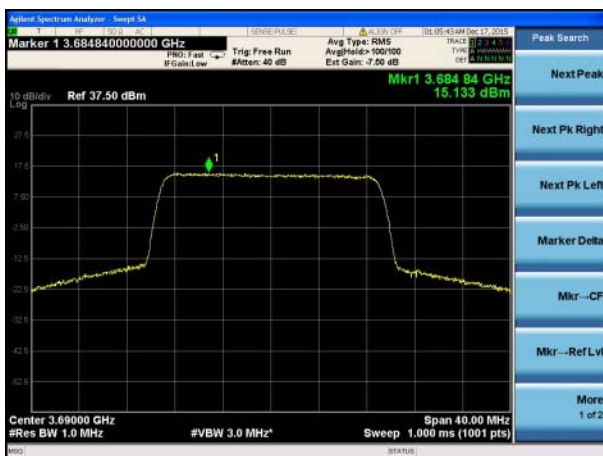

Highest channel

6.6 Occupy Bandwidth

Test Requirement:	FCC part 90.209
Test Method:	FCC part 2.1049
Test Procedure:	<ol style="list-style-type: none"> 1. The EUT's output RF connector was connected with a short cable to the spectrum analyzer 2. The transmitter shall be operated at its maximum carrier power measured under normal test conditions. 3. The span of the analyzer shall be set to capture all products of the modulation process, including the emission skirts. 4. The resolution bandwidth (RBW) shall be in the range of 1% to 5% of the occupied bandwidth (OBW) and video bandwidth (VBW) shall be approximately 3x RBW.
Test Instruments:	Refer to section 5.8 for details
Test mode:	Refer to section 5.3 for details
Test results:	Passed

Measurement Data

Chain 0:

Bandwidth(MHz)	Modulation	Test Channel	99% Occupy bandwidth (MHz)
10	QPSK	Lowest	9.043
		Middle	9.049
		Highest	9.045
	64QAM	Lowest	9.048
		Middle	9.050
		Highest	9.048
20	QPSK	Lowest	17.885
		Middle	17.877
		Highest	17.883
	64QAM	Lowest	17.881
		Middle	17.870
		Highest	17.871

Chain 1:

Bandwidth(MHz)	Modulation	Test Channel	99% Occupy bandwidth (MHz)
10	QPSK	Lowest	9.043
		Middle	9.045
		Highest	9.055
	64QAM	Lowest	9.042
		Middle	9.046
		Highest	9.051
20	QPSK	Lowest	17.870
		Middle	17.871
		Highest	17.880
	64QAM	Lowest	17.883
		Middle	17.876
		Highest	17.870

Test plot as follows:

Chain 0:

10MHz

QPSK

64QAM



Lowest channel



Middle channel



Highest channel

20MHz

QPSK



64QAM



Lowest channel



Middle channel



Highest channel

Chain 1:

10MHz

QPSK

64QAM



Lowest channel



Middle channel



Highest channel

20MHz

QPSK

64QAM



Lowest channel



Middle channel



Highest channel

6.7 Emission Mask

Test Requirement:	FCC part 90.210(b)
Limit:	<p>Emission Mask B. For transmitters that are equipped with an audio low-pass filter, the power of any emission must be attenuated below the unmodulated carrier power (P) as follows:</p> <p>(1) On any frequency removed from the assigned frequency by more than 50 percent, but not more than 100 percent of the authorized bandwidth: At least 25 dB.</p> <p>(2) On any frequency removed from the assigned frequency by more than 100 percent, but not more than 250 percent of the authorized bandwidth: At least 35 dB.</p> <p>(3) On any frequency removed from the assigned frequency by more than 250 percent of the authorized bandwidth: At least $43 + 10 \log (P)$ dB.</p>
Test Procedure:	<ol style="list-style-type: none"> 1 The RF output of the transceiver was connected to a spectrum analyser through appropriate attenuation. 2 RBW=100kHz, VBW=1MHz, Detector mode= RMS, Trace mode: Power averaging over 100 sweeps
Test Instruments:	Refer to section 5.8 for details
Test mode:	Refer to section 5.3 for details
Test results:	Passed

Measurement Data:

Test plots as below:
Chain 0:

10MHz

QPKS

64QAM

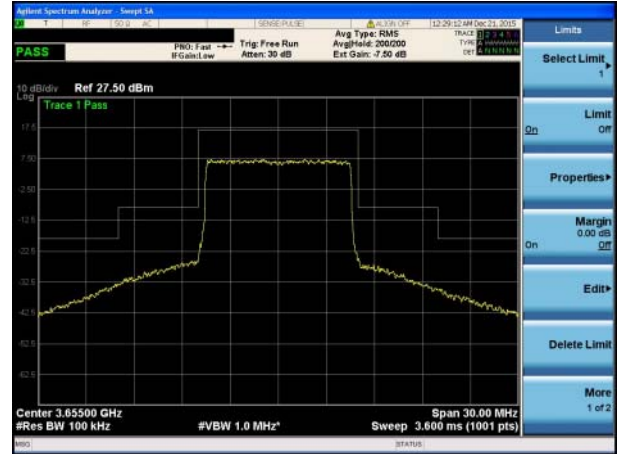
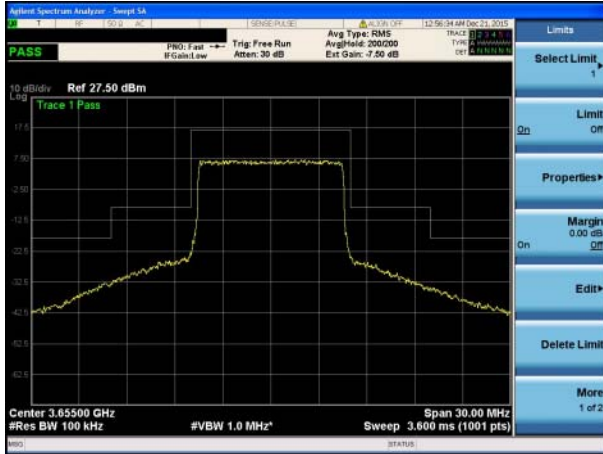

Lowest channel

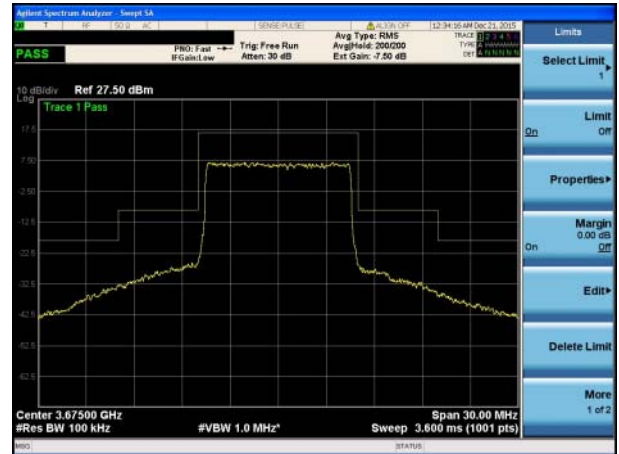
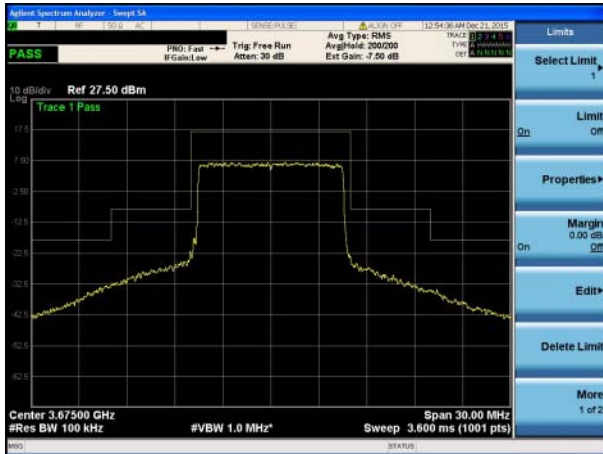

Middle channel

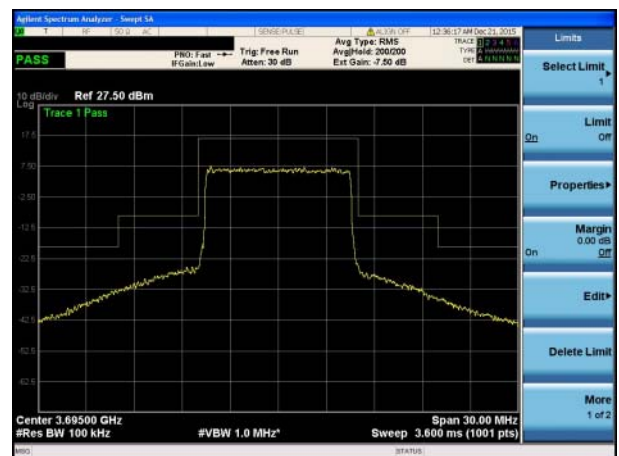

Highest channel

20MHz

QPKS



64QAM



Lowest channel



Middle channel

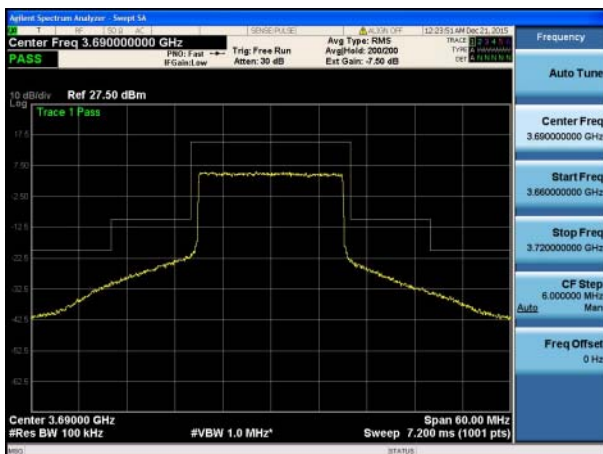

Highest channel

Chain 1:

10MHz

QPKS

64QAM

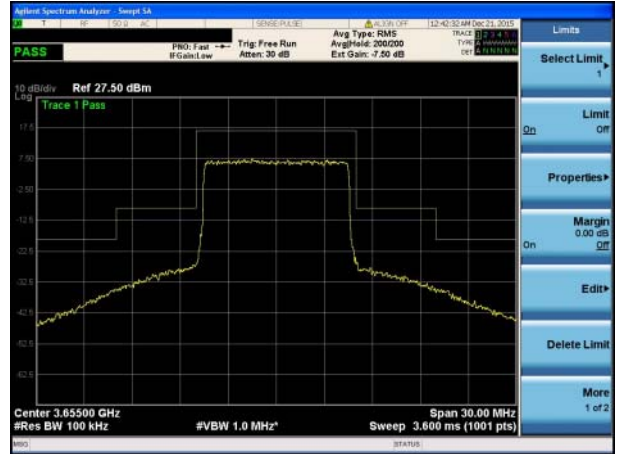
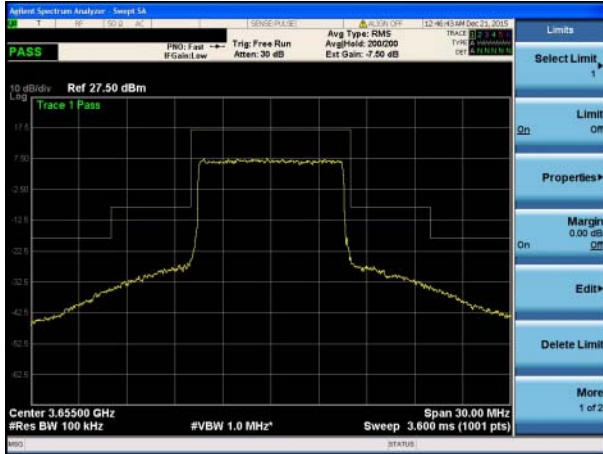

Lowest channel



Middle channel

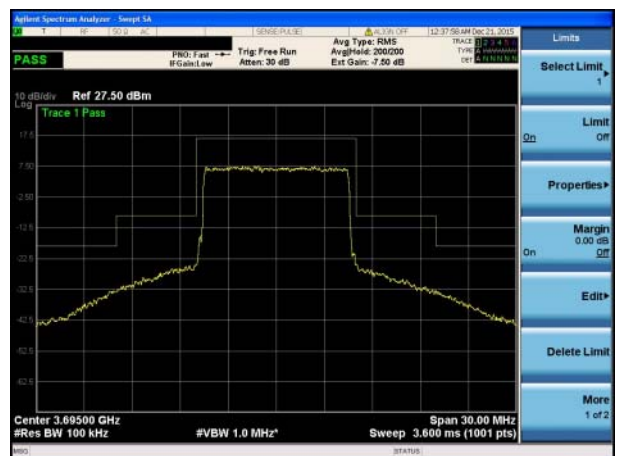
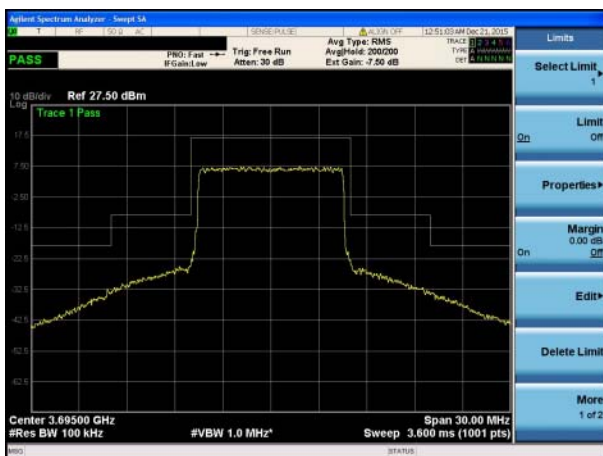

Highest channel

20MHz

QPKS

64QAM

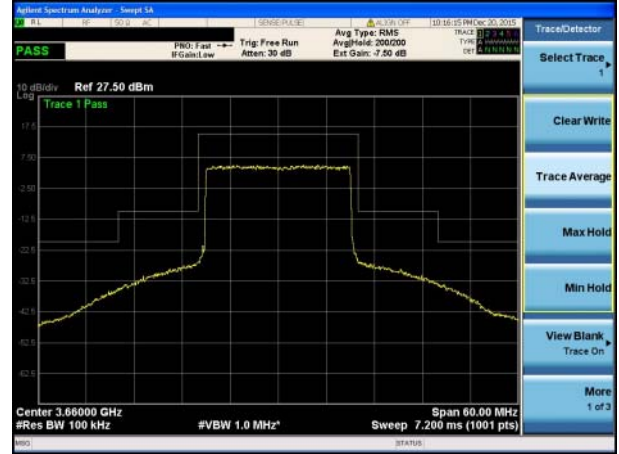

Lowest channel

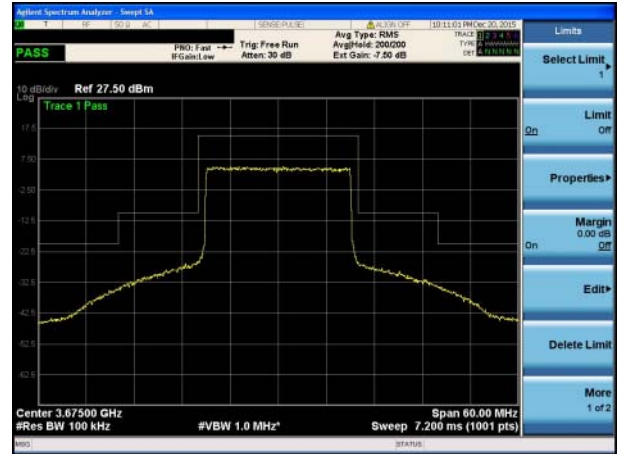

Middle channel



Highest channel

6.8 Out of band emission at antenna terminals

Test Requirement:	FCC part 90.1323
Test Method:	FCC part 2.1051
Limit:	Less than -13dBm
Test Procedure:	<ol style="list-style-type: none"> 1 The RF output of the transceiver was connected to a spectrum analyzer through appropriate attenuation. 2 The resolution bandwidth of the spectrum analyzer was set at 100 kHz when below 1GHz, 1MHz when above 1 GHz; sufficient scans were taken to show the out of band Emissions if any up to 10th harmonic. 3 For the out of band: Set the RBW=100 kHz, VBW=300 kHz when below 1 GHz, RBW =1 MHz, VBW=3 MHz when above 1 GHz, Start=30MHz, Stop= 10th harmonic. 4 Band Edge Requirements: In the 1 MHz bands immediately outside and adjacent to the frequency block, a resolution bandwidth of at least 1 percent of the emission bandwidth of the fundamental emission of the transmitter may be employed to measure the out of band Emissions.
Test Instruments:	Refer to section 5.8 for details
Test mode:	Refer to section 5.3 for details
Test results:	Passed
Remark:	During the test, pre-scan the QPSK, 64QAM modulation, and found the QPSK modulation (10MHz/20MHz middle channel) is the worst case.

Test plots as follows (worst case):

Spurious emission
Chain 0:

10MHz(Middle channel)

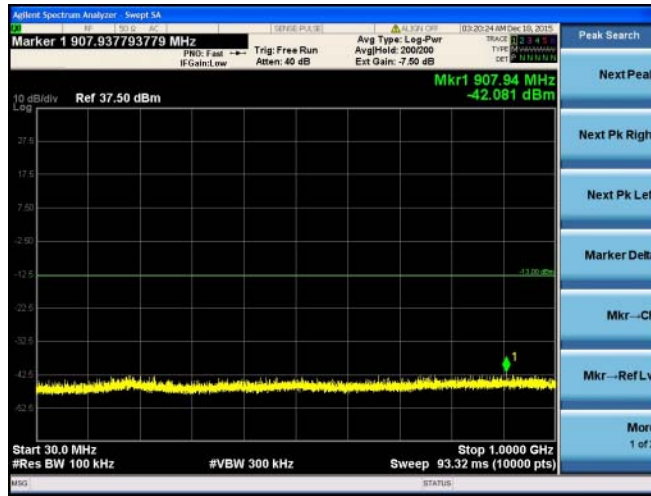

30MHz~1GHz

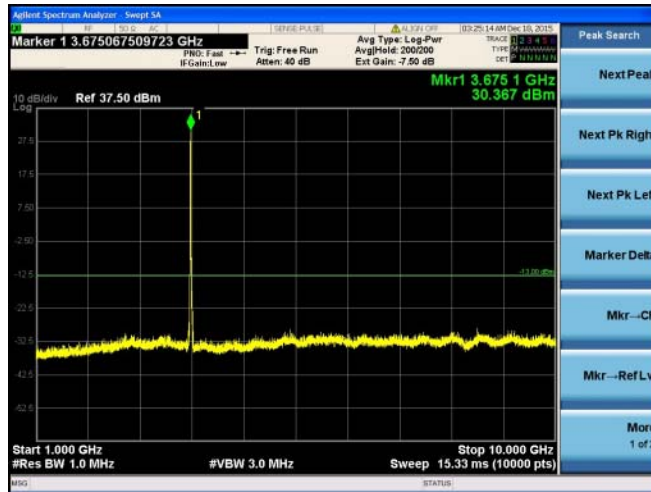

1GHz~10GHz

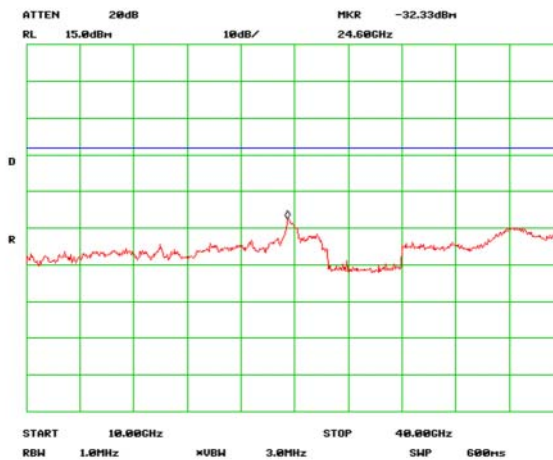

10GHz~40GHz

20MHz(Middle channel)

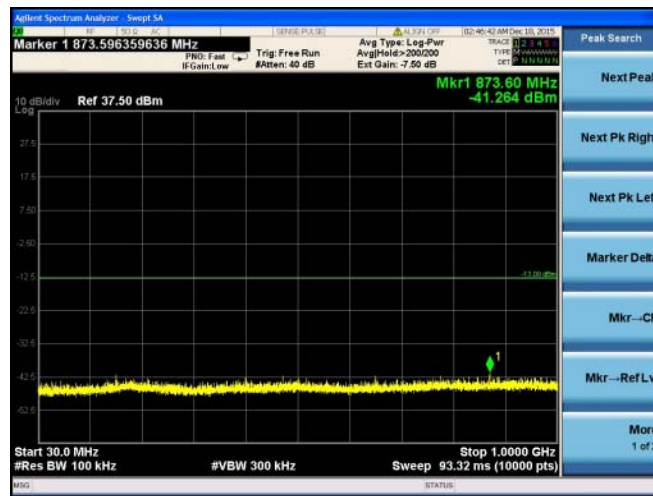

30MHz~1GHz

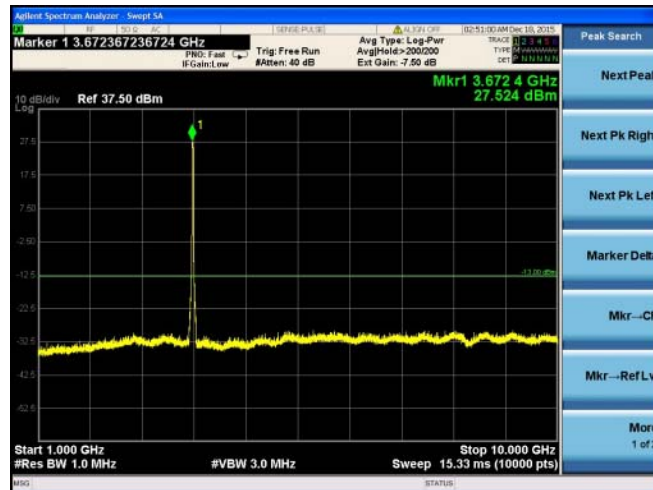

1GHz~10GHz

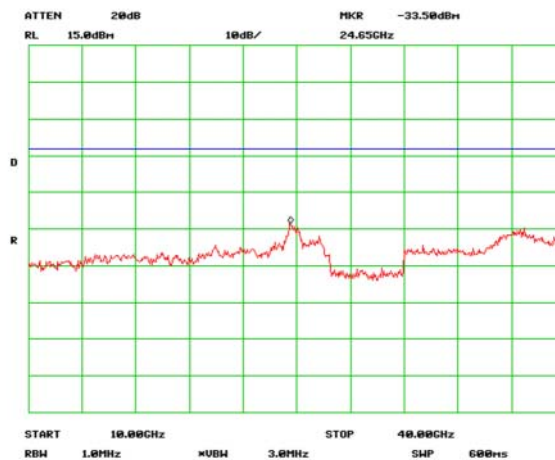

10GHz~40GHz

Chain 1:

10MHz(Middle channel)

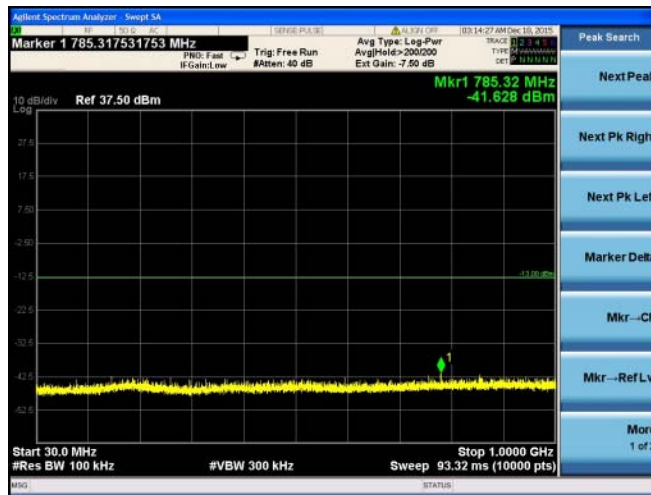

30MHz~1GHz

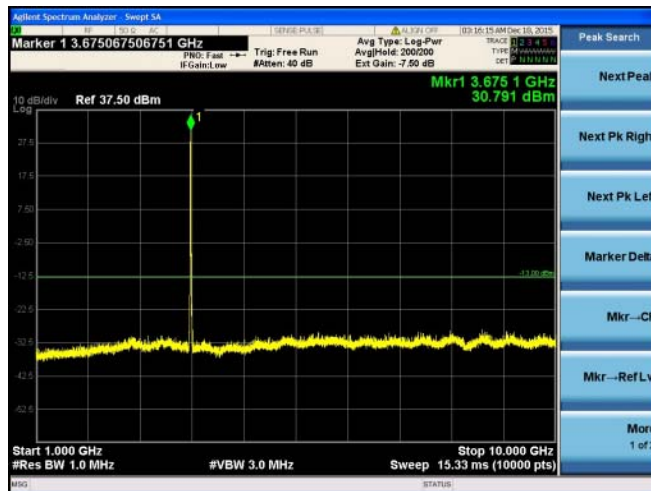

1GHz~10GHz

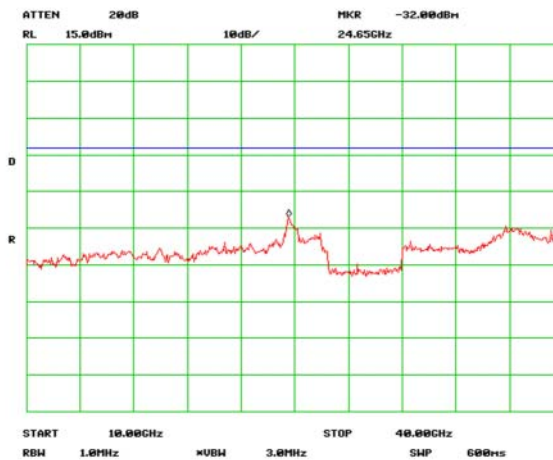

10GHz~40GHz

20MHz(Middle channel)

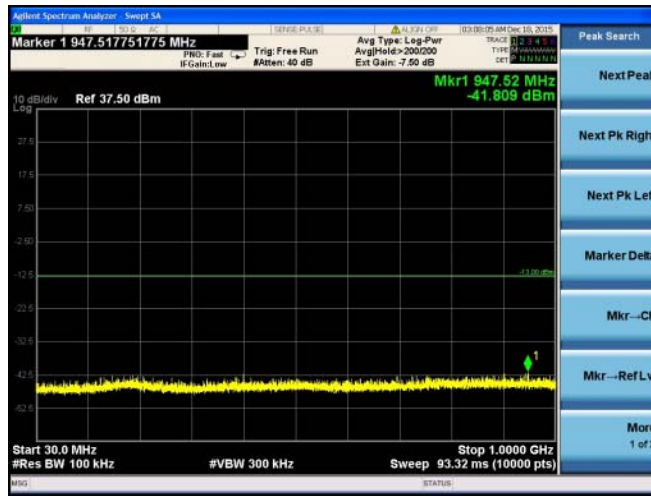

30MHz~1GHz



1GHz~10GHz

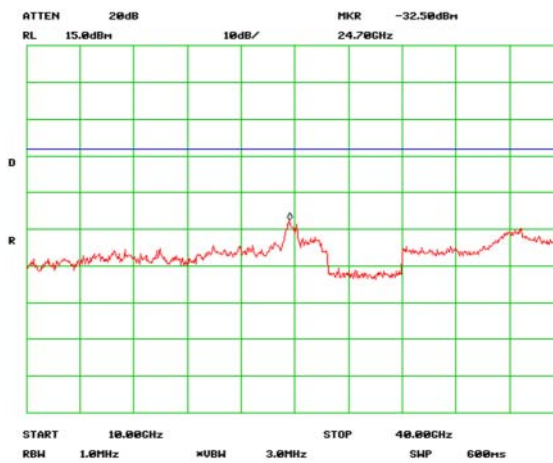

10GHz~40GHz

Band edge emission:

Chain 0:

10MHz

QPSK

64QAM

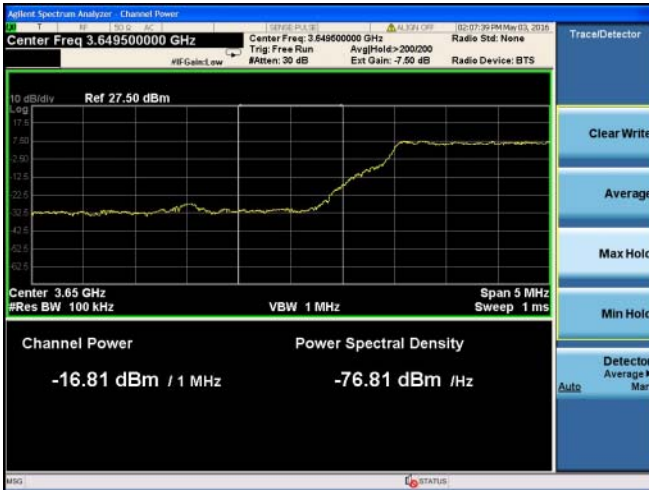

Lowest channel

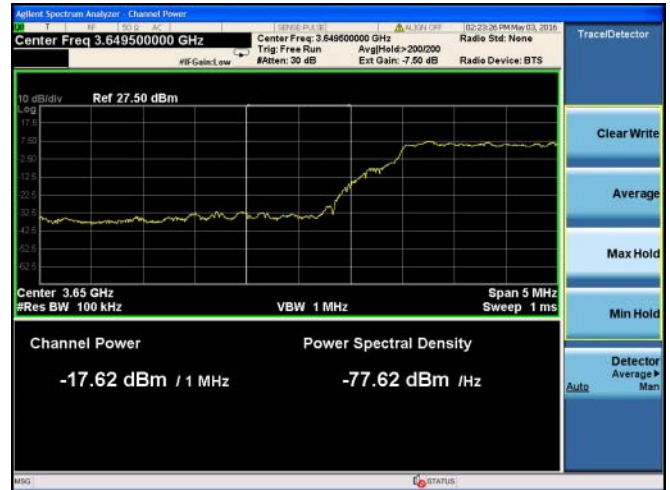

Lowest channel



Highest channel



Highest channel

20MHz

QPSK

64QAM



Lowest channel



Lowest channel



Highest channel



Highest channel

Chain 1:

10MHz

QPSK

64QAM



Lowest channel



Lowest channel



Highest channel

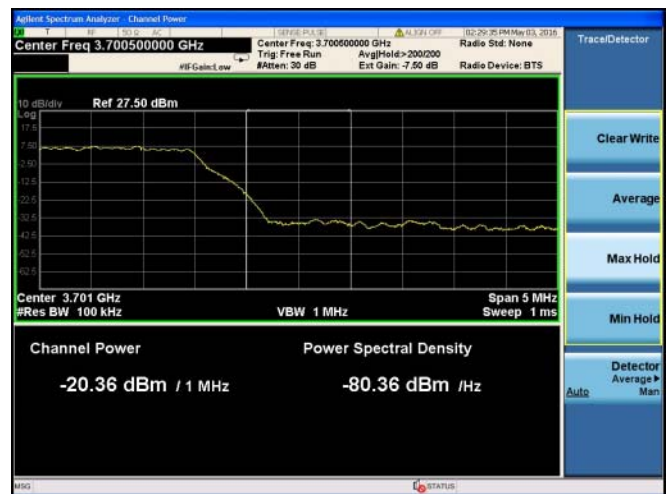

Highest channel

20MHz

QPSK

64QAM

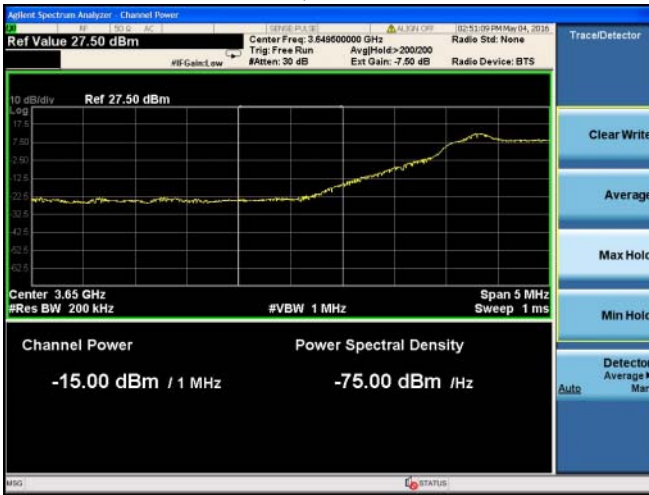

Lowest channel



Lowest channel



Highest channel

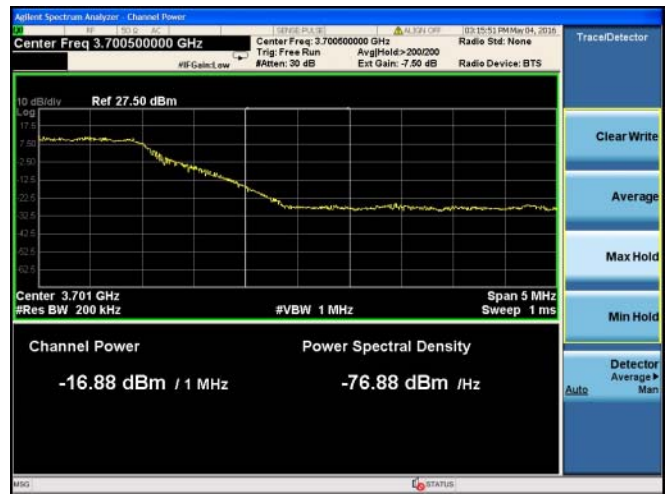

Highest channel

6.9 Field strength of spurious radiation measurement

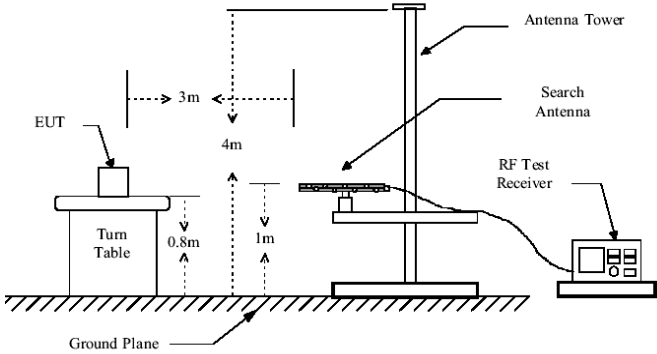
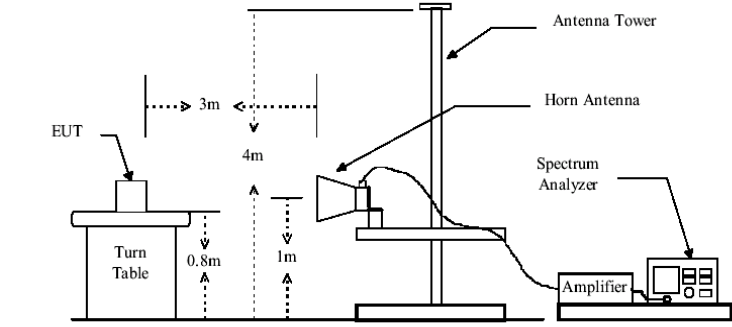
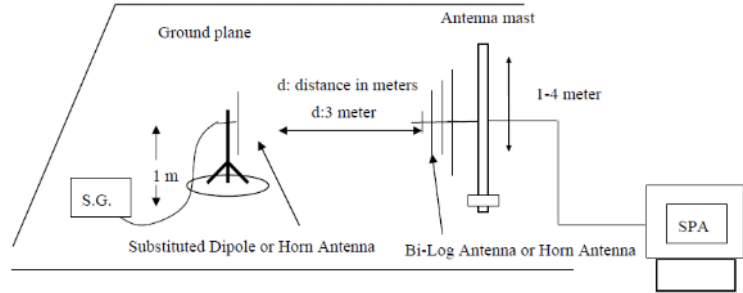
Test Requirement:	FCC part 22.917(a), FCC part 24.238(a)
Test Method:	FCC part 2.1053
Limit:	Less than -13dBm
Test setup:	<p>Below 1GHz</p>  <p>Above 1GHz</p>  <p>Substituted method:</p> 
Test Procedure:	<ol style="list-style-type: none"> 1. The EUT was placed on a non-conductive turntable using a non-conductive support. The radiated emission at the fundamental frequency was measured at 3 m with a test antenna and EMI spectrum analyser. 2. During the tests, the antenna height and the EUT azimuth were varied in order to identify the maximum level of emissions from the EUT. This maximization process was repeated with the EUT positioned in each of its three orthogonal orientations. 3. The frequency range up to tenth harmonic was investigated for each of three fundamental frequency (low, middle and high channels). Once spurious emission was identified, the power of the emission was determined using the substitution method.

	<p>4. The spurious emissions attenuation was calculated as the difference between radiated power at the fundamental frequency and the spurious emissions frequency.</p> $\text{ERP / EIRP} = \text{S.G. output (dBm)} + \text{Antenna Gain(dB/dBi)} - \text{Cable Loss (dB)}$
Test Uncertainty:	± 4.88 dB
Test Instruments:	Refer to section 5.8 for details
Test mode:	Refer to section 5.3 for details.
Test results:	Passed
Remark:	During the test, pre-scan the QPSK, 64QAM modulation, and found the QPSK modulation is the worst case.

Measurement Data (worst case):

10MHz for QPSK				
Frequency (MHz)	Spurious Emission		Limit (dBm)	Result
	Polarization	Level (dBm)		
Lowest				
33.92	Vertical	-56.62	-13	Pass
135.51	V	-48.58		
7310.00	V	-42.59		
10965.00	V	-37.26		
176.89	Horizontal	-41.12		
222.95	H	-53.57		
7310.00	H	-37.20		
10965.00	H	-36.66		
Middle				
33.92	Vertical	-57.24	-13	Pass
135.51	V	-47.22		
7350.00	V	-42.60		
11025.00	V	-37.16		
176.89	Horizontal	-42.30		
222.95	H	-53.75		
7350.00	H	-41.83		
11025.00	H	-36.85		
Highest				
33.92	Vertical	-56.39	-13	Pass
135.51	V	-47.92		
7390.00	V	-41.25		
11085.00	V	-37.82		
176.89	Horizontal	-42.07		
222.95	H	-54.17		
7390.00	H	-38.52		
11085.00	H	-37.27		

20MHz for QPSK				
Frequency (MHz)	Spurious Emission		Limit (dBm)	Result
	Polarization	Level (dBm)		
Lowest				
33.92	Vertical	-56.33	-13	Pass
135.51	V	-49.25		
7320.00	V	-42.91		
10980.00	V	-37.74		
176.89	Horizontal	-42.25		
222.95	H	-53.74		
7320.00	H	-43.04		
10980.00	H	-37.83		
Middle				
33.92	Vertical	-57.41	-13	Pass
135.51	V	-47.83		
7350.00	V	-42.68		
11025.00	V	-38.31		
176.89	Horizontal	-42.51		
222.95	H	-52.27		
7350.00	H	-42.76		
11025.00	H	-38.36		
Highest				
33.92	Vertical	-55.93	-13	Pass
135.51	V	-48.69		
7380.00	V	-41.41		
11070.00	V	-38.28		
176.89	Horizontal	-41.23		
222.95	H	-54.54		
7380.00	H	-42.17		
11070.00	H	-38.33		

6.10 Frequency stability V.S. Temperature measurement

Test Requirement:	FCC Part 90.213(a)																																																																										
Test Method:	FCC Part 2.1055(a)(1)(b)																																																																										
Limit:	<table border="1"> <thead> <tr> <th rowspan="2">Frequency range (MHz)</th> <th rowspan="2">Fixed and base stations (±ppm)</th> <th colspan="2">Mobile stations (±ppm)</th> </tr> <tr> <th>Over 2 watts output power</th> <th>2 watts or less output power</th> </tr> </thead> <tbody> <tr><td>Below 25</td><td>100</td><td>100</td><td>200</td></tr> <tr><td>25-50</td><td>20</td><td>20</td><td>50</td></tr> <tr><td>72-76</td><td>5</td><td></td><td>50</td></tr> <tr><td>150-174</td><td>5</td><td>5</td><td>50</td></tr> <tr><td>216-220</td><td>1.0</td><td></td><td>1.0</td></tr> <tr><td>220-222</td><td>0.1</td><td>1.5</td><td>1.5</td></tr> <tr><td>421-512</td><td>2.5</td><td>5</td><td>5</td></tr> <tr><td>806-809</td><td>1.0</td><td>1.5</td><td>1.5</td></tr> <tr><td>809-824</td><td>1.5</td><td>2.5</td><td>2.5</td></tr> <tr><td>851-854</td><td>1.0</td><td>1.5</td><td>1.5</td></tr> <tr><td>854-869</td><td>1.5</td><td>2.5</td><td>2.5</td></tr> <tr><td>896-901</td><td>0.1</td><td>1.5</td><td>1.5</td></tr> <tr><td>902-928</td><td>2.5</td><td>2.5</td><td>2.5</td></tr> <tr><td>929-930</td><td>1.5</td><td></td><td></td></tr> <tr><td>935-940</td><td>0.1</td><td>1.5</td><td>1.5</td></tr> <tr><td>1427-1435</td><td>300</td><td>300</td><td>300</td></tr> <tr><td>Above 2450</td><td></td><td></td><td></td></tr> </tbody> </table>	Frequency range (MHz)	Fixed and base stations (±ppm)	Mobile stations (±ppm)		Over 2 watts output power	2 watts or less output power	Below 25	100	100	200	25-50	20	20	50	72-76	5		50	150-174	5	5	50	216-220	1.0		1.0	220-222	0.1	1.5	1.5	421-512	2.5	5	5	806-809	1.0	1.5	1.5	809-824	1.5	2.5	2.5	851-854	1.0	1.5	1.5	854-869	1.5	2.5	2.5	896-901	0.1	1.5	1.5	902-928	2.5	2.5	2.5	929-930	1.5			935-940	0.1	1.5	1.5	1427-1435	300	300	300	Above 2450			
Frequency range (MHz)	Fixed and base stations (±ppm)			Mobile stations (±ppm)																																																																							
		Over 2 watts output power	2 watts or less output power																																																																								
Below 25	100	100	200																																																																								
25-50	20	20	50																																																																								
72-76	5		50																																																																								
150-174	5	5	50																																																																								
216-220	1.0		1.0																																																																								
220-222	0.1	1.5	1.5																																																																								
421-512	2.5	5	5																																																																								
806-809	1.0	1.5	1.5																																																																								
809-824	1.5	2.5	2.5																																																																								
851-854	1.0	1.5	1.5																																																																								
854-869	1.5	2.5	2.5																																																																								
896-901	0.1	1.5	1.5																																																																								
902-928	2.5	2.5	2.5																																																																								
929-930	1.5																																																																										
935-940	0.1	1.5	1.5																																																																								
1427-1435	300	300	300																																																																								
Above 2450																																																																											
Test setup:	<p style="text-align: center;">Note : Measurement setup for testing on Antenna connector</p>																																																																										
Test procedure:	<ol style="list-style-type: none"> 1. The equipment under test was connected to an external DC power supply and input rated voltage. 2. RF output was connected to a frequency counter or spectrum analyzer via feed through attenuators. 3. The EUT was placed inside the temperature chamber. 4. Set the spectrum analyzer RBW low enough to obtain the desired frequency resolution and measure EUT 25 operating frequency as reference frequency. 5. Turn EUT off and set the chamber temperature to -30. After the temperature stabilized for approximately 30 minutes recorded the frequency. 6. Repeat step measure with 10 increased per stage until the highest temperature of +50 reached 																																																																										
Test Instruments:	Refer to section 5.8 for details																																																																										
Test mode:	Refer to section 5.3 for details																																																																										
Test results:	Passed																																																																										
Remark:	All three channels of all modulations have been tested, but only the worst channel and the worst modulation show in this test item.																																																																										

Measurement Data (the worst channel):

Chain 0:

Reference Frequency: Lowest channel=3655MHz(10MHz for QPSK)			
Power supplied (Vdc)	Temperature ()	Frequency error	
		Hz	ppm
48.00	-35	162	0.044323
	-20	124	0.033926
	-10	105	0.028728
	0	123	0.033653
	10	130	0.035568
	20	133	0.036389
	30	107	0.029275
	40	145	0.039672
	55	139	0.038030
Reference Frequency: Lowest channel=3660MHz(20MHz for QPSK)			
Power supplied (Vdc)	Temperature ()	Frequency error	
		Hz	ppm
48.00	-35	154	0.042134
	-20	126	0.034473
	-10	104	0.028454
	0	135	0.036936
	10	147	0.040219
	20	108	0.029549
	30	126	0.034473
	40	128	0.035021
	55	150	0.041040

Chain 1:

Reference Frequency: Lowest channel=3655MHz(10MHz for QPSK)			
Power supplied (Vdc)	Temperature ()	Frequency error	
		Hz	ppm
48.00	-35	159	0.043502
	-20	127	0.034747
	-10	110	0.030096
	0	126	0.034473
	10	129	0.035294
	20	130	0.035568
	30	111	0.030369
	40	147	0.040219
	55	140	0.038304
Reference Frequency: Lowest channel=3660MHz(20MHz for QPSK)			
Power supplied (Vdc)	Temperature ()	Frequency error	
		Hz	ppm
48.00	-35	150	0.041040
	-20	122	0.033379
	-10	111	0.030369
	0	139	0.038030
	10	144	0.039398
	20	112	0.030643
	30	123	0.033652
	40	124	0.033926
	55	153	0.041860

6.11 Frequency stability V.S. Voltage measurement

Test Requirement:	FCC Part 90.213(a)																																																																														
Test Method:	FCC Part 2.1055(a)(1)(b)																																																																														
Limit:	<table border="1"> <thead> <tr> <th rowspan="2">Frequency range (MHz)</th> <th rowspan="2">Fixed and base stations (±ppm)</th> <th colspan="2">Mobile stations (±ppm)</th> </tr> <tr> <th>Over 2 watts output power</th> <th>2 watts or less output power</th> </tr> </thead> <tbody> <tr><td>Below 25</td><td>100</td><td>100</td><td>200</td></tr> <tr><td>25-50</td><td>20</td><td>20</td><td>50</td></tr> <tr><td>72-76</td><td>5</td><td></td><td>50</td></tr> <tr><td>150-174</td><td>5</td><td>5</td><td>50</td></tr> <tr><td>216-220</td><td>1.0</td><td></td><td>1.0</td></tr> <tr><td>220-222</td><td>0.1</td><td>1.5</td><td>1.5</td></tr> <tr><td>421-512</td><td>2.5</td><td>5</td><td>5</td></tr> <tr><td>806-809</td><td>1.0</td><td>1.5</td><td>1.5</td></tr> <tr><td>809-824</td><td>1.5</td><td>2.5</td><td>2.5</td></tr> <tr><td>851-854</td><td>1.0</td><td>1.5</td><td>1.5</td></tr> <tr><td>854-869</td><td>1.5</td><td>2.5</td><td>2.5</td></tr> <tr><td>896-901</td><td>0.1</td><td>1.5</td><td>1.5</td></tr> <tr><td>902-928</td><td>2.5</td><td>2.5</td><td>2.5</td></tr> <tr><td>902-928</td><td>2.5</td><td>2.5</td><td>2.5</td></tr> <tr><td>929-930</td><td>1.5</td><td></td><td></td></tr> <tr><td>935-940</td><td>0.1</td><td>1.5</td><td>1.5</td></tr> <tr><td>1427-1435</td><td>300</td><td>300</td><td>300</td></tr> <tr><td>Above 2450</td><td></td><td></td><td></td></tr> </tbody> </table>	Frequency range (MHz)	Fixed and base stations (±ppm)	Mobile stations (±ppm)		Over 2 watts output power	2 watts or less output power	Below 25	100	100	200	25-50	20	20	50	72-76	5		50	150-174	5	5	50	216-220	1.0		1.0	220-222	0.1	1.5	1.5	421-512	2.5	5	5	806-809	1.0	1.5	1.5	809-824	1.5	2.5	2.5	851-854	1.0	1.5	1.5	854-869	1.5	2.5	2.5	896-901	0.1	1.5	1.5	902-928	2.5	2.5	2.5	902-928	2.5	2.5	2.5	929-930	1.5			935-940	0.1	1.5	1.5	1427-1435	300	300	300	Above 2450			
Frequency range (MHz)	Fixed and base stations (±ppm)			Mobile stations (±ppm)																																																																											
		Over 2 watts output power	2 watts or less output power																																																																												
Below 25	100	100	200																																																																												
25-50	20	20	50																																																																												
72-76	5		50																																																																												
150-174	5	5	50																																																																												
216-220	1.0		1.0																																																																												
220-222	0.1	1.5	1.5																																																																												
421-512	2.5	5	5																																																																												
806-809	1.0	1.5	1.5																																																																												
809-824	1.5	2.5	2.5																																																																												
851-854	1.0	1.5	1.5																																																																												
854-869	1.5	2.5	2.5																																																																												
896-901	0.1	1.5	1.5																																																																												
902-928	2.5	2.5	2.5																																																																												
902-928	2.5	2.5	2.5																																																																												
929-930	1.5																																																																														
935-940	0.1	1.5	1.5																																																																												
1427-1435	300	300	300																																																																												
Above 2450																																																																															
Test setup:	<p style="text-align: center;">Temperature Chamber</p> <p style="text-align: center;">Spectrum analyzer Att. EUT</p> <p style="text-align: center;">Variable Power Supply</p> <p>Note : Measurement setup for testing on Antenna connector</p>																																																																														
Test procedure:	<ol style="list-style-type: none"> 1. Set chamber temperature to 25 . Use a variable DC power source to power the EUT and set the voltage to rated voltage. 2. Set the spectrum analyzer RBW low enough to obtain the desired frequency resolution and recorded the frequency. 3. Reduce the input voltage to specify extreme voltage variation (+/- 15%) and endpoint, record the maximum frequency change. 																																																																														
Test Instruments:	Refer to section 5.8 for details																																																																														
Test mode:	Refer to section 5.3 for details, and all channels have been tested, only shows the worst channel data in this report.																																																																														
Test results:	Passed																																																																														
Remark:	All three channels of all modulations have been tested, but only the worst channel and the worst modulation show in this test item.																																																																														

Measurement Data (the worst channel):

Chain 0:

Reference Frequency: Lowest channel=3655MHz(10MHz for QPSK)			
Temperature ()	Power supplied (Vdc)	Frequency error	
		Hz	ppm
25	42	99	0.027086
	48	85	0.023256
	58	74	0.020246
Reference Frequency: Lowest channel=3660MHz(20MHz for QPSK)			
Temperature ()	Power supplied (Vdc)	Frequency error	
		Hz	ppm
25	42	86	0.023497
	48	85	0.023224
	58	59	0.016120

Chain 1:

Reference Frequency: Lowest channel=3655MHz(10MHz for QPSK)			
Temperature ()	Power supplied (Vdc)	Frequency error	
		Hz	ppm
25	42	102	0.027907
	48	91	0.024897
	58	73	0.019973
Reference Frequency: Lowest channel=3660MHz(20MHz for QPSK)			
Temperature ()	Power supplied (Vdc)	Frequency error	
		Hz	ppm
25	42	90	0.024590
	48	88	0.024044
	58	64	0.017486

7 Test Setup Photo

Radiated Spurious Emission

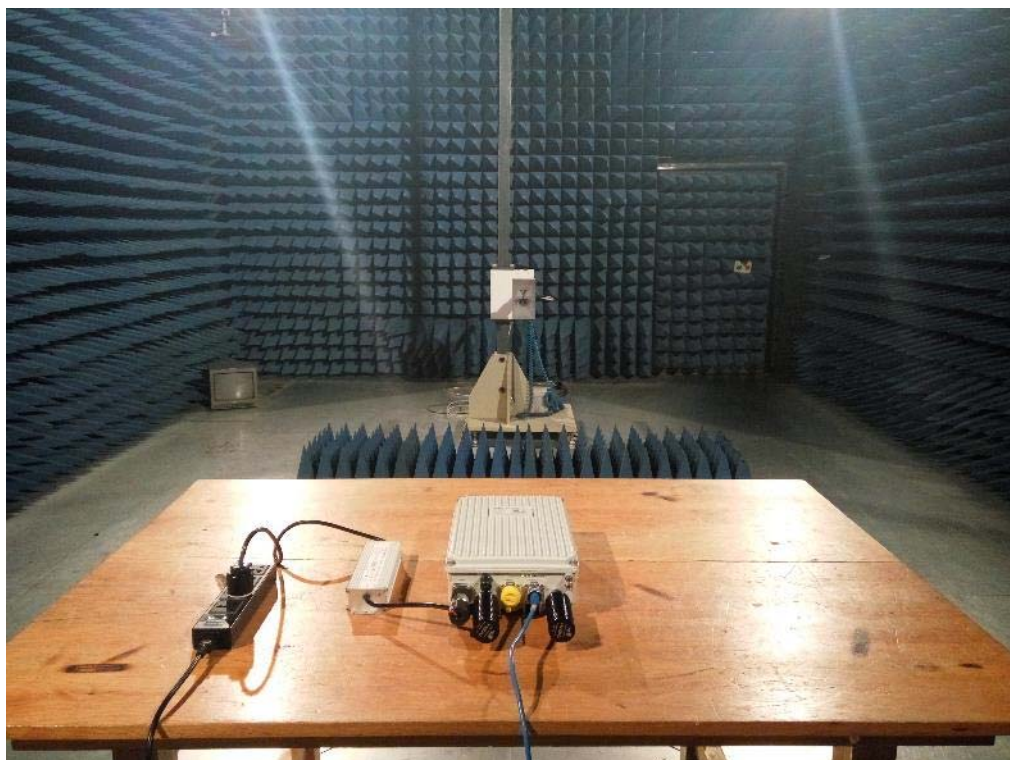
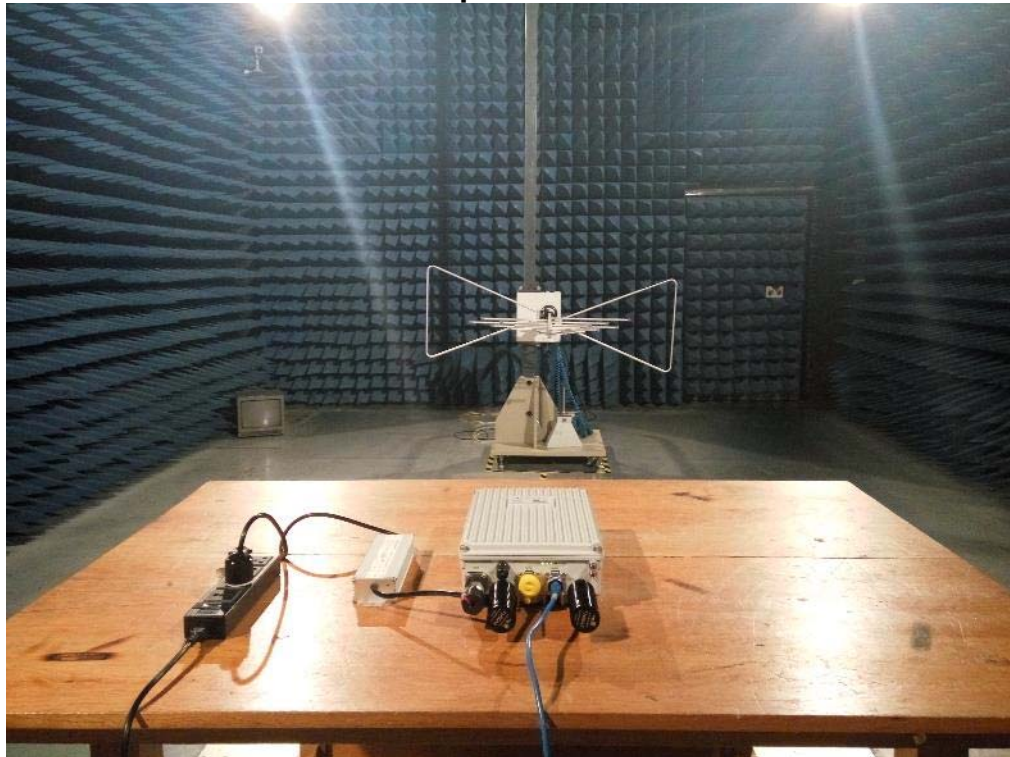

8 EUT Constructional Details

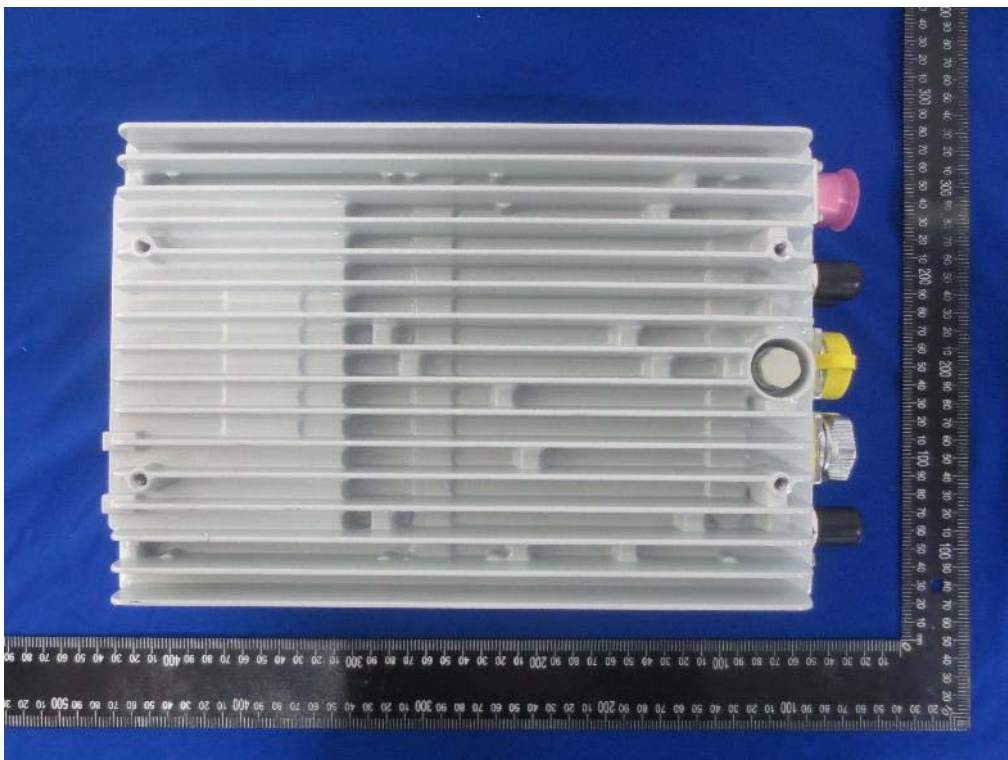







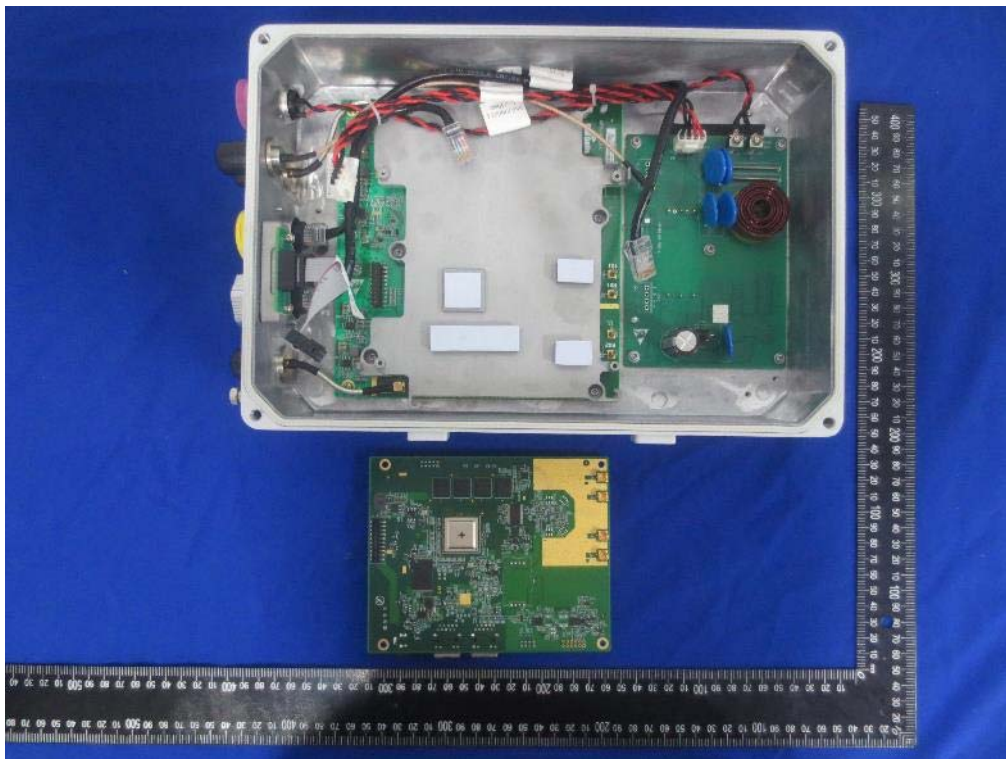
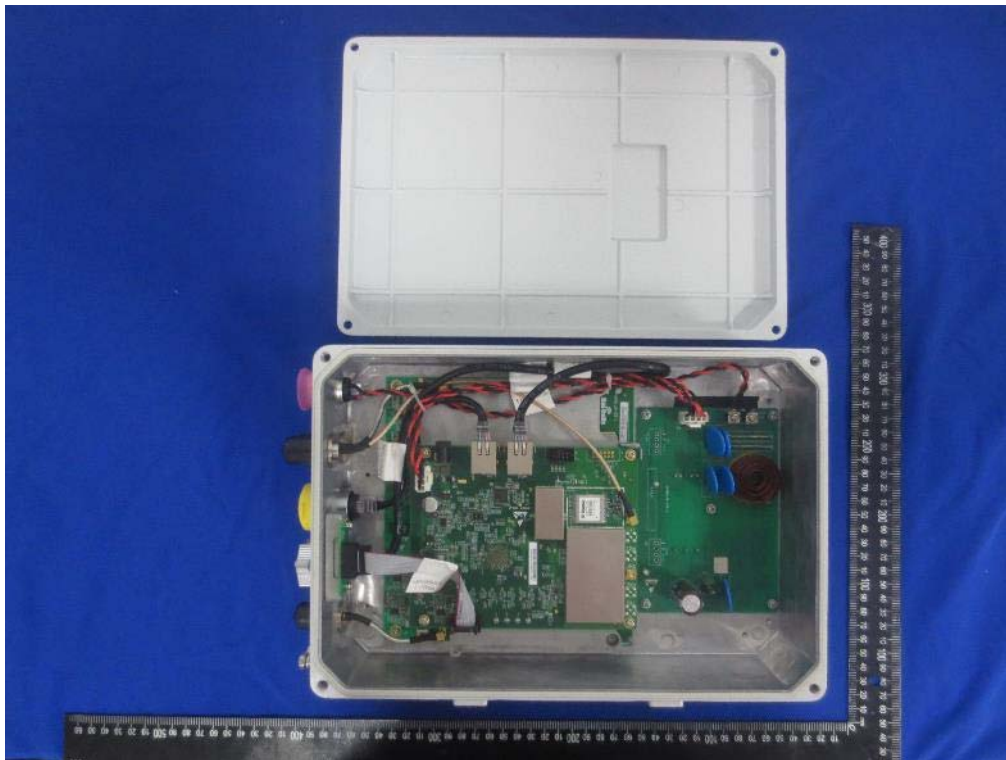

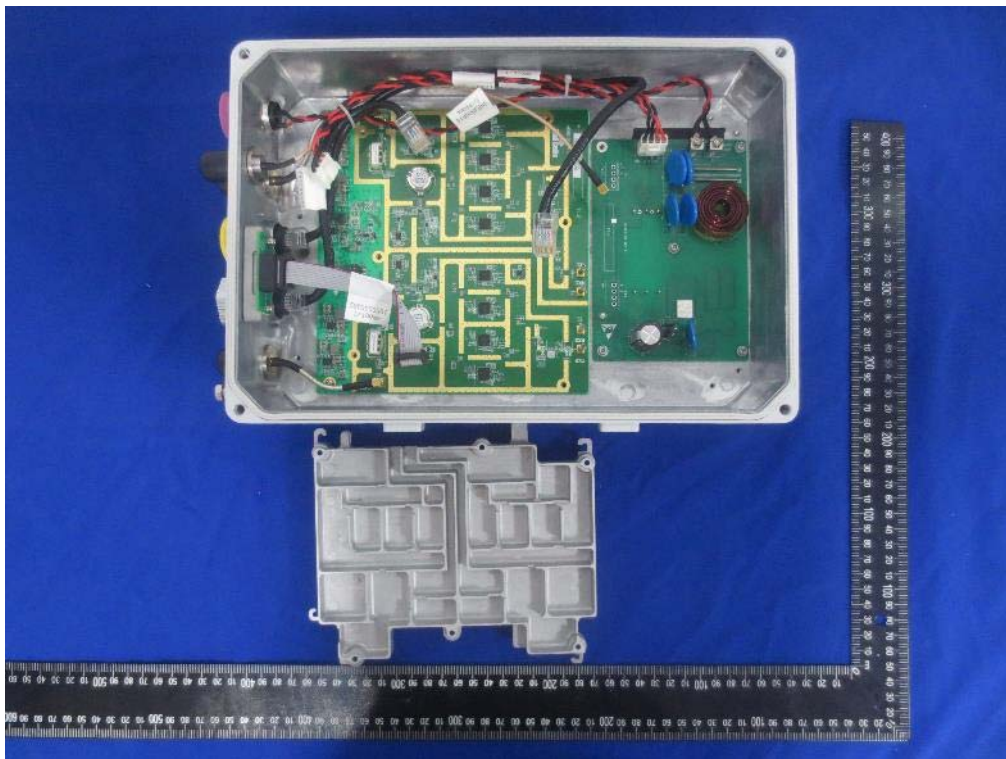
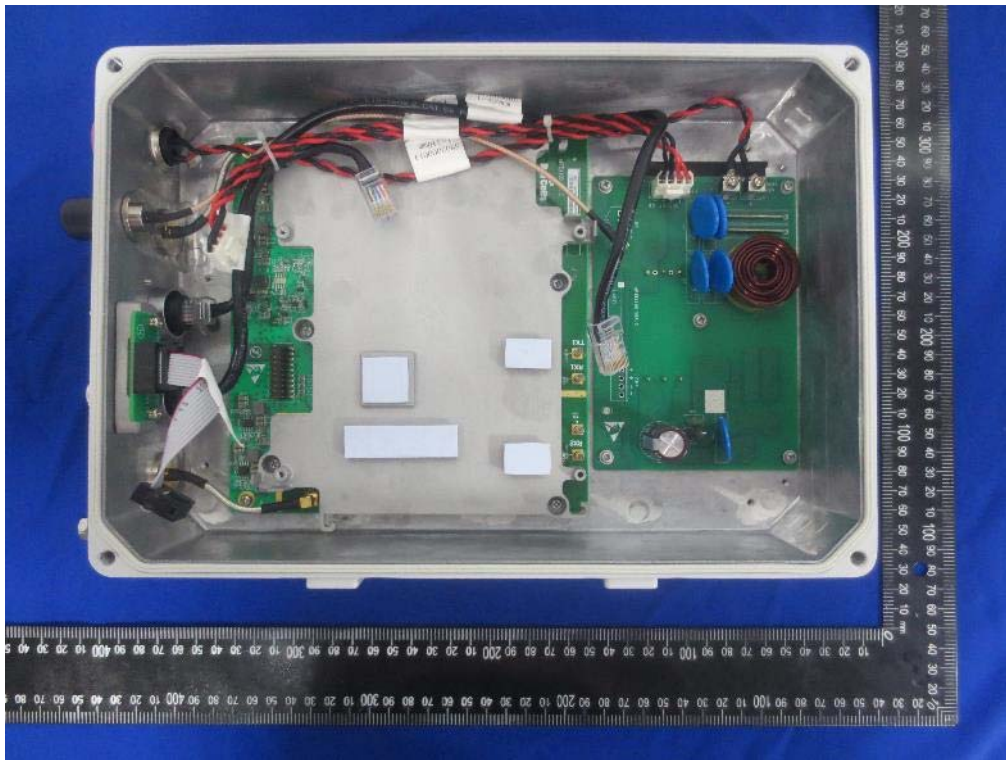

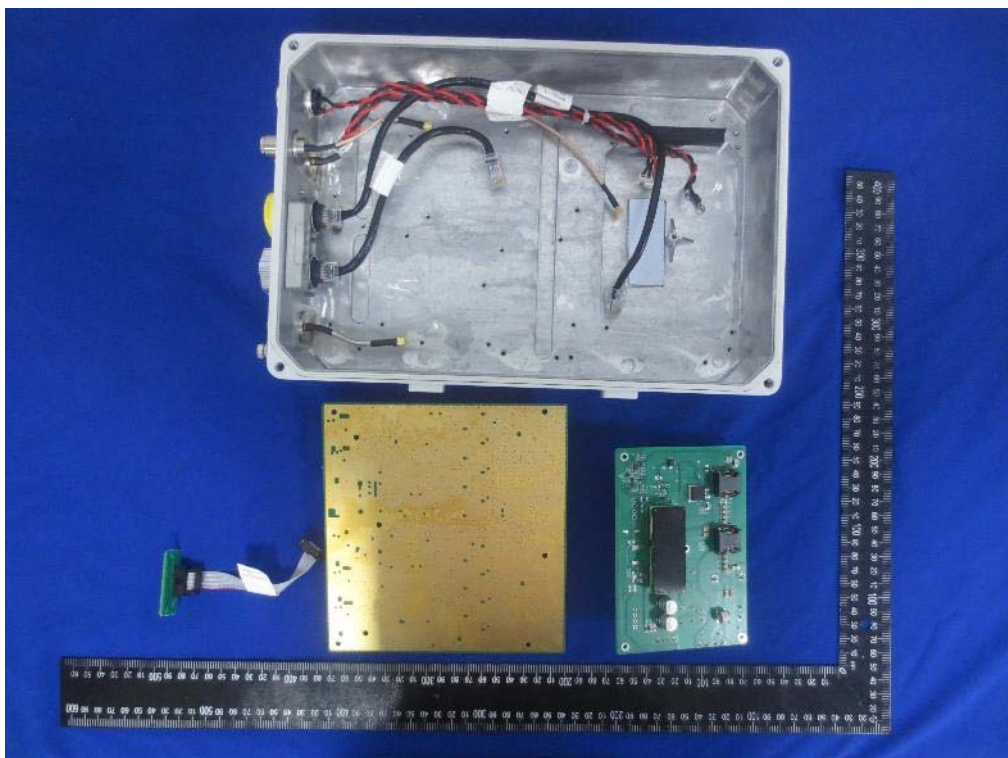



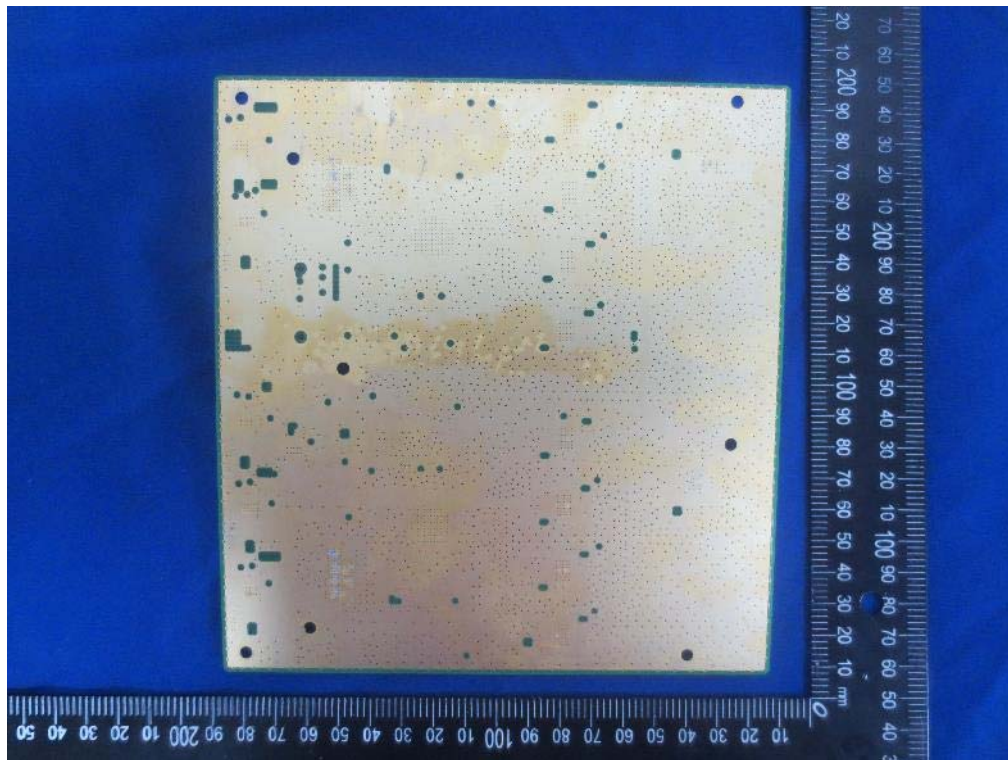
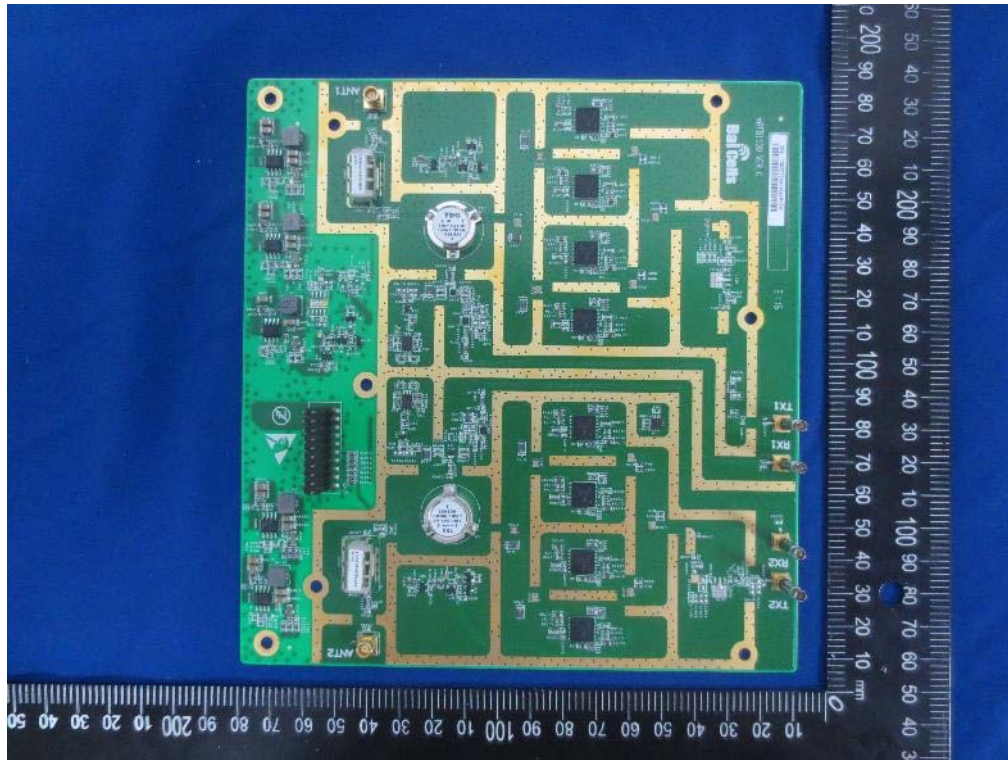

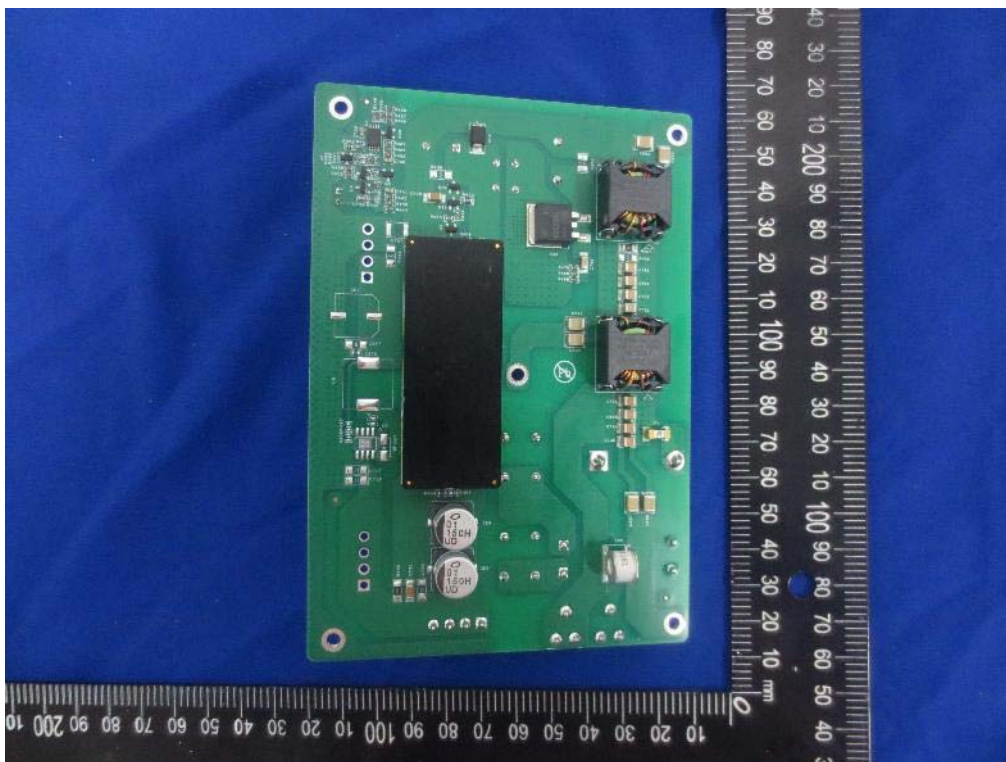
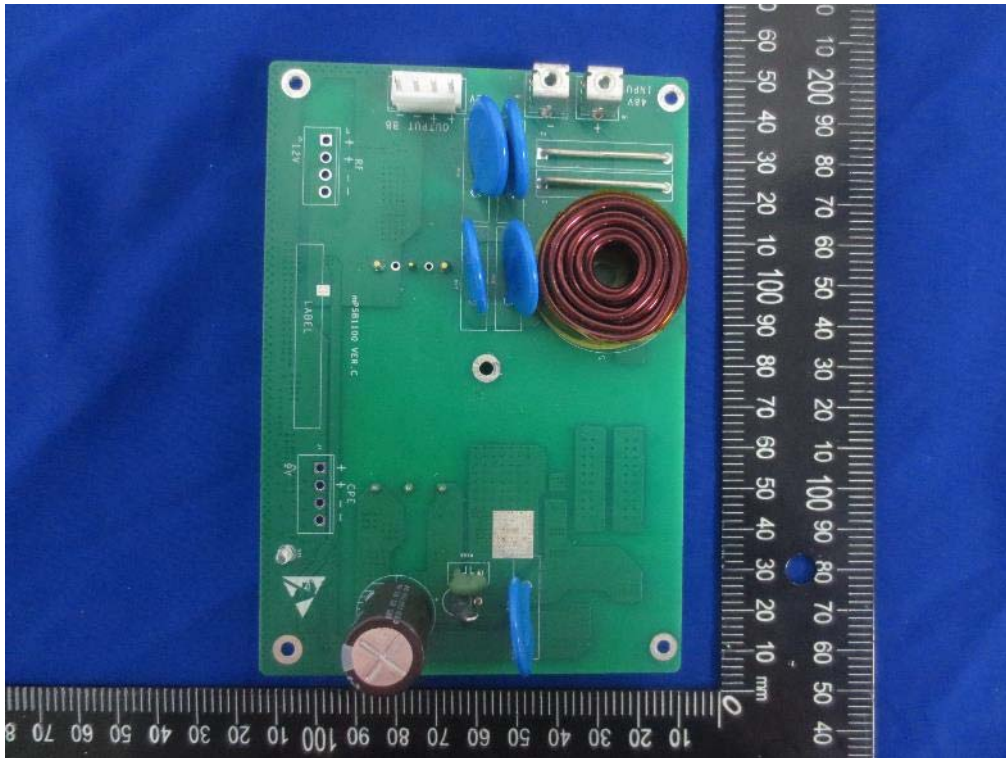

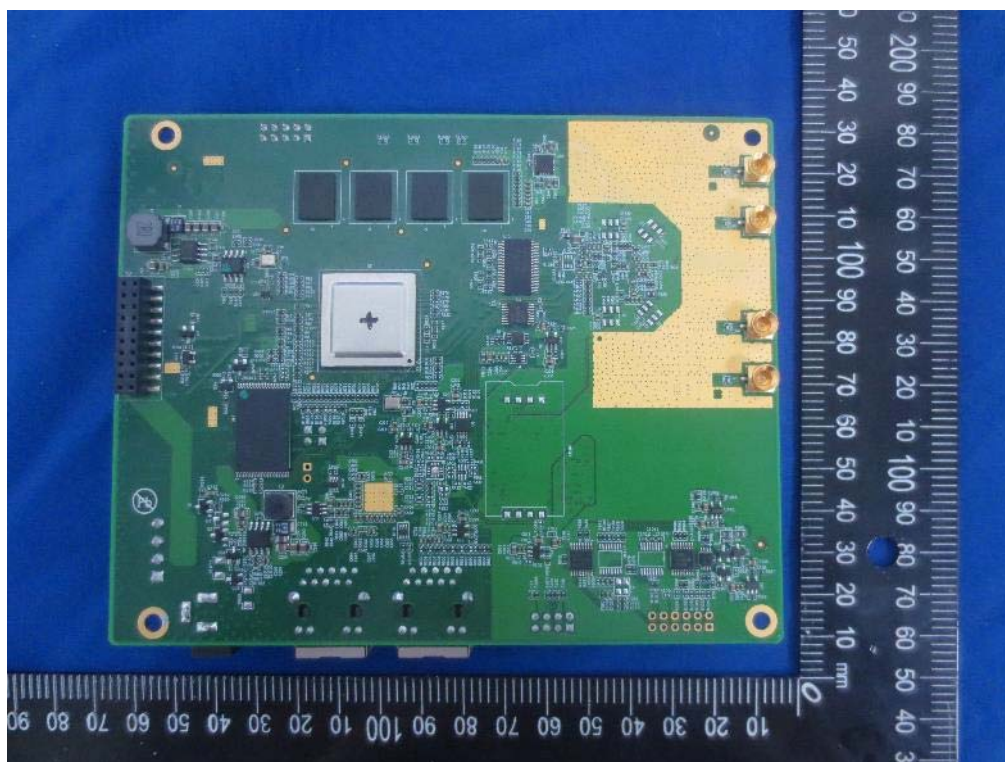

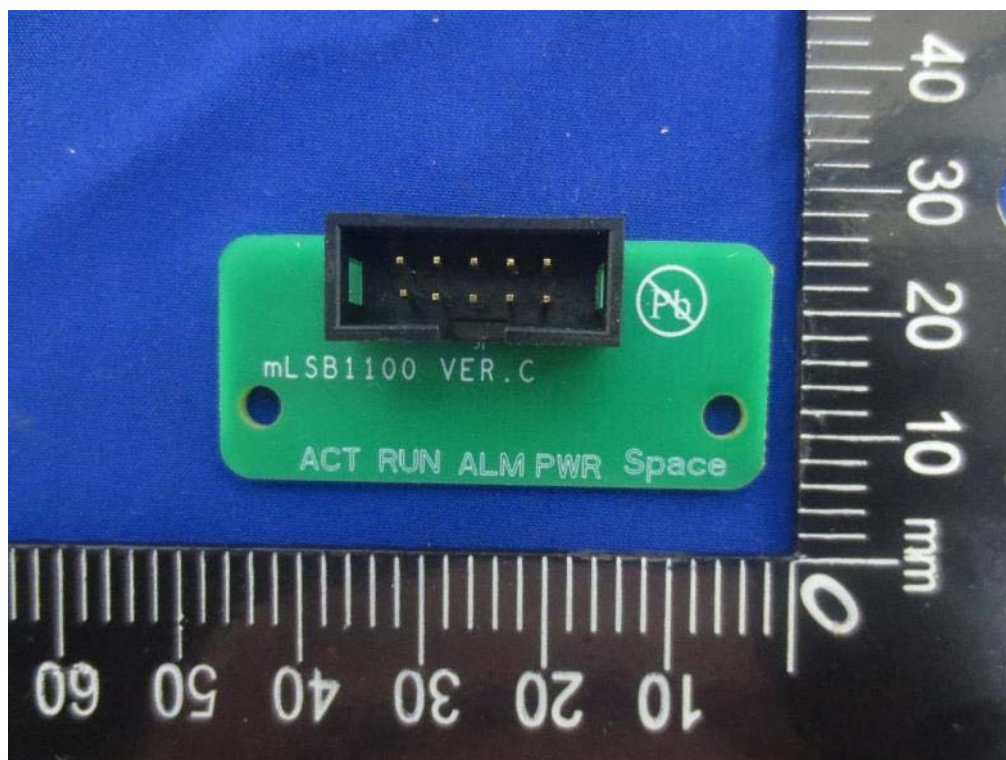

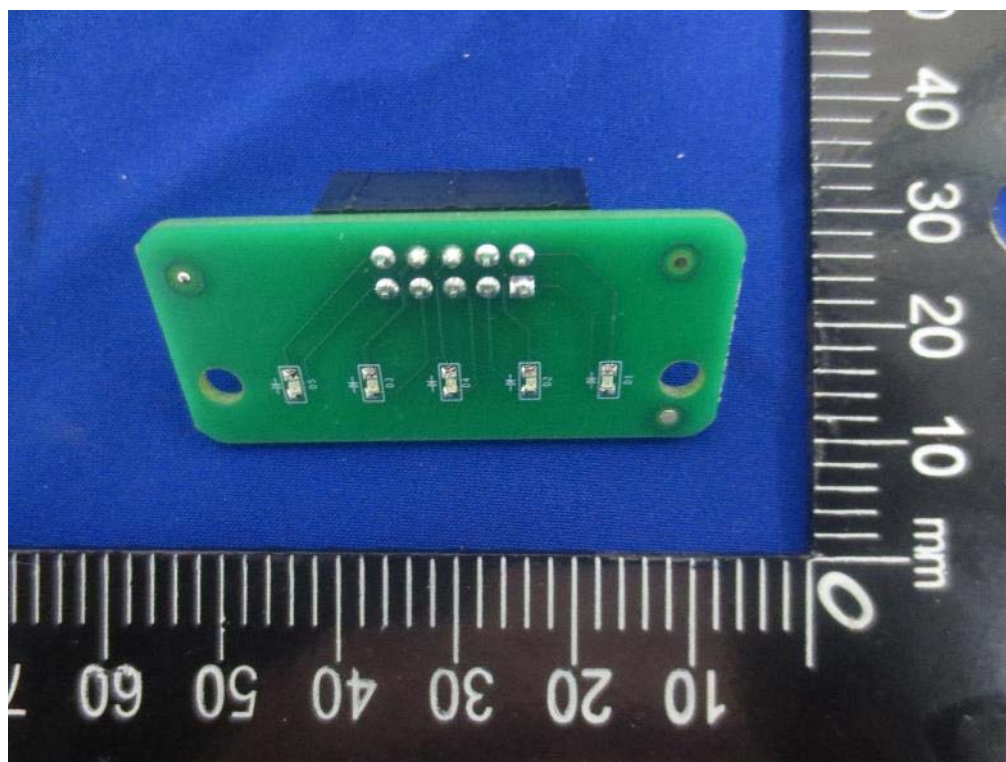

-----End of report-----