

FCC REPORT

Applicant: Baicells Technologies Co., Ltd.

Address of Applicant: 3F, Hui Yuan Development Building, No.1 Shangdi Information Industry Base, Haidian Dist., Beijing, China

Equipment Under Test (EUT)

Product Name: LTE Indoor CPE

Model No.: EG2011B

Trade mark: BaiCells

FCC ID: 2AG32EG2011B

Applicable standards: FCC CFR Title 47 Part 2
FCC CFR Title 47 Part 27 Subpart M

Date of sample receipt: 17 Jan., 2018

Date of Test: 17 Jan., to 15 Mar., 2018

Date of report issued: 16 Mar., 2018

Test Result: PASS*

* In the configuration tested, the EUT complied with the standards specified above.

Authorized Signature:



Bruce Zhang
Laboratory Manager

This report details the results of the testing carried out on one sample. The results contained in this test report do not relate to other samples of the same product and does not permit the use of the CCIS product certification mark. The manufacturer should ensure that all products in series production are in conformity with the product sample detailed in this report.

This report may only be reproduced and distributed in full. If the product in this report is used in any configuration other than that detailed in the report, the manufacturer must ensure the new system complies with all relevant standards.

This document cannot be reproduced except in full, without prior written approval of the Company. Any unauthorized alteration, forgery or falsification of the content or appearance of this document is unlawful and offenders may be prosecuted to the fullest extent of the law. Unless otherwise stated the results shown in this test report refer only to the sample(s) tested and such sample(s) are retained for 90 days only.

2. Version

Version No.	Date	Description
00	16 Mar., 2018	Original

Tested by:



Test Engineer

Date:

16 Mar., 2018

Reviewed by:



Project Engineer

Date:

16 Mar., 2018

3. Contents

Page

1.	COVER PAGE.....	1
2.	VERSION.....	2
3.	CONTENTS.....	3
4.	TEST SUMMARY.....	4
5.	GENERAL INFORMATION.....	5
5.1	CLIENT INFORMATION.....	5
5.2	GENERAL DESCRIPTION OF E.U.T.....	5
5.3	TEST ENVIRONMENT AND MODE.....	6
5.4	DESCRIPTION OF SUPPORT UNITS.....	6
5.5	MEASUREMENT UNCERTAINTY.....	6
5.6	RELATED SUBMITTAL(S) / GRANT (S).....	6
5.7	LABORATORY FACILITY.....	6
5.8	LABORATORY LOCATION.....	7
5.9	TEST INSTRUMENTS LIST.....	7
6.	TEST RESULTS.....	8
6.1	TRANSMIT OUTPUT POWER.....	8
6.2	PEAK-TO-AVERAGE RATIO.....	15
6.3	OCCUPY BANDWIDTH.....	17
6.4	OUT OF BAND EMISSION AT ANTENNA TERMINALS.....	35
6.5	FIELD STRENGTH OF SPURIOUS RADIATION MEASUREMENT.....	84
6.6	FREQUENCY STABILITY V.S. TEMPERATURE MEASUREMENT.....	88
6.7	FREQUENCY STABILITY V.S. VOLTAGE MEASUREMENT.....	93
7	TEST SETUP PHOTO.....	96
8	EUT CONSTRUCTIONAL DETAILS.....	97

4. Test Summary

Test Item	Section	Result
RF Output Power	Part 2.1046 Part 27.50 (h)(2)	Pass
Peak-to-Average Ratio	/	Pass
Modulation Characteristics	Part 2.1047	Pass
99% & -26 dB Occupied Bandwidth	Part 2.1049 Part 27.53(m)(6)	Pass
Spurious Emissions at Antenna Terminal	Part 2.1051 Part 27.53(m)(4)	Pass
Field Strength of Spurious Radiation	Part 2.1053 Part 27.53(m)(4)	Pass
Frequency stability vs. temperature	Part 2.1055(a)(1)(b) Part 27.54	Pass
Frequency stability vs. voltage	Part 2.1055(d)(1)(2) Part 27.54	Pass

5. General Information

5.1 Client Information

Applicant:	Baicells Technologies Co., Ltd.
Address:	3F, Hui Yuan Development Building, No.1 Shangdi Information Industry Base, Haidian Dist., Beijing, China
Manufacturer:	Baicells Technologies Co., Ltd.
Address:	3F, Hui Yuan Development Building, No.1 Shangdi Information Industry Base, Haidian Dist., Beijing, China

5.2 General Description of E.U.T.

Product Name:	LTE Indoor CPE
Model No.:	EG2011B
Operation Frequency range:	LTE Band41: 2496MHz~2690MHz
Modulation type:	BPSK, QPSK, 16QAM
Antenna type:	Internal antenna
Antenna gain:	5 dBi
Power supply:	DC 5V
AC adapter:	Model: ADS-25FSG-06 05015EPCU Input: AC100-240V, 50/60Hz, 0.7A Output: DC 5V, 3.0A

Test Channel:

5MHz		10MHz	
Channel:	Frequency (MHz)	Channel:	Frequency (MHz)
Lowest	2498.5	Lowest	2501.0
Middle	2593.0	Middle	2593.0
Highest	2687.5	Highest	2685.0
15MHz		20MHz	
Channel:	Frequency (MHz)	Channel:	Frequency (MHz)
Lowest	2503.5	Lowest	2506.0
Middle	2593.0	Middle	2593.0
Highest	2682.5	Highest	2680.0

5.3 Test environment and mode

Operating Environment:	
Temperature:	Normal: 15°C ~ 35°C, Extreme: -30°C ~ +50°C
Humidity:	20 % ~ 75 % RH
Atmospheric Pressure:	1008 mbar
Voltage:	Nominal: 120Vac, Extreme: Low 102Vac, High 138Vac
Test mode:	
BPSK mode	Keep the EUT communication with simulated station in BPSK mode
QPSK mode	Keep the EUT communication with simulated station in QPSK mode
16-QAM mode	Keep the EUT communication with simulated station in 16-QAM mode
Remark:	
<ol style="list-style-type: none"> The EUT has been tested under continuous transmitting mode. Channel Low, Mid and High for each type band with rated data rate were chosen for full testing. The field strength of spurious radiation emission was measured as EUT stand-up position (H mode) and lie down position (E1, E2 mode) for these modes with power adaptor, earphone and Data cable. Just the worst case position (H mode) shown in report. Pre-scan all modulation mode (BPSK, QPSK, 16QAM), and found the QPSK and 16QAM modulation mode are the worst case. So the worst case shown in report. 	

5.4 Description of Support Units

Test Equipment	Manufacturer	Model No.	Serial No.
/	/	/	/

5.5 Measurement Uncertainty

Parameters	Expanded Uncertainty
Radiated Emission (9kHz ~ 30MHz)	4.24 dB (k=2)
Radiated Emission (30MHz ~ 1000MHz)	4.35 dB (k=2)
Radiated Emission (1GHz ~ 18GHz)	4.44 dB (k=2)
Radiated Emission (18GHz ~ 26.5GHz)	4.56 dB (k=2)

5.6 Related Submittal(s) / Grant (s)

This is an original grant, no related submittals and grants.
--

5.7 Laboratory Facility

<p>The test facility is recognized, certified, or accredited by the following organizations:</p> <ul style="list-style-type: none"> FCC - Registration No.: 727551 Shenzhen Zhongjian Nanfang Testing Co., Ltd. has been accredited as a testing laboratory by FCC (Federal Communications Commission). The Registration No. is 727551. IC - Registration No.: 10106A-1 The 3m Semi-anechoic chamber of Shenzhen Zhongjian Nanfang Testing Co., Ltd. has been Registered by Certification and Engineering Bureau of Industry Canada for radio equipment testing with Registration No.: 10106A-1. CNAS - Registration No.: CNAS L6048 Shenzhen Zhongjian Nanfang Testing Co., Ltd. is accredited to ISO/IEC 17025:2005 General Requirements for the Competence of Testing and Calibration laboratories for the competence of testing. The Registration No. is CNAS L6048. A2LA - Registration No.: 4346.01 This laboratory is accredited in accordance with the recognized International Standard ISO/IEC 17025:2005 General requirements for the competence of testing and calibration laboratories. The test scope can be found as below link: https://portal.a2la.org/scopepdf/4346-01.pdf

5.8 Laboratory Location

Shenzhen Zhongjian Nanfang Testing Co., Ltd.
 Address: No. B-C, 1/F., Building 2, Laodong No.2 Industrial Park, Xixiang Road,
 Bao'an District, Shenzhen, Guangdong, China
 Tel: +86-755-23118282, Fax: +86-755-23116366
 Email: info@ccis-cb.com, Website: http://www.ccis-cb.com

5.9 Test Instruments list

Test Equipment	Manufacturer	Model No.	Serial No.	Cal. Date (mm-dd-yy)	Cal. Due date (mm-dd-yy)
3m SAC	SAEMC	9m*6m*6m	966	07-22-2017	07-21-2020
BiConiLog Antenna	SCHWARZBECK	VULB9163	497	02-25-2017	02-24-2018
				02-23-2018	02-22-2019
Biconical Antenna	SCHWARZBECK	VUBA9117	359	06-22-2017	06-21-2018
Horn Antenna	SCHWARZBECK	BBHA9120D	916	02-25-2017	02-24-2018
				02-23-2018	02-22-2019
Horn Antenna	SCHWARZBECK	BBHA9120D	1805	02-25-2017	02-24-2018
				02-23-2018	02-22-2019
EMI Test Software	AUDIX	E3	6.110919b	N/A	N/A
Pre-amplifier	HP	8447D	2944A09358	02-25-2017	02-24-2018
				02-23-2018	02-22-2019
Pre-amplifier	CD	PAP-1G18	11804	02-25-2017	02-24-2018
				02-23-2018	02-22-2019
Spectrum analyzer	Rohde & Schwarz	FSP30	101454	02-25-2017	02-24-2018
				02-23-2018	02-22-2019
EMI Test Receiver	Rohde & Schwarz	ESRP7	101070	02-25-2017	02-24-2018
				02-23-2018	02-22-2019
Spectrum Analyzer	Agilent	N9020A	MY50510123	10-29-2017	10-28-2018
Signal Generator	Rohde & Schwarz	SMX	835454/016	02-25-2017	02-24-2018
				02-23-2018	02-22-2019
Signal Generator	R&S	SMR20	1008100050	02-25-2017	02-24-2018
				02-23-2018	02-22-2019
RF Switch Unit	MWRFTTEST	MW200	N/A	N/A	N/A
Cable	ZDECL	Z108-NJ-NJ-81	1608458	02-25-2017	02-24-2018
				02-23-2018	02-22-2019
Cable	MICRO-COAX	MFR64639	K10742-5	02-25-2017	02-24-2018
				02-23-2018	02-22-2019
Cable	SUHNER	SUCOFLEX100	58193/4PE	02-25-2017	02-24-2018
				02-23-2018	02-22-2019
DC Power Supply	XinNuoEr	WYK-10020K	1409050110020	10-31-2017	10-30-2018
Temperature Humidity Chamber	HengPu	HPGDS-500	20140828008	09-24-2017	09-23-2018
Simulated Station	Rohde & Schwarz	CMW500	140493	06-24-2017	06-23-2018

6. Test Results

6.1 Transmit Output Power

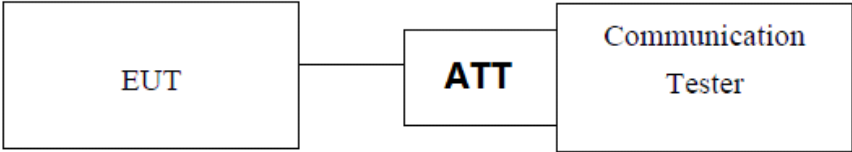
Test Requirement:	Part 27.50 (h)(2)
Test Method:	FCC Part 2.1046
Limit:	Mobile and other user stations. Mobile stations are limited to 2.0 watts EIRP. All user stations are limited to 2.0 watts transmitter output power.
Test setup:	 <p style="text-align: center;"><i>Note: Measurement setup for testing on Antenna connector</i></p>
Test Procedure:	The transmitter output was connected to a calibrated attenuator, the other end of which was connected to the simulated station. Transmitter output power was read off in dBm.
Test Instruments:	Refer to section 5.9 for details
Test mode:	Refer to section 5.3 for details
Test results:	Passed

measurement data:

Antenna port: ANT 0							
LTE Band	Bandwidth (MHz)	Modulation	RB Size	RB Offset	Average Power (dBm)		
					39675	40620	41565
					2498.5MHz	2593.0MHz	2687.5MHz
41	5	QPSK	1	0	22.32	22.22	22.15
			1	12	22.47	22.24	22.01
			1	24	22.34	22.06	21.40
			12	0	21.06	21.64	21.39
			12	6	21.05	21.40	21.07
			12	11	21.10	21.35	20.96
			25	0	21.13	21.49	21.19
		16QAM	1	0	20.75	21.44	21.30
			1	12	21.07	21.45	21.15
			1	24	20.95	21.28	20.96
			12	0	20.54	20.54	20.30
			12	6	20.58	20.40	20.11
			12	11	20.42	20.37	20.37
			25	0	20.16	20.49	20.24
LTE Band	Bandwidth (MHz)	Modulation	RB Size	RB Offset	Average Power (dBm)		
					39700	40620	41540
					2501.0MHz	2593.0MHz	2685.0MHz
41	10	QPSK	1	0	22.45	22.97	22.63
			1	24	22.68	22.93	22.46
			1	49	22.57	22.74	22.16
			25	0	21.68	21.76	21.70
			25	12	21.78	21.62	21.59
			25	24	21.78	21.58	21.49
			50	0	21.76	21.50	21.65
		16QAM	1	0	21.67	22.04	21.85
			1	24	21.63	22.08	21.56
			1	49	21.57	21.92	21.33
			25	0	20.63	21.01	20.67
			25	12	20.84	21.07	20.62
			25	24	20.83	21.13	20.48
			50	0	20.79	21.15	20.64

LTE Band	Bandwidth (MHz)	Modulation	RB Size	RB Offset	Average Power (dBm)		
					39725	40620	41515
					2503.5MHz	2593.0MHz	2682.5MHz
41	15	QPSK	1	0	22.42	22.90	22.59
			1	37	22.48	22.75	22.34
			1	74	22.42	22.51	22.24
			36	0	21.52	21.70	21.51
			36	16	21.43	21.81	21.54
			36	35	21.40	21.66	21.45
			75	0	21.57	21.95	21.68
		16QAM	1	0	21.68	22.11	21.98
			1	37	21.63	22.06	21.58
			1	74	21.69	21.73	21.44
			36	0	20.40	20.63	20.57
			36	16	20.53	20.87	20.49
			36	35	20.50	20.72	20.40
			75	0	20.58	21.00	20.63
LTE Band	Bandwidth (MHz)	Modulation	RB Size	RB Offset	Average Power (dBm)		
					39750	40620	41490
					2506.0MHz	2593.0MHz	2680.0MHz
41	20	QPSK	1	0	22.35	22.97	22.59
			1	49	22.45	22.83	22.46
			1	99	22.39	22.48	22.15
			50	0	21.88	22.05	21.83
			50	24	21.49	22.08	21.75
			50	49	21.40	21.73	21.64
			100	0	21.42	22.02	21.79
		16QAM	1	0	21.60	22.15	21.93
			1	49	21.60	22.23	21.74
			1	99	21.57	21.74	21.41
			50	0	20.76	21.00	20.76
			50	24	20.59	21.03	20.85
			50	49	20.48	20.66	20.62
			100	0	20.55	21.00	20.80

Antenna port: ANT 1							
LTE Band	Bandwidth (MHz)	Modulation	RB Size	RB Offset	Average Power (dBm)		
					39675	40620	41565
					2498.5MHz	2593.0MHz	2687.5MHz
41	5	QPSK	1	0	22.07	22.13	22.03
			1	12	22.14	22.04	22.04
			1	24	22.26	21.87	21.27
			12	0	21.30	21.52	21.16
			12	6	21.01	21.18	21.01
			12	11	20.98	21.20	20.74
			25	0	21.07	21.36	21.11
		16QAM	1	0	20.45	21.02	21.18
			1	12	21.03	21.39	21.04
			1	24	20.41	21.07	20.75
			12	0	20.22	20.34	20.37
			12	6	20.17	20.29	20.15
			12	11	20.48	20.20	20.21
			25	0	20.35	20.18	20.22
LTE Band	Bandwidth (MHz)	Modulation	RB Size	RB Offset	Average Power (dBm)		
					39700	40620	41540
					2501.0MHz	2593.0MHz	2685.0MHz
41	10	QPSK	1	0	22.14	22.34	22.41
			1	24	22.53	22.51	22.29
			1	49	22.41	22.16	22.10
			25	0	21.53	21.56	21.65
			25	12	21.49	21.73	21.34
			25	24	21.43	21.81	21.41
			50	0	21.52	21.83	21.53
		16QAM	1	0	21.14	22.31	21.49
			1	24	21.23	22.01	21.32
			1	49	21.27	21.85	21.17
			25	0	20.39	21.36	20.45
			25	12	20.41	21.03	20.33
			25	24	20.52	21.16	20.29
			50	0	20.47	21.12	20.42

LTE Band	Bandwidth (MHz)	Modulation	RB Size	RB Offset	Average Power (dBm)		
					39725	40620	41515
					2503.5MHz	2593.0MHz	2682.5MHz
41	15	QPSK	1	0	22.36	22.84	22.36
			1	37	22.17	22.75	22.17
			1	74	22.29	22.36	22.30
			36	0	21.47	21.61	21.42
			36	16	21.32	21.72	21.29
			36	35	21.20	21.43	21.37
			75	0	21.45	21.63	21.41
		16QAM	1	0	21.29	22.02	21.73
			1	37	21.47	21.88	21.46
			1	74	21.36	21.36	21.32
			36	0	20.45	20.17	20.45
			36	16	20.31	20.88	20.62
			36	35	20.49	20.25	20.21
			75	0	20.63	20.84	20.32
LTE Band	Bandwidth (MHz)	Modulation	RB Size	RB Offset	Average Power (dBm)		
					39750	40620	41490
					2506.0MHz	2593.0MHz	2680.0MHz
41	20	QPSK	1	0	22.13	22.87	22.34
			1	49	22.24	22.63	22.13
			1	99	22.21	22.27	22.07
			50	0	21.47	22.01	21.74
			50	24	21.26	21.89	21.65
			50	49	21.37	21.64	21.36
			100	0	21.29	21.71	21.52
		16QAM	1	0	21.54	22.03	21.37
			1	49	21.38	21.87	21.58
			1	99	21.43	21.60	21.16
			50	0	20.59	21.03	20.81
			50	24	20.43	20.25	20.76
			50	49	20.58	20.84	20.37
			100	0	20.36	20.69	20.51

MIMO EIRP Power:

LTE Band 41: 5MHz Bandwidth													
Modulation	RB Size	RB Offset	Test Channel	Antenna port	Conducted Power (dBm)	Total Conducted Power (dBm)	Antenna Gain (dBi)	Total EIRP (dBm)	EIRP Limit (dBm)				
QPSK	25	0	Lowest	ANT 0	21.13	24.11	8.00	32.11	33.00				
				ANT 1	21.07								
			Middle	ANT 0	21.49	24.44				8.00	32.44		
				ANT 1	21.36								
			Highest	ANT 0	21.19	24.16						8.00	32.15
				ANT 1	21.11								
16QAM	25	0	Lowest	ANT 0	20.16	23.27	8.00	31.27	33.00				
				ANT 1	20.35								
			Middle	ANT 0	20.49	23.35				8.00	31.35		
				ANT 1	20.18								
			Highest	ANT 0	20.24	23.24						8.00	31.24
				ANT 1	20.22								
LTE Band 41: 10MHz Bandwidth													
Modulation	RB Size	RB Offset	Test Channel	Antenna port	Conducted Power (dBm)	Total Conducted Power (dBm)	Antenna Gain (dBi)	Total EIRP (dBm)	EIRP Limit (dBm)				
QPSK	50	0	Lowest	ANT 0	21.76	24.65	8.00	32.65	33.00				
				ANT 1	21.52								
			Middle	ANT 0	21.50	24.68				8.00	32.68		
				ANT 1	21.83								
			Highest	ANT 0	21.62	24.59						8.00	32.59
				ANT 1	21.53								
16QAM	50	0	Lowest	ANT 0	20.79	23.64	8.00	31.64	33.00				
				ANT 1	20.47								
			Middle	ANT 0	21.15	24.15				8.00	32.15		
				ANT 1	21.12								
			Highest	ANT 0	20.64	23.54						8.00	31.54
				ANT 1	20.42								
<i>Remark: Directional gain = $G_{ANT} + 10 \log(N_{ANT})$ dBi = 5 dBi + 10 log(2) dBi = 8 dBi.</i>													

LTE Band 41: 15MHz Bandwidth													
Modulation	RB Size	RB Offset	Test Channel	Antenna port	Conducted Power (dBm)	Total Conducted Power (dBm)	Antenna Gain (dBi)	Total EIRP (dBm)	EIRP Limit (dBm)				
QPSK	75	0	Lowest	ANT 0	21.57	24.52	8.00	32.52	33.00				
				ANT 1	21.45								
			Middle	ANT 0	21.95	24.80				8.00	32.80		
				ANT 1	21.63								
			Highest	ANT 0	21.68	24.56						8.00	32.56
				ANT 1	21.41								
16QAM	75	0	Lowest	ANT 0	20.58	23.62	8.00	31.62	33.00				
				ANT 1	20.63								
			Middle	ANT 0	21.00	23.93				8.00	31.93		
				ANT 1	20.84								
			Highest	ANT 0	20.63	23.49						8.00	31.49
				ANT 1	20.32								
LTE Band 41: 20MHz Bandwidth													
Modulation	RB Size	RB Offset	Test Channel	Antenna port	Conducted Power (dBm)	Total Conducted Power (dBm)	Antenna Gain (dBi)	Total EIRP (dBm)	EIRP Limit (dBm)				
QPSK	100	0	Lowest	ANT 0	21.42	24.37	8.00	32.37	33.00				
				ANT 1	21.29								
			Middle	ANT 0	22.02	24.88				8.00	32.88		
				ANT 1	21.71								
			Highest	ANT 0	21.79	24.67						8.00	32.67
				ANT 1	21.52								
16QAM	100	0	Lowest	ANT 0	20.55	23.47	8.00	31.47	33.00				
				ANT 1	20.36								
			Middle	ANT 0	21.00	23.86				8.00	31.86		
				ANT 1	20.69								
			Highest	ANT 0	20.80	23.67						8.00	31.67
				ANT 1	20.51								

$Directional\ gain = G_{ANT} + 10\ log(N_{ANT})\ dBi = 5\ dBi + 10\ log(2)\ dBi = 8\ dBi.$

6.2 Peak-to-Average Ratio

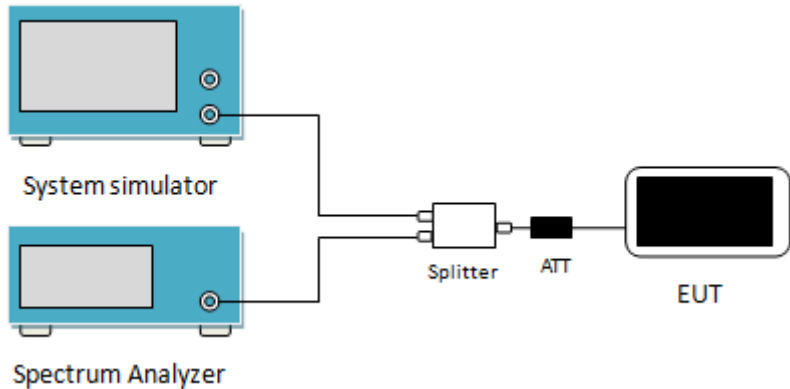
Test Requirement:	/
Test Method:	ANSI/TIA-603-D 2010
Limit:	The peak-to-average ratio (PAR) of the transmission may not exceed 13 dB.
Test Setup:	 <p>The diagram shows a test setup for measuring Peak-to-Average Ratio (PAR). It includes a System simulator, a Spectrum Analyzer, a Splitter, an ATT (Attenuator), and an EUT (Equipment Under Test). The System simulator and Spectrum Analyzer are connected to the Splitter. The Splitter is connected to the ATT, which is then connected to the EUT.</p>
Test Procedure:	<ol style="list-style-type: none"> 1 The RF output of the transceiver was connected to a spectrum analyzer through appropriate attenuation. 2 Set the CCDF option in spectrum analyzer, $RBW \geq OBW$, 3 Set the EUT working in highest power level, measured and recorded the 0.1% as PAPR level. 4 Repeat step 1~3 at other frequency and modulations.
Test Instruments:	Refer to section 5.9 for details
Test mode:	Refer to section 5.3 for details
Test results:	Passed

measurement data:

Bandwidth	Modulation	PAPR	
		ANT 0	ANT 1
20MHz	QPSK	4.32	5.16
	16QAM	5.07	4.78

test plots as below:

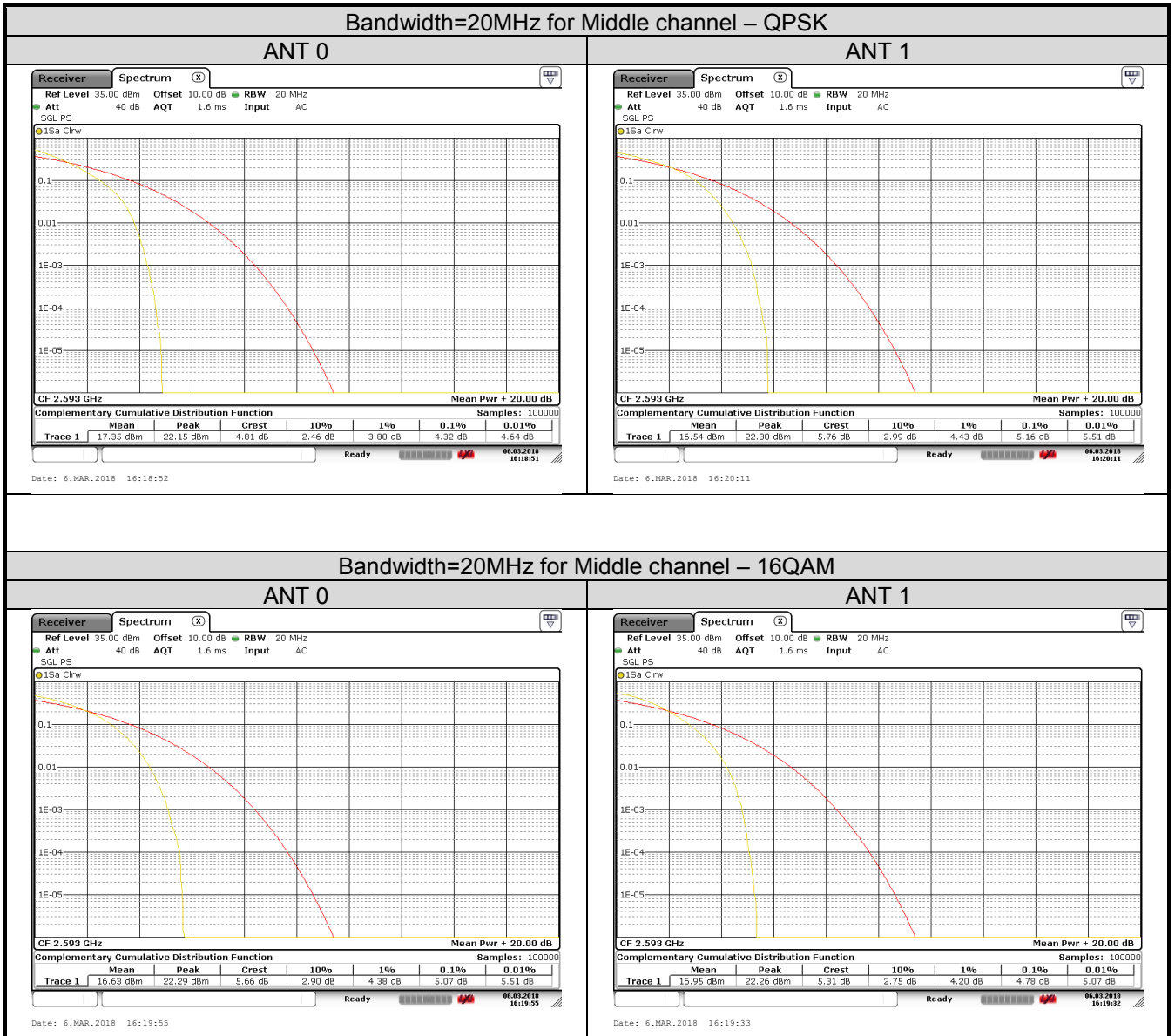

6.3 Occupy Bandwidth

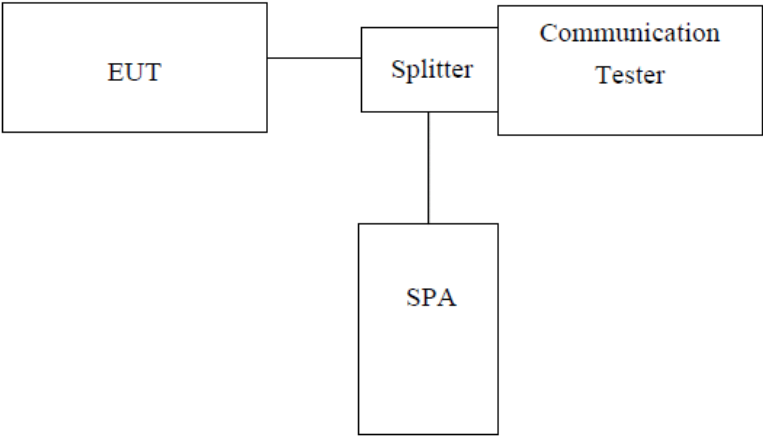
Test Requirement:	Part 27.53(m)(6)
Test Method:	ANSI/TIA-603-D 2010, FCC part 2.1049
Test setup:	 <p style="text-align: center;"><i>Note: Measurement setup for testing on Antenna connector</i></p>
Test Procedure:	<ol style="list-style-type: none"> 1. The EUT's output RF connector was connected with a short cable to the spectrum analyzer 2. The transmitter shall be operated at its maximum carrier power measured under normal test conditions. 3. The span of the analyzer shall be set to capture all products of the modulation process, including the emission skirts. 4. The resolution bandwidth (RBW) shall be in the range of 1% to 5% of the occupied bandwidth (OBW) and video bandwidth (VBW) shall be approximately 3x RBW.
Test Instruments:	Refer to section 5.9 for details
Test mode:	Refer to section 5.3 for details
Test results:	Passed

measurement data:

Test Channel	Bandwidth (MHz)	Modulation	Ant. Port	99% Occupy bandwidth (MHz)	26dB Occupy bandwidth (MHz)
Lowest	5	QPSK	Ant 0	4.52	5.32
			Ant 1	4.52	5.10
		16QAM	Ant 0	4.52	5.18
			Ant 1	4.52	5.10
Middle	5	QPSK	Ant 0	4.54	5.22
			Ant 1	4.52	5.20
		16QAM	Ant 0	4.52	5.20
			Ant 1	4.52	5.20
Highest	5	QPSK	Ant 0	4.52	5.02
			Ant 1	4.52	5.26
		16QAM	Ant 0	4.52	5.12
			Ant 1	4.52	5.22
Lowest	10	QPSK	Ant 0	9.16	10.32
			Ant 1	9.12	10.36
		16QAM	Ant 0	9.12	10.16
			Ant 1	9.08	10.32
Middle	10	QPSK	Ant 0	9.12	11.28
			Ant 1	9.12	10.36
		16QAM	Ant 0	9.12	10.60
			Ant 1	9.08	10.32
Highest	10	QPSK	Ant 0	9.12	10.24
			Ant 1	9.08	10.28
		16QAM	Ant 0	9.12	10.28
			Ant 1	9.12	10.40
Lowest	15	QPSK	Ant 0	13.56	14.94
			Ant 1	13.50	14.76
		16QAM	Ant 0	13.56	14.94
			Ant 1	13.50	14.76
Middle	15	QPSK	Ant 0	13.56	15.00
			Ant 1	13.56	14.70
		16QAM	Ant 0	13.56	15.36
			Ant 1	13.56	14.94
Highest	15	QPSK	Ant 0	13.56	14.88
			Ant 1	13.50	14.82
		16QAM	Ant 0	13.56	14.64
			Ant 1	13.56	14.88
Lowest	20	QPSK	Ant 0	18.00	19.44
			Ant 1	18.00	19.28
		16QAM	Ant 0	17.84	19.44
			Ant 1	17.84	19.28
Middle	20	QPSK	Ant 0	18.00	19.28
			Ant 1	17.92	19.36
		16QAM	Ant 0	17.92	19.36
			Ant 1	17.92	19.44
Highest	20	QPSK	Ant 0	17.92	19.44
			Ant 1	17.92	19.36
		16QAM	Ant 0	17.92	19.36
			Ant 1	18.00	19.36

test plot as follows:

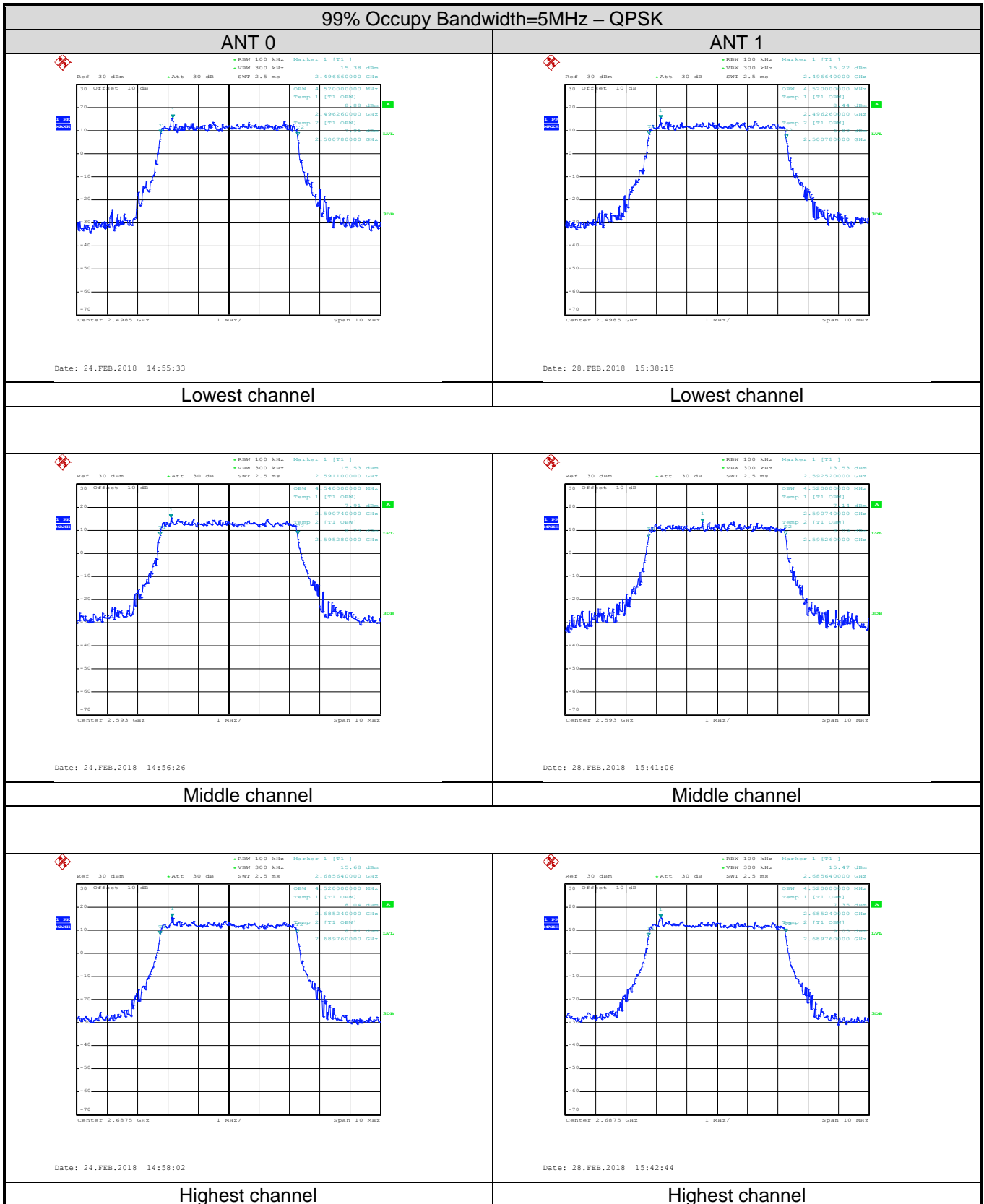

99% Occupy Bandwidth=5MHz – 16QAM

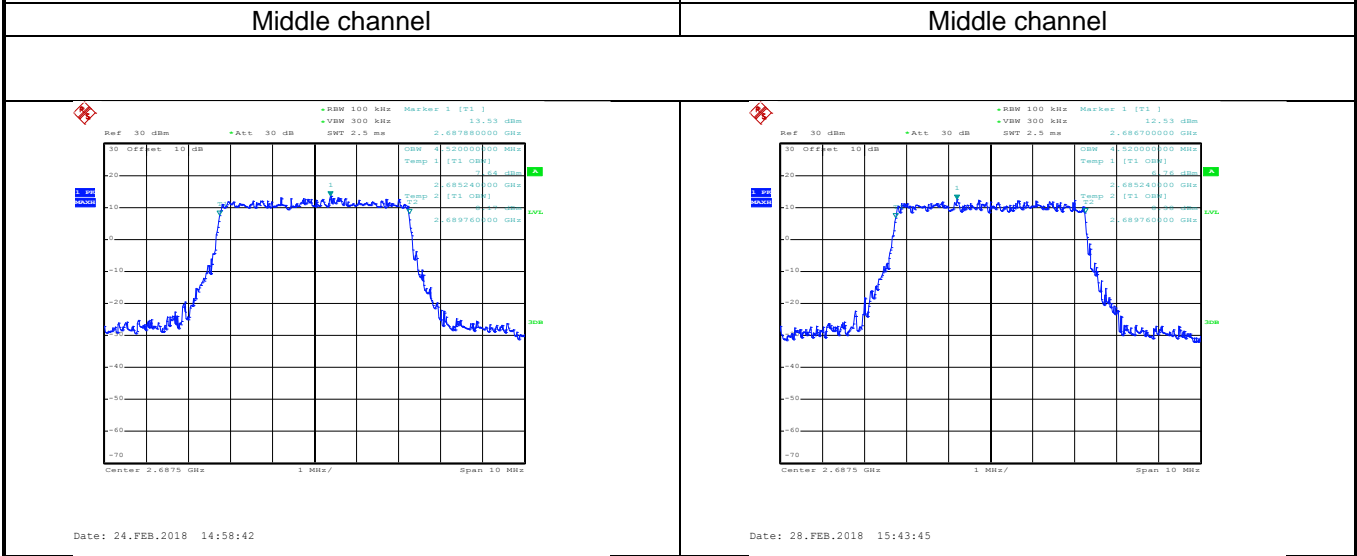
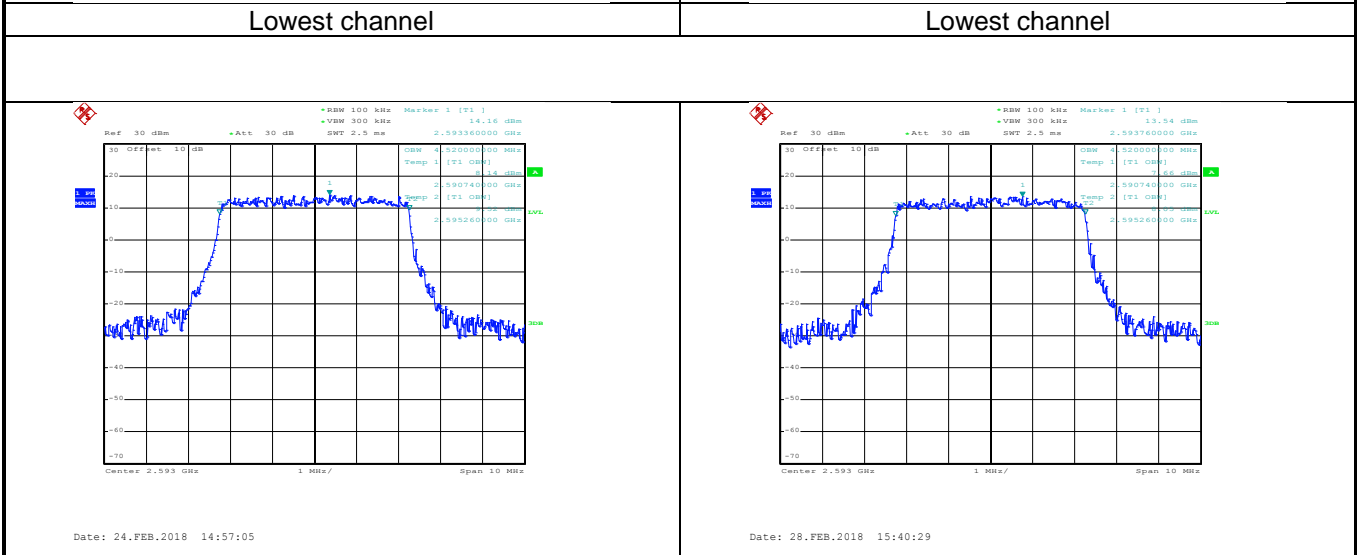
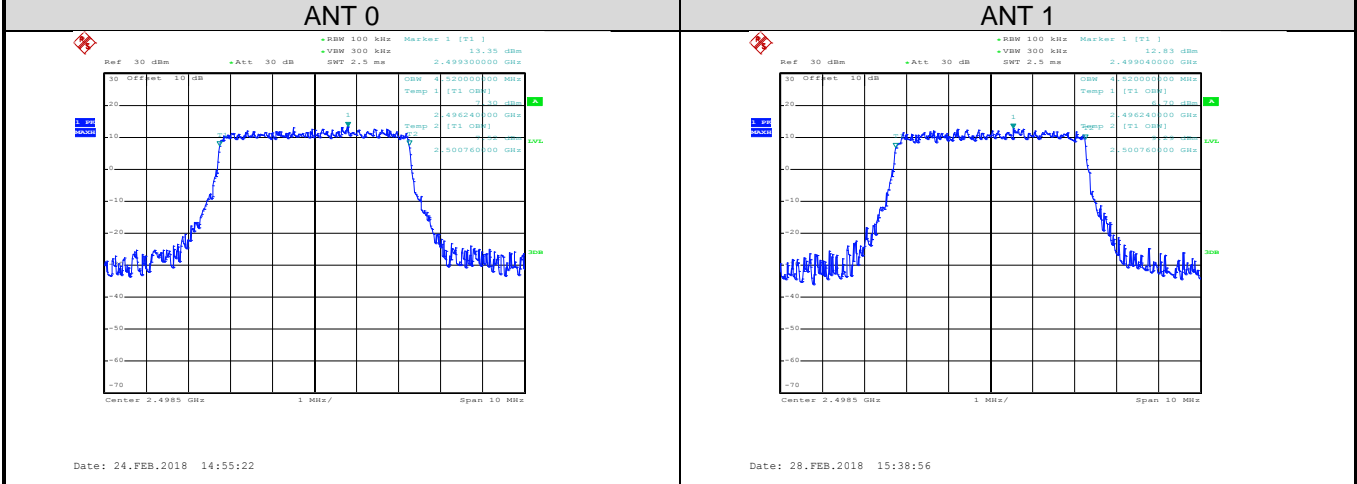

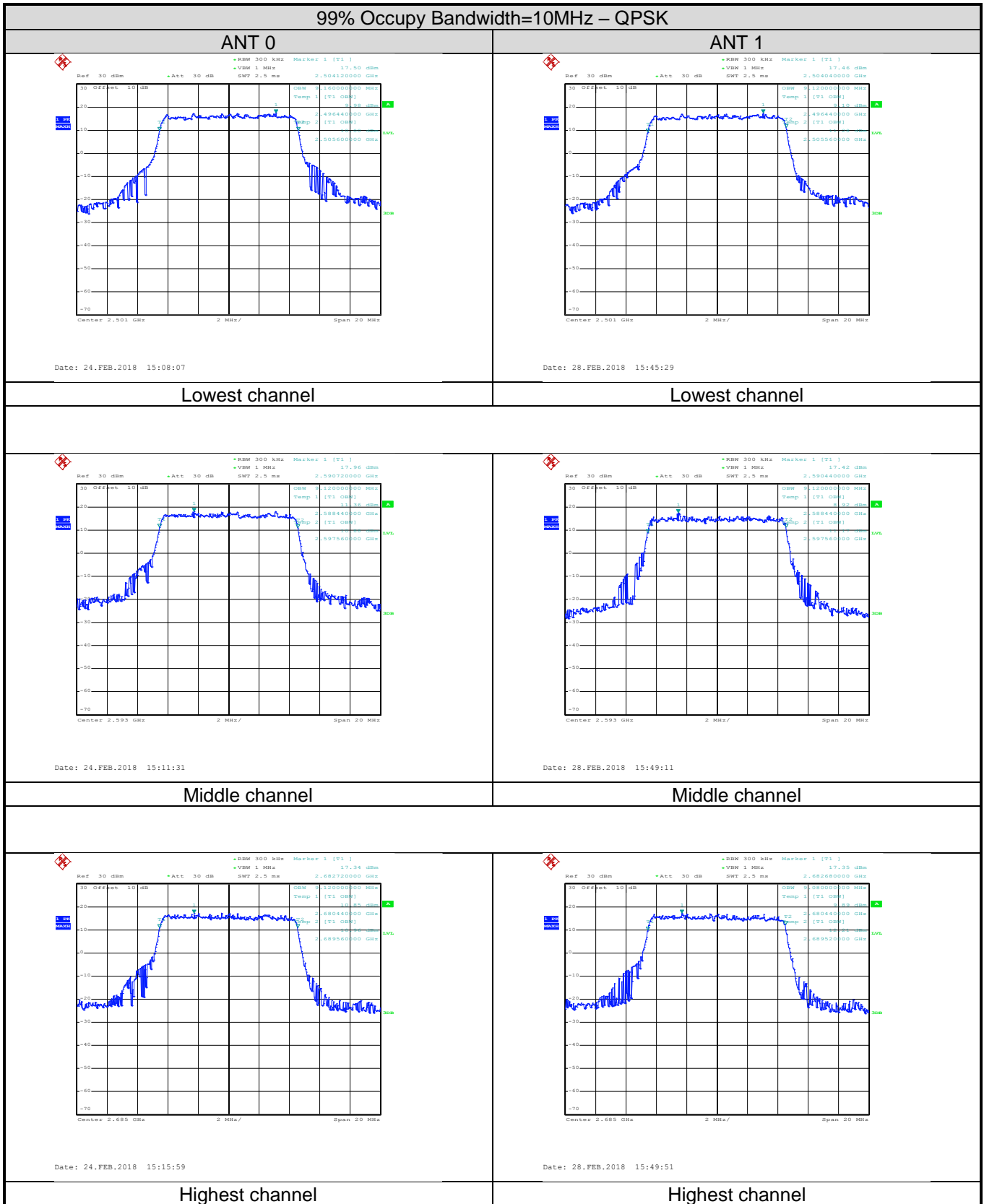

99% Occupy Bandwidth=10MHz – 16QAM

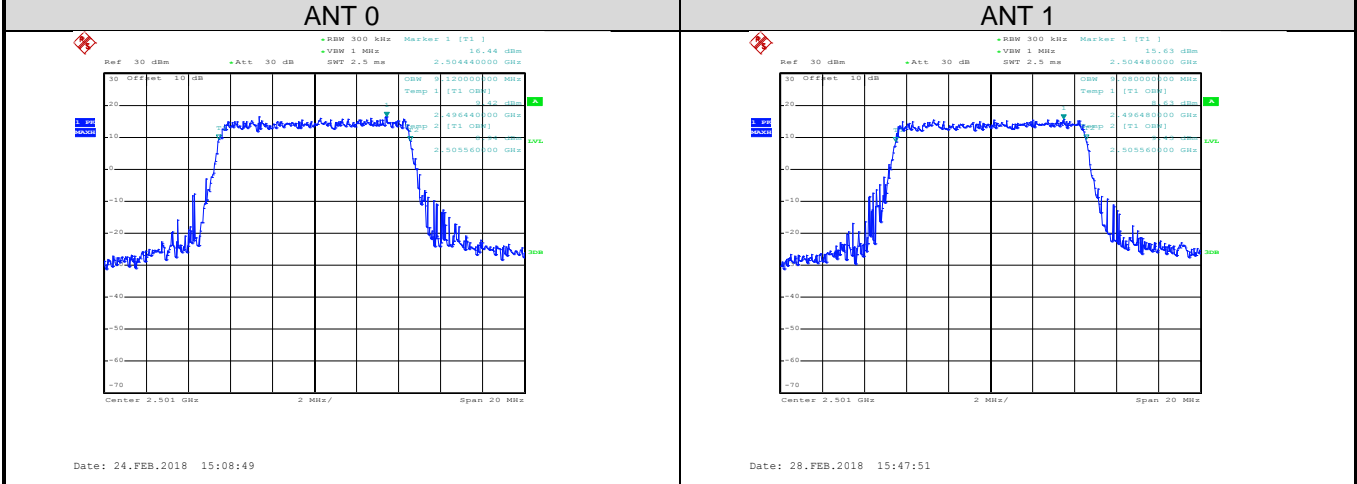

Lowest channel

Lowest channel

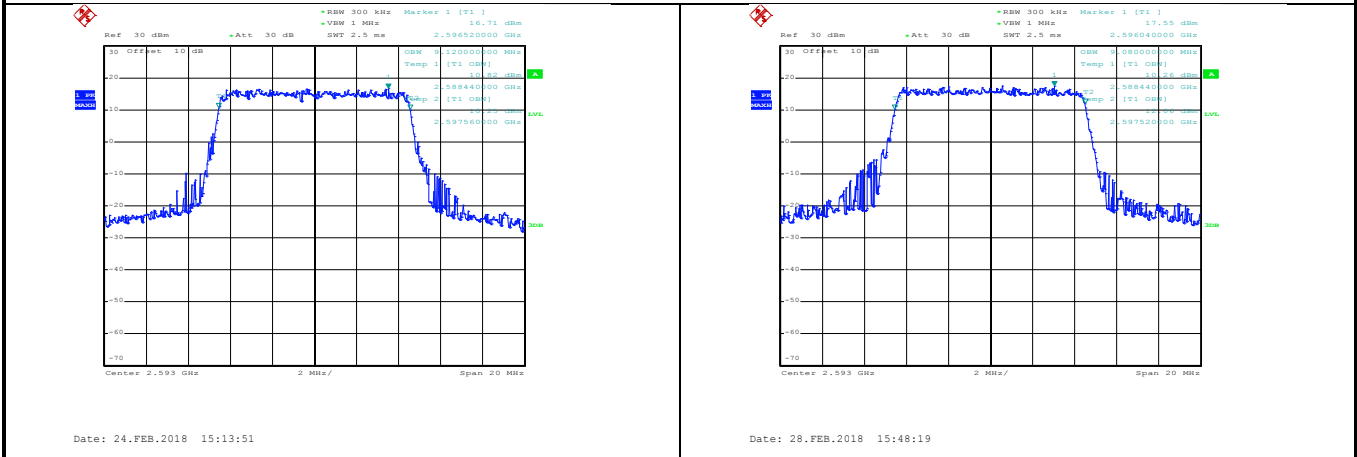

Middle channel

Middle channel

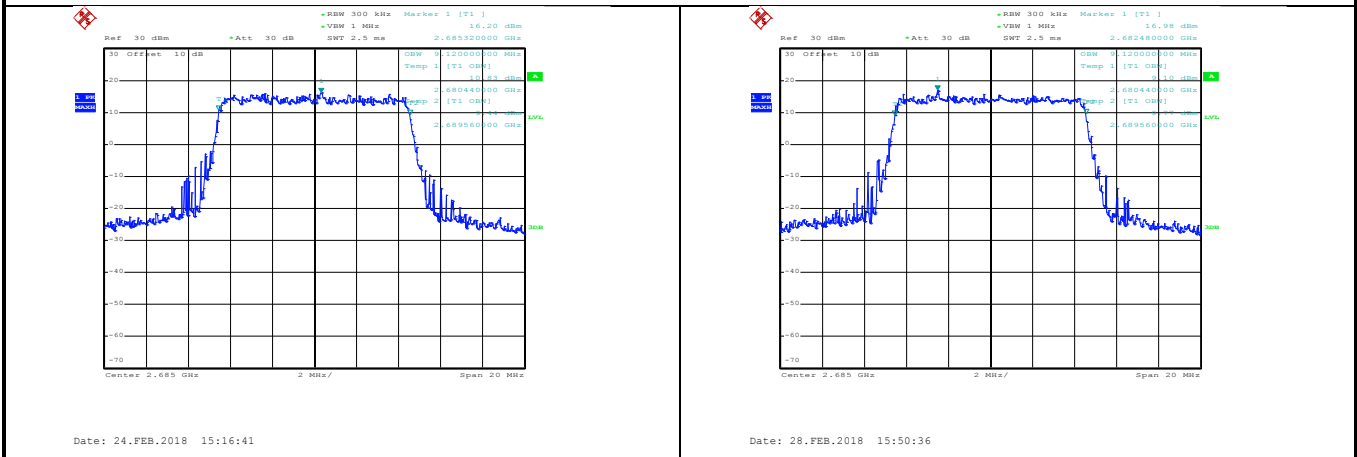

Highest channel

Highest channel

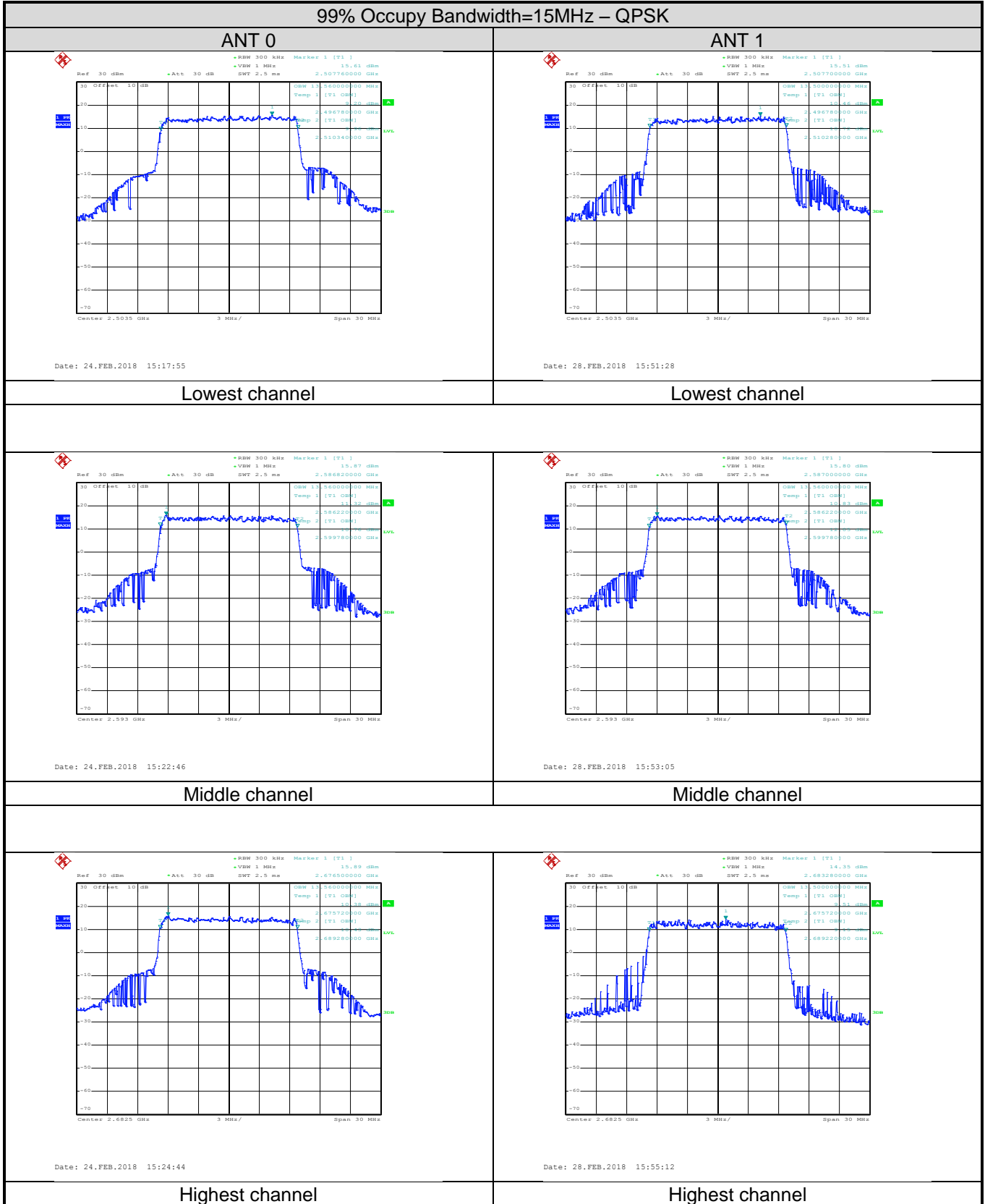

99% Occupy Bandwidth=15MHz – 16QAM

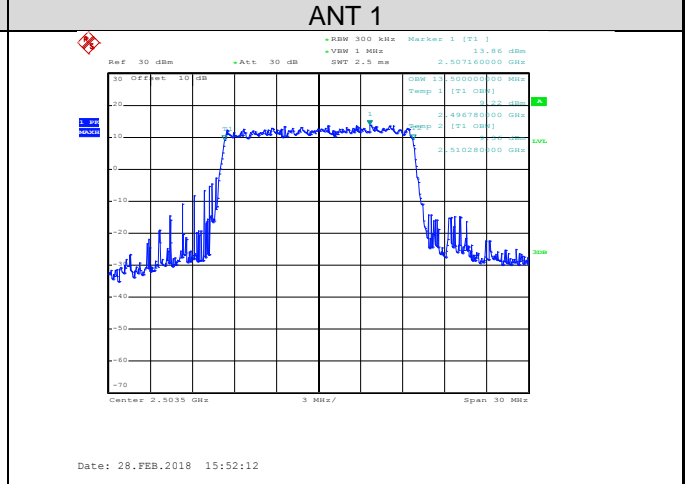
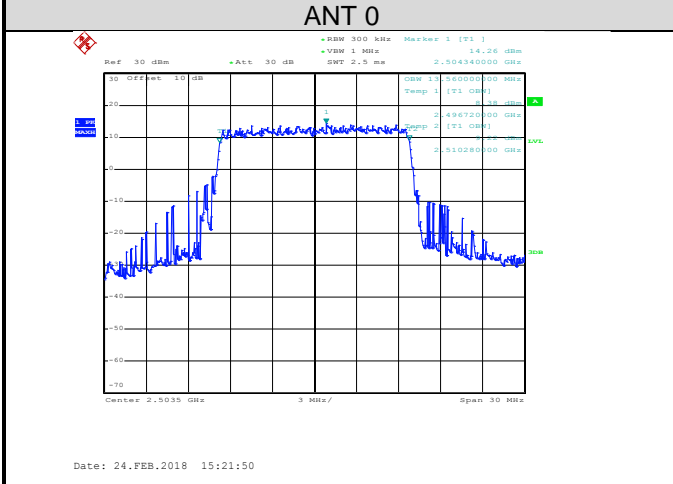

Lowest channel

Lowest channel

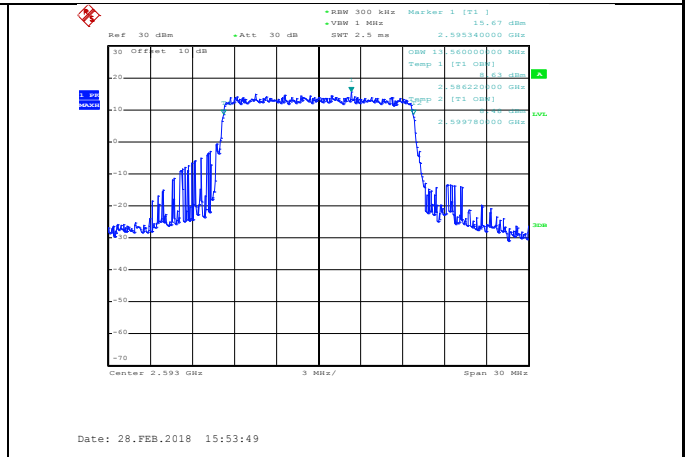
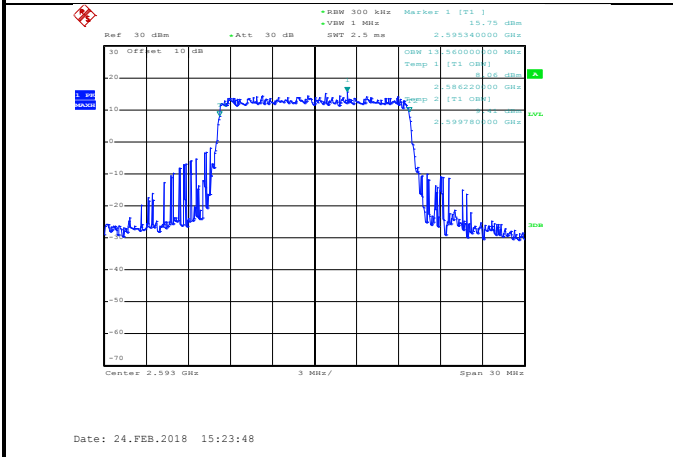

Middle channel

Middle channel

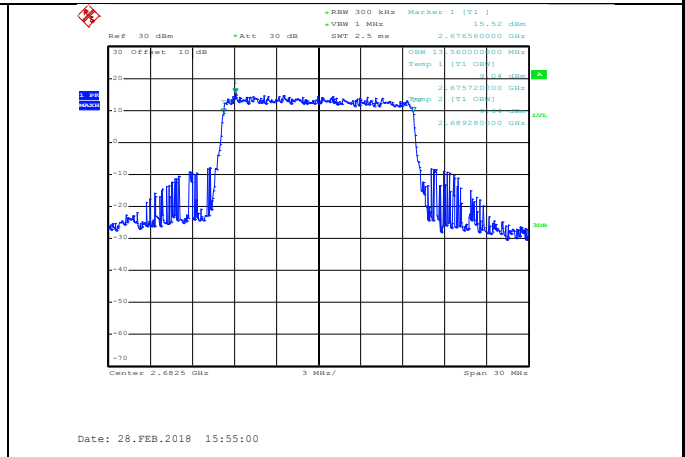
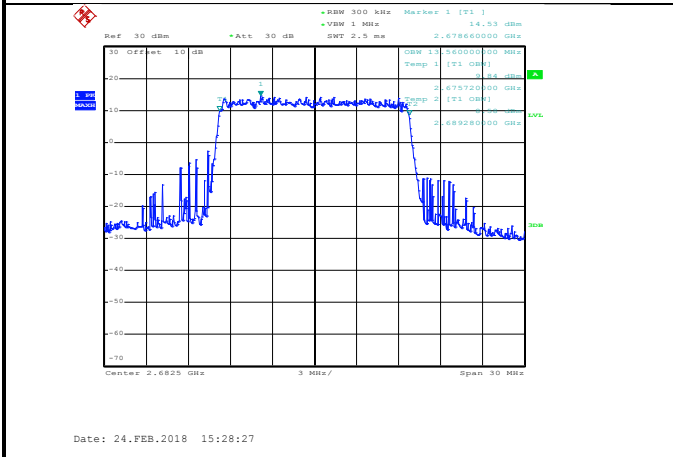

Highest channel

Highest channel

99% Occupy Bandwidth=20MHz – QPSK

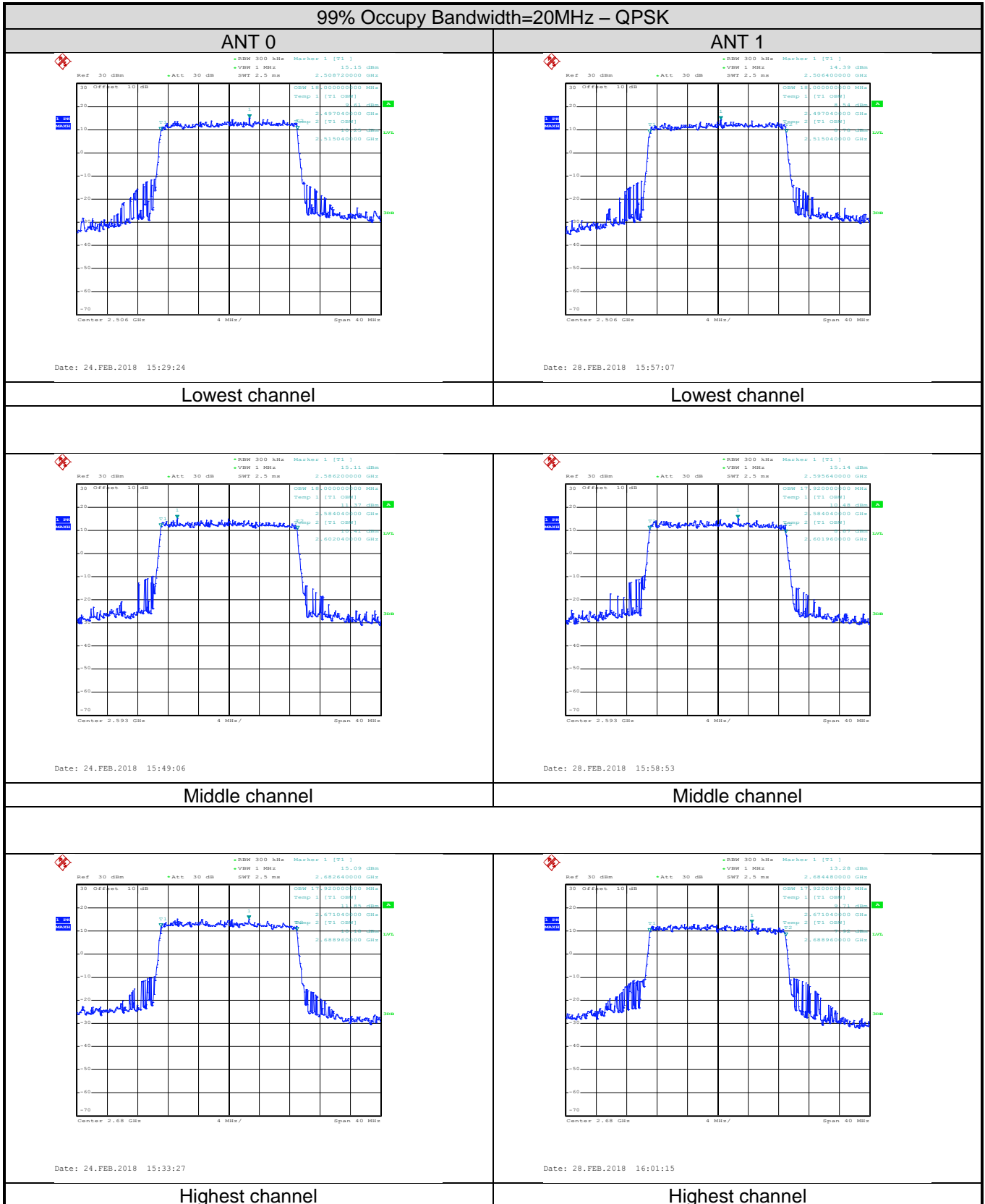

99% Occupy Bandwidth=20MHz – 16QAM

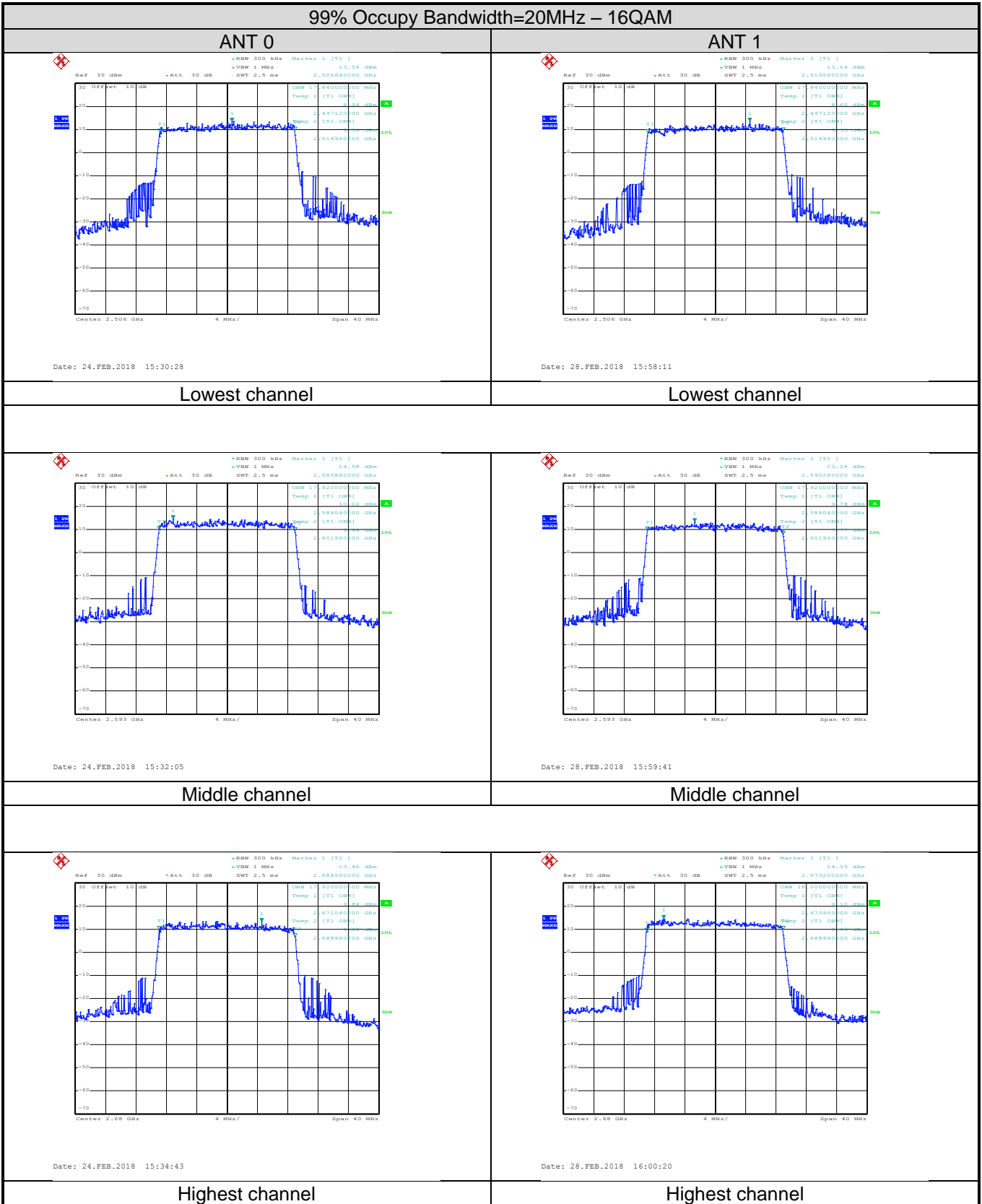

26dB Emission Bandwidth =5MHz – QPSK

ANT 0

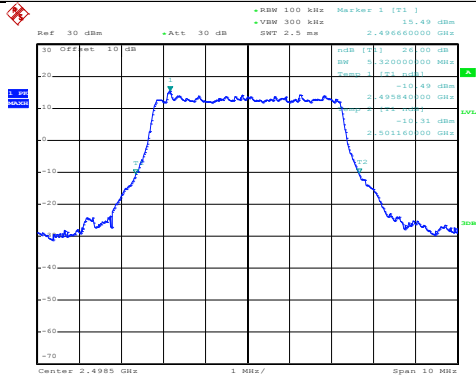

Date: 24.FEB.2018 14:54:54

Lowest channel

ANT 1

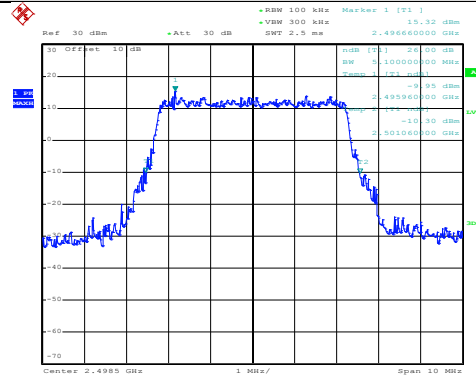

Date: 28.FEB.2018 15:38:30

Lowest channel

Middle channel

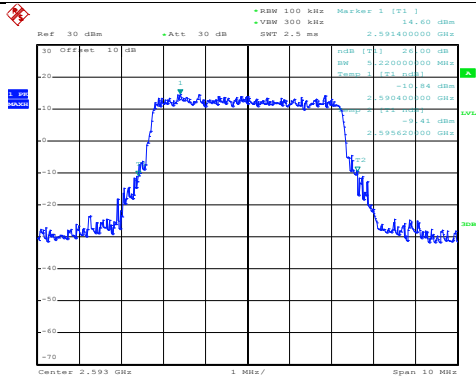

Date: 24.FEB.2018 14:56:36

Middle channel

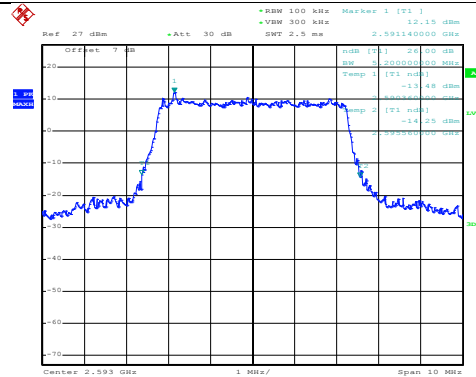

Date: 28.FEB.2018 15:18:34

Highest channel

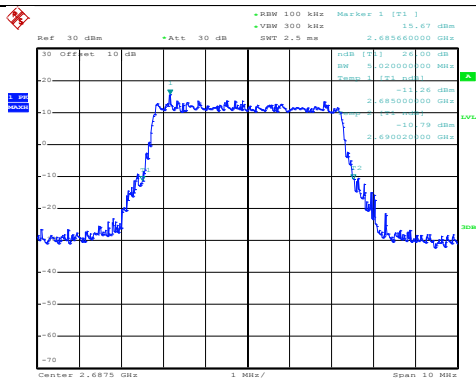

Date: 24.FEB.2018 14:58:14

Highest channel

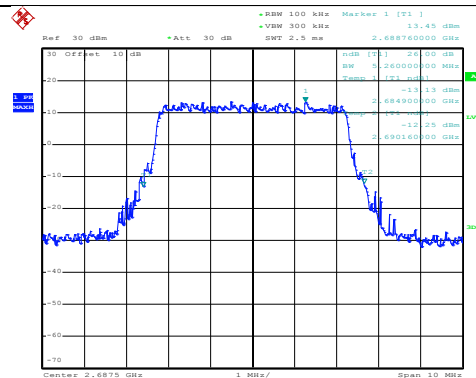

Date: 28.FEB.2018 15:42:55

26dB Emission Bandwidth=5MHz – 16QAM

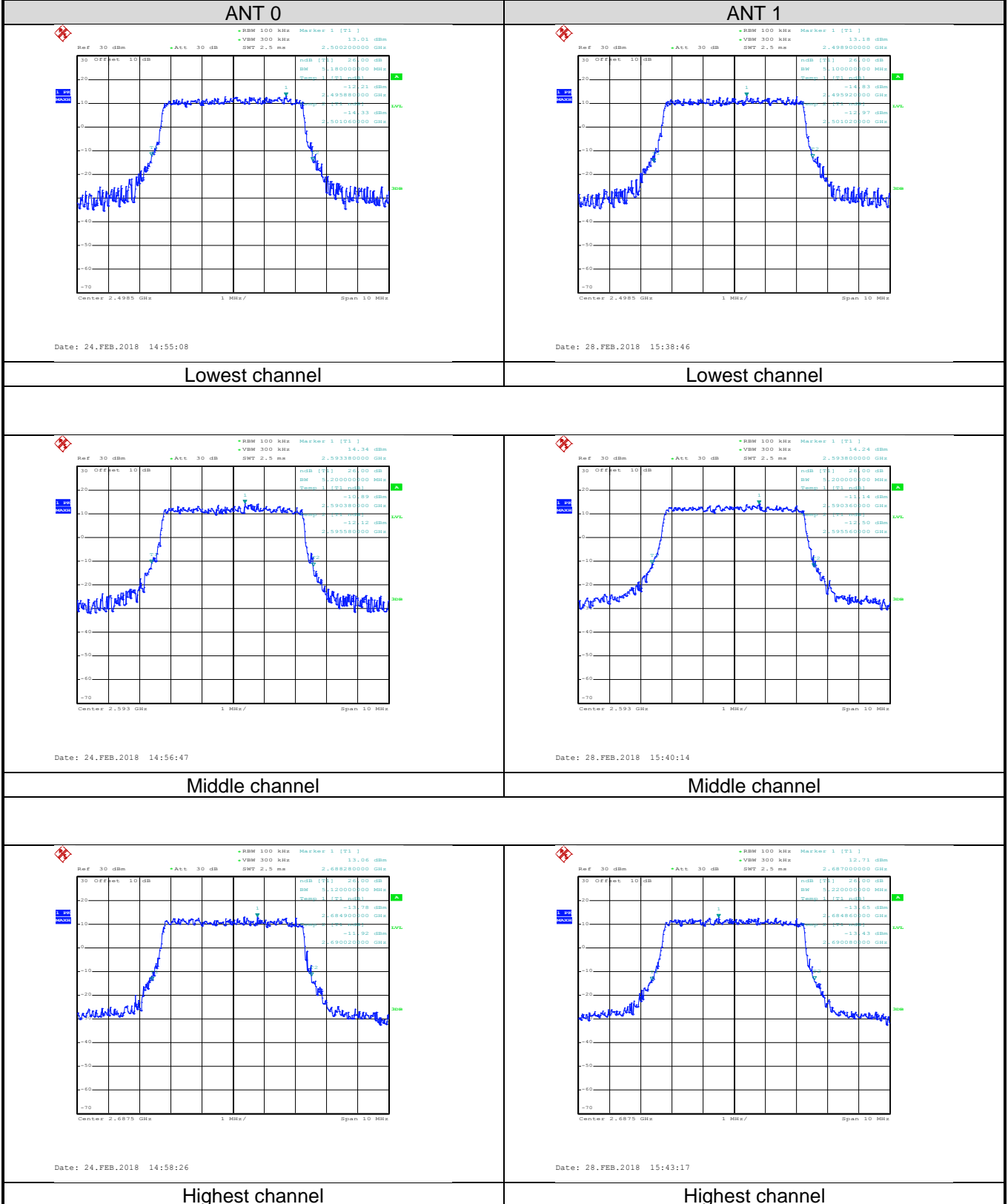

26dB Emission Bandwidth=10MHz – QPSK

ANT 0

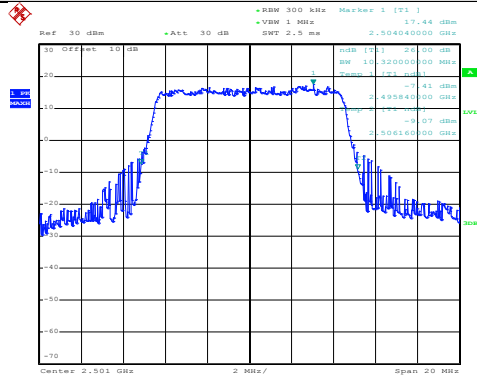

Date: 24.FEB.2018 15:08:21

Lowest channel

ANT 1

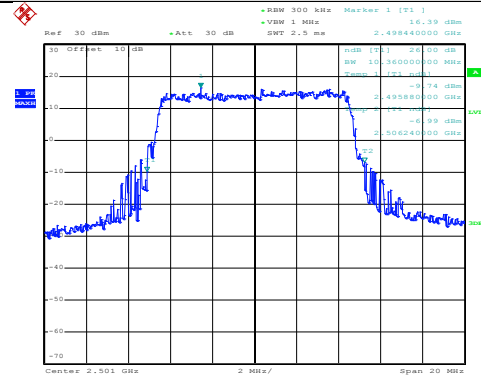

Date: 28.FEB.2018 15:47:39

Lowest channel

Middle channel

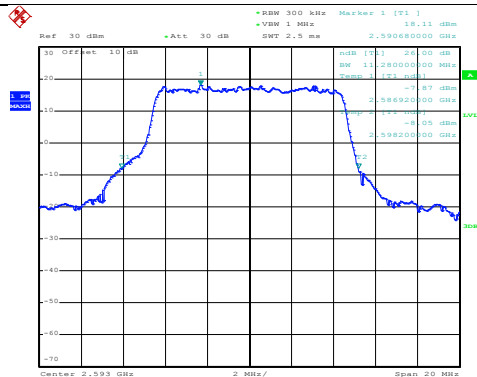

Date: 24.FEB.2018 15:13:02

Middle channel

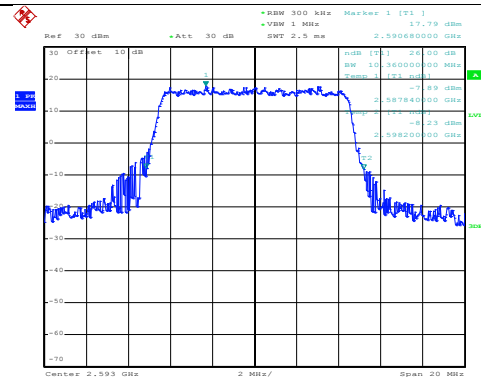

Date: 28.FEB.2018 15:48:38

Highest channel

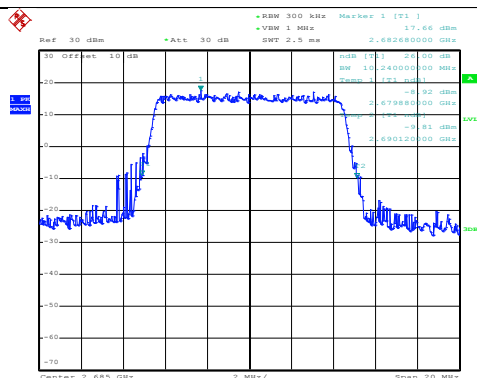

Date: 24.FEB.2018 15:16:09

Highest channel

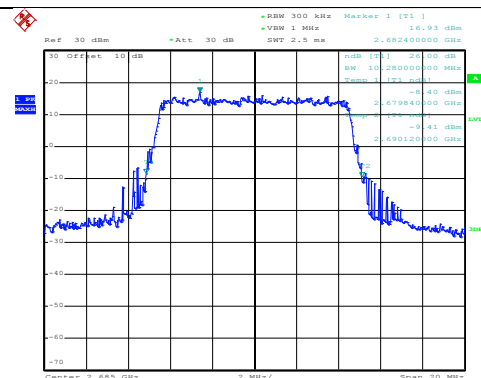

Date: 28.FEB.2018 15:50:25

26dB Emission Bandwidth=10MHz – 16QAM

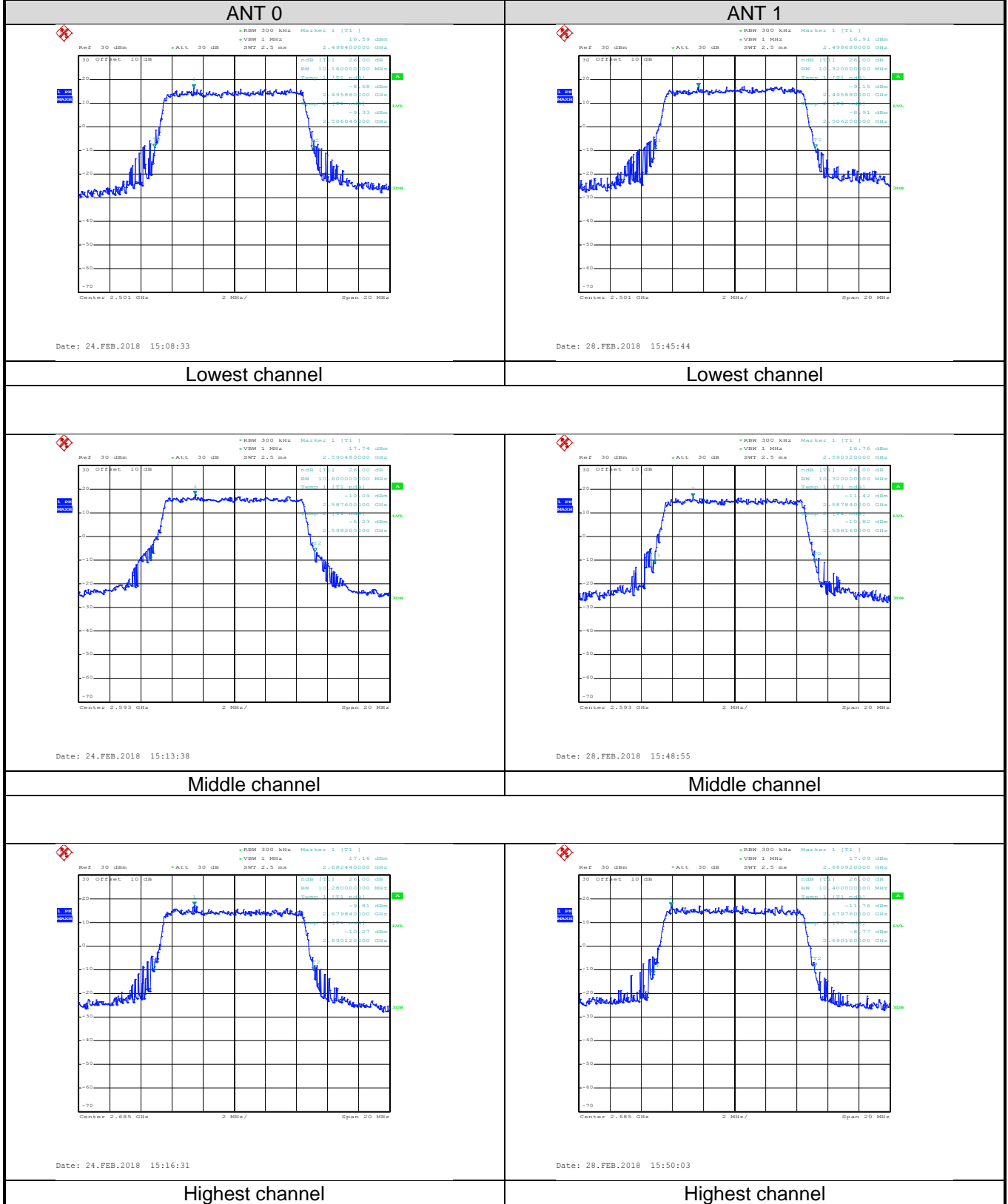

26dB Emission Bandwidth=15MHz – QPSK

ANT 0

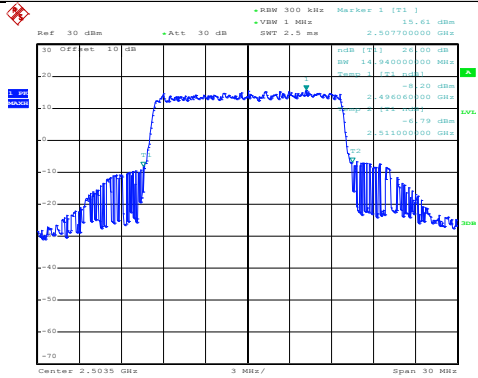

Date: 24.FEB.2018 15:18:17

Lowest channel

ANT 1

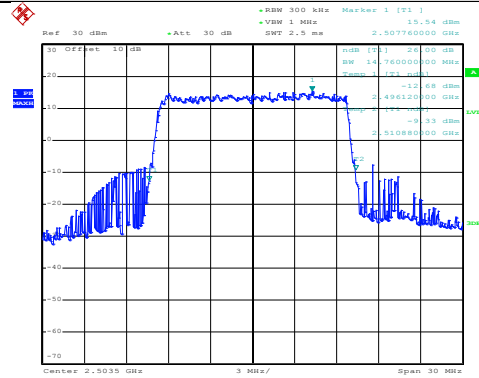

Date: 28.FEB.2018 15:51:41

Lowest channel

Middle channel

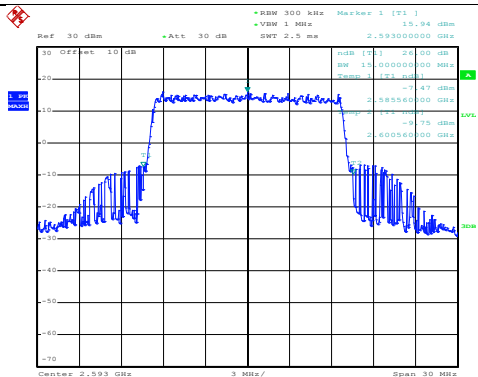

Date: 24.FEB.2018 15:23:01

Middle channel

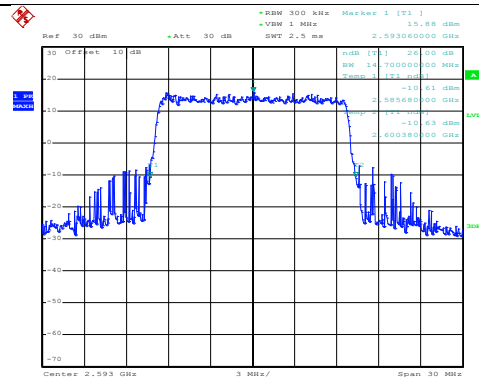

Date: 28.FEB.2018 15:53:15

Highest channel

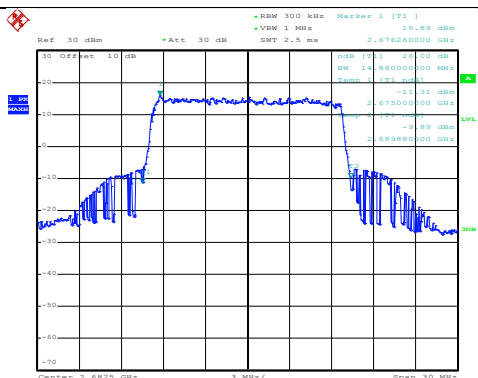

Date: 24.FEB.2018 15:25:18

Highest channel

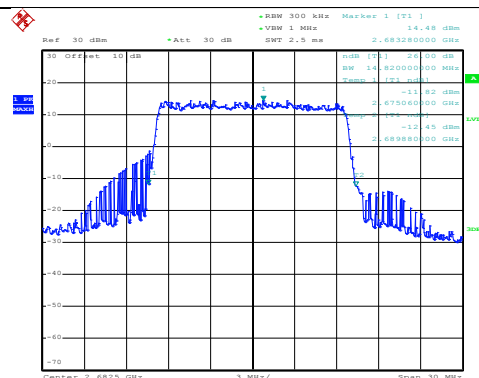

Date: 28.FEB.2018 15:55:33

26dB Emission Bandwidth=15MHz – 16QAM

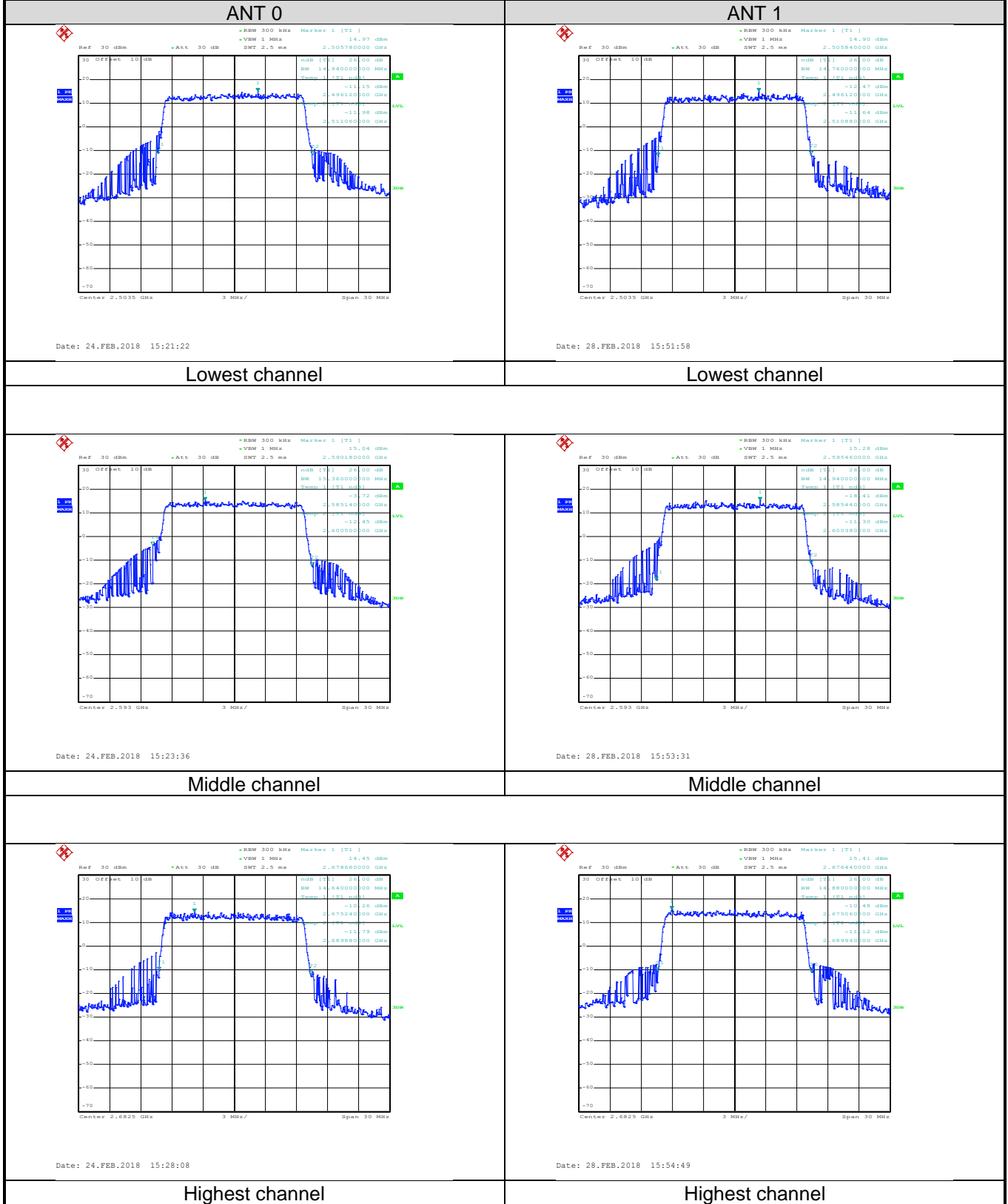

26dB Emission Bandwidth=20MHz – QPSK

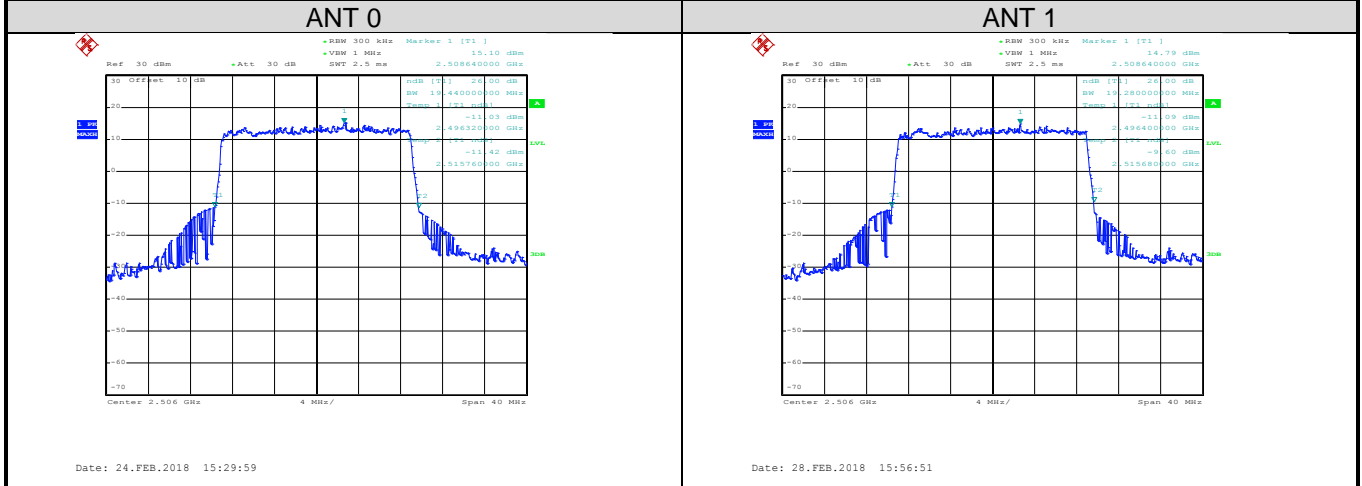

Lowest channel

Lowest channel

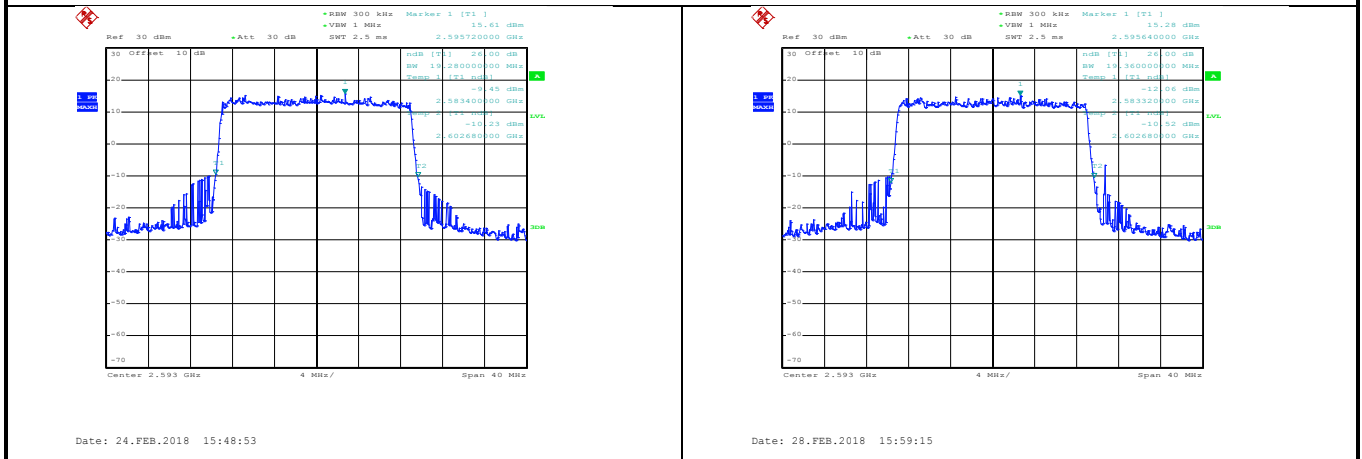

Middle channel

Middle channel

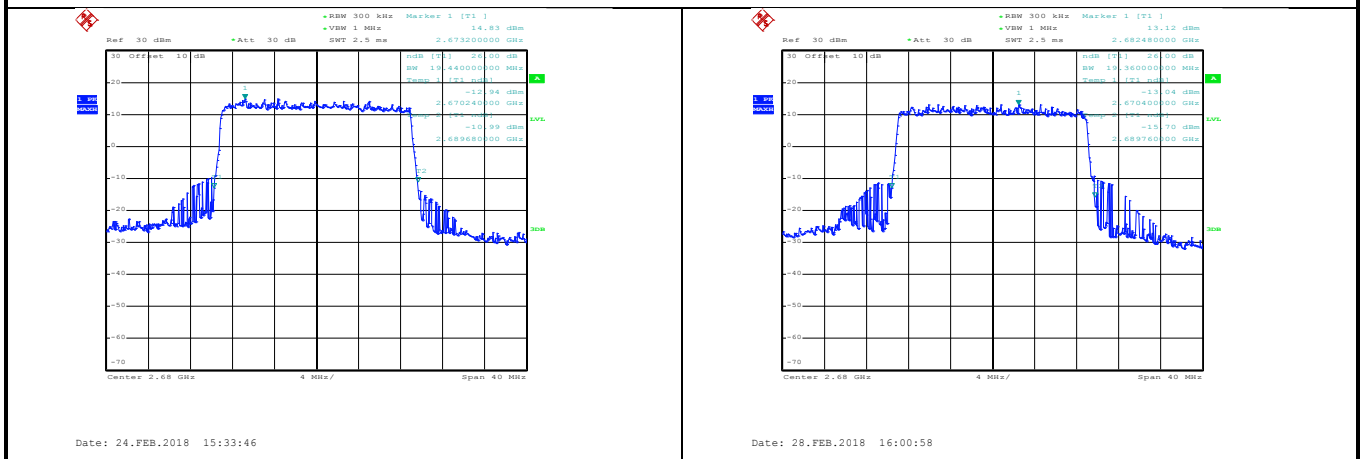

Highest channel

Highest channel

26dB Emission Bandwidth=20MHz – 16QAM

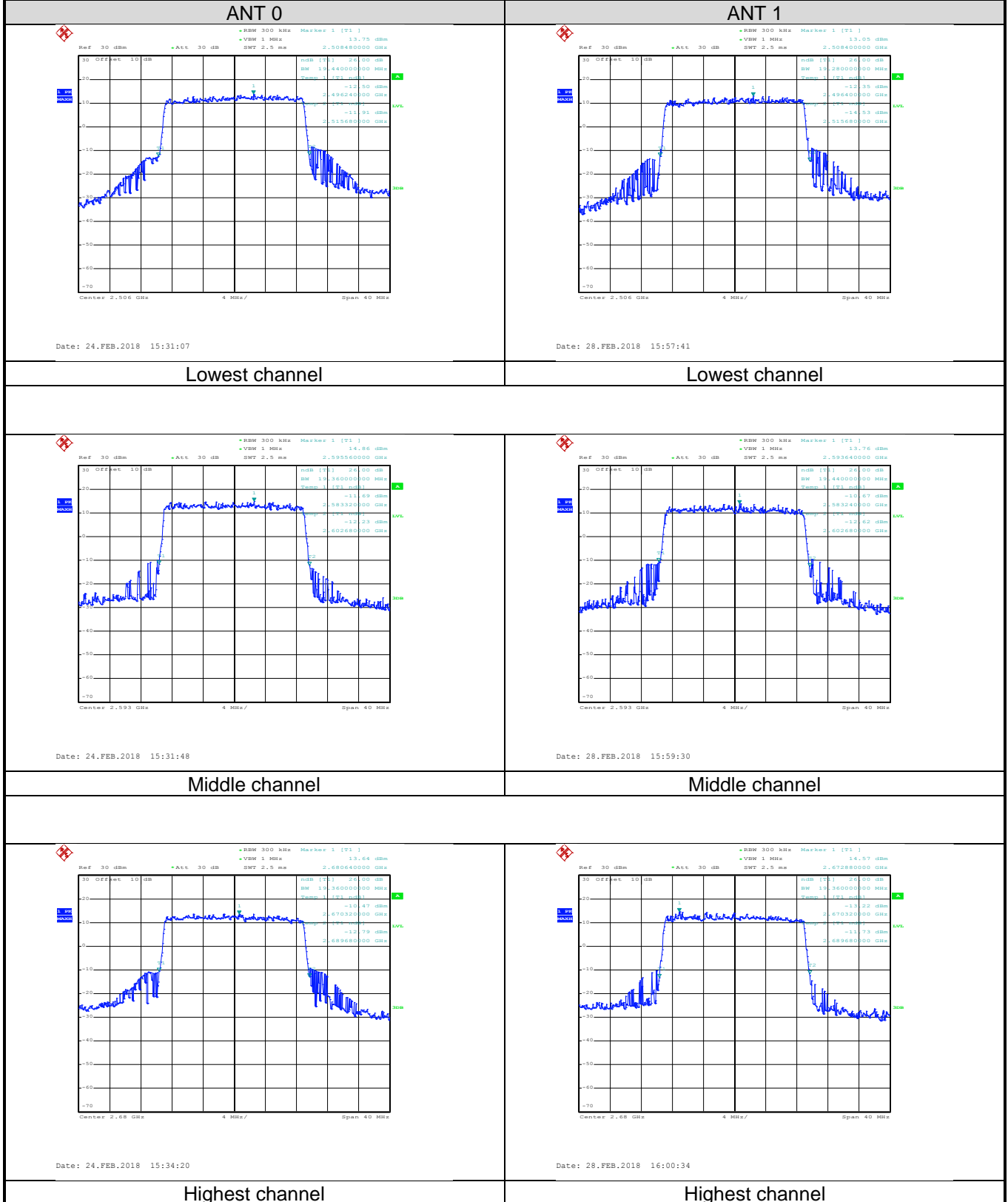

6.4 Out of band emission at antenna terminals

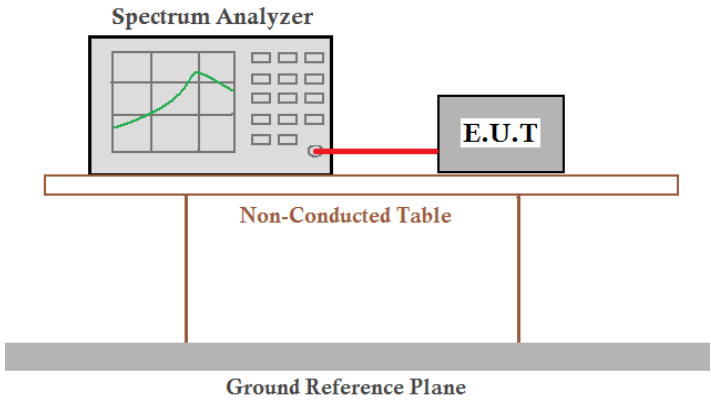
Test Requirement:	Part 27.53(m)(4)
Test Method:	ANSI/TIA-603-D 2010, FCC part 2.1051
Limit:	For mobile digital stations, the attenuation factor shall be not less than $40 + 10 \log (P)$ dB on all frequencies between the channel edge and 5 megahertz from the channel edge, $43 + 10 \log (P)$ dB on all frequencies between 5 megahertz and X megahertz from the channel edge, and $55 + 10 \log (P)$ dB on all frequencies more than X megahertz from the channel edge, where X is the greater of 6 megahertz or the actual emission bandwidth as defined in paragraph (m)(6) of this section. In addition, the attenuation factor shall not be less than $43 + 10 \log (P)$ dB on all frequencies between 2490.5 MHz and 2496 MHz and $55 + 10 \log (P)$ dB at or below 2490.5 MHz. Mobile Satellite Service licensees operating on frequencies below 2495 MHz may also submit a documented interference complaint against BRS licensees operating on channel BRS Channel 1 on the same terms and conditions as adjacent channel BRS or EBS licensees.
Test setup:	 <p>The diagram illustrates the test setup. A Spectrum Analyzer is connected via a red cable to an E.U.T. (Equipment Under Test). Both are placed on a Non-Conducted Table. Below the table is a Ground Reference Plane.</p>
Test Procedure:	<ol style="list-style-type: none"> 1 The RF output of the transceiver was connected to a spectrum analyzer through appropriate attenuation. 2 The resolution bandwidth of the spectrum analyzer was set at 100 kHz when below 1GHz, 1MHz when above 1 GHz; sufficient scans were taken to show the out of band Emissions if any up to 10th harmonic. 3 For the out of band: Set the RBW=100 kHz, VBW=300 kHz when below 1 GHz, RBW =1 MHz, VBW=3 MHz when above 1 GHz, Start=30MHz, Stop= 10th harmonic. 4 Band Edge Requirements: In the 1 MHz bands immediately outside and adjacent to the frequency block, a resolution bandwidth of at least 1 percent of the emission bandwidth of the fundamental emission of the transmitter may be employed to measure the out of band Emissions.
Test Instruments:	Refer to section 5.9 for details
Test mode:	Refer to section 5.3 for details
Test results:	Passed

test plot as follows:

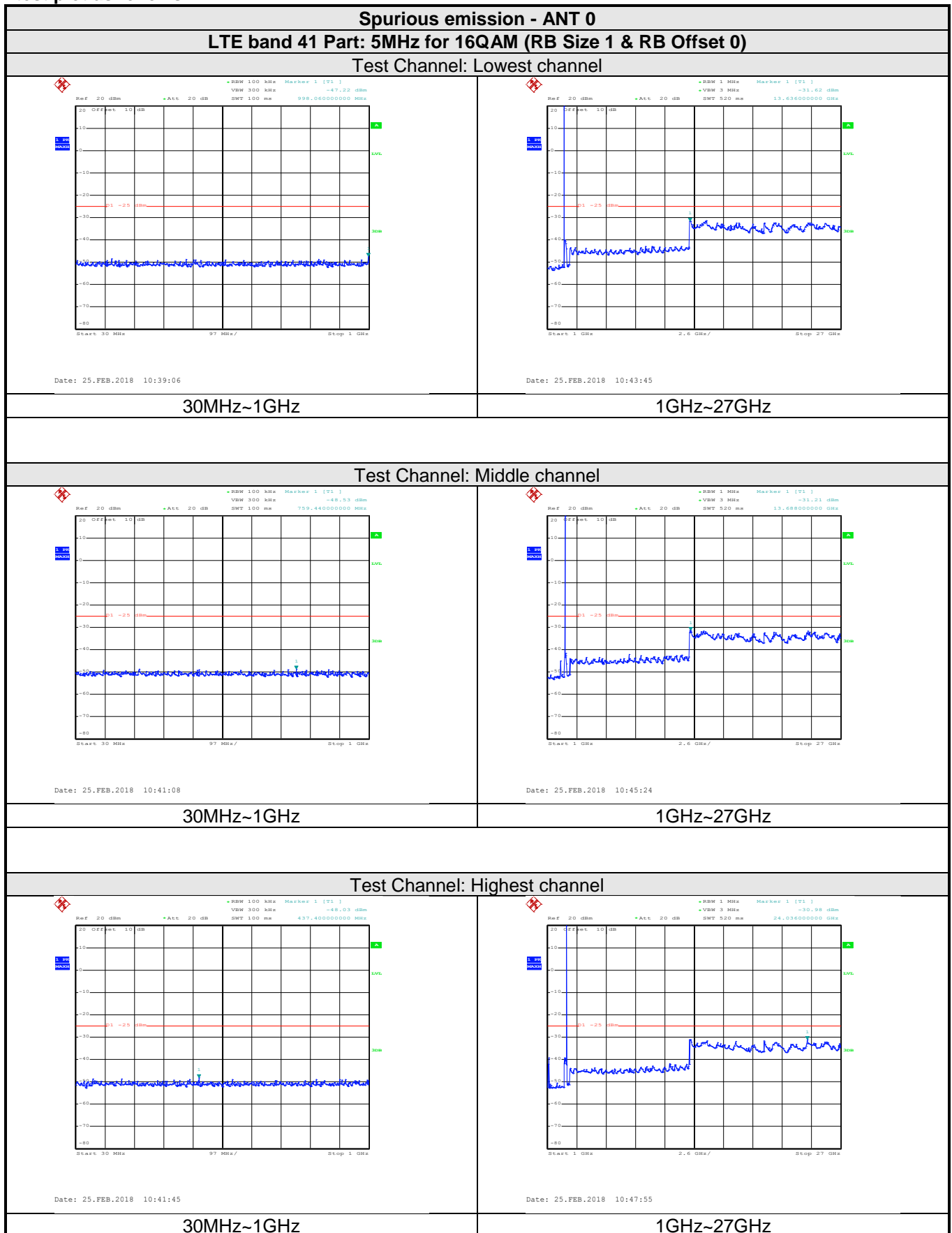

LTE band 41 Part: 5MHz for 16QAM (RB Size 25 & RB Offset 0)

Test Channel: Lowest channel

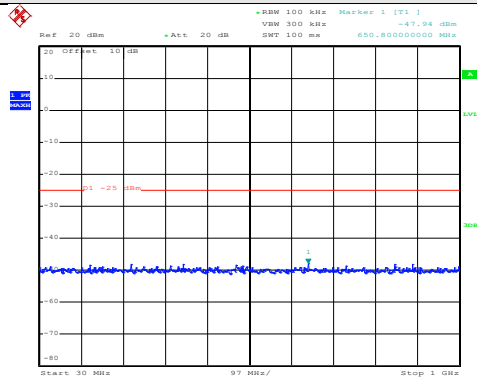

Date: 25.FEB.2018 10:40:15

30MHz~1GHz

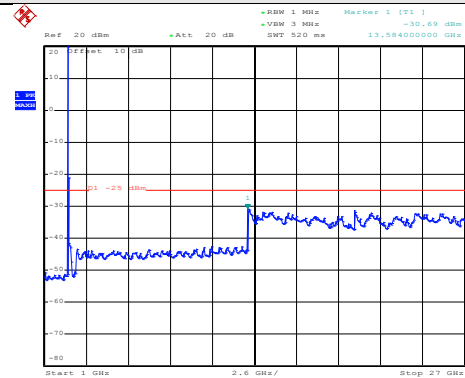

Date: 25.FEB.2018 10:44:06

1GHz~27GHz

Test Channel: Middle channel

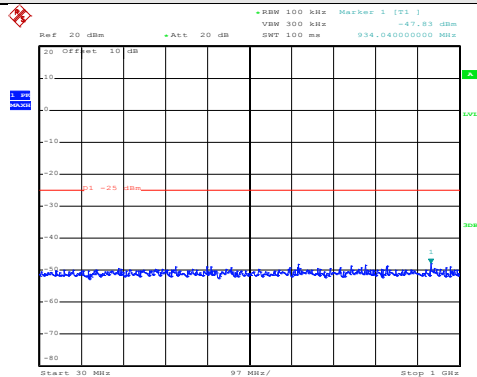

Date: 25.FEB.2018 10:40:56

30MHz~1GHz

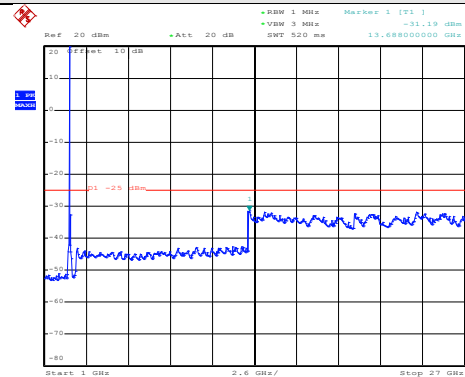

Date: 25.FEB.2018 10:46:04

1GHz~27GHz

Test Channel: Highest channel

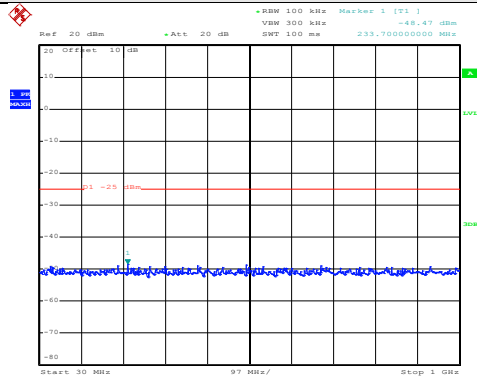

Date: 25.FEB.2018 10:42:18

30MHz~1GHz

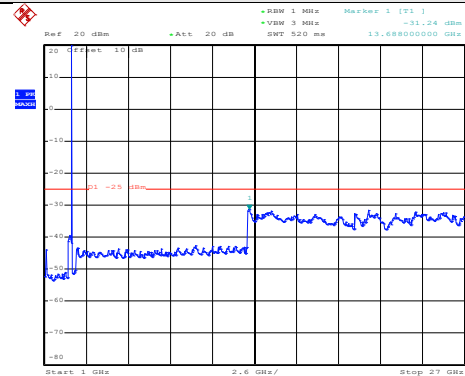

Date: 25.FEB.2018 10:48:18

1GHz~27GHz

LTE band 41 Part: 5MHz for QPSK (RB Size 1 & RB Offset 0)

Test Channel: Lowest channel

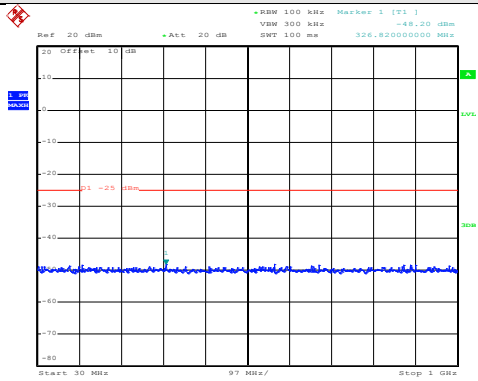

Date: 25.FEB.2018 10:38:53

30MHz~1GHz

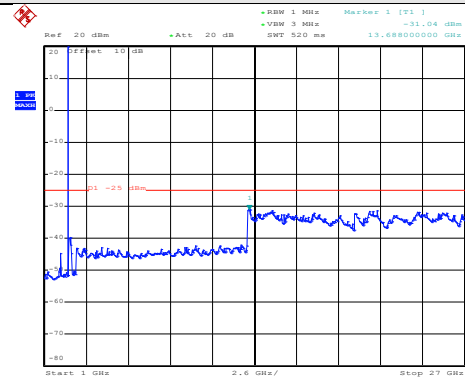

Date: 25.FEB.2018 10:43:29

1GHz~27GHz

Test Channel: Middle channel

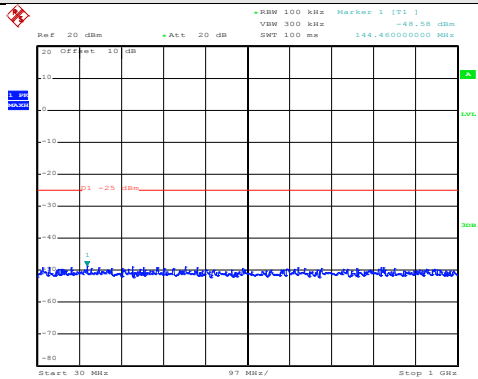

Date: 25.FEB.2018 10:41:20

30MHz~1GHz

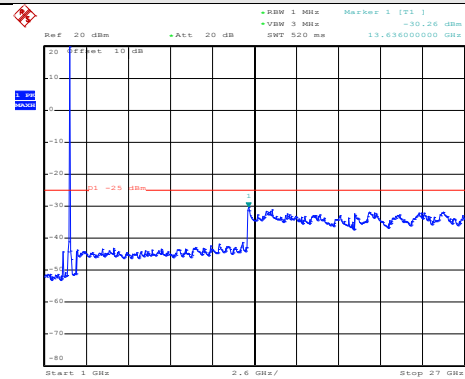

Date: 25.FEB.2018 10:45:04

1GHz~27GHz

Test Channel: Highest channel

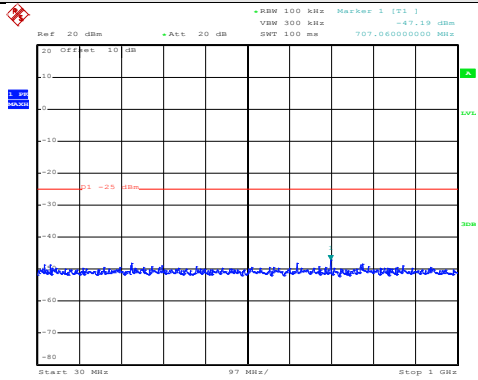

Date: 25.FEB.2018 10:41:34

30MHz~1GHz

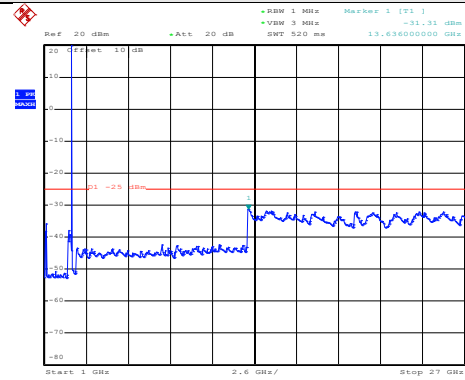

Date: 25.FEB.2018 10:47:33

1GHz~27GHz

LTE band 41 Part: 5MHz for QPSK (RB Size 25 & RB Offset 0)

Test Channel: Lowest channel

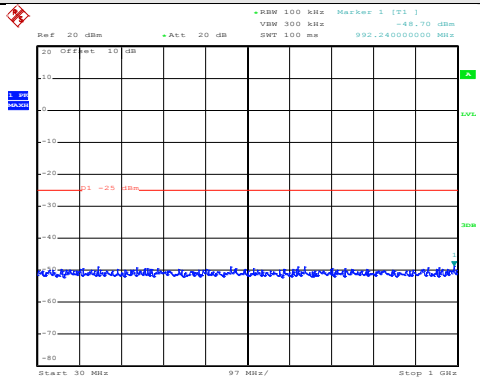

Date: 25.FEB.2018 10:40:27

30MHz~1GHz

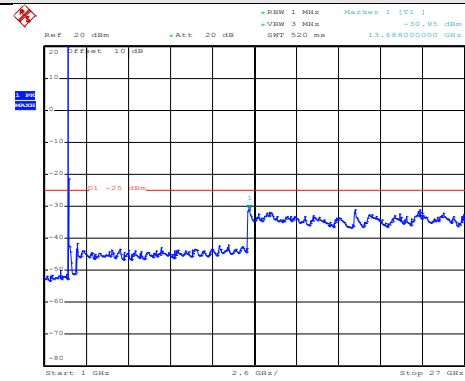

Date: 25.FEB.2018 10:44:25

1GHz~27GHz

Test Channel: Middle channel

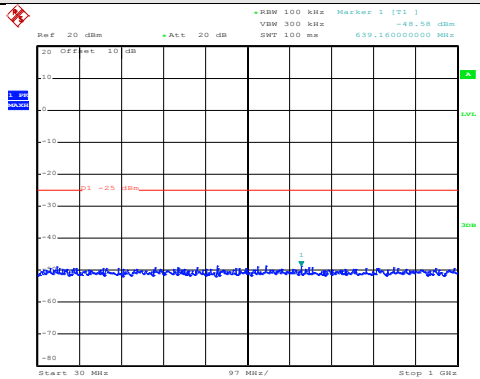

Date: 25.FEB.2018 10:40:46

30MHz~1GHz

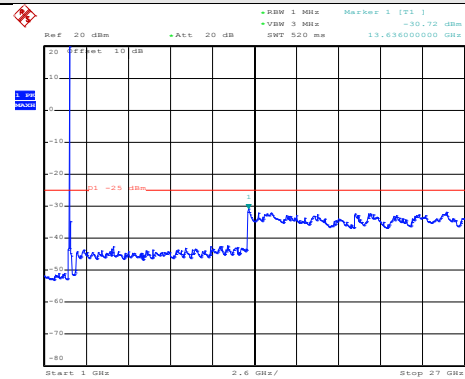

Date: 25.FEB.2018 10:45:47

1GHz~27GHz

Test Channel: Highest channel

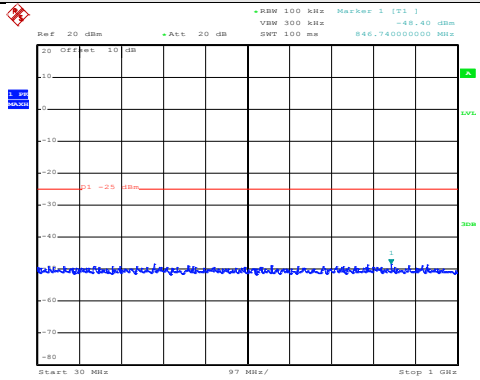

Date: 25.FEB.2018 10:42:06

30MHz~1GHz

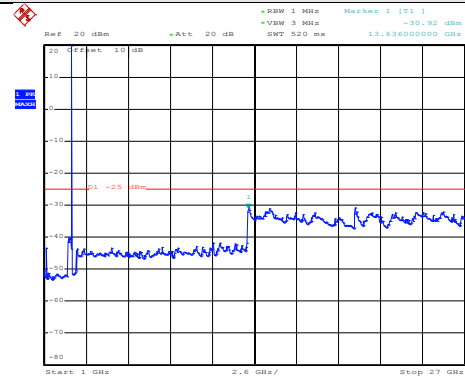

Date: 25.FEB.2018 10:48:38

1GHz~27GHz

LTE band 41 Part: 10MHz for 16QAM (RB Size 1 & RB Offset 0)

Test Channel: Lowest channel

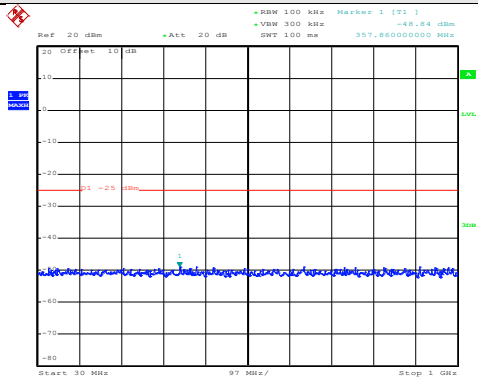

Date: 26.FEB.2018 00:48:47

30MHz~1GHz

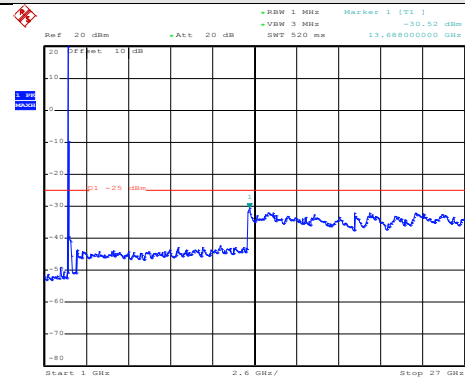

Date: 25.FEB.2018 10:55:56

1GHz~27GHz

Test Channel: Middle channel

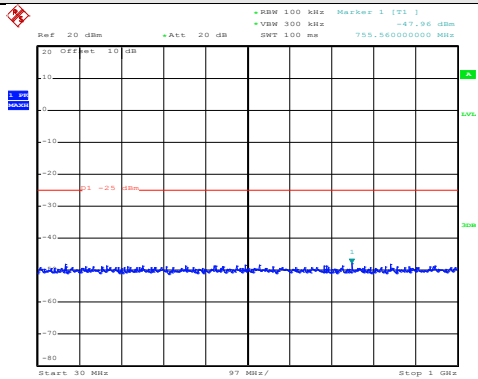

Date: 26.FEB.2018 00:52:53

30MHz~1GHz

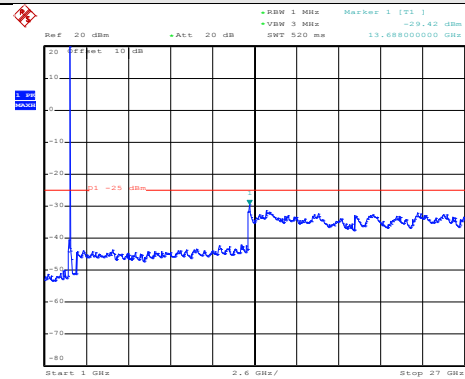

Date: 25.FEB.2018 11:00:28

1GHz~27GHz

Test Channel: Highest channel

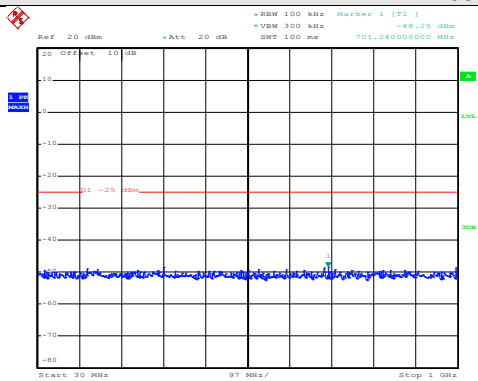

Date: 26.FEB.2018 00:53:27

30MHz~1GHz

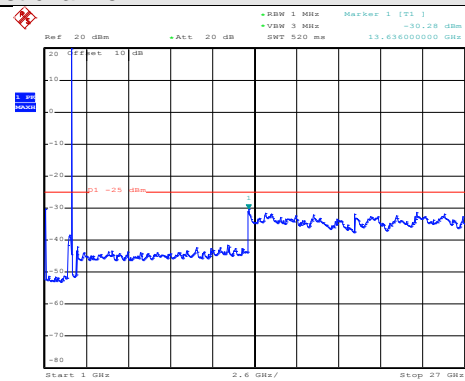

Date: 25.FEB.2018 11:02:25

1GHz~27GHz

LTE band 41 Part: 10MHz for 16QAM (RB Size 50 & RB Offset 0)

Test Channel: Lowest channel

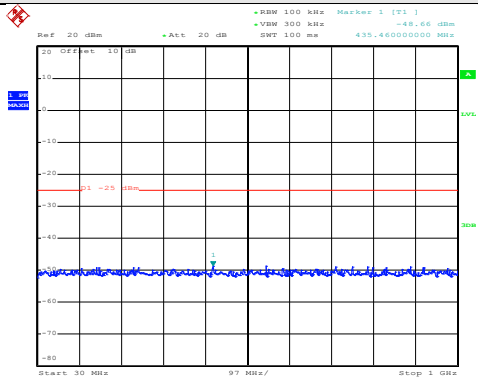

Date: 26.FEB.2018 00:49:01

30MHz~1GHz

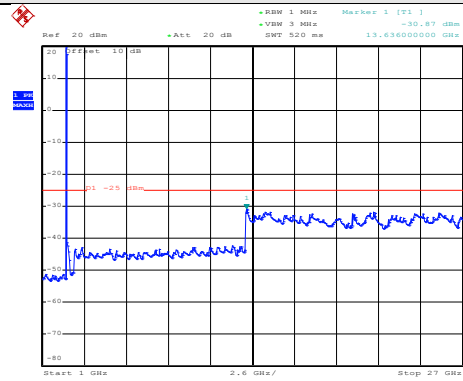

Date: 25.FEB.2018 10:59:05

1GHz~27GHz

Test Channel: Middle channel

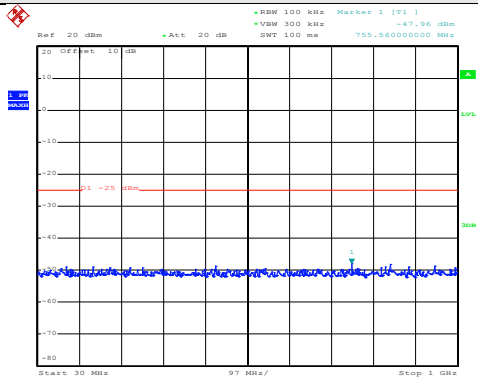

Date: 26.FEB.2018 00:52:13

30MHz~1GHz

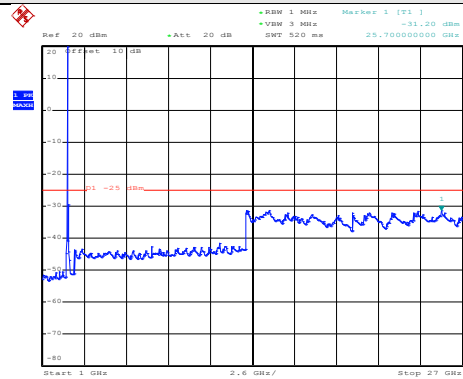

Date: 25.FEB.2018 11:01:40

1GHz~27GHz

Test Channel: Highest channel

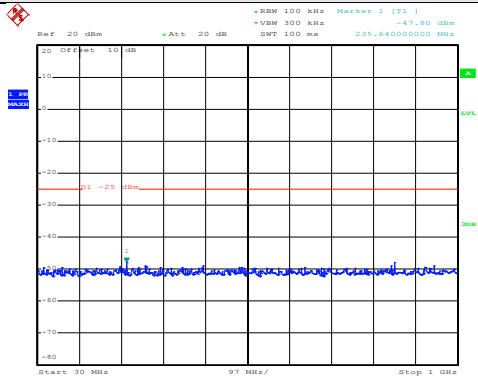

Date: 26.FEB.2018 00:53:37

30MHz~1GHz

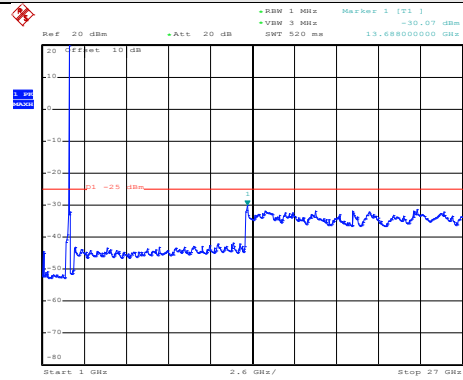

Date: 25.FEB.2018 11:03:51

1GHz~27GHz

LTE band 41 Part: 10MHz for QPSK (RB Size 1 & RB Offset 0)

Test Channel: Lowest channel

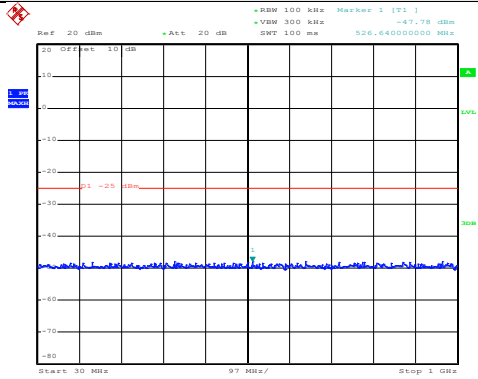

Date: 26.FEB.2018 00:48:34

30MHz~1GHz

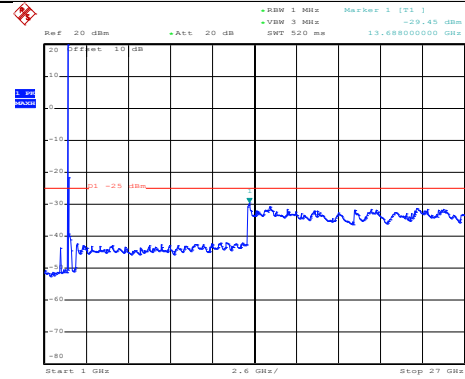

Date: 25.FEB.2018 10:55:32

1GHz~27GHz

Test Channel: Middle channel

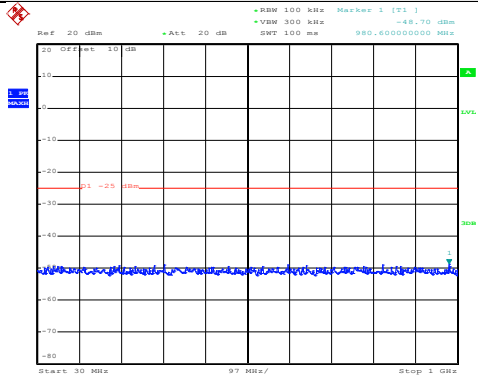

Date: 26.FEB.2018 00:53:03

30MHz~1GHz

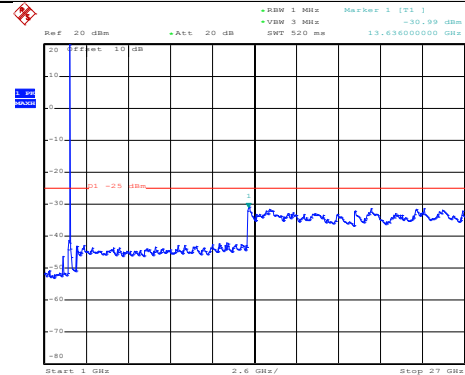

Date: 25.FEB.2018 11:00:08

1GHz~27GHz

Test Channel: Highest channel

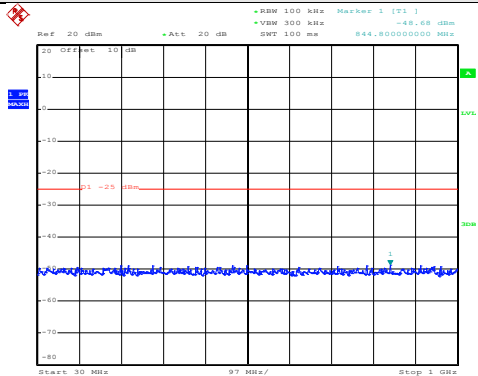

Date: 26.FEB.2018 00:53:17

30MHz~1GHz

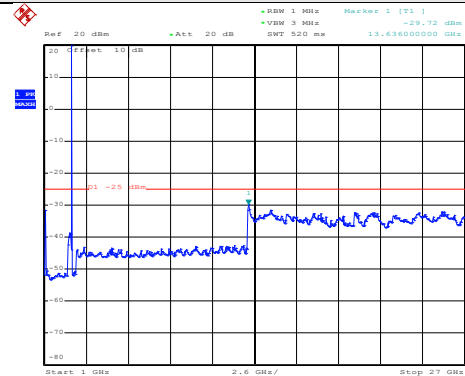

Date: 25.FEB.2018 11:02:46

1GHz~27GHz

LTE band 41 Part: 10MHz for QPSK (RB Size 50 & RB Offset 0)

Test Channel: Lowest channel

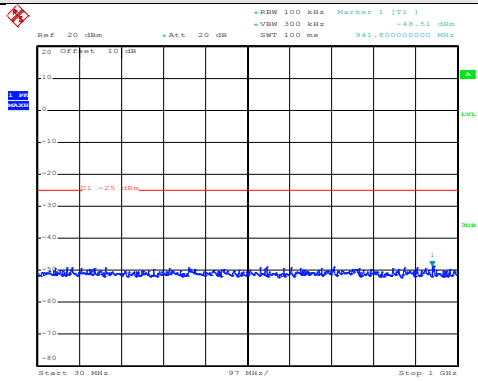

Date: 26.FEB.2018 00:49:12

30MHz~1GHz

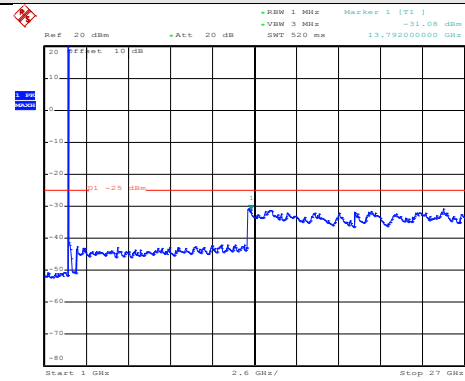

Date: 25.FEB.2018 10:58:42

1GHz~27GHz

Test Channel: Middle channel

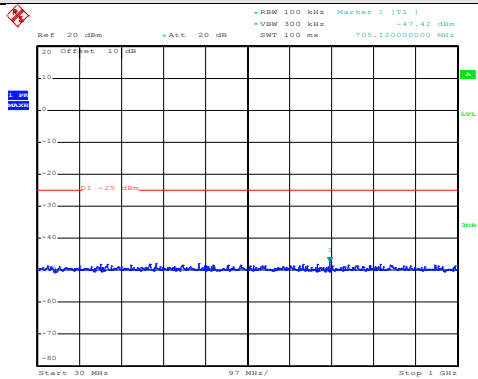

Date: 26.FEB.2018 00:52:02

30MHz~1GHz

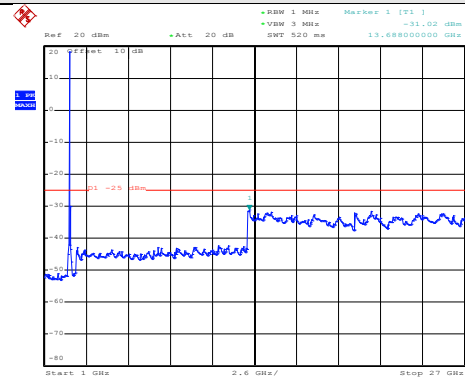

Date: 25.FEB.2018 11:01:10

1GHz~27GHz

Test Channel: Highest channel

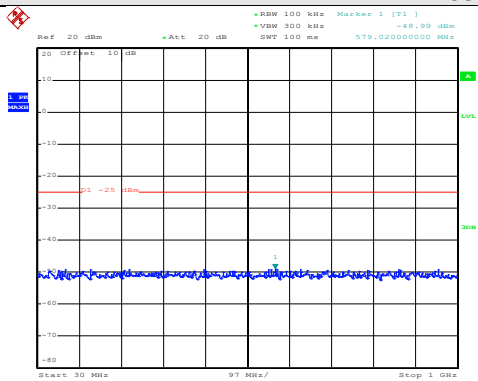

Date: 26.FEB.2018 00:53:49

30MHz~1GHz

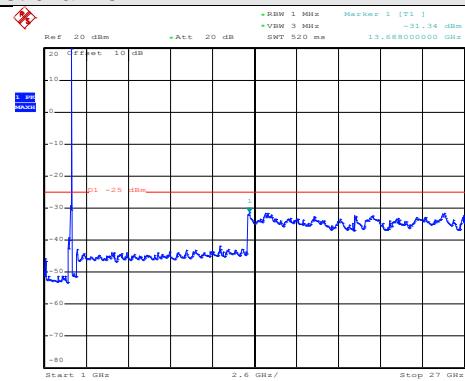

Date: 25.FEB.2018 11:03:16

1GHz~27GHz

LTE band 41 Part: 15MHz for 16QAM (RB Size 1 & RB Offset 0)

Test Channel: Lowest channel

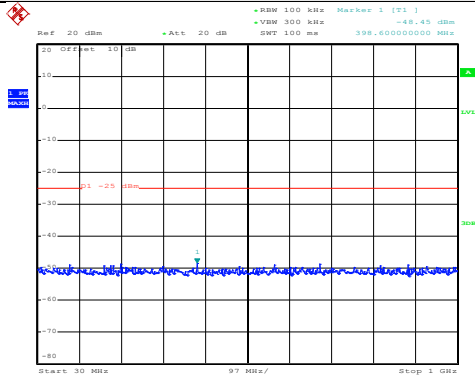

Date: 26.FEB.2018 00:55:19

30MHz~1GHz

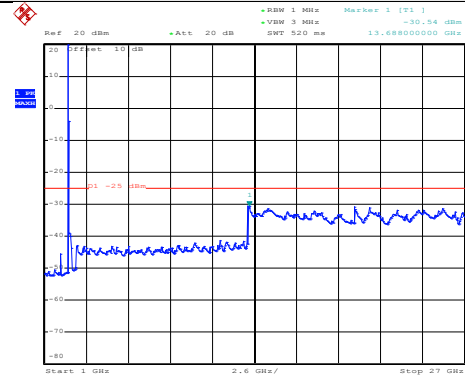

Date: 26.FEB.2018 01:03:48

1GHz~27GHz

Test Channel: Middle channel

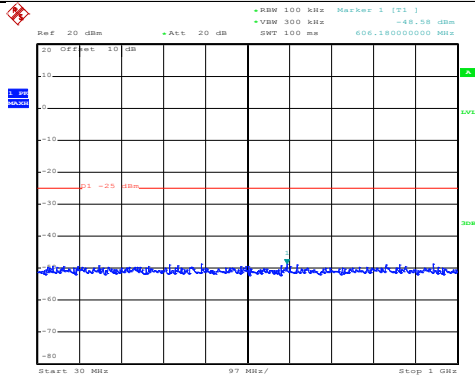

Date: 26.FEB.2018 00:56:32

30MHz~1GHz

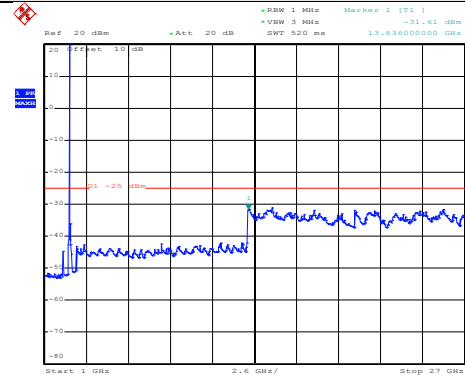

Date: 26.FEB.2018 01:07:49

1GHz~27GHz

Test Channel: Highest channel

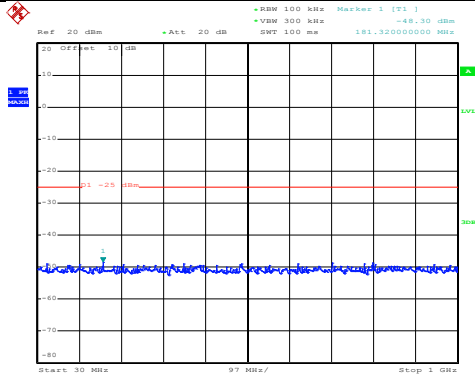

Date: 26.FEB.2018 00:57:11

30MHz~1GHz

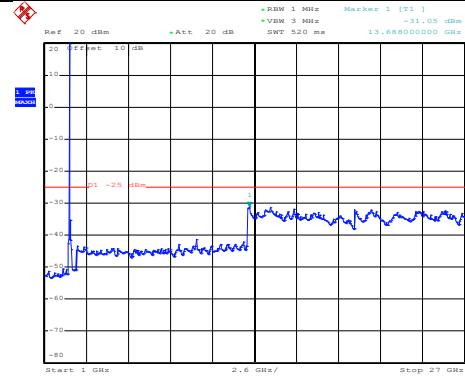

Date: 26.FEB.2018 01:10:13

1GHz~27GHz

LTE band 41 Part: 15MHz for 16QAM (RB Size 75 & RB Offset 0)

Test Channel: Lowest channel

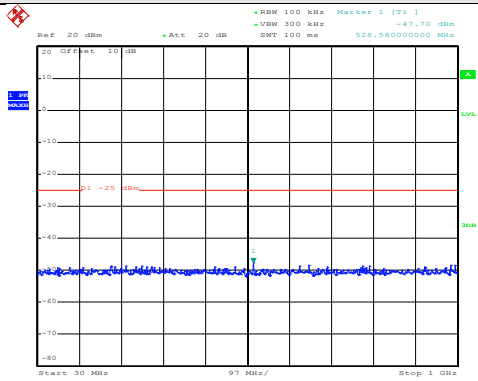

Date: 26.FEB.2018 00:55:41

30MHz~1GHz

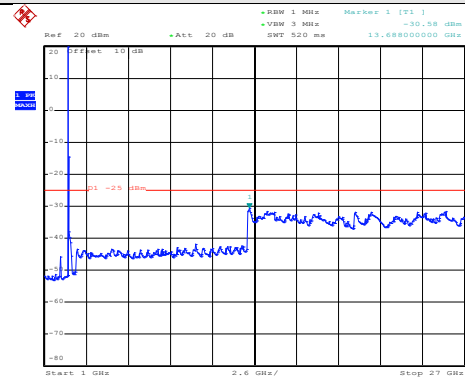

Date: 26.FEB.2018 01:04:53

1GHz~27GHz

Test Channel: Middle channel

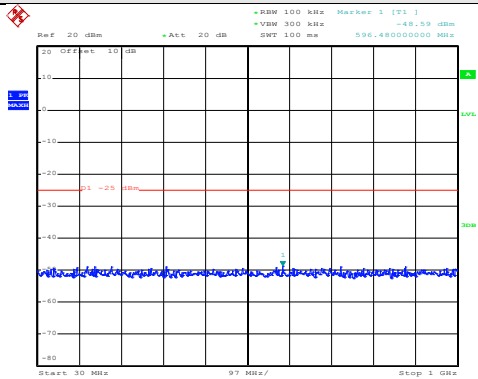

Date: 26.FEB.2018 00:56:19

30MHz~1GHz

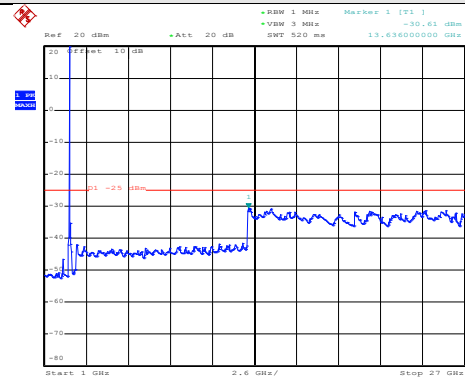

Date: 26.FEB.2018 01:06:19

1GHz~27GHz

Test Channel: Highest channel

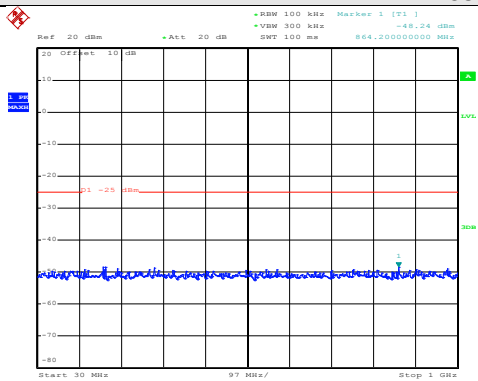

Date: 26.FEB.2018 00:57:21

30MHz~1GHz

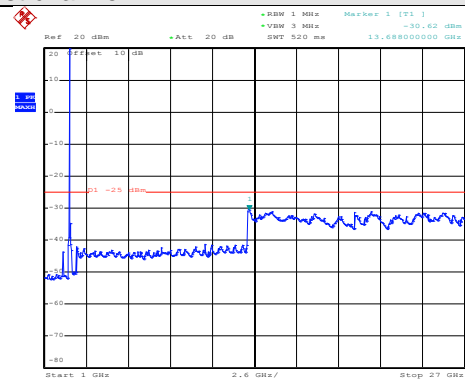

Date: 26.FEB.2018 01:09:22

1GHz~27GHz