



BaiCells CW0100 CPE Installation Guide

V1.0

About This Document

This document introduces the installation and debugging steps of CW0100 outdoor CPE equipment, which is used for guiding installer to install CPE correctly.

Copyright Notice

BaiCells copyrights this specification. No part of this specification may be reproduced in any form or means, without the prior written consent of BaiCells.

Disclaimer

This specification is preliminary and is subject to change at any time without notice. BaiCells assumes no responsibility for any errors contained herein. For more information, please consult our technical engineers.

Revision Record

Date	Version	Description	Author
30 Jun,2016	V1.0	Initial released.	Tang Houcheng

Contact Us

E-mail: support@baicells.com

Phone: 86-10-62607100

Website: <http://www.baicells.com/>

Contents

1. Installation Preparation	2
1.1 Out-of-Box Audit	2
1.2 Installation Accessories	2
1.3 Installation Tools	3
1.4 Installation Environment.....	4
1.5 Safety Protection.....	4
2. Equipment Installation	5
2.1 Appearance	5
2.2 Interface and Button	5
2.3 LED Indicators.....	6
2.4 RF Specifications.....	6
2.5 Install on Pole.....	7
2.6 Install on Wall.....	8
3. Wire Connection	9
3.1 Make Ethernet Cable Connector.....	9
3.2 Connect Ethernet Cable	13
3.3 Power On.....	14
3.4 Lightning Protection of Cable.....	15
4. Power on Detection.....	16
4.1 Detection Item	16
4.2 Ethernet Port Working Status	16
4.3 CPE Configuration Check.....	16
4.4 CPE Access Test	16
4.5 CPE Parameter Record	16
5. Regulatory Compliance	17
Appendix A FAQ.....	19

Contents of Figure

Figure 2-1 Appearance of CW0100.....	5
Figure 2-2 Install on pole A.....	7
Figure 2-3 Install on pole B	8
Figure 2-4 Mounting Hole of Install on Wall	8
Figure 3-1 Strip Shielded Twisted Pair	9
Figure 3-2 Separate the metal net, wire of cable and aluminum foil layer	9
Figure 3-3 Cut off the aluminum foil layer of twisted pair.....	10
Figure 3-4 Color Order	10
Figure 3-5 Insert the twisted pair core into line card.....	10
Figure 3-6 Insert line card into Connector.....	11
Figure 3-7 Crimping connector.....	11
Figure 3-8 Impact the connector with cable shield layer.....	11
Figure 3-9 Cut off the redundant part.....	12
Figure 3-10 Completion of shielded connector	12
Figure 3-11 Connect Cable 1	13
Figure 3-12 Connect Cable 2	14
Figure 3-13 POE power Mode.....	15

Contents of Table

Table 2-1 CW0100 Interface and button	5
Table 2-2 LED Indicators	6
Table 2-3 RF Specification	6
Table 3-1 Lightning Protection Demand of Cable	15

1. Installation Preparation

1.1 Out-of-Box Audit

Before opening the box, make sure the packaging cases are in good condition, undamaged and not soaked. During the unpacking, avoid potential damaging impacts from hits or excessive force.

Check whether the material in the box is consistent with “*Shipping List*” and is in good condition and undamaged.

Note:

During the unpacking, if the outer package is damaged or soaked, stop unpacking and find the cause. Report the issue to the vendor. For any shortage, miscarriage, or damage is identified, report the local vendor within 10 days.

1.2 Installation Accessories

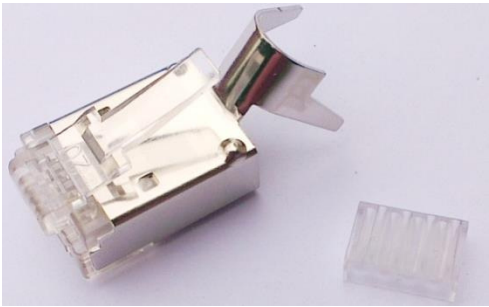















Figure	Name
	Shielded RJ-45 connector and line card
	POE power adaptor

Figure	Name
	<p>Shielded CAT5 twisted pair</p> <p>The length of the cable is tailored according to situation of the installation site.</p>
	<p>Plastic tie</p>
	<p>Grounding wire</p>

1.3 Installation Tools

The following tools are needed during the installation.

				
<p>Standing wave measuring</p>	<p>Nipper pliers</p>	<p>Diagonal pliers</p>	<p>Pincer pliers</p>	<p>Ethernet cable tester</p>
				
<p>Percussion drill and some drill</p>	<p>Tool knife</p>	<p>Screwdriver</p>	<p>Crimping tool</p>	<p>Multimeter</p>

				
Wrench	Electroprobe	Electric soldering iron	Ladder	

1.4 Installation Environment

According to “*Reconnaissance Report*”, check whether the external environment of installation site is ready.

1.5 Safety Protection

Construction personnel must conform to “*Construction Safety Specification*”, wearing safety protection guard, such as safety belt, safety helmet, gloves, and wrist strap, and so on.

2. Equipment Installation

2.1 Appearance

The appearance of CW0100 outdoor CPE is smart, the dimension of CPE is 245mm x 135mm x 42mm, the weights of CPE is 600g. The appearance is shown in Figure 2-1.

Figure 2-1 Appearance of CW0100



CW0100 CPE support installing on pole or installing on wall. The following introduces the two ways separately.



Caution: The direction of CPE cable exit end must be down.

2.2 Interface and Button

Table 2-1 CW0100 Interface and button

Connectors	Description
ETH RJ45	One LAN
USIM Slot	Support 1.8V/3.0V USIM
Restore Button	Long press over 10s to restore the factory settings

2.3 LED Indicators

Table 2-2 LED Indicators

LED Name	Description	Color	LED Behavior	Status Indicator
PWR	Power Indicator	Green	OFF	No Power Supply
			Steady On	Power On
LTE Signal	3 LTEs, Indicate connection state and signal strength	Green	All OFF	No Connected
			ALL blanking	Connecting
			One LED Steady On	Connected, the signal is weak
			Two LED Steady On	Connected, the signal is medium
			Three LED Steady On	Connected, the signal is strong
LAN	Eth Indication	Green	OFF	Ethernet connection is not established
			Steady On	Ethernet connection is normal
			Blanking	Ethernet interface data being transmitted

2.4 RF Specifications

Table 2-3 RF Specification

Feature	Capability	
	Value	Unit
Mode	TDD	
Channel Bandwidth	5/10/15/20	MHz
Max Output Power	24	dBm
LTE Standard	3GPP R9	
Frequency	3650 ~ 3700	MHz
Antenna Gain	11	dBi

2.5 Install on Pole

Installing on pole have three methods: traditional on pole, telegraph on pole and iron on tower.

- Traditional on pole: Required diameter of the pole is 25mm to 45mm.
- Telegraph on pole: If the pole is telegraph, you need to install a pole that length is over 700mm and diameter is 25mm to 45mm as the mounting bracket.
- Iron on tower: If CPE is installed on iron tower, you need to choose vertical direction angle iron as the mounting bracket. The length is about 25mm to 45mm.

Installation steps is as follows:

1. Loosen iron hold hoop use the screw driver, make the hold hoop through the mounting hole and fix with the pole.

Figure 2-2 Install on pole A

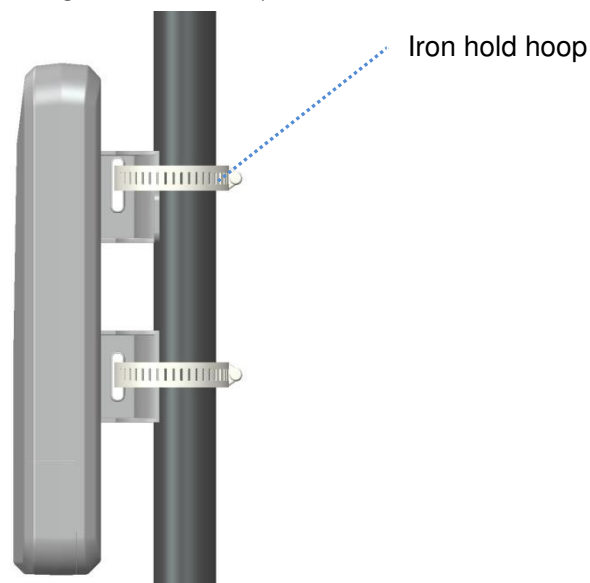

2. Locking the iron hold hoop use screw driver, fasten the CPE with the pole.

Figure 2-3 Install on pole B

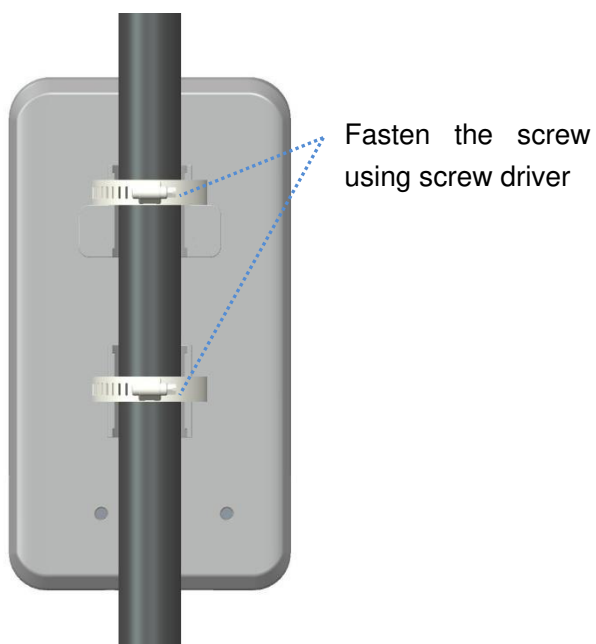

2.6 Install on Wall

When CW0100 installs on wall, the installation method is as follows:

On the wall, fix two big head screw which distance is 52mm, and then hang the CPE on the big head screw.

Figure 2-4 Mounting Hole of Install on Wall

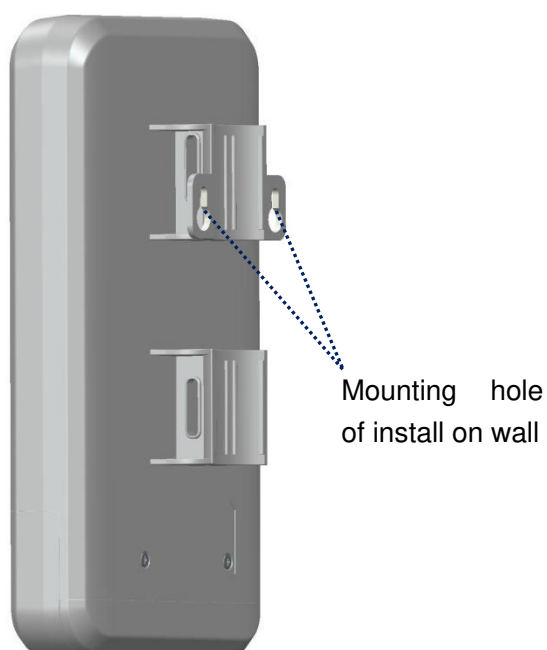

3. Wire Connection

3.1 Make Ethernet Cable Connector

CW0100 outdoor CPE need to use shielded CAT5 twisted pair, the operation steps of making connector is as follows::

1. Before making the RJ-45 shielded connector, strip the outer Jacket of the twisted pair about 30mm using crimping tool, which is shown in Figure 3-1.

Figure 3-1 Strip Shielded Twisted Pair



2. Separate the metal net, wire of cable and aluminum foil layer of twisted pair, as shown in Figure 3-2.

Figure 3-2 Separate the metal net, wire of cable and aluminum foil layer

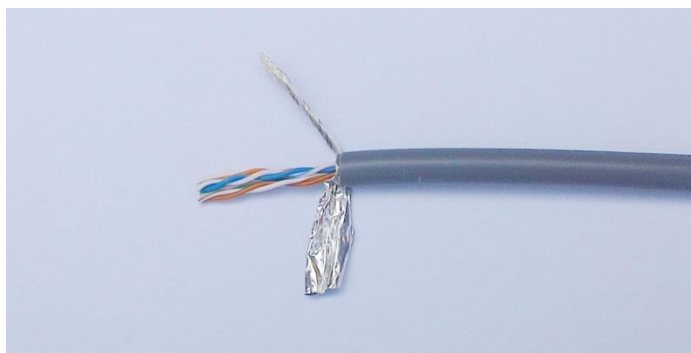

3. Cut off the aluminum foil layer of twisted pair using diagonal pliers, as shown in Figure 3-3.

Figure 3-3 Cut off the aluminum foil layer of twisted pair

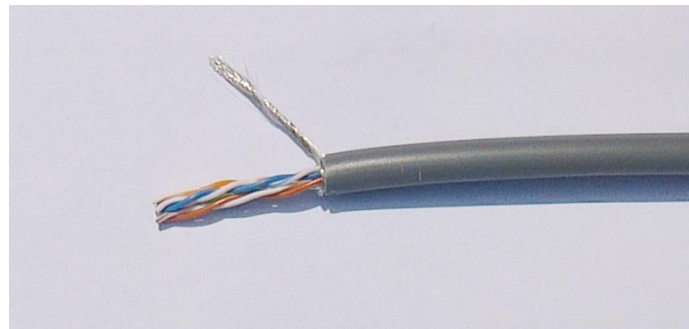

- The mode of connection is standard straight through cable. The color order is white/orange, orange, white/green, blue, white/blue, green, white/brown, brown, which is shown in Figure 3-4. The color order is important to get corrected.

Figure 3-4 Color Order

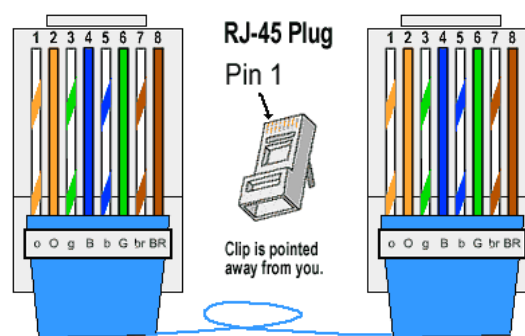

- Insert the eight wires into the line card according to the color order, shorten them to a suitable length (about 12 mm) using diagonal pliers, as shown in Figure 3-5.

Figure 3-5 Insert the twisted pair core into line card

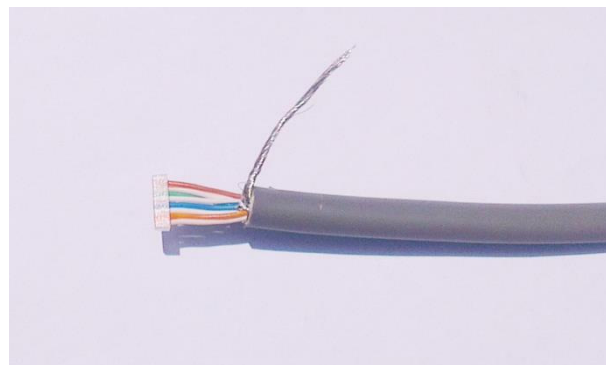

- Insert the line card having passed through eight wires into shielded connector, ensure that the wires go to the end. The line card that one side is plane, the other side is convex, ensure that the shielded connector match with the line card, as shown in Figure 3-6.

Figure 3-6 Insert line card into Connector



7. Crimping the cable using crimper, as shown in Figure 3-7.

Figure 3-7 Crimping connector

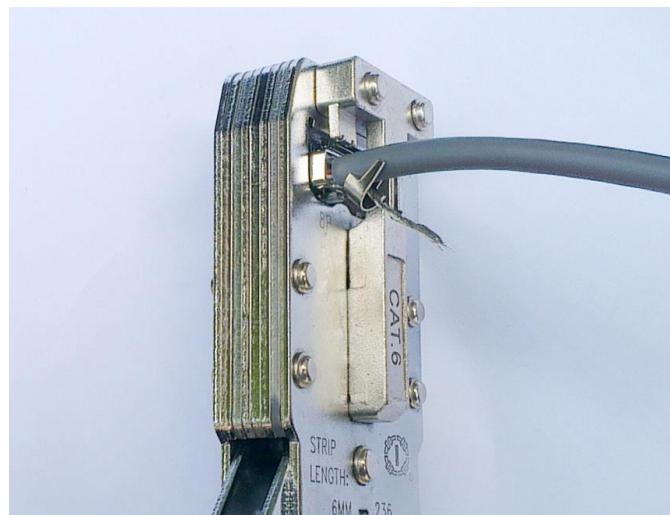

8. Impact the metal part of the shielded connector tail with the metal net shielded layer of the Ethernet cable using nipper pliers, as shown in Figure 3-8.

Figure 3-8 Impact the connector with cable shield layer

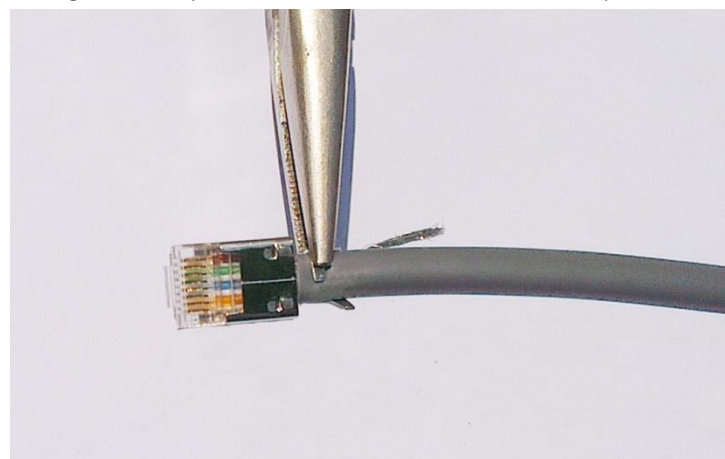

9. Cut off the redundant part of metal net using diagonal pliers, as shown in Figure 3-9.

Figure 3-9 Cut off the redundant part

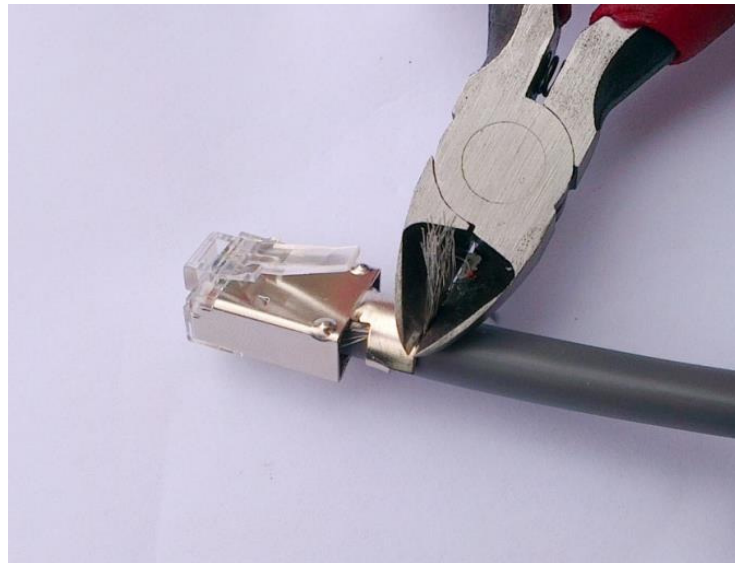

10. After the completion of shielded connector making, as shown in Figure 3-10.
Repeat all the steps and wire color on the other end of the cable.

Figure 3-10 Completion of shielded connector

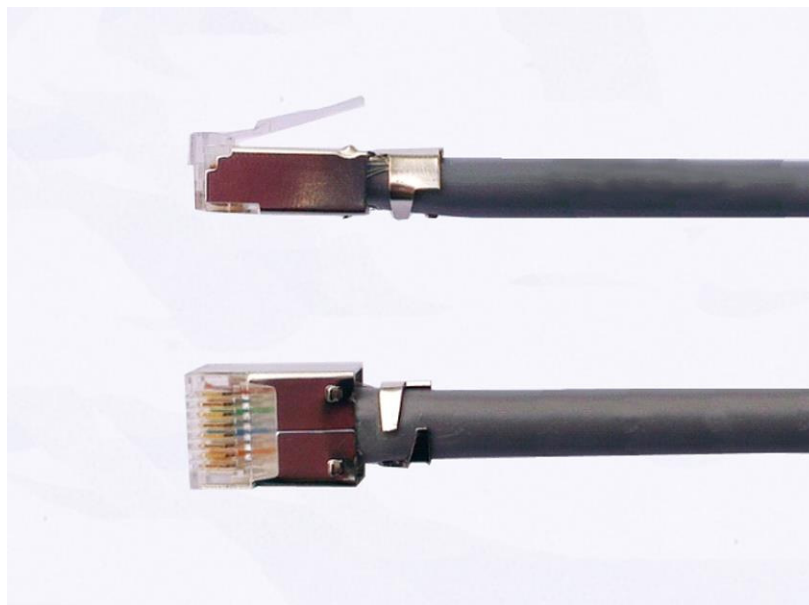

11. Test whether the cable is normal using Ethernet cable tester.
After the completion of two ends making, use Ethernet cable tester to test whether it

is normal. In the tester, if eight signal indicator and grounding indicator flash green in turn, it indicates that the Ethernet cable is normal. If any signal indicator is red or yellow, it indicates that there is circuit break or bad contact. You need to make a new connector again.

3.2 Connect Ethernet Cable

1. Connect the shielded cable to WAN interface of CPE, as shown in Figure 3-11.

Figure 3-11 Connect Cable 1



2. After connecting the Ethernet cable, cover the slide of CPE, as shown in Figure 3-12.

Figure 3-12 Connect Cable 2



3. Connect to POE power.

One end of the cable connect to CPE and the other end connect to POE power. Fix the cable on the pole using plastic tie close to CPE about 20cm, preventing the damage of the cable wagging with the wind.

It is recommended that the cable is fixed by plastic tie at intervals of 50cm until POE power. If the length of outdoor is too long, you need to protect the cable with metal shielded flexible sleeve.

3.3 Power On

CW0100 outdoor CPE is powered with POE. CPE provides standard POE power interface conformed to IEEE 802.3af standard. The 4, 5 (+), 7, 8 (-) wire have direct current. Before power on, test whether there is voltage output and whether voltage output is inverse with multimeter.

Power on CW0100 CPE with POE supply:

1. Connect DATA IN port of POE adaptor to one of a switch port with Ethernet cable.
2. Connect one end of grounding wire to PE terminal of POE adaptor and fasten it, the other end of grounding wire connect to grounding device.
3. Connect DATA&POWER OUT port of POE adaptor to POE port of CW0100 with Ethernet cable.

Place POE adaptor and switch in the room, which is shown in Figure 3-13.

Figure 3-13 POE power Mode

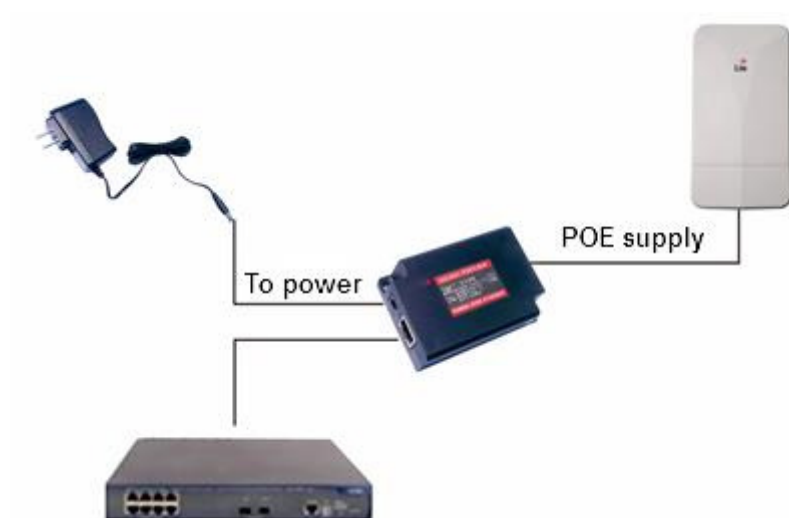

3.4 Lightning Protection of Cable

It need to use shielded cable and ensure the grounding of two ends of equipment. If the opposite equipment has plastic enclosure, which cannot be grounding. In this situation, the shielded cable function is decreased largely.

If its available, it is recommended that Ethernet cable and power cable pass through metal sleeve to ground separately. And they cannot be in a same metal sleeve.

It is highly recommended that the distance is as nearest as possible between the two equipment connected by Ethernet cable, avoiding the cable hanging in the air. According to the wiring environment, the lightning protection demand is different, the details is described in Table 3-1.

Table 3-1 Lightning Protection Demand of Cable

Number	Environment	Lightning Protection Demand
1	Completely in indoor or underground	No special demand
2	Outdoor part exceed 3m	4KV(10/700us)
3	Outdoor part exceed 10m	3KA
4	Outdoor part exceed 10m, and application environment is poor, such as the cable hanging in the air, strong lightning area, and so on.	5KA

4. Power on Detection

4.1 Detection Item

Power on detection includes the following four items:

- Ethernet port working status
- CPE configuration check
- CPE access test
- CPE parameter record

4.2 Ethernet Port Working Status

After CPE powered on, waiting for 2 minutes, connect the Ethernet port of PC to POE adaptor.

The CW0100 CPE default IP address is 192.168.1.1. Set the IP address of PC is 192.168.1.2, ensure that the Ethernet indicator get light and ping CPE IP address normal.

4.3 CPE Configuration Check

Log in the WebUI of CPE, check whether the software version is correct, whether the LTE mode is enabled, and whether WAN interface and LAN interface are consistent with plan.

4.4 CPE Access Test

Insert into USIM card, set the WAN interface to LTE mode, set LTE to auto connection, check terminal connection status, and check whether the terminal can san LTE signal and get IP address. After the connection is established, service testing can be made, such as HTTP, FTP, and so on.

4.5 CPE Parameter Record

Record parameter of CPE, such as installation site, installation height, antenna direction angle, and so on.

5. Regulatory Compliance

FCC Compliance

This device complies with part 15 of the FCC Rules. Operation is subject to the following two conditions: (1) This device may not cause harmful interference, and (2) this device must accept any interference received, including interference that may cause undesired operation.

Any Changes or modifications not expressly approved by the party responsible for compliance could void the user's authority to operate the equipment.

This equipment has been tested and found to comply with the limits for a Class B digital device, pursuant to part 15 of the FCC Rules. These limits are designed to provide reasonable protection against harmful interference in a residential installation. This equipment generates uses and can radiate radio frequency energy and, if not installed and used in accordance with the instructions, may cause harmful interference to radio communications. However, there is no guarantee that interference will not occur in a particular installation. If this equipment does cause harmful interference to radio or television reception, which can be determined by turning the equipment off and on, the user is encouraged to try to correct the interference by one or more of the following measures:

- Reorient or relocate the receiving antenna.
- Increase the separation between the equipment and receiver.
- Connect the equipment into an outlet on a circuit different from that to which the receiver is connected.
- Consult the dealer or an experienced radio/TV technician for help.

Warning

This equipment complies with FCC radiation exposure limits set forth for an uncontrolled environment. This equipment should be installed and operated with minimum distance 20 cm between the radiator & your body.

IC Compliance

This device complies with Industry Canada licence-exempt RSS standard(s). Operation is subject to the following two conditions: (1) This device may not cause interference, and (2) This device must accept any interference, including interference that may cause undesired operation of the device.

Le présent appareil est conforme aux CNR d'Industrie Canada applicables aux appareils radio exempts de licence. L'exploitation est autorisée aux deux conditions suivantes:

- (1) l'appareil ne doit pas produire de brouillage, et
- (2) l'utilisateur de l'appareil doit accepter tout brouillage radioélectrique subi, même si le brouillage est susceptible d'en compromettre le fonctionnement.

The antenna(s) used for this transmitter must be installed to provide a separation distance of at least 20 cm from all persons and must not be collocated or operating in conjunction with any other antenna or transmitter, End-Users must be provided with transmitter operation conditions for satisfying RF exposure compliance.

Appendix A **FAQ**

CPE is unable to power on	Check whether POE power is connected normal.
	Check whether the Ethernet cable is damaged and wire order is correct.
CPE service is unable to running normal	Check whether it is correct that the network configuration of CPE.
	Check whether the CPE have connected to LTE network.
CPE receive download signal weak	If external antenna is used, check whether antenna feed system have connected normal. (The standing wave measuring can be used.)
	Check whether the internal coaxial-cable gets loose.
CPE is unable to connect base station	Check whether it is normal that the CPE receives signal.
	Check whether the software version that CPE has download is consistent with the software version of base station.
	Check the data card frequency band of CPE is consistent with the base station.