



FCC TEST REPORT

FCC ID: 2AG2KLGUNTANGLEDPRO

Product Name	:	Untangled Pro Bluetooth Wireless Headphone
Model Name	:	Untangled Pro
Brand Name	:	Lilgadgets
Report No.	:	PTC21062301712E-FC01
Prepared for		
A&H Design Group, Ltd		
Suite 608, Tower One, Harbour Centre 1 Hok Cheung Street, Hung Hom Kowloon, Hong Kong		
Prepared by		
Precise Testing & Certification Co., Ltd.		
Building 1, No. 6, Tongxin Road, Dongcheng Street, Dongguan, Guangdong, China		



1 TEST RESULT CERTIFICATION

Applicant's name : A&H Design Group, Ltd
Address : Suite 608, Tower One, Harbour Centre 1 Hok Cheung Street, Hung Hom Kowloon, Hong Kong
Manufacture's name : A&H Design Group, Ltd
Address : Suite 608, Tower One, Harbour Centre 1 Hok Cheung Street, Hung Hom Kowloon, Hong Kong
Product name : Untangled Pro Bluetooth Wireless Headphone
Model name : Untangled Pro
Standards : FCC CFR47 Part 15 Section 15.247
Test procedure : ANSI C63.10:2013
Test Date : Jul. 25, 2021 to Jul. 29, 2021
Date of Issue : Jul. 29, 2021
Test Result : Pass

This device described above has been tested by PTC, and the test results show that the equipment under test (EUT) is in compliance with the FCC requirements. And it is applicable only to the tested sample identified in the report.

This report shall not be reproduced except in full, without the written approval of PTC, this document may be altered or revised by PTC, personal only, and shall be noted in the revision of the document.

Test Engineer:

Leo Yang / Engineer

Technical Manager:

Chris Du / Manager



Contents

	Page
1 TEST RESULT CERTIFICATION.....	2
2 TEST SUMMARY.....	5
3 TEST FACILITY.....	6
4 GENERAL INFORMATION.....	7
4.1 GENERAL DESCRIPTION OF E.U.T.....	7
4.2 TEST MODE.....	8
5 EQUIPMENT DURING TEST.....	10
5.1 EQUIPMENTS LIST.....	10
5.2 MEASUREMENT UNCERTAINTY.....	12
5.3 DESCRIPTION OF SUPPORT UNITS.....	13
6 CONDUCTED EMISSION.....	14
6.1 E.U.T. OPERATION.....	14
6.2 EUT SETUP.....	14
6.3 TEST SET-UP (BLOCK DIAGRAM OF CONFIGURATION).....	15
6.4 MEASUREMENT PROCEDURE:.....	15
6.5 CONDUCTED EMISSION LIMIT.....	15
6.6 MEASUREMENT DESCRIPTION.....	15
6.7 CONDUCTED EMISSION TEST RESULT.....	15
7 RADIATED SPURIOUS EMISSIONS.....	18
7.1 EUT OPERATION.....	18
7.2 TEST SETUP.....	19
7.3 SPECTRUM ANALYZER SETUP.....	20
7.4 TEST PROCEDURE.....	21
7.5 SUMMARY OF TEST RESULTS.....	22
8 MAXIMUM PEAK OUTPUT POWER TEST.....	29
8.1 TEST STANDARD AND LIMIT.....	29
8.2 TEST SETUP.....	29
8.3 TEST PROCEDURE.....	29
8.4 TEST DATA.....	29



9 20DB OCCUPY BANDWIDTH TEST..... 34

 9.1 TEST STANDARD..... 34

 9.2 TEST SETUP..... 34

 9.3 TEST PROCEDURE..... 34

 9.4 TEST DATA..... 34

10 CARRIER FREQUENCY SEPARATION TEST.....41

 10.1 TEST STANDARD AND LIMIT..... 41

 10.2 TEST SETUP..... 41

 10.3 TEST PROCEDURE..... 41

 10.4 TEST DATA..... 41

11 NUMBER OF HOPPING CHANNEL TEST..... 46

 11.1 TEST STANDARD AND LIMIT..... 46

 11.2 TEST SETUP..... 46

 11.3 TEST PROCEDURE..... 46

 11.4 TEST DATA..... 47

12 DWELL TIME TEST.....49

 12.1 TEST STANDARD AND LIMIT..... 49

 12.2 TEST SETUP..... 49

 12.3 TEST PROCEDURE..... 49

 12.4 TEST DATA..... 50

13 100KHZ BANDWIDTH OF FREQUENCY BAND EDGE REQUIREMENT..... 52

 13.1 TEST STANDARD AND LIMIT..... 52

 13.2 TEST SETUP..... 52

 13.3 TEST PROCEDURE..... 52

 13.4 TEST DATA..... 53

14 ANTENNA REQUIREMENT.....62

 14.1 TEST STANDARD AND REQUIREMENT..... 62

 14.2 ANTENNA CONNECTED CONSTRUCTION..... 62

15 APPENDIX I -- TEST SETUP PHOTOGRAPH..... 63

16 APPENDIX II -- EXTERNAL PHOTOGRAPH..... 65

17 APPENDIX III -- INTERNAL PHOTOGRAPH..... 70



2 Test Summary

Test Items	Test Requirement	Result
Radiated Spurious Emissions	15.205(a) 15.209 15.247(d)	PASS
Band edge	15.247(d) 15.205(a)	PASS
Conduct Emission	15.207	PASS
20dB Bandwidth	15.247(a)(1)	PASS
Maximum Peak Output Power	15.247(b)(3)	PASS
Frequency Separation	15.247(a)(1)	PASS
Number of Hopping Frequency	15.247(a)(1)(iii)	PASS
Dwell time	15.247(a)(1)(iii)	PASS
Antenna Requirement	15.203	PASS



Report No.: PTC21062301712E-FC01

3 TEST FACILITY

Precise Testing & Certification Co., Ltd.

Address: Building 1, No. 6, Tongxin Road, Dongcheng Street, Dongguan, Guangdong, China

FCC Registration Number: 790290

A2LA Certificate No.: 4408.01

IC Registration Number: 12191A-1



4 General Information

4.1 General Description of E.U.T.

Product Name	:	Untangled Pro Bluetooth Wireless Headphone
Model Name	:	Untangled Pro
Additional model	:	LGUT-01-WH/LGUT-02-BK/LGUT-03-BE/LGUT-04-PK/LGUT-05-PU/LGUT-06-GR/LGUT-07-SC/LGUT-08-DC/LGUT-09-RC/LGUT-10-FD
Bluetooth Version	:	BT 5.0 BDR+EDR
Operating frequency	:	2402-2480MHz
Numbers of Channel	:	79 channels For BR+EDR;
Type of Modulation	:	GFSK, $\pi/4$ -DQPSK, 8DPSK For DSS;
Antenna Type	:	PCB Antenna
Antenna Gain	:	0 dBi
Power supply	:	Input: DC 5V, 500mA(with DC 3.7V, 400mAh Battery inside)
Hardware Version	:	N/A
Software Version	:	N/A



4.2 Test Mode

The EUT has been tested under its typical operating condition. Pre-defined engineering program for regulatory testing used to control the EUT for staying in continuous transmitting. Only the worst case data were reported.

The EUT has been associated with peripherals pursuant to ANSI C63.10-2013 and configuration operated in a manner tended to maximize its emission characteristics in a typical application. Frequency range investigated: radiation (9 KHz to the 10th harmonics of the highest fundamental frequency or to 40 GHz, whichever is lower).

The EUT has been tested under TX operating condition.

This EUT is a FHSS system, were conducted to determine the final configuration from all possible combinations. We use software control the EUT, Let EUT hopping on and transmit with highest power, all the modes GFSK, $\pi/4$ -DQPSK, 8DPSK have been tested. 79 Channels are provided by EUT. The 3 channels of lower, medium and higher were chosen for test.

Channel List:

Channel	Frequency (MHz)	Channel	Frequency (MHz)	Channel	Frequency (MHz)	Channel	Frequency (MHz)
0	2402	1	2403	2	2404	3	2405
4	2406	5	2407	6	2408	7	2409
8	2410	9	2411	10	2412	11	2413
12	2414	13	2415	14	2416	15	2417
16	2418	17	2419	18	2420	19	2421
20	2422	21	2423	22	2424	23	2425
24	2426	25	2427	26	2428	27	2429
28	2430	29	2431	30	2432	31	2433
32	2434	33	2435	34	2436	35	2437
36	2438	37	2439	38	2440	39	2441
40	2442	41	2443	42	2444	43	2445
44	2446	45	2447	46	2448	47	2449
48	2450	49	2451	50	2452	51	2453
52	2454	53	2455	54	2456	55	2457
56	2458	57	2459	58	2460	59	2461
60	2462	61	2463	62	2464	63	2465
64	2466	65	2467	66	2468	67	2469
68	2470	69	2471	70	2472	71	2473
72	2474	73	2475	74	2476	75	2477
76	2478	77	2479	78	2480	-	-



Channel	Frequency(MHz)
0	2402
39	2441
78	2480



5 Equipment During Test

5.1 Equipments List

RF Conducted Test

Name of Equipment	Manufacturer	Model	Serial No.	Characteristics	Calibration Due
MXG Signal Analyzer	Agilent	N9020A	SER MY5111038	10Hz-30GHz	Aug. 21, 2021
Coaxial Cable	CDS	79254	46107086	10Hz-30GHz	Aug. 21, 2021
Power Meter	Anritsu	ML2495A	0949003	300MHz-40GHz	Aug. 21, 2021
Power Sensor	Anritsu	MA2411B	0917017	300MHz-40GHz	Aug. 21, 2021

Remark: The temporary antenna connector is soldered on the PCB board in order to perform conducted tests and this temporary antenna connector is listed in the equipment list.

Name of Equipment	Manufacturer	Model	Serial No.	Characteristics	Calibration Due
EMI Test Receiver	Rohde&Schwarz	ESCI	101417	9KHz-3GHz	Aug. 21, 2021
Loop Antenna	Schwarzbeck	FMZB 1519	012	9 KHz -30MHz	Aug. 21, 2021
Bilog Antenna	SCHWARZBECK	VULB9160	9160-3355	25MHz-2GHz	Aug. 21, 2021
Preamplifier (low frequency)	SCHWARZBECK	BBV 9475	9745-0013	1MHz-1GHz	Aug. 21, 2021
Cable	Schwarzbeck	PLF-100	549489	9KHz-3GHz	Aug. 21, 2021
Spectrum Analyzer	Agilent	E4407B	MY45109572	9KHz-40GHz	Aug. 21, 2021
Horn Antenna	SCHWARZBECK	9120D	9120D-1246	1GHz-18GHz	Aug. 21, 2021
Power Amplifier	LUNAR EM	LNA1G18-40	J10100000081	1GHz-26.5GHz	Aug. 21, 2021
Horn Antenna	SCHWARZBECK	BBHA 9170	9170-181	14GHz-40GHz	Aug. 21, 2021
Amplifier	SCHWARZBECK	BBV 9721	9721-205	18GHz-40GHz	Aug. 21, 2021
Cable	H+S	CBL-26	N/A	1GHz-26.5GHz	Aug. 21, 2021
RF Cable	R&S	R204	R21X	1GHz-40GHz	Aug. 21, 2021



Conducted Emissions

Name of Equipment	Manufacturer	Model	Serial No.	Characteristics	Calibration Due
EMI Test Receiver	Rohde&Schwarz	ESCI	101417	9KHz-3GHz	Aug. 19, 2021
Artificial Mains Network	Rohde&Schwarz	ENV216	102453	9KHz-300MHz	Aug. 19, 2021
Artificial Mains Network	Rohde&Schwarz	ENV216	101342	9KHz-300MHz	Aug. 19, 2021



5.2 Measurement Uncertainty

Parameter	Uncertainty
RF output power, conducted	±1.0dB
Power Spectral Density, conducted	±2.2dB
Radio Frequency	± 1 x 10 ⁻⁶
Bandwidth	± 1.5 x 10 ⁻⁶
Time	±2%
Duty Cycle	±2%
Temperature	±1°C
Humidity	±5%
DC and low frequency voltages	±3%
Conducted Emissions (150kHz~30MHz)	±3.64dB
Radiated Emission(30MHz~1GHz)	±5.03dB
Radiated Emission(1GHz~25GHz)	±4.74dB



5.3 Description of Support Units

Equipment	Information	Model No..
Battery	3.7V	N/A
Computer	Inspiron	M511R

6 Conducted Emission

Test Requirement: : FCC CFR 47 Part 15 Section 15.207
 Test Method: : ANSI C63.10:2013
 Test Result: : PASS
 Frequency Range: : 150kHz to 30MHz
 Class/Severity: : Class B
 Detector: : Peak for pre-scan (9kHz Resolution Bandwidth)

6.1 E.U.T. Operation

Operating Environment :

Temperature: : 23.2°C
 Humidity: : 51 % RH
 Atmospheric Pressure: : 101.12 kPa
 Test Voltage : AC 120V/60Hz

6.2 EUT Setup

The conducted emission tests were performed using the setup accordance with the ANSI C63.10: 2013

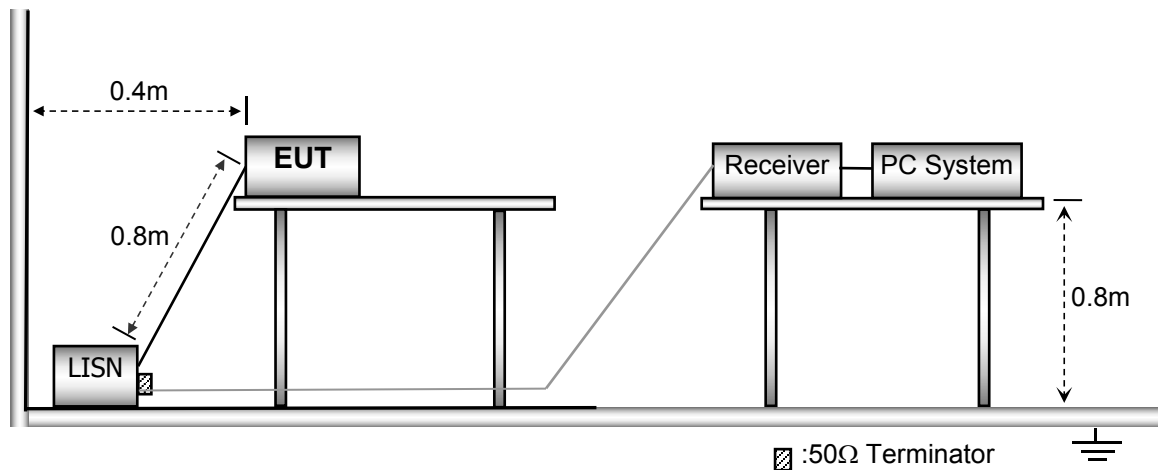

6.3 Test SET-UP (Block Diagram of Configuration)

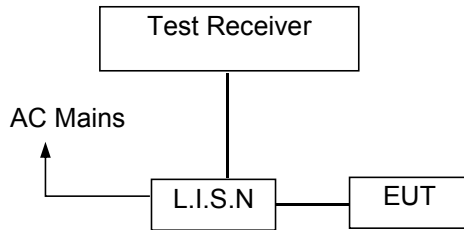

6.4 Measurement Procedure:

1. The EUT was placed on a table, which is 0.8m above ground plane.
2. Maximum procedure was performed on the six highest emissions to ensure EUT compliance.
3. Repeat above procedures until all frequency measured was complete.

6.5 Conducted Emission Limit

Conducted Emission

Frequency(MHz)	Quasi-peak	Average
0.15-0.5	66-56	56-46
0.5-5.0	56	46
5.0-30.0	60	50

Note:

1. The lower limit shall apply at the transition frequencies
2. The limit decreases in line with the logarithm of the frequency in the range of 0.15 to 0.50MHz.

6.6 Measurement Description

The maximised peak emissions from the EUT was scanned and measured for both the Live and Neutral Lines. Quasi-peak & average measurements were performed if peak emissions were within 6dB of the average limit line.

6.7 Conducted Emission Test Result

Pass

Conducted emission at both 120V & 240V is assessed, and emission at 120V represents the worst case. All the modulation modes were tested the data of the worst mode (GFSK) are recorded in the following pages and the others modulation methods do not exceed the limits.



Line -120V/60Hz:

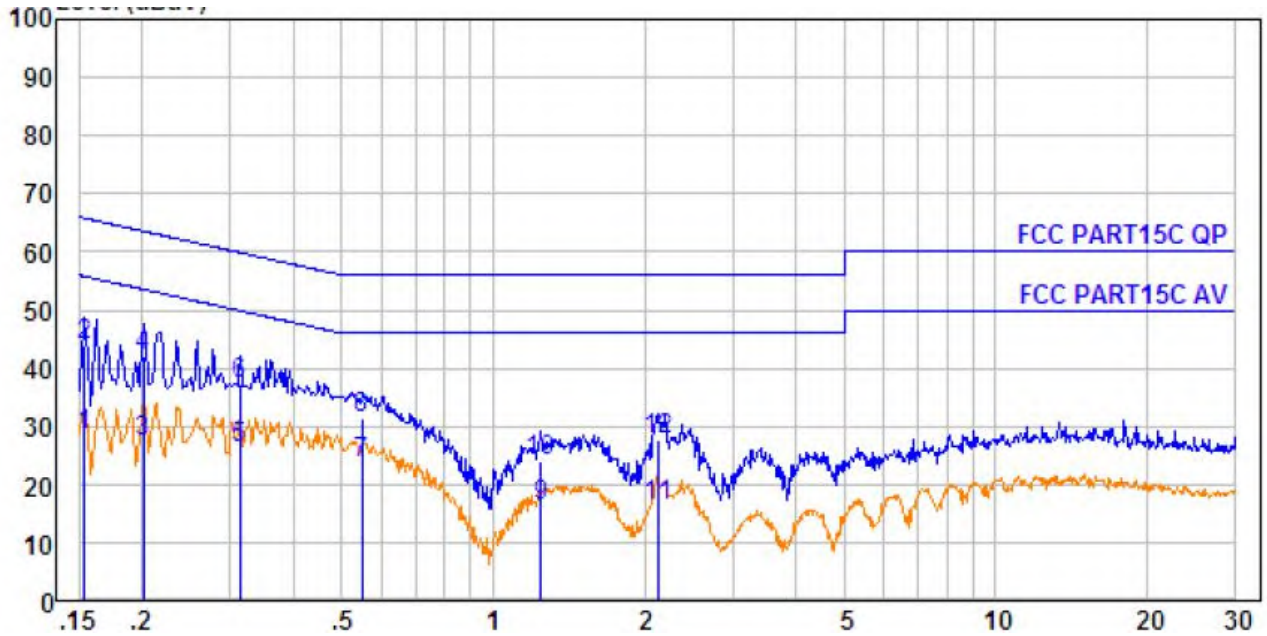

No.	Freq MHz	Cable Loss dB	AMN Factor dB	Receiver Reading dBuV	Emission Level dBuV	Limit dBuV	Over Limit dB	Remark
1.	0.154	0.21	9.59	18.79	28.59	55.78	-27.19	Average
2.	0.154	0.21	9.59	33.93	43.73	65.78	-22.05	QP
3.	0.202	0.28	9.59	17.59	27.46	53.54	-26.08	Average
4.	0.202	0.28	9.59	32.35	42.22	63.54	-21.32	QP
5.	0.313	0.38	9.60	16.26	26.24	49.88	-23.64	Average
6.	0.313	0.38	9.60	27.35	37.33	59.88	-22.55	QP
7.	0.549	0.43	9.61	13.69	23.73	46.00	-22.27	Average
8.	0.549	0.43	9.61	21.29	31.33	56.00	-24.67	QP
9.	1.242	0.46	9.61	6.06	16.13	46.00	-29.87	Average
10.	1.242	0.46	9.61	14.00	24.07	56.00	-31.93	QP
11.	2.133	0.47	9.61	6.20	16.28	46.00	-29.72	Average
12.	2.133	0.47	9.61	17.66	27.74	56.00	-28.26	QP



Neutral -120V/60Hz:

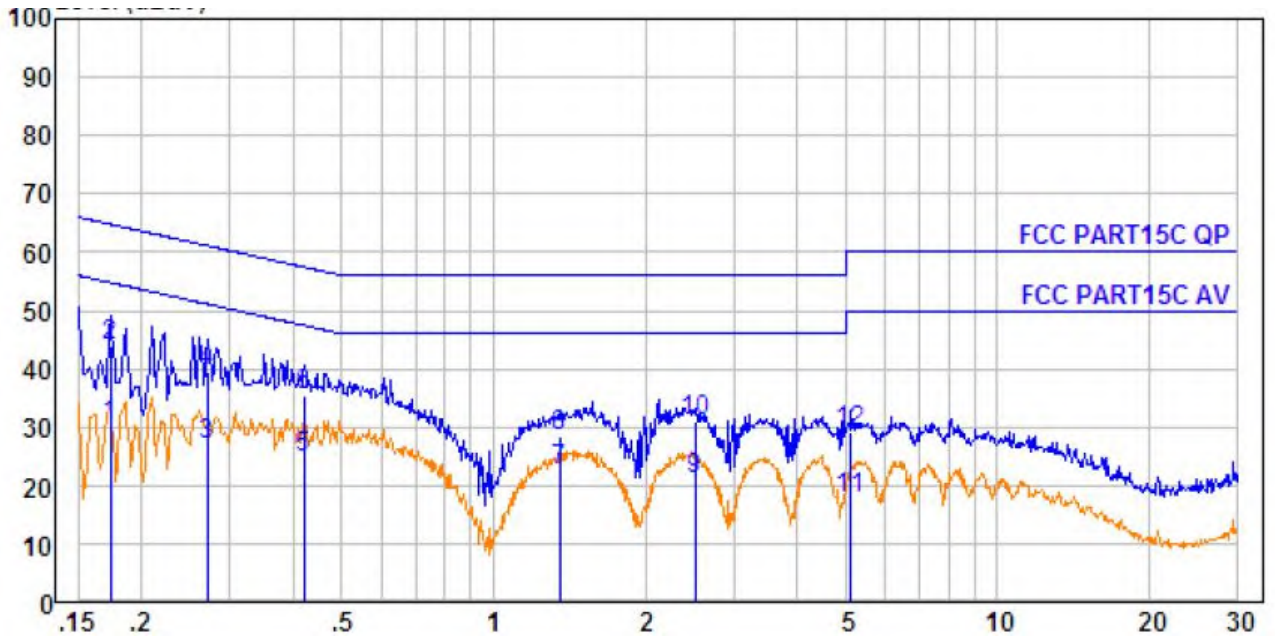

No.	Freq MHz	Cable Loss dB	AMN Factor dB	Receiver Reading dBuV	Emission Level dBuV	Limit dBuV	Over Limit dB	Remark
1.	0.174	0.24	9.60	20.38	30.22	54.77	-24.55	Average
2.	0.174	0.24	9.60	34.04	43.88	64.77	-20.89	QP
3.	0.270	0.35	9.62	16.93	26.90	51.12	-24.22	Average
4.	0.270	0.35	9.62	29.40	39.37	61.12	-21.75	QP
5.	0.421	0.41	9.63	14.66	24.70	47.42	-22.72	Average
6.	0.421	0.41	9.63	25.21	35.25	57.42	-22.17	QP
7.	1.352	0.46	9.64	12.40	22.50	46.00	-23.50	Average
8.	1.352	0.46	9.64	18.39	28.49	56.00	-27.51	QP
9.	2.513	0.47	9.65	11.02	21.14	46.00	-24.86	Average
10.	2.513	0.47	9.65	20.85	30.97	56.00	-25.03	QP
11.	5.112	0.51	9.71	7.54	17.76	50.00	-32.24	Average
12.	5.112	0.51	9.71	18.80	29.02	60.00	-30.98	QP



7 Radiated Spurious Emissions

Test Requirement : FCC CFR47 Part 15 Section 15.209 & 15.247
 Test Method : ANSI C63.10:2013
 Test Result : PASS
 Measurement Distance : 3m
 Limit : See the follow table

Frequency (MHz)	Field Strength		Field Strength Limit at 3m Measurement Dist	
	uV/m	Distance (m)	uV/m	dBuV/m
0.009 ~ 0.490	$2400/F(\text{kHz})$	300	$10000 * 2400/F(\text{kHz})$	$20\log^{(2400/F(\text{kHz}))} + 80$
0.490 ~ 1.705	$24000/F(\text{kHz})$	30	$100 * 24000/F(\text{kHz})$	$20\log^{(24000/F(\text{kHz}))} + 40$
1.705 ~ 30	30	30	$100 * 30$	$20\log^{(30)} + 40$
30 ~ 88	100	3	100	$20\log^{(100)}$
88 ~ 216	150	3	150	$20\log^{(150)}$
216 ~ 960	200	3	200	$20\log^{(200)}$
Above 960	500	3	500	$20\log^{(500)}$

7.1 EUT Operation

Operating Environment :

Temperature : 24.5 °C
 Humidity : 55.5% RH
 Atmospheric Pressure : 101.3kPa
 Test Voltage : DC 3.7V

7.2 Test Setup

The radiated emission tests were performed in the 3m Semi- Anechoic Chamber test site

The test setup for emission measurement below 30MHz.

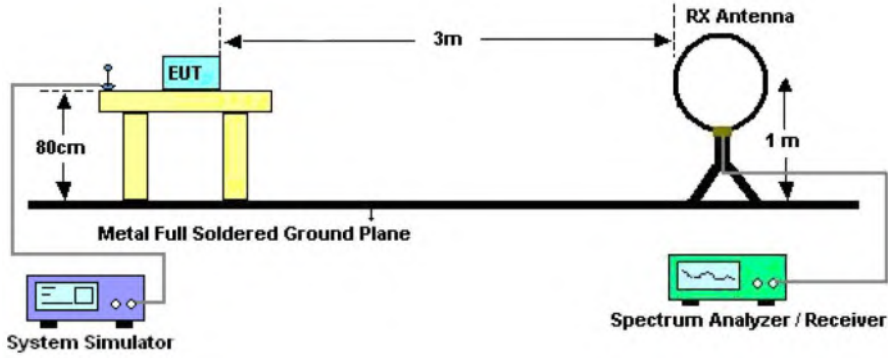

The test setup for emission measurement from 30 MHz to 1 GHz.

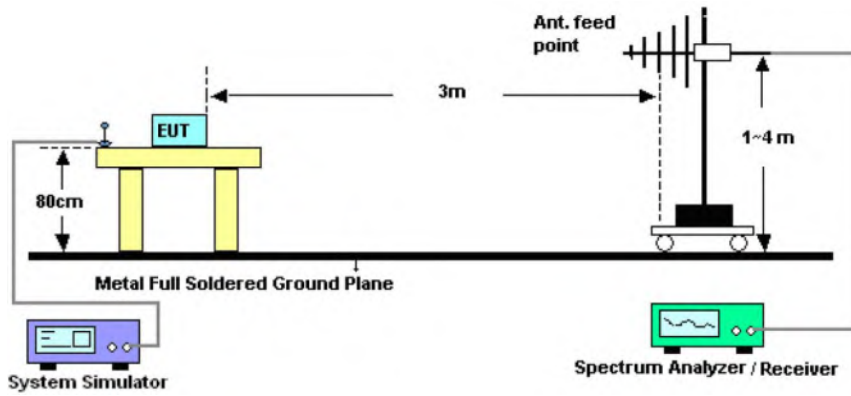

The test setup for emission measurement above 1 GHz.

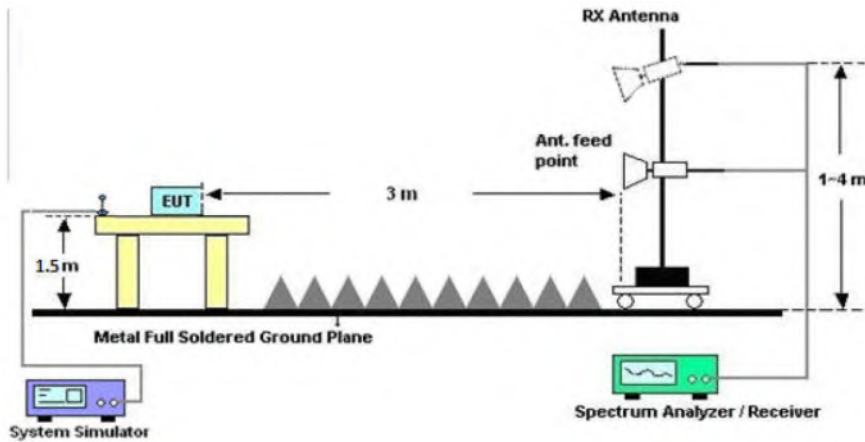



7.3 Spectrum Analyzer Setup

Spectrum Parameter	Setting
Attenuation	Auto
Start Frequency	1000 MHz
Stop Frequency	10th carrier harmonic
RB / VB (emission in restricted band)	1 MHz / 1 MHz for Peak, 1 MHz / 10Hz for Average

Receiver Parameter	Setting
Attenuation	Auto
Start ~ Stop Frequency	9kHz~150kHz / RB 200Hz for QP
Start ~ Stop Frequency	150kHz~30MHz / RB 9kHz for QP
Start ~ Stop Frequency	30MHz~1000MHz / RB 120kHz for QP



7.4 Test Procedure

1. The testing follows the guidelines in Spurious Radiated Emissions of ANSI C63.10-2013.
2. Below 1000MHz, The EUT was placed on a turn table which is 0.8m above ground plane. And above 1000MHz, The EUT was placed on a styrofoam table which is 1.5m above ground plane.
3. The EUT was set 3 meters from the interference receiving antenna, which was mounted on the top of a variable height antenna tower.
4. For each suspected emission, the EUT was arranged to its worst case and then tune the Antenna tower (From 1m to 4m) and turntable (from 0 degree to 360 degree) to find the maximum reading. A pre-amp and a high pass filter are used for the test in order to get better signal level to comply with the guidelines.
5. Set to the maximum power setting and enable the EUT transmit continuously.
6. Final measurement (Above 1GHz): The frequency range will be divided into different sub ranges depending of the frequency range of the used horn antenna. The EMI Receiver set to peak and average mode and a resolution bandwidth of 1MHz. The measurement will be performed in horizontal and vertical polarization of the measuring antenna and while rotating the EUT in its vertical axis in the range of 0 degree to 360 degree in order to have the antenna inside the cone of radiation.
7. Test Procedure of measurement (For Above 1GHz):
 - 1) Monitor the frequency range at horizontal polarization and move the antenna over all sides of the EUT(if necessary move the EUT to another orthogonal axis).
 - 2) Change the antenna polarization and repeat 1) with vertical polarization.
 - 3) Make a hardcopy of the spectrum.
 - 4) Measure the frequency of the detected emissions with a lower span and resolution bandwidth to increase the accuracy and note the frequency value.
 - 5) Change the analyser mode to Clear/ Write and found the cone of emission.
 - 6) Rotate and move the EUT, so that the measuring distance can be enlarged to 3m and the antenna will be still inside the cone of emission.
 - 7) Measure the level of the detected frequency with the correct resolution bandwidth, with the antenna polarization and azimuth and the peak and average detector, which causes the maximum emission.
 - 8) Repeat steps 1) to 7) for the next antenna spot if the EUT is larger than the antenna beamwidth.
7. The radiation measurements are tested under 3-axes(X,Y,Z) position(X denotes lying on the table, Y denotes side stand and Z denotes vertical stand), After pre-test, It was found that the worse radiation emission was get at the X position. So the data shown was the X position only.



7.5 Summary of Test Results

Test Frequency: 9KHz-30MHz

Freq. (MHz)	Ant.Pol. H/V	Emission Level (dBuV/m)	Limit 3m (dBuV/m)	Over (dB)
--	--	--	--	>20

Note:

The amplitude of spurious emission that is attenuated by more than 20dB below the permissible limit has no need to be reported.

Distance extrapolation factor = $40 \log(\text{Specific distance} / \text{test distance})$ (dB);
Limit line = Specific limits (dBuV) + distance extrapolation factor.

Test Frequency: 30MHz ~ 1GHz

Please refer to the following test plots, Low Channel (2402MHz) Worst case GFSK for record:



Test plot for Horizontal

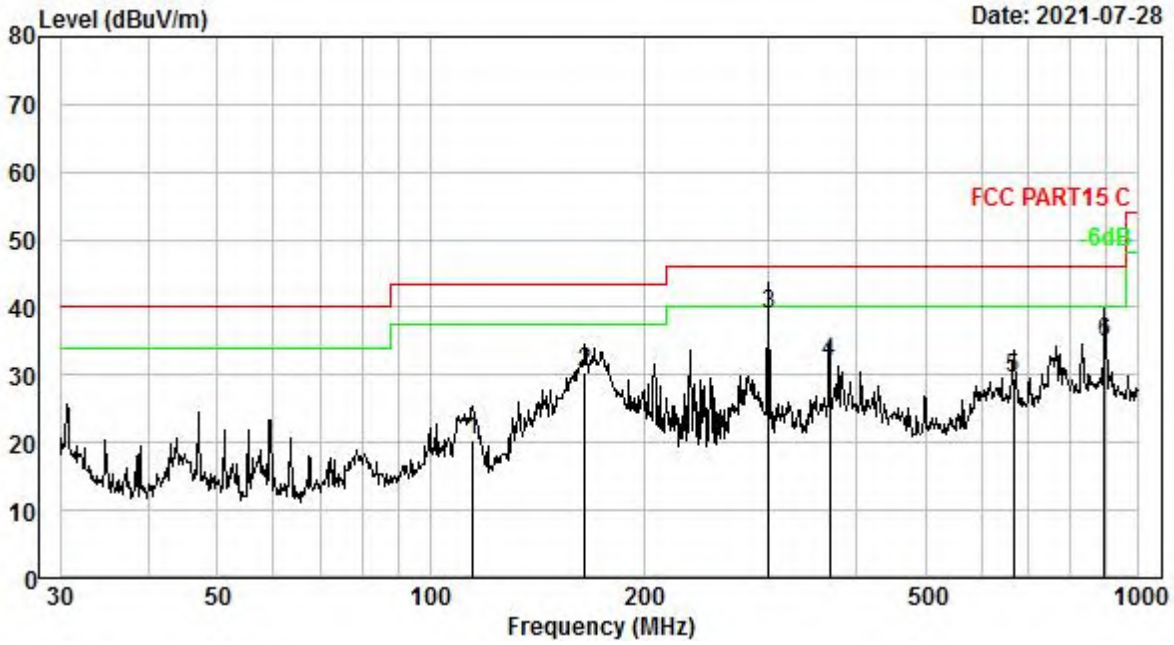

No.	Freq MHz	Cable Loss dB	ANT Factor dB/m	Receiver Reading dBuV	Preamp Factor dB	Emission Level dBuV/m	Limit dBuV/m	Over Limit dB	Remark
1.	114.917	3.51	11.40	35.36	30.00	20.27	43.50	-23.23	QP
2.	165.487	4.14	13.64	42.67	30.03	30.42	43.50	-13.08	QP
3.	300.367	5.16	13.21	50.77	30.32	38.82	46.00	-7.18	QP
4.	366.823	5.51	14.54	42.42	30.59	31.88	46.00	-14.12	QP
5.	665.804	6.53	19.76	34.31	31.06	29.54	46.00	-16.46	QP
6.	896.997	7.04	22.07	36.83	31.04	34.90	46.00	-11.10	QP

Remark: Emission Level = Reading + Cable Loss + ANT Factor - AMP Factor



Test plot for Vertical

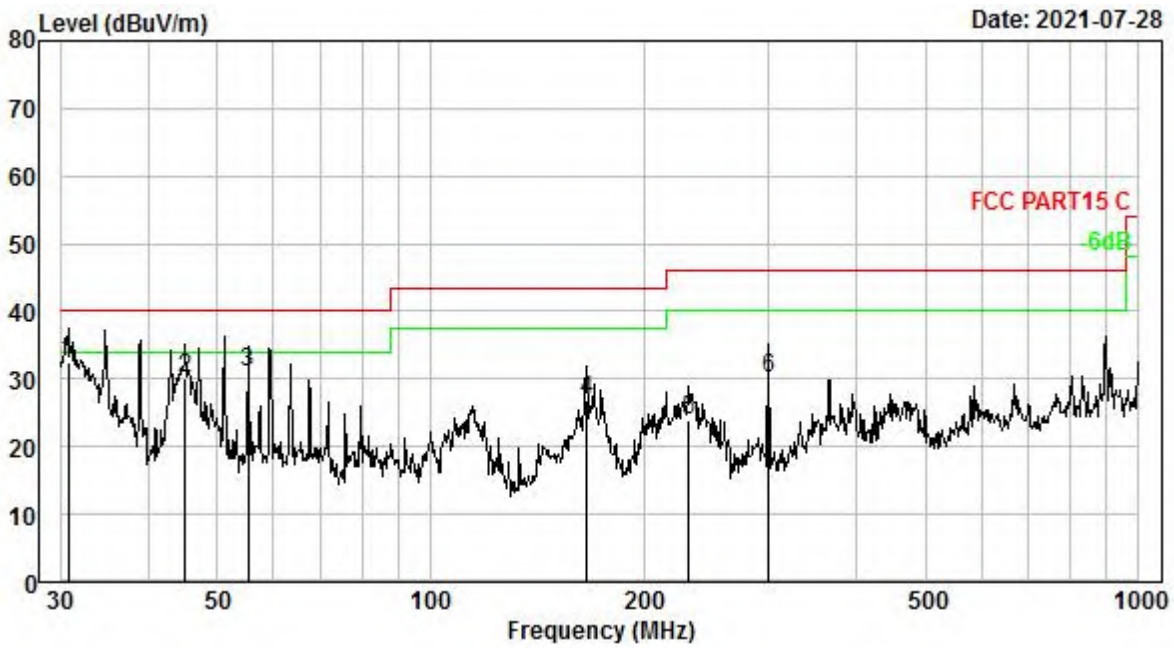

No.	Freq MHz	Cable Loss dB	ANT Factor dB/m	Receiver Reading dBuV	Preamplifier Factor dB	Emission Level dBuV/m	Limit dBuV/m	Over Limit dB	Remark
1.	30.745	1.24	11.78	49.27	29.89	32.40	40.00	-7.60	QP
2.	45.058	1.90	12.30	45.78	29.91	30.07	40.00	-9.93	QP
3.	55.221	2.25	12.08	46.57	29.93	30.97	40.00	-9.03	QP
4.	166.068	4.14	13.59	39.11	30.03	26.81	43.50	-16.69	QP
5.	231.718	4.71	11.99	37.45	30.14	24.01	46.00	-21.99	QP
6.	300.367	5.16	13.21	42.17	30.32	30.22	46.00	-15.78	QP

Remark: Emission Level = Reading + Cable Loss + ANT Factor - AMP Factor



Test Frequency 1GHz-25GHz

Test Mode: CH00					Test channel: Lowest			
Peak Value								
Frequency (MHz)	Read Level (dBuV)	Antenna Factor (dB/m)	Cable Loss (dB)	Preamp Factor (dB)	Level (dBuV/m)	Limit (dBuV/m)	Over Limit (dB)	Pol.
4804	46.02	34.04	6.58	34.09	52.55	74	-21.45	V
7206	43.11	37.11	7.73	34.5	53.45	74	-20.55	V
9608	42.97	39.31	9.23	34.79	56.72	74	-17.28	V
4804	45.05	34.04	6.58	34.09	51.58	74	-22.42	H
7206	46.13	37.11	7.73	34.5	56.47	74	-17.53	H
9608	39.88	39.31	9.23	34.79	53.63	74	-20.37	H
Average Value								
Frequency (MHz)	Read Level (dBuV)	Antenna Factor (dB/m)	Cable Loss (dB)	Preamp Factor (dB)	Level (dBuV/m)	Limit (dBuV/m)	Over Limit (dB)	Pol.
4804	31.11	34.04	6.58	34.09	37.64	54	-16.36	V
7206	26.03	37.11	7.73	34.5	36.37	54	-17.63	V
9608	22.16	39.31	9.23	34.79	35.91	54	-18.09	V
4804	27.98	34.04	6.58	34.09	34.51	54	-19.49	H
7206	25.98	37.11	7.73	34.5	36.32	54	-17.68	H
9608	26.12	39.31	9.23	34.79	39.87	54	-14.13	H



Test Mode: CH39					Test channel: Middle			
Peak Value								
Frequency (MHz)	Read Level (dBuV)	Antenna Factor (dB/m)	Cable Loss (dB)	Preamp Factor (dB)	Level (dBuV/m)	Limit (dBuV/m)	Over Limit (dB)	Pol.
4882	43.59	34.38	6.69	34.09	50.57	74	-23.43	V
7323	44.87	37.22	7.78	34.53	55.34	74	-18.66	V
9764	41.26	39.46	9.35	34.8	55.27	74	-18.73	V
4882	43.97	34.38	6.69	34.09	50.95	74	-23.05	H
7323	44.11	37.22	7.78	34.53	54.58	74	-19.42	H
9764	39.26	39.46	9.35	34.8	53.27	74	-20.73	H
Average Value								
Frequency (MHz)	Read Level (dBuV)	Antenna Factor (dB/m)	Cable Loss (dB)	Preamp Factor (dB)	Level (dBuV/m)	Limit (dBuV/m)	Over Limit (dB)	Pol.
4882	29.36	34.38	6.69	34.09	36.34	54	-17.66	V
7323	24.15	37.22	7.78	34.53	34.62	54	-19.38	V
9764	25.02	39.46	9.35	34.8	39.03	54	-14.97	V
4882	27.95	34.38	6.69	34.09	34.93	54	-19.07	H
7323	25.14	37.22	7.78	34.53	35.61	54	-18.39	H
9764	23.6	39.46	9.35	34.8	37.61	54	-16.39	H



Test Mode: CH78					Test channel: Middle			
Peak Value								
Frequency (MHz)	Read Level (dBuV)	Antenna Factor (dB/m)	Cable Loss (dB)	Preamp Factor (dB)	Level (dBuV/m)	Limit (dBuV/m)	Over Limit (dB)	Pol.
4960	43.98	34.72	6.79	34.09	51.4	74	-22.6	V
7440	42.87	37.34	7.82	34.57	53.46	74	-20.54	V
9920	41.59	39.62	9.46	34.81	55.86	74	-18.14	V
4960	43.36	34.72	6.79	34.09	50.78	74	-23.22	H
7440	42.07	37.34	7.82	34.57	52.66	74	-21.34	H
9920	41.02	39.62	9.46	34.81	55.29	74	-18.71	H
Average Value								
Frequency (MHz)	Read Level (dBuV)	Antenna Factor (dB/m)	Cable Loss (dB)	Preamp Factor (dB)	Level (dBuV/m)	Limit (dBuV/m)	Over Limit (dB)	Pol.
4960	30.59	34.72	6.79	34.09	38.01	54	-15.99	V
7440	25.76	37.34	7.82	34.57	36.35	54	-17.65	V
9920	24.01	39.62	9.46	34.81	38.28	54	-15.72	V
4960	26.99	34.72	6.79	34.09	34.41	54	-19.59	H
7440	24.13	37.34	7.82	34.57	34.72	54	-19.28	H
9920	23.21	39.62	9.46	34.81	37.48	54	-16.52	H

Note: 1. The testing has been conformed to 10*2480MHz=24800MHz.

2. All other emissions more than 30dB below the limit.

3. Factor = Antenna Factor + Cable Loss – Pre-amplifier.

Emission Level = Reading + Factor

Margin=Emission Level-Limit



Spurious Emission in Restricted Band 2310-2390MHz and 2483.5-2500MHz

Bluetooth (GFSK, Pi/4-DQPSK, 8DPSK, Hopping)mode have been tested, and the worst result(GFSK, Hopping) was report as below

Test Mode: Low Channel 2402MHz									
Frequency (MHz)	Read Level (dBuV)	Antenna Factor (dB/m)	Cable Loss (dB)	Preamp Factor (dB)	Level (dBuV/m)	Limit (dBuV/m)	Over (dB)	Polarity H/V	Test Value
2390	51.34	29.15	3.41	34.01	49.89	74	-24.11	H	Peak
2400	50.89	29.16	3.43	34.01	49.47	74	-24.53	H	Peak
2390	53.03	29.15	3.41	34.01	51.58	74	-22.42	V	Peak
2400	54.41	29.16	3.43	34.01	52.99	74	-21.01	V	Peak
2390	38.16	29.15	3.41	34.01	36.71	54	-17.29	H	AV
2400	42.29	29.16	3.43	34.01	40.87	54	-13.13	H	AV
2390	43.37	29.15	3.41	34.01	41.92	54	-12.08	V	AV
2400	42.25	29.16	3.43	34.01	40.83	54	-13.17	V	AV

Test Mode: High Channel 2480MHz									
Frequency (MHz)	Read Level (dBuV)	Antenna Factor (dB/m)	Cable Loss (dB)	Preamp Factor (dB)	Level (dBuV/m)	Limit (dBuV/m)	Over (dB)	Polarity H/V	Test Value
2483.5	55.69	29.28	3.53	34.03	54.47	74	-19.53	H	Peak
2500	47.24	29.3	3.56	34.03	46.07	74	-27.93	H	Peak
2483.5	56.24	29.28	3.53	34.03	55.02	74	-18.98	V	Peak
2500	46.11	29.3	3.56	34.03	44.94	74	-29.06	V	Peak
2483.5	40.03	29.28	3.53	34.03	38.81	54	-15.19	H	AV
2500	35.62	29.3	3.56	34.03	34.45	54	-19.55	H	AV
2483.5	38.79	29.28	3.53	34.03	37.57	54	-16.43	V	AV
2500	37.11	29.3	3.56	34.03	35.94	54	-18.06	V	AV



8 Maximum Peak Output Power Test

8.1 Test Standard and Limit

Test Standard	FCC Part15 C Section 15.247 (b)(3)
Test Limit	125mW

8.2 Test Setup

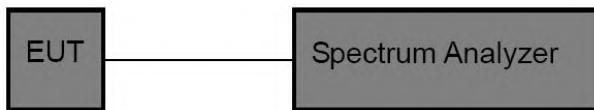

8.3 Test Procedure

- The EUT was directly connected to the spectrum analyzer and antenna output port as show in the block diagram above,
- Spectrum Setting:
 - RBW > the 20 dB bandwidth of the emission being measured
 - Span = approximately 5 times the 20 dB bandwidth, centered on a hopping channel
 - VBW ≥ RBW
 - Sweep = auto
 - Detector function = peak
 - Trace = max hold

8.4 Test Data

Test Item	: Max. peak output power	Test Mode	: CH Low ~ CH High
Test Voltage	: DC 3.7V Battery inside	Temperature	: 24.5°C
Test Result	: PASS	Humidity	: 55%RH



Channel Frequency (MHz)	Peak Power output (dBm)	Limit (dBm)	Results	Modulation
2402	1.53	20.96	PASS	BDR
2441	3.07	20.96	PASS	BDR
2480	3.34	20.96	PASS	BDR
2402	0.29	20.96	PASS	EDR
2441	1.54	20.96	PASS	EDR
2480	2.34	20.96	PASS	EDR

Remark: The EDR was tested on ($\pi/4$ DQPSK, 8DPSK) modes, only the worst data of (8DPSK) is attached in the following pages.

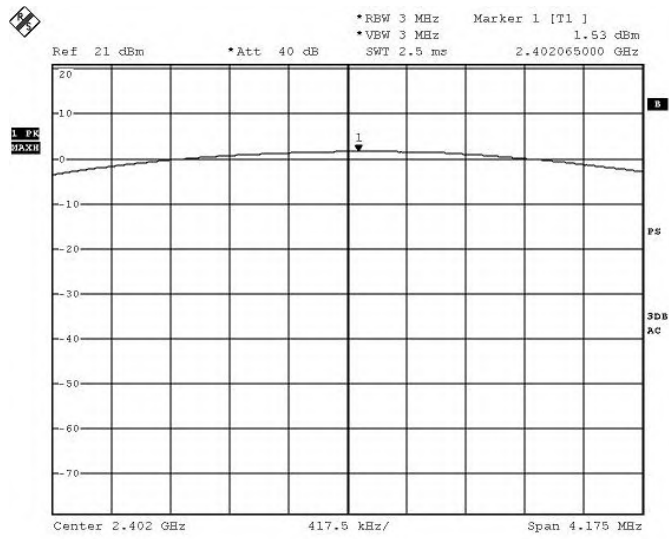

Test Mode: GFSK ---Low

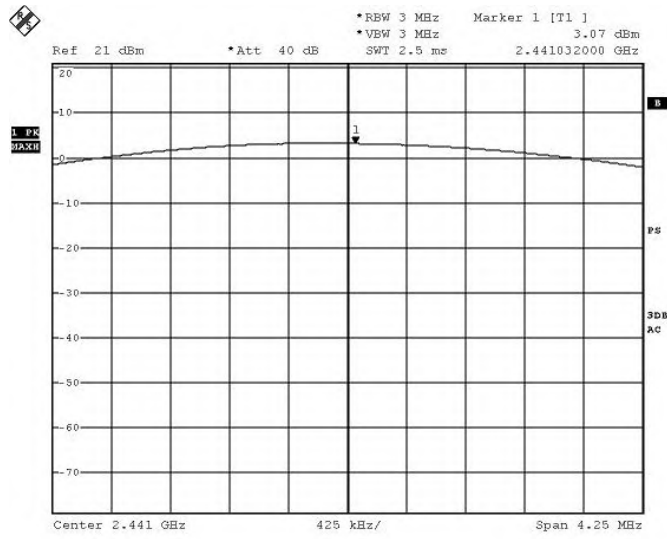

Test Mode: GFSK ---Middle

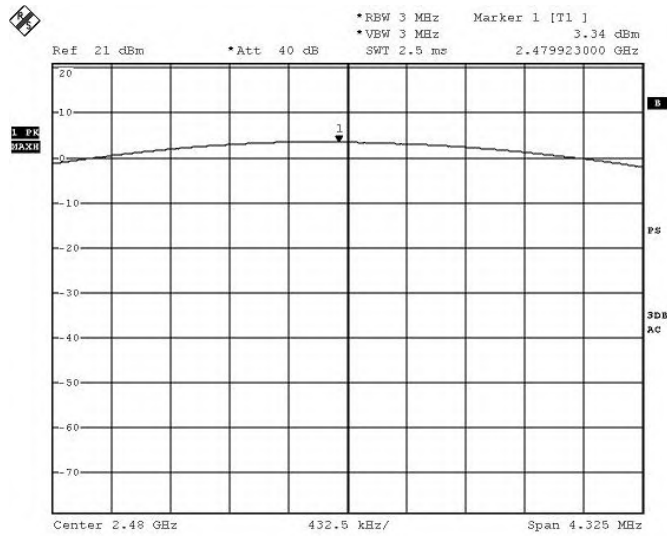

Test Mode: GFSK ---High

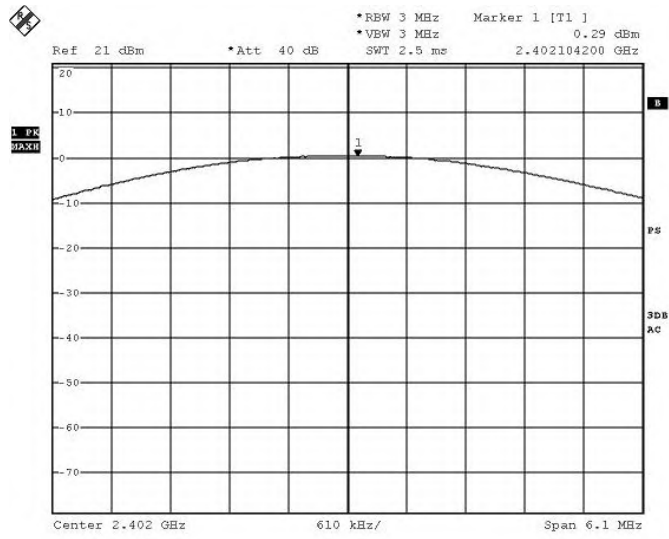

Test Mode: 8DPSK---Low

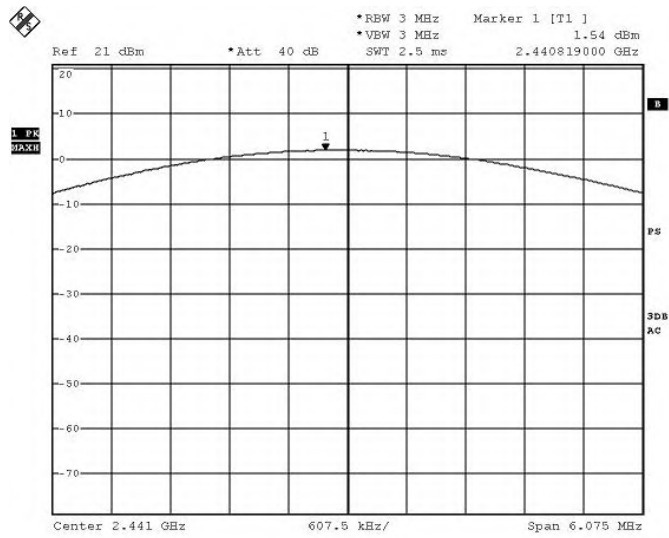

Test Mode: 8DPSK ---Middle

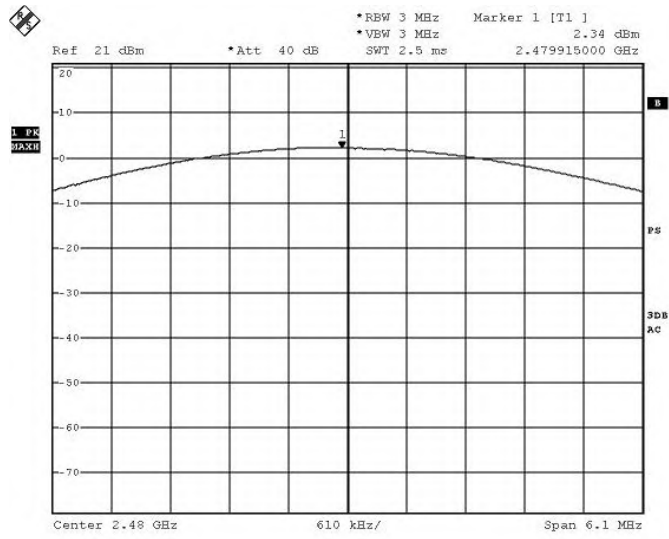

Test Mode: 8DPSK ---High



9 20DB Occupy Bandwidth Test

9.1 Test Standard

Test Standard	FCC Part15 C Section 15.247 (a)(1)
---------------	------------------------------------

9.2 Test Setup

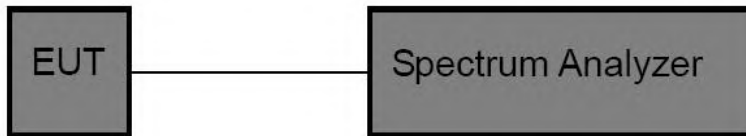

9.3 Test Procedure

Using the following spectrum analyzer settings:

1. Span= approximately 2 to 3 times the 20dB bandwidth, centered on a hopping channel.
2. Set the RBW = 30 kHz.
3. Set the VBW = 100 kHz.
4. Sweep time = auto couple.
5. Detector function = peak.
6. Trace mode = max hold.
7. Allow trace to fully stabilize.

9.4 Test Data

Test Item	: 20dB BW	Test Mode	: CH Low ~ CH High
Test Voltage	: DC 3.7V Battery inside	Temperature	: 24.5°C
Test Result	: PASS	Humidity	: 55%RH



Channel	Frequency(MHz)	20dB Down BW(kHz)	Modulation Mode
Low	2402	871.70	BDR
Middle	2441	869.80	BDR
High	2480	855.30	BDR
Low	2402	1222	EDR
Middle	2441	1223	EDR
High	2480	1222	EDR

Remark: The EDR was tested on ($\pi/4$ DQPSK, 8DPSK) modes, only the worst data of (EDR) is attached in the following pages.

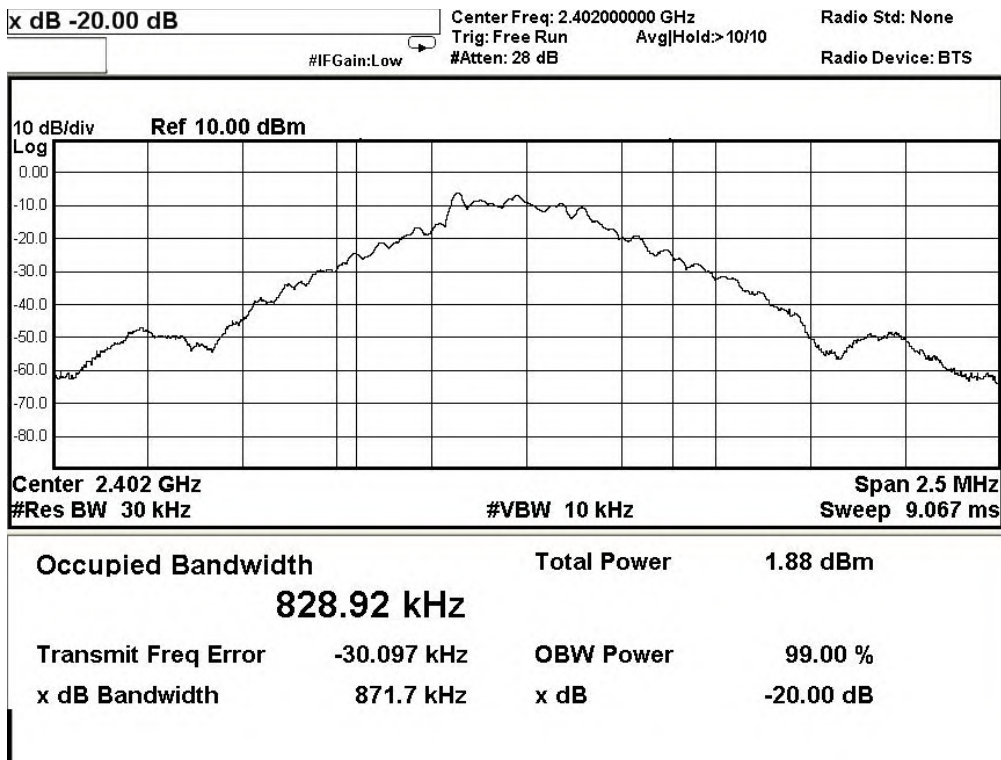

Test Mode: GFSK ---Low

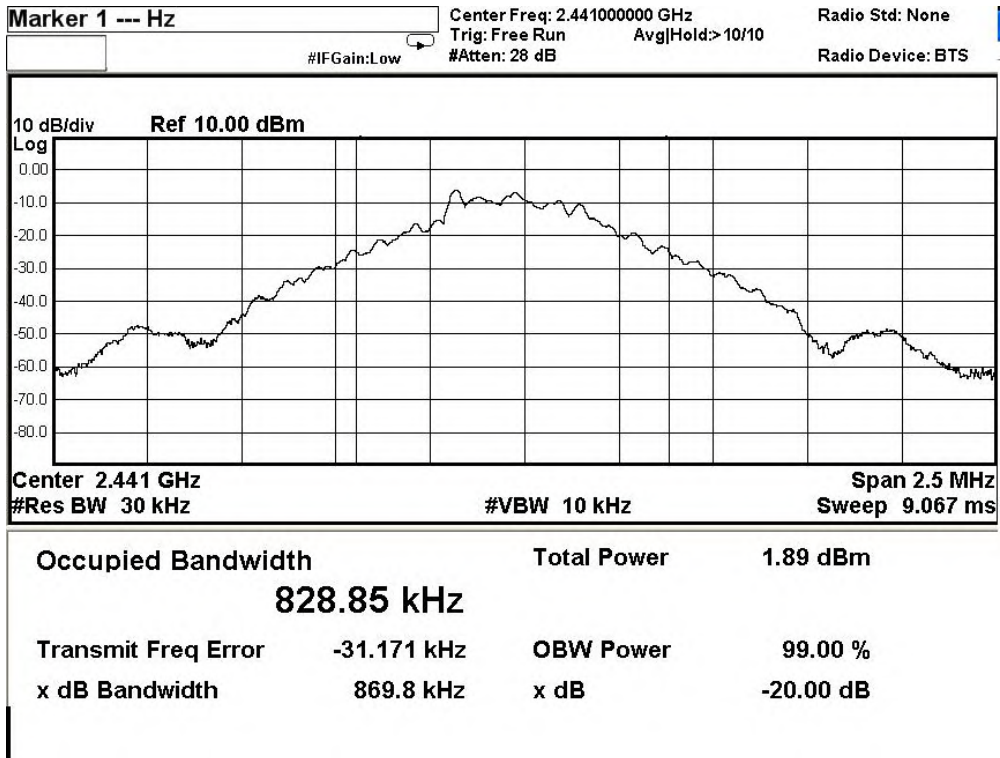

Test Mode: GFSK ---Middle

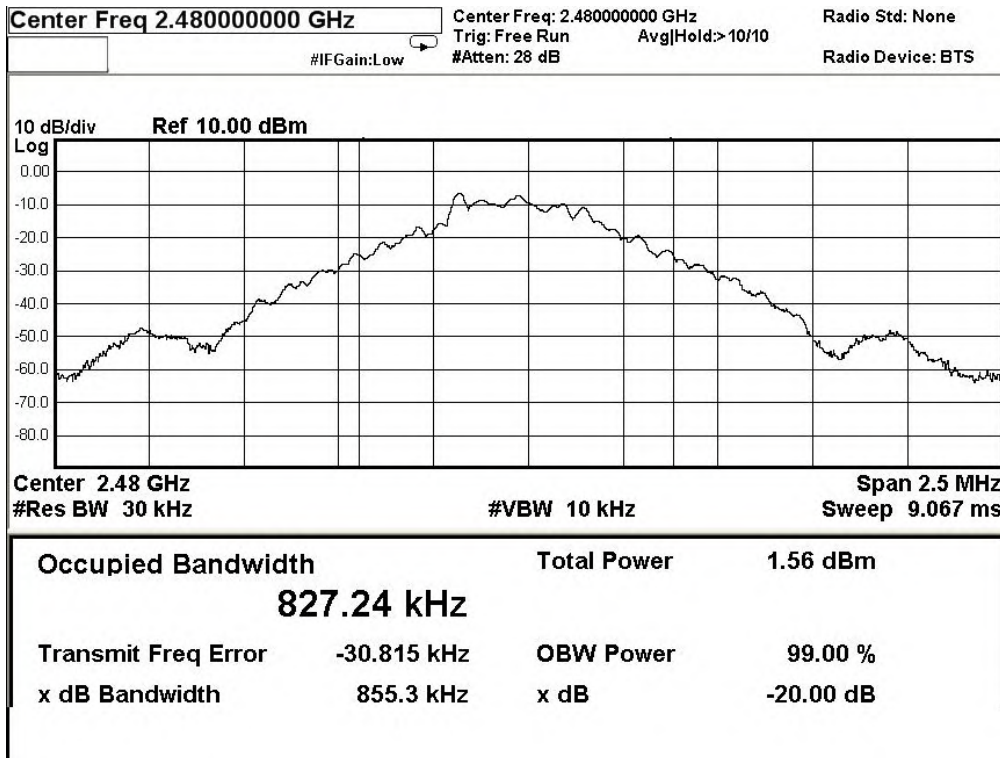

Test Mode: GFSK ---High

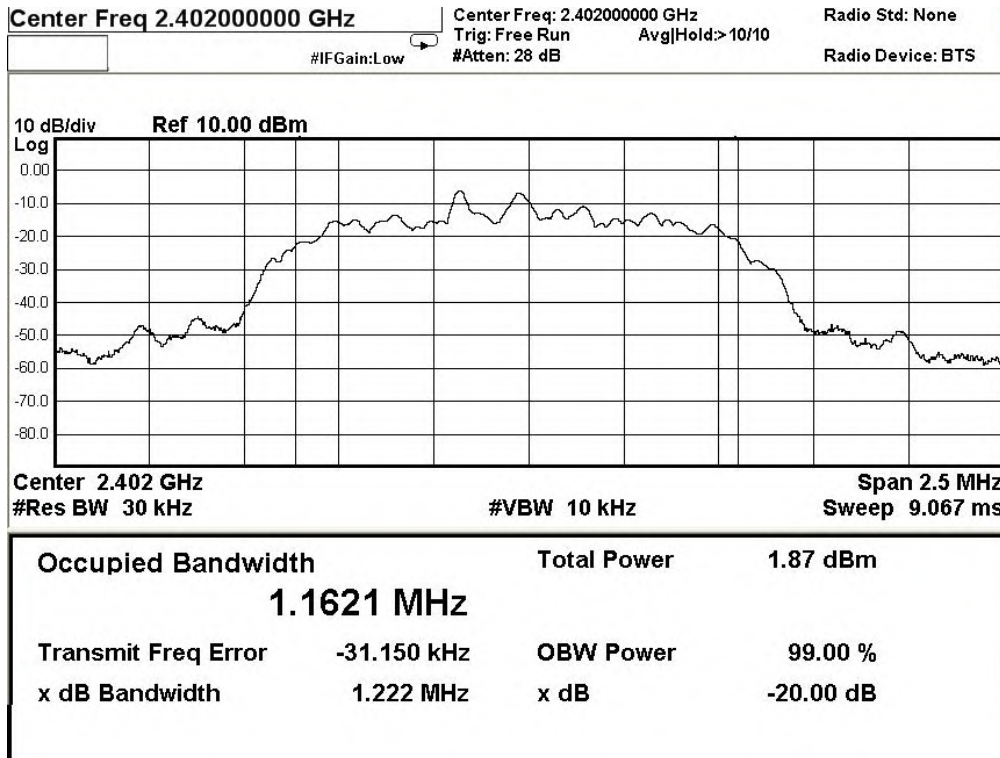

Test Mode: 8DPSK---Low

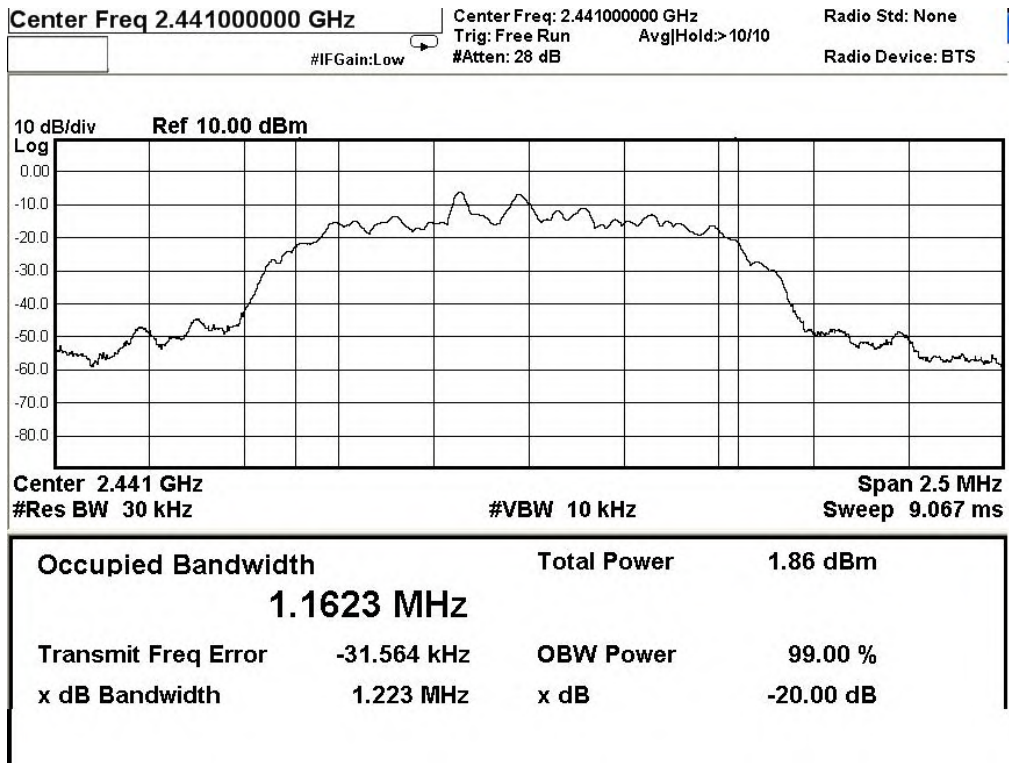

Test Mode: 8DPSK ---Middle

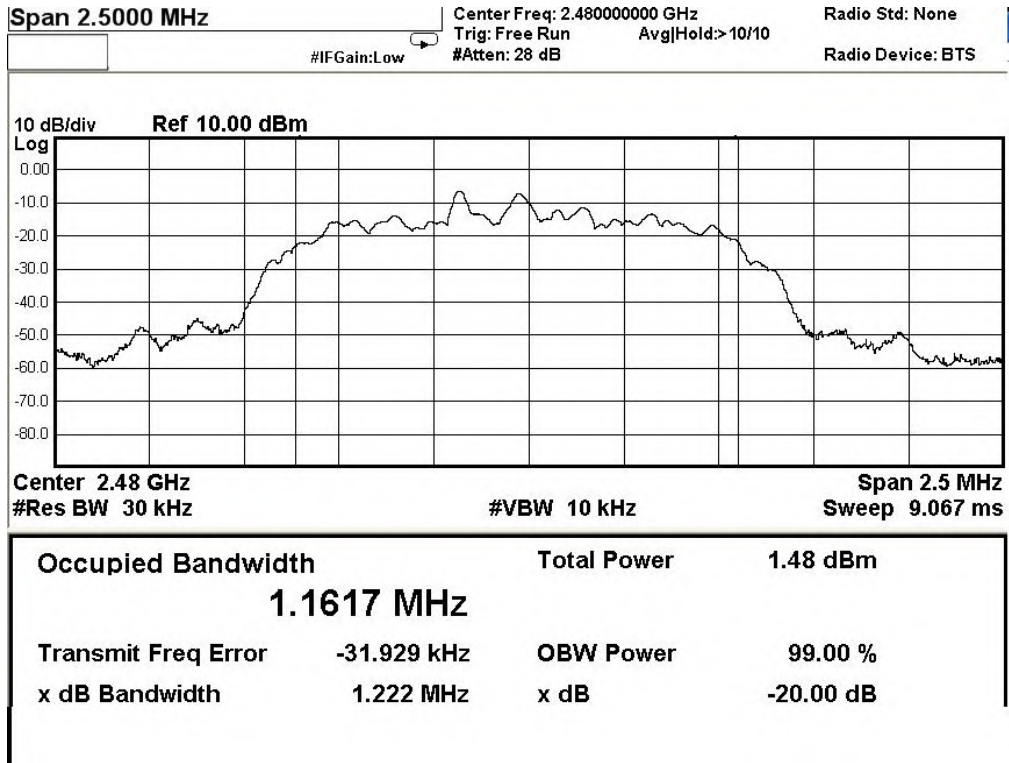

Test Mode: 8DPSK ---High



10 Carrier Frequency Separation Test

10.1 Test Standard and Limit

Test Standard	FCC Part15 C Section 15.247 (a)(1)
Test Limit	>25KHz or >two-thirds of the 20 dB bandwidth

10.2 Test Setup

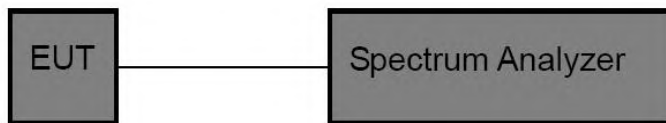

10.3 Test Procedure

The EUT must have its hopping function enabled. Using the following spectrum analyzer settings:

1. Span= Wide enough to capture the peaks of two adjacent channels
2. Set the RBW = 300 kHz.
3. Set the VBW = 300 kHz.
4. Sweep time = auto couple.
5. Detector function = peak.
6. Trace mode = max hold.
7. Allow trace to fully stabilize.

10.4 Test Data

Test Item	: Frequency Separation	Test Mode	: CH Low ~ CH High
Test Voltage	: DC 3.7V Battery inside	Temperature	: 24.5°C
Test Result	: PASS	Humidity	: 55%RH



Channel	Frequency (MHz)	Separation Read Value (kHz)	Limit (kHz)	Modulation Mode
Low	2402	1000	581.13	BDR
Middle	2441	1000	579.87	BDR
High	2480	1000	570.20	BDR
Low	2402	1000	814.67	EDR
Middle	2441	1000	815.33	EDR
High	2480	1000	814.67	EDR

Remark: 1. The EDR was tested on ($\pi/4$ DQPSK, 8DPSK) modes, only the worst data of (8DPSK) is attached in the following pages.

2. The limit of mode (EDR) is 2/3 of 20dB BW.

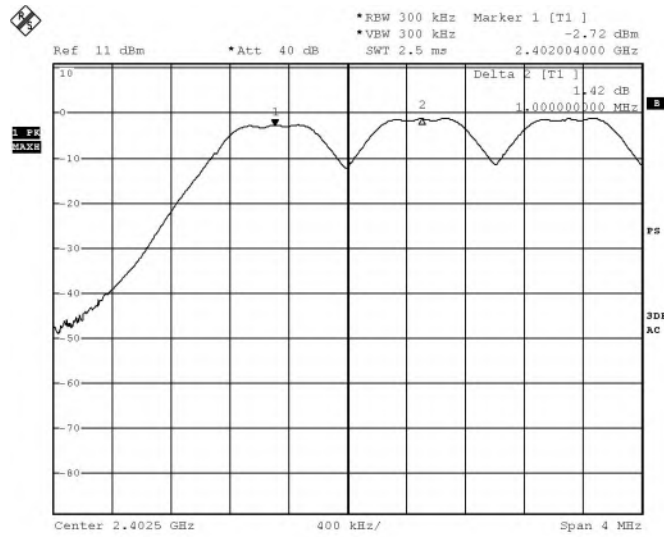

Test Mode: GFSK ---Low

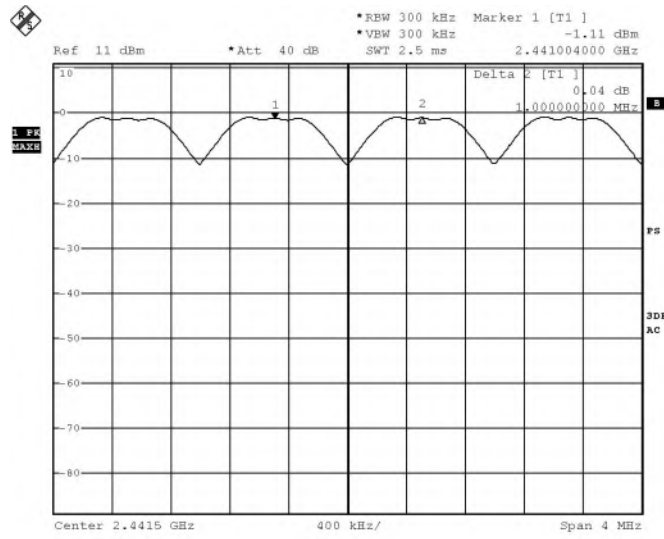

Test Mode: GFSK ---Middle

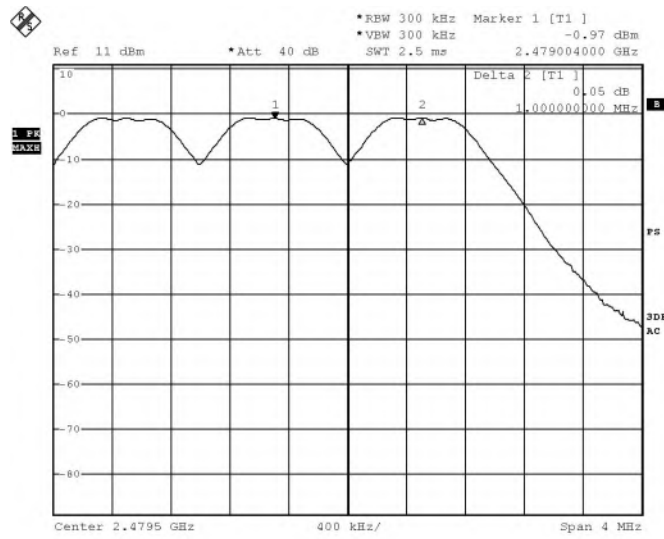

Test Mode: GFSK ---High

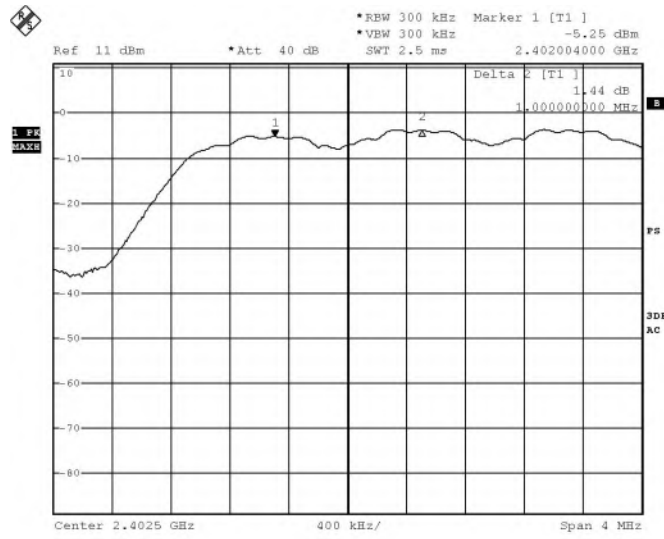

Test Mode: 8DPSK---Low

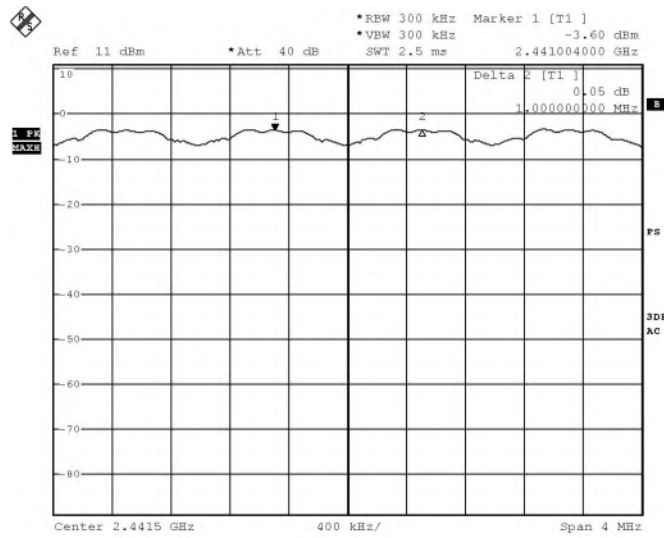

Test Mode: 8DPSK ---Middle

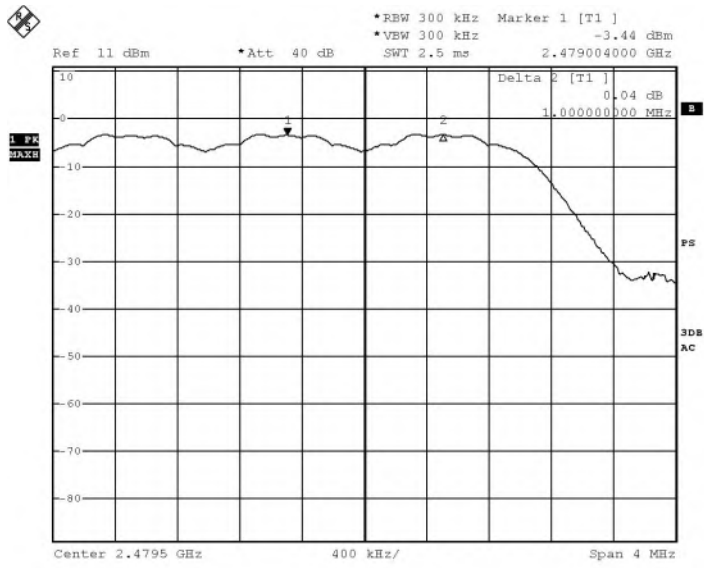

Test Mode: 8DPSK --High



11 Number of Hopping Channel Test

11.1 Test Standard and Limit

Test Standard	FCC Part15 C Section 15.247 (a)(1)
Test Limit	>15 channels

11.2 Test Setup

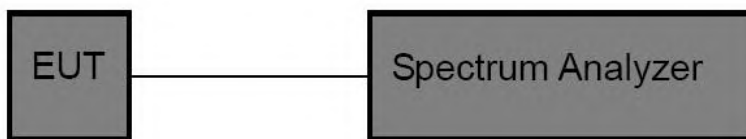

11.3 Test Procedure

The EUT must have its hopping function enabled. Using the following spectrum analyzer setting:

1. Span= the frequency band of operation
2. Set the RBW = 300kHz.
3. Set the VBW = 300kHz.
4. Sweep time = auto couple.
5. Detector function = peak.
6. Trace mode = max hold.
7. Allow trace to fully stabilize.



11.4 Test Data

Test Item	: Number of Hopping Frequency	Test Mode	: CH Low ~ CH High
Test Voltage	: DC 3.7V Battery inside	Temperature	: 24.5°C
Test Result	: PASS	Humidity	: 55%RH

Hopping Channel Frequency Range	Quantity of Hopping Channel	Quantity of Hopping Channel
2402-2480MHz	79	> 15

Remark: The EDR was tested on ($\pi/4$ DQPSK, 8DPSK) modes, only the worst data of (8DPSK) is attached in the following pages.

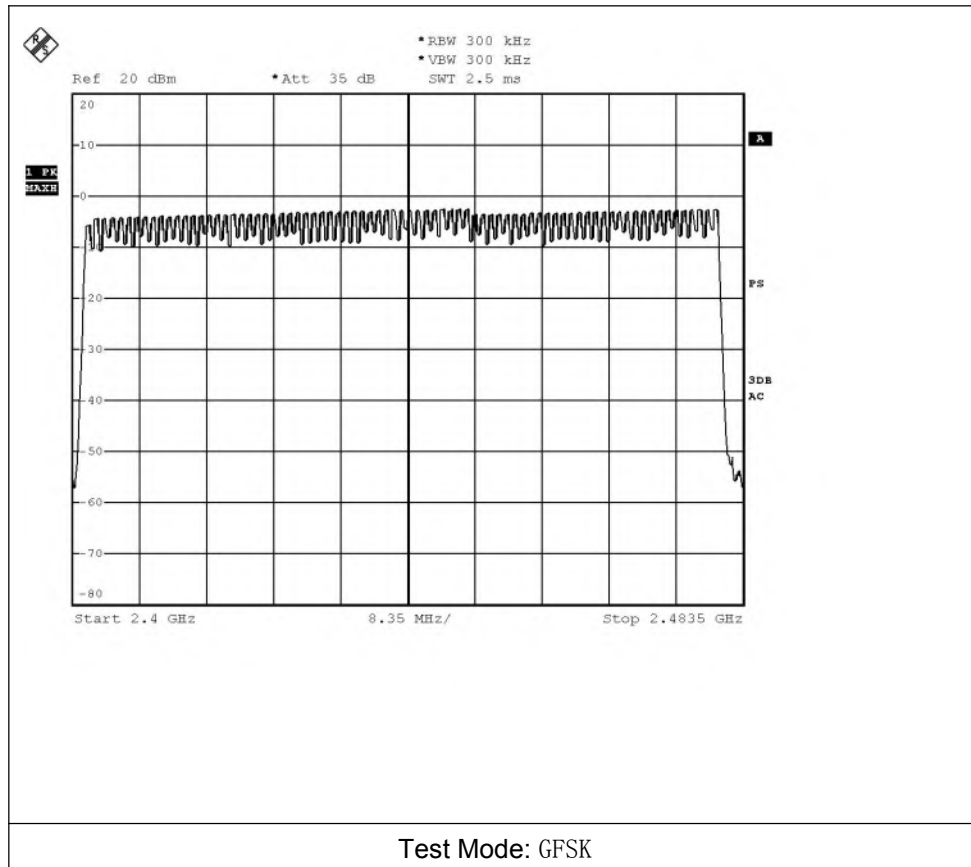

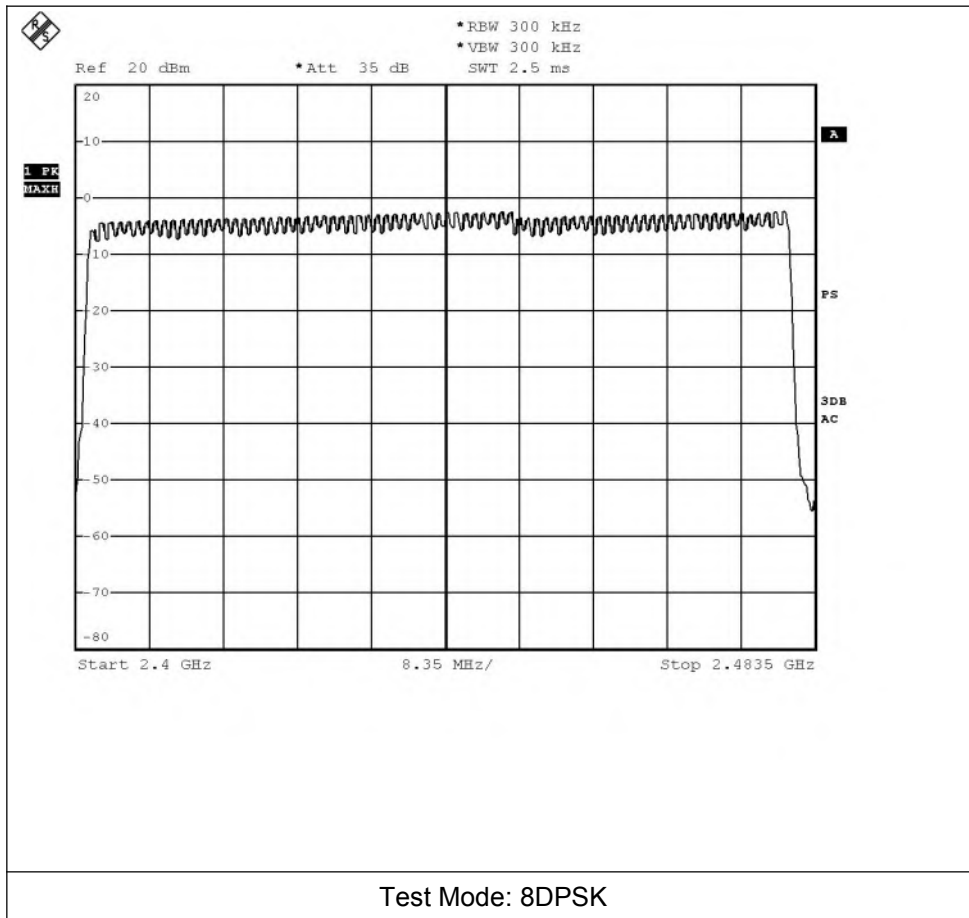



12 Dwell Time Test

12.1 Test Standard and Limit

Test Standard	FCC Part15 C Section 15.247 (a)(1)
Test Limit	0.4 sec

12.2 Test Setup

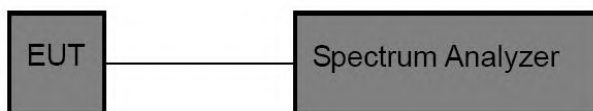

12.3 Test Procedure

The EUT must have its hopping function enabled. Use the following spectrum analyzer settings:

1. Span= zero span, centered on a hopping channel
2. Set the RBW = 1 MHz.
3. Set the VBW = 1 MHz.
4. Sweep time = as necessary to capture the entire dwell time per hopping channel.
5. Detector function = peak.
6. Trace mode = max hold.
7. Allow trace to fully stabilize.



12.4 Test Data

Test Item	: Time of Occupancy	Test Mode	: CH Low ~ CH High
Test Voltage	: DC 3.7V Battery inside	Temperature	: 24.5°C
Test Result	: PASS	Humidity	: 55%RH

Package Type	Pulse width (ms)	Time slot length(ms)	Dwell time (s)	Limit (s)	Modulation
3DH1	0.420	time slot length *1600/2 /79 * 31.6	0.13272	0.4	EDR
3DH3	1.680	time slot length *1600/4 /79 * 31.6	0.26544	0.4	EDR
3DH5	2.930	time slot length *1600/6 /79 * 31.6	0.277764	0.4	EDR

Remark: The EDR was tested on ($\pi/4$ DQPSK, 8DPSK) modes, only the worst data of (8DPSK) is attached in the following pages.

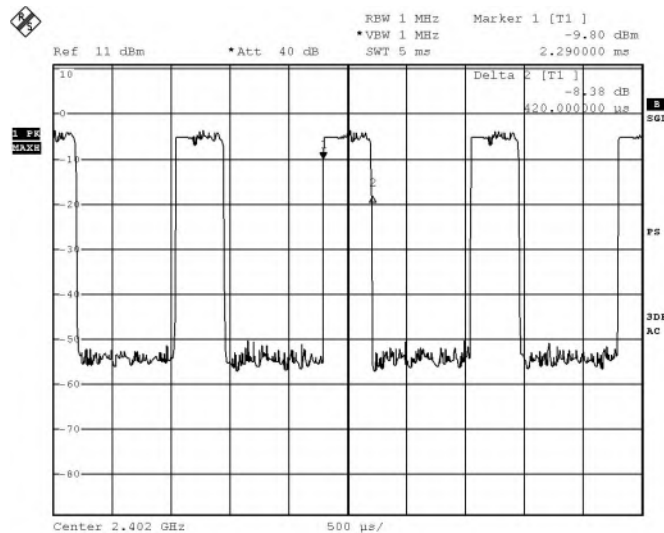

Test Mode: EDR---3DH1

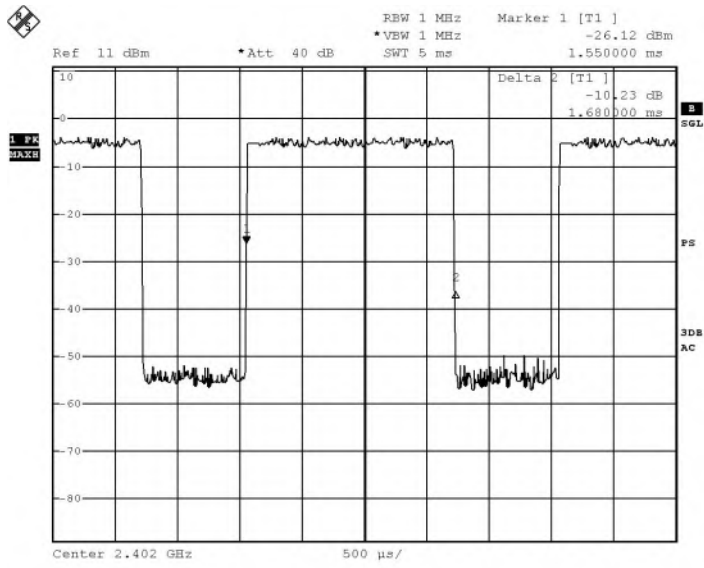

Test Mode: EDR---3DH3

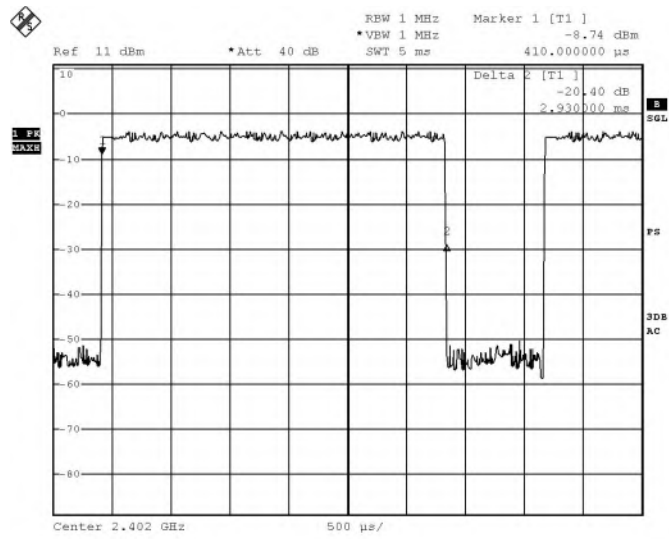

Test Mode: EDR---3DH5

13 100kHz Bandwidth of Frequency Band Edge Requirement

13.1 Test Standard and Limit

Test Standard	FCC Part15 C Section 15.247 (d)
Test Limit	in any 100 kHz bandwidth outside the frequency bands in which the spread spectrum intentional radiator is operating, the radio frequency power that is produced by the intentional radiator shall be at least 20dB below that in the 100kHz bandwidth within the band that contains the highest level of the desired power, In addition, radiated emissions which fall in the restricted bands, as defined in §15.205(a), must also comply with the radiated emission limits specified in 15.209(a).

13.2 Test Setup

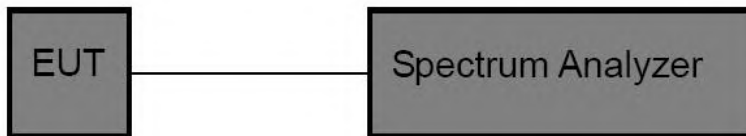

13.3 Test Procedure

The EUT must have its hopping/Non-hopping function enabled. Using the following spectrum analyzer setting:

1. Set the RBW = 100kHz.
2. Set the VBW = 300kHz.
3. Sweep time = auto couple.
4. Detector function = peak.
5. Trace mode = max hold.
6. Allow trace to fully stabilize.



13.4 Test Data

Test Item	: Band edge	Test Mode	: CH Low ~ CH High
Test Voltage	: DC 3.7V Battery inside	Temperature	: 24.5°C
Test Result	: PASS	Humidity	: 55%RH

Remark: The EDR was tested on ($\pi/4$ DQPSK, 8DPSK) modes, only the worst data of ($\pi/4$ DQPSK) is attached in the following pages.

For GFSK Non-Hopping Mode (Low)

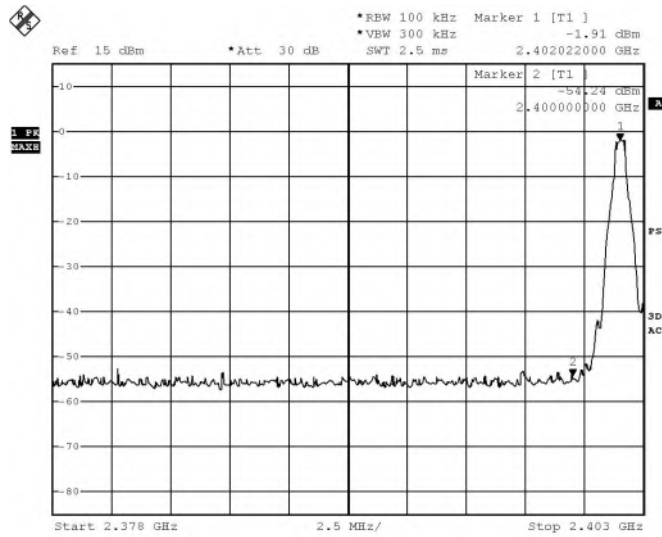



For GFSK Hopping Mode (Low)

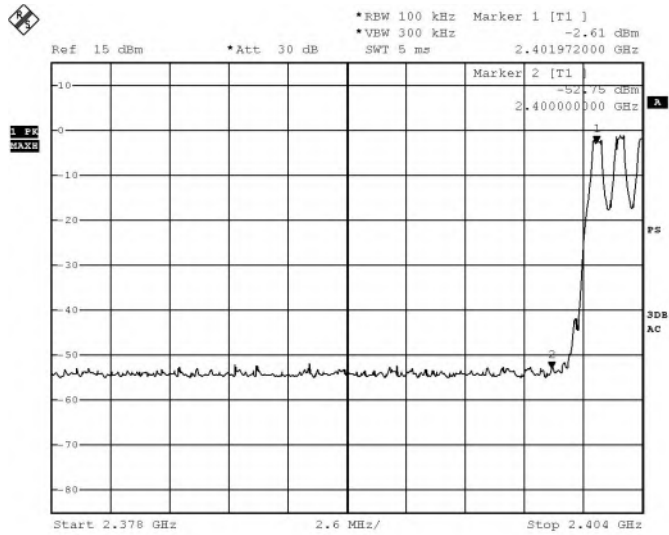

For GFSK Non-Hopping Mode (High)

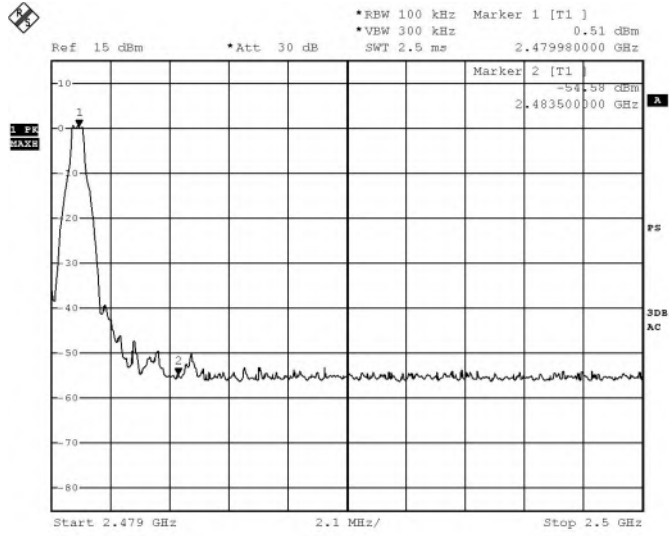

For GFSK Hopping Mode (High)

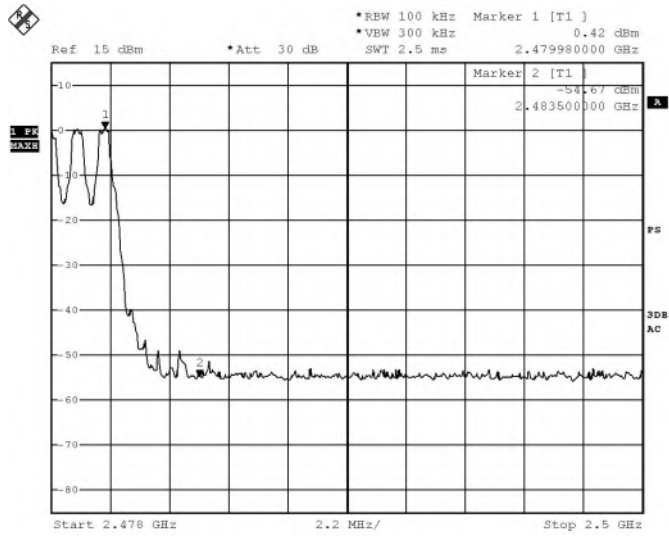

For $\pi/4$ DQPSK Non-Hopping Mode (Low)

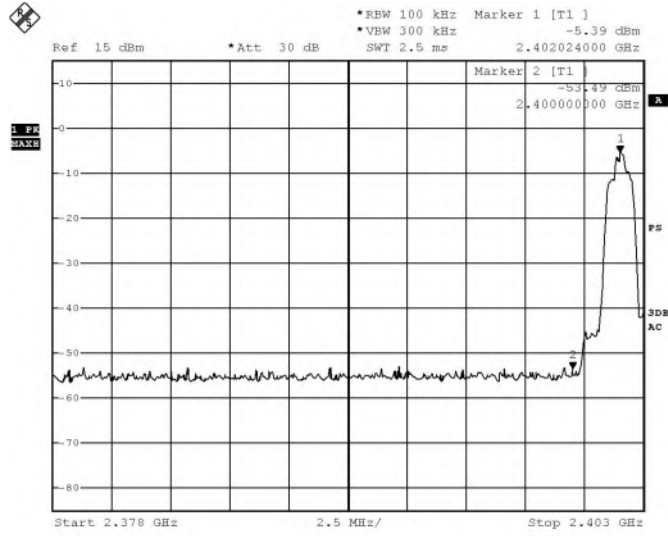

For $\pi/4$ DQPSK Hopping Mode (Low)

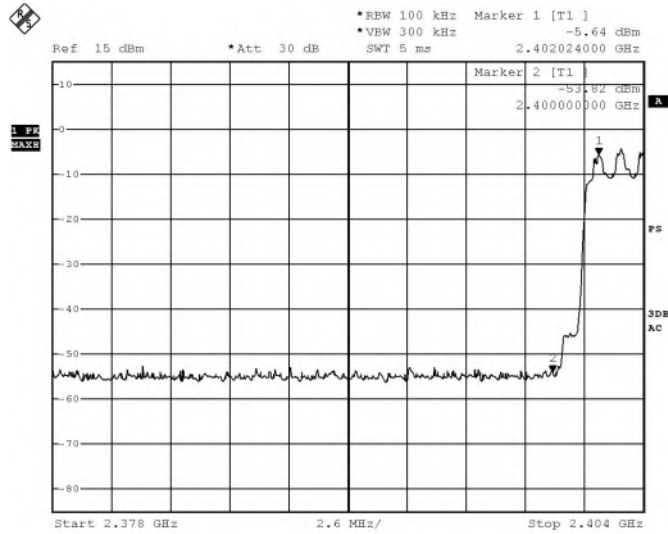

For $\pi/4$ DQPSK Non-Hopping Mode (High)

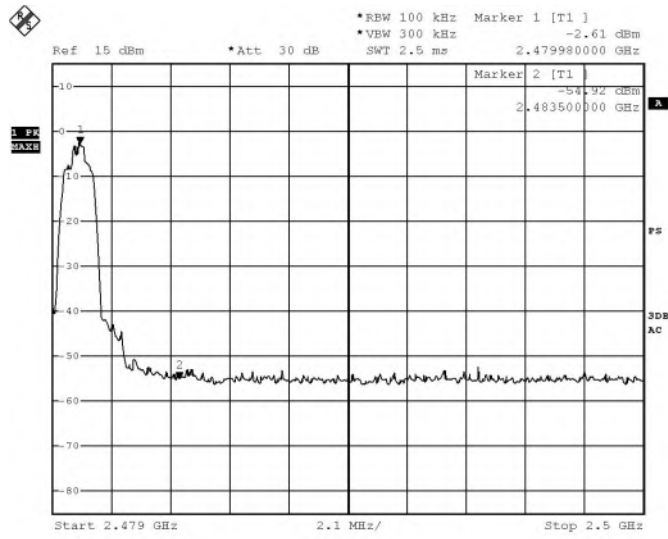

For $\pi/4$ DQPSK Hopping Mode (High)

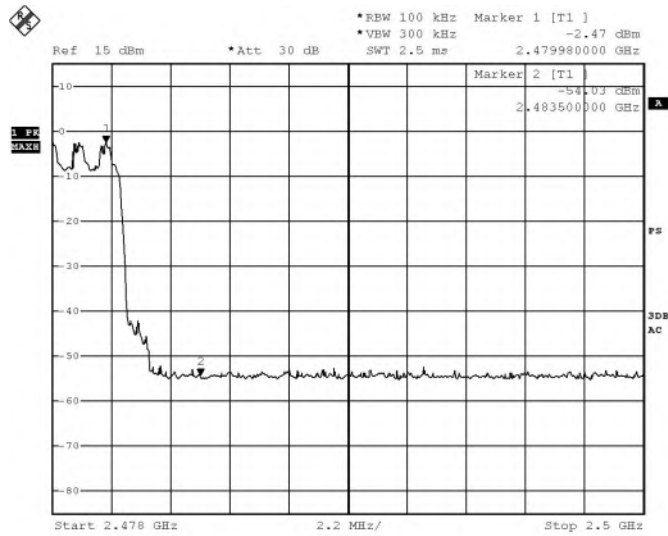

For 8DPSK Non-Hopping Mode (Low)

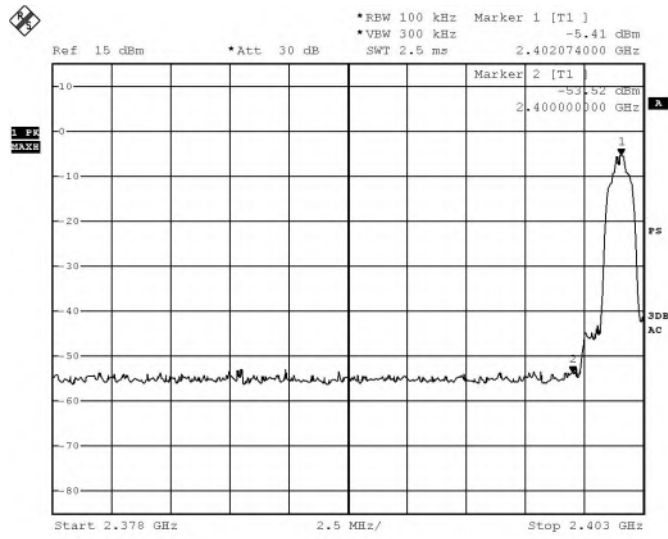

For 8DPSK Hopping Mode (Low)

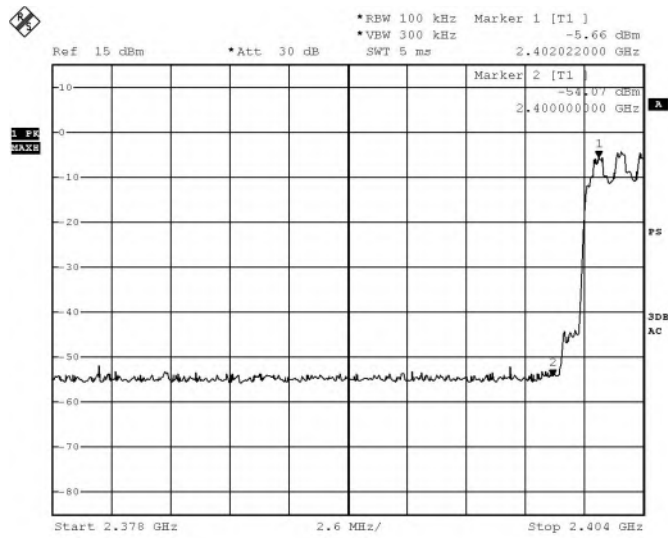

For 8DPSK Non-Hopping Mode (High)

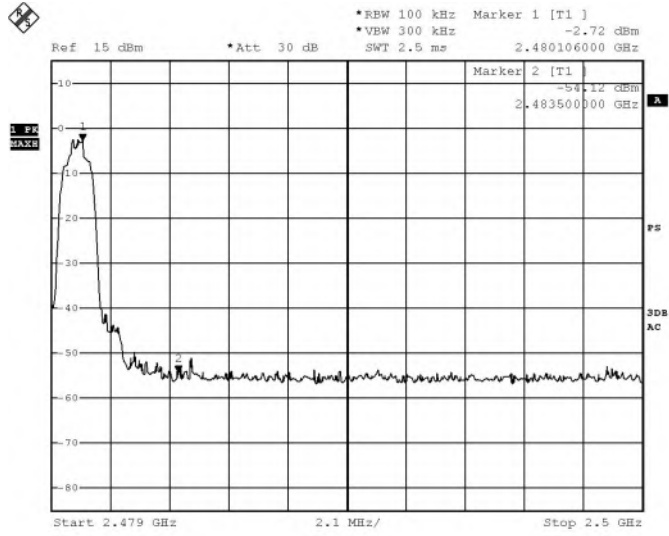

For 8DPSK Hopping Mode (High)

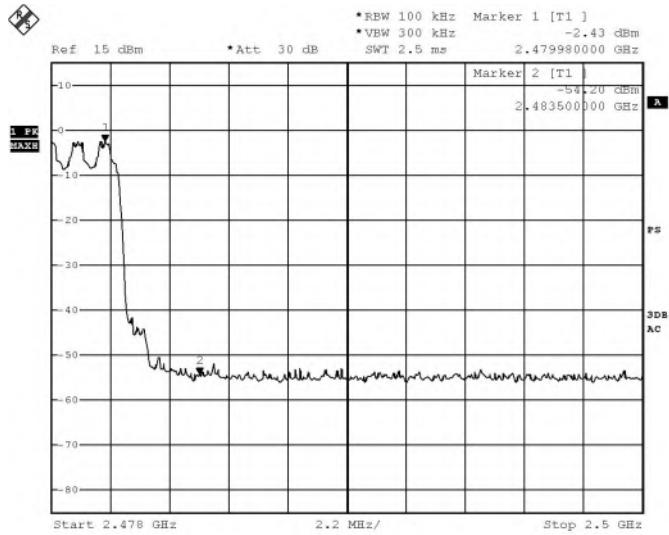



Conducted Emission Method

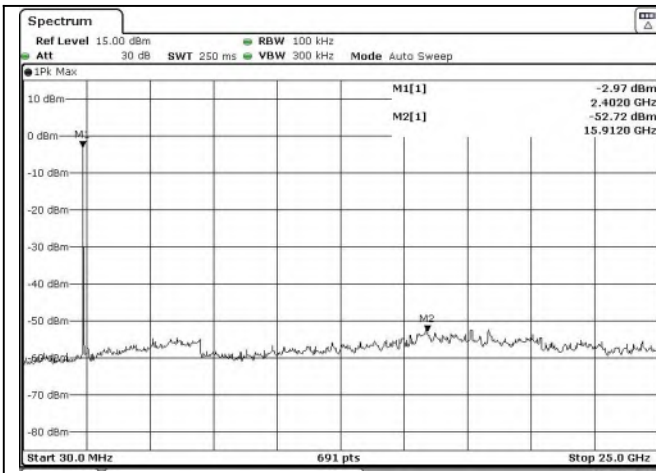

Test Mode: BDR---Low

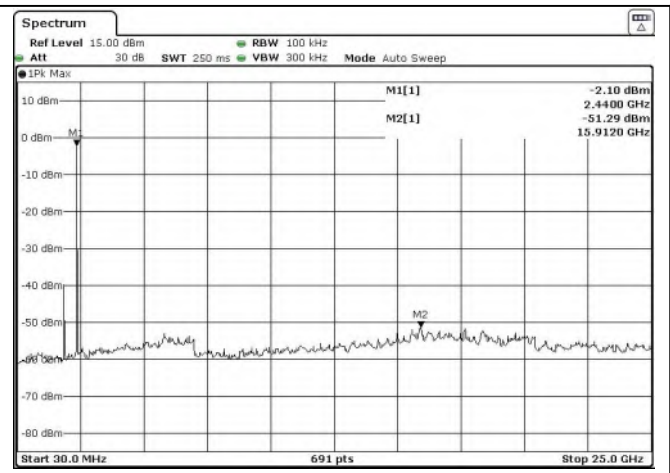

Test Mode: BDR---Mid

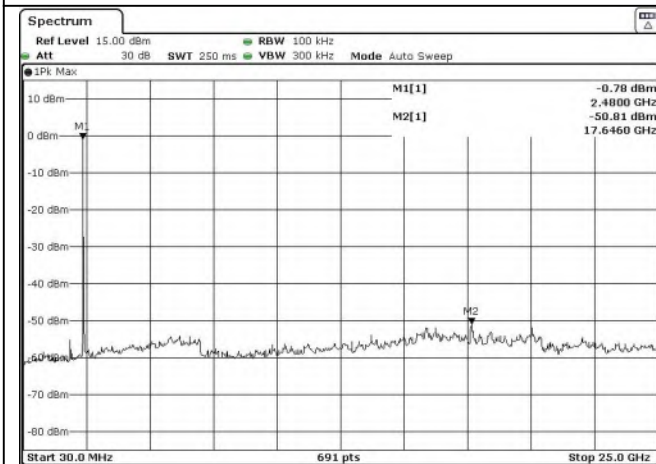

Test Mode: BDR---High

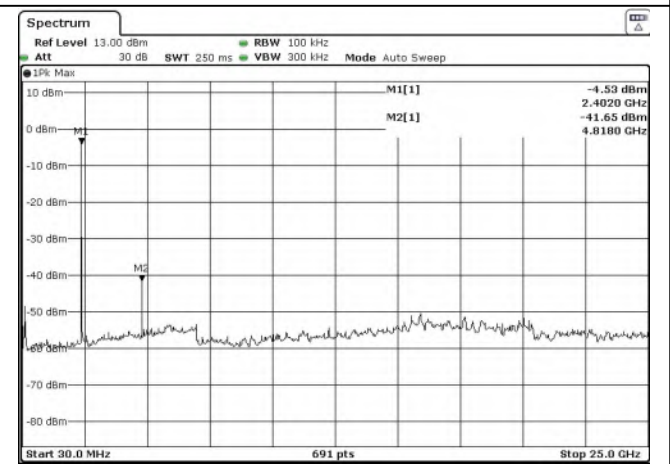

Test Mode: EDR---Low

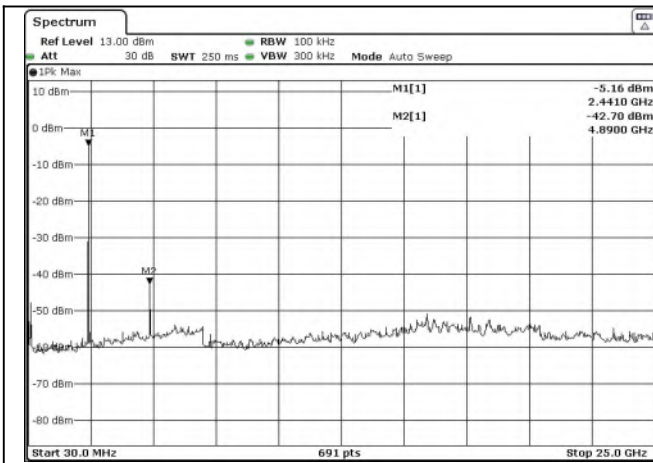

Test Mode: EDR---Mid

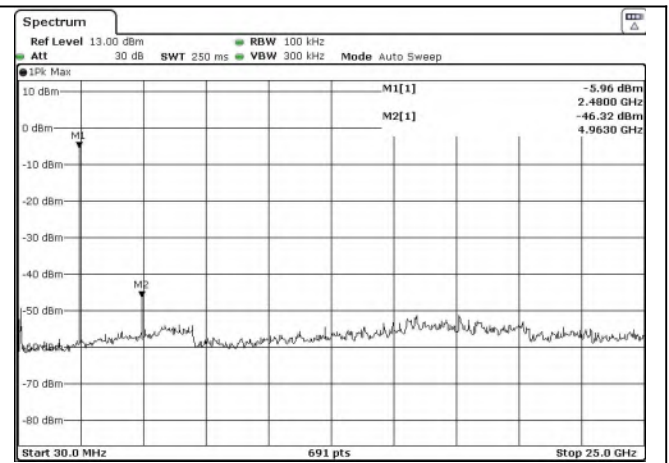

Test Mode: EDR--High

14 Antenna Requirement

14.1 Test Standard and Requirement

Test Standard	FCC Part15 Section 15.203 /247(c)
Requirement	<p>1) 15.203 requirement:</p> <p>An intentional radiator shall be designed to ensure that no antenna other than that furnished by the responsible party shall be used with the device. The use of a permanently attached antenna or of an antenna that uses a unique coupling to the intentional radiator, the manufacturer may design the unit so that a broken antenna can be replaced by the user, but the use of a standard antenna jack or electrical connector is prohibited.</p> <p>2) 15.247(c) (1)(i) requirement:</p> <p>Systems operating in the 2400-2483.5 MHz band that is used exclusively for fixed. Point-to-point operations may employ transmitting antennas with directional gain greater than 6dBi provided the maximum conducted output power of the intentional radiator is reduced by 1 dB for every 3 dB that the directional gain of the antenna exceeds 6 dBi.</p>

14.2 Antenna Connected Construction

The antenna is PCB Antenna which permanently attached, and the best case gain of the antenna is 0 dBi. It complies with the standard requirement.

BT Antenna

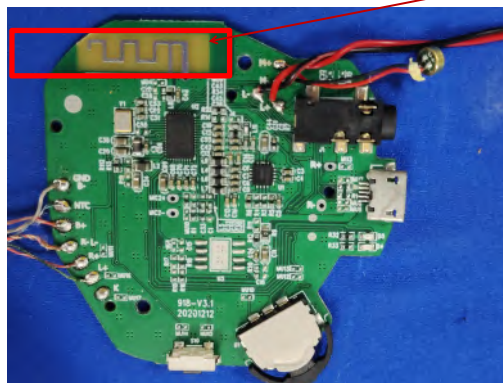

15 APPENDIX I -- TEST SETUP PHOTOGRAPH

Conducted Emissions



Radiated Emissions
From 30M-1GHz

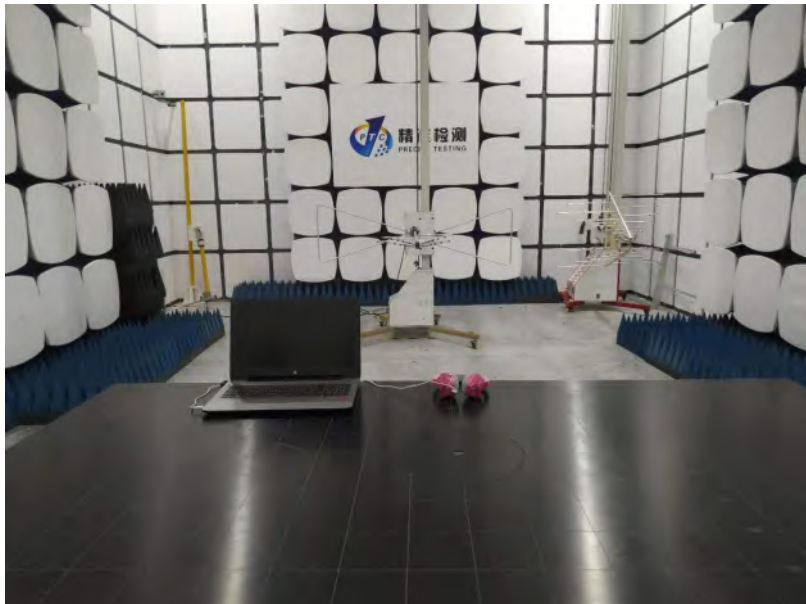

Above 1GHz

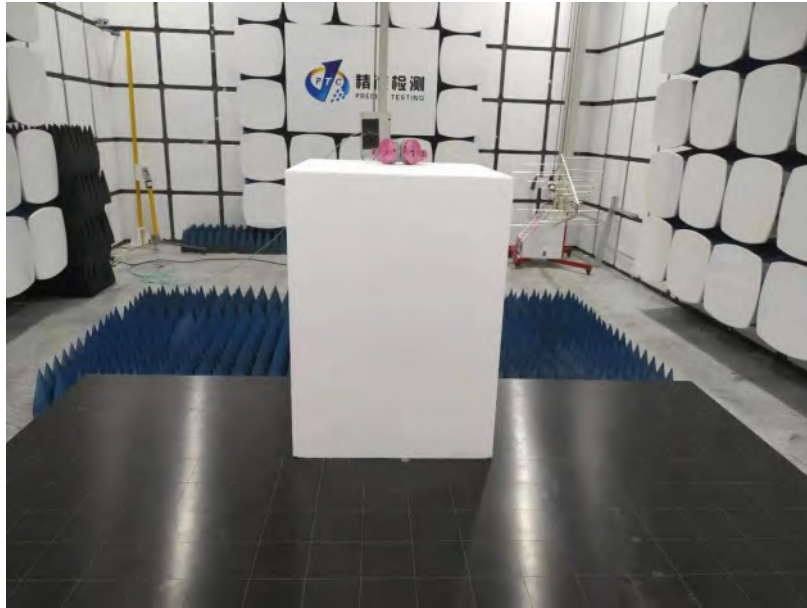

16 APPENDIX II -- EXTERNAL PHOTOGRAPH











17 APPENDIX III -- INTERNAL PHOTOGRAPH



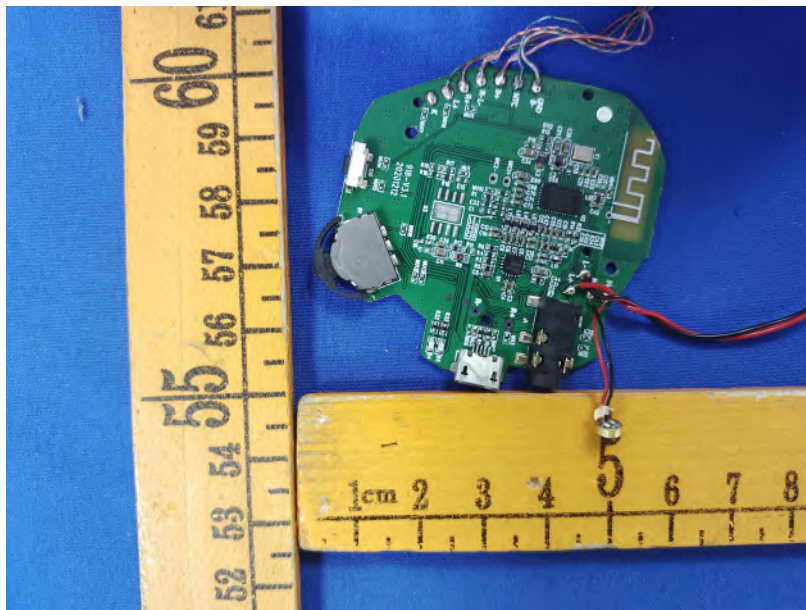

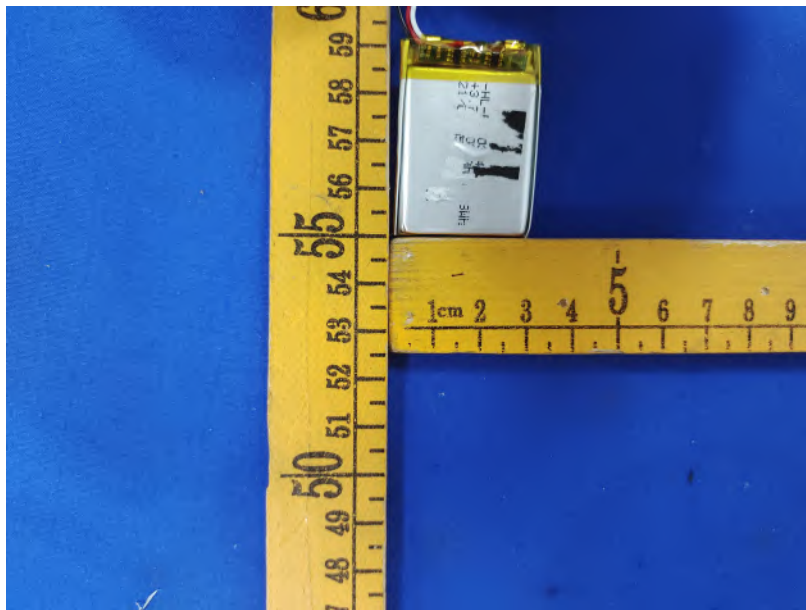
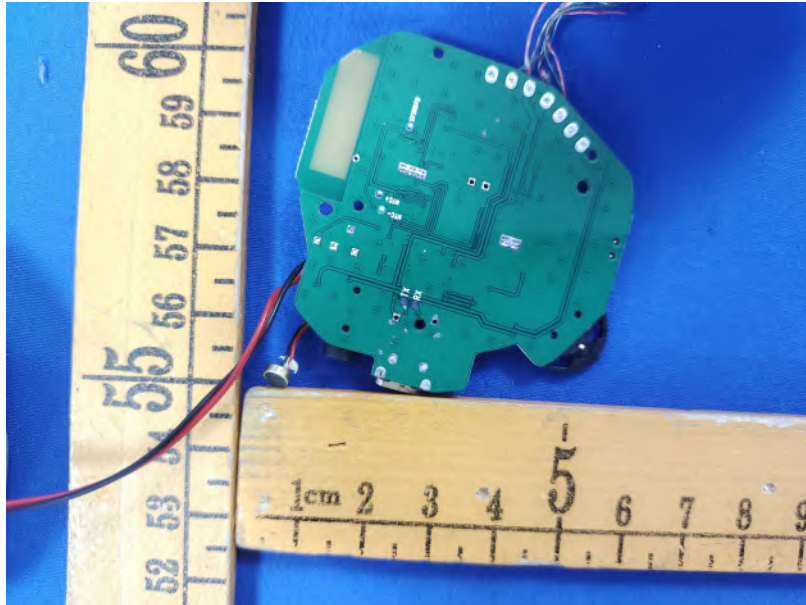

----- End of Report -----