

FCC PART 15 SUBPART C TEST REPORT

FCC PART 15.231

Report Reference No..... : BSL24010131P01-R01

FCC ID..... : 2AG2K13

Compiled by
(position+printed name+signature).. : Engineer/ Cindy Zheng

Supervised by
(position+printed name+signature).. : Manager/Haley Wen

Approved by
(position+printed name+signature).. : RF Manager/ Vivian Jiang

Date of issue..... : February 23, 2024

Testing Laboratory Name : BSL Testing Co., Ltd.

Address..... : 1/F, Building B, Xinshidai GR Park,Shiyan Street, Bao'an District, Shenzhen,Guangdong, 518052, People's Republic of China

Applicant's name..... : A&H Design Group, Ltd.

Address..... : Suite 608, Tower One, Harbour Centre,1 Hok Cheung Street, Hung Hom, Kowloon, Hong Kong

Test specification..... :

Standard..... : FCC CFR Title 47 Part 15 Subpart C section 15.231

BSL Testing Co., Ltd. All rights reserved.

This publication may be reproduced in whole or in part for non-commercial purposes as long as the BSL Testing Co., Ltd. is acknowledged as copyright owner and source of the material. BSL Testing Co., Ltd. takes no responsibility for and will not assume liability for damages resulting from the reader's interpretation of the reproduced material due to its placement and context.

Test item description..... : Rechargeable bullet with AAA remote

Trade Mark..... : N/A

Manufacturer..... : A&H Design Group, Ltd.

Model/Type reference..... : 86461

Listed Models : N/A

Ratings..... : ASK

Modulation : 433.92MHz

Frequency..... : DC 1.5V From Battery

Result..... : PASS

TEST REPORT

Equipment under Test : **Rechargeable bullet with AAA remote**

Model /Type : 86461

Listed Models : N/A

Model Declaration : N/A

Applicant : **A&H Design Group, Ltd.**

Address : Suite 608, Tower One, Harbour Centre, 1 Hok Cheung Street, Hung Hom, Kowloon, Hong Kong

Manufacturer : **A&H Design Group, Ltd.**

Address : Suite 608, Tower One, Harbour Centre, 1 Hok Cheung Street, Hung Hom, Kowloon, Hong Kong

Test Result:	PASS
---------------------	-------------

The test report merely corresponds to the test sample.
It is not permitted to copy extracts of these test result without the written permission of the test laboratory.

Contents

1 TEST STANDARDS	4
2 SUMMARY	5
2.1 General Remarks	5
2.2 Product Description	5
2.3 Equipment Under Test	5
2.4 Short description of the Equipment under Test (EUT)	5
2.5 Block Diagram of Test Setup	5
2.6 Special Accessories	5
2.7 Related Submittal(s) / Grant (s)	6
2.8 Modifications	6
3 TEST ENVIRONMENT	7
3.1 Address of the test laboratory	7
3.2 Test Facility	7
3.3 Environmental conditions	7
3.4 Summary of measurement results	8
3.5 Statement of the measurement uncertainty	8
3.6 Equipments Used during the Test	9
4 TEST CONDITIONS AND RESULTS	11
4.1 AC Power Conducted Emission	11
4.2 Radiated Emission	12
4.3 20dB Bandwidth	19
4.4 Deactivation Time	20
4.5 Antenna Requirement	21
5 TEST SETUP PHOTOS OF THE EUT	22
6 PHOTOS OF THE EUT	23

1 TEST STANDARDS

The tests were performed according to following standards:

[FCC Rules Part 15.231](#): Periodic operation in the band 40.66-40.70 MHz and above 70 MHz.

[ANSI C63.10:2013](#) : American National Standard for Testing Unlicensed Wireless Devices

2 SUMMARY

2.1 General Remarks

Date of receipt of test sample	:	January 24, 2024
Testing commenced on	:	January 24, 2024
Testing concluded on	:	January 30, 2024

2.2 Product Description

Product Name:	Rechargeable bullet with AAA remote
Model/Type reference:	86461
Testing sample ID:	BSL24010131P01-R01-1# (Engineer sample), BSL24010131P01-R01-2#(Normal sample)
Power supply:	DC 1.5V From Battery
Modulation:	ASK
Operation frequency:	433.92MHz
Channel number:	1
Antenna type:	Metal Antenna
Antenna gain:	0 dBi

2.3 Equipment Under Test

Power supply system utilised

Power supply voltage	:	<input type="radio"/> 230V / 50 Hz	<input type="radio"/> 120V / 60Hz
		<input type="radio"/> 12 V DC	<input type="radio"/> 24 V DC
		<input checked="" type="radio"/> Other (specified in blank below) DC 1.5V From Battery	

2.4 Short description of the Equipment under Test (EUT)

This is a Rechargeable bullet with AAA remote .

For more details, refer to the user's manual of the EUT.

2.5 Block Diagram of Test Setup

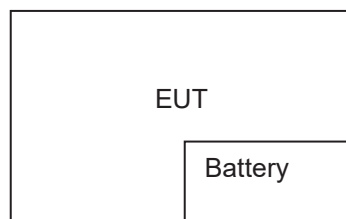

2.6 Special Accessories

Follow auxiliary equipment(s) test with EUT that provided by the manufacturer or laboratory is listed as follow:

Description	Manufacturer	Model	Technical Parameters	Certificate	Provided by
/	/	/	/	/	/



2.7 Related Submittal(s) / Grant (s)

This submittal(s) (test report) is intended for the device filing to comply with Section 15.231 of the FCC Part 15, Subpart C Rules.

2.8 Modifications

No modifications were implemented to meet testing criteria.

3 TEST ENVIRONMENT

3.1 Address of the test laboratory

BSL Testing Co., Ltd.

1/F, Building B, Xinshidai GR Park,Shiyan Street, Bao'an District, Shenzhen,Guangdong, 518052, People's Republic of China

3.2 Test Facility

FCC-Registration No.: 562200 Designation Number: CN1338

BSL Testing Co.,Ltd. has been listed on the US Federal Communications Commission list of test facilities recognized to perform electromagnetic emissions measurements.

Industry Canada Registration Number. Is: 11093A CAB identifier: CN0019

The Laboratory has been registered by Certification and Engineering Bureau of Industry Canada for radio equipment testing.

A2LA-Lab Cert. No.: 4707.01

BSL Testing Co.,Ltd. has been listed by American Association for Laboratory Accreditation to perform electromagnetic emission measurement.

The 3m-Semi anechoic test site fulfils CISPR 16-1-4 according to ANSI C63.10 and CISPR 16-1-4:2010.

3.3 Environmental conditions

During the measurement the environmental conditions were within the listed ranges:

Radiated Emission:

Temperature:	25 ° C
Humidity:	45 %
Atmospheric pressure:	950-1050mbar

Conducted testing:

Temperature:	25 ° C
Humidity:	44 %
Atmospheric pressure:	950-1050mbar

3.4 Summary of measurement results

FCC and IC Requirements		
FCC Part 15.207	Conducted Emission	N/A
FCC Part 15.231(a)(2)	Automatically Deactivate	PASS
FCC Part 15.231(b)	Electric Field Strength of Fundamental Emission	PASS
FCC Part 15.205 & 15.209 & 15.231(b)	Electric Field Strength of Spurious Emission	PASS
FCC Part 15.231(c)	-20dB bandwidth	PASS

Remark: The measurement uncertainty is not included in the test result.

“ N/A” denotes test is not applicable in this test report.

3.5 Statement of the measurement uncertainty

The data and results referenced in this document are true and accurate. The reader is cautioned that there may be errors within the calibration limits of the equipment and facilities. The measurement uncertainty was calculated for all measurements listed in this test report acc. to TR-100028-01 “ Electromagnetic compatibility and Radio spectrum Matters (ERM);Uncertainties in the measurement of mobile radio equipment characteristics; Part 1” and TR-100028-02 “Electromagnetic compatibility and Radio spectrum Matters (ERM);Uncertainties in the measurement of mobile radio equipment characteristics; Part 2 “ and is documented in the BSL Testing Co., Ltd. quality system acc. to DIN EN ISO/IEC 17025. Furthermore, component and process variability of devices similar to that tested may result in additional deviation. The manufacturer has the sole responsibility of continued compliance of the device.

Hereafter the best measurement capability for BSL Testing Co., Ltd. :

Test	Range	Measurement Uncertainty	Notes
Radiated Emission	9KHz~30MHz	3.82 dB	(1)
Radiated Emission	30~1000MHz	4.06 dB	(1)
Radiated Emission	1~18GHz	5.14 dB	(1)
Radiated Emission	18-40GHz	5.38 dB	(1)
Conducted Disturbance	0.15~30MHz	2.14 dB	(1)
Transmitter power conducted	1~40GHz	0.57 dB	(1)
Conducted spurious emission	1~40GHz	1.60 dB	(1)
OBW	1~40GHz	25 Hz	(1)
PSD	1~40GHz	0.01 dBm/3KHz	(1)

- (1) This uncertainty represents an expanded uncertainty expressed at approximately the 95% confidence level using a coverage factor of k=2.

3.6 Equipments Used during the Test

Conducted Emission					
Test Equipment	Manufacturer	Model	Serial No.	Date of Cal.	Due Date
Shielding Room	ZhongYu Electron	7.3(L)x3.1(W)x2.9(H)	BSL252	2023-10-28	2024-10-27
EMI Test Receiver	R&S	ESCI 7	BSL552	2023-10-28	2024-10-27
Coaxial Switch	ANRITSU CORP	MP59B	BSL225	2023-10-28	2024-10-27
ENV216 2-L-V-NETZNACHB.DE	ROHDE&SCHWARZ	ENV216	BSL226	2023-10-28	2024-10-27
Coaxial Cable	BSL	N/A	BSL227	N/A	N/A
EMI Test Software	AUDIX	E3	N/A	N/A	N/A
Thermo meter	KTJ	TA328	BSL233	2023-10-28	2024-10-27
Absorbing clamp	Elektronik-Feinmechanik	MDS21	BSL229	2023-10-28	2024-10-27
LISN	R&S	ENV216	308	2023-10-28	2024-10-27
LISN	R&S	ENV216	314	2023-10-28	2024-10-27
LISN	R&S	ESH3-Z2	0357.8810. 54-101161-S2	2023-10-28	2024-10-27

Radiation Test equipment					
Test Equipment	Manufacturer	Model	Serial No.	Date of Cal.	Due Date
3m Semi- Anechoic Chamber	ZhongYu Electron	9.2(L)*6.2(W)* 6.4(H)	BSL250	2023-10-28	2024-10-27
Control Room	ZhongYu Electron	6.2(L)*2.5(W)* 2.4(H)	BSL251	N/A	N/A
EMI Test Receiver	Rohde & Schwarz	ESU26	BSL203	2023-10-28	2024-10-27
BiConiLog Antenna	SCHWARZBECK MESS-ELEKTRONIK	VULB9163	BSL214	2023-10-28	2024-10-27
Double -ridged waveguide horn	SCHWARZBECK MESS-ELEKTRONIK	BBHA 9120 D	BSL208	2023-10-28	2024-10-27
Horn Antenna	ETS-LINDGREN	3160	BSL217	2023-10-28	2024-10-27
EMI Test Software	AUDIX	E3	N/A	N/A	N/A
Coaxial Cable	BSL	N/A	BSL213	2023-10-28	2024-10-27
Coaxial Cable	BSL	N/A	BSL211	2023-10-28	2024-10-27
Coaxial cable	BSL	N/A	BSL210	2023-10-28	2024-10-27
Coaxial Cable	BSL	N/A	BSL212	2023-10-28	2024-10-27
Amplifier(100kHz-3GHz)	HP	8347A	BSL204	2023-10-28	2024-10-27
Amplifier(2GHz-20GHz)	HP	84722A	BSL206	2023-10-28	2024-10-27
Amplifier (18-26GHz)	Rohde & Schwarz	AFS33-18002 650-30-8P-44	BSL218	2023-10-28	2024-10-27
Band filter	Amindeon	82346	BSL219	2023-10-28	2024-10-27
Power Meter	Anritsu	ML2495A	BSL540	2023-10-28	2024-10-27
Power Sensor	Anritsu	MA2411B	BSL541	2023-10-28	2024-10-27

Wideband Radio Communication Tester	Rohde & Schwarz	CMW500	BSL575	2023-10-28	2024-10-27
Splitter	Agilent	11636B	BSL237	2023-10-28	2024-10-27
Loop Antenna	ZHINAN	ZN30900A	BSL534	2023-10-28	2024-10-27
Breitband hornantenne	SCHWARZBECK	BBHA 9170	BSL579	2023-10-28	2024-10-27
Amplifier	TDK	PA-02-02	BSL574	2023-10-28	2024-10-27
Amplifier	TDK	PA-02-03	BSL576	2023-10-28	2024-10-27
PSA Series Spectrum Analyzer	Rohde & Schwarz	FSP	BSL578	2023-10-28	2024-10-27

RF Conducted Test:					
Test Equipment	Manufacturer	Model	Serial No.	Date of Cal.	Due Date
MXA Signal Analyzer	Agilent	N9020A	BSL566	2023-10-28	2024-10-27
EMI Test Receiver	R&S	ESCI 7	BSL552	2023-10-28	2024-10-27
Spectrum Analyzer	Agilent	E4440A	BSL533	2023-10-28	2024-10-27
MXG vector Signal Generator	Agilent	N5182A	BSL567	2023-10-28	2024-10-27
ESG Analog Signal Generator	Agilent	E4428C	BSL568	2023-10-28	2024-10-27
USB RF Power Sensor	DARE	RPR3006W	BSL569	2023-10-28	2024-10-27
RF Switch Box	Shongyi	RFSW3003328	BSL571	2023-10-28	2024-10-27
Programmable Constant Temp & Humi Test Chamber	WEWON	WHTH-150L-40-880	BSL572	2023-10-28	2024-10-27

Note: The Cal.Interval was one year.

4 TEST CONDITIONS AND RESULTS

4.1 AC Power Conducted Emission

TEST CONFIGURATION

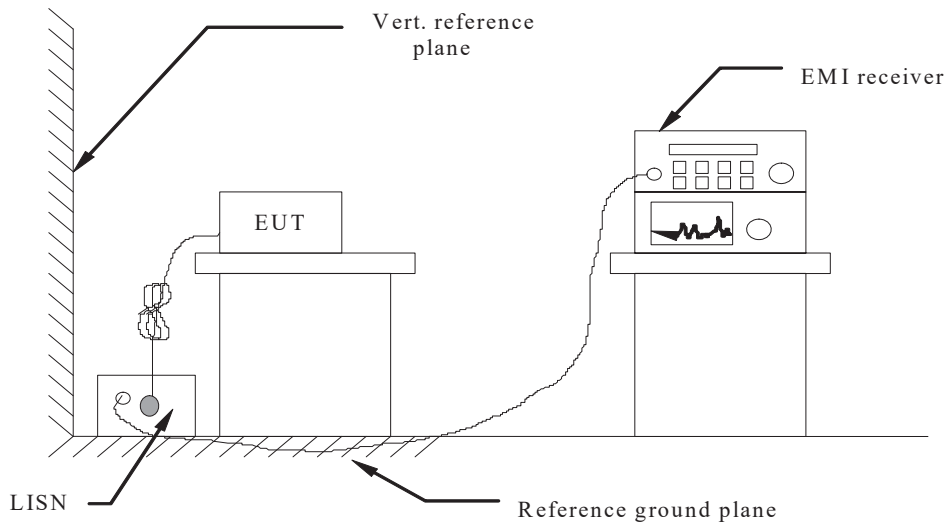

TEST PROCEDURE

- 1 The equipment was set up as per the test configuration to simulate typical actual usage per the user's manual. The EUT is a tabletop system, a wooden table with a height of 0.8 meters is used and is placed on the ground plane as per ANSI C63.10-2013.
- 2 Support equipment, if needed, was placed as per ANSI C63.10-2013
- 3 All I/O cables were positioned to simulate typical actual usage as per ANSI C63.10-2013
- 4 The EUT received DC 12V power from adapter, the adapter received AC120V/60Hz and AC 240V/60Hz power through a Line Impedance Stabilization Network (LISN) which supplied power source and was grounded to the ground plane.
- 5 All support equipments received AC power from a second LISN, if any.
- 6 The EUT test program was started. Emissions were measured on each current carrying line of the EUT using a spectrum Analyzer / Receiver connected to the LISN powering the EUT. The LISN has two monitoring points: Line 1 (Hot Side) and Line 2 (Neutral Side). Two scans were taken: one with Line 1 connected to Analyzer / Receiver and Line 2 connected to a 50 ohm load; the second scan had Line 1 connected to a 50 ohm load and Line 2 connected to the Analyzer / Receiver.
- 7 Analyzer / Receiver scanned from 150 KHz to 30MHz for emissions in each of the test modes.
- 8 During the above scans, the emissions were maximized by cable manipulation.

AC Power Conducted Emission Limit

For intentional device, according to § 15.207(a) AC Power Conducted Emission Limits is as following:

Frequency range (MHz)	Limit (dBuV)	
	Quasi-peak	Average
0.15-0.5	66 to 56*	56 to 46*
0.5-5	56	46
5-30	60	50

* Decreases with the logarithm of the frequency.

TEST RESULTS

The EUT is powered by the Battery, So this test item is not applicable for the EUT.

4.2 Radiated Emission

Limit

For intentional device, according to 15.209(a) the general requirement of field strength of radiated emission from intentional radiators at a distance of 3 meters shall not exceed the following table.

Frequency (MHz)	Distance (Meters)	Radiated (dB μ V/m)	Radiated (μ V/m)
0.009-0.49	3	$20\log(2400/F(\text{KHz}))+40\log(300/3)$	$2400/F(\text{KHz})$
0.49-1.705	3	$20\log(24000/F(\text{KHz}))+40\log(30/3)$	$24000/F(\text{KHz})$
1.705-30	3	$20\log(30)+40\log(30/3)$	30
30-88	3	40.0	100
88-216	3	43.5	150
216-960	3	46.0	200
Above 960	3	54.0	500

In addition to the provisions of 15.231(b), the field strength of emissions from intentional radiators operated under this section shall not exceed the following:

Funda- mental fre- quency (MHz)	Field strength of funda- mental (microvolts/ meter)	Field strength of spurious emissions (microvolts/meter)
40.66– 40.70.	2,250	225
70–130	1,250	125
130–174	¹ 1,250 to 3,750	¹ 125 to 375
174–260	3,750	375
260–470	¹ 3,750 to 12,500	¹ 375 to 1,250
Above 470	12,500	1,250

¹ Linear interpolations.

[Where F is the frequency in MHz, the formulas for calculating the maximum permitted fundamental field strengths are as follows: for the band 260-470 MHz, $20*\log(41.6667*433.890-7083.3333)=80.82\text{dB}\mu\text{V}/\text{m}$ The maximum permitted unwanted emission level is 20 dB below the maximum permitted fundamental level.]

TEST CONFIGURATION

(A) Radiated Emission Test Set-Up, Frequency Below 30MHz

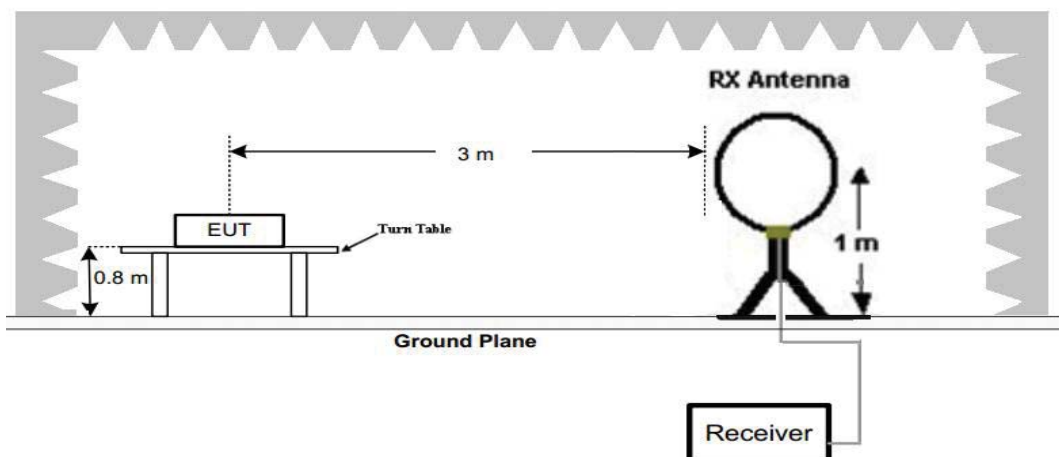

(B) Radiated Emission Test Set-Up, Frequency below 1000MHz

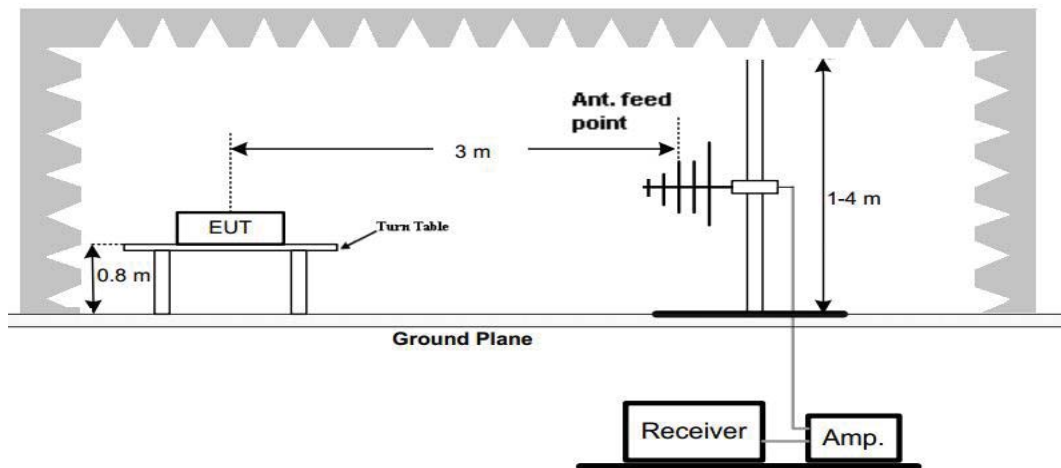

(C) Radiated Emission Test Set-Up, Frequency above 1000MHz

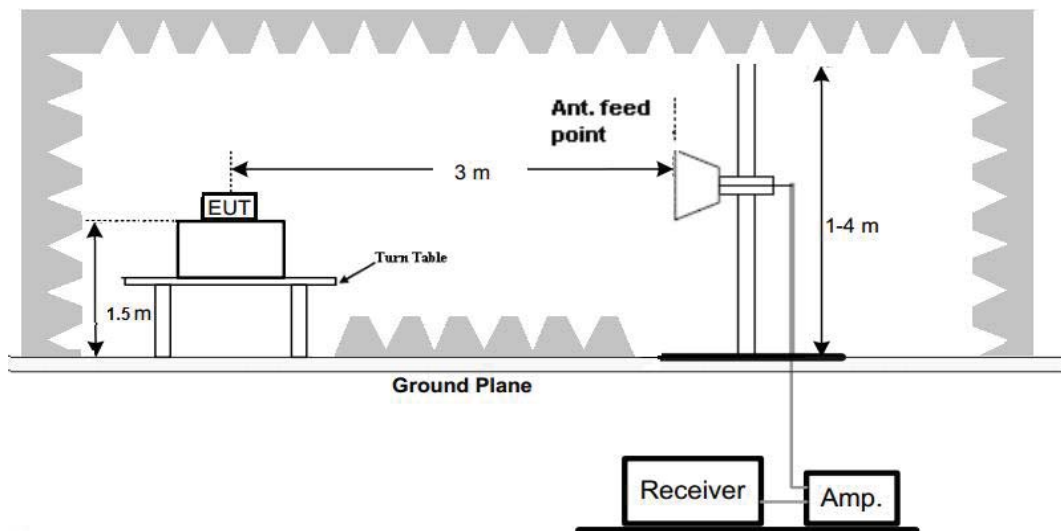

Test Procedure

1. Below 1GHz measurement the EUT is placed on a turntable which is 0.8m above ground plane, and above 1GHz measurement EUT was placed on a low permittivity and low loss tangent turn table which is 1.5m above ground plane.
2. Maximum procedure was performed by raising the receiving antenna from 1m to 4m and rotating the turn table from 0°C to 360°C to acquire the highest emissions from EUT
3. And also, each emission was to be maximized by changing the polarization of receiving antenna both horizontal and vertical.
4. Repeat above procedures until all frequency measurements have been completed.

TEST RESULTS

The emissions from 30MHz to 5GHz are measured peak and average level, below 1 GHz measured QP level, detailed test data please see below. Besides, we tested 3 directions and recorded the worst data.

Radiated emission test from 9 KHz to 10th harmonic of fundamental was verified, and no emission found except system noise floor in 9 KHz to 30MHz and not recorded in this report.

Radiated Spurious Emission (Between 30MHz – 1GHz)

Horizontal

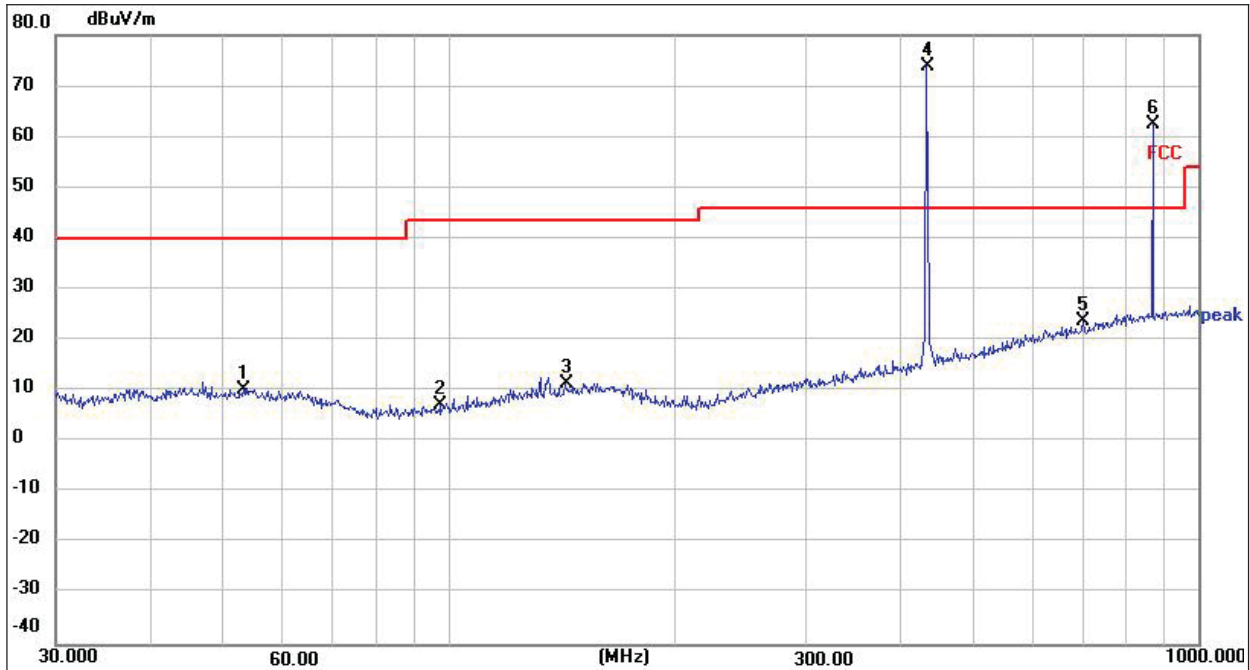

No.	Frequency (MHz)	Reading (dBuV)	Factor (dB/m)	Level (dBuV/m)	Limit (dBuV/m)	Margin (dB)	Detector	Height (cm)	Azimuth (deg.)	P/F
1	53.3179	26.94	-16.69	10.25	40.00	-29.75	peak	100	0	P
2	97.7983	27.32	-20.06	7.26	43.50	-36.24	peak	100	0	P
3	143.3261	27.97	-16.49	11.48	43.50	-32.02	peak	100	0	P
4	433.9201	85.82	-12.11	73.71	46.00	27.71	peak	100	0	P
5	701.7610	30.23	-6.46	23.77	46.00	-22.23	peak	100	0	P
6	867.8402	66.38	-4.03	62.35	46.00	16.35	peak	100	0	P

Fundamental and Harmonics Result									
Frequency MHz	Peak Level (dBuV/m)	AV Factor (dBuV/m)	Average Level (dBuV/m)	Limitd PK (dBuV/m)	Limitd AV (dBuV/m)	Margin PK(dB)	Margin AV(dB)	Conclusion	
433.92	73.71	-6.994	66.72	100.8	80.8	-27.09	-14.08	PASS	
867.84	62.35	-6.994	55.36	80.8	60.8	-18.45	-5.44	PASS	

Remarks:

- 1.Final Level =Receiver Read level + Antenna Factor + Cable Loss – Preamplifier Factor
- 2.The emission levels of other frequencies are very lower than the limit and not show in test report.
- 3.AV Level (dBuV/m)= PK Level (dBuV/m)+ AV Factor(dBuV/m)
- 4.Margin(dB) = Limit (dBμV) - Level (dBμV)

Vertical

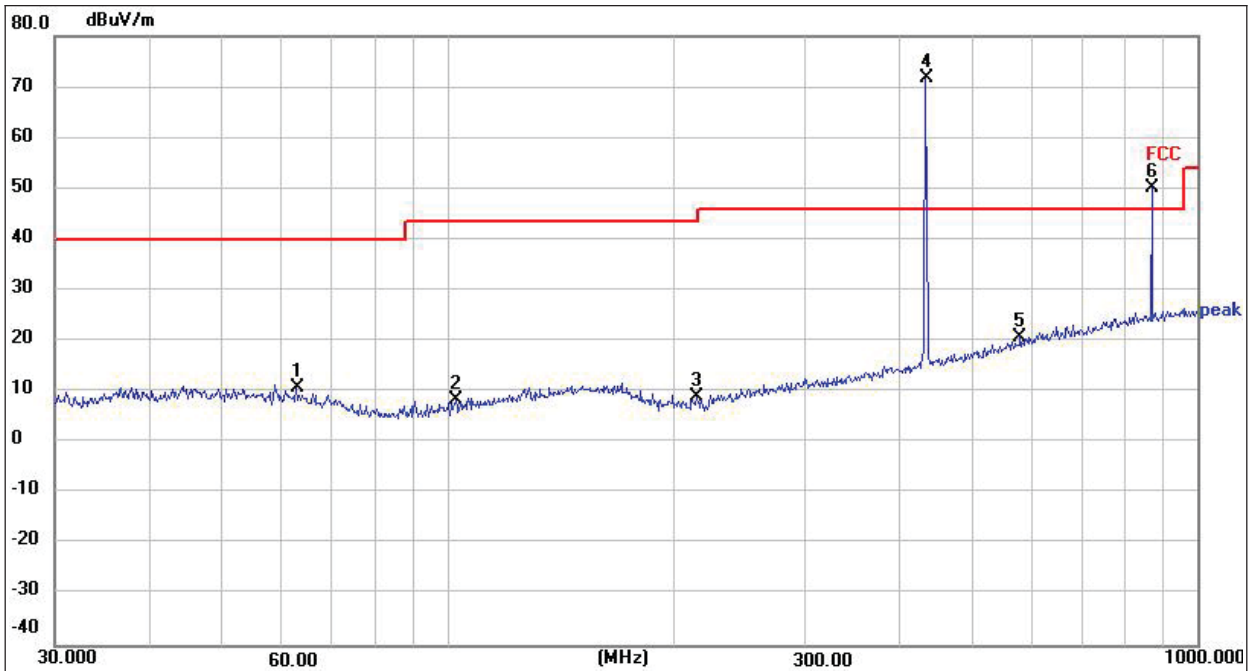

No.	Frequency (MHz)	Reading (dBuV)	Factor (dB/m)	Level (dBuV/m)	Limit (dBuV/m)	Margin (dB)	Detector	Height (cm)	Azimuth (deg.)	P/F
1	62.8708	28.26	-17.50	10.76	40.00	-29.24	peak	100	360	P
2	102.7192	28.21	-19.63	8.58	43.50	-34.92	peak	100	360	P
3	215.2678	28.24	-19.33	8.91	43.50	-34.59	peak	100	360	P
4	434.0651	83.89	-12.11	71.78	46.00	25.78	peak	100	360	P
5	580.7026	29.30	-8.40	20.90	46.00	-25.10	peak	100	360	P
6	869.1302	54.23	-4.03	50.20	46.00	4.20	peak	100	360	P

Fundamental and Harmonics Result									
Frequency MHz	Peak Level (dBuV/m)	AV Factor (dBuV/m)	Average Level (dBuV/m)	Limitd PK (dBuV/m)	Limitd AV (dBuV/m)	Margin PK(dB)	Margin AV(dB)	Conclusion	
433.92	71.78	-6.994	64.79	100.8	80.8	-29.02	-16.01	PASS	
867.84	50.20	-6.994	43.21	80.8	60.8	-30.60	-17.59	PASS	

Remarks:

1. Final Level = Receiver Read level + Antenna Factor + Cable Loss – Preamplifier Factor
2. The emission levels of other frequencies are very lower than the limit and not show in test report.
3. AV Level (dBuV/m) = PK Level (dBuV/m) + AV Factor (dBuV/m)
4. Margin (dB) = Limit (dBμV) - Level (dBμV)

Radiated Spurious Emission (1GHz to 10th harmonics)

Frequency MHz	Peak Level dBuV/m	Duty cycle factor	Average Level dBuV/m	Limit		Margin dB		Polarization
				PK	AV	PK	AV	
1301.72	45.65	-6.994	38.66	74.0	54.0	-28.35	-15.34	Vertical
1735.25	43.16	-6.994	36.17	74.0	54.0	-30.84	-17.83	Vertical
2603.55	40.62	-6.994	33.63	74.0	54.0	-33.38	-20.37	Vertical
3037.46	37.66	-6.994	30.67	74.0	54.0	-36.34	-23.33	Vertical
3471.35	35.45	-6.994	28.46	74.0	54.0	-38.55	-25.54	Vertical
3905.28	32.66	-6.994	25.67	74.0	54.0	-41.34	-28.33	Vertical
1301.72	45.38	-6.994	38.39	74.0	54.0	-28.62	-15.61	Horizontal
1735.25	42.19	-6.994	35.20	74.0	54.0	-31.81	-18.80	Horizontal
2603.55	39.42	-6.994	32.43	74.0	54.0	-34.58	-21.57	Horizontal
3037.46	37.45	-6.994	30.46	74.0	54.0	-36.55	-23.54	Horizontal
3471.35	35.69	-6.994	28.70	74.0	54.0	-38.31	-25.30	Horizontal
3905.28	31.97	-6.994	24.98	74.0	54.0	-42.03	-29.02	Horizontal

Notes:

1. Average emission Level = Peak Level + Duty cycle factor
2. In a transmit cycle 100ms period found burst 46pcs, the Duty Cycle can calculate as below:

$$\text{Duty Cycle} = (22.2 + 9.1) / 70.1 = 0.447$$

$$\text{AV Factor} = 20 * \log(\text{Duty Cycle}) = 20 * \log(0.447) = -6.994$$

(The plot of Duty Cycle See the follow page)

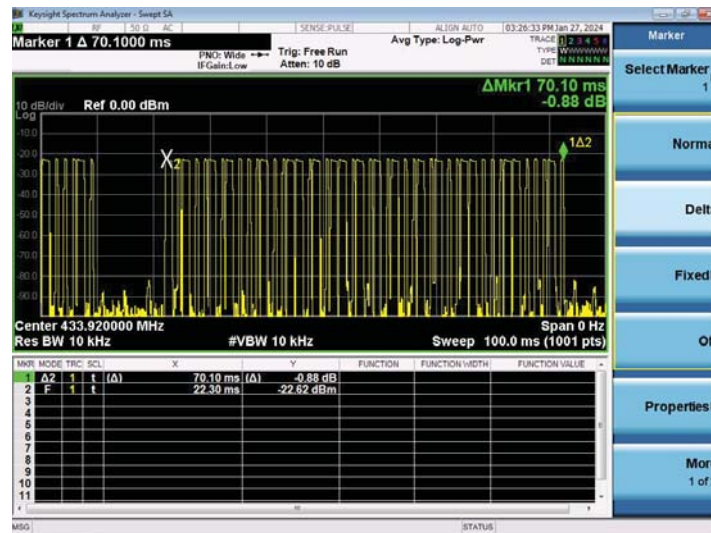
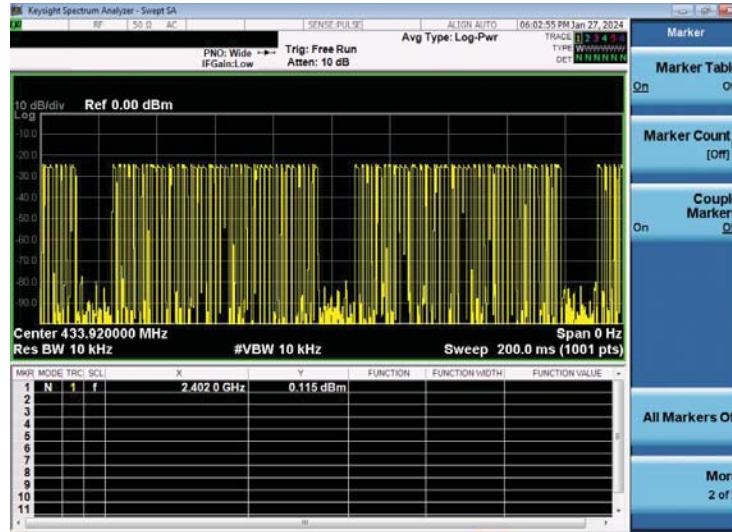

(Transmit cycle 70.10ms)

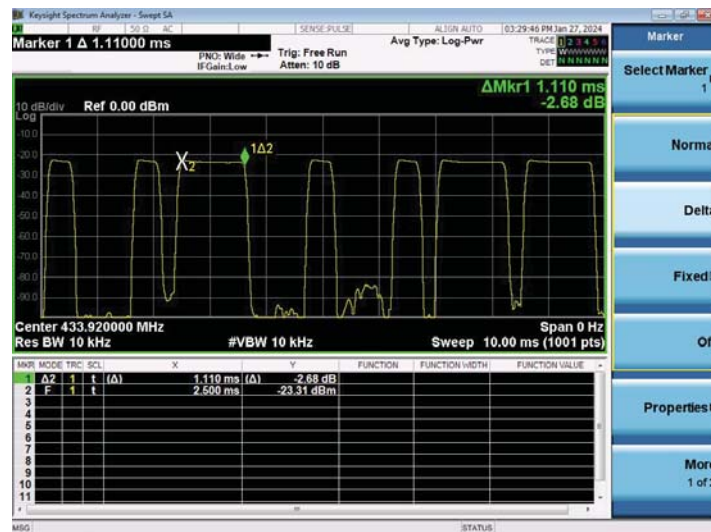

(Time per burst: 1.11ms*20pcs=22.2ms)

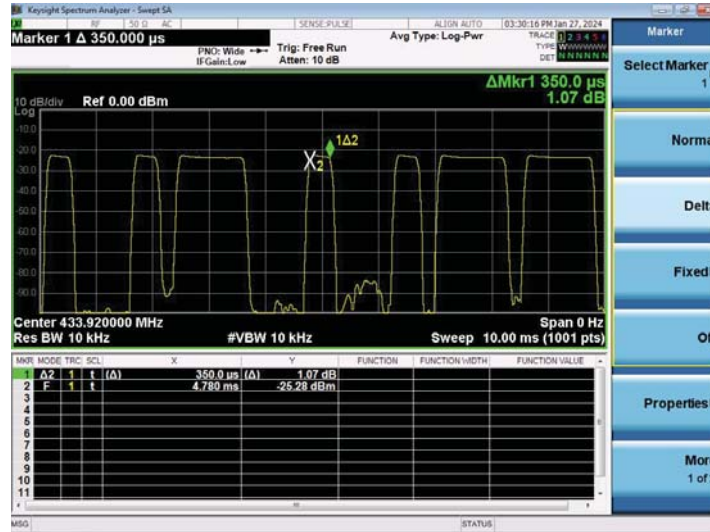

(Time per burst: $0.35\text{ms} \times 26\text{pcs} = 9.1\text{ms}$)

4.3 20dB Bandwidth

Limit

According to 47 CFR 15.231(c) The bandwidth of the emission shall be no wider than 0.25% of the centre frequency for devices operating above 70MHz and below 900MHz. Bandwidth is determined at the points 20dB down from the modulated carrier.

Test Configuration

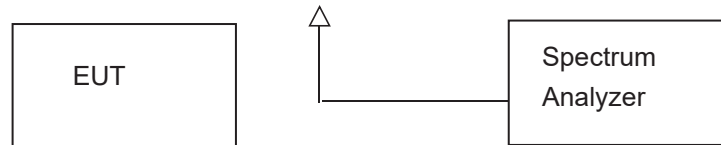

Test Procedure

The 20dB bandwidth and 99% bandwidth is measured with a spectrum analyzer connected via a receive antenna placed near the EUT while the EUT is operating in transmission mode.

The 20dB bandwidth is defined as the total spectrum the power of which is higher than peak power minus 20dB.

The occupied bandwidth (OBW), that is the frequency bandwidth such that, below its lower and above its upper frequency limits, the mean powers radiated are each equal to 0.5 percent of the total mean power radiated by a given emission.

Test Results

Modulation	Channel Frequency (MHz)	99% OBW (KHz)	20dB bandwidth (KHz)	Limit (KHz)	Result
ASK	433.92	41.025	39.90	$0.25\% * 433.92 = 1084.8$	Pass

Test plot as follows:

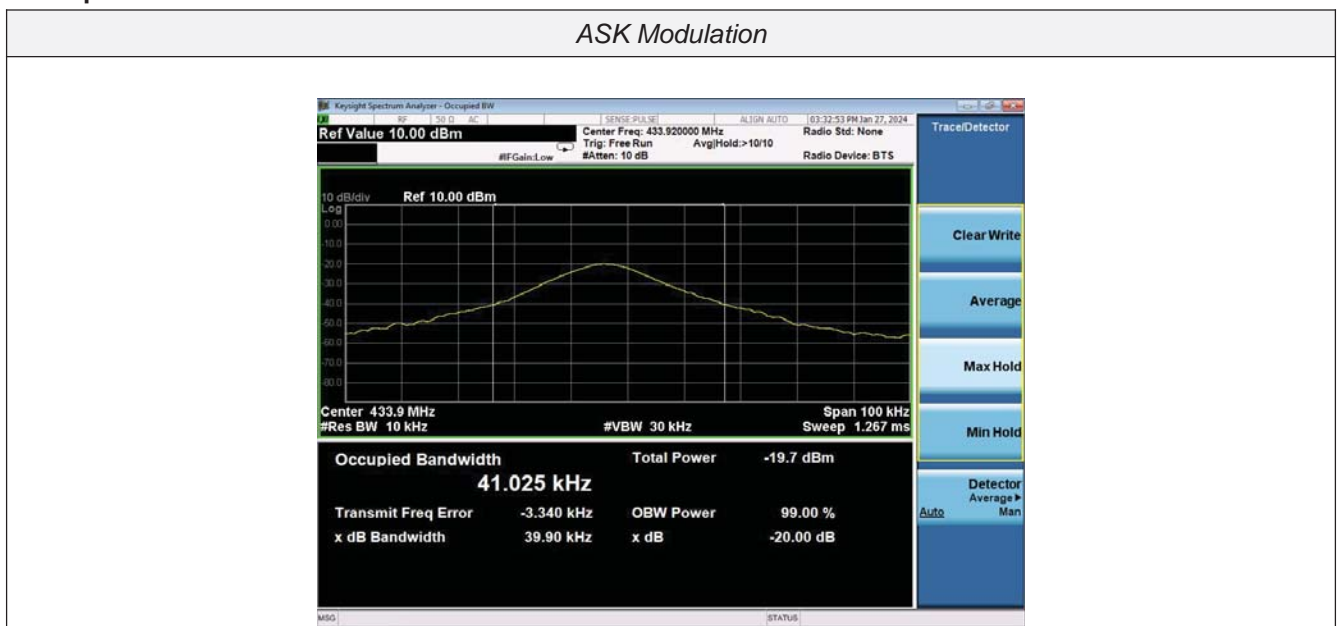

4.4 Deactivation Time

Limit

According to FCC §15.231(a)(2), A transmitter activated automatically shall cease transmission within 5 seconds after activation.

Test Configuration

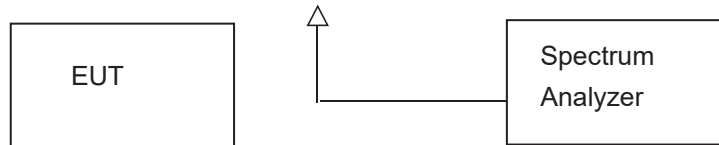

Test Procedure

1. The EUT was placed on a wooded table which is 0.8m height and close to receiver antenna of spectrum analyzer.
2. The spectrum analyzer resolution bandwidth was set to 1 MHz and video bandwidth was set to 1 MHz to encompass all significant spectral components during the test. The spectrum analyzer was operated in linear scale and zero span mode after tuning to the transmitter carrier frequency.

TEST RESULTS

Note: The transmitter was automatically activated, and the carrier frequency 433.92MHz :

Frequency (MHz)	One transmission time (S)	Limit(S)	Result
433.92	1.360	5	Pass

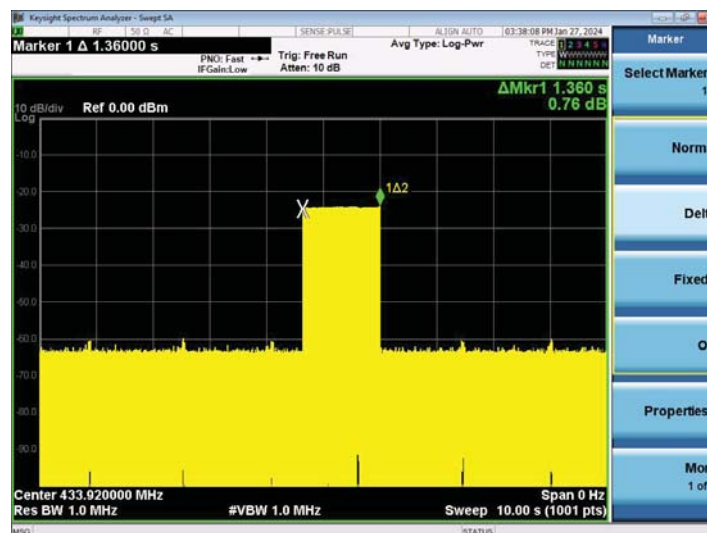

4.5 Antenna Requirement

Standard Applicable

According to FCC Part 15C 15.203

- a) An intentional radiator shall be de-signed to ensure that no antenna other than that furnished by the responsible party shall be used with the device.
- b) The manufacturer may design the unit so that a broken antenna can be replaced by the user, but the use of a standard antenna jack or electrical connector is prohibited.

Refer to statement below for compliance.

The manufacturer may design the unit so that the user can replace a broken antenna, but the use of a standard antenna jack or electrical connector is prohibited. Further, this requirement does not apply to intentional radiators that must be professionally installed.

Antenna Connected Construction

The antenna used in this product is a Metal Antenna, The directional gains of antenna used for transmitting is 0 dBi.

Remark:The antenna gain is provided by the customer , if the data provided by the customer is not accurate, BSL Testing Co., Ltd. does not assume any responsibility.

5 Test Setup Photos of the EUT



6 Photos of the EUT







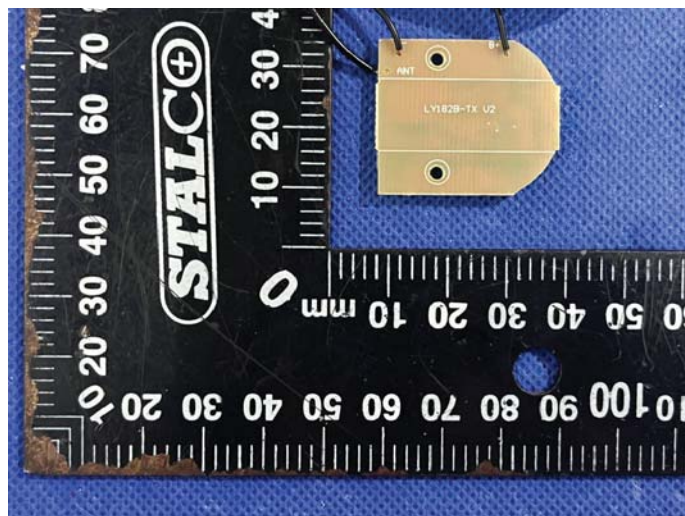
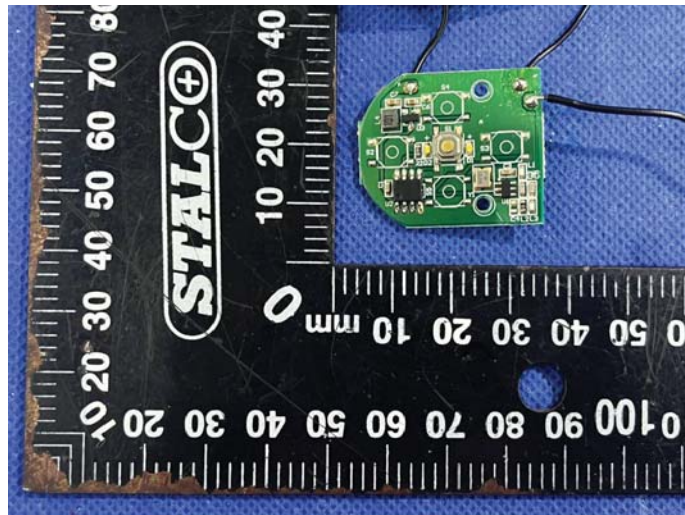
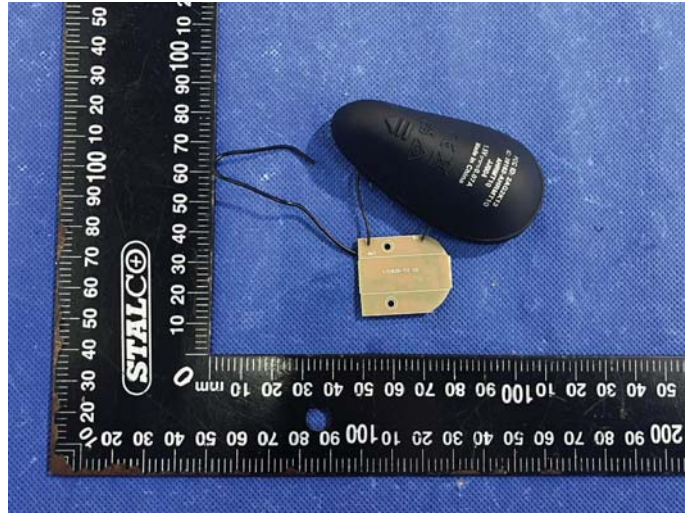

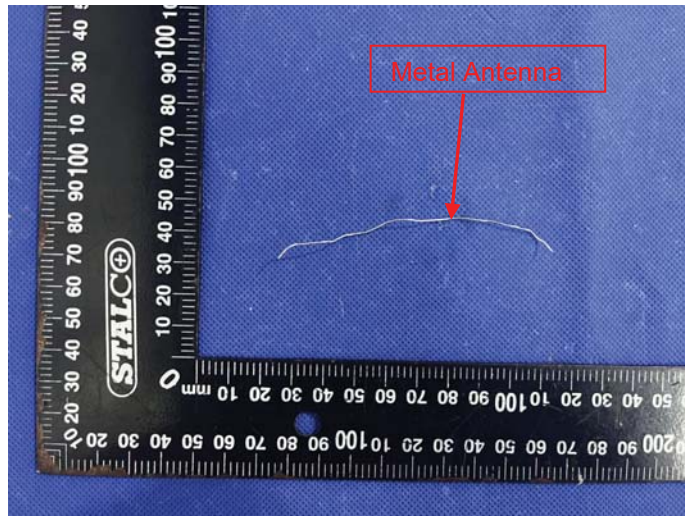

***** End of Report *****