

**ELECTROMAGNETIC EMISSIONS COMPLIANCE REPORT
INTENTIONAL RADIATOR CERTIFICATION TO
FCC PART 15 SUBPART C REQUIREMENT**

OF

The Cowgirl

Model No.: CG-001

Trademark: N/A

FCC ID: 2AG2K-CG-001

Report No.: ED170426013E

Issue Date: June 07, 2017

Prepared for

**A&H Design Group, Ltd
Suite 608, Tower One, Harbour Centre, 1 Hok Cheung Street, Hung Hom,
Kowloon, Hong Kong.**

Prepared by

EMTEK(DONGGUAN) CO., LTD.

**No.281, Guantai Road, Nancheng District,
Dongguan, Guangdong, China
TEL: 86-769-22807078
FAX: 86-769-22807079**

**This report shall not be reproduced, except in full, without the written approval of
EMTEK(DONGGUAN) CO., LTD.**

VERIFICATION OF COMPLIANCE

| | |
|----------------------|---|
| Applicant: | A&H Design Group, Ltd Suite 608, Tower One, Harbour Centre, 1 Hok Cheung Street, Hung Hom, Kowloon, Hong Kong. |
| Manufacturer: | A&H Design Group, Ltd Suite 608, Tower One, Harbour Centre, 1 Hok Cheung Street, Hung Hom, Kowloon, Hong Kong. |
| Product Description: | The Cowgirl |
| Trade Mark: | N/A |
| Model Number: | CG-001 |

We hereby certify that:

The above equipment was tested by EMTEK(DONGGUAN) CO., LTD. The test data, data evaluation, test procedures, and equipment configurations shown in this report were made in accordance with the procedures given in ANSI C63.10-2013 and the energy emitted by the sample EUT tested as described in this report is in compliance with conducted and radiated emission limits of FCC Rules Part 15.247(2016).

Date of Test : April 26, 2017 to June 05, 2017

Abby Li

Prepared by : Abby Li/Editor

Tomas Yang

Reviewer : Tomas Yang/Supervisor

Sam Lv

Approved & Authorized Signer : Sam Lv/Manager

Modified Information

| Version | Summary | Revision Date | Report No. |
|---------|-----------------|---------------|--------------|
| Ver.1.0 | Original Report | / | ED170426013E |
| | | | |
| | | | |
| | | | |
| | | | |
| | | | |
| | | | |

Table of Contents

| | | |
|-----------|---|-----------|
| 1. | GENERAL INFORMATION..... | 6 |
| 1.1 | PRODUCT DESCRIPTION..... | 6 |
| 1.2 | TEST METHODOLOGY | 6 |
| 2. | TEST FACILITY | 7 |
| 3. | DESCRIPTION OF TEST MODES..... | 8 |
| 4. | TEST SYSTEM UNCERTAINTY | 10 |
| 5. | CONDUCTED EMISSIONS TEST | 11 |
| 5.1 | MEASUREMENT PROCEDURE: | 11 |
| 5.2 | TEST SET-UP (BLOCK DIAGRAM OF CONFIGURATION)..... | 11 |
| 5.3 | MEASUREMENT EQUIPMENT USED:..... | 11 |
| 5.4 | CONDUCTED EMISSION LIMIT | 11 |
| 5.5 | MEASUREMENT RESULT:..... | 12 |
| 5.6 | CONDUCTED MEASUREMENT PHOTOS: | 15 |
| 6. | RADIATED EMISSION TEST | 16 |
| 6.1 | MEASUREMENT PROCEDURE | 16 |
| 6.2 | TEST SET-UP (BLOCK DIAGRAM OF CONFIGURATION)..... | 18 |
| 6.3 | MEASUREMENT EQUIPMENT USED:..... | 19 |
| 6.4 | RADIATED EMISSION LIMIT | 20 |
| 6.5 | MEASUREMENT RESULT..... | 21 |
| 6.6 | RADIATED MEASUREMENT PHOTOS: | 27 |
| 7. | 6DB BANDWIDTH MEASUREMENT | 28 |
| 7.1 | MEASUREMENT PROCEDURE | 28 |
| 7.2 | TEST SET-UP (BLOCK DIAGRAM OF CONFIGURATION)..... | 28 |
| 7.3 | MEASUREMENT EQUIPMENT USED:..... | 28 |
| 7.4 | LIMIT..... | 28 |
| 7.5 | MEASUREMENT RESULTS:..... | 28 |
| 7. | MAXIMUM PEAK OUTPUT POWER TEST | 31 |
| 7.1 | MEASUREMENT PROCEDURE | 31 |
| 7.2 | TEST SET-UP (BLOCK DIAGRAM OF CONFIGURATION)..... | 31 |
| 7.3 | MEASUREMENT EQUIPMENT USED:..... | 31 |
| 7.4 | PEAK POWER OUTPUT LIMIT | 31 |
| 7.5 | 7.5 MEASUREMENT RESULTS:..... | 31 |
| 8. | POWER SPECTRAL DENSITY MEASUREMENT | 34 |
| 8.1 | MEASUREMENT PROCEDURE | 34 |
| 8.2 | TEST SET-UP (BLOCK DIAGRAM OF CONFIGURATION)..... | 34 |
| 8.3 | MEASUREMENT EQUIPMENT USED: | 34 |

8.4 MEASUREMENT PROCEDURE 34

8.5 MEASUREMENT RESULTS:..... 35

9. BAND EDGE TEST 39

9.1 MEASUREMENT PROCEDURE 39

9.2 TEST SET-UP (BLOCK DIAGRAM OF CONFIGURATION)..... 40

9.3 MEASUREMENT EQUIPMENT USED:..... 40

9.4 MEASUREMENT RESULTS:..... 41

10 ANTENNA APPLICATION 42

10.1 ANTENNA REQUIREMENT 42

10.2 RESULT 42

11 PHOTOS OF EUT 42

1. GENERAL INFORMATION

1.1 Product Description

| Characteristics | Description |
|---------------------------|---|
| Product Name | The Cowgirl |
| Model number | CG-001 |
| Power Supply | DC 24V from adapter |
| Adapter | Model number: S090A2402700P Input rating: 100-240V~, 50-60Hz, 2A Max Output rating: DC24V, 2.7A |
| Kind of Device | Bluetooth Ver.4.0 BLE |
| Modulation | GFSK |
| Operating Frequency Range | 2402-2480MHz |
| Number of Channels | 40 |
| Transmit Power Max(PK) | -1.44dBm(0.000718W) |
| Antenna Type | Internal PCB antenna |
| Antenna Gain | 0dBi |

1.2 Test Methodology

All the test program has follow FCC new test procedure KDB 558074 D01 DTS Meas Guidance v04, April 5, 2017 and in accordance with the procedures given in ANSI C63.10-2013.

2. Test Facility

Site Description

EMC Lab. : Registered on FCC, July 06, 2016
The Certificate Number is 247565.

Registered on Industry Canada, January 13, 2017
The Certificate Number is 9444A

Name of Firm : EMTEK(DONGGUAN) CO., LTD.

Site Location : No.281, Guantai Road, Nancheng District,
Dongguan, Guangdong, China

3. Description of test modes

The EUT has been tested under its typical operating condition and fully-charged battery for EUT tested alone. Pre-defined engineering program for regulatory testing used to control the EUT for staying in continuous transmitting. Only the worst case data were reported.

The EUT has been associated with peripherals pursuant to ANSI C63.10-2013 and configuration operated in a manner tended to maximize its emission characteristics in a typical application. Frequency range investigated: radiation (9 KHz to the 10th harmonics of the highest fundamental frequency or to 40 GHz, whichever is lower).

For Radiated: The EUT's antenna was pre-tested under the following modes:

| Test Mode | Description |
|---------------|-----------------|
| Mode A | X-Y axis |
| Mode B | Y-Z axis |
| Mode C | X-Z axis |

From the above modes, the worst case was found in Mode A. Therefore only the test data of the mode was recorded in this report

The EUT has been tested under its typical operating condition. Pre-defined engineering program for regulatory testing used to control the EUT for staying in continuous transmitting. Only the worst case data were reported.

The EUT has been associated with peripherals pursuant to ANSI C63.10-2013 and configuration operated in a manner tended to maximize its emission characteristics in a typical application. Frequency range investigated: radiation (9 KHz to the 10th harmonics of the highest fundamental frequency or to 40 GHz, whichever is lower).

The EUT has been tested under TX operating condition.
Channel List:

| Channel | Frequency (MHz) | Channel | Frequency (MHz) | Channel | Frequency (MHz) |
|-----------|-----------------|-----------|-----------------|-----------|-----------------|
| 00 | 2402 | 14 | 2430 | 28 | 2458 |
| 01 | 2404 | 15 | 2432 | 29 | 2460 |
| 02 | 2406 | 16 | 2434 | 30 | 2462 |
| 03 | 2408 | 17 | 2436 | 31 | 2464 |
| 04 | 2410 | 18 | 2438 | 32 | 2466 |
| 05 | 2412 | 19 | 2440 | 33 | 2468 |
| 06 | 2414 | 20 | 2442 | 34 | 2470 |
| 07 | 2416 | 21 | 2444 | 35 | 2472 |
| 08 | 2418 | 22 | 2446 | 36 | 2474 |
| 09 | 2420 | 23 | 2448 | 37 | 2476 |
| 10 | 2422 | 24 | 2450 | 38 | 2478 |
| 11 | 2424 | 25 | 2452 | 39 | 2480 |
| 12 | 2426 | 26 | 2454 | | |
| 13 | 2428 | 27 | 2456 | | |

Note:

1. Test of channel was included the lowest 2402MHz, middle 2440MHz and highest frequency 2480MHz in highest data rate and to perform the test, then record on this report.

4. TEST SYSTEM UNCERTAINTY

The following measurement uncertainty levels have been estimated for tests performed on the apparatus:

| Parameter | Uncertainty |
|--------------------------------|-------------------------|
| Radio Frequency | $\pm 1 \times 10^{-5}$ |
| Maximum Peak Output Power Test | $\pm 1.0\text{dB}$ |
| Conducted Emissions Test | $\pm 2.0\text{dB}$ |
| Radiated Emission Test | $\pm 2.0\text{dB}$ |
| Power Density | $\pm 2.0\text{dB}$ |
| Occupied Bandwidth Test | $\pm 1.0\text{dB}$ |
| Band Edge Test | $\pm 3\text{dB}$ |
| All emission, radiated | $\pm 3\text{dB}$ |
| Antenna Port Emission | $\pm 3\text{dB}$ |
| Temperature | $\pm 0.5^\circ\text{C}$ |
| Humidity | $\pm 3\%$ |

Remark: The coverage Factor (k=2), and measurement Uncertainty for a level of Confidence of 95%

5. Conducted Emissions Test

5.1 Measurement Procedure:

1. The EUT was placed on a table, which is 0.8m above ground plane.
2. Maximum procedure was performed on the six highest emissions to ensure EUT compliance.
3. Repeat above procedures until all frequency measured was complete.

5.2 Test SET-UP (Block Diagram of Configuration)

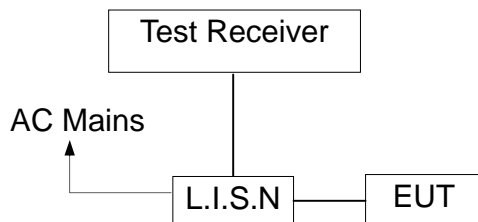

5.3 Measurement Equipment Used:

| Conducted Emission Test Site | | | | | | |
|------------------------------|-----------------|--------------|---------------|-----------------|------------|------------|
| EQUIPMENT TYPE | MFR | MODEL NUMBER | SERIAL NUMBER | Characteristics | Last Cal. | Due date |
| Test Receiver | Rohde & Schwarz | ESCS30 | 100018 | 9kHz~3GHz | 05/16/2017 | 05/15/2018 |
| L.I.S.N | Rohde & Schwarz | ENV216 | 100017 | 9KHz-300MHz | 05/16/2017 | 05/15/2018 |
| RF Switching Unit | CDS | RSU-M2 | 38401 | 9KHz-300MHz | 05/16/2017 | 05/15/2018 |
| Coaxial Cable | CDS | 79254 | 46107086 | 9kHz~3GHz | 05/16/2017 | 05/15/2018 |

5.4 Conducted Emission Limit

(7) Conducted Emission Frequency(MHz)

0.15-0.5
0.5-5.0
5.0-30.0

Quasi-peak
66-56
56
60

Average
56-46
46
50

Note:

1. The lower limit shall apply at the transition frequencies
2. The limit decreases in line with the logarithm of the frequency in the range of 0.15 to 0.50MHz.

5.5 Measurement Result:

Pass.

Conducted emission at both 120V & 240V is assessed, and emission at 120V represents the worst case. All the modulation modes were tested the data of the worst mode (GFSK TX 2440MHz) are recorded in the following pages and the others modulation methods do not exceed the limits.

Please refer to the following data.

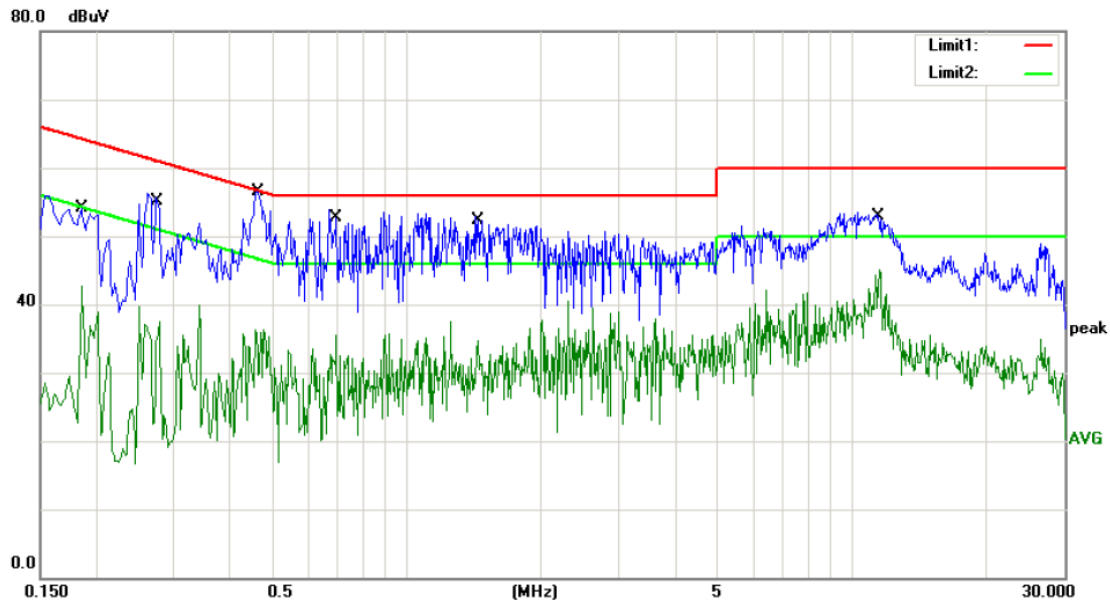

Site site #1 Phase: **L1** Temperature: 24
 Limit: (CE)FCC PART 15C_QP Power: AC 120V/60Hz Humidity: 55 %
 Mode: TX2440
 Note:

| No. | Mk. | Freq. MHz | Reading Level dBuV | Correct Factor dB | Measure- ment dBuV | Limit dBuV | Over dB | Detector | Comment |
|-----|-----|--------------|--------------------------|-------------------------|--------------------------|---------------|------------|----------|---------|
| 1 | | 0.1860 | 54.15 | 0.00 | 54.15 | 64.21 | -10.06 | QP | |
| 2 | | 0.1860 | 42.79 | 0.00 | 42.79 | 54.21 | -11.42 | AVG | |
| 3 | | 0.2780 | 56.39 | 0.00 | 56.39 | 60.88 | -4.49 | QP | |
| 4 | | 0.2780 | 37.50 | 0.00 | 37.50 | 50.88 | -13.38 | AVG | |
| 5 | | 0.4620 | 50.50 | 0.00 | 50.50 | 56.66 | -6.16 | QP | |
| 6 | | 0.4620 | 36.34 | 0.00 | 36.34 | 46.66 | -10.32 | AVG | |
| 7 | | 0.6940 | 49.95 | 0.00 | 49.95 | 56.00 | -6.05 | QP | |
| 8 | | 0.6940 | 35.44 | 0.00 | 35.44 | 46.00 | -10.56 | AVG | |
| 9 | * | 1.4460 | 51.89 | 0.00 | 51.89 | 56.00 | -4.11 | QP | |
| 10 | | 1.4460 | 34.75 | 0.00 | 34.75 | 46.00 | -11.25 | AVG | |
| 11 | | 11.5340 | 53.12 | 0.00 | 53.12 | 60.00 | -6.88 | QP | |
| 12 | | 11.5340 | 45.19 | 0.00 | 45.19 | 50.00 | -4.81 | AVG | |

*:Maximum data x:Over limit !:over margin Comment: Factor build in receiver. Operator: Aspen

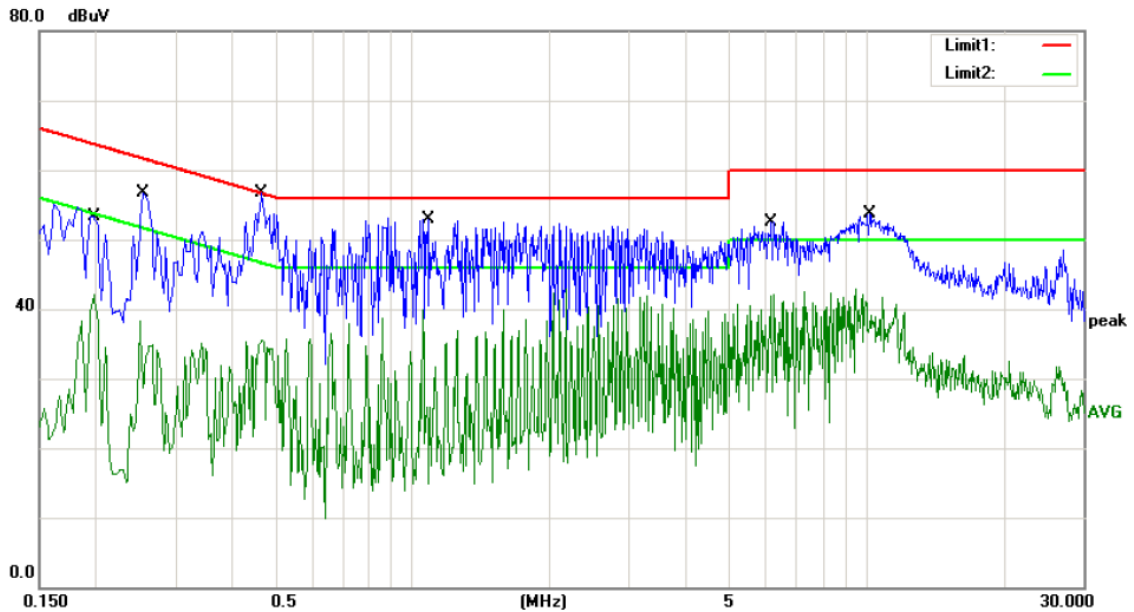

Site site #1 Phase: **N** Temperature: 24
 Limit: (CE)FCC PART 15C_QP Power: AC 120V/60Hz Humidity: 55 %
 Mode: TX2440
 Note:

| No. | Mk. | Freq. MHz | Reading Level dBuV | Correct Factor dB | Measure- ment dBuV | Limit dBuV | Over dB | Detector | Comment |
|-----|-----|--------------|--------------------------|-------------------------|--------------------------|---------------|------------|----------|---------|
| 1 | | 0.1980 | 54.78 | 0.00 | 54.78 | 63.69 | -8.91 | QP | |
| 2 | | 0.1980 | 42.06 | 0.00 | 42.06 | 53.69 | -11.63 | AVG | |
| 3 | | 0.2540 | 54.65 | 0.00 | 54.65 | 61.63 | -6.98 | QP | |
| 4 | | 0.2540 | 38.38 | 0.00 | 38.38 | 51.63 | -13.25 | AVG | |
| 5 | | 0.4660 | 51.70 | 0.00 | 51.70 | 56.58 | -4.88 | QP | |
| 6 | | 0.4660 | 35.43 | 0.00 | 35.43 | 46.58 | -11.15 | AVG | |
| 7 | * | 1.0820 | 52.86 | 0.00 | 52.86 | 56.00 | -3.14 | QP | |
| 8 | | 1.0820 | 39.89 | 0.00 | 39.89 | 46.00 | -6.11 | AVG | |
| 9 | | 6.2500 | 52.52 | 0.00 | 52.52 | 60.00 | -7.48 | QP | |
| 10 | | 6.2500 | 42.16 | 0.00 | 42.16 | 50.00 | -7.84 | AVG | |
| 11 | | 10.1660 | 53.63 | 0.00 | 53.63 | 60.00 | -6.37 | QP | |
| 12 | | 10.1660 | 42.04 | 0.00 | 42.04 | 50.00 | -7.96 | AVG | |

*:Maximum data x:Over limit !:over margin Comment: Factor build in receiver. Operator: Aspen

4.6 Conducted Measurement Photos:



6. Radiated Emission Test

5.1 Measurement Procedure

1. The testing follows the guidelines in ANSI C63.10-2013.
2. Below 1000MHz, The EUT was placed on a turn table which is 0.8m above ground plane. And above 1000MHz, The EUT was placed on a styrofoam table which is 1.5m above ground plane.
3. The EUT was set 3 meters from the interference receiving antenna, which was mounted on the top of a variable height antenna tower.
4. The EUT was arranged to its worst case and then tune the Antenna tower (From 1m to 4m) and turntable (from 0 degree to 360 degrees) to find the maximum reading. A pre-amp and a high pass filter are used for the test in order to get better signal level.
5. For measurement below 1GHz, if the emission level of the EUT measured by the peak detector is 3dB lower than the applicable limit, the peak emission level will be reported. Otherwise, the emission measurement will be repeated using the quasi-peak detector and reported.
6. Final measurement (Above 1GHz): The frequency range will be divided into different sub ranges depending of the frequency range of the used horn antenna. The EMI Receiver set to peak and average mode and a resolution bandwidth of 1MHz. The measurement will be performed in horizontal and vertical polarization of the measuring antenna and while rotating the EUT in its vertical axis in the range of 0 degree to 360 degree in order to have the antenna inside the cone of radiation.
7. Test Procedure of measurement (For Above 1GHz):
 - 1) Monitor the frequency range at horizontal polarization and move the antenna over all sides of the EUT(if necessary move the EUT to another orthogonal axis).
 - 2) Change the antenna polarization and repeat 1) with vertical polarization.
 - 3) Make a hardcopy of the spectrum.
 - 4) Measure the frequency of the detected emissions with a lower span and resolution bandwidth to increase the accuracy and note the frequency value.
 - 5) Change the analyser mode to Clear/ Write and found the cone of emission.
 - 6) Rotate and move the EUT, so that the measuring distance can be enlarged to 3m and the antenna will be still inside the cone of emission.
 - 7) Measure the level of the detected frequency with the correct resolution bandwidth, with the antenna polarization and azimuth and the peak and average detector, which causes the maximum emission.
 - 8) Repeat steps 1) to 7) for the next antenna spot if the EUT is larger than the antenna beamwidth.

Use the following spectrum analyzer settings:

When spectrum scanned from 30MHz to 1GHz setting resolution bandwidth 120KHz and video bandwidth 300KHz:

| EMI Test Receiver | Setting |
|-------------------|----------|
| Attenuation | Auto |
| RB | 120KHz |
| VB | 300KHz |
| Detector | QP |
| Trace | Max hold |

When spectrum scanned above 1GHz setting resolution bandwidth 1MHz, video bandwidth 3MHz:

| EMI Test Receiver | Setting |
|-------------------|----------|
| Attenuation | Auto |
| RB | 1MHz |
| VB | 3MHz |
| Detector | Peak |
| Trace | Max hold |

When spectrum scanned above 1GHz setting resolution bandwidth 1MHz, video bandwidth 10Hz:

| EMI Test Receiver | Setting |
|-------------------|----------|
| Attenuation | Auto |
| RB | 1MHz |
| VB | 10Hz |
| Detector | Peak |
| Trace | Max hold |

For Average Measurement:

VBW=10Hz, when duty cycle is no less than 98 percent.

$VBW \geq 1/T$, when duty cycle is less than 98 percent where T is the minimum transmission duration over which the transmitter is on and is transmitting at its maximum power control level for the tested mode of operation.

| Band | Duty Cycle(%) | T(μ s) | 1/T(KHz) | Average Correction Factor | VBW Setting |
|-----------|---------------|-------------|----------|---------------------------|-------------|
| 2402-2480 | 100 | - | - | 0 | 10Hz |

5.2 Test SET-UP (Block Diagram of Configuration)

(A) Radiated Emission Test Set-Up, Frequency Below 30MHz

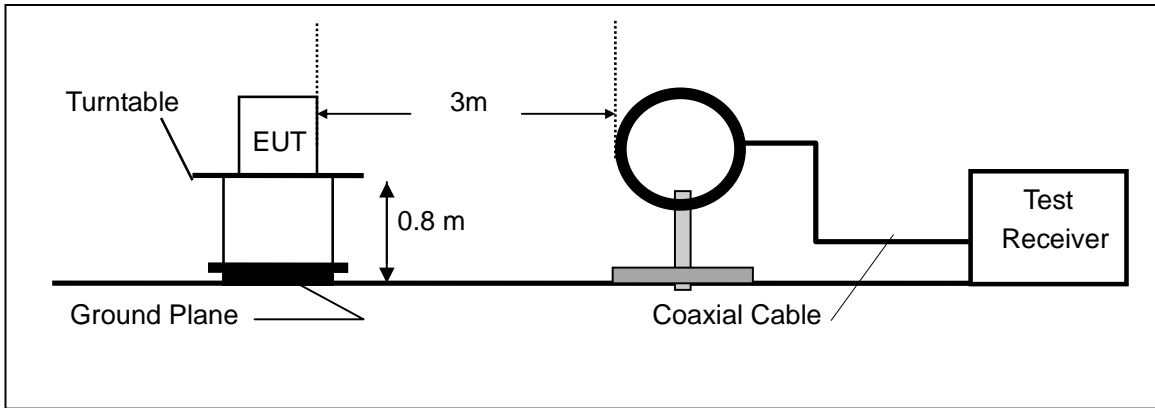

(B) Radiated Emission Test Set-Up, Frequency Below 1000MHz

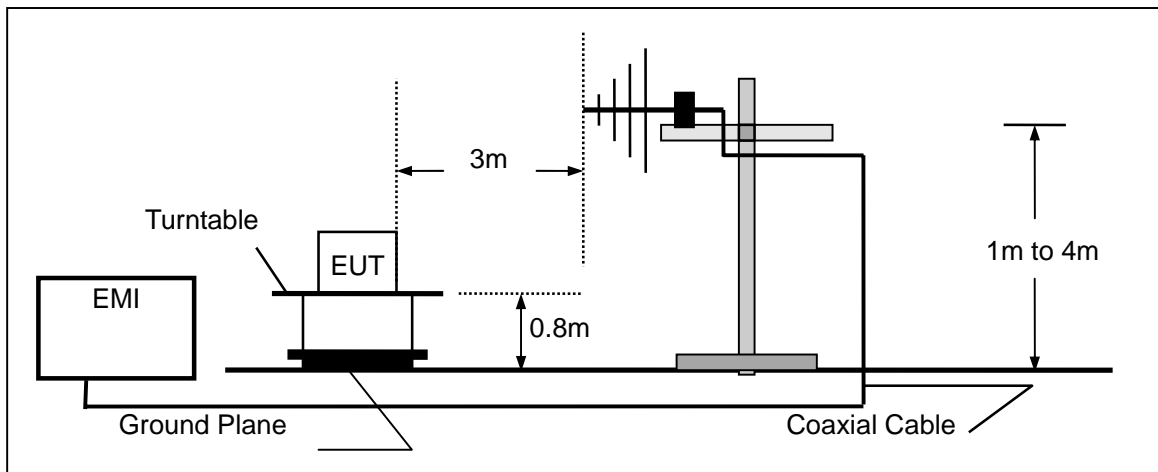

(C) Radiated Emission Test Set-Up, Frequency above 1000MHz

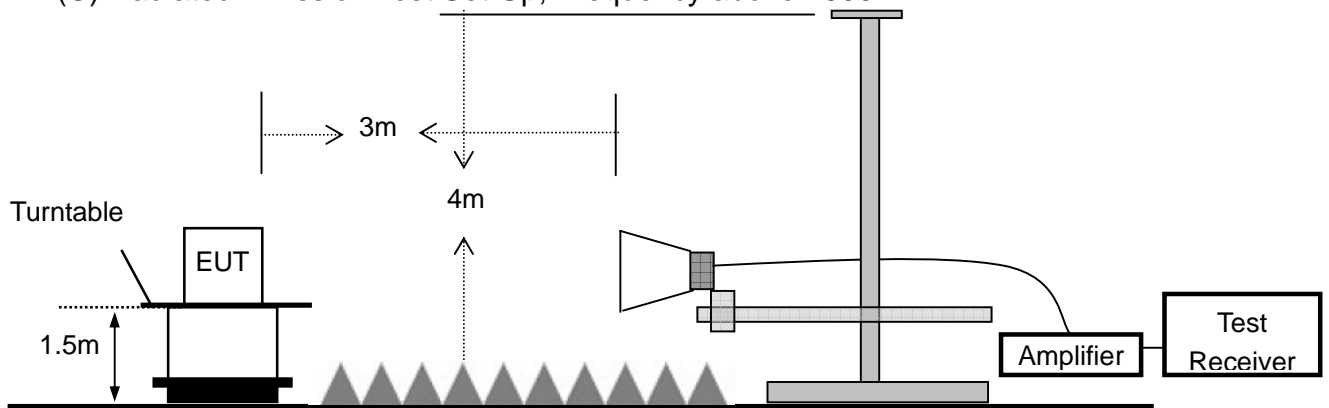

5.3 Measurement Equipment Used:

| Item | Equipment | Manufacturer | Model No. | Serial No. | Characteristics | Last Cal. | Cal. Interval |
|------|--------------------------------|-----------------|------------|--------------|-----------------|------------|---------------|
| 1. | Test Receiver | Rohde & Schwarz | ESCI | 1166.5950.03 | 9KHz-3GHz | 05/16/2017 | 1 Year |
| 2. | Loop Antenna | Schwarzbeck | FMZB 1519 | 012 | 9 KHz -30MHz | 05/16/2017 | 1 Year |
| 3. | Bilog Antenna | Schwarzbeck | VULB9163 | 000141 | 25MHz-2GHz | 05/16/2017 | 1 Year |
| 4. | Power Amplifier | CDS | RSU-M352 | 818 | 1MHz-1GHz | 05/16/2017 | 1 Year |
| 5. | Power Amplifier | HP | 8447F | OPT H64 | 1GHz-26.5GHz | 05/16/2017 | 1 Year |
| 6. | Color Monitor | SUNSP0 | SP-140A | N/A | -- | 05/16/2017 | 1 Year |
| 7. | Single Line Filter | JIANLI | XL-3 | N/A | -- | 05/16/2017 | 1 Year |
| 8. | Single Phase Power Line Filter | JIANLI | DL-2X100B | N/A | -- | 05/16/2017 | 1 Year |
| 9. | 3 Phase Power Line Filter | JIANLI | DL-4X100B | N/A | -- | 05/16/2017 | 1 Year |
| 10. | DC Power Filter | JIANLI | DL-2X50B | N/A | -- | 05/16/2017 | 1 Year |
| 11. | Cable | Schwarzbeck | PLF-100 | 549489 | 9KHz-3GHz | 05/16/2017 | 1 Year |
| 12. | Cable | Rosenberger | CIL02 | A0783566 | 9KHz-3GHz | 05/16/2017 | 1 Year |
| 13. | Cable | Rosenberger | RG 233/U | 525178 | 9KHz-3GHz | 05/16/2017 | 1 Year |
| 14. | Signal Analyzer | Rohde & Schwarz | FSV30 | 103040 | 9KHz-40GHz | 05/16/2017 | 1 Year |
| 15. | Horn Antenna | Schwarzbeck | BBHA9120D | 9120D-1272 | 1GHz-18GHz | 05/16/2017 | 1 Year |
| 16. | Horn Antenna | Schwarzbeck | BBHA 9170 | BBHA9170399 | 14GHz -26.5GHz | 05/16/2017 | 1 Year |
| 17. | Power Amplifier | LUNAR EM | LNA1G18-40 | J10100000081 | 1GHz-26.5GHz | 05/16/2017 | 1 Year |
| 18. | Cable | H+S | CBL-26 | N/A | 1GHz-26.5GHz | 05/16/2017 | 1 Year |
| 19. | Cable | H+S | CBL-26 | N/A | 1GHz-26.5GHz | 05/16/2017 | 1 Year |
| 20. | Cable | H+S | CBL-26 | N/A | 1GHz-26.5GHz | 05/16/2017 | 1 Year |

5.4 Radiated emission limit

The emissions from an intentional radiator shall not exceed the field strength levels specified in the following table 15.209(a):

| Frequencies (MHz) | Field Strength (micровolts/meter) | Measurement Distance (meters) |
|-------------------|-----------------------------------|-------------------------------|
| 0.009~0.490 | 2400/F(KHz) | 300 |
| 0.490~1.705 | 24000/F(KHz) | 30 |
| 1.705~30.0 | 30 | 30 |
| 30~88 | 100 | 3 |
| 88~216 | 150 | 3 |
| 216~960 | 200 | 3 |
| Above 960 | 500 | 3 |

15.205 Restricted bands of operation

| MHz | MHz | MHz | GHz |
|----------------------------|-----------------------|-----------------|------------------|
| 0.090 - 0.110 | 16.42 - 16.423 | 399.9 - 410 | 4.5 - 5.15 |
| ¹ 0.495 - 0.505 | 16.69475 - 16.69525 | 608 - 614 | 5.35 - 5.46 |
| 2.1735 - 2.1905 | 16.80425 - 16.80475 | 960 - 1240 | 7.25 - 7.75 |
| 4.125 - 4.128 | 25.5 - 25.67 | 1300 - 1427 | 8.025 - 8.5 |
| 4.17725 - 4.17775 | 37.5 - 38.25 | 1435 - 1626.5 | 9.0 - 9.2 |
| 4.20725 - 4.20775 | 73 - 74.6 | 1645.5 - 1646.5 | 9.3 - 9.5 |
| 6.215 - 6.218 | 74.8 - 75.2 | 1660 - 1710 | 10.6 - 12.7 |
| 6.26775 - 6.26825 | 108 - 121.94 | 1718.8 - 1722.2 | 13.25 - 13.4 |
| 6.31175 - 6.31225 | 123 - 138 | 2200 - 2300 | 14.47 - 14.5 |
| 8.291 - 8.294 | 149.9 - 150.05 | 2310 - 2390 | 15.35 - 16.2 |
| 8.362 - 8.366 | 156.52475 - 156.52525 | 2483.5 - 2500 | 17.7 - 21.4 |
| 8.37625 - 8.38675 | 156.7 - 156.9 | 2690 - 2900 | 22.01 - 23.12 |
| 8.41425 - 8.41475 | 162.0125 - 167.17 | 3260 - 3267 | 23.6 - 24.0 |
| 12.29 - 12.293 | 167.72 - 173.2 | 3332 - 3339 | 31.2 - 31.8 |
| 12.51975 - 12.52025 | 240 - 285 | 3345.8 - 3358 | 36.43 - 36.5 |
| 12.57675 - 12.57725 | 322 - 335.4 | 3600 - 4400 | (²) |

- Remark 1. Emission level in dBuV/m=20 log (uV/m)
 : 2. Measurement was performed at an antenna to the closed point of EUT distance of meters.
 3. Only spurious frequency is permitted to locate within the Restricted Bands specified in provision of § 15.205, and the emissions located in restricted bands also comply with 15.209 limit.

5.5 Measurement Result

Below 30MHz:

| | | | |
|--------------------|------------|---------------|--------------|
| Operation Mode: | TX | Test Date : | May 09, 2017 |
| Frequency Range: | 9KHz~30MHz | Temperature : | 28°C |
| Test Result: | PASS | Humidity : | 65 % |
| Measured Distance: | 3m | Test By: | W |

| Freq. (MHz) | Ant.Pol. H/V | Emission Level (dBuV/m) | Limit 3m (dBuV/m) | Over (dB) |
|----------------|-----------------|-------------------------------|----------------------|--------------|
| -- | -- | -- | -- | -- |

Note: The low frequency, which started from 9KHz-30MHz, was pre-scanned and the result which was 20dB lower than the limit line per 15.31(o) was not reported.

Below 1000MHz:

Pass.

The data of the mode (GFSK 2440MHz) are recorded in the following pages.

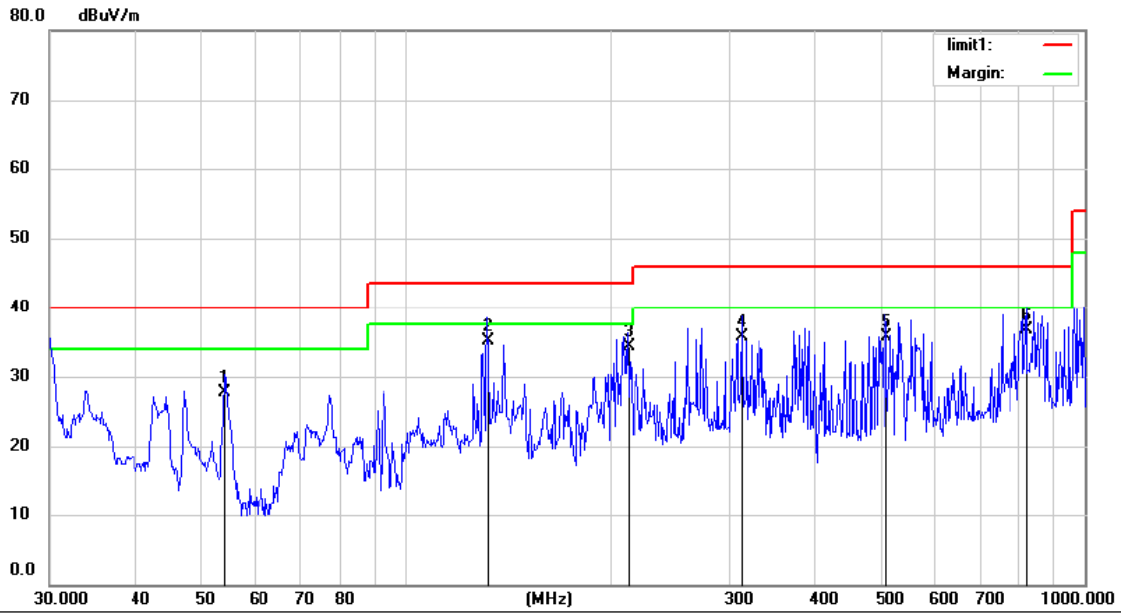

Site Chamber #1 Polarization: **Horizontal** Temperature: 26
 Limit: (RE)FCC PART 15 C 3m Power: AC 120V/60Hz Humidity: 55 %
 Mode: TX2440
 Note:

| No. | Mk. | Freq. | Reading Level | Correct Factor | Measurement | Limit | Over | Antenna Height | Table Degree | |
|-----|-----|----------|---------------|----------------|-------------|--------|--------|----------------|--------------|---------|
| | | MHz | dBuV | dB | dBuV/m | dBuV/m | dB | cm | degree | Comment |
| 1 | | 54.2500 | 44.58 | -16.80 | 27.78 | 40.00 | -12.22 | | | QP |
| 2 | * | 131.8500 | 52.65 | -17.55 | 35.10 | 43.50 | -8.40 | | | QP |
| 3 | | 212.3600 | 52.05 | -17.81 | 34.24 | 43.50 | -9.26 | | | QP |
| 4 | | 313.2400 | 49.65 | -14.00 | 35.65 | 46.00 | -10.35 | | | QP |
| 5 | | 509.1800 | 45.99 | -10.29 | 35.70 | 46.00 | -10.30 | | | QP |
| 6 | | 824.4300 | 41.35 | -4.69 | 36.66 | 46.00 | -9.34 | | | QP |

*:Maximum data x:Over limit !:over margin

Operator: W

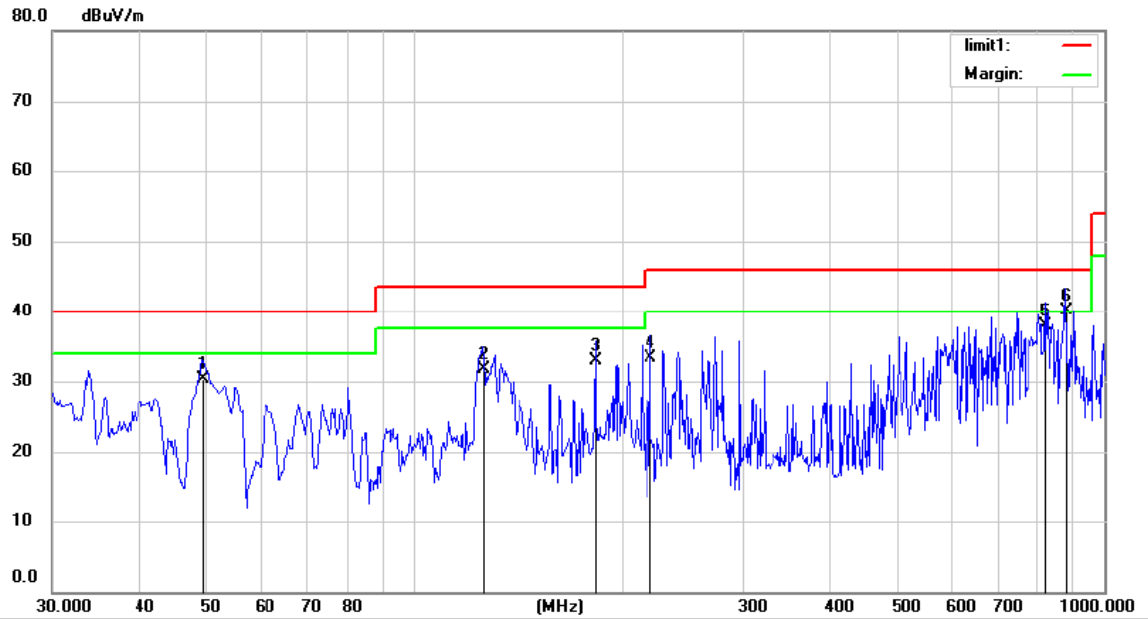

Site Chamber #1 Polarization: **Vertical** Temperature: 26
 Limit: (RE)FCC PART 15 C 3m Power: AC 120V/60Hz Humidity: 55 %
 Mode: TX2440
 Note:

| No. | Mk. | Freq. MHz | Reading Level dBuV | Correct Factor dB | Measure- ment dBuV/m | Limit dBuV/m | Over dB | Antenna Height cm | Table Degree degree | Comment |
|-----|-----|--------------|--------------------------|-------------------------|----------------------------|-----------------|------------|-------------------------|---------------------------|---------|
| 1 | | 49.4000 | 45.13 | -14.91 | 30.22 | 40.00 | -9.78 | QP | | |
| 2 | | 126.0300 | 49.23 | -17.55 | 31.68 | 43.50 | -11.82 | QP | | |
| 3 | | 183.2600 | 52.60 | -19.64 | 32.96 | 43.50 | -10.54 | QP | | |
| 4 | | 220.1200 | 50.54 | -17.19 | 33.35 | 46.00 | -12.65 | QP | | |
| 5 | | 824.4300 | 42.35 | -4.39 | 37.96 | 46.00 | -8.04 | QP | | |
| 6 | * | 880.6900 | 44.25 | -4.18 | 40.07 | 46.00 | -5.93 | QP | | |

*:Maximum data x:Over limit !:over margin

Operator: W

Above 1000MHz~10th Harmonics:

Operation Mode: TX Mode (CH00: 2402MHz) Test Date : May 09, 2017
 Frequency Range: 1-25GHz Temperature : 25 °C
 Test Result: PASS Humidity : 50 %
 Measured Distance: 3m Test By: W

| Freq. (MHz) | Ant. Pol. H/V | Emission Level(dBuV/m) | | Limit 3m(dBuV/m) | | Margin(dB) | |
|----------------|------------------|------------------------|-------|------------------|----|------------|--------|
| | | PK | AV | PK | AV | PK | AV |
| 4804 | V | 64.12 | 44.02 | 74 | 54 | -9.88 | -9.98 |
| 7206 | V | 63.05 | 43.95 | 74 | 54 | -10.95 | -10.05 |
| 9608 | V | 62.95 | 42.14 | 74 | 54 | -11.05 | -11.86 |
| 12010 | V | 61.41 | 41.95 | 74 | 54 | -12.59 | -12.05 |
| 14412 | V | 60.25 | 40.6 | 74 | 54 | -13.75 | -13.4 |
| 16814 | V | 59.06 | 39.52 | 74 | 54 | -14.94 | -14.48 |
| 4804 | H | 65.12 | 45.62 | 74 | 54 | -8.88 | -8.38 |
| 7206 | H | 62.62 | 42.52 | 74 | 54 | -11.38 | -11.48 |
| 9608 | H | 61.36 | 41.95 | 74 | 54 | -12.64 | -12.05 |
| 12010 | H | 60.95 | 40.28 | 74 | 54 | -13.05 | -13.72 |
| 14412 | H | 59.42 | 39.52 | 74 | 54 | -14.58 | -14.48 |
| 16814 | H | 58.52 | 38.62 | 74 | 54 | -15.48 | -15.38 |

Other harmonics emissions are lower than 20dB below the allowable limit.

- Note:**
- (1) All Readings are Peak Value and AV.
 - (2) Emission Level= Reading Level+ Probe Factor +Cable Loss.
 - (3) The average measurement was not performed when the peak measured data under the limit of average detection.
 - (4) Measuring frequencies from 1GHz to 25GHz.

Operation Mode: TX Mode (CH19: 2440MHz) Test Date : May 09, 2017
 Frequency Range: 1-25GHz Temperature : 25 °C
 Test Result: PASS Humidity : 50 %
 Measured Distance: 3m Test By: W

| Freq. (MHz) | Ant. Pol. H/V | Emission Level(dBuV/m) | | Limit 3m(dBuV/m) | | Margin(dB) | |
|----------------|------------------|------------------------|-------|------------------|----|------------|--------|
| | | PK | AV | PK | AV | PK | AV |
| 4880 | V | 63.25 | 43.95 | 74 | 54 | -10.75 | -10.05 |
| 7320 | V | 62.95 | 42.65 | 74 | 54 | -11.05 | -11.35 |
| 9760 | V | 61.42 | 41.25 | 74 | 54 | -12.58 | -12.75 |
| 12200 | V | 60.05 | 40.55 | 74 | 54 | -13.95 | -13.45 |
| 14640 | V | 59.42 | 39.52 | 74 | 54 | -14.58 | -14.48 |
| 17080 | V | 58.41 | 38.42 | 74 | 54 | -15.59 | -15.58 |
| 4880 | H | 64.85 | 44.05 | 74 | 54 | -9.15 | -9.95 |
| 7320 | H | 63.95 | 43.95 | 74 | 54 | -10.05 | -10.05 |
| 9760 | H | 62.51 | 42.14 | 74 | 54 | -11.49 | -11.86 |
| 12200 | H | 61.95 | 41.95 | 74 | 54 | -12.05 | -12.05 |
| 14640 | H | 60.25 | 40.28 | 74 | 54 | -13.75 | -13.72 |
| 17080 | H | 59.52 | 39.52 | 74 | 54 | -14.48 | -14.48 |

Other harmonics emissions are lower than 20dB below the allowable limit.

- Note:**
- (1) All Readings are Peak Value and AV.
 - (2) Emission Level= Reading Level+ Probe Factor +Cable Loss.
 - (3) The average measurement was not performed when the peak measured data under the limit of average detection.
 - (4) Measuring frequencies from 1GHz to 25GHz.

Operation Mode: TX Mode (CH39: 2480MHz) Test Date : May 09, 2017
 Frequency Range: 1-25GHz Temperature : 25 °C
 Test Result: PASS Humidity : 50 %
 Measured Distance: 3m Test By: W

| Freq. (MHz) | Ant. Pol. H/V | Emission Level(dBuV/m) | | Limit 3m(dBuV/m) | | Margin(dB) | |
|----------------|------------------|------------------------|-------|------------------|----|------------|--------|
| | | PK | AV | PK | AV | PK | AV |
| 4960 | V | 64.22 | 44.95 | 74 | 54 | -9.78 | -9.05 |
| 7440 | V | 63.95 | 43.65 | 74 | 54 | -10.05 | -10.35 |
| 9920 | V | 62.41 | 42.17 | 74 | 54 | -11.59 | -11.83 |
| 12400 | V | 61.25 | 41.25 | 74 | 54 | -12.75 | -12.75 |
| 14880 | V | 60.95 | 40.36 | 74 | 54 | -13.05 | -13.64 |
| 17360 | V | 59.42 | 39.42 | 74 | 54 | -14.58 | -14.58 |
| 4960 | H | 63.52 | 43.52 | 74 | 54 | -10.48 | -10.48 |
| 7440 | H | 62.14 | 42.14 | 74 | 54 | -11.86 | -11.86 |
| 9920 | H | 61.95 | 41.65 | 74 | 54 | -12.05 | -12.35 |
| 12400 | H | 60.25 | 40.25 | 74 | 54 | -13.75 | -13.75 |
| 14880 | H | 59.42 | 39.51 | 74 | 54 | -14.58 | -14.49 |
| 17360 | H | 58.41 | 38.42 | 74 | 54 | -15.59 | -15.58 |

Other harmonics emissions are lower than 20dB below the allowable limit.

- Note:**
- (1) All Readings are Peak Value and AV.
 - (2) Emission Level= Reading Level+ Probe Factor +Cable Loss.
 - (3) The average measurement was not performed when the peak measured data under the limit of average detection.
 - (4) Measuring frequencies from 1GHz to 25GHz.

5.6 Radiated Measurement Photos:



7. 6dB Bandwidth Measurement

6.1 Measurement Procedure

The EUT was operating in Bluetooth mode or could be controlled its channel. Printed out the test result from the spectrum by hard copy function.

6.2 Test SET-UP (Block Diagram of Configuration)

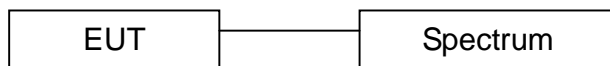

6.3 Measurement Equipment Used:

| EQUIPMENT TYPE | MFR | MODEL NUMBER | SERIAL NUMBER | Characteristics | LAST CAL. | CAL DUE. |
|-------------------|-----------------|--------------|---------------|-----------------|------------|------------|
| Spectrum Analyzer | Rohde & Schwarz | FSV30 | 1321.3008K | 10Hz-30GHz | 05/16/2017 | 05/15/2018 |
| Coaxial Cable | CDS | 79254 | 46107086 | 10Hz-30GHz | 05/16/2017 | 05/15/2018 |
| Antenna Connector | ARTHUR-YANG | 2244-N1TG1 | N/A | 10Hz-30GHz | 05/16/2017 | 05/15/2018 |

Remark: The temporary antenna connector is soldered on the PCB board in order to perform conducted tests and this temporary antenna connector is listed in the equipment list.

6.4 Limit

The minimum 6dB bandwidth shall be at least 500kHz.

6.5 Measurement Results:

Refer to attached data chart.

| | | | |
|--------------------|------|---------------|--------------|
| Spectrum Detector: | PK | Test Date : | May 09, 2017 |
| Test By: | W | Temperature : | 25 °C |
| Test Result: | PASS | Humidity : | 50 % |

| Channel number | Channel frequency (MHz) | Measurement level (KHz) | Required Limit (KHz) |
|----------------|-------------------------|-------------------------|----------------------|
| 00 | 2402 | 660 | >500 |
| 19 | 2440 | 663 | >500 |
| 39 | 2480 | 686 | >500 |

Channel 00:

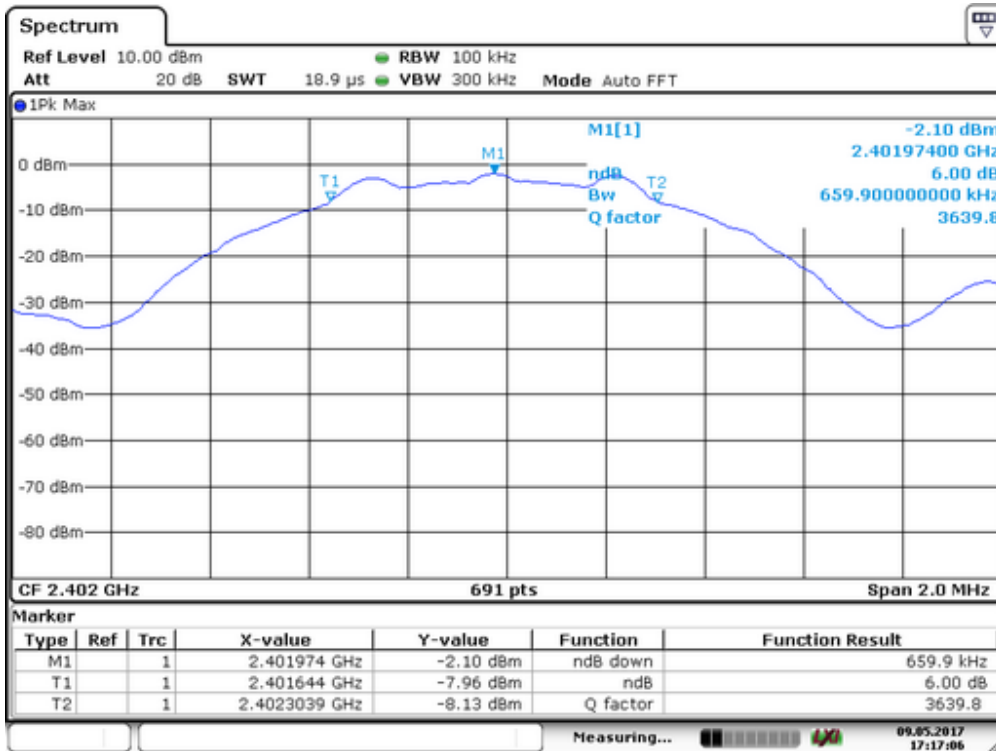

Channel 19:

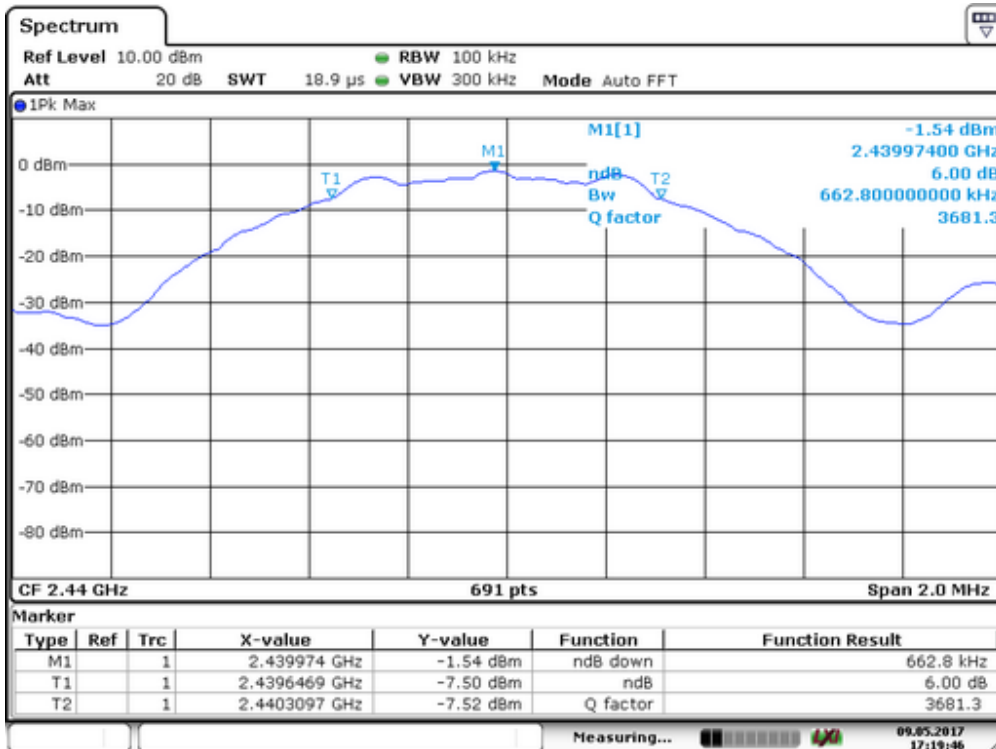

Channel 39:

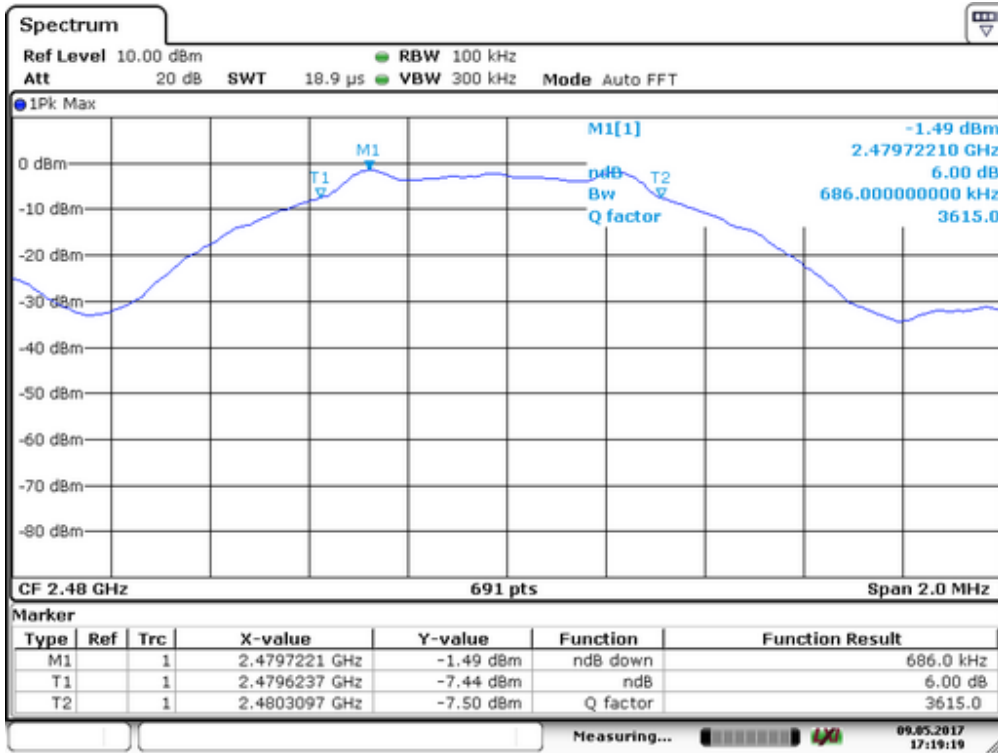

7. MAXIMUM PEAK OUTPUT POWER TEST

7.1 Measurement Procedure

- The Transmitter output (antenna port) was connected to the spectrum Analyzer.
- Turn on the EUT and then record the peak power value.
- Repeat above procedures on all channels needed to be tested.

7.2 Test SET-UP (Block Diagram of Configuration)

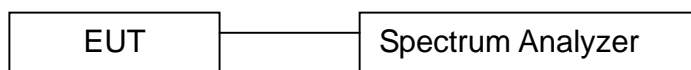

7.3 Measurement Equipment Used:

| EQUIPMENT TYPE | MFR | MODEL NUMBER | SERIAL NUMBER | Characteristics | LAST CAL. | CAL DUE. |
|-------------------|-----------------|--------------|---------------|-----------------|------------|------------|
| Spectrum Analyzer | Rohde & Schwarz | FSV30 | 1321.3008K | 10Hz-30GHz | 05/16/2017 | 05/15/2018 |
| Coaxial Cable | CDS | 79254 | 46107086 | 10Hz-30GHz | 05/16/2017 | 05/15/2018 |
| Antenna Connector | ARTHUR-YANG | 2244-N1TG1 | N/A | 10Hz-30GHz | 05/16/2017 | 05/15/2018 |

Remark: The temporary antenna connector is soldered on the PCB board in order to perform conducted tests and this temporary antenna connector is listed in the equipment list.

7.4 Peak Power output limit

The maximum peak power shall be less 1Watt.

7.5 Measurement Results:

Refer to attached data chart.

| | | | |
|--------------------|------|---------------|--------------|
| Spectrum Detector: | PK | Test Date : | May 09, 2017 |
| Test By: | W | Temperature : | 25 °C |
| Test Result: | PASS | Humidity : | 50 % |

| Channel number | Channel Frequency (MHz) | Peak Power output(dBm) | Peak Power output(mW) | Peak Power Limit(W) | Pass/Fail |
|----------------|-------------------------|------------------------|-----------------------|---------------------|-----------|
| 0 | 2402 | -3.59 | 0.438 | 1W(30dBm) | PASS |
| 19 | 2440 | -1.9 | 0.646 | 1W(30dBm) | PASS |
| 39 | 2480 | -1.44 | 0.718 | 1W(30dBm) | PASS |

Channel 00:

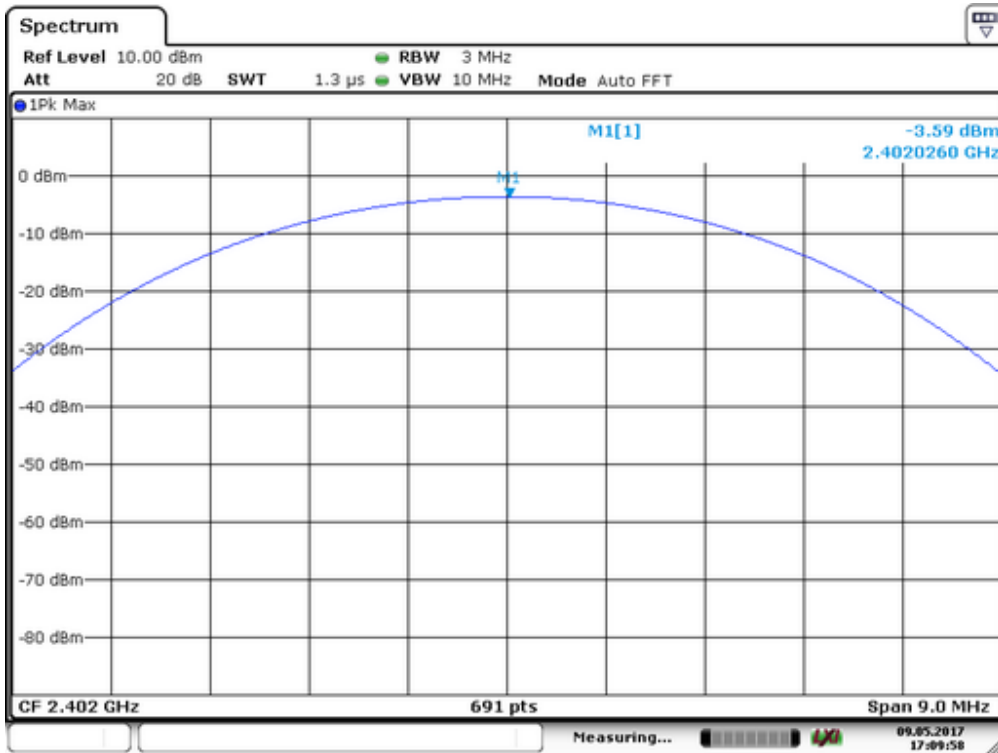

Channel 19:

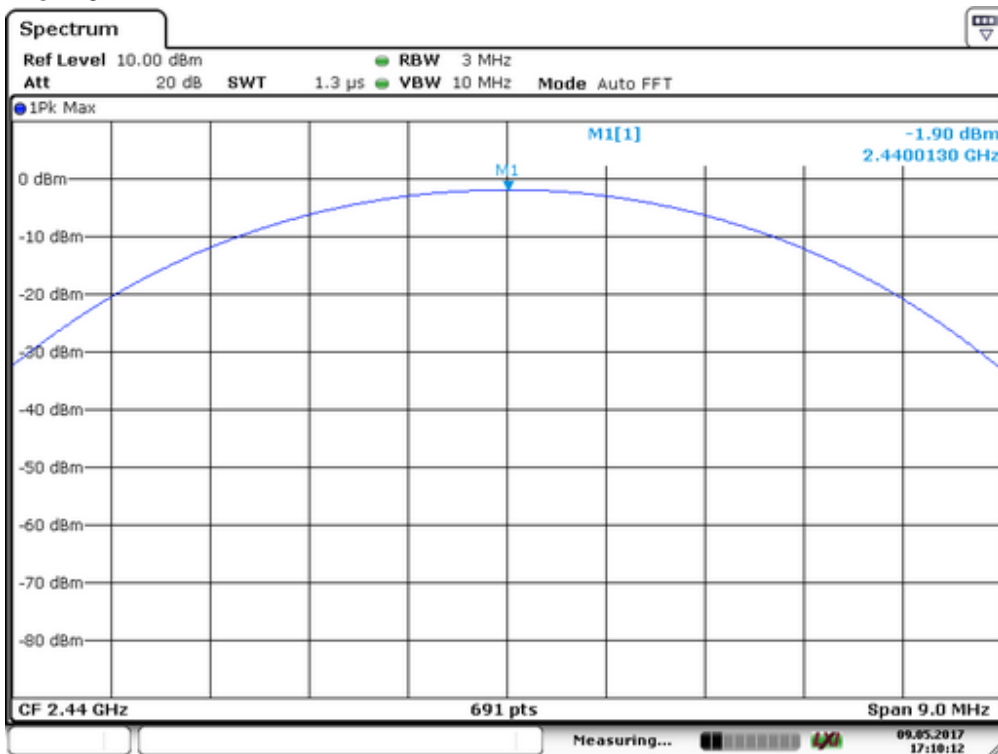

Channel 39:

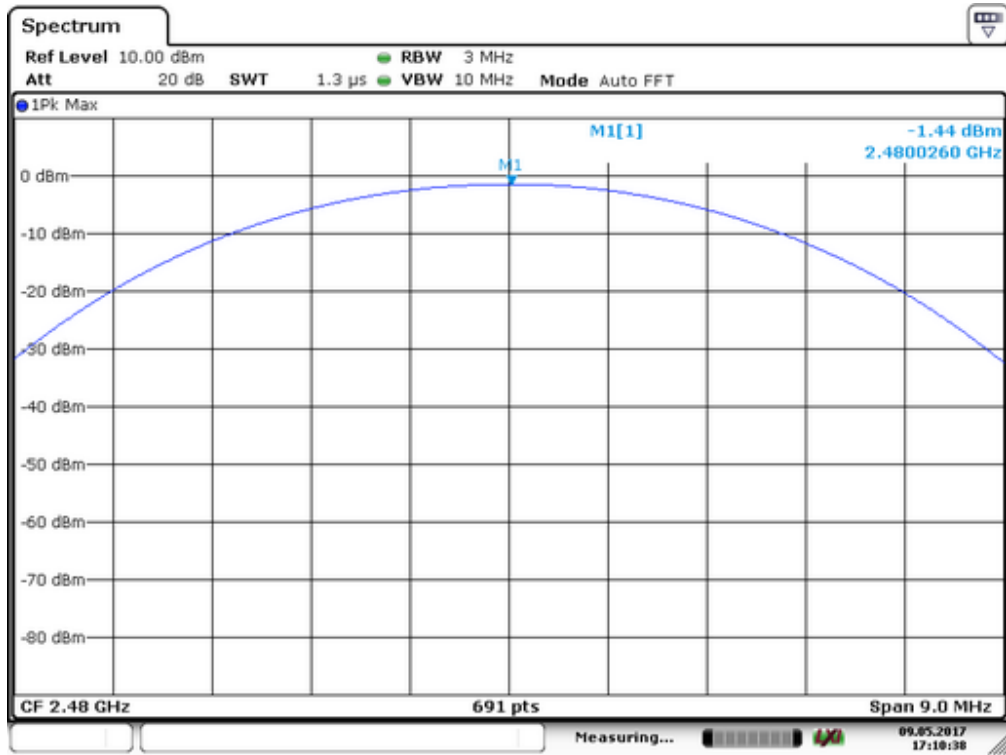

8. Power Spectral Density Measurement

8.1 Measurement Procedure

The EUT was operating in Bluetooth mode or could be controlled its channel. Printed out the test result from the spectrum by hard copy function.

8.2 Test SET-UP (Block Diagram of Configuration)

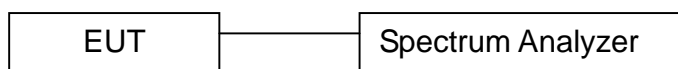

8.3 Measurement Equipment Used:

| EQUIPMENT TYPE | MFR | MODEL NUMBER | SERIAL NUMBER | Characteristics | LAST CAL. | CAL DUE. |
|-------------------|-----------------|--------------|---------------|-----------------|------------|------------|
| Spectrum Analyzer | Rohde & Schwarz | FSV30 | 1321.3008K | 10Hz-30GHz | 05/16/2017 | 05/15/2018 |
| Coaxial Cable | CDS | 79254 | 46107086 | 10Hz-30GHz | 05/16/2017 | 05/15/2018 |
| Antenna Connector | ARTHUR-YANG | 2244-N1TG1 | N/A | 10Hz-30GHz | 05/16/2017 | 05/15/2018 |

Remark: The temporary antenna connector is soldered on the PCB board in order to perform conducted tests and this temporary antenna connector is listed in the equipment list.

8.4 Measurement Procedure

8.4.1 The RF output of EUT was connected to the spectrum analyzer by RF cable and attenuator. The path loss was compensated to the results for each measurement.

8.4.2. Set to the maximum power setting and enable the EUT transmit continuously.

8.4.3. Make the measurement with the spectrum analyzer's resolution bandwidth (RBW) = 3 kHz. Video bandwidth VBW = 10 kHz In order to make an accurate measurement, set the span to 1.5 times DTS Channel Bandwidth. (6dB BW)

8.4.4. Detector = peak, Sweep time = auto couple, Trace mode = max hold, Allow trace to fully stabilize. Use the peak marker function to determine the maximum power level.

8.4.5. Measure and record the results in the test report.

8.4.6. The Measured power density (dBm)/ 100KHz is a reference level and used as 20dBc down limit line for Conducted Band Edges and Conducted Spurious Emission.

8.5 Measurement Results:

The following table is the setting of spectrum analyzer.

| | |
|-------------------|--|
| Spectrum analyzer | Setting |
| Attenuation | Auto |
| Span Frequency | Set the span to 1.5 times the DTS bandwidth. |
| RB | 3KHz |
| VB | 10KHz |
| Detector | Peak |
| Trace | Max hold |
| Sweep Time | Automatic |

Refer to attached data chart.

| | | | |
|--------------------|------|---------------|--------------|
| Spectrum Detector: | PK | Test Date : | May 09, 2017 |
| Test By: | W | Temperature : | 25 °C |
| Test Result: | PASS | Humidity : | 50 % |

| Channel number | Channel frequency (MHz) | Measurement level (dBm) | | Required Limit (dBm/3kHz) | Pass/Fail |
|----------------|-------------------------|-------------------------|----------|---------------------------|-----------|
| | | PSD/100kHz | PSD/3kHz | | |
| 00 | 2402 | -2.49 | -15.21 | 8 | PASS |
| 19 | 2440 | -2.60 | -13.51 | 8 | PASS |
| 39 | 2480 | -1.56 | -13.57 | 8 | PASS |

Note:

1. Measured power density(dBm) has offset with cable loss.
2. The measured power density(dBm)/100KHz is reference level and used as 20dBc down for Conducted Band Edges and Conducted Spurious Emission limit line.

PSD 100kHz Plot:
Channel 00

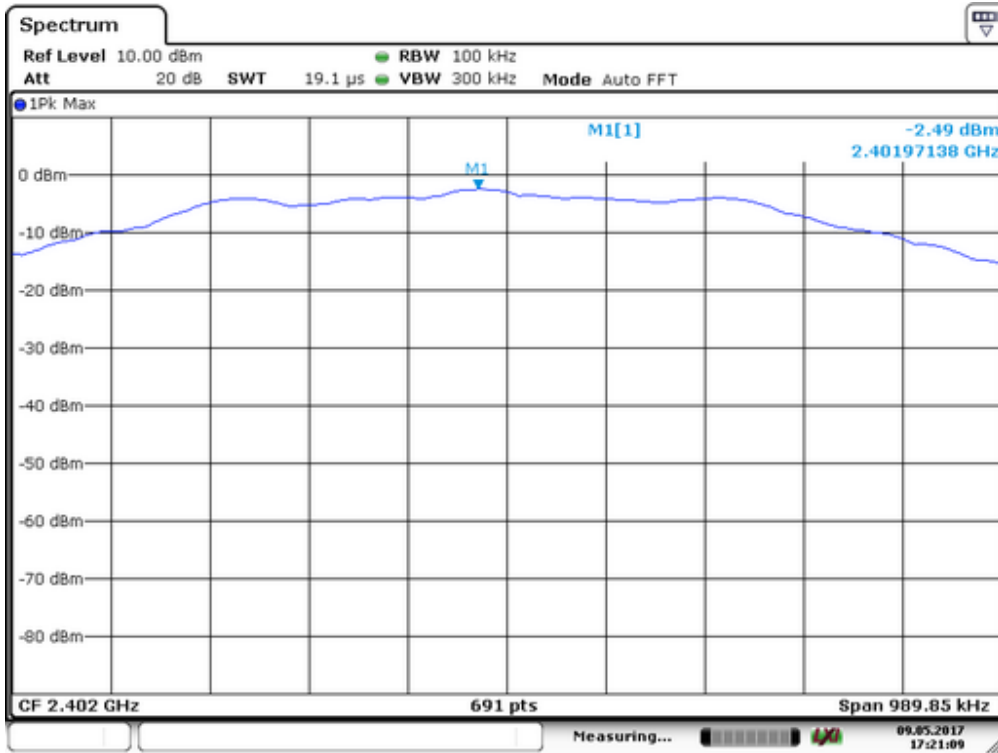

Channel 19

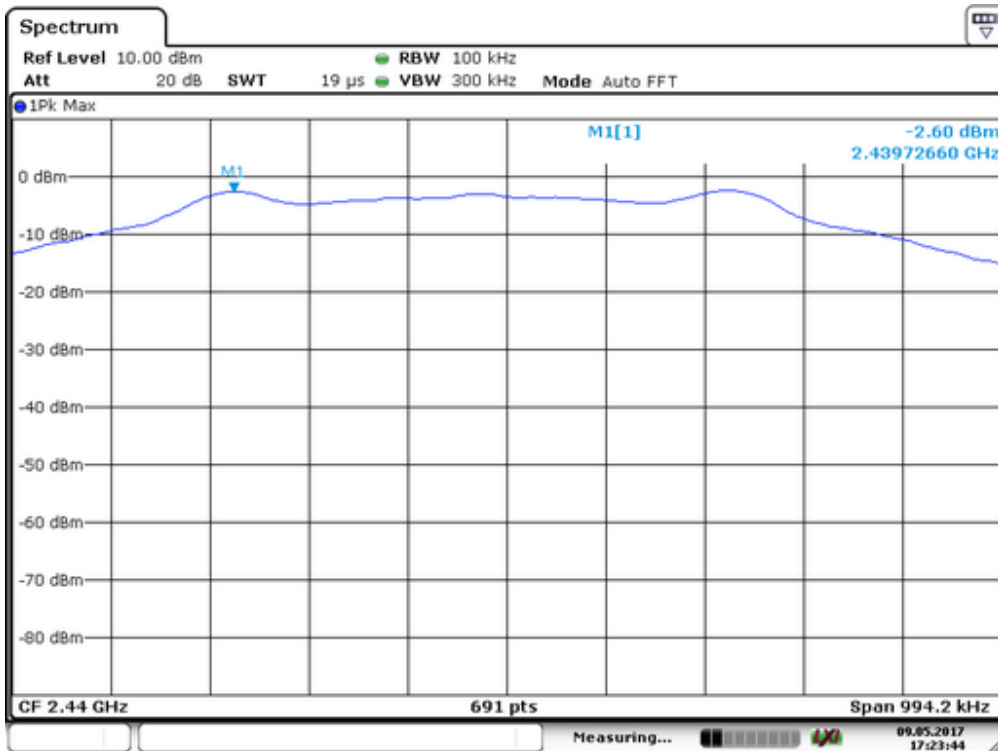

Channel 39

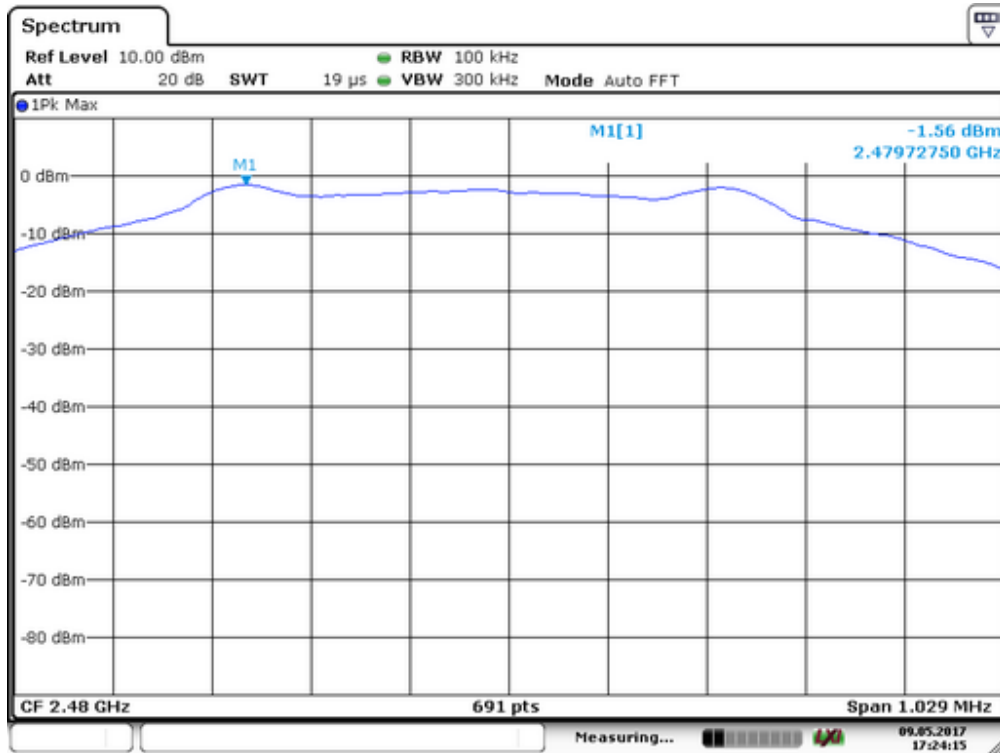

PSD 3KHz Plot:
Channel 00

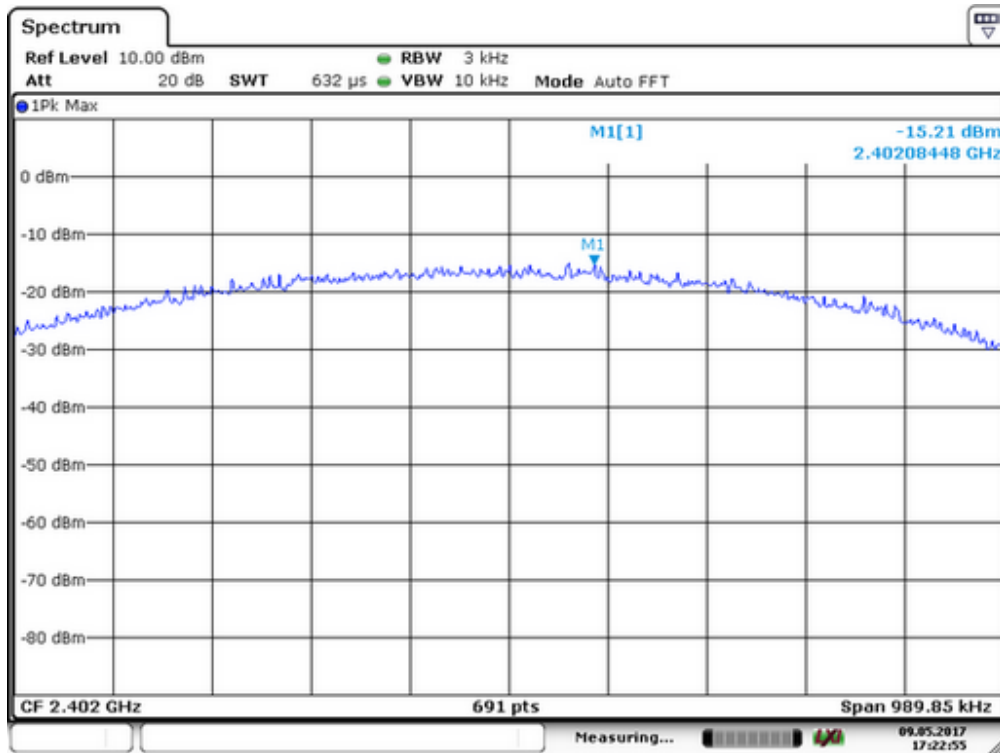

Channel 19

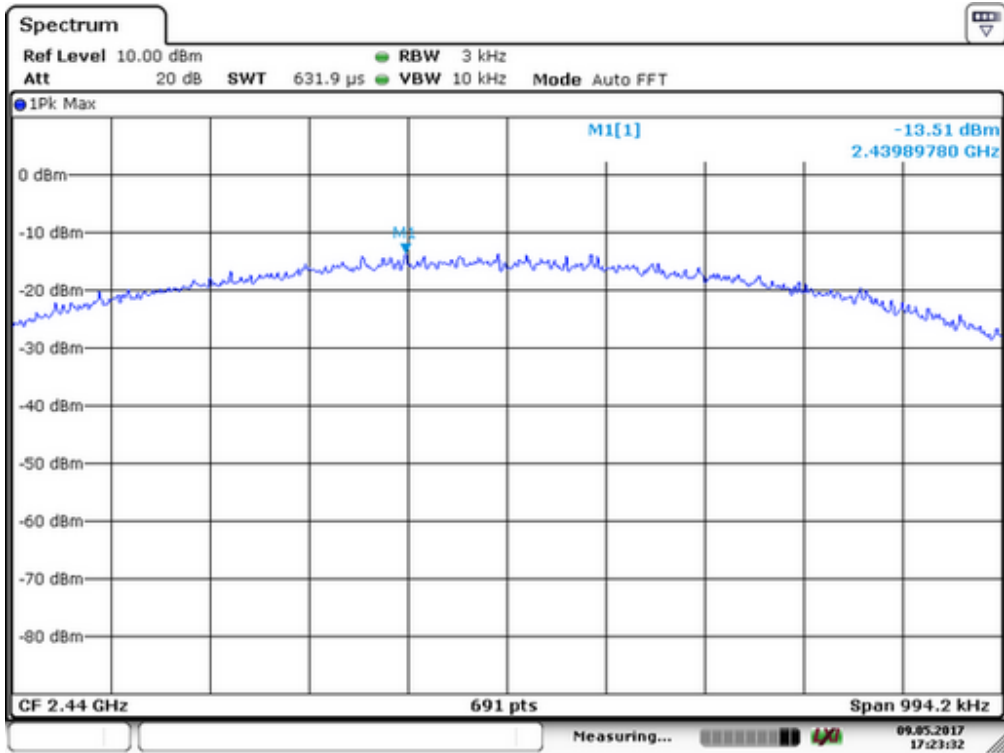

Channel 39

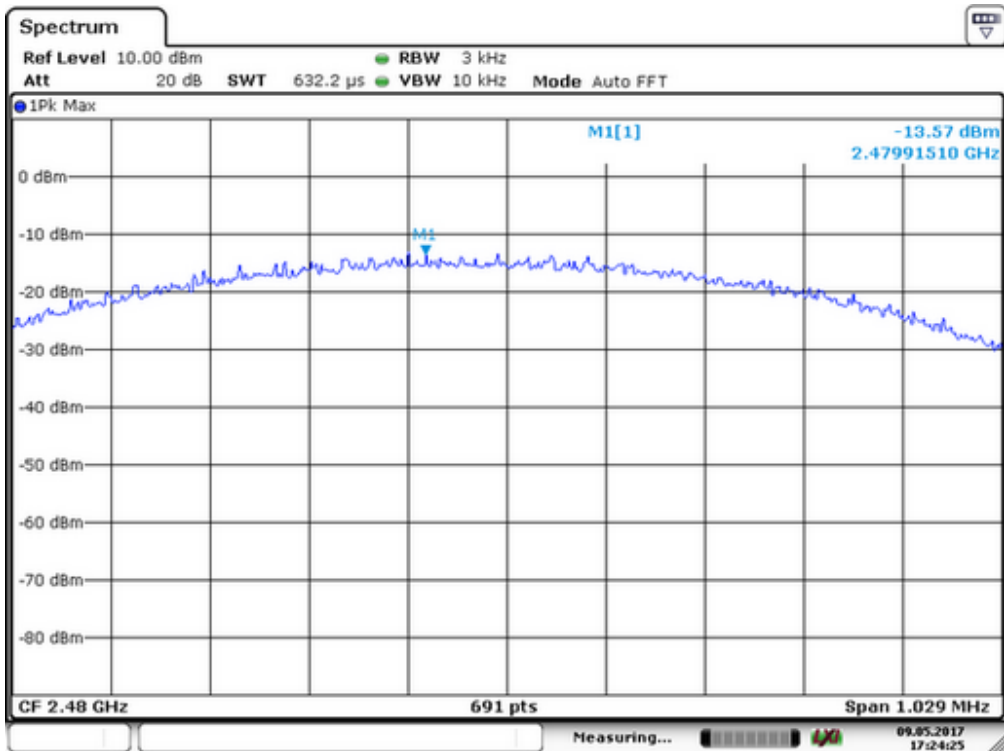

9. Band EDGE test

9.1 Measurement Procedure

For Conducted Test

1. The transmitter output is connected to a spectrum analyzer. The resolution bandwidth is set to 100KHz. The video bandwidth is set to 300KHz.
2. The spectrum from 30MHz to 26 GHz is investigated with the transmitter set to the lowest, middle, and highest channels.

| EMI Test Receiver | Setting |
|-------------------|----------|
| Attenuation | Auto |
| RBW | 100KHz |
| VBW | 300KHz |
| Detector | Peak |
| Trace | Max hold |

For Radiated emission Test

The EUT was placed on a styrofoam table which is 1.5m above ground plane.

The measurement procedure at the band edges was simplified by performing the measurement in just one plot. Both, the in-band-emission and the unwanted emission were encompassed by the span. After trace stabilization, the maximum peak was determined by a peak detector and the value was marked by an appropriate limit line. The second limit line, which is 20dB below the first, marks the limit for the emissions in the unrestricted band. A maximum-peak-detector marks the highest emission in the unrestricted band next to the band edge.

The measurements were performed at the lower end of the 2.4GHz band.

Use the following spectrum analyzer settings:

For Restricted Band, When spectrum scanned above 1GHz setting resolution bandwidth 1MHz, video bandwidth 3MHz:

| EMI Test Receiver | Setting |
|-------------------|----------|
| Attenuation | Auto |
| RBW | 1MHz |
| VBW | 3MHz |
| Detector | Peak |
| Trace | Max hold |

For Non-Restricted Band, When spectrum scanned above 1GHz setting resolution bandwidth 100KHz, video bandwidth 300KHz:

| EMI Test Receiver | Setting |
|-------------------|----------|
| Attenuation | Auto |
| RBW | 100KHz |
| VBW | 300KHz |
| Detector | Peak |
| Trace | Max hold |

9.2 Test SET-UP (Block Diagram of Configuration)

For Conducted Test

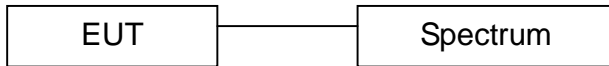

For Radiated emission Test

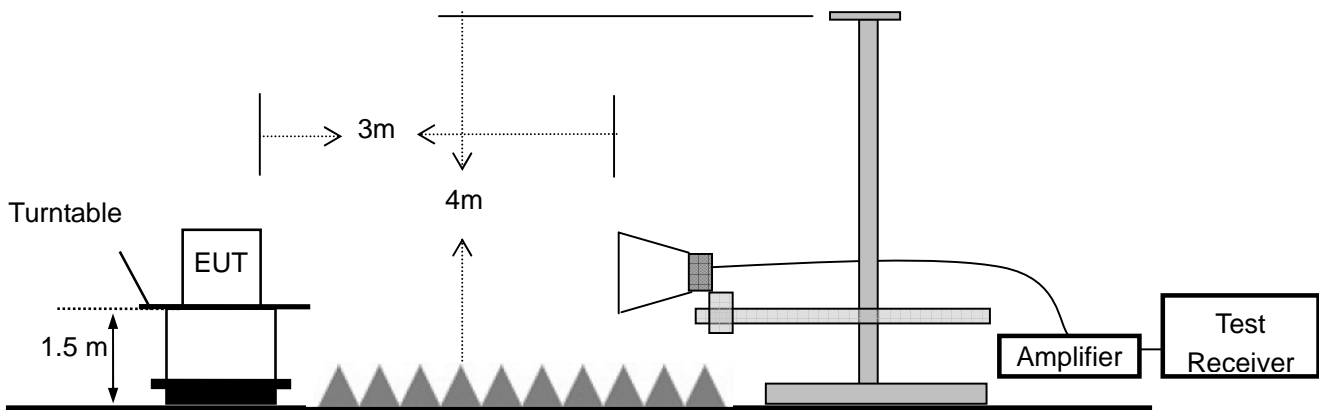

9.3 Measurement Equipment Used:

For Conducted Test

| EQUIPMENT TYPE | MFR | MODEL NUMBER | SERIAL NUMBER | Characteristics | LAST CAL. | CAL DUE. |
|-------------------|-----------------|--------------|---------------|-----------------|------------|------------|
| Spectrum Analyzer | Rohde & Schwarz | FSV30 | 1321.3008K | 10Hz-30GHz | 05/16/2017 | 05/15/2018 |
| Coaxial Cable | CDS | 79254 | 46107086 | 10Hz-30GHz | 05/16/2017 | 05/15/2018 |
| Antenna Connector | ARTHUR-YANG | 2244-N1TG1 | N/A | 10Hz-30GHz | 05/16/2017 | 05/15/2018 |

Remark: The temporary antenna connector is soldered on the PCB board in order to perform conducted tests and this temporary antenna connector is listed in the equipment list.

For Radiated emission Test

| Item | Equipment | Manufacturer | Model No. | Serial No. | Characteristics | Last Cal. | Cal. Interval |
|------|-----------------|-----------------|------------|--------------|-----------------|------------|---------------|
| 1 | Signal Analyzer | Rohde & Schwarz | FSV30 | 103040 | 9KHz-40GHz | 05/16/2017 | 1 Year |
| 2 | Horn Antenna | Schwarzbeck | BBHA9120D | 9120D-1272 | 1GHz-18GHz | 05/16/2017 | 1 Year |
| 3 | Power Amplifier | LUNAR EM | LNA1G18-40 | J10100000081 | 1GHz-26.5GHz | 05/16/2017 | 1 Year |
| 4 | Cable | H+S | CBL-26 | N/A | 1GHz-26.5GHz | 05/16/2017 | 1 Year |
| 5 | Cable | H+S | CBL-26 | N/A | 1GHz-26.5GHz | 05/16/2017 | 1 Year |
| 6 | Cable | H+S | CBL-26 | N/A | 1GHz-26.5GHz | 05/16/2017 | 1 Year |

9.4 Measurement Results:

Refer to attached data chart.

| | | | |
|--------------------|------|---------------|--------------|
| Spectrum Detector: | PK | Test Date : | May 09, 2017 |
| Test By: | W | Temperature : | 25 °C |
| Test Result: | PASS | Humidity : | 50 % |

1. Conducted Test

| Frequency (MHz) | Peak Power Output(dBm) | Emission read Value(dBm) | Result of Band edge(dBc) | Band edge Limit(dBc) |
|-----------------|------------------------|--------------------------|--------------------------|----------------------|
| 2399.24 | -2.41 | -33.4 | 30.99 | >20dBc |
| 2484.76 | -1.04 | -39.9 | 38.86 | >20dBc |

2. Radiated emission Test

| Frequency (MHz) | Antenna polarization (H/V) | Emission (dBuV/m) | | Band edge Limit (dBuV/m) | | Margin (dB) | |
|-----------------|----------------------------|-------------------|-------|--------------------------|----|-------------|--------|
| | | PK | AV | PK | AV | PK | AV |
| 2396.42 | H | 63.02 | 43.06 | 74 | 54 | -10.98 | -10.94 |
| 2390.25 | V | 59.62 | 39.51 | 74 | 54 | -14.38 | -14.49 |
| 2484.65 | H | 64.12 | 44.18 | 74 | 54 | -9.88 | -9.82 |
| 2485 | V | 58.41 | 38.51 | 74 | 54 | -15.59 | -15.49 |

10 Antenna Application

10.1 Antenna requirement

The EUT'S antenna is met the requirement of FCC part 15C section 15.203 and 15.247.

FCC part 15C section 15.247 requirements:

Systems operating in the 2402-2480MHz band that are used exclusively for fixed, point-to-point operations may employ transmitting antennas with directional gain greater than 6dBi provided the maximum peak output power of the intentional radiator is reduced by 1dB for every 3dB that the directional gain of the antenna exceeds 6dBi.

10.2 Result

The EUT's antenna, permanent attached antenna, used a PCB antenna and integrated on PCB, The antenna's gain is 0dBi and meets the requirement.

11 Photos of EUT





