

FCC TEST REPORT (PART 24)

Applicant:	Xiaomi Communications Co., Ltd.
Address:	#019, 9th Floor, Building 6, 33 Xi'erqi Middle Road, Haidian District, Beijing, China, 100085

Manufacturer or Supplier:	Xiaomi Communications Co., Ltd.
Address:	#019, 9th Floor, Building 6, 33 Xi'erqi Middle Road, Haidian District, Beijing, China, 100085
Product:	Mobile Phone
Brand Name:	Redmi
Model Name:	2409BRN2CL
FCC ID:	2AFZZRN2CL
Date of tests:	May. 11, 2024 ~ Jul. 05, 2024

The tests have been carried out according to the requirements of the following standard:

- FCC PART 24, Subpart E**
 FCC PART 2
 ANSI/TIA/EIA-603-D
 ANSI/TIA/EIA-603-E
 ANSI C63.26-2015

CONCLUSION: The submitted sample was found to COMPLY with the test requirement

Prepared by Simon Wang
Engineer / Mobile Department

Approved by Luke Lu
Manager / Mobile Department

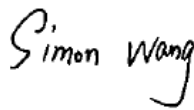

Date: Jul. 05, 2024



Date: Jul. 05, 2024

This report is governed by, and incorporates by reference, the Conditions of Testing as posted at the date of issuance of this report at <http://www.bureauveritas.com/home/about-us/our-business/cps/about-us/terms-conditions/> and is intended for your exclusive use. Any copying or replication of this report to or for any other person or entity, or use of our name or trademark, is permitted only with our prior written permission. This report sets forth our findings solely with respect to the test samples identified herein. The results set forth in this report are not indicative or representative of the quality or characteristics of the lot from which a test sample was taken or any similar or identical product unless specifically and expressly noted. Our report includes all of the tests requested by you and the results thereof based upon the information that you provided to us. Measurement uncertainty is only provided upon request for accredited tests. Statements of conformity are based on simple acceptance criteria without taking measurement uncertainty into account, unless otherwise requested in writing. You have 60 days from date of issuance of this report to notify us of any material error or omission caused by our negligence or if you require measurement uncertainty; provided, however, that such notice shall be in writing and shall specifically address the issue you wish to raise. A failure to raise such issue within the prescribed time shall constitute your unqualified acceptance of the completeness of this report, the tests conducted and the correctness of the report contents.



TABLE OF CONTENTS

RELEASE CONTROL RECORD	4
1 SUMMARY OF TEST RESULTS	5
1.1 MEASUREMENT UNCERTAINTY	6
1.2 TEST SITE AND INSTRUMENTS	7
2 GENERAL INFORMATION	8
2.1 GENERAL DESCRIPTION OF EUT	8
2.2 CONFIGURATION OF SYSTEM UNDER TEST	11
2.3 DESCRIPTION OF SUPPORT UNITS	12
2.4 TEST ITEM AND TEST CONFIGURATION.....	12
2.5 EUT OPERATING CONDITIONS	15
2.6 GENERAL DESCRIPTION OF APPLIED STANDARDS	15
3 TEST TYPES AND RESULTS	16
3.1 OUTPUT POWER MEASUREMENT	16
3.1.1 LIMITS OF OUTPUT POWER MEASUREMENT	16
3.1.2 TEST PROCEDURES	16
3.1.3 TEST SETUP	17
3.1.4 TEST RESULTS	17
3.2 FREQUENCY STABILITY MEASUREMENT	45
3.2.1 LIMITS OF FREQUENCY STABILITY MEASUREMENT	45
3.2.2 TEST PROCEDURE	45
3.2.3 TEST SETUP	45
3.2.4 TEST RESULTS	46
3.3 OCCUPIED BANDWIDTH MEASUREMENT.....	47
3.3.1 LIMITS OF OCCUPIED BANDWIDTH MEASUREMENT	47
3.3.2 TEST SETUP	47
3.3.3 TEST PROCEDURES.....	47
3.3.4 TEST RESULTS	48
3.4 BAND EDGE MEASUREMENTC	49
3.4.1 LIMITS OF BAND EDGE MEASUREMENT	49
3.4.2 TEST SETUP	49
3.4.3 TEST PROCEDURES.....	50
3.4.4. TEST RESULTS	51
3.5 CONDUCTED SPURIOUS EMISSIONS.....	52
3.5.1 LIMITS OF CONDUCTED SPURIOUS EMISSIONS MEASUREMENT	52
3.5.2 TEST PROCEDURE	52
3.5.3 TEST SETUP	52
3.5.4 TEST RESULTS	53
3.6 RADIATED EMISSION MEASUREMENT	54
3.6.1 LIMITS OF RADIATED EMISSION MEASUREMENT	54
3.6.2 TEST PROCEDURES.....	54



**BUREAU
VERITAS**

Test Report No.: W7L-P24050014RF06

3.6.3 DEVIATION FROM TEST STANDARD	54
3.6.4 TEST SETUP	55
3.6.5 TEST RESULTS	57
3.7 PEAK TO AVERAGE RATIO.....	93
3.7.1 LIMITS OF PEAK TO AVERAGE RATIO MEASUREMENT	93
3.7.2 TEST SETUP	93
3.7.3 TEST PROCEDURES	93
3.7.4 TEST RESULTS	94
4 PHOTOGRAPHS OF THE TEST CONFIGURATION.....	95
5 INFORMATION ON THE TESTING LABORATORIES	96
6 MODIFICATIONS RECORDERS FOR ENGINEERING CHANGES TO THE EUT BY THE LAB.....	97
7 APPENDIX	98
GSM 1900	98
WCDMA BAND2	114
LTE BAND 2	126



Test Report No.: W7L-P24050014RF06

RELEASE CONTROL RECORD

ISSUE NO.	REASON FOR CHANGE	DATE ISSUED
W7L-P24050014RF06	Original release	Jul. 05, 2024



1 SUMMARY OF TEST RESULTS

The EUT has been tested according to the following specifications:

APPLIED STANDARD: FCC Part 24 & Part 2		
STANDARD SECTION	TEST TYPE	RESULT
§2.1046	Conducted Output Power	Compliance
§24.232(c)	Equivalent Isotropic Radiated Power	Compliance
§2.1055 §24.235	Frequency Stability	Compliance
§2.1049	Occupied Bandwidth	Compliance
§24.232(d)	Peak to average ratio	Compliance
§24.238(a)(b)	Band Edge Measurements	Compliance
§2.1051 §24.238(a)(b)	Conducted Spurious Emissions	Compliance
§2.1053 §24.238(a)(b)	Radiated Spurious Emissions	Compliance



1.1 MEASUREMENT UNCERTAINTY

Where relevant, the following measurement uncertainty levels have been estimated for tests performed on the EUT as specified in CISPR 16-4-2:

MEASUREMENT	UNCERTAINTY
Frequency Stability	$\pm 76.97\text{Hz}$
Radiated emissions (9KHz~30MHz)	$\pm 2.68\text{dB}$
Radiated emissions & Radiated Power (30MHz~1GHz)	$\pm 4.98\text{dB}$
Radiated emissions & Radiated Power (1GHz ~6GHz)	$\pm 4.70\text{dB}$
Radiated emissions (6GHz ~18GHz)	$\pm 4.60\text{dB}$
Radiated emissions (18GHz ~40GHz)	$\pm 4.12\text{dB}$
Conducted emissions	$\pm 4.01\text{dB}$
Occupied Channel Bandwidth	$\pm 43.58\text{KHz}$
Conducted Output power	$\pm 2.06\text{dB}$
Band Edge Measurements	$\pm 4.70\text{dB}$
Peak to average ratio	$\pm 0.76\text{dB}$

This uncertainty represents an expanded uncertainty expressed at approximately the 95% confidence level using a coverage factor of k=2.



1.2 TEST SITE AND INSTRUMENTS

Equipment	Manufacturer	Model No.	Serial No.	Last Cal.	Next Cal.
MXE EMI Receiver	KEYSIGHT	N9038A-544	MY54450026	Mar. 28,24	Mar. 27,25
EXA Signal Analyzer	KEYSIGHT	N9010A-544	MY54510355	May.10,24	May.09,25
Loop Antenna	Schwarzbeck	FMZB 1519B	00173	Sep.03,23	Sep.02,24
Bilog Antenna	ETS-LINDGRE N	3143B	00161965	Feb. 18,24	Feb. 17,25
Horn Antenna	ETS-LINDGRE N	3117	00168692	Feb. 18,24	Feb. 17,25
Horn Antenna (18GHz-40GHz)	N/A	QWH-SL-18-40-K- SG/QMS-00361	15433	Sep.04, 23	Sep.03, 24
Radio Communication Analyzer	ANRITSU	MT8820C	6201465426	Feb. 14,24	Feb. 13,25
Signal Pre-Amplifier	EMSI	EMC 9135	980249	May. 06,24	May. 05,25
Signal Pre-Amplifier	EMSI	EMC 012645B	980257	May.10,24	May.09,25
Signal Pre-Amplifier	EMSI	EMC 184045B	980259	Feb. 17,24	Feb.16,25
3m Semi-anechoic Chamber	ETS-LINDGRE N	9m*6m*6m	Euroshieldpn- CT0001143-121 6	Nov. 14,23	Nov. 13,26
Test Software	E3	V 9.160323	N/A	N/A	N/A
Test Software	JS1120	3.1.36	N/A	N/A	N/A
10dB Attenuator	JFW/USA	50HF-010-SMA	50HF-010-SMA	May. 06,24	May. 05,25
Power Meter	Anritsu	ML2495A	1506002	Feb. 14,24	Feb. 13,25
Power Sensor	Anritsu	MA2411B	1339352	Feb. 14,24	Feb. 13,25
Temperature Chamber	ESPEC	SH-242	93000855	May. 06,24	May. 05,25
MXG Analog Microwave Signal Generator	KEYSIGHT	N5183A	MY50143024	Feb. 14,24	Feb. 13,25
Base station R&S CMW500	Rohde&Schwa rz	CMW500	153085	May.10,24	May.09,25
DC Source	Kikusui/JP	PMX18-5A	N/A	Aug. 11,23	Aug. 10,24

- NOTE:**
1. The calibration interval of the above test instruments is 12 months or 36 months, and the calibrations are traceable to CEPREI/CHINA, GRGT/CHINA and NIM/CHINA.
 2. The test was performed in 3m Semi-anechoic Chamber and RF Oven Room.
 3. The horn antenna is used only for the measurement of emission frequency above 1GHz if tested.
 4. The FCC Site Registration No. is 525120; The Designation No. is CN1171.



2 GENERAL INFORMATION

2.1 GENERAL DESCRIPTION OF EUT

PRODUCT	Mobile Phone	
BRAND NAME	Redmi	
MODEL NAME	2409BRN2CL	
NOMINAL VOLTAGE	5/3.6~11Vdc(adapter or host equipment) 3.84Vdc (Li-ion, battery)	
MODULATION TYPE	GSM/GPRS: GMSK EDGE: 8PSK WCDMA: BPSK, QPSK LTE Band 2: QPSK, 16QAM, 64QAM	
FREQUENCY RANGE	GSM, EDGE	1850.2MHz ~ 1909.8MHz
	WCDMA	1852.4MHz ~ 1907.6MHz
	LTE Band 2 Channel Bandwidth: 1.4MHz	1850.7MHz ~ 1909.3MHz
	LTE Band 2 Channel Bandwidth: 3MHz	1851.5MHz ~ 1908.5MHz
	LTE Band 2 Channel Bandwidth: 5MHz	1852.5MHz ~ 1907.5MHz
	LTE Band 2 Channel Bandwidth: 10MHz	1855.0MHz ~ 1905.0MHz
	LTE Band 2 Channel Bandwidth: 15MHz	1857.5MHz ~ 1902.5MHz
	LTE Band 2 Channel Bandwidth: 20MHz	1860.0MHz ~ 1900.0MHz
	MAX. EIRP POWER	GSM
EDGE		392.64mW
WCDMA		269.77mW
LTE Band 2 Channel Bandwidth: 1.4MHz		252.93mW
LTE Band 2 Channel Bandwidth: 3MHz		248.31mW
LTE Band 2 Channel Bandwidth: 5MHz		250.03mW
LTE Band 2 Channel Bandwidth: 10MHz		249.46mW
LTE Band 2 Channel Bandwidth: 15MHz		252.35mW



	LTE Band 2 Channel Bandwidth: 20MHz	255.27mW
EMISSION DESIGNATOR	GSM	250KGXW
	EDGE	252KG7W
	WCDMA	4M17F9W
	LTE Band 2 Channel Bandwidth: 1.4MHz	QPSK: 1M10G7D
		16QAM: 1M10W7D
	LTE Band 2 Channel Bandwidth: 3MHz	QPSK: 2M69G7D
		16QAM: 2M69W7D
	LTE Band 2 Channel Bandwidth: 5MHz	QPSK: 4M50G7D
		16QAM: 4M50W7D
	LTE Band 2 Channel Bandwidth: 10MHz	QPSK: 9M01G7D
16QAM: 9M01W7D		
LTE Band 2 Channel Bandwidth: 15MHz	QPSK: 13M5G7D	
	16QAM: 13M5W7D	
LTE Band 2 Channel Bandwidth: 20MHz	QPSK: 18M0G7D	
	16QAM: 18M0W7D	
ANTENNA TYPE	ANT 0(UP): PIFA Antenna with -0.3dBi gain for GSM1900/ WCDMA II/LTE B2 ANT 1(DOWN): PIFA Antenna with -0.5dBi gain for GSM1900/ WCDMA II/LTE B2	
HW VERSION	135100C3N	
SW VERSION	Xiaomi HyperOS 1.0	
IMEI	867957070066520	
I/O PORTS	Refer to user's manual	
CABLE SUPPLIED	USB cable1: non-shielded cable, with w/o ferrite core, 1.0 meter USB cable2: non-shielded cable, with w/o ferrite core, 1.0 meter USB cable3: non-shielded cable, with w/o ferrite core, 1.0 meter USB cable4: non-shielded cable, with w/o ferrite core, 1.0 meter USB cable5: non-shielded cable, with w/o ferrite core, 1.0 meter USB cable6: non-shielded cable, with w/o ferrite core, 1.0 meter USB cable7: non-shielded cable, with w/o ferrite core, 1.0 meter USB cable8: non-shielded cable, with w/o ferrite core, 1.0 meter	
EXTREME TEMPERATURE	0-40 °C	
EXTREME VOLTAGE	3.6V - 4.4V	



**BUREAU
VERITAS**

Test Report No.: W7L-P24050014RF06

NOTE:

1. For a more detailed features description, please refer to the manufacturer's specifications or the user's manual.
2. Physically, the EUT provides two completed transmitter and two receiver.

MODULATION MODE	TX FUNCTION
GSM/GPRS/EDGE	2TX/2RX
WCDMA	2TX/2RX
LTE	2TX/2RX

3. For the test results, the EUT had been tested with all conditions. But only the worst case was shown in the test report.
4. Antenna gain and EUT conducted cable loss are provided by the customer, and the laboratory will record the results based on these items that involve these two parameters.



2.2 CONFIGURATION OF SYSTEM UNDER TEST

FOR RADIATION EMISSION TEST

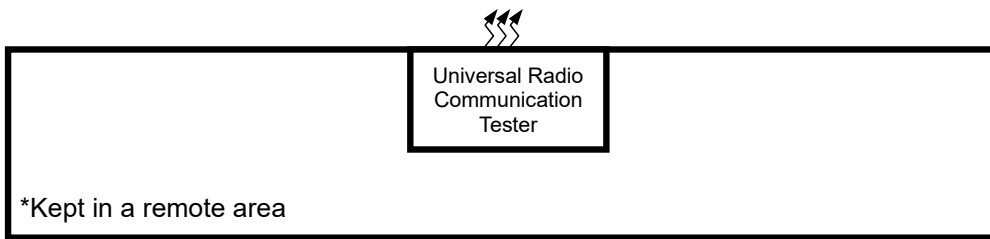
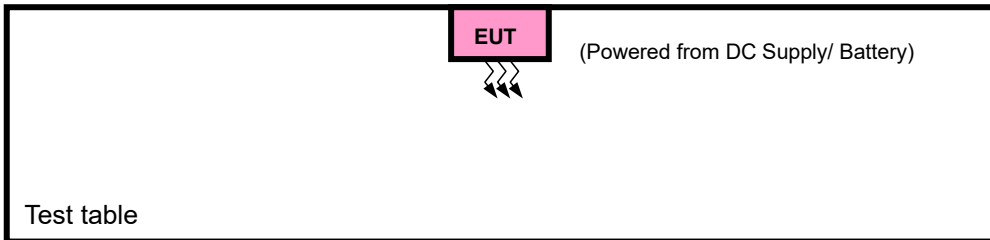
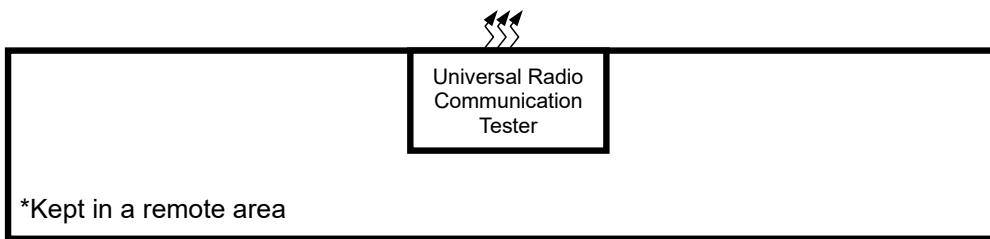
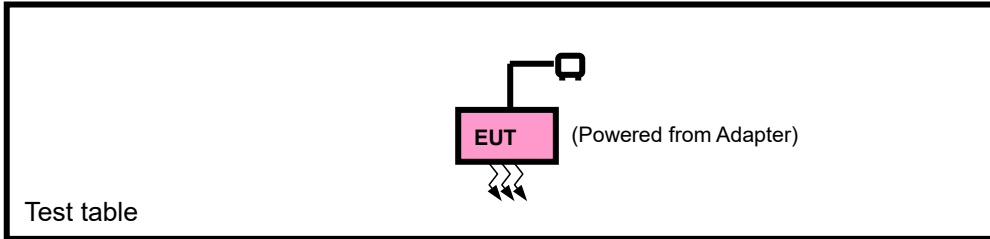



2.3 DESCRIPTION OF SUPPORT UNITS

The EUT has been tested as an independent unit together with other necessary accessories or support units. The following support units or accessories were used to form a representative test configuration during the tests.

NO.	PRODUCT	BRAND	MODEL NO.	SERIAL NO.	FCC ID
1	DC source	Kikusui/JP	PMX18-5A	0000001	N/A

NO.	SIGNAL CABLE DESCRIPTION OF THE ABOVE SUPPORT UNITS
1	DC Line: Unshielded, Detachable 1.0m

2.4 TEST ITEM AND TEST CONFIGURATION

Pre-Scan has been conducted to determine the worst-case mode from all possible combinations between available modulations, data rates, XYZ axis and antenna ports. The worst case in EIRP and radiated emission was found when positioned on X-plane for GSM/EDGE/ WCDMA/ LTE. Following channel(s) was (were) selected for the final test as listed below:

EUT CONFIGURE MODE	DESCRIPTION
A	EUT + Adapter with GSM or WCDMA or LTE link
B	EUT + DC source with GSM or WCDMA or LTE link

GSM MODE

EUT CONFIGURE MODE	TEST ITEM	AVAILABLE CHANNEL	TESTED CHANNEL	MODE
A	EIRP	512 to 810	512, 661, 810	GSM, EDGE
B	FREQUENCY STABILITY	512 to 810	512, 661, 810	GSM, EDGE
A	OCCUPIED BANDWIDTH	512 to 810	512, 661, 810	GSM, EDGE
A	PEAK TO AVERAGE RATIO	512 to 810	512, 661, 810	GSM, EDGE
A	BAND EDGE	512 to 810	512, 810	GSM, EDGE
A	CONDUCTED EMISSION	512 to 810	512, 661, 810	GSM, EDGE
A	RADIATED EMISSION	512 to 810	512, 661, 810	GSM, EDGE



**BUREAU
VERITAS**

Test Report No.: W7L-P24050014RF06

WCDMA

EUT CONFIGURE MODE	TEST ITEM	AVAILABLE CHANNEL	TESTED CHANNEL	MODE
A	EIRP	9262 to 9538	9262, 9400, 9538	WCDMA
B	FREQUENCY STABILITY	9262 to 9538	9262, 9400, 9538	WCDMA
A	OCCUPIED BANDWIDTH	9262 to 9538	9262, 9400, 9538	WCDMA
A	PEAK TO AVERAGE RATIO	9262 to 9538	9262, 9400, 9538	WCDMA
A	BAND EDGE	9262 to 9538	9262, 9538	WCDMA
A	CONDCUDED EMISSION	9262 to 9538	9262, 9400, 9538	WCDMA
A	RADIATED EMISSION	9262 to 9538	9262, 9400, 9538	WCDMA

LTE BAND 2 MODE

EUT CONFIGURE MODE	TEST ITEM	AVAILABLE CHANNEL	TESTED CHANNEL	CHANNEL BANDWIDTH	MODULATION	MODE
A	EIRP	18607 to 19193	18607, 18900, 19193	1.4MHz	QPSK,16QAM, 64QAM	1 RB / 0 RB Offset
		18615 to 19185	18615, 18900, 19185	3MHz	QPSK,16QAM, 64QAM	1 RB / 0 RB Offset
		18625 to 19175	18625, 18900, 19175	5MHz	QPSK,16QAM, 64QAM	1 RB / 0 RB Offset
		18650 to 19150	18650, 18900, 19150	10MHz	QPSK,16QAM, 64QAM	1 RB / 0 RB Offset
		18675 to 19125	18675, 18900, 19125	15MHz	QPSK,16QAM, 64QAM	1 RB / 0 RB Offset
		18700 to 19100	18700, 18900, 19100	20MHz	QPSK,16QAM, 64QAM	1 RB / 0 RB Offset
B	FREQUENCY STABILITY	18700 to 19100	18700, 18900, 19100	20MHz	QPSK	100 RB / 0 RB Offset
A	OCCUPIED BANDWIDTH	18607 to 19193	18607, 18900, 19193	1.4MHz	QPSK,16QAM	6 RB / 0 RB Offset
		18615 to 19185	18615, 18900, 19185	3MHz	QPSK,16QAM	15 RB / 0 RB Offset
		18625 to 19175	18625, 18900, 19175	5MHz	QPSK,16QAM	25 RB / 0 RB Offset
		18650 to 19150	18650, 18900, 19150	10MHz	QPSK,16QAM	50 RB / 0 RB Offset
		18675 to 19125	18675, 18900, 19125	15MHz	QPSK,16QAM	75 RB / 0 RB Offset
		18700 to 19100	18700, 18900, 19100	20MHz	QPSK,16QAM	100 RB / 0 RB Offset
A	PEAK TO AVERAGE RATIO	18700 to 19100	18700, 18900, 19100	20MHz	c	1 RB / 0 RB Offset 100 RB / 0 RB Offset



BUREAU
VERITAS

Test Report No.: W7L-P24050014RF06

A	BAND EDGE	18607 to 19193	18607	1.4MHz	QPSK, 16QAM	1 RB / 0 RB Offset
			19193	1.4MHz	QPSK, 16QAM	6 RB / 0 RB Offset
		18615 to 19185	18615	3MHz	QPSK, 16QAM	1 RB / 5 RB Offset
			19185	3MHz	QPSK, 16QAM	6 RB / 0 RB Offset
		18625 to 19175	18625	5MHz	QPSK, 16QAM	1 RB / 0 RB Offset
			19175	5MHz	QPSK, 16QAM	15 RB / 0 RB Offset
		18650 to 19150	18625	5MHz	QPSK, 16QAM	1 RB / 14 RB Offset
			19175	5MHz	QPSK, 16QAM	15 RB / 0 RB Offset
		18675 to 19125	18625	5MHz	QPSK, 16QAM	1 RB / 0 RB Offset
			19175	5MHz	QPSK, 16QAM	25 RB / 0 RB Offset
		18700 to 19100	18650	10MHz	QPSK, 16QAM	1 RB / 24 RB Offset
			19150	10MHz	QPSK, 16QAM	25 RB / 0 RB Offset
		18675 to 19125	18650	10MHz	QPSK, 16QAM	1 RB / 0 RB Offset
			19150	10MHz	QPSK, 16QAM	50 RB / 0 RB Offset
		18700 to 19100	18675	15MHz	QPSK, 16QAM	1 RB / 49 RB Offset
			19125	15MHz	QPSK, 16QAM	50 RB / 0 RB Offset
18700 to 19100	18675	15MHz	QPSK, 16QAM	1 RB / 0 RB Offset		
	19125	15MHz	QPSK, 16QAM	75 RB / 0 RB Offset		
18700 to 19100	18700	20MHz	QPSK, 16QAM	1 RB / 74 RB Offset		
	19100	20MHz	QPSK, 16QAM	75 RB / 0 RB Offset		
A	CONDCUDETED EMISSION	18607 to 19193	18607, 18900, 19193	1.4MHz	QPSK	1 RB / 0 RB Offset
		18615 to 19185	18615, 18900, 19185	3MHz	QPSK	1 RB / 0 RB Offset
		18625 to 19175	18625, 18900, 19175	5MHz	QPSK	1 RB / 0 RB Offset
		18650 to 19150	18650, 18900, 19150	10MHz	QPSK	1 RB / 0 RB Offset
		18675 to 19125	18675, 18900, 19125	15MHz	QPSK	1 RB / 0 RB Offset
		18700 to 19100	18700, 18900, 19100	20MHz	QPSK	1 RB / 0 RB Offset
A	RADIATED EMISSION	18607 to 19193	18900	1.4MHz	QPSK	1 RB / 0 RB Offset
		18615 to 19185	18900	3MHz	QPSK	1 RB / 0 RB Offset
		18625 to 19175	18900	5MHz	QPSK	1 RB / 0 RB Offset
		18650 to 19150	18650, 18900, 19150	10MHz	QPSK	1 RB / 0 RB Offset
		18675 to 19125	18900	15MHz	QPSK	1 RB / 0 RB Offset
		18700 to 19100	18900	20MHz	QPSK	1 RB / 0 RB Offset

Note: This device was tested under all bandwidths, RB configurations and modulations. The worst case was found in QPSK modulation.



TEST CONDITION:

TEST ITEM	ENVIRONMENTAL CONDITIONS	INPUT POWER	TESTED BY
EIRP	25deg. C, 57%RH	DC 5/3.6~11V By Adapter	Jace Hu
FREQUENCY STABILITY	25deg. C, 57%RH	DC 3.6/3.84/4.4 By DC Source	James Fu
OCCUPIED BANDWIDTH	23deg. C, 61%RH	DC 5/3.6~11V By Adapter	James Fu
PEAK TO AVERAGE RATIO	23deg. C, 61%RH	DC 5/3.6~11V By Adapter	James Fu
BAND EDGE	23deg. C, 61%RH	DC 5/3.6~11V By Adapter	James Fu
CONDCUDED EMISSION	23deg. C, 61%RH	DC 5/3.6~11V By Adapter	James Fu
RADIATED EMISSION	23deg. C, 70%RH	DC 5/3.6~11V By Adapter	Jace Hu

2.5 EUT OPERATING CONDITIONS

The EUT makes a call to the communication simulator. The communication simulator station system controlled an EUT to export maximum output power under transmission mode and specific channel frequency.

2.6 GENERAL DESCRIPTION OF APPLIED STANDARDS

The EUT is an RF product. According to the specifications of the manufacturer, it must comply with the requirements of the following standards:

FCC 47 CFR Part 2

FCC 47 CFR Part 24

KDB 971168 D01 Power Meas License Digital Systems v03r01

ANSI/TIA/EIA-603-D

ANSI/TIA/EIA-603-E

ANSI C63.26-2015

NOTE: All test items have been performed and recorded as per the above standards.



3 TEST TYPES AND RESULTS

3.1 OUTPUT POWER MEASUREMENT

3.1.1 LIMITS OF OUTPUT POWER MEASUREMENT

Mobile and portable stations are limited to 2 watts EIRP.

3.1.2 TEST PROCEDURES

EIRP MEASUREMENT:

Per KDB 971168 D01 Power Meas License Digital Systems v03r01 or subclause 5.2.5.5 of ANSI C63.26-2015, the relevant equation for determining the ERP or EIRP from the conducted RF output power measured using the guidance provided above is:

$$\text{ERP or EIRP} = P_{\text{Meas}} + G_{\text{T}} - L_{\text{C}}$$

Where:

ERP or EIRP = effective radiated power or equivalent isotopically radiated power, respectively

(expressed in the same units as P_{Meas} , typically dBW or dBm);

P_{Meas} = measured transmitter output power or PSD, in dBm or dBW;

G_{T} = gain of the transmitting antenna, in dBd (ERP) or dBi (EIRP);

L_{C} = signal attenuation in the connecting cable between the transmitter and antenna, in dB.

CONDUCTED POWER MEASUREMENT:

The EUT was set up for the maximum power with WCDMA link data modulation and link up with simulator. Set the EUT to transmit under low, middle and high channel and record the power level shown on simulator.



3.1.3 TEST SETUP

EIRP / ERP Measurement:

CONDUCTED POWER MEASUREMENT:

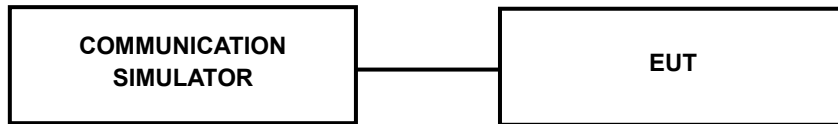

3.1.4 TEST RESULTS

CONDUCTED OUTPUT POWER (dBm)

Ant 0(UP):

Band	GSM1900		
Channel	512	661	810
Frequency (MHz)	1850.2	1880	1909.8
GSM	29.26	29.25	29.34
GPRS (GMSK, 1Tx-slot)	29.27	29.24	29.33
GPRS (GMSK, 2Tx-slot)	25.66	25.71	25.93
GPRS (GMSK, 3Tx-slot)	23.83	23.94	24.17
GPRS (GMSK, 4Tx-slot)	22.84	22.99	23.23
EDGE (8PSK, 1Tx-slot)	26.08	26.06	26.24
EDGE (8PSK, 2Tx-slot)	22.91	22.94	23.22
EDGE (8PSK, 3Tx-slot)	21.07	21.10	21.30
EDGE (8PSK, 4Tx-slot)	19.91	19.96	20.11

Band	WCDMA II		
Channel	9262	9400	9538
Frequency (MHz)	1852.4	1880	1907.6
RMC 12.2K	24.57	24.61	24.60
HSDPA Subtest-1	23.76	23.77	23.71
HSDPA Subtest-2	23.75	23.76	23.72
HSDPA Subtest-3	23.25	23.29	23.23
HSDPA Subtest-4	23.21	23.27	23.30
DC-HSDPA Subtest-1	23.69	23.79	23.76
DC-HSDPA Subtest-2	23.76	23.79	23.72
DC-HSDPA Subtest-3	23.22	23.29	23.28
DC-HSDPA Subtest-4	23.19	23.30	23.19
HSUPA Subtest-1	21.88	21.92	21.94
HSUPA Subtest-2	21.59	21.69	21.67
HSUPA Subtest-3	22.57	22.52	22.54
HSUPA Subtest-4	21.24	21.31	21.27
HSUPA Subtest-5	22.54	22.55	22.59
HSPA+ Subtest-1	21.80	21.87	21.84



**BUREAU
VERITAS**

Test Report No.: W7L-P24050014RF06

LTE BAND 2

Band/BW	Modulation	RB Size	RB Offset	Low CH 18607	Mid CH 18900	High CH 19193
				Frequency 1850.7 MHz	Frequency 1880 MHz	Frequency 1909.3 MHz
2/ 1.4	QPSK	1	0	24.03	23.92	23.76
		1	2	24.33	24.21	24.24
		1	5	23.88	23.82	23.86
		3	0	23.88	24.00	24.02
		3	1	24.06	23.99	24.05
		3	3	23.96	23.98	23.81
		6	0	23.18	23.13	23.09
	16QAM	1	0	23.24	23.28	23.03
		1	2	23.43	23.48	23.38
		1	5	23.06	23.17	23.08
		3	0	22.99	23.14	23.04
		3	1	23.06	23.11	23.04
		3	3	22.95	23.07	22.82
		6	0	22.13	22.24	22.01
	64QAM	1	0	22.57	22.30	22.15
		1	2	22.80	22.59	22.33
		1	5	22.36	22.21	22.13
		3	0	21.90	22.01	22.05
		3	1	21.97	22.07	22.01
		3	3	21.87	22.03	21.71
		6	0	21.08	21.16	21.11



**BUREAU
VERITAS**

Test Report No.: W7L-P24050014RF06

Band/BW	Modulation	RB Size	RB Offset	Low CH 18615	Mid CH 18900	High CH 19185
				Frequency 1851.5 MHz	Frequency 1880 MHz	Frequency 1908.5 MHz
2 / 3	QPSK	1	0	24.04	23.93	23.82
		1	7	24.25	24.16	24.22
		1	14	23.94	23.83	23.84
		8	0	23.14	23.17	23.14
		8	3	23.25	23.15	23.17
		8	7	23.10	23.11	23.01
		15	0	23.15	23.17	23.11
	16QAM	1	0	23.23	23.16	23.13
		1	7	23.50	23.56	23.39
		1	14	23.18	23.28	23.00
		8	0	22.22	22.34	22.17
		8	3	22.17	22.22	22.23
		8	7	22.07	22.32	22.02
		15	0	22.15	22.18	22.02
	64QAM	1	0	22.56	22.23	22.14
		1	7	22.83	22.59	22.41
		1	14	22.37	22.27	22.09
		8	0	21.16	21.15	21.18
		8	3	21.21	21.12	21.16
		8	7	21.06	21.28	20.95
		15	0	21.15	21.21	21.11



**BUREAU
VERITAS**

Test Report No.: W7L-P24050014RF06

Band/BW	Modulation	RB Size	RB Offset	Low CH 18625	Mid CH 18900	High CH 19175
				Frequency 1852.5 MHz	Frequency 1880 MHz	Frequency 1907.5 MHz
2 / 5	QPSK	1	0	24.02	23.86	23.83
		1	12	24.28	24.19	24.23
		1	24	23.96	23.81	23.83
		12	0	23.07	23.12	23.14
		12	6	23.25	23.11	23.25
		12	13	23.10	23.20	22.93
		25	0	23.17	23.13	23.07
	16QAM	1	0	23.24	23.28	23.04
		1	12	23.53	23.58	23.37
		1	24	23.17	23.17	23.01
		12	0	22.15	22.25	22.21
		12	6	22.20	22.25	22.17
		12	13	22.18	22.26	21.95
		25	0	22.16	22.19	22.12
	64QAM	1	0	22.63	22.28	22.21
		1	12	22.88	22.55	22.33
		1	24	22.50	22.32	22.02
		12	0	21.09	21.15	21.18
		12	6	21.15	21.12	21.19
		12	13	21.19	21.28	20.97
		25	0	21.08	21.26	21.10



**BUREAU
VERITAS**

Test Report No.: W7L-P24050014RF06

Band/BW	Modulation	RB Size	RB Offset	Low CH 18650	Mid CH 18900	High CH 19150
				Frequency 1855 MHz	Frequency 1880 MHz	Frequency 1905 MHz
2/ 10	QPSK	1	0	24.07	23.97	23.85
		1	24	24.27	24.22	24.16
		1	49	23.93	23.81	23.85
		25	0	23.08	23.24	23.19
		25	12	23.20	23.19	23.28
		25	25	23.05	23.22	22.97
		50	0	23.10	23.17	23.15
	16QAM	1	0	23.18	23.23	23.05
		1	24	23.54	23.57	23.34
		1	49	23.15	23.15	23.03
		25	0	22.18	22.32	22.12
		25	12	22.23	22.19	22.24
		25	25	22.08	22.29	22.06
		50	0	22.16	22.28	22.00
	64QAM	1	0	22.51	22.31	22.16
		1	24	22.83	22.58	22.37
		1	49	22.37	22.23	22.14
		25	0	21.16	21.18	21.09
		25	12	21.26	21.25	21.15
		25	25	21.07	21.32	20.98
		50	0	21.17	21.17	21.10



Band/BW	Modulation	RB Size	RB Offset	Low CH 18675	Mid CH 18900	High CH 19125
				Frequency 1857.5 MHz	Frequency 1880 MHz	Frequency 1902.5 MHz
2/ 15	QPSK	1	0	23.99	23.87	23.75
		1	37	24.32	24.26	24.24
		1	74	23.96	23.84	23.78
		36	0	23.13	23.22	23.19
		36	19	23.12	23.15	23.20
		36	39	23.07	23.14	22.98
		75	0	23.18	23.21	23.11
	16QAM	1	0	23.16	23.25	23.03
		1	37	23.52	23.50	23.37
		1	74	23.07	23.17	23.07
		36	0	22.12	22.21	22.12
		36	19	22.27	22.31	22.21
		36	39	22.06	22.23	22.05
		75	0	22.18	22.17	22.05
	64QAM	1	0	22.58	22.34	22.14
		1	37	22.85	22.61	22.37
		1	74	22.48	22.19	22.04
		36	0	21.22	21.24	21.10
		36	19	21.18	21.18	21.14
		36	39	21.11	21.21	21.01
		75	0	21.13	21.16	21.03



Band/BW	Modulation	RB Size	RB Offset	Low CH 18700	Mid CH 18900	High CH 19100
				Frequency 1860 MHz	Frequency 1880 MHz	Frequency 1900 MHz
2/ 20	QPSK	1	0	24.10	23.98	23.86
		1	50	24.37	24.27	24.25
		1	99	24.00	23.93	23.87
		50	0	23.20	23.21	23.24
		50	25	23.27	23.25	23.30
		50	50	23.17	23.26	23.07
		100	0	23.22	23.21	23.18
	16QAM	1	0	23.29	23.30	23.18
		1	50	23.58	23.61	23.44
		1	99	23.21	23.29	23.11
		50	0	22.25	22.36	22.26
		50	25	22.30	22.33	22.28
		50	50	22.19	22.38	22.09
		100	0	22.24	22.31	22.15
	64QAM	1	0	22.65	22.36	22.22
		1	50	22.93	22.63	22.47
		1	99	22.51	22.33	22.16
		50	0	21.23	21.28	21.24
		50	25	21.29	21.27	21.25
		50	50	21.20	21.33	21.04
		100	0	21.19	21.30	21.14



Ant 1(DOWN):

Band	GSM1900		
Channel	512	661	810
Frequency (MHz)	1850.2	1880	1909.8
GSM	29.41	29.42	29.31
GPRS (GMSK, 1Tx-slot)	29.36	29.40	29.30
GPRS (GMSK, 2Tx-slot)	25.75	25.89	25.96
GPRS (GMSK, 3Tx-slot)	23.92	24.10	24.22
GPRS (GMSK, 4Tx-slot)	22.95	23.13	23.28
EDGE (8PSK, 1Tx-slot)	25.83	26.08	26.11
EDGE (8PSK, 2Tx-slot)	22.81	22.98	23.14
EDGE (8PSK, 3Tx-slot)	20.96	21.23	21.37
EDGE (8PSK, 4Tx-slot)	19.99	20.04	20.20

Band	WCDMA II		
Channel	9262	9400	9538
Frequency (MHz)	1852.4	1880	1907.6
RMC 12.2K	24.42	24.45	24.35
HSDPA Subtest-1	23.59	23.60	23.46
HSDPA Subtest-2	23.59	23.60	23.49
HSDPA Subtest-3	23.05	23.10	22.98
HSDPA Subtest-4	23.12	23.07	23.04
DC-HSDPA Subtest-1	23.54	23.59	23.49
DC-HSDPA Subtest-2	23.54	23.57	23.47
DC-HSDPA Subtest-3	23.04	23.14	22.97
DC-HSDPA Subtest-4	23.07	23.12	23.01
HSUPA Subtest-1	21.74	21.75	21.72
HSUPA Subtest-2	21.50	21.47	21.41
HSUPA Subtest-3	22.33	22.37	22.26
HSUPA Subtest-4	21.12	21.07	21.01
HSUPA Subtest-5	22.36	22.36	22.29
HSPA+ Subtest-1	21.65	21.69	21.54



**BUREAU
VERITAS**

Test Report No.: W7L-P24050014RF06

LTE BAND 2

Band/BW	Modulation	RB Size	RB Offset	Low CH 18607	Mid CH 18900	High CH 19193
				Frequency 1850.7 MHz	Frequency 1880 MHz	Frequency 1909.3 MHz
2/ 1.4	QPSK	1	0	24.07	24.04	24.10
		1	2	24.36	24.40	24.46
		1	5	24.04	23.98	24.10
		3	0	24.24	24.23	24.35
		3	1	24.29	24.23	24.24
		3	3	24.21	24.30	24.18
		6	0	23.38	23.33	23.50
	16QAM	1	0	23.51	23.32	23.29
		1	2	23.86	23.64	23.60
		1	5	23.39	23.32	23.23
		3	0	23.22	23.27	23.35
		3	1	23.31	23.23	23.32
		3	3	23.27	23.42	23.08
		6	0	22.42	22.48	22.44
	64QAM	1	0	22.43	22.26	22.27
		1	2	22.70	22.63	22.53
		1	5	22.35	22.22	22.31
		3	0	22.21	22.31	22.29
		3	1	22.31	22.21	22.29
		3	3	22.17	22.32	22.05
		6	0	21.40	21.50	21.39



Band/BW	Modulation	RB Size	RB Offset	Low CH 18615	Mid CH 18900	High CH 19185
				Frequency 1851.5 MHz	Frequency 1880 MHz	Frequency 1908.5 MHz
2 / 3	QPSK	1	0	24.04	24.05	24.10
		1	7	24.35	24.29	24.43
		1	14	24.09	24.04	24.02
		8	0	23.43	23.47	23.50
		8	3	23.48	23.46	23.51
		8	7	23.40	23.51	23.35
		15	0	23.46	23.50	23.41
	16QAM	1	0	23.41	23.33	23.32
		1	7	23.73	23.71	23.55
		1	14	23.37	23.38	23.24
		8	0	22.51	22.39	22.52
		8	3	22.62	22.55	22.48
		8	7	22.34	22.64	22.25
		15	0	22.42	22.45	22.43
	64QAM	1	0	22.42	22.30	22.29
		1	7	22.68	22.72	22.57
		1	14	22.31	22.24	22.43
		8	0	21.40	21.48	21.43
		8	3	21.42	21.50	21.49
		8	7	21.41	21.52	21.23
		15	0	21.42	21.42	21.41



**BUREAU
VERITAS**

Test Report No.: W7L-P24050014RF06

Band/BW	Modulation	RB Size	RB Offset	Low CH 18625	Mid CH 18900	High CH 19175
				Frequency 1852.5 MHz	Frequency 1880 MHz	Frequency 1907.5 MHz
2 / 5	QPSK	1	0	24.17	24.01	23.99
		1	12	24.37	24.31	24.42
		1	24	24.09	23.97	24.03
		12	0	23.43	23.35	23.46
		12	6	23.41	23.43	23.44
		12	13	23.30	23.58	23.36
		25	0	23.44	23.37	23.43
	16QAM	1	0	23.48	23.28	23.32
		1	12	23.77	23.72	23.64
		1	24	23.38	23.42	23.34
		12	0	22.51	22.47	22.52
		12	6	22.60	22.43	22.52
		12	13	22.41	22.57	22.33
		25	0	22.38	22.47	22.38
	64QAM	1	0	22.40	22.36	22.23
		1	12	22.61	22.65	22.47
		1	24	22.37	22.29	22.30
		12	0	21.47	21.40	21.44
		12	6	21.50	21.41	21.50
		12	13	21.40	21.50	21.24
		25	0	21.44	21.49	21.34



**BUREAU
VERITAS**

Test Report No.: W7L-P24050014RF06

Band/BW	Modulation	RB Size	RB Offset	Low CH 18650	Mid CH 18900	High CH 19150
				Frequency 1855 MHz	Frequency 1880 MHz	Frequency 1905 MHz
2/ 10	QPSK	1	0	24.04	24.02	23.99
		1	24	24.36	24.33	24.39
		1	49	24.11	24.02	24.07
		25	0	23.38	23.37	23.51
		25	12	23.45	23.34	23.50
		25	25	23.32	23.53	23.29
		50	0	23.32	23.39	23.34
	16QAM	1	0	23.43	23.35	23.31
		1	24	23.80	23.62	23.60
		1	49	23.38	23.42	23.23
		25	0	22.47	22.42	22.43
		25	12	22.51	22.41	22.41
		25	25	22.43	22.62	22.33
		50	0	22.43	22.53	22.35
	64QAM	1	0	22.33	22.34	22.27
		1	24	22.57	22.62	22.53
		1	49	22.37	22.32	22.39
		25	0	21.41	21.49	21.50
		25	12	21.41	21.43	21.50
		25	25	21.36	21.47	21.31
		50	0	21.37	21.45	21.43



Band/BW	Modulation	RB Size	RB Offset	Low CH 18675	Mid CH 18900	High CH 19125
				Frequency 1857.5 MHz	Frequency 1880 MHz	Frequency 1902.5 MHz
2/ 15	QPSK	1	0	24.13	24.03	24.07
		1	37	24.36	24.29	24.41
		1	74	24.04	24.01	24.11
		36	0	23.38	23.45	23.46
		36	19	23.51	23.34	23.49
		36	39	23.32	23.59	23.36
		75	0	23.43	23.41	23.35
	16QAM	1	0	23.49	23.32	23.35
		1	37	23.85	23.65	23.57
		1	74	23.38	23.31	23.26
		36	0	22.38	22.36	22.51
		36	19	22.51	22.49	22.41
		36	39	22.39	22.58	22.34
		75	0	22.43	22.39	22.45
	64QAM	1	0	22.32	22.37	22.35
		1	37	22.69	22.66	22.60
		1	74	22.37	22.31	22.39
		36	0	21.42	21.44	21.42
		36	19	21.49	21.52	21.54
		36	39	21.41	21.47	21.29
		75	0	21.38	21.52	21.39



**BUREAU
VERITAS**

Test Report No.: W7L-P24050014RF06

Band/BW	Modulation	RB Size	RB Offset	Low CH 18700	Mid CH 18900	High CH 19100
				Frequency 1860 MHz	Frequency 1880 MHz	Frequency 1900 MHz
2/ 20	QPSK	1	0	24.18	24.14	24.14
		1	50	24.43	24.42	24.52
		1	99	24.17	24.12	24.15
		50	0	23.45	23.47	23.55
		50	25	23.52	23.49	23.57
		50	50	23.44	23.46	23.41
		100	0	23.47	23.48	23.52
	16QAM	1	0	23.54	23.38	23.42
		1	50	23.87	23.77	23.66
		1	99	23.44	23.45	23.37
		50	0	22.52	22.51	22.54
		50	25	22.64	22.56	22.53
		50	50	22.49	22.66	22.37
		100	0	22.51	22.54	22.47
	64QAM	1	0	22.45	22.41	22.38
		1	50	22.72	22.76	22.62
		1	99	22.38	22.37	22.44
		50	0	21.49	21.54	21.54
		50	25	21.53	21.53	21.57
		50	50	21.43	21.59	21.37
		100	0	21.45	21.55	21.44



**BUREAU
VERITAS**

Test Report No.: W7L-P24050014RF06

EIRP POWER (dBm)

Ant 0(UP):

GSM

Channel	Frequency (MHz)	Conducted Power (dBm)	G _{T-Lc} (dB)	EIRP (dBm)	EIRP (mW)	Limit (W)
512	1850.2	29.27	-0.3	28.97	788.86	2
661	1880.0	29.25	-0.3	28.95	785.24	2
810	1909.8	29.34	-0.3	29.04	801.68	2

EDGE

Channel	Frequency (MHz)	Conducted Power (dBm)	G _{T-Lc} (dB)	EIRP (dBm)	EIRP (mW)	Limit (W)
512	1850.2	26.08	-0.3	25.78	378.44	2
661	1880.0	26.06	-0.3	25.76	376.7	2
810	1909.8	26.24	-0.3	25.94	392.64	2

WCDMA

Channel	Frequency (MHz)	Conducted Power (dBm)	G _{T-Lc} (dB)	EIRP (dBm)	EIRP (mW)	Limit (W)
9262	1852.4	24.57	-0.3	24.27	267.3	2
9400	1880	24.61	-0.3	24.31	269.77	2
9538	1907.6	24.6	-0.3	24.3	269.15	2



LTE BAND 2

CHANNEL BANDWIDTH: 1.4MHz QPSK

Channel	Frequency (MHz)	Conducted Power (dBm)	G _{T-Lc} (dB)	EIRP (dBm)	EIRP (mW)	Limit (W)
18607	1850.7	24.33	-0.3	24.03	252.93	2
18900	1880.0	24.21	-0.3	23.91	246.04	2
19193	1909.3	24.24	-0.3	23.94	247.74	2

CHANNEL BANDWIDTH: 1.4MHz 16QAM

Channel	Frequency (MHz)	Conducted Power (dBm)	G _{T-Lc} (dB)	EIRP (dBm)	EIRP (mW)	Limit (W)
18607	1850.7	23.43	-0.3	23.13	205.59	2
18900	1880.0	23.48	-0.3	23.18	207.97	2
19193	1909.3	23.38	-0.3	23.08	203.24	2

CHANNEL BANDWIDTH: 1.4MHz 64QAM

Channel	Frequency (MHz)	Conducted Power (dBm)	G _{T-Lc} (dB)	EIRP (dBm)	EIRP (mW)	Limit (W)
18607	1850.7	22.8	-0.3	22.5	177.83	2
18900	1880.0	22.59	-0.3	22.29	169.43	2
19193	1908.3	22.33	-0.3	22.03	159.59	2



**BUREAU
VERITAS**

Test Report No.: W7L-P24050014RF06

CHANNEL BANDWIDTH: 3MHz QPSK

Channel	Frequency (MHz)	Conducted Power (dBm)	G _{T-Lc} (dB)	EIRP (dBm)	EIRP (mW)	Limit (W)
18615	1851.5	24.25	-0.3	23.95	248.31	2
18900	1880.0	24.16	-0.3	23.86	243.22	2
19185	1908.5	24.22	-0.3	23.92	246.6	2

CHANNEL BANDWIDTH: 3MHz 16QAM

Channel	Frequency (MHz)	Conducted Power (dBm)	G _{T-Lc} (dB)	EIRP (dBm)	EIRP (mW)	Limit (W)
18615	1851.5	23.5	-0.3	23.2	208.93	2
18900	1880.0	23.56	-0.3	23.26	211.84	2
19185	1908.5	23.39	-0.3	23.09	203.7	2

CHANNEL BANDWIDTH: 3MHz 64QAM

Channel	Frequency (MHz)	Conducted Power (dBm)	G _{T-Lc} (dB)	EIRP (dBm)	EIRP (mW)	Limit (W)
18615	1851.5	22.83	-0.3	22.53	179.06	2
18900	1880.0	22.59	-0.3	22.29	169.43	2
19185	1908.5	22.41	-0.3	22.11	162.55	2



BUREAU
VERITAS

Test Report No.: W7L-P24050014RF06

CHANNEL BANDWIDTH: 5MHz QPSK

Channel	Frequency (MHz)	Conducted Power (dBm)	G _T -L _C (dB)	EIRP (dBm)	EIRP (mW)	Limit (W)
18625	1852.5	24.28	-0.3	23.98	250.03	2
18900	1880.0	24.19	-0.3	23.89	244.91	2
19175	1907.5	24.23	-0.3	23.93	247.17	2

CHANNEL BANDWIDTH: 5MHz 16QAM

Channel	Frequency (MHz)	Conducted Power (dBm)	G _T -L _C (dB)	EIRP (dBm)	EIRP (mW)	Limit (W)
18625	1852.5	23.53	-0.3	23.23	210.38	2
18900	1880.0	23.58	-0.3	23.28	212.81	2
19175	1907.5	23.37	-0.3	23.07	202.77	2

CHANNEL BANDWIDTH: 5MHz 64QAM

Channel	Frequency (MHz)	Conducted Power (dBm)	G _T -L _C (dB)	EIRP (dBm)	EIRP (mW)	Limit (W)
18625	1852.5	22.88	-0.3	22.58	181.13	2
18900	1880.0	22.55	-0.3	22.25	167.88	2
19175	1907.5	22.33	-0.3	22.03	159.59	2



CHANNEL BANDWIDTH: 10MHz QPSK

Channel	Frequency (MHz)	Conducted Power (dBm)	G _{T-Lc} (dB)	EIRP (dBm)	EIRP (mW)	Limit (W)
18650	1855.0	24.27	-0.3	23.97	249.46	2
18900	1880.0	24.22	-0.3	23.92	246.6	2
19150	1905.0	24.16	-0.3	23.86	243.22	2

CHANNEL BANDWIDTH: 10MHz 16QAM

Channel	Frequency (MHz)	Conducted Power (dBm)	G _{T-Lc} (dB)	EIRP (dBm)	EIRP (mW)	Limit (W)
18650	1855.0	23.54	-0.3	23.24	210.86	2
18900	1880.0	23.57	-0.3	23.27	212.32	2
19150	1905.0	23.34	-0.3	23.04	201.37	2

CHANNEL BANDWIDTH: 10MHz 64QAM

Channel	Frequency (MHz)	Conducted Power (dBm)	G _{T-Lc} (dB)	EIRP (dBm)	EIRP (mW)	Limit (W)
18650	1855.0	22.83	-0.3	22.53	179.06	2
18900	1880.0	22.58	-0.3	22.28	169.04	2
19150	1905.0	22.37	-0.3	22.07	161.06	2



CHANNEL BANDWIDTH: 15MHz QPSK

Channel	Frequency (MHz)	Conducted Power (dBm)	G _{T-Lc} (dB)	EIRP (dBm)	EIRP (mW)	Limit (W)
18675	1857.5	24.32	-0.3	24.02	252.35	2
18900	1880.0	24.26	-0.3	23.96	248.89	2
19125	1902.5	24.24	-0.3	23.94	247.74	2

CHANNEL BANDWIDTH: 15MHz 16QAM

Channel	Frequency (MHz)	Conducted Power (dBm)	G _{T-Lc} (dB)	EIRP (dBm)	EIRP (mW)	Limit (W)
18675	1857.5	23.52	-0.3	23.22	209.89	2
18900	1880.0	23.5	-0.3	23.2	208.93	2
19125	1902.5	23.37	-0.3	23.07	202.77	2

CHANNEL BANDWIDTH: 15MHz 64QAM

Channel	Frequency (MHz)	Conducted Power (dBm)	G _{T-Lc} (dB)	EIRP (dBm)	EIRP (mW)	Limit (W)
18675	1857.5	22.85	-0.3	22.55	179.89	2
18900	1880.0	22.61	-0.3	22.31	170.22	2
19125	1902.5	22.37	-0.3	22.07	161.06	2



CHANNEL BANDWIDTH: 20MHz QPSK

Channel	Frequency (MHz)	Conducted Power (dBm)	G _{T-Lc} (dB)	EIRP (dBm)	EIRP (mW)	Limit (W)
18700	1860	24.37	-0.3	24.07	255.27	2
18900	1880	24.27	-0.3	23.97	249.46	2
19100	1900	24.25	-0.3	23.95	248.31	2

CHANNEL BANDWIDTH: 20MHz 16QAM

Channel	Frequency (MHz)	Conducted Power (dBm)	G _{T-Lc} (dB)	EIRP (dBm)	EIRP (mW)	Limit (W)
18700	1860	23.58	-0.3	23.28	212.81	2
18900	1880	23.61	-0.3	23.31	214.29	2
19100	1900	23.44	-0.3	23.14	206.06	2

CHANNEL BANDWIDTH: 20MHz 64QAM

Channel	Frequency (MHz)	Conducted Power (dBm)	G _{T-Lc} (dB)	EIRP (dBm)	EIRP (mW)	Limit (W)
18700	1860	22.93	-0.3	22.63	183.23	2
18900	1880	22.63	-0.3	22.33	171	2
19100	1900	22.47	-0.3	22.17	164.82	2



**BUREAU
VERITAS**

Test Report No.: W7L-P24050014RF06

Ant 1(DOWN):

GSM

Channel	Frequency (MHz)	Conducted Power (dBm)	G _T -L _C (dB)	EIRP (dBm)	EIRP (mW)	Limit (W)
512	1850.2	29.41	-0.5	28.91	778.04	2
661	1880.0	29.42	-0.5	28.92	779.83	2
810	1909.8	29.31	-0.5	28.81	760.33	2

EDGE

Channel	Frequency (MHz)	Conducted Power (dBm)	G _T -L _C (dB)	EIRP (dBm)	EIRP (mW)	Limit (W)
512	1850.2	25.83	-0.5	25.33	341.19	2
661	1880.0	26.08	-0.5	25.58	361.41	2
810	1909.8	26.11	-0.5	25.61	363.92	2

WCDMA

Channel	Frequency (MHz)	Conducted Power (dBm)	G _T -L _C (dB)	EIRP (dBm)	EIRP (mW)	Limit (W)
9262	1852.4	24.42	-0.5	23.92	246.6	2
9400	1880	24.45	-0.5	23.95	248.31	2
9538	1907.6	24.35	-0.5	23.85	242.66	2



LTE BAND 2

CHANNEL BANDWIDTH: 1.4MHz QPSK

Channel	Frequency (MHz)	Conducted Power (dBm)	G _{T-Lc} (dB)	EIRP (dBm)	EIRP (mW)	Limit (W)
18607	1850.7	24.36	-0.5	23.86	243.22	2
18900	1880.0	24.4	-0.5	23.9	245.47	2
19193	1909.3	24.46	-0.5	23.96	248.89	2

CHANNEL BANDWIDTH: 1.4MHz 16QAM

Channel	Frequency (MHz)	Conducted Power (dBm)	G _{T-Lc} (dB)	EIRP (dBm)	EIRP (mW)	Limit (W)
18607	1850.7	23.86	-0.5	23.36	216.77	2
18900	1880.0	23.64	-0.5	23.14	206.06	2
19193	1909.3	23.6	-0.5	23.1	204.17	2

CHANNEL BANDWIDTH: 1.4MHz 64QAM

Channel	Frequency (MHz)	Conducted Power (dBm)	G _{T-Lc} (dB)	EIRP (dBm)	EIRP (mW)	Limit (W)
18607	1850.7	22.7	-0.5	22.2	165.96	2
18900	1880.0	22.63	-0.5	22.13	163.31	2
19193	1908.3	22.53	-0.5	22.03	159.59	2



CHANNEL BANDWIDTH: 3MHz QPSK

Channel	Frequency (MHz)	Conducted Power (dBm)	G _{T-Lc} (dB)	EIRP (dBm)	EIRP (mW)	Limit (W)
18615	1851.5	24.35	-0.5	23.85	242.66	2
18900	1880.0	24.29	-0.5	23.79	239.33	2
19185	1908.5	24.43	-0.5	23.93	247.17	2

CHANNEL BANDWIDTH: 3MHz 16QAM

Channel	Frequency (MHz)	Conducted Power (dBm)	G _{T-Lc} (dB)	EIRP (dBm)	EIRP (mW)	Limit (W)
18615	1851.5	23.73	-0.5	23.23	210.38	2
18900	1880.0	23.71	-0.5	23.21	209.41	2
19185	1908.5	23.55	-0.5	23.05	201.84	2

CHANNEL BANDWIDTH: 3MHz 64QAM

Channel	Frequency (MHz)	Conducted Power (dBm)	G _{T-Lc} (dB)	EIRP (dBm)	EIRP (mW)	Limit (W)
18615	1851.5	22.68	-0.5	22.18	165.2	2
18900	1880.0	22.72	-0.5	22.22	166.72	2
19185	1908.5	22.57	-0.5	22.07	161.06	2



**BUREAU
VERITAS**

Test Report No.: W7L-P24050014RF06

CHANNEL BANDWIDTH: 5MHz QPSK

Channel	Frequency (MHz)	Conducted Power (dBm)	G _T -L _C (dB)	EIRP (dBm)	EIRP (mW)	Limit (W)
18625	1852.5	24.37	-0.5	23.87	243.78	2
18900	1880.0	24.31	-0.5	23.81	240.44	2
19175	1907.5	24.42	-0.5	23.92	246.6	2

CHANNEL BANDWIDTH: 5MHz 16QAM

Channel	Frequency (MHz)	Conducted Power (dBm)	G _T -L _C (dB)	EIRP (dBm)	EIRP (mW)	Limit (W)
18625	1852.5	23.77	-0.5	23.27	212.32	2
18900	1880.0	23.72	-0.5	23.22	209.89	2
19175	1907.5	23.64	-0.5	23.14	206.06	2

CHANNEL BANDWIDTH: 5MHz 64QAM

Channel	Frequency (MHz)	Conducted Power (dBm)	G _T -L _C (dB)	EIRP (dBm)	EIRP (mW)	Limit (W)
18625	1852.5	22.61	-0.5	22.11	162.55	2
18900	1880.0	22.65	-0.5	22.15	164.06	2
19175	1907.5	22.47	-0.5	21.97	157.4	2



CHANNEL BANDWIDTH: 10MHz QPSK

Channel	Frequency (MHz)	Conducted Power (dBm)	G _{T-Lc} (dB)	EIRP (dBm)	EIRP (mW)	Limit (W)
18650	1855.0	24.36	-0.5	23.86	243.22	2
18900	1880.0	24.33	-0.5	23.83	241.55	2
19150	1905.0	24.39	-0.5	23.89	244.91	2

CHANNEL BANDWIDTH: 10MHz 16QAM

Channel	Frequency (MHz)	Conducted Power (dBm)	G _{T-Lc} (dB)	EIRP (dBm)	EIRP (mW)	Limit (W)
18650	1855.0	23.8	-0.5	23.3	213.8	2
18900	1880.0	23.62	-0.5	23.12	205.12	2
19150	1905.0	23.6	-0.5	23.1	204.17	2

CHANNEL BANDWIDTH: 10MHz 64QAM

Channel	Frequency (MHz)	Conducted Power (dBm)	G _{T-Lc} (dB)	EIRP (dBm)	EIRP (mW)	Limit (W)
18650	1855.0	22.57	-0.5	22.07	161.06	2
18900	1880.0	22.62	-0.5	22.12	162.93	2
19150	1905.0	22.53	-0.5	22.03	159.59	2



CHANNEL BANDWIDTH: 15MHz QPSK

Channel	Frequency (MHz)	Conducted Power (dBm)	G _{T-Lc} (dB)	EIRP (dBm)	EIRP (mW)	Limit (W)
18675	1857.5	24.36	-0.5	23.86	243.22	2
18900	1880.0	24.29	-0.5	23.79	239.33	2
19125	1902.5	24.41	-0.5	23.91	246.04	2

CHANNEL BANDWIDTH: 15MHz 16QAM

Channel	Frequency (MHz)	Conducted Power (dBm)	G _{T-Lc} (dB)	EIRP (dBm)	EIRP (mW)	Limit (W)
18675	1857.5	23.85	-0.5	23.35	216.27	2
18900	1880.0	23.65	-0.5	23.15	206.54	2
19125	1902.5	23.57	-0.5	23.07	202.77	2

CHANNEL BANDWIDTH: 15MHz 64QAM

Channel	Frequency (MHz)	Conducted Power (dBm)	G _{T-Lc} (dB)	EIRP (dBm)	EIRP (mW)	Limit (W)
18675	1857.5	22.69	-0.5	22.19	165.58	2
18900	1880.0	22.66	-0.5	22.16	164.44	2
19125	1902.5	22.6	-0.5	22.1	162.18	2



CHANNEL BANDWIDTH: 20MHz QPSK

Channel	Frequency (MHz)	Conducted Power (dBm)	G _{T-L_C} (dB)	EIRP (dBm)	EIRP (mW)	Limit (W)
18700	1860	24.43	-0.5	23.93	247.17	2
18900	1880	24.42	-0.5	23.92	246.6	2
19100	1900	24.52	-0.5	24.02	252.35	2

CHANNEL BANDWIDTH: 20MHz 16QAM

Channel	Frequency (MHz)	Conducted Power (dBm)	G _{T-L_C} (dB)	EIRP (dBm)	EIRP (mW)	Limit (W)
18700	1860	23.87	-0.5	23.37	217.27	2
18900	1880	23.77	-0.5	23.27	212.32	2
19100	1900	23.66	-0.5	23.16	207.01	2

CHANNEL BANDWIDTH: 20MHz 64QAM

Channel	Frequency (MHz)	Conducted Power (dBm)	G _{T-L_C} (dB)	EIRP (dBm)	EIRP (mW)	Limit (W)
18700	1860	22.72	-0.5	22.22	166.72	2
18900	1880	22.76	-0.5	22.26	168.27	2
19100	1900	22.62	-0.5	22.12	162.93	2



3.2 FREQUENCY STABILITY MEASUREMENT

3.2.1 LIMITS OF FREQUENCY STABILITY MEASUREMENT

The frequency stability shall be sufficient to ensure that the fundamental emission stays within the authorized frequency block.

3.2.2 TEST PROCEDURE

- The device is placed in the oven room. The oven room could control the temperatures and humidity. Power warms up is at least 15 min and power applied should perform before recording frequency error.
- EUT is connected the external power supply to control the DC input power. The test voltage range is from minimum to maximum working voltage. Each step shall be recording the frequency error rate.
- The temperature range step is 10 degrees in this test items. All temperature levels shall be holding $\pm 0.5^{\circ}\text{C}$ during the measurement testing. Each temperature step shall be at least 0.5 hours, consider the EUT could be test under the stability condition.

NOTE: The frequency error was recorded frequency error from the communication simulator.

3.2.3 TEST SETUP

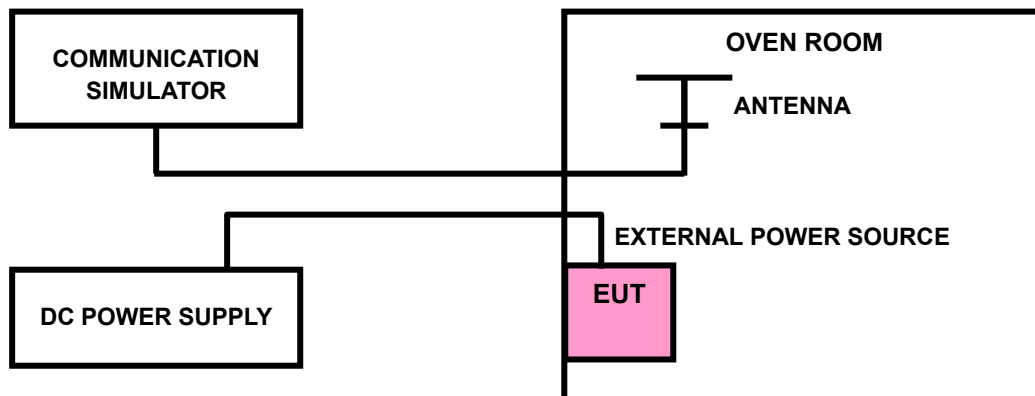



**BUREAU
VERITAS**

Test Report No.: W7L-P24050014RF06

3.2.4 TEST RESULTS

Please Refer to Appendix Of this test report.

Note: LV = Low voltage (3.6V); NV = Normal voltage (3.84V); HV= High voltage (4.4V).
NT = Normal temperature (25°C)



3.3 OCCUPIED BANDWIDTH MEASUREMENT

3.3.1 LIMITS OF OCCUPIED BANDWIDTH MEASUREMENT

The width of a frequency band is such that, below the lower and above the upper frequency limits, the mean powers emitted are each equal to a specified percentage. 0.5 % of the total mean power of a given emission.

3.3.2 TEST SETUP

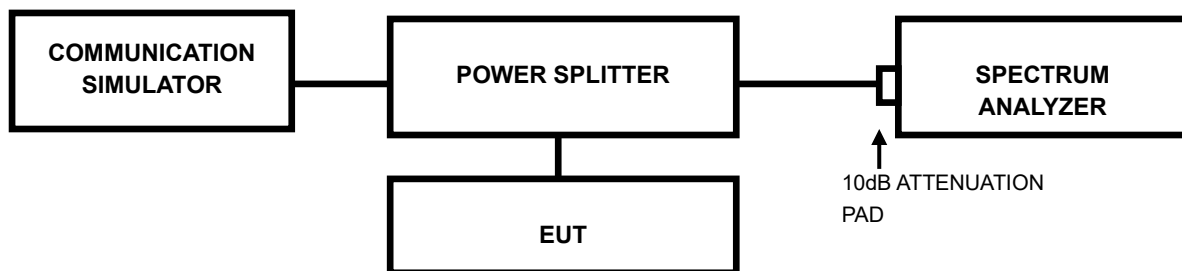

3.3.3 TEST PROCEDURES

- The conducted occupied bandwidth used the power splitter via EUT RF power connector between simulation base station and spectrum analyzer.
- Use OBW measurement function of Spectrum analyzer to measure 99 % occupied bandwidth.



BUREAU
VERITAS

Test Report No.: W7L-P24050014RF06

3.3.4 TEST RESULTS

Please Refer to Appendix Of this test report.



3.4 BAND EDGE MEASUREMENTC

3.4.1 LIMITS OF BAND EDGE MEASUREMENT

Power of any emission outside of the authorized operating frequency ranges must be attenuated below the transmitting power (P) by a factor of at least $43 + 10 \log(P)$ dB. In the 1 MHz bands immediately outside and adjacent to the frequency block a resolution bandwidth of at least one percent of the emission bandwidth of the fundamental emission of the transmitter may be employed.

3.4.2 TEST SETUP

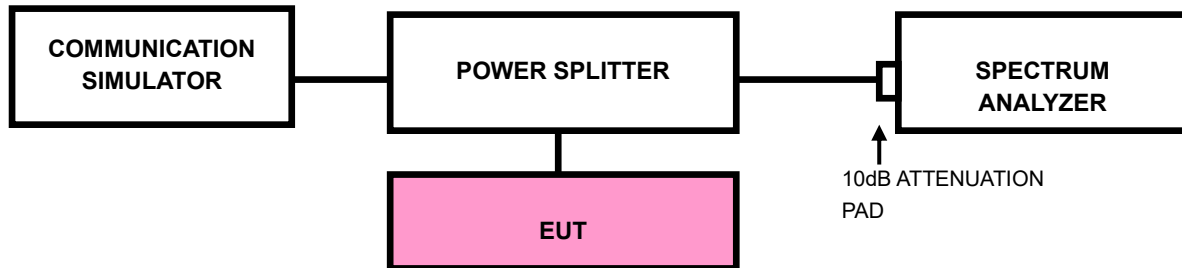



3.4.3 TEST PROCEDURES

- a) All measurements were done at low and high operational frequency range.
- b) Connect the transmitter to the spectrum analyzer via coaxial cable while ensuring proper impedance matching.
- c) Tune the analyzer to the nominal center frequency of the emission bandwidth (EBW)
- d) Set the resolution bandwidth (RBW) $\geq 1\%$ EBW in the 1MHz band immediately outside and adjacent to the band edge.
- e) Beyond the 1MHz band from the band edge, RBW=1MHz was used.
- f) Set the video bandwidth (VBW) to $\geq 3 \times$ RBW.
- g) Select the average power (RMS) display detector.
- h) Set the number of measurement points to ≥ 1001 .
- i) Use auto-coupled sweep time.
- j) Perform the measurement over an interval of time when the transmission is continuous and at its maximum power level.
- k) The RF fundamental frequency should be excluded against the limit line in the operating frequency band and use RBW is 10KHz or 100KHz.
- l) Record the max trace plot into the test report.



BUREAU
VERITAS

Test Report No.: W7L-P24050014RF06

3.4.4. TEST RESULTS

Please Refer to Appendix Of this test report.



3.5 CONDUCTED SPURIOUS EMISSIONS

3.5.1 LIMITS OF CONDUCTED SPURIOUS EMISSIONS MEASUREMENT

The power of any emission outside of the authorized operating frequency ranges must be attenuated below the transmitting power (P) by a factor of at least $43 + 10 \log(P)$ dB. The emission limit is equal to -13dBm .

3.5.2 TEST PROCEDURE

- a. The EUT makes a phone call to the communication simulator. All measurements were done at low, middle, and high operational frequency range.
- b. Measuring frequency range is from 30MHz up to a frequency including its 10th harmonic. 10dB attenuation pad is connected with spectrum. RBW=1MHz and VBW=3MHz is used for conducted emission measurement.

3.5.3 TEST SETUP

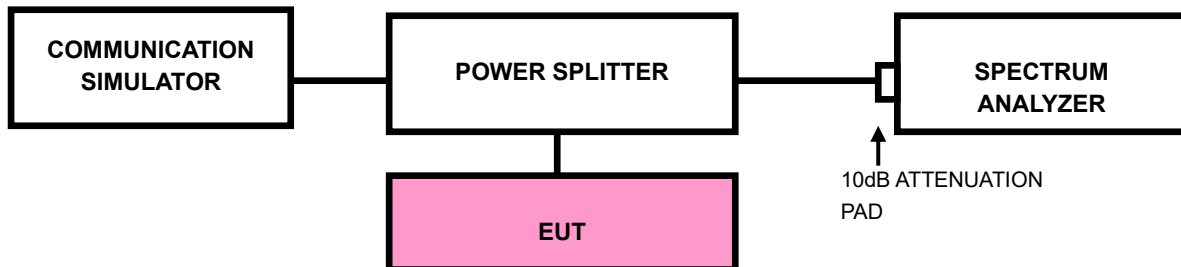



BUREAU
VERITAS

Test Report No.: W7L-P24050014RF06

3.5.4 TEST RESULTS

NOTE : The 9K~30MHz amplitude of spurious emissions attenuated more than 20 dB below the permissible value is not required in the report.

Please Refer to Appendix Of this test report.



3.6 RADIATED EMISSION MEASUREMENT

3.6.1 LIMITS OF RADIATED EMISSION MEASUREMENT

The power of any emission outside of the authorized operating frequency ranges must be attenuated below the transmitting power (P) by a factor of at least $43 + 10 \log(P)$ dB. The emission limit is equal to -13dBm .

3.6.2 TEST PROCEDURES

- a. The substitute method is used for E.I.R.P measurement. In the semi-anechoic chamber, EUT placed on the 0.8m height of Turn Table, rotated the table around 360 degrees to search the maximum radiation power and receiver antenna shall be rotated vertical and horizontal polarization and moved height from 1m to 4m to find the maximum polar radiated power. The “Read Value” is the spectrum reading the maximum power value.
- b. The substitution horn antenna is substituted for EUT at the same position and signals generator exports the CW signal to the substitution antenna via a TX cable. Rotated the Turn Table and moved the receiving antenna to find the maximum radiation power. Adjust output power level of S.G to get a Value of spectrum reading equal to “Read Value “ of step a. Record the power level of S.G
- c. $\text{EIRP} = \text{Output power level of S.G} - \text{TX cable loss} + \text{Antenna gain of substitution horn}$.

NOTE: The resolution bandwidth and video bandwidth of test receiver/spectrum analyzer is 1MHz/3MHz.

3.6.3 DEVIATION FROM TEST STANDARD

No deviation

3.6.4 TEST SETUP

< Frequency Range below 30MHz >

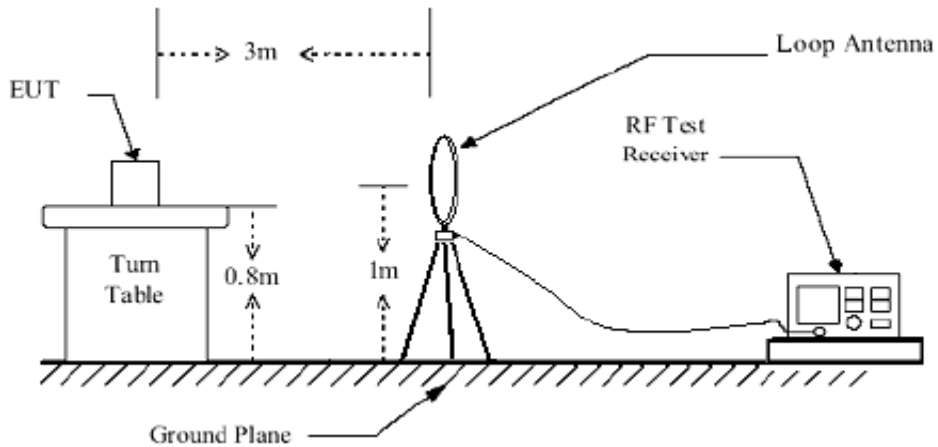

< Frequency Range 30MHz~1GHz >

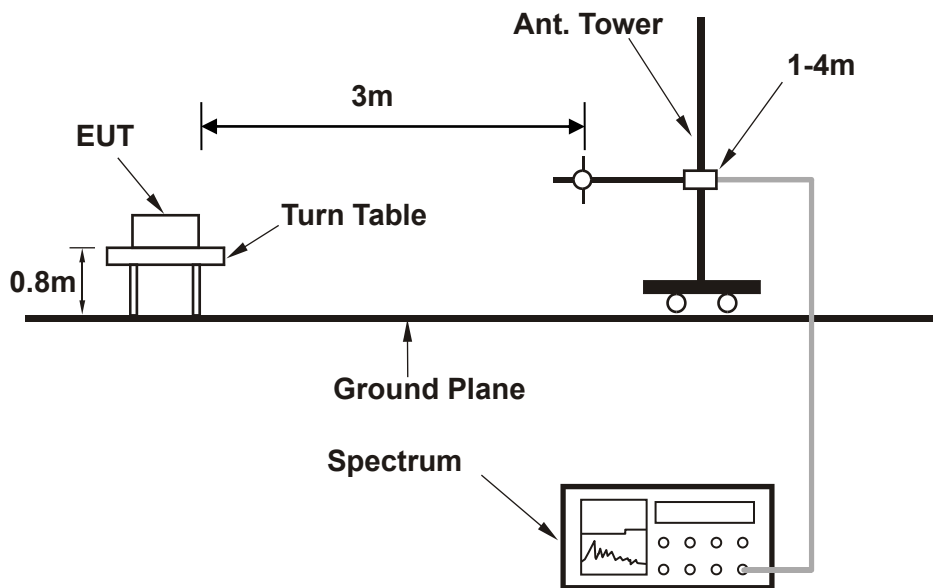



<Frequency Range above 1GHz>

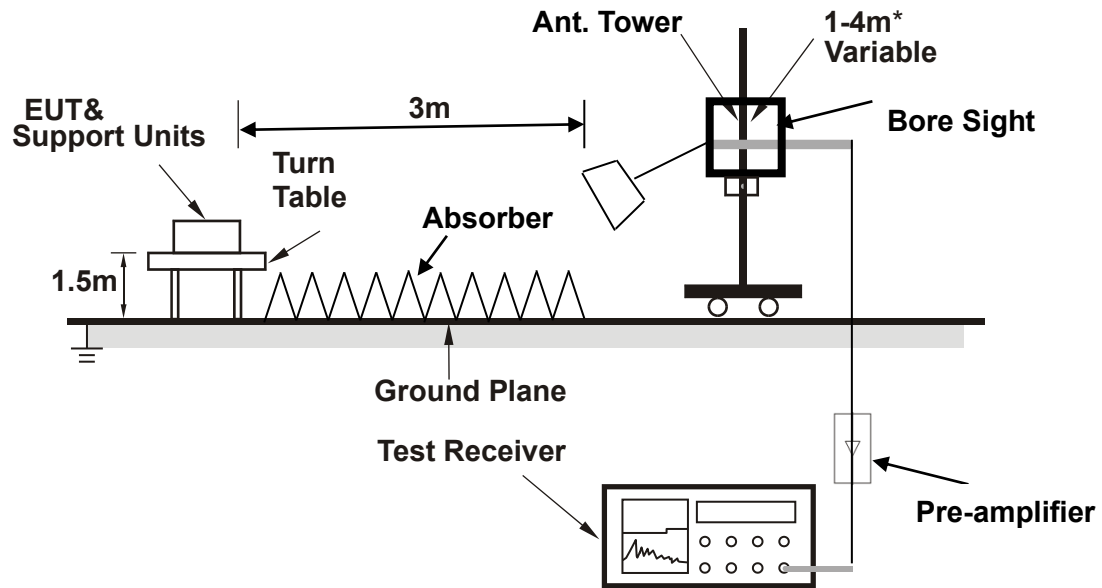

Note: Above 1G is a directional antenna

Depending on the EUT height and the antenna 3dB beamwidth both, refer to section 7.3 of CISPR 16-2-3.

For the actual test configuration, please refer to the attached file (Test Setup Photo).



3.6.5 TEST RESULTS

NOTE : The 9K~30MHz amplitude of spurious emissions attenuated more than 20 dB below the permissible value is not required in the report.

BELOW 1GHz WORST-CASE DATA

30 MHz – 1GHz data:

GSM1900(Ant0) (UP):

CHANNEL BANDWIDTH: 512 ~ 810

MODE	TX channel 661	FREQUENCY RANGE	Below 1000MHz
ENVIRONMENTAL CONDITIONS	23deg. C, 70%RH	INPUT POWER	AC 120V/60HZ
TESTED BY	Jace Hu		
ANTENNA POLARITY & TEST DISTANCE: HORIZONTAL AT 3 M			

	Freq	Level	Read Level	Limit Line	Over Limit	Factor	Remark	Pol/Phase
	MHz	dBm/m	dBm	dBm/m	dB	dB/m		
1	30.000	-56.36	-54.38	-13.00	-43.36	-1.98	Peak	Horizontal
2	91.110	-55.12	-42.36	-13.00	-42.12	-12.76	Peak	Horizontal
3	144.460	-58.93	-44.24	-13.00	-45.93	-14.69	Peak	Horizontal
4	178.410	-61.03	-44.61	-13.00	-48.03	-16.42	Peak	Horizontal
5	291.900	-62.01	-52.82	-13.00	-49.01	-9.19	Peak	Horizontal
6	801.150	-59.07	-64.25	-13.00	-46.07	5.18	Peak	Horizontal

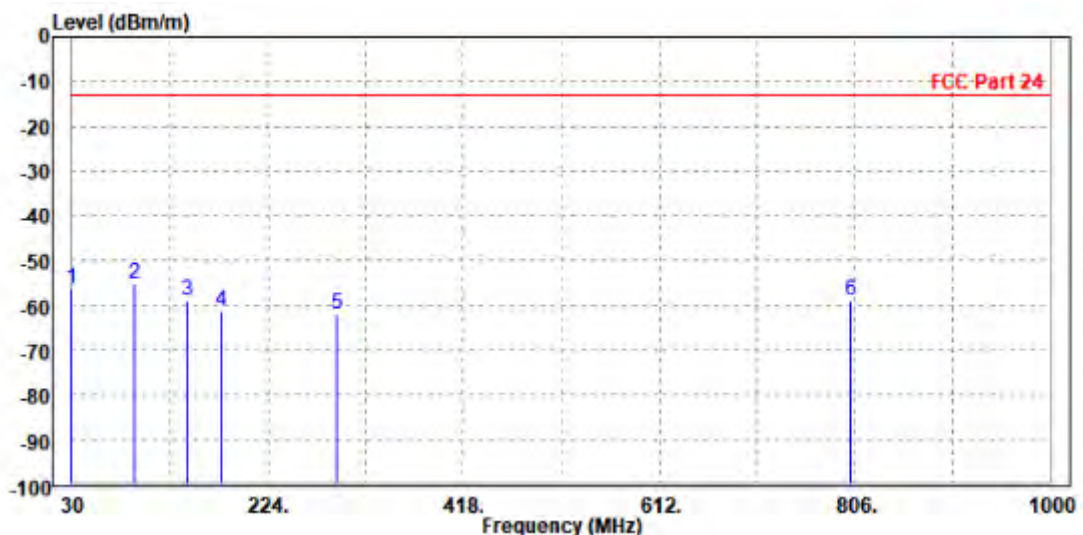



**BUREAU
VERITAS**

Test Report No.: W7L-P24050014RF06

MODE	TX channel 661	FREQUENCY RANGE	Below 1000MHz
ENVIRONMENTAL CONDITIONS	23deg. C, 70%RH	INPUT POWER	AC 120V/60HZ
TESTED BY	Jace Hu		
ANTENNA POLARITY & TEST DISTANCE: VERTICAL AT 3 M			

	Freq	Level	Read Level	Limit Line	Over Limit	Factor	Remark	Pol/Phase
	MHz	dBm/m	dBm	dBm/m	dB	dB/m		
1	65.890	-58.45	-38.83	-13.00	-45.45	-19.62	Peak	Vertical
2	87.230	-56.66	-38.84	-13.00	-43.66	-17.82	Peak	Vertical
3	145.430	-63.24	-49.34	-13.00	-50.24	-13.90	Peak	Vertical
4	197.810	-58.46	-49.87	-13.00	-45.46	-8.59	Peak	Vertical
5	292.870	-60.86	-57.40	-13.00	-47.86	-3.46	Peak	Vertical
6 PP	871.960	-53.46	-63.59	-13.00	-40.46	10.13	Peak	Vertical

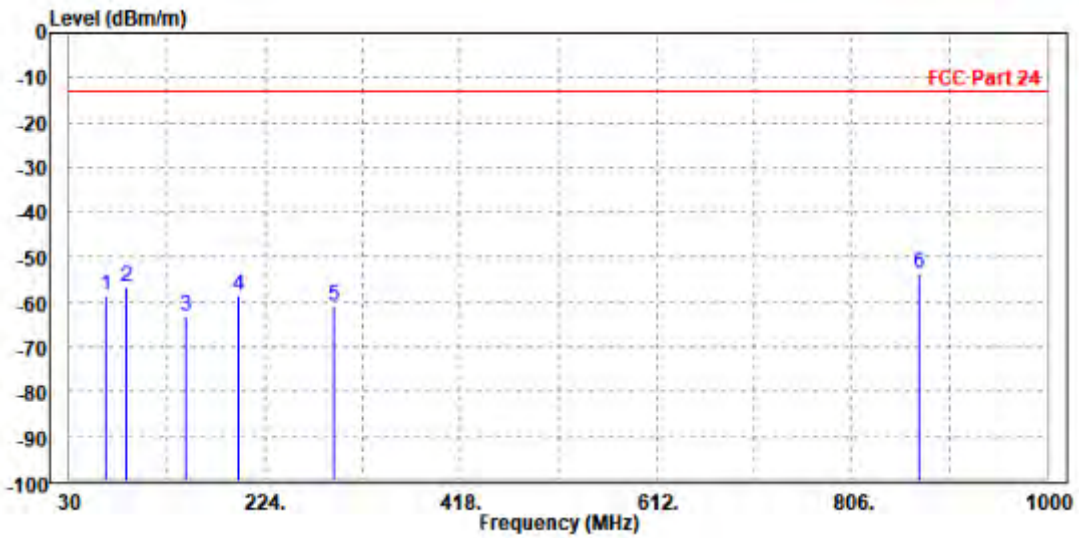



BUREAU VERITAS

Test Report No.: W7L-P24050014RF06

ABOVE 1GHz DATA

Note: For higher frequency, the emission is too low to be detected.

WORST-CASE DATA

GSM 1900(Ant0) (UP):

CH 512

MODE	TX channel 512	FREQUENCY RANGE	Above 1000MHz
ENVIRONMENTAL CONDITIONS	23deg. C, 70%RH	INPUT POWER	AC 120V/60HZ
TESTED BY	Jace Hu		
ANTENNA POLARITY & TEST DISTANCE: HORIZONTAL AT 3 M			

	Freq	Level	Read Level	Limit Line	Over Limit	Factor	Remark	Pol/Phase
	MHz	dBm/m	dBm	dBm/m	dB	dB/m		
1	3698.000	-51.10	-59.50	-13.00	-38.10	8.40	Peak	Horizontal
2 PP	5550.000	-44.26	-56.06	-13.00	-31.26	11.80	Peak	Horizontal

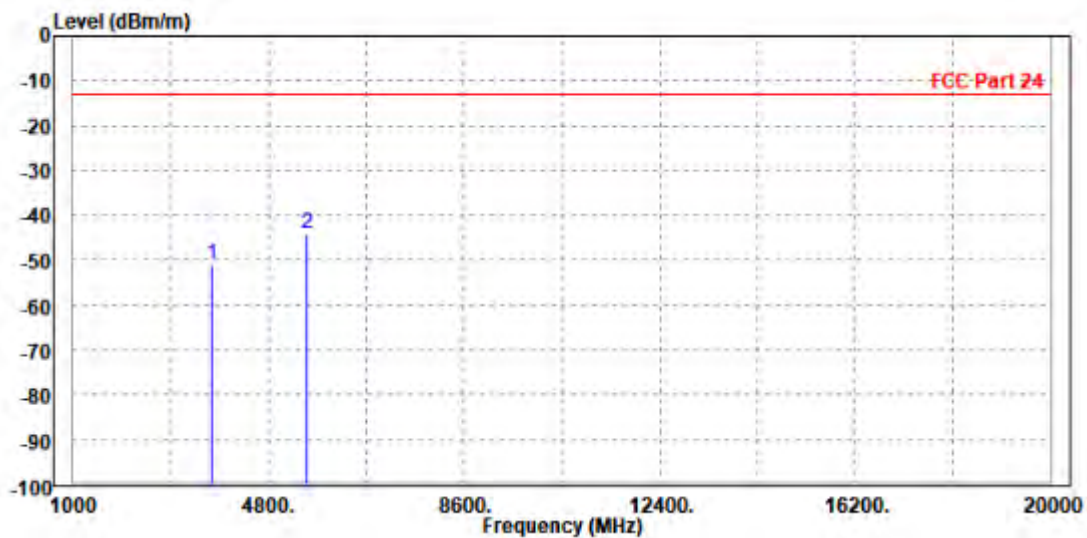



**BUREAU
VERITAS**

Test Report No.: W7L-P24050014RF06

MODE	TX channel 512	FREQUENCY RANGE	Above 1000MHz
ENVIRONMENTAL CONDITIONS	23deg. C, 70%RH	INPUT POWER	AC 120V/60HZ
TESTED BY	Jace Hu		
ANTENNA POLARITY & TEST DISTANCE: VERTICAL AT 3 M			

	Freq	Level	Read Level	Limit Line	Over Limit	Factor	Remark	Pol/Phase
	MHz	dBm/m	dBm	dBm/m	dB	dB/m		
1	3700.000	-51.44	-60.07	-13.00	-38.44	8.63	Peak	Vertical
2 PP	5541.000	-44.70	-57.04	-13.00	-31.70	12.34	Peak	Vertical

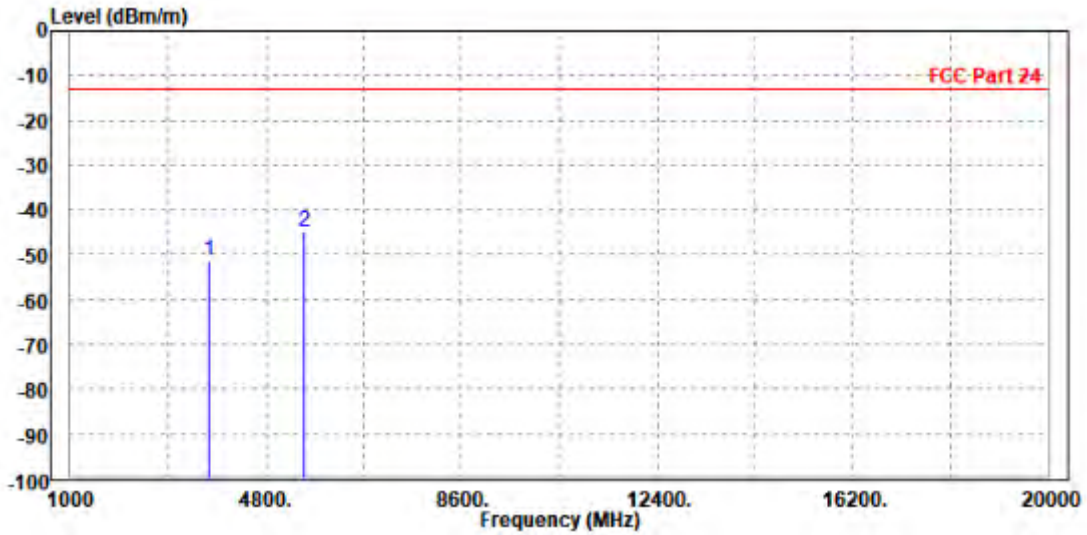



**BUREAU
VERITAS**

Test Report No.: W7L-P24050014RF06

CH 661

MODE	TX channel 661	FREQUENCY RANGE	Above 1000MHz
ENVIRONMENTAL CONDITIONS	23deg. C, 70%RH	INPUT POWER	AC 120V/60HZ
TESTED BY	Jace Hu		
ANTENNA POLARITY & TEST DISTANCE: HORIZONTAL AT 3 M			

	Freq	Level	Read Level	Limit Line	Over Limit	Factor	Remark	Pol/Phase
	MHz	dBm/m	dBm	dBm/m	dB	dB/m		
1	3760.000	-52.04	-60.39	-13.00	-39.04	8.35	Peak	Horizontal
2 PP	5640.000	-40.36	-52.17	-13.00	-27.36	11.81	Peak	Horizontal

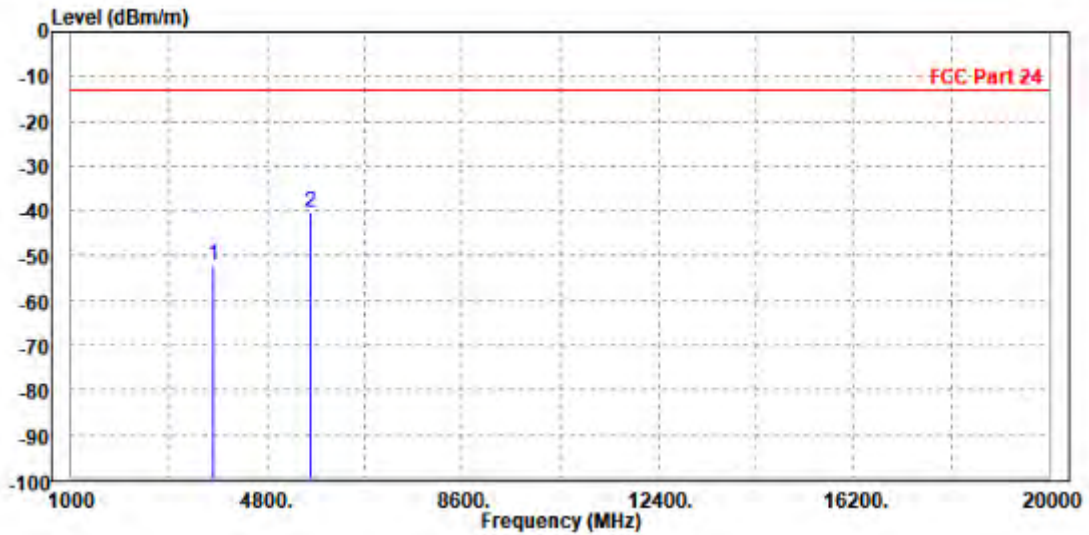



**BUREAU
VERITAS**

Test Report No.: W7L-P24050014RF06

MODE	TX channel 661	FREQUENCY RANGE	Above 1000MHz
ENVIRONMENTAL CONDITIONS	23deg. C, 70%RH	INPUT POWER	AC 120V/60HZ
TESTED BY	Jace Hu		
ANTENNA POLARITY & TEST DISTANCE: VERTICAL AT 3 M			

	Freq	Level	Read Level	Limit Line	Over Limit	Factor	Remark	Pol/Phase
	MHz	dBm/m	dBm	dBm/m	dB	dB/m		
1	3755.000	-52.03	-60.66	-13.00	-39.03	8.63	Peak	Vertical
2 PP	5640.000	-42.21	-54.53	-13.00	-29.21	12.32	Peak	Vertical

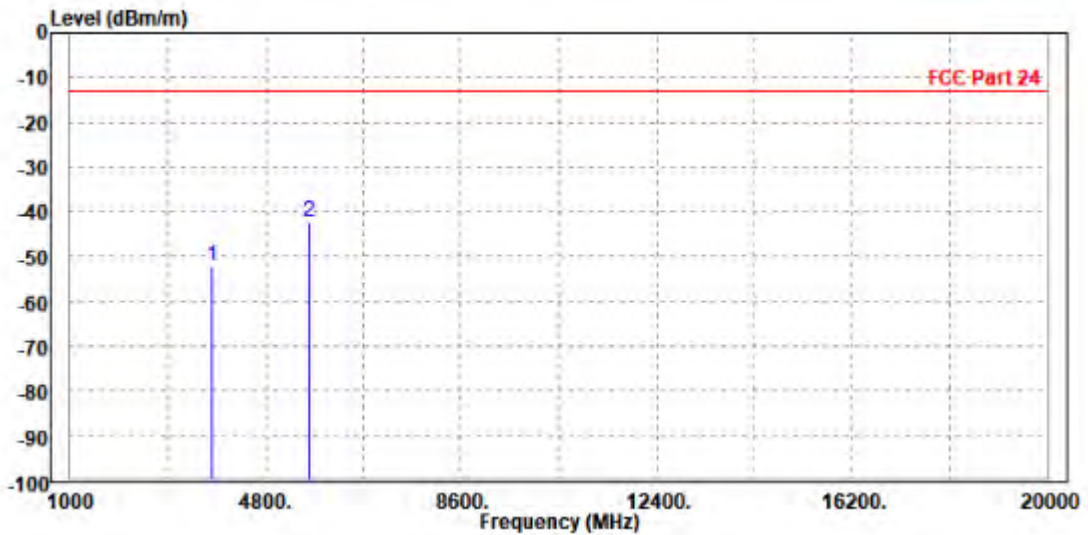



**BUREAU
VERITAS**

Test Report No.: W7L-P24050014RF06

CH 810

MODE	TX channel 810	FREQUENCY RANGE	Above 1000MHz
ENVIRONMENTAL CONDITIONS	23deg. C, 70%RH	INPUT POWER	AC 120V/60HZ
TESTED BY	Jace Hu		
ANTENNA POLARITY & TEST DISTANCE: HORIZONTAL AT 3 M			

	Freq	Level	Read Level	Limit Line	Over Limit	Factor	Remark	Pol/Phase
	MHz	dBm/m	dBm	dBm/m	dB	dB/m		
1	3818.000	-48.84	-57.15	-13.00	-35.84	8.31	Peak	Horizontal
2 PP	5731.000	-40.70	-52.52	-13.00	-27.70	11.82	Peak	Horizontal

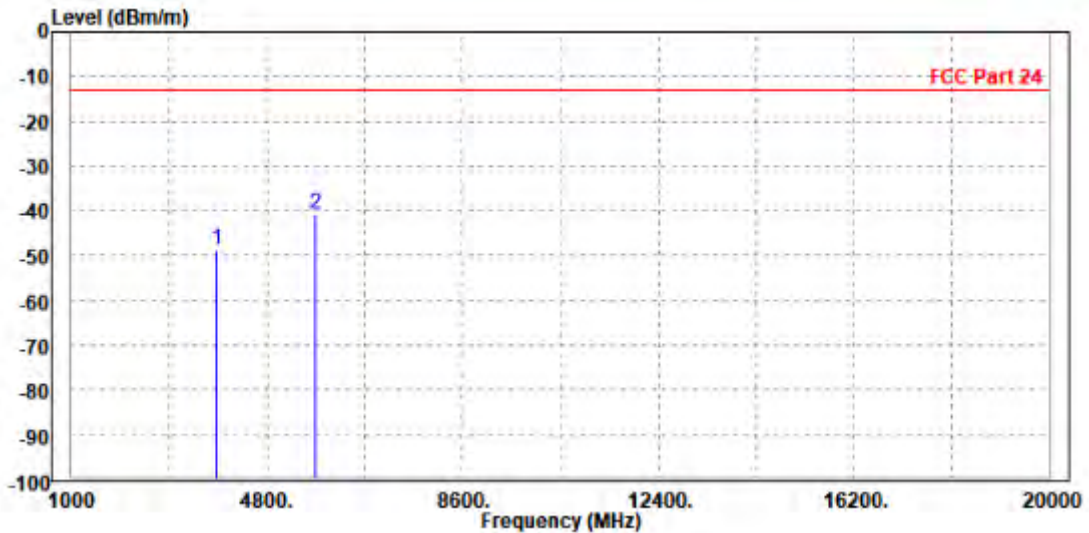



**BUREAU
VERITAS**

Test Report No.: W7L-P24050014RF06

MODE	TX channel 810	FREQUENCY RANGE	Above 1000MHz
ENVIRONMENTAL CONDITIONS	23deg. C, 70%RH	INPUT POWER	AC 120V/60HZ
TESTED BY	Jace Hu		
ANTENNA POLARITY & TEST DISTANCE: VERTICAL AT 3 M			

	Freq	Level	Read Level	Limit Line	Over Limit	Factor	Remark	Pol/Phase
	MHz	dBm/m	dBm	dBm/m	dB	dB/m		
1	3812.000	-49.91	-58.54	-13.00	-36.91	8.63	Peak	Vertical
2 PP	5727.000	-40.48	-52.79	-13.00	-27.48	12.31	Peak	Vertical

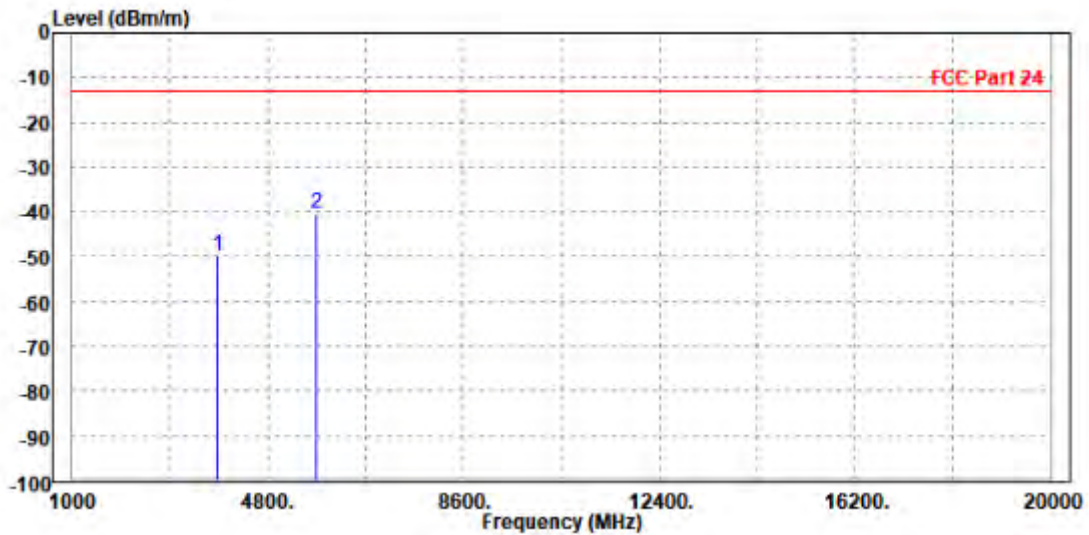



**BUREAU
VERITAS**

Test Report No.: W7L-P24050014RF06

EDGE 1900(Ant0) (UP):

CH 512

MODE	TX channel 512	FREQUENCY RANGE	Above 1000MHz
ENVIRONMENTAL CONDITIONS	23deg. C, 70%RH	INPUT POWER	AC 120V/60HZ
TESTED BY	Jace Hu		
ANTENNA POLARITY & TEST DISTANCE: HORIZONTAL AT 3 M			

	Freq	Level	Read Level	Limit Line	Over Limit	Factor	Remark	Pol/Phase
	MHz	dBm/m	dBm	dBm/m	dB	dB/m		
1	3700.000	-51.62	-60.02	-13.00	-38.62	8.40	Peak	Horizontal
2 PP	5541.000	-46.69	-58.49	-13.00	-33.69	11.80	Peak	Horizontal

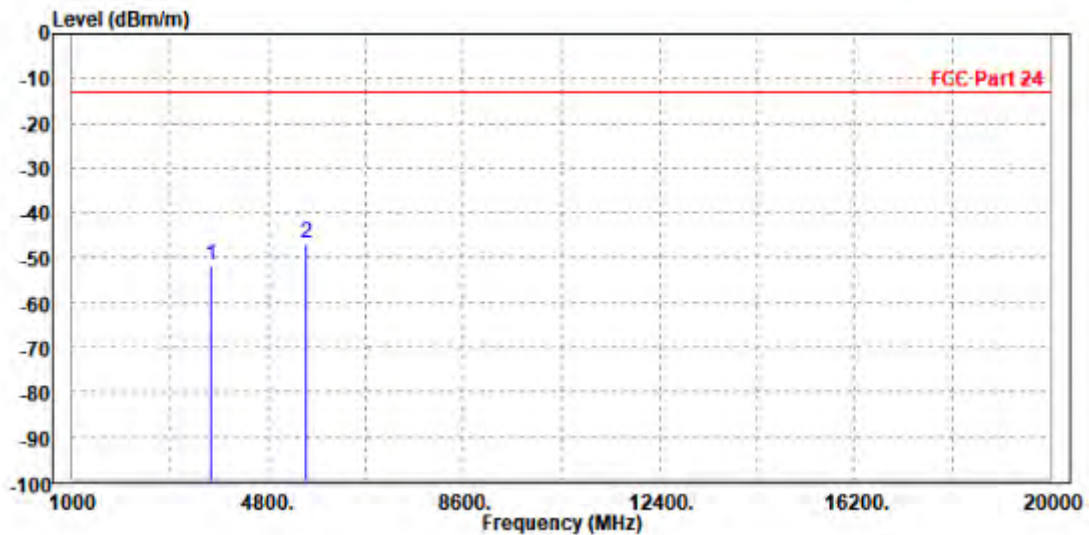



BUREAU VERITAS

Test Report No.: W7L-P24050014RF06

MODE	TX channel 512	FREQUENCY RANGE	Above 1000MHz
ENVIRONMENTAL CONDITIONS	23deg. C, 70%RH	INPUT POWER	AC 120V/60HZ
TESTED BY	Jace Hu		
ANTENNA POLARITY & TEST DISTANCE: VERTICAL AT 3 M			

	Freq	Level	Read Level	Limit Line	Over Limit	Factor	Remark	Pol/Phase
	MHz	dBm/m	dBm	dBm/m	dB	dB/m		
1	3698.000	-51.17	-59.80	-13.00	-38.17	8.63	Peak	Vertical
2 PP	5550.000	-49.99	-62.32	-13.00	-36.99	12.33	Peak	Vertical

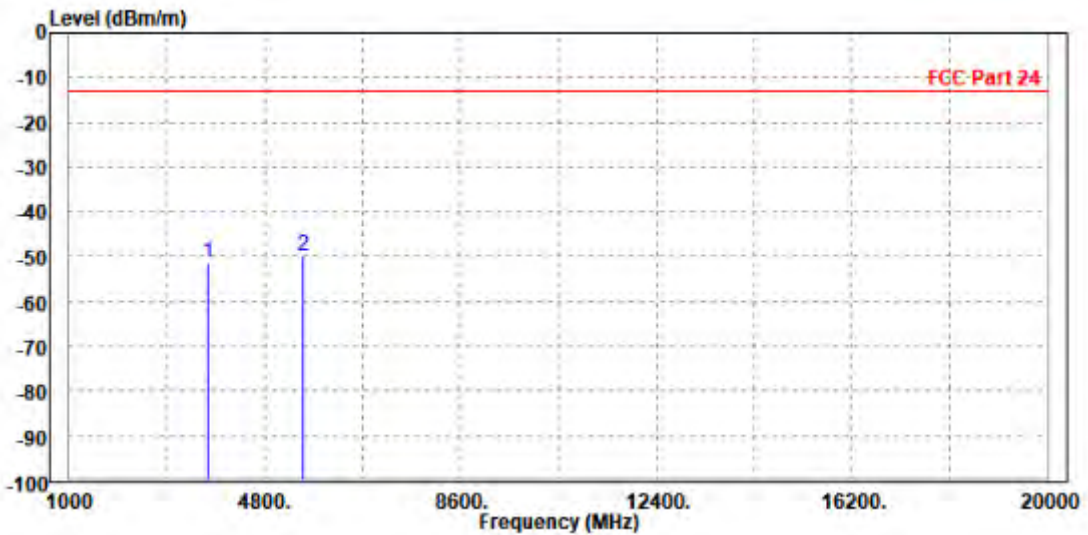



BUREAU VERITAS

Test Report No.: W7L-P24050014RF06

CH 661

MODE	TX channel 661	FREQUENCY RANGE	Above 1000MHz
ENVIRONMENTAL CONDITIONS	23deg. C, 70%RH	INPUT POWER	AC 120V/60HZ
TESTED BY	Jace Hu		
ANTENNA POLARITY & TEST DISTANCE: HORIZONTAL AT 3 M			

	Freq	Level	Read Level	Limit Line	Over Limit	Factor	Remark	Pol/Phase
	MHz	dBm/m	dBm	dBm/m	dB	dB/m		
1	3755.000	-52.25	-60.61	-13.00	-39.25	8.36	Peak	Horizontal
2 PP	5640.000	-43.34	-55.15	-13.00	-30.34	11.81	Peak	Horizontal

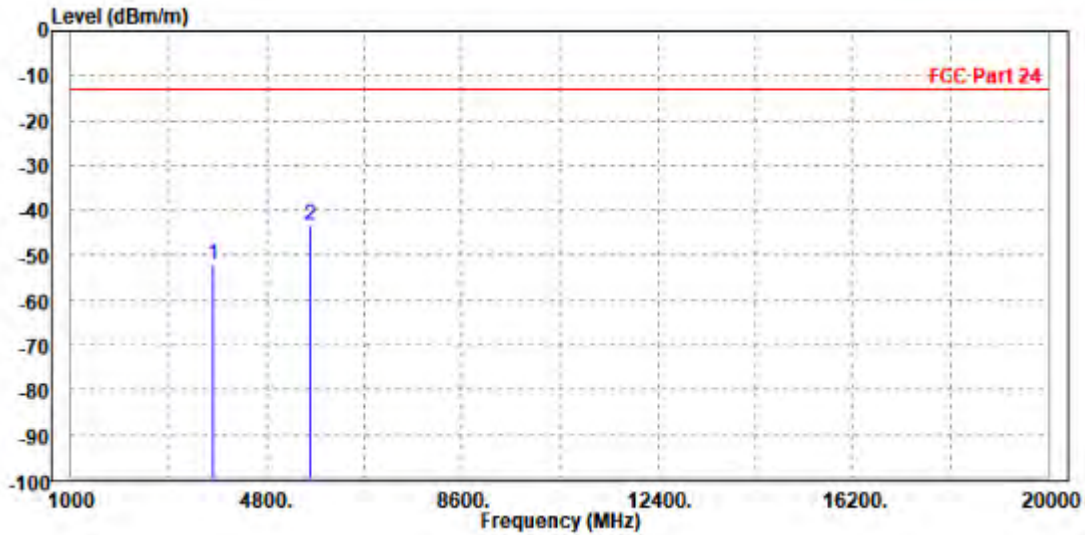



**BUREAU
VERITAS**

Test Report No.: W7L-P24050014RF06

MODE	TX channel 661	FREQUENCY RANGE	Above 1000MHz
ENVIRONMENTAL CONDITIONS	23deg. C, 70%RH	INPUT POWER	AC 120V/60HZ
TESTED BY	Jace Hu		
ANTENNA POLARITY & TEST DISTANCE: VERTICAL AT 3 M			

	Freq	Level	Read Level	Limit Line	Over Limit	Factor	Remark	Pol/Phase
	MHz	dBm/m	dBm	dBm/m	dB	dB/m		
1	3760.000	-52.43	-61.06	-13.00	-39.43	8.63	Peak	Vertical
2 PP	5640.000	-48.01	-60.33	-13.00	-35.01	12.32	Peak	Vertical

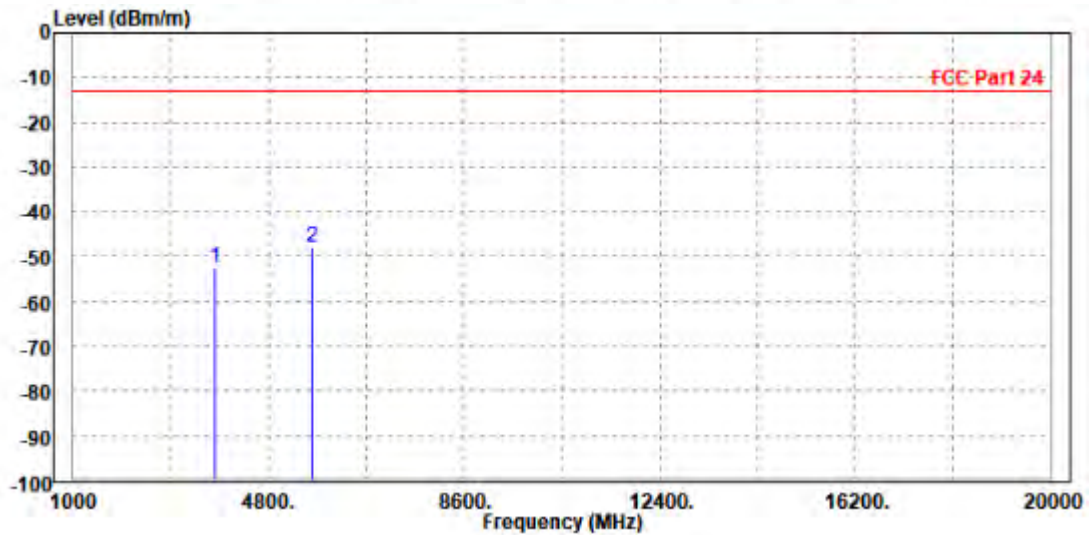



**BUREAU
VERITAS**

Test Report No.: W7L-P24050014RF06

CH 810

MODE	TX channel 810	FREQUENCY RANGE	Above 1000MHz
ENVIRONMENTAL CONDITIONS	23deg. C, 70%RH	INPUT POWER	AC 120V/60HZ
TESTED BY	Jace Hu		
ANTENNA POLARITY & TEST DISTANCE: HORIZONTAL AT 3 M			

	Freq	Level	Read Level	Limit Line	Over Limit	Factor	Remark	Pol/Phase
	MHz	dBm/m	dBm	dBm/m	dB	dB/m		
1	PP 3818.000	-50.31	-58.62	-13.00	-37.31	8.31	Peak	Horizontal
2	5727.000	-51.12	-62.94	-13.00	-38.12	11.82	Peak	Horizontal

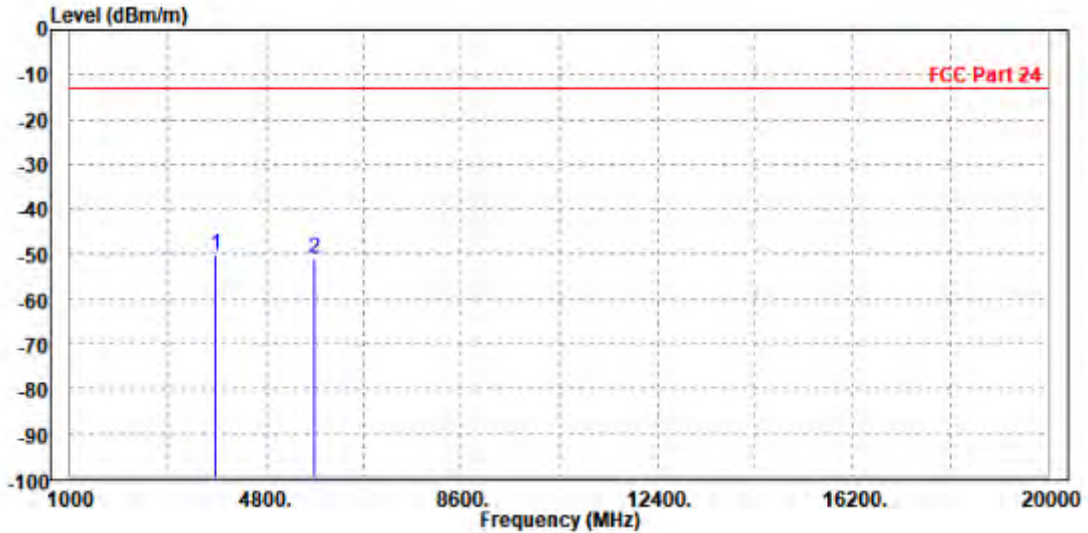



**BUREAU
VERITAS**

Test Report No.: W7L-P24050014RF06

MODE	TX channel 810	FREQUENCY RANGE	Above 1000MHz
ENVIRONMENTAL CONDITIONS	23deg. C, 70%RH	INPUT POWER	AC 120V/60HZ
TESTED BY	Jace Hu		
ANTENNA POLARITY & TEST DISTANCE: VERTICAL AT 3 M			

	Freq	Level	Read Level	Limit Line	Over Limit	Factor	Remark	Pol/Phase
	MHz	dBm/m	dBm	dBm/m	dB	dB/m		
1	3812.000	-51.14	-59.77	-13.00	-38.14	8.63	Peak	Vertical
2 PP	5727.000	-49.75	-62.06	-13.00	-36.75	12.31	Peak	Vertical

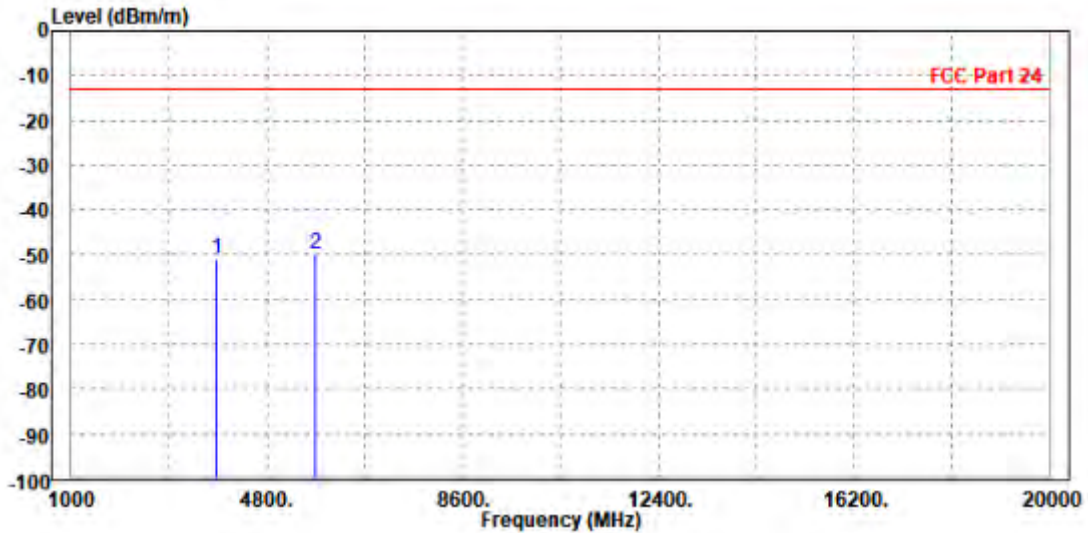



**BUREAU
VERITAS**

Test Report No.: W7L-P24050014RF06

WCDMA Band II(Ant0) (UP):

CH 9262

MODE	TX channel 9262	FREQUENCY RANGE	Above 1000MHz
ENVIRONMENTAL CONDITIONS	23deg. C, 70%RH	INPUT POWER	AC 120V/60HZ
TESTED BY	Jace Hu		
ANTENNA POLARITY & TEST DISTANCE: HORIZONTAL AT 3 M			

	Freq	Level	Read Level	Limit Line	Over Limit	Factor	Remark	Pol/Phase
	MHz	dBm/m	dBm	dBm/m	dB	dB/m		
1	3704.800	-50.35	-58.75	-13.00	-37.35	8.40	Peak	Horizontal
2 PP	5560.000	-49.05	-60.85	-13.00	-36.05	11.80	Peak	Horizontal

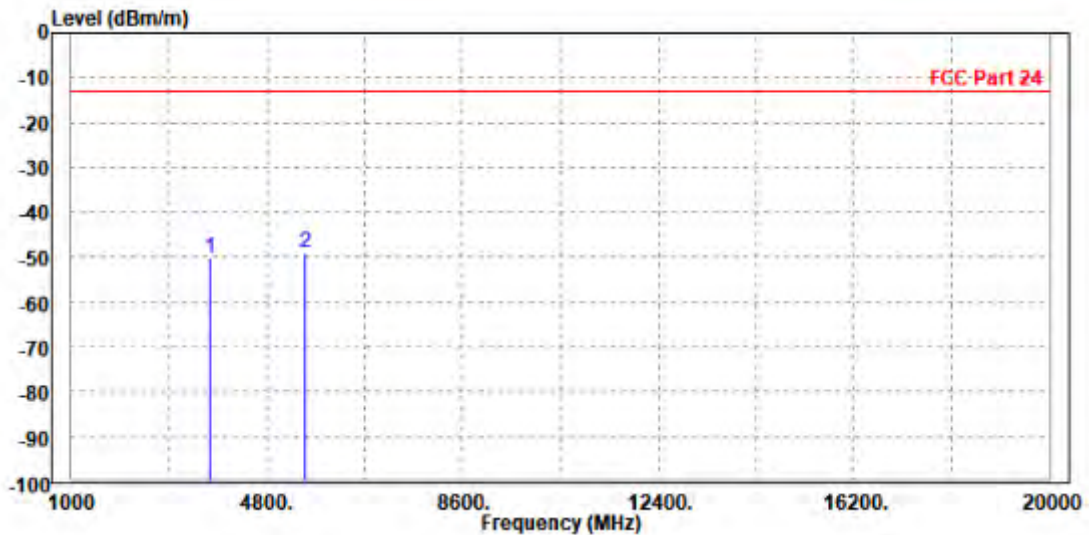



**BUREAU
VERITAS**

Test Report No.: W7L-P24050014RF06

MODE	TX channel 9262	FREQUENCY RANGE	Above 1000MHz
ENVIRONMENTAL CONDITIONS	23deg. C, 70%RH	INPUT POWER	AC 120V/60HZ
TESTED BY	Jace Hu		
ANTENNA POLARITY & TEST DISTANCE: VERTICAL AT 3 M			

	Freq	Level	Read Level	Limit Line	Over Limit	Factor	Remark	Pol/Phase
	MHz	dBm/m	dBm	dBm/m	dB	dB/m		
1	3698.000	-51.38	-60.01	-13.00	-38.38	8.63	Peak	Vertical
2 PP	5557.200	-49.27	-61.60	-13.00	-36.27	12.33	Peak	Vertical

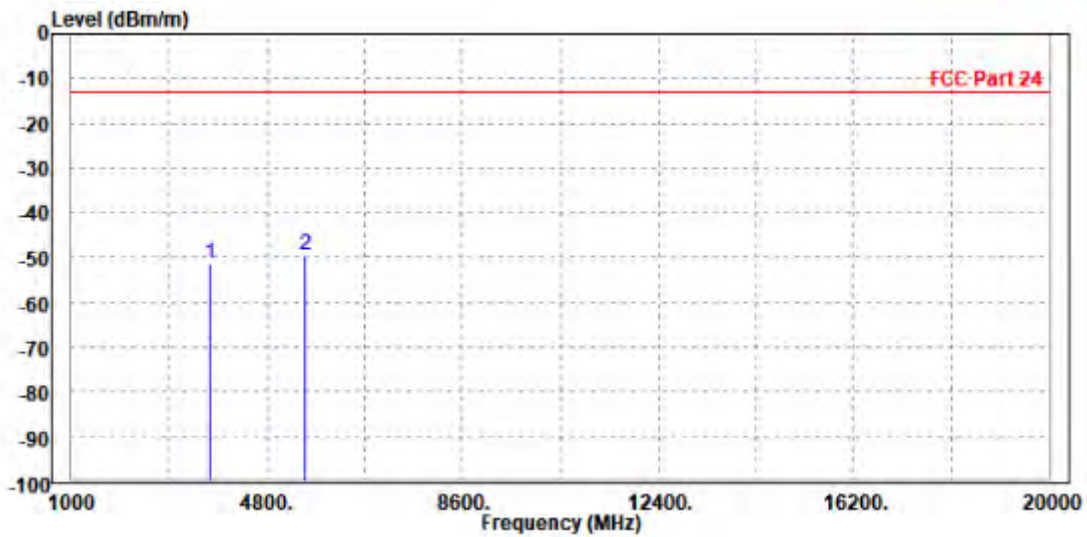



**BUREAU
VERITAS**

Test Report No.: W7L-P24050014RF06

CH 9400

MODE	TX channel 9400	FREQUENCY RANGE	Above 1000MHz
ENVIRONMENTAL CONDITIONS	23deg. C, 70%RH	INPUT POWER	AC 120V/60HZ
TESTED BY	Jace Hu		
ANTENNA POLARITY & TEST DISTANCE: HORIZONTAL AT 3 M			

	Freq	Level	Read Level	Limit Line	Over Limit	Factor	Remark	Pol/Phase
	MHz	dBm/m	dBm	dBm/m	dB	dB/m		
1	3755.000	-51.32	-59.68	-13.00	-38.32	8.36	Peak	Horizontal
2 PP	5640.000	-50.02	-61.83	-13.00	-37.02	11.81	Peak	Horizontal

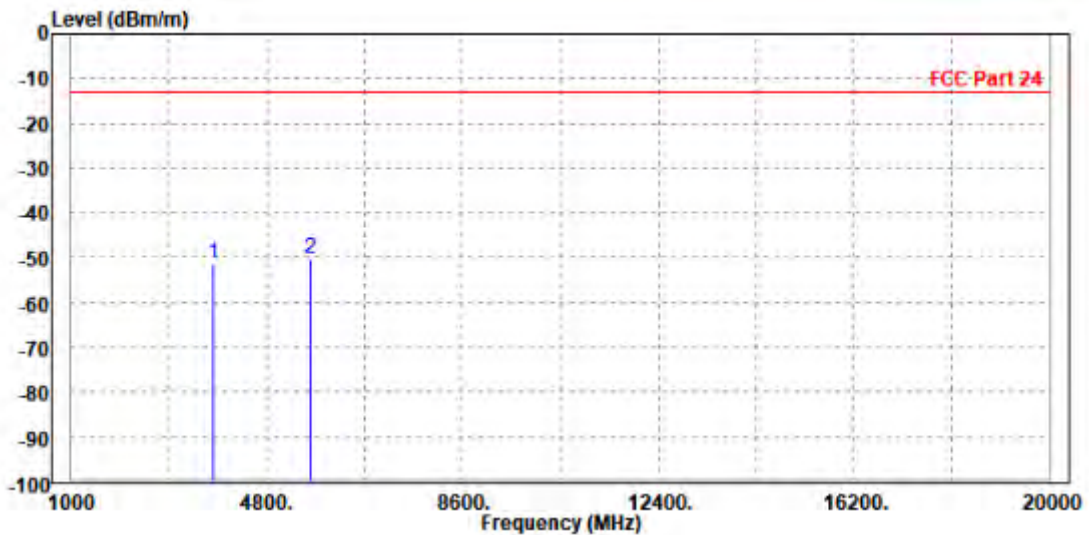



**BUREAU
VERITAS**

Test Report No.: W7L-P24050014RF06

MODE	TX channel 9400	FREQUENCY RANGE	Above 1000MHz
ENVIRONMENTAL CONDITIONS	23deg. C, 70%RH	INPUT POWER	AC 120V/60HZ
TESTED BY	Jace Hu		
ANTENNA POLARITY & TEST DISTANCE: VERTICAL AT 3 M			

	Freq	Level	Read Level	Limit Line	Over Limit	Factor	Remark	Pol/Phase
	MHz	dBm/m	dBm	dBm/m	dB	dB/m		
1	3760.000	-50.82	-59.45	-13.00	-37.82	8.63	Peak	Vertical
2 PP	5636.000	-48.03	-60.35	-13.00	-35.03	12.32	Peak	Vertical

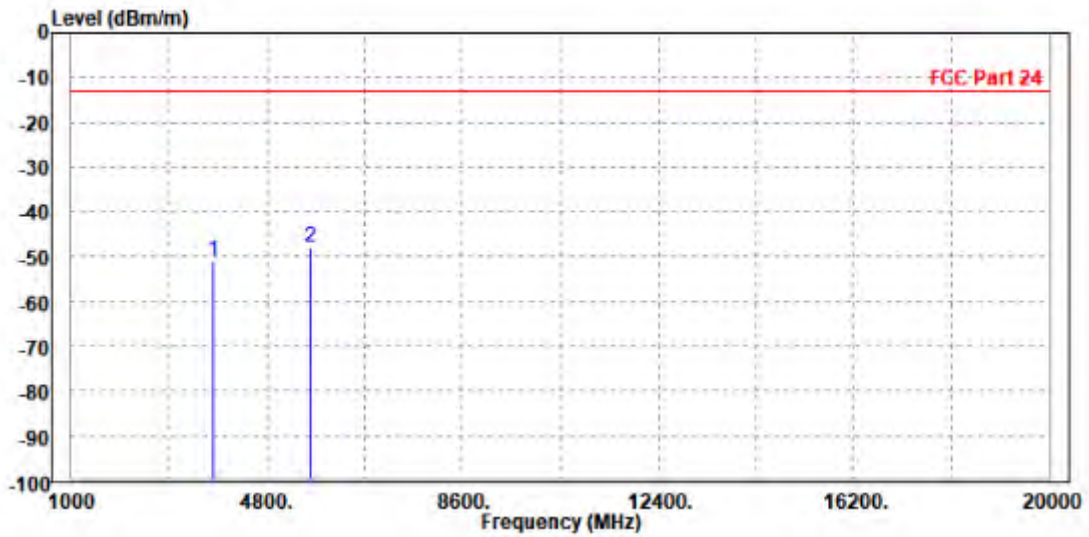



**BUREAU
VERITAS**

Test Report No.: W7L-P24050014RF06

CH 9538

MODE	TX channel 9538	FREQUENCY RANGE	Above 1000MHz
ENVIRONMENTAL CONDITIONS	23deg. C, 70%RH	INPUT POWER	AC 120V/60HZ
TESTED BY	Jace Hu		
ANTENNA POLARITY & TEST DISTANCE: HORIZONTAL AT 3 M			

	Freq	Level	Read Level	Limit Line	Over Limit	Factor	Remark	Pol/Phase
	MHz	dBm/m	dBm	dBm/m	dB	dB/m		
1	3812.000	-51.21	-59.52	-13.00	-38.21	8.31	Peak	Horizontal
2 PP	5722.800	-50.36	-62.18	-13.00	-37.36	11.82	Peak	Horizontal

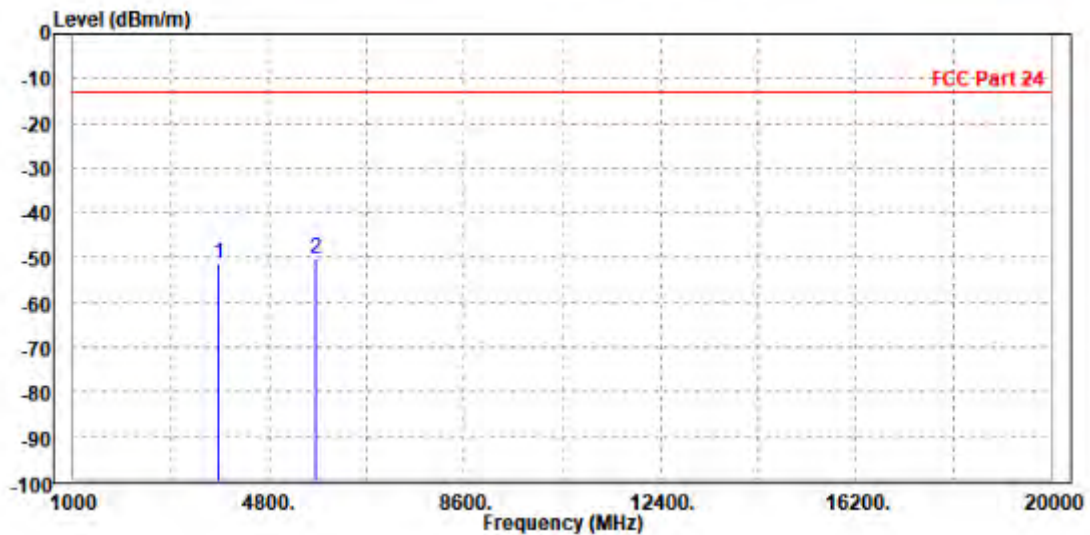



**BUREAU
VERITAS**

Test Report No.: W7L-P24050014RF06

MODE	TX channel 9538	FREQUENCY RANGE	Above 1000MHz
ENVIRONMENTAL CONDITIONS	23deg. C, 70%RH	INPUT POWER	AC 120V/60HZ
TESTED BY	Jace Hu		
ANTENNA POLARITY & TEST DISTANCE: VERTICAL AT 3 M			

	Freq	Level	Read Level	Limit Line	Over Limit	Factor	Remark	Pol/Phase
	MHz	dBm/m	dBm	dBm/m	dB	dB/m		
1	3815.200	-50.03	-58.66	-13.00	-37.03	8.63	Peak	Vertical
2 PP	5731.000	-49.41	-61.72	-13.00	-36.41	12.31	Peak	Vertical

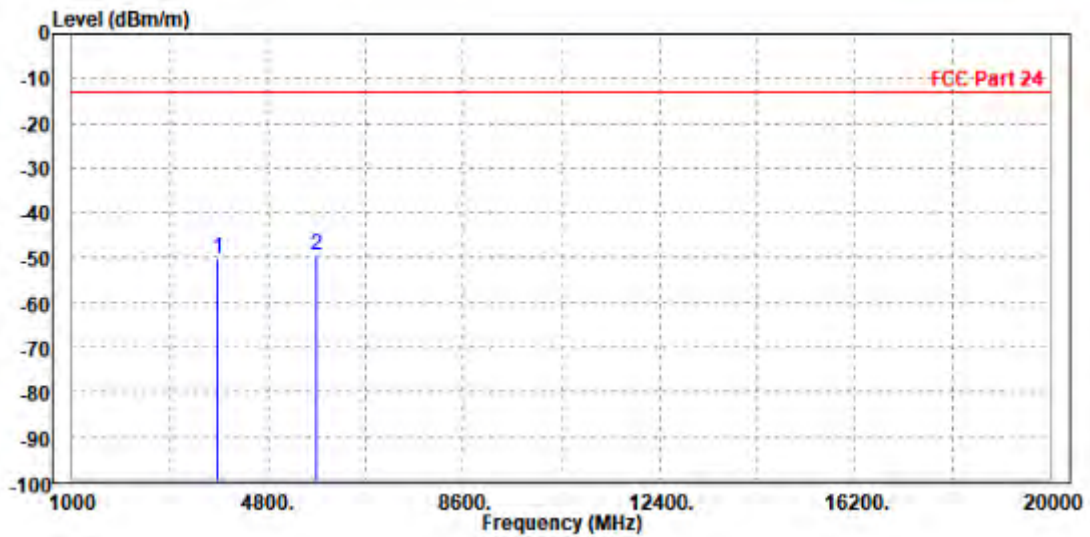



**BUREAU
VERITAS**

Test Report No.: W7L-P24050014RF06

LTE Band 2(Ant0) (UP):

CHANNEL BANDWIDTH: 1.4MHz / QPSK

MODE	TX channel 18900	FREQUENCY RANGE	Above 1000MHz
ENVIRONMENTAL CONDITIONS	23deg. C, 70%RH	INPUT POWER	AC 120V/60Hz
TESTED BY	Jace Hu		
ANTENNA POLARITY & TEST DISTANCE: HORIZONTAL AT 3 M			

	Freq	Level	Read Level	Limit Line	Over Limit	Factor	Remark	Pol/Phase
	MHz	dBm/m	dBm	dBm/m	dB	dB/m		
1	3760.000	-50.63	-58.98	-13.00	-37.63	8.35	Peak	Horizontal
2 PP	5636.000	-49.58	-61.39	-13.00	-36.58	11.81	Peak	Horizontal

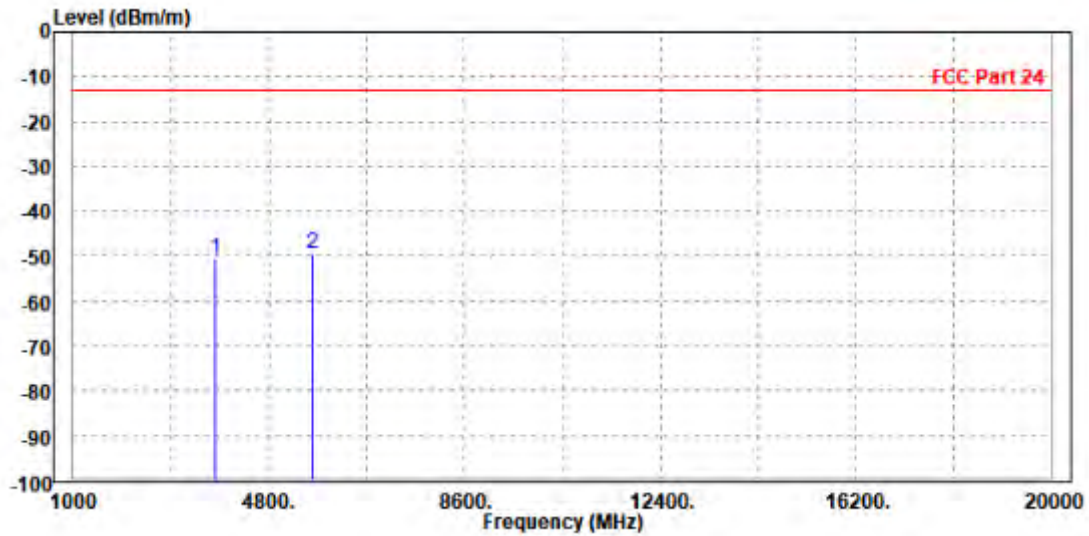



**BUREAU
VERITAS**

Test Report No.: W7L-P24050014RF06

MODE	TX channel 18900	FREQUENCY RANGE	Above 1000MHz
ENVIRONMENTAL CONDITIONS	23deg. C, 70%RH	INPUT POWER	AC 120V/60Hz
TESTED BY	Jace Hu		
ANTENNA POLARITY & TEST DISTANCE: VERTICAL AT 3 M			

	Freq	Level	Read Level	Limit Line	Over Limit	Factor	Remark	Pol/Phase
	MHz	dBm/m	dBm	dBm/m	dB	dB/m		
1	3755.000	-51.24	-59.87	-13.00	-38.24	8.63	Peak	Vertical
2 PP	5640.000	-49.89	-62.21	-13.00	-36.89	12.32	Peak	Vertical

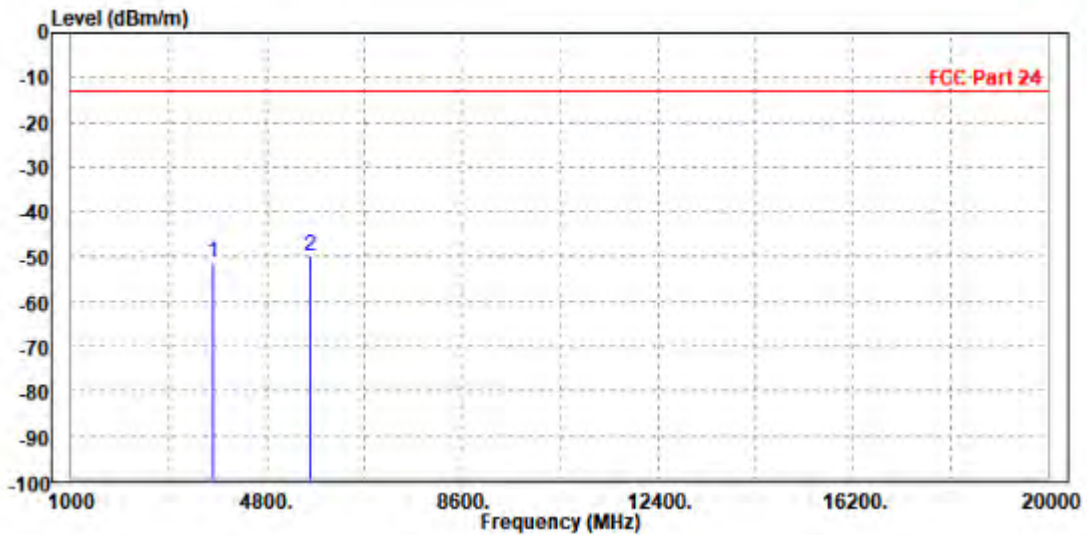



**BUREAU
VERITAS**

Test Report No.: W7L-P24050014RF06

CHANNEL BANDWIDTH: 3MHz / QPSK

MODE	TX channel 18900	FREQUENCY RANGE	Above 1000MHz
ENVIRONMENTAL CONDITIONS	23deg. C, 70%RH	INPUT POWER	AC 120V/60Hz
TESTED BY	Jace Hu		
ANTENNA POLARITY & TEST DISTANCE: HORIZONTAL AT 3 M			

	Freq	Level	Read Level	Limit Line	Over Limit	Factor	Remark	Pol/Phase
	MHz	dBm/m	dBm	dBm/m	dB	dB/m		
1	3755.000	-50.60	-58.96	-13.00	-37.60	8.36	Peak	Horizontal
2 PP	5640.000	-48.67	-60.48	-13.00	-35.67	11.81	Peak	Horizontal

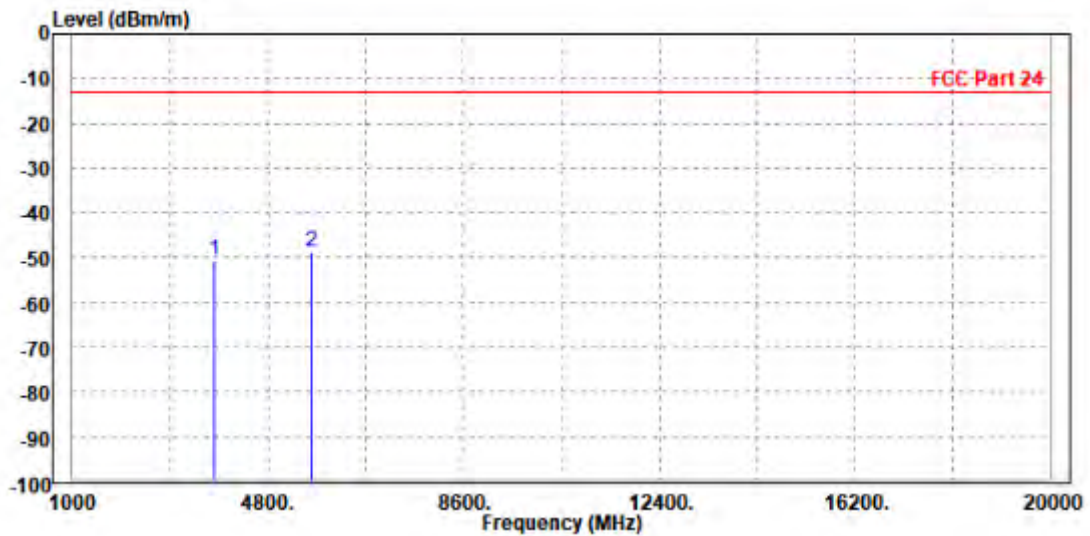



**BUREAU
VERITAS**

Test Report No.: W7L-P24050014RF06

MODE	TX channel 18900	FREQUENCY RANGE	Above 1000MHz
ENVIRONMENTAL CONDITIONS	23deg. C, 70%RH	INPUT POWER	AC 120V/60Hz
TESTED BY	Jace Hu		
ANTENNA POLARITY & TEST DISTANCE: VERTICAL AT 3 M			

	Freq	Level	Read Level	Limit Line	Over Limit	Factor	Remark	Pol/Phase
	MHz	dBm/m	dBm	dBm/m	dB	dB/m		
1	3760.000	-50.18	-58.81	-13.00	-37.18	8.63	Peak	Vertical
2 PP	5636.000	-48.18	-60.50	-13.00	-35.18	12.32	Peak	Vertical

