

Table of Contents

Release Control Record	3
1. Summary of Maximum SAR Value	4
Description of Equipment Under Test.....	5
2. SAR Measurement System	8
3.1 Definition of Specific Absorption Rate (SAR)	8
3.2 SPEAG DASY System	8
3.2.1 Robot.....	9
3.2.2 Probes.....	10
3.2.3 Data Acquisition Electronics (DAE)	10
3.2.4 Phantoms	11
3.2.5 Device Holder.....	12
3.2.6 System Validation Dipoles	12
3.2.7 Tissue Simulating Liquids.....	13
3.3 SAR System Verification	15
3.4 SAR Measurement Procedure	16
3.4.1 Area & Zoom Scan Procedure	16
3.4.2 Volume Scan Procedure.....	16
3.4.3 Power Drift Monitoring.....	17
3.4.4 Spatial Peak SAR Evaluation	17
3.4.5 SAR Averaged Methods	17
3. SAR Measurement Evaluation.....	18
4.1 EUT Configuration and Setting.....	18
4.2 EUT Testing Position.....	58
4.2.1 Head Exposure Conditions.....	58
4.2.2 Body-worn Accessory Exposure Conditions	60
4.2.3 Hotspot Mode Exposure Conditions	61
4.2.4 Extremity Exposure Conditions	62
4.2.5 SAR Text Exclusion Evaluations.....	62
4.3 Tissue Verification	63
4.4 System Verification.....	64
4.5 Maximum Output Power.....	66
4.5.1 Maximum Conducted Power	66
4.5.2 Measured Conducted Power Result.....	66
4.6 SAR Testing Results	66
4.6.1 SAR Test Reduction Considerations	66
4.6.2 SAR Results for Head Exposure Condition	68
4.6.3 SAR Results for Body-worn Exposure Condition (Separation Distance is 1.0 cm Gap).....	80
4.6.4 SAR Results for Hotspot Exposure Condition (Separation Distance is 1.0 cm Gap).....	88
4.6.5 SAR Results for Extremity Exposure Condition (Separation Distance is 0 cm Gap).....	103
4.6.6 SAR Measurement Variability.....	107
4.6.7 Simultaneous Multi-band Transmission Evaluation	108
4. Calibration of Test Equipment.....	109
5. Measurement Uncertainty.....	110
6. Information on the Testing Laboratories	112
Appendix A. SAR Plots of System Verification	
Appendix B. SAR Plots of SAR Measurement	
Appendix C. Calibration Certificate for Probe and Dipole	
Appendix D. Conducted Power Result	
Appendix E. Simultaneous Multi-band Transmission Evaluation	
Appendix F. Photographs of EUT and SAR Setup	

Release Control Record

Report No.	Reason for Change	Date Issued
A240618W001SA02	Initial release	Aug. 24, 2024

1. Summary of Maximum SAR Value

Equipment Class	Mode	Highest Reported Head SAR _{1g} (W/kg)	Highest Reported Body-worn SAR _{1g} (1.0 cm Gap) (W/kg)	Highest Reported Hotspot SAR _{1g} (1.0 cm Gap) (W/kg)	Highest Reported Extremity SAR _{10g} (0 cm Gap) (W/kg)
PCE	GSM850	1.05	0.30	0.30	N/A
	GSM1900	0.78	0.43	1.09	1.96
	WCDMA II	1.03	0.88	1.02	2.44
	WCDMA IV	1.08	0.66	0.89	1.89
	WCDMA V	0.83	0.36	0.36	N/A
	LTE 2	0.76	0.60	0.76	1.80
	LTE 7	1.05	0.58	1.00	2.47
	LTE 12 / 17	0.97	0.30	0.45	N/A
	LTE 13	0.84	0.25	0.27	N/A
	LTE 26 / 5	0.77	0.41	0.41	N/A
	LTE 38	1.03	0.57	0.79	1.79
	LTE 41	0.98	0.55	0.70	2.02
	LTE 42(Part27Q)	1.07	0.56	0.95	2.55
	LTE 48 / 42	0.99	0.76	0.88	1.94
	LTE 66 / 4	0.68	0.57	0.66	2.26
	NR Band n2	1.04	0.71	0.94	2.25
	NR Band n7	1.03	0.60	0.84	2.30
	NR Band n12	0.92	0.24	0.24	N/A
	NR Band n26 / 5	0.83	0.47	0.47	N/A
	NR Band n38	0.97	0.62	0.90	2.33
NR Band n41	1.07	0.65	0.99	2.59	
NR Band n48	0.99	1.08	1.08	2.34	
NR Band n66	0.96	0.78	0.93	2.56	
NR Band n77/78	1.06	0.97	0.97	2.45	
DTS	WLAN2.4G	0.34	0.23	0.28	N/A
NII	WLAN5.2G	N/A	N/A	0.17	N/A
	WLAN5.3G	0.39	0.18	N/A	0.73
	WLAN5.5G	0.34	0.20	N/A	0.84
	WLAN5.8G	0.27	0.24	0.33	N/A
DSS	BT	0.20	0.04	0.06	N/A
DXX	NFC	N/A	N/A	N/A	N/A
Highest Simultaneous Transmission SAR		Head (W/kg)	Body-worn (W/kg)	Hotspot (W/kg)	Extremity (W/kg)
		1.57	1.36	1.45	3.43

Note:

- The SAR limit (Head & Body: SAR_{1g} 1.6 W/kg, Extremity: SAR_{10g} 4.0 W/kg) for general population / uncontrolled exposure is specified in FCC 47 CFR part 2 (2.1093) and ANSI/IEEE C95.1-1992.

Description of Equipment Under Test

EUT Type	Mobile Phone
FCC ID	2AFZZRAD4G
Brand Name	Redmi
Model Name	24094RAD4G
IMEI Code	Sample1: 861781070034825 / 861781070034833 Sample2: 861781070040723 / 861781070040731 Sample3: 861781070041341 / 861781070041358
HW Version	13510O17P
SW Version	Xiaomi HyperOS 1.0
Tx Frequency Bands (Unit: MHz)	GSM850 : 824 ~ 849 GSM1900 : 1850 ~ 1910 WCDMA Band II : 1850 ~ 1910 WCDMA Band IV : 1710 ~ 1755 WCDMA Band V : 824 ~ 849 LTE Band 2 : 1850 ~ 19010 LTE Band 4 : 1710 ~ 1755 LTE Band 5 : 824 ~ 849 LTE Band 7 : 2500 ~ 2570 LTE Band 12 : 699 ~ 716 LTE Band 13 : 777 ~ 787 LTE Band 17 : 704 ~ 716 LTE Band 26 : 814 ~ 849 LTE Band 38 : 2570 ~ 2620 LTE Band 41 : 2496 ~ 2690 LTE Band 42 : 3450 ~ 3550, 3550 ~ 3600 LTE Band 48 : 3550 ~ 3700 LTE Band 66 : 1710 ~ 1780 NR Band n2 : 1850 ~ 1910 NR Band n5 : 824 ~ 849 NR Band n7 : 2500 ~ 2570 NR Band n26 : 814 ~ 849 NR Band n38 : 2570 ~ 2620 NR Band n41 : 2496 ~ 2690 NR Band n48 : 3550 ~ 3700 NR Band n66 : 1710 ~ 1780 NR Band n77 : 3450 ~ 3550, 3700 ~ 3980 NR Band n78 : 3450 ~ 3550 WLAN : 2412 ~ 2462, 5180 ~ 5240, 5260 ~ 5320, 5500 ~ 5700, 5745 ~ 5825 Bluetooth : 2402 ~ 2480 NFC : 13.56
Uplink Modulations	GSM & GPRS & EDGE : GMSK, 8PSK WCDMA : QPSK LTE : QPSK, 16QAM, 64QAM NR : Pi/2 BPSK (DFT-s-OFDM), QPSK (DFT-s-OFDM, CP-OFDM), 16QAM (DFT-s-OFDM, CP-OFDM), 64QAM (DFT-s-OFDM, CP-OFDM), 256QAM (DFT-s-OFDM, CP-OFDM) 802.11b : DSSS 802.11a/g/n/ac : OFDM Bluetooth : GFSK, $\pi/4$ -DQPSK, 8-DPSK, LE NFC : ASK
Subcarrier Spacing	15 kHz (FDD) / 30 kHz (TDD)
Uplink Transmission Duty Cycle	For 5GNR TDD PC2 Maximum Duty Cycle is 50%, using FTM (Factory Test Mode) with 50% duty cycle is considered during testing. For 5G NR other bands test, using FTM (Factory Test Mode) with default 100% duty cycle transmission to perform evaluation.
NR Anchor Band for LTE Band 2	NR Band n66/n77/n78
NR Anchor Band for LTE Band 4	NR Band n7/n38/n41/n78
NR Anchor Band for LTE Band 5	NR Band n7/n66/n78
NR Anchor Band for LTE Band 7	NR Band n5/n7/n66/n78
NR Anchor Band for LTE Band 26	NR Band n78
NR Anchor Band for LTE Band 38	NR Band n78

NR Anchor Band for LTE Band 41	NR Band n41/n78
NR Anchor Band for LTE Band 66	NR Band n7/n38/n41/n66/n78
Maximum Tune-up Conducted Power (Unit: dBm)	Please refer to section 4.5.1 of this report.
Antenna Type	PIFA Antenna
EUT Stage	Identical Prototype

Note:

1. The above EUT information is declared by manufacturer and for more detailed features description please refers to the manufacturer's specifications or User's Manual.
2. This device supports both LTE B4/5/17/42 and B12/26/48/66. Since the supported frequency span for LTE B4/5/17/42 falls completely within the LTE B12/26/48/66, they have the same target power, and share the same transmission path, therefore SAR was only assessed for B12/26/48/66.
3. The SAR of LTE Band 42 (3550MHz ~ 3600MHz) is covered by LTE Band 48 due to same power level with repeated frequency range.
4. This device supports both NR Band n5/78 and NR Band n26/77. Since the supported frequency span for NR Band n5/78 falls completely within the NR Band n26/77, they have the same target power, and share the same transmission path, therefore SAR was only assessed for NR Band n26/77.
5. The difference between sample 1/2/3 is only the memory size and screen supplier, battery supplier, so sample 2/3 verifies the worst case of sample 1.
6. For WWAN and WLAN antennas, when the audio is actively routed through the earpiece receiver on head exposure condition, power reduction will be activated to limit the maximum power.
7. For WWAN antenna, when the SAR sensor is detected close to the body sate, power reduction will be activated to limit the maximum power. Proximity sensor triggering distances please refer to section 4.1 of this report.

SAR test scenarios:

WWAN Ant 1 scenarios:

Power State	SAR Test Scenarios	Receiver	SAR Sensor
Full Power	N/A	Off	Off
DSI-1	Head	On	Off
DSI-2	Body-Worn / Lmibs	Off	Off
DSI-3/DSI-4	Body-Worn / Lmibs	Off	On

WWAN Ant 2/3/4/5 scenarios:

Power State	SAR Test Scenarios	Receiver	SAR Sensor
Full Power	N/A	Off	Off
DSI-1	Head	On	Off
DSI-2	Body-Worn / Lmibs	Off	Off
DSI-4	Body-Worn / Lmibs	Off	On

WWAN Ant 7 scenarios:

Power State	SAR Test Scenarios	Receiver
Full Power	N/A	Off
DSI-1	Head	On
DSI-2	Body-Worn / Lmibs	Off

WLAN Ant 6 scenarios:

Power State	SAR Test Scenarios	Receiver
Full Power	N/A	Off
DSI-1	Head	On
DSI-2	Body-Worn / Lmibs	Off

2. SAR Measurement System

3.1 Definition of Specific Absorption Rate (SAR)

SAR is related to the rate at which energy is absorbed per unit mass in an object exposed to a radio field. The SAR distribution in a biological body is complicated and is usually carried out by experimental techniques or numerical modeling. The standard recommends limits for two tiers of groups, occupational/controlled and general population/uncontrolled, based on a person's awareness and ability to exercise control over his or her exposure. In general, occupational/controlled exposure limits are higher than the limits for general population/uncontrolled.

The SAR definition is the time derivative (rate) of the incremental energy (dW) absorbed by (dissipated in) an incremental mass (dm) contained in a volume element (dv) of a given density (ρ). The equation description is as below:

$$\text{SAR} = \frac{d}{dt} \left(\frac{dW}{dm} \right) = \frac{d}{dt} \left(\frac{dW}{\rho dv} \right)$$

SAR is expressed in units of Watts per kilogram (W/kg)

SAR measurement can be related to the electrical field in the tissue by

$$\text{SAR} = \frac{\sigma |E|^2}{\rho}$$

Where: σ is the conductivity of the tissue, ρ is the mass density of the tissue and E is the RMS electrical field strength.

3.2 SPEAG DASY System

DASY system consists of high precision robot, probe alignment sensor, phantom, robot controller, controlled measurement server and near-field probe. The robot includes six axes that can move to the precision position of the DASY5 software defined. The DASY software can define the area that is detected by the probe. The robot is connected to controlled box. Controlled measurement server is connected to the controlled robot box. The DAE includes amplifier, signal multiplexing, AD converter, offset measurement and surface detection. It is connected to the Electro-optical coupler (ECO). The ECO performs the conversion from the optical into digital electric signal of the DAE and transfers data to the PC.

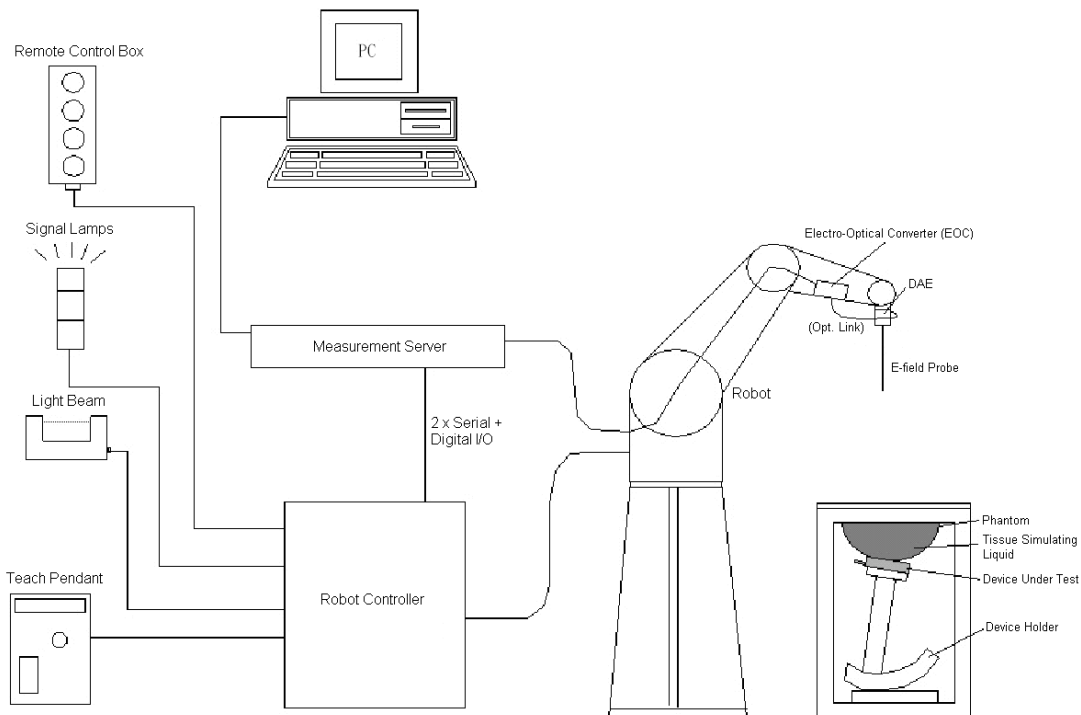

Fig-3.1 DASY System Setup

3.2.1 Robot

The DASY system uses the high precision robots from Stäubli SA (France). For the 6-axis controller system, the robot controller version (DASY6 : CS8c) from Stäubli is used. The Stäubli robot series have many features that are important for our application:

- High precision (repeatability ± 0.035 mm)
- High reliability (industrial design)
- Jerk-free straight movements
- Low ELF interference (the closed metallic construction shields against motor control fields)



Fig-3.2 DASY6

3.2.2 Probes

The SAR measurement is conducted with the dosimetric probe. The probe is specially designed and calibrated for use in liquid with high permittivity. The dosimetric probe has special calibration in liquid at different frequency.

Model	EX3DV4	
Construction	Symmetrical design with triangular core. Built-in shielding against static charges. PEEK enclosure material (resistant to organic solvents, e.g., DGBE).	
Frequency	10 MHz to 6 GHz Linearity: ± 0.2 dB	
Directivity	± 0.3 dB in HSL (rotation around probe axis) ± 0.5 dB in tissue material (rotation normal to probe axis)	
Dynamic Range	10 μ W/g to 100 mW/g Linearity: ± 0.2 dB (noise: typically < 1 μ W/g)	
Dimensions	Overall length: 337 mm (Tip: 20 mm) Tip diameter: 2.5 mm (Body: 12 mm) Typical distance from probe tip to dipole centers: 1 mm	

Model	ES3DV3	
Construction	Symmetrical design with triangular core. Interleaved sensors. Built-in shielding against static charges. PEEK enclosure material (resistant to organic solvents, e.g., DGBE).	
Frequency	10 MHz to 4 GHz Linearity: ± 0.2 dB	
Directivity	± 0.2 dB in HSL (rotation around probe axis) ± 0.3 dB in tissue material (rotation normal to probe axis)	
Dynamic Range	5 μ W/g to 100 mW/g Linearity: ± 0.2 dB	
Dimensions	Overall length: 337 mm (Tip: 20 mm) Tip diameter: 3.9 mm (Body: 12 mm) Distance from probe tip to dipole centers: 2.0 mm	

3.2.3 Data Acquisition Electronics (DAE)

Model	DAE3, DAE4	
Construction	Signal amplifier, multiplexer, A/D converter and control logic. Serial optical link for communication with DASY embedded system (fully remote controlled). Two step probe touch detector for mechanical surface detection and emergency robot stop.	
Measurement Range	-100 to +300 mV (16 bit resolution and two range settings: 4mV, 400mV)	
Input Offset Voltage	< 5 μ V (with auto zero)	
Input Bias Current	< 50 fA	
Dimensions	60 x 60 x 68 mm	

3.2.4 Phantoms

Model	Twin SAM	
Construction	The shell corresponds to the specifications of the Specific Anthropomorphic Mannequin (SAM) phantom defined in IEEE 1528 and IEC 62209-1. It enables the dosimetric evaluation of left and right hand phone usage as well as body mounted usage at the flat phantom region. A cover prevents evaporation of the liquid. Reference markings on the phantom allow the complete setup of all predefined phantom positions and measurement grids by teaching three points with the robot.	
Material	Vinylester, glass fiber reinforced (VE-GF)	
Shell Thickness	2 ± 0.2 mm (6 ± 0.2 mm at ear point)	
Dimensions	Length: 1000 mm Width: 500 mm Height: adjustable feet	
Filling Volume	approx. 25 liters	

Model	ELI	
Construction	Phantom for compliance testing of handheld and body-mounted wireless devices in the frequency range of 30 MHz to 6 GHz. ELI is fully compatible with the IEC 62209-2 standard and all known tissue simulating liquids. ELI has been optimized regarding its performance and can be integrated into our standard phantom tables. A cover prevents evaporation of the liquid. Reference markings on the phantom allow installation of the complete setup, including all predefined phantom positions and measurement grids, by teaching three points. The phantom is compatible with all SPEAG dosimetric probes and dipoles.	
Material	Vinylester, glass fiber reinforced (VE-GF)	
Shell Thickness	2.0 ± 0.2 mm (bottom plate)	
Dimensions	Major axis: 600 mm Minor axis: 400 mm	
Filling Volume	approx. 30 liters	

3.2.5 Device Holder

Model	Mounting Device	
Construction	In combination with the Twin SAM Phantom or ELI4, the Mounting Device enables the rotation of the mounted transmitter device in spherical coordinates. Rotation point is the ear opening point. Transmitter devices can be easily and accurately positioned according to IEC, IEEE, FCC or other specifications. The device holder can be locked for positioning at different phantom sections (left head, right head, flat).	
Material	POM	

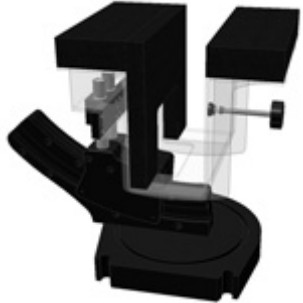
Model	Laptop Extensions Kit	
Construction	Simple but effective and easy-to-use extension for Mounting Device that facilitates the testing of larger devices according to IEC 62209-2 (e.g., laptops, cameras, etc.). It is lightweight and fits easily on the upper part of the Mounting Device in place of the phone positioner.	
Material	POM, Acrylic glass, Foam	

3.2.6 System Validation Dipoles

Model	D-Serial	
Construction	Symmetrical dipole with 1/4 balun. Enables measurement of feed point impedance with NWA. Matched for use near flat phantoms filled with tissue simulating solutions.	
Frequency	750 MHz to 5800 MHz	
Return Loss	> 20 dB	
Power Capability	> 100 W (f < 1GHz), > 40 W (f > 1GHz)	

3.2.7 Tissue Simulating Liquids

For SAR measurement of the field distribution inside the phantom, the phantom must be filled with homogeneous tissue simulating liquid to a depth of at least 15 cm. For head SAR testing, the liquid height from the ear reference point (ERP) of the phantom to the liquid top surface is larger than 15 cm. For body SAR testing, the liquid height from the center of the flat phantom to the liquid top surface is larger than 15 cm. The nominal dielectric values of the tissue simulating liquids in the phantom and the tolerance of 5% are listed in Table-3.1.

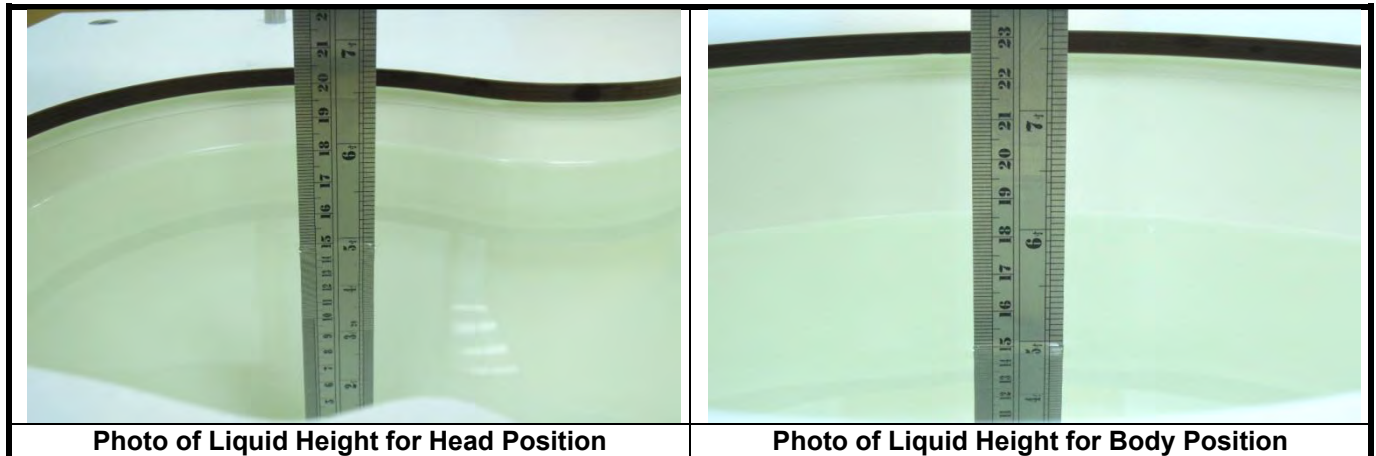

The dielectric properties of the head tissue simulating liquids are defined in IEEE 1528, and KDB 865664 D01 Appendix A. For the body tissue simulating liquids, the dielectric properties are defined in KDB 865664 D01 Appendix A. The dielectric properties of the tissue simulating liquids were verified prior to the SAR evaluation using a dielectric assessment kit and a network analyzer.

Table-3.1 Targets of Tissue Simulating Liquid

Frequency (MHz)	Target Permittivity	Range of $\pm 5\%$	Target Conductivity	Range of $\pm 5\%$
For Head				
750	41.9	39.8 ~ 44.0	0.89	0.85 ~ 0.93
835	41.5	39.4 ~ 43.6	0.90	0.86 ~ 0.95
900	41.5	39.4 ~ 43.6	0.97	0.92 ~ 1.02
1450	40.5	38.5 ~ 42.5	1.20	1.14 ~ 1.26
1640	40.3	38.3 ~ 42.3	1.29	1.23 ~ 1.35
1750	40.1	38.1 ~ 42.1	1.37	1.30 ~ 1.44
1800	40.0	38.0 ~ 42.0	1.40	1.33 ~ 1.47
1900	40.0	38.0 ~ 42.0	1.40	1.33 ~ 1.47
2000	40.0	38.0 ~ 42.0	1.40	1.33 ~ 1.47
2300	39.5	37.5 ~ 41.5	1.67	1.59 ~ 1.75
2450	39.2	37.2 ~ 41.2	1.80	1.71 ~ 1.89
2600	39.0	37.1 ~ 41.0	1.96	1.86 ~ 2.06
3500	37.9	36.0 ~ 39.8	2.91	2.76 ~ 3.06
5200	36.0	34.2 ~ 37.8	4.66	4.43 ~ 4.89
5300	35.9	34.1 ~ 37.7	4.76	4.52 ~ 5.00
5500	35.6	33.8 ~ 37.4	4.96	4.71 ~ 5.21
5600	35.5	33.7 ~ 37.3	5.07	4.82 ~ 5.32
5800	35.3	33.5 ~ 37.1	5.27	5.01 ~ 5.53

The following table gives the recipes for tissue simulating liquids.

Table-3.2 Recipes of Tissue Simulating Liquid

Tissue Type	Bactericide	DGBE	HEC	NaCl	Sucrose	Triton X-100	Water	Diethylene Glycol Mono-hexylether
H750	0.2	-	0.2	1.5	56.0	-	42.1	-
H835	0.2	-	0.2	1.5	57.0	-	41.1	-
H900	0.2	-	0.2	1.4	58.0	-	40.2	-
H1450	-	43.3	-	0.6	-	-	56.1	-
H1640	-	45.8	-	0.5	-	-	53.7	-
H1750	-	47.0	-	0.4	-	-	52.6	-
H1800	-	44.5	-	0.3	-	-	55.2	-
H1900	-	44.5	-	0.2	-	-	55.3	-
H2000	-	44.5	-	0.1	-	-	55.4	-
H2300	-	44.9	-	0.1	-	-	55.0	-
H2450	-	45.0	-	0.1	-	-	54.9	-
H2600	-	45.1	-	0.1	-	-	54.8	-
H3500	-	28.0	-	0.2	-	20.0	71.8	-
H5G	-	-	-	-	-	17.2	65.5	17.3

3.3 SAR System Verification

The system check verifies that the system operates within its specifications. It is performed daily or before every SAR measurement. The system check uses normal SAR measurements in the flat section of the phantom with a matched dipole at a specified distance. The system verification setup is shown as below.

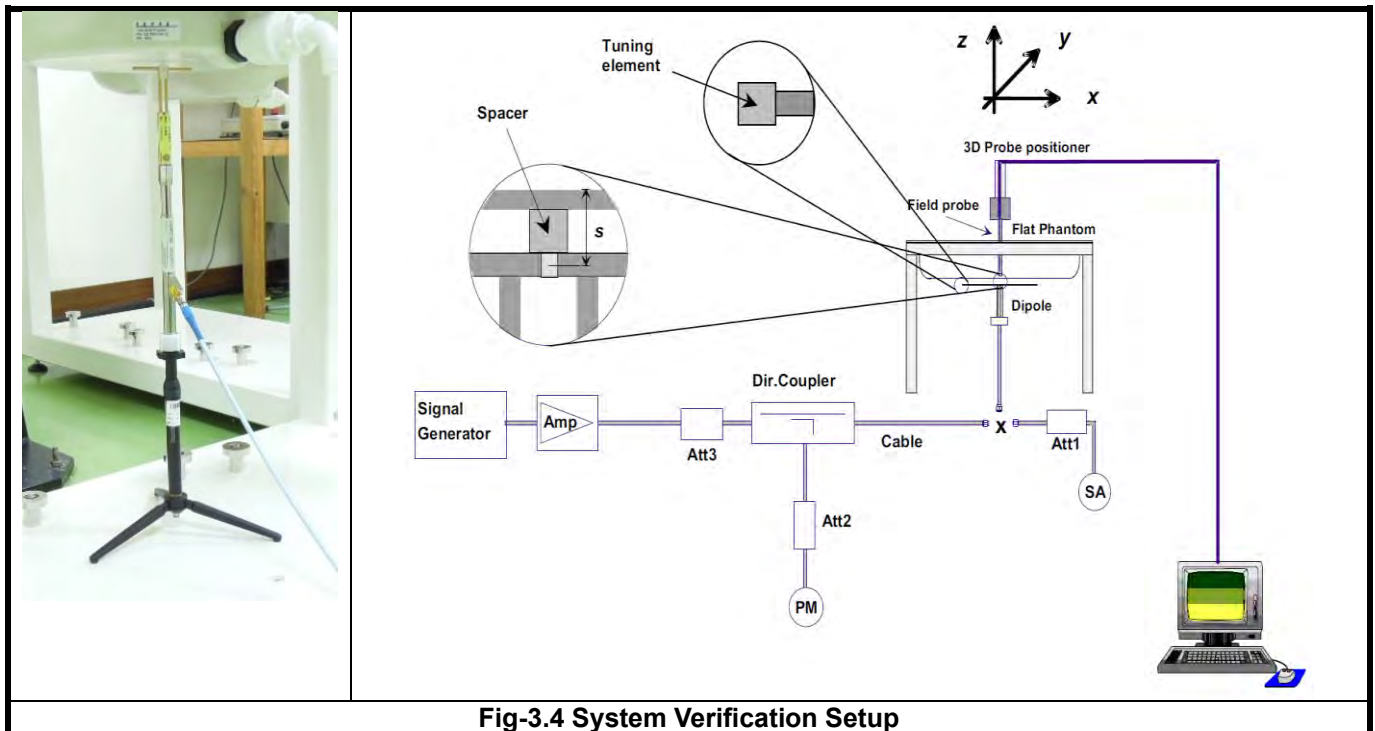

Fig-3.4 System Verification Setup

The validation dipole is placed beneath the flat phantom with the specific spacer in place. The distance spacer is touch the phantom surface with a light pressure at the reference marking and be oriented parallel to the long side of the phantom. The spectrum analyzer measures the forward power at the location of the system check dipole connector. The signal generator is adjusted for the desired forward power (250 mW is used for 700 MHz to 3 GHz, 100 mW is used for 3.5 GHz to 6 GHz) at the dipole connector and the power meter is read at that level. After connecting the cable to the dipole, the signal generator is readjusted for the same reading at power meter.

After system check testing, the SAR result will be normalized to 1W forward input power and compared with the reference SAR value derived from validation dipole certificate report. The deviation of system check should be within 10 %.

3.4 SAR Measurement Procedure

According to the SAR test standard, the recommended procedure for assessing the peak spatial-average SAR value consists of the following steps:

- (a) Power reference measurement
- (b) Area scan
- (c) Zoom scan
- (d) Power drift measurement

The SAR measurement procedures for each of test conditions are as follows:

- (a) Make EUT to transmit maximum output power
- (b) Measure conducted output power through RF cable
- (c) Place the EUT in the specific position of phantom
- (d) Perform SAR testing steps on the DASY system
- (e) Record the SAR value

3.4.1 Area & Zoom Scan Procedure

First Area Scan is used to locate the approximate location(s) of the local peak SAR value(s). The measurement grid within an Area Scan is defined by the grid extent, grid step size and grid offset. Next, in order to determine the EM field distribution in a three-dimensional spatial extension, Zoom Scan is required. The Zoom Scan is performed around the highest E-field value to determine the averaged SAR-distribution over 10 g. According to KDB 865664 D01, the resolution for Area and Zoom scan is specified in the table below.

Items	<= 2 GHz	2-3 GHz	3-4 GHz	4-5 GHz	5-6 GHz
Area Scan ($\Delta x, \Delta y$)	<= 15 mm	<= 12 mm	<= 12 mm	<= 10 mm	<= 10 mm
Zoom Scan ($\Delta x, \Delta y$)	<= 8 mm	<= 5 mm	<= 5 mm	<= 4 mm	<= 4 mm
Zoom Scan (Δz)	<= 5 mm	<= 5 mm	<= 4 mm	<= 3 mm	<= 2 mm
Zoom Scan Volume	>= 30 mm	>= 30 mm	>= 28 mm	>= 25 mm	>= 22 mm

Note:

When zoom scan is required and report SAR is <= 1.4 W/kg, the zoom scan resolution of $\Delta x / \Delta y$ (2-3GHz: <= 8 mm, 3-4GHz: <= 7 mm, 4-6GHz: <= 5 mm) may be applied.

3.4.2 Volume Scan Procedure

The volume scan is used for assess overlapping SAR distributions for antennas transmitting in different frequency bands. It is equivalent to an oversized zoom scan used in standalone measurements. The measurement volume will be used to enclose all the simultaneous transmitting antennas. For antennas transmitting simultaneously in different frequency bands, the volume scan is measured separately in each frequency band. In order to sum correctly to compute the 1g aggregate SAR, the EUT remain in the same test position for all measurements and all volume scan use the same spatial resolution and grid spacing. When all volume scan were completed, the software, SEMCAD postprocessor can combine and subsequently superpose these measurement data to calculating the multiband SAR.

3.4.3 Power Drift Monitoring

All SAR testing is under the EUT install full charged battery and transmit maximum output power. In DASY measurement software, the power reference measurement and power drift measurement procedures are used for monitoring the power drift of EUT during SAR test. Both these procedures measure the field at a specified reference position before and after the SAR testing. The software will calculate the field difference in dB. If the power drift more than 5%, the SAR will be retested.

3.4.4 Spatial Peak SAR Evaluation

The procedure for spatial peak SAR evaluation has been implemented according to the test standard. It can be conducted for 1g and 10g, as well as for user-specific masses. The DASY software includes all numerical procedures necessary to evaluate the spatial peak SAR value.

The base for the evaluation is a "cube" measurement. The measured volume must include the 1g and 10g cubes with the highest averaged SAR values. For that purpose, the center of the measured volume is aligned to the interpolated peak SAR value of a previously performed area scan.

The entire evaluation of the spatial peak values is performed within the post-processing engine (SEMCAD). The system always gives the maximum values for the 1g and 10g cubes. The algorithm to find the cube with highest averaged SAR is divided into the following stages:

- (a) Extraction of the measured data (grid and values) from the Zoom Scan
- (b) Calculation of the SAR value at every measurement point based on all stored data (A/D values and measurement parameters)
- (c) Generation of a high-resolution mesh within the measured volume
- (d) Interpolation of all measured values from the measurement grid to the high-resolution grid
- (e) Extrapolation of the entire 3-D field distribution to the phantom surface over the distance from sensor to surface
- (f) Calculation of the averaged SAR within masses of 1g and 10g

3.4.5 SAR Averaged Methods

In DASY, the interpolation and extrapolation are both based on the modified Quadratic Shepard's method. The interpolation scheme combines a least-square fitted function method and a weighted average method which are the two basic types of computational interpolation and approximation.

Extrapolation routines are used to obtain SAR values between the lowest measurement points and the inner phantom surface. The extrapolation distance is determined by the surface detection distance and the probe sensor offset. The uncertainty increases with the extrapolation distance. To keep the uncertainty within 1% for the 1 g and 10 g cubes, the extrapolation distance should not be larger than 5 mm.

3. SAR Measurement Evaluation

4.1 EUT Configuration and Setting

<Connections between EUT and System Simulator>

For WWAN SAR testing, the EUT was linked and controlled by base station emulator (Anritsu MT8821C is used for GSM/WCDMA/CDMA/LTE). Communication between the EUT and the emulator was established by air link. The distance between the EUT and the communicating antenna of the emulator is larger than 50 cm and the output power radiated from the emulator antenna is at least 30 dB smaller than the output power of EUT. The EUT was set from the emulator to radiate maximum output power during SAR testing.

< Proximity Sensor Triggering Distances >

The proximity sensor triggering distance was determined per KDB 616217 section 6.2, and EUT moving further away from the flat phantom and EUT moving toward the flat phantom were both assessed.

In the preliminary triggering distance testing, the tissue-equivalent medium for different frequency bands were used for verification; no other frequency bands tissue-equivalent medium was found to result in shortest triggering than that for 5700MHz, and the tissue-equivalent medium for 5700MHz was used for formal proximity sensor triggering testing.

Summary for power verification per distance was tabulated in the below table.

WWAN Ant-1

DSI3/4

Output Power Verification in dBm for EUT Front Face (moving toward phantom)											
Distance (mm)	16	17	18	19	20	21	22	23	24	25	26
GSM1900 Ch810 (GPRS 3Tx Slot)	24.32	24.32	24.32	24.32	24.32	24.32	25.93	25.93	25.93	25.93	25.93
WCDMA II Ch9400 (RMC12.2K)	19.17	19.17	19.17	19.17	19.17	19.17	24.04	24.04	24.04	24.04	24.04
WCDMA IV Ch1413 (RMC12.2K)	19.06	19.06	19.06	19.06	19.06	19.06	24.04	24.04	24.04	24.04	24.04
LTE 2 Ch18900 (QPSK20M_1RB_OS50)	18.96	18.96	18.96	18.96	18.96	18.96	24.30	24.30	24.30	24.30	24.30
LTE 7 Ch21100 (QPSK20M_1RB_OS50)	22.65	22.65	22.65	22.65	22.65	22.65	24.01	24.01	24.01	24.01	24.01
LTE 38 Ch38000 (QPSK20M_1RB_OS50)	23.18	23.18	23.18	23.18	23.18	23.18	23.99	23.99	23.99	23.99	23.99
LTE 41 Ch39750 (QPSK20M_1RB_OS0)	23.21	23.21	23.21	23.21	23.21	23.21	24.02	24.02	24.02	24.02	24.02
LTE 66 Ch132322 (QPSK20M_1RB_OS50)	17.98	17.98	17.98	17.98	17.98	17.98	24.51	24.51	24.51	24.51	24.51
NR n2 Ch376000 (DFT-QPSK20M_1RB_OS53)	18.25	18.25	18.25	18.25	18.25	18.25	23.86	23.86	23.86	23.86	23.86
NR n7 Ch507000 (DFT-QPSK50M_1RB_OS135)	21.76	21.76	21.76	21.76	21.76	21.76	23.40	23.40	23.40	23.40	23.40
NR n38 Ch518000 (DFT-QPSK40M_1RB_OS53)	22.53	22.53	22.53	22.53	22.53	22.53	24.11	24.11	24.11	24.11	24.11
NR n41 Ch518598 (DFT-QPSK100M_1RB_OS137)	21.38	21.38	21.38	21.38	21.38	21.38	24.01	24.01	24.01	24.01	24.01
NR n66 Ch349000 (DFT-QPSK80M_1RB_OS107)	18.86	18.86	18.86	18.86	18.86	18.86	24.18	24.18	24.18	24.18	24.18



BUREAU
VERITAS

FCC SAR Test Report



Certificate #6613.01

Output Power Verification in dBm for EUT Front Face (moving away phantom)											
Distance (mm)	16	17	18	19	20	21	22	23	24	25	26
GSM1900 Ch810 (GPRS 3Tx Slot)	24.32	24.32	24.32	24.32	24.32	24.32	25.93	25.93	25.93	25.93	25.93
WCDMA II Ch9400 (RMC12.2K)	19.17	19.17	19.17	19.17	19.17	19.17	24.04	24.04	24.04	24.04	24.04
WCDMA IV Ch1413 (RMC12.2K)	19.06	19.06	19.06	19.06	19.06	19.06	24.04	24.04	24.04	24.04	24.04
LTE 2 Ch18900 (QPSK20M_1RB_OS50)	18.96	18.96	18.96	18.96	18.96	18.96	24.30	24.30	24.30	24.30	24.30
LTE 7 Ch21100 (QPSK20M_1RB_OS50)	22.65	22.65	22.65	22.65	22.65	22.65	24.01	24.01	24.01	24.01	24.01
LTE 38 Ch38000 (QPSK20M_1RB_OS50)	23.18	23.18	23.18	23.18	23.18	23.18	23.99	23.99	23.99	23.99	23.99
LTE 41 Ch39750 (QPSK20M_1RB_OS0)	23.21	23.21	23.21	23.21	23.21	23.21	24.02	24.02	24.02	24.02	24.02
LTE 66 Ch132322 (QPSK20M_1RB_OS50)	17.98	17.98	17.98	17.98	17.98	17.98	24.51	24.51	24.51	24.51	24.51
NR n2 Ch376000 (DFT-QPSK20M_1RB_OS53)	18.25	18.25	18.25	18.25	18.25	18.25	23.86	23.86	23.86	23.86	23.86
NR n7 Ch507000 (DFT-QPSK50M_1RB_OS135)	21.76	21.76	21.76	21.76	21.76	21.76	23.40	23.40	23.40	23.40	23.40
NR n38 Ch518000 (DFT-QPSK40M_1RB_OS53)	22.53	22.53	22.53	22.53	22.53	22.53	24.11	24.11	24.11	24.11	24.11
NR n41 Ch518598 (DFT-QPSK100M_1RB_OS137)	21.38	21.38	21.38	21.38	21.38	21.38	24.01	24.01	24.01	24.01	24.01
NR n66 Ch349000 (DFT-QPSK80M_1RB_OS107)	18.86	18.86	18.86	18.86	18.86	18.86	24.18	24.18	24.18	24.18	24.18



BUREAU
VERITAS

FCC SAR Test Report



Certificate #6613.01

Output Power Verification in dBm for EUT Rear Face (moving toward phantom)											
Distance (mm)	16	17	18	19	20	21	22	23	24	25	26
GSM1900 Ch810 (GPRS 3Tx Slot)	24.32	24.32	24.32	24.32	24.32	24.32	25.93	25.93	25.93	25.93	25.93
WCDMA II Ch9400 (RMC12.2K)	19.17	19.17	19.17	19.17	19.17	19.17	24.04	24.04	24.04	24.04	24.04
WCDMA IV Ch1413 (RMC12.2K)	19.06	19.06	19.06	19.06	19.06	19.06	24.04	24.04	24.04	24.04	24.04
LTE 2 Ch18900 (QPSK20M_1RB_OS50)	18.96	18.96	18.96	18.96	18.96	18.96	24.30	24.30	24.30	24.30	24.30
LTE 7 Ch21100 (QPSK20M_1RB_OS50)	22.65	22.65	22.65	22.65	22.65	22.65	24.01	24.01	24.01	24.01	24.01
LTE 38 Ch38000 (QPSK20M_1RB_OS50)	23.18	23.18	23.18	23.18	23.18	23.18	23.99	23.99	23.99	23.99	23.99
LTE 41 Ch39750 (QPSK20M_1RB_OS0)	23.21	23.21	23.21	23.21	23.21	23.21	24.02	24.02	24.02	24.02	24.02
LTE 66 Ch132322 (QPSK20M_1RB_OS50)	17.98	17.98	17.98	17.98	17.98	17.98	24.51	24.51	24.51	24.51	24.51
NR n2 Ch376000 (DFT-QPSK20M_1RB_OS53)	18.25	18.25	18.25	18.25	18.25	18.25	23.86	23.86	23.86	23.86	23.86
NR n7 Ch507000 (DFT-QPSK50M_1RB_OS135)	21.76	21.76	21.76	21.76	21.76	21.76	23.40	23.40	23.40	23.40	23.40
NR n38 Ch518000 (DFT-QPSK40M_1RB_OS53)	22.53	22.53	22.53	22.53	22.53	22.53	24.11	24.11	24.11	24.11	24.11
NR n41 Ch518598 (DFT-QPSK100M_1RB_OS137)	21.38	21.38	21.38	21.38	21.38	21.38	24.01	24.01	24.01	24.01	24.01
NR n66 Ch349000 (DFT-QPSK80M_1RB_OS107)	18.86	18.86	18.86	18.86	18.86	18.86	24.18	24.18	24.18	24.18	24.18



BUREAU
VERITAS

FCC SAR Test Report



Certificate #6613.01

Output Power Verification in dBm for EUT Rear Face (moving away phantom)											
Distance (mm)	16	17	18	19	20	21	22	23	24	25	26
GSM1900 Ch810 (GPRS 3Tx Slot)	24.32	24.32	24.32	24.32	24.32	24.32	25.93	25.93	25.93	25.93	25.93
WCDMA II Ch9400 (RMC12.2K)	19.17	19.17	19.17	19.17	19.17	19.17	24.04	24.04	24.04	24.04	24.04
WCDMA IV Ch1413 (RMC12.2K)	19.06	19.06	19.06	19.06	19.06	19.06	24.04	24.04	24.04	24.04	24.04
LTE 2 Ch18900 (QPSK20M_1RB_OS50)	18.96	18.96	18.96	18.96	18.96	18.96	24.30	24.30	24.30	24.30	24.30
LTE 7 Ch21100 (QPSK20M_1RB_OS50)	22.65	22.65	22.65	22.65	22.65	22.65	24.01	24.01	24.01	24.01	24.01
LTE 38 Ch38000 (QPSK20M_1RB_OS50)	23.18	23.18	23.18	23.18	23.18	23.18	23.99	23.99	23.99	23.99	23.99
LTE 41 Ch39750 (QPSK20M_1RB_OS0)	23.21	23.21	23.21	23.21	23.21	23.21	24.02	24.02	24.02	24.02	24.02
LTE 66 Ch132322 (QPSK20M_1RB_OS50)	17.98	17.98	17.98	17.98	17.98	17.98	24.51	24.51	24.51	24.51	24.51
NR n2 Ch376000 (DFT-QPSK20M_1RB_OS53)	18.25	18.25	18.25	18.25	18.25	18.25	23.86	23.86	23.86	23.86	23.86
NR n7 Ch507000 (DFT-QPSK50M_1RB_OS135)	21.76	21.76	21.76	21.76	21.76	21.76	23.40	23.40	23.40	23.40	23.40
NR n38 Ch518000 (DFT-QPSK40M_1RB_OS53)	22.53	22.53	22.53	22.53	22.53	22.53	24.11	24.11	24.11	24.11	24.11
NR n41 Ch518598 (DFT-QPSK100M_1RB_OS137)	21.38	21.38	21.38	21.38	21.38	21.38	24.01	24.01	24.01	24.01	24.01
NR n66 Ch349000 (DFT-QPSK80M_1RB_OS107)	18.86	18.86	18.86	18.86	18.86	18.86	24.18	24.18	24.18	24.18	24.18



BUREAU
VERITAS

FCC SAR Test Report



Certificate #6613.01

Output Power Verification in dBm for EUT Bottom Side (moving toward phantom)											
Distance (mm)	16	17	18	19	20	21	22	23	24	25	26
GSM1900 Ch810 (GPRS 3Tx Slot)	24.32	24.32	24.32	24.32	24.32	24.32	25.93	25.93	25.93	25.93	25.93
WCDMA II Ch9400 (RMC12.2K)	19.17	19.17	19.17	19.17	19.17	19.17	24.04	24.04	24.04	24.04	24.04
WCDMA IV Ch1413 (RMC12.2K)	19.06	19.06	19.06	19.06	19.06	19.06	24.04	24.04	24.04	24.04	24.04
LTE 2 Ch18900 (QPSK20M_1RB_OS50)	18.96	18.96	18.96	18.96	18.96	18.96	24.30	24.30	24.30	24.30	24.30
LTE 7 Ch21100 (QPSK20M_1RB_OS50)	22.65	22.65	22.65	22.65	22.65	22.65	24.01	24.01	24.01	24.01	24.01
LTE 38 Ch38000 (QPSK20M_1RB_OS50)	23.18	23.18	23.18	23.18	23.18	23.18	23.99	23.99	23.99	23.99	23.99
LTE 41 Ch39750 (QPSK20M_1RB_OS0)	23.21	23.21	23.21	23.21	23.21	23.21	24.02	24.02	24.02	24.02	24.02
LTE 66 Ch132322 (QPSK20M_1RB_OS50)	17.98	17.98	17.98	17.98	17.98	17.98	24.51	24.51	24.51	24.51	24.51
NR n2 Ch376000 (DFT-QPSK20M_1RB_OS53)	18.25	18.25	18.25	18.25	18.25	18.25	23.86	23.86	23.86	23.86	23.86
NR n7 Ch507000 (DFT-QPSK50M_1RB_OS135)	21.76	21.76	21.76	21.76	21.76	21.76	23.40	23.40	23.40	23.40	23.40
NR n38 Ch518000 (DFT-QPSK40M_1RB_OS53)	22.53	22.53	22.53	22.53	22.53	22.53	24.11	24.11	24.11	24.11	24.11
NR n41 Ch518598 (DFT-QPSK100M_1RB_OS137)	21.38	21.38	21.38	21.38	21.38	21.38	24.01	24.01	24.01	24.01	24.01
NR n66 Ch349000 (DFT-QPSK80M_1RB_OS107)	18.86	18.86	18.86	18.86	18.86	18.86	24.18	24.18	24.18	24.18	24.18



BUREAU
VERITAS

FCC SAR Test Report



Certificate #6613.01

Output Power Verification in dBm for EUT Bottom Side (moving away phantom)											
Distance (mm)	16	17	18	19	20	21	22	23	24	25	26
GSM1900 Ch810 (GPRS 3Tx Slot)	24.32	24.32	24.32	24.32	24.32	24.32	25.93	25.93	25.93	25.93	25.93
WCDMA II Ch9400 (RMC12.2K)	19.17	19.17	19.17	19.17	19.17	19.17	24.04	24.04	24.04	24.04	24.04
WCDMA IV Ch1413 (RMC12.2K)	19.06	19.06	19.06	19.06	19.06	19.06	24.04	24.04	24.04	24.04	24.04
LTE 2 Ch18900 (QPSK20M_1RB_OS50)	18.96	18.96	18.96	18.96	18.96	18.96	24.30	24.30	24.30	24.30	24.30
LTE 7 Ch21100 (QPSK20M_1RB_OS50)	22.65	22.65	22.65	22.65	22.65	22.65	24.01	24.01	24.01	24.01	24.01
LTE 38 Ch38000 (QPSK20M_1RB_OS50)	23.18	23.18	23.18	23.18	23.18	23.18	23.99	23.99	23.99	23.99	23.99
LTE 41 Ch39750 (QPSK20M_1RB_OS0)	23.21	23.21	23.21	23.21	23.21	23.21	24.02	24.02	24.02	24.02	24.02
LTE 66 Ch132322 (QPSK20M_1RB_OS50)	17.98	17.98	17.98	17.98	17.98	17.98	24.51	24.51	24.51	24.51	24.51
NR n2 Ch376000 (DFT-QPSK20M_1RB_OS53)	18.25	18.25	18.25	18.25	18.25	18.25	23.86	23.86	23.86	23.86	23.86
NR n7 Ch507000 (DFT-QPSK50M_1RB_OS135)	21.76	21.76	21.76	21.76	21.76	21.76	23.40	23.40	23.40	23.40	23.40
NR n38 Ch518000 (DFT-QPSK40M_1RB_OS53)	22.53	22.53	22.53	22.53	22.53	22.53	24.11	24.11	24.11	24.11	24.11
NR n41 Ch518598 (DFT-QPSK100M_1RB_OS137)	21.38	21.38	21.38	21.38	21.38	21.38	24.01	24.01	24.01	24.01	24.01
NR n66 Ch349000 (DFT-QPSK80M_1RB_OS107)	18.86	18.86	18.86	18.86	18.86	18.86	24.18	24.18	24.18	24.18	24.18

WWAN Ant-2

DSI4

Output Power Verification in dBm for EUT Front Face (moving toward phantom)											
Distance (mm)	16	17	18	19	20	21	22	23	24	25	26
NR n77 Ch633334 (DFT-QPSK100M_1RB_OS137)	20.75	20.75	20.75	20.75	20.75	20.75	24.26	24.26	24.26	24.26	24.26
NR n78 Ch633334 (DFT-QPSK100M_1RB_OS137)	20.93	20.93	20.93	20.93	20.93	20.93	23.95	23.95	23.95	23.95	23.95

Output Power Verification in dBm for EUT Front Face (moving away phantom)											
Distance (mm)	16	17	18	19	20	21	22	23	24	25	26
NR n77 Ch633334 (DFT-QPSK100M_1RB_OS137)	20.75	20.75	20.75	20.75	20.75	20.75	24.26	24.26	24.26	24.26	24.26
NR n78 Ch633334 (DFT-QPSK100M_1RB_OS137)	20.93	20.93	20.93	20.93	20.93	20.93	23.95	23.95	23.95	23.95	23.95

Output Power Verification in dBm for EUT Rear Face (moving toward phantom)											
Distance (mm)	16	17	18	19	20	21	22	23	24	25	26
NR n77 Ch633334 (DFT-QPSK100M_1RB_OS137)	20.75	20.75	20.75	20.75	20.75	20.75	24.26	24.26	24.26	24.26	24.26
NR n78 Ch633334 (DFT-QPSK100M_1RB_OS137)	20.93	20.93	20.93	20.93	20.93	20.93	23.95	23.95	23.95	23.95	23.95

Output Power Verification in dBm for EUT Rear Face (moving away phantom)											
Distance (mm)	16	17	18	19	20	21	22	23	24	25	26
NR n77 Ch633334 (DFT-QPSK100M_1RB_OS137)	20.75	20.75	20.75	20.75	20.75	20.75	24.26	24.26	24.26	24.26	24.26
NR n78 Ch633334 (DFT-QPSK100M_1RB_OS137)	20.93	20.93	20.93	20.93	20.93	20.93	23.95	23.95	23.95	23.95	23.95



BUREAU
VERITAS

FCC SAR Test Report



Certificate #6613.01

Output Power Verification in dBm for EUT Left Side (moving toward phantom)											
Distance (mm)	11	12	13	14	15	16	17	18	19	20	21
NR n77 Ch633334 (DFT-QPSK100M_1RB_OS137)	20.75	20.75	20.75	20.75	20.75	20.75	24.26	24.26	24.26	24.26	24.26
NR n78 Ch633334 (DFT-QPSK100M_1RB_OS137)	20.93	20.93	20.93	20.93	20.93	20.93	23.95	23.95	23.95	23.95	23.95

Output Power Verification in dBm for EUT Left Side (moving away phantom)											
Distance (mm)	11	12	13	14	15	16	17	18	19	20	21
NR n77 Ch633334 (DFT-QPSK100M_1RB_OS137)	20.75	20.75	20.75	20.75	20.75	20.75	24.26	24.26	24.26	24.26	24.26
NR n78 Ch633334 (DFT-QPSK100M_1RB_OS137)	20.93	20.93	20.93	20.93	20.93	20.93	23.95	23.95	23.95	23.95	23.95

WWAN Ant-3

DSI4

Output Power Verification in dBm for EUT Front Face (moving toward phantom)											
Distance (mm)	16	17	18	19	20	21	22	23	24	25	26
LTE 2 Ch18700 (QPSK20M_1RB_OS50)	17.04	17.04	17.04	17.04	17.04	17.04	23.86	23.86	23.86	23.86	23.86
LTE 7 Ch20850 (QPSK20M_1RB_OS50)	14.61	14.61	14.61	14.61	14.61	14.61	23.63	23.63	23.63	23.63	23.63
LTE 38 Ch38000 (QPSK20M_1RB_OS0)	18.52	18.52	18.52	18.52	18.52	18.52	23.59	23.59	23.59	23.59	23.59
LTE 41 Ch39750 (QPSK20M_1RB_OS50)	19.27	19.27	19.27	19.27	19.27	19.27	20.31	20.31	20.31	20.31	20.31
LTE 42 Ch42990 (QPSK20M_1RB_OS50)	15.44	15.44	15.44	15.44	15.44	15.44	18.55	18.55	18.55	18.55	18.55
LTE 66 Ch132322 (QPSK20M_1RB_OS50)	19.72	19.72	19.72	19.72	19.72	19.72	23.95	23.95	23.95	23.95	23.95
NR n41 Ch518598 (DFT-QPSK100M_1RB_OS137)	19.53	19.53	19.53	19.53	19.53	19.53	21.26	21.26	21.26	21.26	21.26
NR n48 Ch643332 (DFT-QPSK100M_1RB_OS137)	17.79	17.79	17.79	17.79	17.79	17.79	19.26	19.26	19.26	19.26	19.26
NR n77 Ch633334 (DFT-QPSK100M_1RB_OS137)	18.98	18.98	18.98	18.98	18.98	18.98	19.73	19.73	19.73	19.73	19.73
ENDC NR n77 Ch633334 (DFT-QPSK100M_1RB_OS137)	15.46	15.46	15.46	15.46	15.46	15.46	19.73	19.73	19.73	19.73	19.73
NR n78 Ch633334 (DFT-QPSK100M_1RB_OS137)	18.91	18.91	18.91	18.91	18.91	18.91	19.71	19.71	19.71	19.71	19.71
ENDC NR n78 Ch633334 (DFT-QPSK100M_1RB_OS137)	15.40	15.40	15.40	15.40	15.40	15.40	19.71	19.71	19.71	19.71	19.71



BUREAU
VERITAS

FCC SAR Test Report



Certificate #6613.01

Output Power Verification in dBm for EUT Front Face (moving away phantom)											
Distance (mm)	16	17	18	19	20	21	22	23	24	25	26
LTE 2 Ch18700 (QPSK20M 1RB_OS50)	17.04	17.04	17.04	17.04	17.04	17.04	23.86	23.86	23.86	23.86	23.86
LTE 7 Ch20850 (QPSK20M 1RB_OS50)	14.61	14.61	14.61	14.61	14.61	14.61	23.63	23.63	23.63	23.63	23.63
LTE 38 Ch38000 (QPSK20M 1RB_OS0)	18.52	18.52	18.52	18.52	18.52	18.52	23.59	23.59	23.59	23.59	23.59
LTE 41 Ch39750 (QPSK20M 1RB_OS50)	19.27	19.27	19.27	19.27	19.27	19.27	20.31	20.31	20.31	20.31	20.31
LTE 42 Ch42990 (QPSK20M 1RB_OS50)	15.44	15.44	15.44	15.44	15.44	15.44	18.55	18.55	18.55	18.55	18.55
LTE 66 Ch132322 (QPSK20M 1RB_OS50)	19.72	19.72	19.72	19.72	19.72	19.72	23.95	23.95	23.95	23.95	23.95
NR n41 Ch518598 (DFT-QPSK100M_1RB_OS137)	19.53	19.53	19.53	19.53	19.53	19.53	21.26	21.26	21.26	21.26	21.26
NR n48 Ch643332 (DFT-QPSK100M_1RB_OS137)	17.79	17.79	17.79	17.79	17.79	17.79	19.26	19.26	19.26	19.26	19.26
NR n77 Ch633334 (DFT-QPSK100M_1RB_OS137)	18.98	18.98	18.98	18.98	18.98	18.98	19.73	19.73	19.73	19.73	19.73
ENDC NR n77 Ch633334 (DFT-QPSK100M_1RB_OS137)	15.46	15.46	15.46	15.46	15.46	15.46	19.73	19.73	19.73	19.73	19.73
NR n78 Ch633334 (DFT-QPSK100M_1RB_OS137)	18.91	18.91	18.91	18.91	18.91	18.91	19.71	19.71	19.71	19.71	19.71
ENDC NR n78 Ch633334 (DFT-QPSK100M_1RB_OS137)	15.40	15.40	15.40	15.40	15.40	15.40	19.71	19.71	19.71	19.71	19.71



**BUREAU
VERITAS**

FCC SAR Test Report



Certificate #6613.01

Output Power Verification in dBm for EUT Rear Face (moving toward phantom)											
Distance (mm)	16	17	18	19	20	21	22	23	24	25	26
LTE 2 Ch18700 (QPSK20M 1RB_OS50)	17.04	17.04	17.04	17.04	17.04	17.04	23.86	23.86	23.86	23.86	23.86
LTE 7 Ch20850 (QPSK20M 1RB_OS50)	14.61	14.61	14.61	14.61	14.61	14.61	23.63	23.63	23.63	23.63	23.63
LTE 38 Ch38000 (QPSK20M 1RB_OS0)	18.52	18.52	18.52	18.52	18.52	18.52	23.59	23.59	23.59	23.59	23.59
LTE 41 Ch39750 (QPSK20M 1RB_OS50)	19.27	19.27	19.27	19.27	19.27	19.27	20.31	20.31	20.31	20.31	20.31
LTE 42 Ch42990 (QPSK20M 1RB_OS50)	15.44	15.44	15.44	15.44	15.44	15.44	18.55	18.55	18.55	18.55	18.55
LTE 66 Ch132322 (QPSK20M 1RB_OS50)	19.72	19.72	19.72	19.72	19.72	19.72	23.95	23.95	23.95	23.95	23.95
NR n41 Ch518598 (DFT-QPSK100M_1RB_OS137)	19.53	19.53	19.53	19.53	19.53	19.53	21.26	21.26	21.26	21.26	21.26
NR n48 Ch643332 (DFT-QPSK100M_1RB_OS137)	17.79	17.79	17.79	17.79	17.79	17.79	19.26	19.26	19.26	19.26	19.26
NR n77 Ch633334 (DFT-QPSK100M_1RB_OS137)	18.98	18.98	18.98	18.98	18.98	18.98	19.73	19.73	19.73	19.73	19.73
ENDC NR n77 Ch633334 (DFT-QPSK100M_1RB_OS137)	15.46	15.46	15.46	15.46	15.46	15.46	19.73	19.73	19.73	19.73	19.73
NR n78 Ch633334 (DFT-QPSK100M_1RB_OS137)	18.91	18.91	18.91	18.91	18.91	18.91	19.71	19.71	19.71	19.71	19.71
ENDC NR n78 Ch633334 (DFT-QPSK100M_1RB_OS137)	15.40	15.40	15.40	15.40	15.40	15.40	19.71	19.71	19.71	19.71	19.71



BUREAU
VERITAS

FCC SAR Test Report



Certificate #6613.01

Output Power Verification in dBm for EUT Rear Face (moving away phantom)											
Distance (mm)	16	17	18	19	20	21	22	23	24	25	26
LTE 2 Ch18700 (QPSK20M 1RB_OS50)	17.04	17.04	17.04	17.04	17.04	17.04	23.86	23.86	23.86	23.86	23.86
LTE 7 Ch20850 (QPSK20M 1RB_OS50)	14.61	14.61	14.61	14.61	14.61	14.61	23.63	23.63	23.63	23.63	23.63
LTE 38 Ch38000 (QPSK20M 1RB_OS0)	18.52	18.52	18.52	18.52	18.52	18.52	23.59	23.59	23.59	23.59	23.59
LTE 41 Ch39750 (QPSK20M 1RB_OS50)	19.27	19.27	19.27	19.27	19.27	19.27	20.31	20.31	20.31	20.31	20.31
LTE 42 Ch42990 (QPSK20M 1RB_OS50)	15.44	15.44	15.44	15.44	15.44	15.44	18.55	18.55	18.55	18.55	18.55
LTE 66 Ch132322 (QPSK20M 1RB_OS50)	19.72	19.72	19.72	19.72	19.72	19.72	23.95	23.95	23.95	23.95	23.95
NR n41 Ch518598 (DFT-QPSK100M_1RB_OS137)	19.53	19.53	19.53	19.53	19.53	19.53	21.26	21.26	21.26	21.26	21.26
NR n48 Ch643332 (DFT-QPSK100M_1RB_OS137)	17.79	17.79	17.79	17.79	17.79	17.79	19.26	19.26	19.26	19.26	19.26
NR n77 Ch633334 (DFT-QPSK100M_1RB_OS137)	18.98	18.98	18.98	18.98	18.98	18.98	19.73	19.73	19.73	19.73	19.73
ENDC NR n77 Ch633334 (DFT-QPSK100M_1RB_OS137)	15.46	15.46	15.46	15.46	15.46	15.46	19.73	19.73	19.73	19.73	19.73
NR n78 Ch633334 (DFT-QPSK100M_1RB_OS137)	18.91	18.91	18.91	18.91	18.91	18.91	19.71	19.71	19.71	19.71	19.71
ENDC NR n78 Ch633334 (DFT-QPSK100M_1RB_OS137)	15.40	15.40	15.40	15.40	15.40	15.40	19.71	19.71	19.71	19.71	19.71



BUREAU
VERITAS

FCC SAR Test Report



Certificate #6613.01

Output Power Verification in dBm for EUT Left Side (moving toward phantom)											
Distance (mm)	11	12	13	14	15	16	17	18	19	20	21
LTE 2 Ch18700 (QPSK20M 1RB_OS50)	17.04	17.04	17.04	17.04	17.04	17.04	23.86	23.86	23.86	23.86	23.86
LTE 7 Ch20850 (QPSK20M 1RB_OS50)	14.61	14.61	14.61	14.61	14.61	14.61	23.63	23.63	23.63	23.63	23.63
LTE 38 Ch38000 (QPSK20M 1RB_OS0)	18.52	18.52	18.52	18.52	18.52	18.52	23.59	23.59	23.59	23.59	23.59
LTE 41 Ch39750 (QPSK20M 1RB_OS50)	19.27	19.27	19.27	19.27	19.27	19.27	20.31	20.31	20.31	20.31	20.31
LTE 42 Ch42990 (QPSK20M 1RB_OS50)	15.44	15.44	15.44	15.44	15.44	15.44	18.55	18.55	18.55	18.55	18.55
LTE 66 Ch132322 (QPSK20M 1RB_OS50)	19.72	19.72	19.72	19.72	19.72	19.72	23.95	23.95	23.95	23.95	23.95
NR n41 Ch518598 (DFT-QPSK100M_1RB_OS137)	19.53	19.53	19.53	19.53	19.53	19.53	21.26	21.26	21.26	21.26	21.26
NR n48 Ch643332 (DFT-QPSK100M_1RB_OS137)	17.79	17.79	17.79	17.79	17.79	17.79	19.26	19.26	19.26	19.26	19.26
NR n77 Ch633334 (DFT-QPSK100M_1RB_OS137)	18.98	18.98	18.98	18.98	18.98	18.98	19.73	19.73	19.73	19.73	19.73
ENDC NR n77 Ch633334 (DFT-QPSK100M_1RB_OS137)	15.46	15.46	15.46	15.46	15.46	15.46	19.73	19.73	19.73	19.73	19.73
NR n78 Ch633334 (DFT-QPSK100M_1RB_OS137)	18.91	18.91	18.91	18.91	18.91	18.91	19.71	19.71	19.71	19.71	19.71
ENDC NR n78 Ch633334 (DFT-QPSK100M_1RB_OS137)	15.40	15.40	15.40	15.40	15.40	15.40	19.71	19.71	19.71	19.71	19.71



BUREAU
VERITAS

FCC SAR Test Report



Certificate #6613.01

Output Power Verification in dBm for EUT Left Side (moving away phantom)											
Distance (mm)	11	12	13	14	15	16	17	18	19	20	21
LTE 2 Ch18700 (QPSK20M 1RB_OS50)	17.04	17.04	17.04	17.04	17.04	17.04	23.86	23.86	23.86	23.86	23.86
LTE 7 Ch20850 (QPSK20M 1RB_OS50)	14.61	14.61	14.61	14.61	14.61	14.61	23.63	23.63	23.63	23.63	23.63
LTE 38 Ch38000 (QPSK20M 1RB_OS0)	18.52	18.52	18.52	18.52	18.52	18.52	23.59	23.59	23.59	23.59	23.59
LTE 41 Ch39750 (QPSK20M 1RB_OS50)	19.27	19.27	19.27	19.27	19.27	19.27	20.31	20.31	20.31	20.31	20.31
LTE 42 Ch42990 (QPSK20M 1RB_OS50)	15.44	15.44	15.44	15.44	15.44	15.44	18.55	18.55	18.55	18.55	18.55
LTE 66 Ch132322 (QPSK20M 1RB_OS50)	19.72	19.72	19.72	19.72	19.72	19.72	23.95	23.95	23.95	23.95	23.95
NR n41 Ch518598 (DFT-QPSK100M_1RB_OS137)	19.53	19.53	19.53	19.53	19.53	19.53	21.26	21.26	21.26	21.26	21.26
NR n48 Ch643332 (DFT-QPSK100M_1RB_OS137)	17.79	17.79	17.79	17.79	17.79	17.79	19.26	19.26	19.26	19.26	19.26
NR n77 Ch633334 (DFT-QPSK100M_1RB_OS137)	18.98	18.98	18.98	18.98	18.98	18.98	19.73	19.73	19.73	19.73	19.73
ENDC NR n77 Ch633334 (DFT-QPSK100M_1RB_OS137)	15.46	15.46	15.46	15.46	15.46	15.46	19.73	19.73	19.73	19.73	19.73
NR n78 Ch633334 (DFT-QPSK100M_1RB_OS137)	18.91	18.91	18.91	18.91	18.91	18.91	19.71	19.71	19.71	19.71	19.71
ENDC NR n78 Ch633334 (DFT-QPSK100M_1RB_OS137)	15.40	15.40	15.40	15.40	15.40	15.40	19.71	19.71	19.71	19.71	19.71

WWAN Ant-4

DS14

Output Power Verification in dBm for EUT Front Face (moving toward phantom)											
Distance (mm)	16	17	18	19	20	21	22	23	24	25	26
GSM1900 Ch810 (GPRS 3Tx Slot)	23.91	23.91	23.91	23.91	23.91	23.91	24.76	24.76	24.76	24.76	24.76
WCDMA II Ch9400 (RMC12.2K)	19.20	19.20	19.20	19.20	19.20	19.20	23.13	23.13	23.13	23.13	23.13
WCDMA IV Ch1413 (RMC12.2K)	21.52	21.52	21.52	21.52	21.52	21.52	23.33	23.33	23.33	23.33	23.33
LTE 2 Ch18900 (QPSK20M_1RB_OS50)	17.28	17.28	17.28	17.28	17.28	17.28	23.16	23.16	23.16	23.16	23.16
LTE 7 Ch20850 (QPSK20M_1RB_OS50)	17.99	17.99	17.99	17.99	17.99	17.99	23.01	23.01	23.01	23.01	23.01
LTE 38 Ch38000 (QPSK20M_1RB_OS0)	20.25	20.25	20.25	20.25	20.25	20.25	23.34	23.34	23.34	23.34	23.34
LTE 41 Ch39750 (QPSK20M_1RB_OS0)	20.59	20.59	20.59	20.59	20.59	20.59	23.49	23.49	23.49	23.49	23.49
LTE 66 Ch132072 (QPSK20M_1RB_OS50)	20.38	20.38	20.38	20.38	20.38	20.38	23.63	23.63	23.63	23.63	23.63
NR n2 Ch376000 (DFT-QPSK20M_1RB_OS53)	18.78	18.78	18.78	18.78	18.78	18.78	23.54	23.54	23.54	23.54	23.54
NR n7 Ch505000 (DFT-QPSK50M_1RB_OS135)	18.74	18.74	18.74	18.74	18.74	18.74	23.57	23.57	23.57	23.57	23.57
NR n38 Ch520000 (DFT-QPSK40M_1RB_OS53)	19.11	19.11	19.11	19.11	19.11	19.11	23.54	23.54	23.54	23.54	23.54
NR n41 Ch518598 (DFT-QPSK100M_1RB_OS137)	19.27	19.27	19.27	19.27	19.27	19.27	24.04	24.04	24.04	24.04	24.04
NR n66 Ch349000 (DFT-QPSK80M_1RB_OS107)	22.19	22.19	22.19	22.19	22.19	22.19	23.94	23.94	23.94	23.94	23.94



BUREAU
VERITAS

FCC SAR Test Report



Certificate #6613.01

Output Power Verification in dBm for EUT Front Face (moving away phantom)											
Distance (mm)	16	17	18	19	20	21	22	23	24	25	26
GSM1900 Ch810 (GPRS 3Tx Slot)	23.91	23.91	23.91	23.91	23.91	23.91	24.76	24.76	24.76	24.76	24.76
WCDMA II Ch9400 (RMC12.2K)	19.20	19.20	19.20	19.20	19.20	19.20	23.13	23.13	23.13	23.13	23.13
WCDMA IV Ch1413 (RMC12.2K)	21.52	21.52	21.52	21.52	21.52	21.52	23.33	23.33	23.33	23.33	23.33
LTE 2 Ch18900 (QPSK20M_1RB_OS50)	17.28	17.28	17.28	17.28	17.28	17.28	23.16	23.16	23.16	23.16	23.16
LTE 7 Ch20850 (QPSK20M_1RB_OS50)	17.99	17.99	17.99	17.99	17.99	17.99	23.01	23.01	23.01	23.01	23.01
LTE 38 Ch38000 (QPSK20M_1RB_OS0)	20.25	20.25	20.25	20.25	20.25	20.25	23.34	23.34	23.34	23.34	23.34
LTE 41 Ch39750 (QPSK20M_1RB_OS0)	20.59	20.59	20.59	20.59	20.59	20.59	23.49	23.49	23.49	23.49	23.49
LTE 66 Ch132072 (QPSK20M_1RB_OS50)	20.38	20.38	20.38	20.38	20.38	20.38	23.63	23.63	23.63	23.63	23.63
NR n2 Ch376000 (DFT-QPSK20M_1RB_OS53)	18.78	18.78	18.78	18.78	18.78	18.78	23.54	23.54	23.54	23.54	23.54
NR n7 Ch505000 (DFT-QPSK50M_1RB_OS135)	18.74	18.74	18.74	18.74	18.74	18.74	23.57	23.57	23.57	23.57	23.57
NR n38 Ch520000 (DFT-QPSK40M_1RB_OS53)	19.11	19.11	19.11	19.11	19.11	19.11	23.54	23.54	23.54	23.54	23.54
NR n41 Ch518598 (DFT-QPSK100M_1RB_OS137)	19.27	19.27	19.27	19.27	19.27	19.27	24.04	24.04	24.04	24.04	24.04
NR n66 Ch349000 (DFT-QPSK80M_1RB_OS107)	22.19	22.19	22.19	22.19	22.19	22.19	23.94	23.94	23.94	23.94	23.94



BUREAU
VERITAS

FCC SAR Test Report



Certificate #6613.01

Output Power Verification in dBm for EUT Rear Face (moving toward phantom)											
Distance (mm)	16	17	18	19	20	21	22	23	24	25	26
GSM1900 Ch810 (GPRS 3Tx Slot)	23.91	23.91	23.91	23.91	23.91	23.91	24.76	24.76	24.76	24.76	24.76
WCDMA II Ch9400 (RMC12.2K)	19.20	19.20	19.20	19.20	19.20	19.20	23.13	23.13	23.13	23.13	23.13
WCDMA IV Ch1413 (RMC12.2K)	21.52	21.52	21.52	21.52	21.52	21.52	23.33	23.33	23.33	23.33	23.33
LTE 2 Ch18900 (QPSK20M_1RB_OS50)	17.28	17.28	17.28	17.28	17.28	17.28	23.16	23.16	23.16	23.16	23.16
LTE 7 Ch20850 (QPSK20M_1RB_OS50)	17.99	17.99	17.99	17.99	17.99	17.99	23.01	23.01	23.01	23.01	23.01
LTE 38 Ch38000 (QPSK20M_1RB_OS0)	20.25	20.25	20.25	20.25	20.25	20.25	23.34	23.34	23.34	23.34	23.34
LTE 41 Ch39750 (QPSK20M_1RB_OS0)	20.59	20.59	20.59	20.59	20.59	20.59	23.49	23.49	23.49	23.49	23.49
LTE 66 Ch132072 (QPSK20M_1RB_OS50)	20.38	20.38	20.38	20.38	20.38	20.38	23.63	23.63	23.63	23.63	23.63
NR n2 Ch376000 (DFT-QPSK20M_1RB_OS53)	18.78	18.78	18.78	18.78	18.78	18.78	23.54	23.54	23.54	23.54	23.54
NR n7 Ch505000 (DFT-QPSK50M_1RB_OS135)	18.74	18.74	18.74	18.74	18.74	18.74	23.57	23.57	23.57	23.57	23.57
NR n38 Ch520000 (DFT-QPSK40M_1RB_OS53)	19.11	19.11	19.11	19.11	19.11	19.11	23.54	23.54	23.54	23.54	23.54
NR n41 Ch518598 (DFT-QPSK100M_1RB_OS137)	19.27	19.27	19.27	19.27	19.27	19.27	24.04	24.04	24.04	24.04	24.04
NR n66 Ch349000 (DFT-QPSK80M_1RB_OS107)	22.19	22.19	22.19	22.19	22.19	22.19	23.94	23.94	23.94	23.94	23.94



BUREAU VERITAS

FCC SAR Test Report



Certificate #6613.01

Output Power Verification in dBm for EUT Rear Face (moving away phantom)											
Distance (mm)	16	17	18	19	20	21	22	23	24	25	26
GSM1900 Ch810 (GPRS 3Tx Slot)	23.91	23.91	23.91	23.91	23.91	23.91	24.76	24.76	24.76	24.76	24.76
WCDMA II Ch9400 (RMC12.2K)	19.20	19.20	19.20	19.20	19.20	19.20	23.13	23.13	23.13	23.13	23.13
WCDMA IV Ch1413 (RMC12.2K)	21.52	21.52	21.52	21.52	21.52	21.52	23.33	23.33	23.33	23.33	23.33
LTE 2 Ch18900 (QPSK20M_1RB_OS50)	17.28	17.28	17.28	17.28	17.28	17.28	23.16	23.16	23.16	23.16	23.16
LTE 7 Ch20850 (QPSK20M_1RB_OS50)	17.99	17.99	17.99	17.99	17.99	17.99	23.01	23.01	23.01	23.01	23.01
LTE 38 Ch38000 (QPSK20M_1RB_OS0)	20.25	20.25	20.25	20.25	20.25	20.25	23.34	23.34	23.34	23.34	23.34
LTE 41 Ch39750 (QPSK20M_1RB_OS0)	20.59	20.59	20.59	20.59	20.59	20.59	23.49	23.49	23.49	23.49	23.49
LTE 66 Ch132072 (QPSK20M_1RB_OS50)	20.38	20.38	20.38	20.38	20.38	20.38	23.63	23.63	23.63	23.63	23.63
NR n2 Ch376000 (DFT-QPSK20M_1RB_OS53)	18.78	18.78	18.78	18.78	18.78	18.78	23.54	23.54	23.54	23.54	23.54
NR n7 Ch505000 (DFT-QPSK50M_1RB_OS135)	18.74	18.74	18.74	18.74	18.74	18.74	23.57	23.57	23.57	23.57	23.57
NR n38 Ch520000 (DFT-QPSK40M_1RB_OS53)	19.11	19.11	19.11	19.11	19.11	19.11	23.54	23.54	23.54	23.54	23.54
NR n41 Ch518598 (DFT-QPSK100M_1RB_OS137)	19.27	19.27	19.27	19.27	19.27	19.27	24.04	24.04	24.04	24.04	24.04
NR n66 Ch349000 (DFT-QPSK80M_1RB_OS107)	22.19	22.19	22.19	22.19	22.19	22.19	23.94	23.94	23.94	23.94	23.94



BUREAU VERITAS

FCC SAR Test Report



Certificate #6613.01

Output Power Verification in dBm for EUT Top Side (moving toward phantom)											
Distance (mm)	16	17	18	19	20	21	22	23	24	25	26
GSM1900 Ch810 (GPRS 3Tx Slot)	23.91	23.91	23.91	23.91	23.91	23.91	24.76	24.76	24.76	24.76	24.76
WCDMA II Ch9400 (RMC12.2K)	19.20	19.20	19.20	19.20	19.20	19.20	23.13	23.13	23.13	23.13	23.13
WCDMA IV Ch1413 (RMC12.2K)	21.52	21.52	21.52	21.52	21.52	21.52	23.33	23.33	23.33	23.33	23.33
LTE 2 Ch18900 (QPSK20M 1RB_OS50)	17.28	17.28	17.28	17.28	17.28	17.28	23.16	23.16	23.16	23.16	23.16
LTE 7 Ch20850 (QPSK20M 1RB_OS50)	17.99	17.99	17.99	17.99	17.99	17.99	23.01	23.01	23.01	23.01	23.01
LTE 38 Ch38000 (QPSK20M 1RB_OS0)	20.25	20.25	20.25	20.25	20.25	20.25	23.34	23.34	23.34	23.34	23.34
LTE 41 Ch39750 (QPSK20M 1RB_OS0)	20.59	20.59	20.59	20.59	20.59	20.59	23.49	23.49	23.49	23.49	23.49
LTE 66 Ch132072 (QPSK20M 1RB_OS50)	20.38	20.38	20.38	20.38	20.38	20.38	23.63	23.63	23.63	23.63	23.63
NR n2 Ch376000 (DFT-QPSK20M_1RB_OS53)	18.78	18.78	18.78	18.78	18.78	18.78	23.54	23.54	23.54	23.54	23.54
NR n7 Ch505000 (DFT-QPSK50M_1RB_OS135)	18.74	18.74	18.74	18.74	18.74	18.74	23.57	23.57	23.57	23.57	23.57
NR n38 Ch520000 (DFT-QPSK40M_1RB_OS53)	19.11	19.11	19.11	19.11	19.11	19.11	23.54	23.54	23.54	23.54	23.54
NR n41 Ch518598 (DFT-QPSK100M_1RB_OS137)	19.27	19.27	19.27	19.27	19.27	19.27	24.04	24.04	24.04	24.04	24.04
NR n66 Ch349000 (DFT-QPSK80M_1RB_OS107)	22.19	22.19	22.19	22.19	22.19	22.19	23.94	23.94	23.94	23.94	23.94



BUREAU
VERITAS

FCC SAR Test Report



Certificate #6613.01

Output Power Verification in dBm for EUT Top Side (moving away phantom)											
Distance (mm)	16	17	18	19	20	21	22	23	24	25	26
GSM1900 Ch810 (GPRS 3Tx Slot)	23.91	23.91	23.91	23.91	23.91	23.91	24.76	24.76	24.76	24.76	24.76
WCDMA II Ch9400 (RMC12.2K)	19.20	19.20	19.20	19.20	19.20	19.20	23.13	23.13	23.13	23.13	23.13
WCDMA IV Ch1413 (RMC12.2K)	21.52	21.52	21.52	21.52	21.52	21.52	23.33	23.33	23.33	23.33	23.33
LTE 2 Ch18900 (QPSK20M_1RB_OS50)	17.28	17.28	17.28	17.28	17.28	17.28	23.16	23.16	23.16	23.16	23.16
LTE 7 Ch20850 (QPSK20M_1RB_OS50)	17.99	17.99	17.99	17.99	17.99	17.99	23.01	23.01	23.01	23.01	23.01
LTE 38 Ch38000 (QPSK20M_1RB_OS0)	20.25	20.25	20.25	20.25	20.25	20.25	23.34	23.34	23.34	23.34	23.34
LTE 41 Ch39750 (QPSK20M_1RB_OS0)	20.59	20.59	20.59	20.59	20.59	20.59	23.49	23.49	23.49	23.49	23.49
LTE 66 Ch132072 (QPSK20M_1RB_OS50)	20.38	20.38	20.38	20.38	20.38	20.38	23.63	23.63	23.63	23.63	23.63
NR n2 Ch376000 (DFT-QPSK20M_1RB_OS53)	18.78	18.78	18.78	18.78	18.78	18.78	23.54	23.54	23.54	23.54	23.54
NR n7 Ch505000 (DFT-QPSK50M_1RB_OS135)	18.74	18.74	18.74	18.74	18.74	18.74	23.57	23.57	23.57	23.57	23.57
NR n38 Ch520000 (DFT-QPSK40M_1RB_OS53)	19.11	19.11	19.11	19.11	19.11	19.11	23.54	23.54	23.54	23.54	23.54
NR n41 Ch518598 (DFT-QPSK100M_1RB_OS137)	19.27	19.27	19.27	19.27	19.27	19.27	24.04	24.04	24.04	24.04	24.04
NR n66 Ch349000 (DFT-QPSK80M_1RB_OS107)	22.19	22.19	22.19	22.19	22.19	22.19	23.94	23.94	23.94	23.94	23.94



BUREAU
VERITAS

FCC SAR Test Report



Certificate #6613.01

WWAN Ant-5

DS14

Output Power Verification in dBm for EUT Front Face (moving toward phantom)											
Distance (mm)	16	17	18	19	20	21	22	23	24	25	26
LTE 42 Ch42990 (QPSK20M_1RB_OS50)	21.19	21.19	21.19	21.19	21.19	21.19	22.47	22.47	22.47	22.47	22.47
(ENDC) LTE 42 Ch42990 (QPSK20M_1RB_OS50)	19.08	19.08	19.08	19.08	19.08	19.08	22.47	22.47	22.47	22.47	22.47
LTE 48 Ch55340 (QPSK20M_1RB_OS50)	21.25	21.25	21.25	21.25	21.25	21.25	22.49	22.49	22.49	22.49	22.49
NR n48 Ch640000 (DFT-QPSK100M_ 1RB_OS137)	18.92	18.92	18.92	18.92	18.92	18.92	23.04	23.04	23.04	23.04	23.04
NR n77 Ch633334 (DFT-QPSK100M_ 1RB_OS137)	18.99	18.99	18.99	18.99	18.99	18.99	23.23	23.23	23.23	23.23	23.23
ENDC NR n77 Ch633334 (DFT-QPSK100M_ 1RB_OS137)	16.45	16.45	16.45	16.45	16.45	16.45	23.23	23.23	23.23	23.23	23.23
NR n78 Ch633334 (DFT-QPSK100M_ 1RB_OS137)	18.87	18.87	18.87	18.87	18.87	18.87	23.01	23.01	23.01	23.01	23.01
ENDC NR n78 Ch633334 (DFT-QPSK100M_ 1RB_OS137)	16.35	16.35	16.35	16.35	16.35	16.35	23.01	23.01	23.01	23.01	23.01



BUREAU
VERITAS

FCC SAR Test Report



Certificate #6613.01

Output Power Verification in dBm for EUT Front Face (moving away phantom)											
Distance (mm)	16	17	18	19	20	21	22	23	24	25	26
LTE 42 Ch42990 (QPSK20M_1RB_OS50)	21.19	21.19	21.19	21.19	21.19	21.19	22.47	22.47	22.47	22.47	22.47
(ENDC) LTE 42 Ch42990 (QPSK20M_1RB_OS50)	19.08	19.08	19.08	19.08	19.08	19.08	22.47	22.47	22.47	22.47	22.47
LTE 48 Ch55340 (QPSK20M_1RB_OS50)	21.25	21.25	21.25	21.25	21.25	21.25	22.49	22.49	22.49	22.49	22.49
NR n48 Ch640000 (DFT-QPSK100M_ 1RB_OS137)	18.92	18.92	18.92	18.92	18.92	18.92	23.04	23.04	23.04	23.04	23.04
NR n77 Ch633334 (DFT-QPSK100M_ 1RB_OS137)	18.99	18.99	18.99	18.99	18.99	18.99	23.23	23.23	23.23	23.23	23.23
ENDC NR n77 Ch633334 (DFT-QPSK100M_ 1RB_OS137)	16.45	16.45	16.45	16.45	16.45	16.45	23.23	23.23	23.23	23.23	23.23
NR n78 Ch633334 (DFT-QPSK100M_ 1RB_OS137)	18.87	18.87	18.87	18.87	18.87	18.87	23.01	23.01	23.01	23.01	23.01
ENDC NR n78 Ch633334 (DFT-QPSK100M_ 1RB_OS137)	16.35	16.35	16.35	16.35	16.35	16.35	23.01	23.01	23.01	23.01	23.01



BUREAU
VERITAS

FCC SAR Test Report



Certificate #6613.01

Output Power Verification in dBm for EUT Rear Face (moving toward phantom)											
Distance (mm)	16	17	18	19	20	21	22	23	24	25	26
LTE 42 Ch42990 (QPSK20M_1RB_OS50)	21.19	21.19	21.19	21.19	21.19	21.19	22.47	22.47	22.47	22.47	22.47
(ENDC) LTE 42 Ch42990 (QPSK20M_1RB_OS50)	19.08	19.08	19.08	19.08	19.08	19.08	22.47	22.47	22.47	22.47	22.47
LTE 48 Ch55340 (QPSK20M_1RB_OS50)	21.25	21.25	21.25	21.25	21.25	21.25	22.49	22.49	22.49	22.49	22.49
NR n48 Ch640000 (DFT-QPSK100M_ 1RB_OS137)	18.92	18.92	18.92	18.92	18.92	18.92	23.04	23.04	23.04	23.04	23.04
NR n77 Ch633334 (DFT-QPSK100M_ 1RB_OS137)	18.99	18.99	18.99	18.99	18.99	18.99	23.23	23.23	23.23	23.23	23.23
ENDC NR n77 Ch633334 (DFT-QPSK100M_ 1RB_OS137)	16.45	16.45	16.45	16.45	16.45	16.45	23.23	23.23	23.23	23.23	23.23
NR n78 Ch633334 (DFT-QPSK100M_ 1RB_OS137)	18.87	18.87	18.87	18.87	18.87	18.87	23.01	23.01	23.01	23.01	23.01
ENDC NR n78 Ch633334 (DFT-QPSK100M_ 1RB_OS137)	16.35	16.35	16.35	16.35	16.35	16.35	23.01	23.01	23.01	23.01	23.01



BUREAU
VERITAS

FCC SAR Test Report



Certificate #6613.01

Output Power Verification in dBm for EUT Rear Face (moving away phantom)											
Distance (mm)	16	17	18	19	20	21	22	23	24	25	26
LTE 42 Ch42990 (QPSK20M_1RB_OS50)	21.19	21.19	21.19	21.19	21.19	21.19	22.47	22.47	22.47	22.47	22.47
(ENDC) LTE 42 Ch42990 (QPSK20M_1RB_OS50)	19.08	19.08	19.08	19.08	19.08	19.08	22.47	22.47	22.47	22.47	22.47
LTE 48 Ch55340 (QPSK20M_1RB_OS50)	21.25	21.25	21.25	21.25	21.25	21.25	22.49	22.49	22.49	22.49	22.49
NR n48 Ch640000 (DFT-QPSK100M_ 1RB_OS137)	18.92	18.92	18.92	18.92	18.92	18.92	23.04	23.04	23.04	23.04	23.04
NR n77 Ch633334 (DFT-QPSK100M_ 1RB_OS137)	18.99	18.99	18.99	18.99	18.99	18.99	23.23	23.23	23.23	23.23	23.23
ENDC NR n77 Ch633334 (DFT-QPSK100M_ 1RB_OS137)	16.45	16.45	16.45	16.45	16.45	16.45	23.23	23.23	23.23	23.23	23.23
NR n78 Ch633334 (DFT-QPSK100M_ 1RB_OS137)	18.87	18.87	18.87	18.87	18.87	18.87	23.01	23.01	23.01	23.01	23.01
ENDC NR n78 Ch633334 (DFT-QPSK100M_ 1RB_OS137)	16.35	16.35	16.35	16.35	16.35	16.35	23.01	23.01	23.01	23.01	23.01



BUREAU
VERITAS

FCC SAR Test Report



Certificate #6613.01

Output Power Verification in dBm for EUT Top Side (moving toward phantom)											
Distance (mm)	16	17	18	19	20	21	22	23	24	25	26
LTE 42 Ch42990 (QPSK20M_1RB_OS50)	21.19	21.19	21.19	21.19	21.19	21.19	22.47	22.47	22.47	22.47	22.47
(ENDC) LTE 42 Ch42990 (QPSK20M_1RB_OS50)	19.08	19.08	19.08	19.08	19.08	19.08	22.47	22.47	22.47	22.47	22.47
LTE 48 Ch55340 (QPSK20M_1RB_OS50)	21.25	21.25	21.25	21.25	21.25	21.25	22.49	22.49	22.49	22.49	22.49
NR n48 Ch640000 (DFT-QPSK100M_ 1RB_OS137)	18.92	18.92	18.92	18.92	18.92	18.92	23.04	23.04	23.04	23.04	23.04
NR n77 Ch633334 (DFT-QPSK100M_ 1RB_OS137)	18.99	18.99	18.99	18.99	18.99	18.99	23.23	23.23	23.23	23.23	23.23
ENDC NR n77 Ch633334 (DFT-QPSK100M_ 1RB_OS137)	16.45	16.45	16.45	16.45	16.45	16.45	23.23	23.23	23.23	23.23	23.23
NR n78 Ch633334 (DFT-QPSK100M_ 1RB_OS137)	18.87	18.87	18.87	18.87	18.87	18.87	23.01	23.01	23.01	23.01	23.01
ENDC NR n78 Ch633334 (DFT-QPSK100M_ 1RB_OS137)	16.35	16.35	16.35	16.35	16.35	16.35	23.01	23.01	23.01	23.01	23.01



BUREAU
VERITAS

FCC SAR Test Report



Certificate #6613.01

Output Power Verification in dBm for EUT Top Side (moving away phantom)											
Distance (mm)	16	17	18	19	20	21	22	23	24	25	26
LTE 42 Ch42990 (QPSK20M_1RB_OS50)	21.19	21.19	21.19	21.19	21.19	21.19	22.47	22.47	22.47	22.47	22.47
(ENDC) LTE 42 Ch42990 (QPSK20M_1RB_OS50)	19.08	19.08	19.08	19.08	19.08	19.08	22.47	22.47	22.47	22.47	22.47
LTE 48 Ch55340 (QPSK20M_1RB_OS50)	21.25	21.25	21.25	21.25	21.25	21.25	22.49	22.49	22.49	22.49	22.49
NR n48 Ch640000 (DFT-QPSK100M_ 1RB_OS137)	18.92	18.92	18.92	18.92	18.92	18.92	23.04	23.04	23.04	23.04	23.04
NR n77 Ch633334 (DFT-QPSK100M_ 1RB_OS137)	18.99	18.99	18.99	18.99	18.99	18.99	23.23	23.23	23.23	23.23	23.23
ENDC NR n77 Ch633334 (DFT-QPSK100M_ 1RB_OS137)	16.45	16.45	16.45	16.45	16.45	16.45	23.23	23.23	23.23	23.23	23.23
NR n78 Ch633334 (DFT-QPSK100M_ 1RB_OS137)	18.87	18.87	18.87	18.87	18.87	18.87	23.01	23.01	23.01	23.01	23.01
ENDC NR n78 Ch633334 (DFT-QPSK100M_ 1RB_OS137)	16.35	16.35	16.35	16.35	16.35	16.35	23.01	23.01	23.01	23.01	23.01

< Proximity Sensor Coverage >

In KDB 616217 section 6.3, if a sensor is spatially offset from the antenna(s), it is necessary to verify sensor triggering for conditions where the antenna is next to the user but the sensor is laterally further away to ensure sensor coverage is sufficient for reducing the power to maintain compliance. For p-sensor coverage testing, the device is moved and “along the direction of maximum antenna and sensor offset”.

However, this device uses a capacitive proximity sensor that is same metallic component as the transmitting antenna to facilitate triggering in any condition the user may use the device in proximity of the antenna in the device. Therefore, no further sensor coverage assessments were required.

<Proximity Sensor Tilt Angle Influences>

The proximity sensor tilt angle influence was determined per KDB 616217 for applicable edge. Summary for proximity sensor tilt angle influence is shown in below.

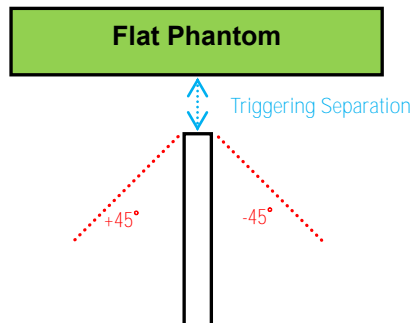

Antenna	Orientation	Separation Distance (mm)	Tilt Angle										
			-45°	-40°	-30°	-20°	-10°	0°	10°	20°	30°	40°	45°
Ant 1	Bottom Side	21	On	On	On	On	On	On	On	On	On	On	On
Ant 2	Left Side	16	On	On	On	On	On	On	On	On	On	On	On
Ant 3	Left Side	16	On	On	On	On	On	On	On	On	On	On	On
Ant 4	Top Side	21	On	On	On	On	On	On	On	On	On	On	On
Ant 5	Top Side	21	On	On	On	On	On	On	On	On	On	On	On

<Summary for Proximity Sensor Triggering Test>

According to the procedures noticed in KDB 616217 D04

The conservation triggering distances based on the separation distance for the sensor trigger / not triggered as EUT with power reduction at 0 mm, and EUT without power reduction is shown as below.

Antenna / Test position	Front Face	Rear Face	Left Side	Right Side	Top Side	Bottom Side
WWAN-Ant 1	21mm	21mm	-	-	-	21mm
WWAN-Ant 2	21mm	21mm	16mm	-	-	-
WWAN-Ant 3	21mm	21mm	16mm	-	-	-
WWAN-Ant 4	21mm	21mm	-	-	21mm	-
WWAN-Ant 5	21mm	21mm	-	-	21mm	-

The power reduction is depends on the proximity sensor input. For a steady SAR test, the power reduction was enabled or disabled manually by engineering software during SAR testing.

<Considerations Related to GSM / GPRS / EDGE for Setup and Testing>

The maximum multi-slot capability supported by this device is as below.

1. This EUT is class B device
2. This EUT supports GPRS multi-slot class 12 (max. uplink: 4, max. downlink: 4, total timeslots: 5)
3. This EUT supports EDGE multi-slot class 12 (max. uplink: 4, max. downlink: 4, total timeslots: 5)

For GSM850 frequency band, the power control level is set to 5 for GSM mode and GPRS (GMSK: CS1), and set to 8 for EDGE (GMSK: MCS1, 8PSK: MCS9). For GSM1900 frequency band, the power control level is set to 0 for GSM mode and GPRS (GMSK: CS1), and set to 2 for EDGE (GMSK: MCS1, 8PSK: MCS9).

SAR test reduction for GPRS and EDGE modes is determined by the source-based time-averaged output power specified for production units, including tune-up tolerance. The data mode with highest specified time-averaged output power should be tested for SAR compliance in the applicable exposure conditions. For modes with the same specified maximum output power and tolerance, the higher number time-slot configuration should be tested.

The frame-averaged power is linearly proportion to the slot number configured and it is linearly scaled the maximum burst-averaged power based on time slots. The calculated method is shown as below:

Frame-averaged power = 10 x log (Burst-averaged power mW x Slot used / 8)

<Considerations Related to WCDMA for Setup and Testing>

WCDMA Handsets Head SAR

SAR for next to the ear head exposure is measured using a 12.2 kbps RMC with TPC bits configured to all "1's". The 3G SAR test reduction procedure is applied to AMR configurations with 12.2 kbps RMC as the primary mode.

WCDMA Handsets Body-worn SAR

SAR for body-worn configurations is measured using a 12.2 kbps RMC with TPC bits configured to all "1's". The 3G SAR test reduction procedure is applied to other spreading codes and multiple DPDCH_n configurations supported by the handset with 12.2 kbps RMC as the primary mode.

Handsets with Release 5 HSDPA

The 3G SAR test reduction procedure is applied to HSDPA body-worn configurations with 12.2 kbps RMC as the primary mode. Otherwise, SAR is measured for HSDPA using the HSDPA body SAR procedures in the "Release 5 HSDPA Data Devices", for the highest reported SAR body-worn exposure configuration in 12.2 kbps RMC. Handsets with both HSDPA and HSUPA are tested according to Release 6 HSPA test procedures.

Handsets with Release 6 HSUPA

The 3G SAR test reduction procedure is applied to HSPA (HSUPA/HSDPA with RMC) body-worn configurations with 12.2 kbps RMC as the primary mode. Otherwise, SAR is measured for HSPA using the HSPA body SAR procedures in the "Release 6 HSPA Data Devices", for the highest reported body-worn exposure SAR configuration in 12.2 kbps RMC. When VOIP is applicable for next to the ear head exposure in HSPA, the 3G SAR test reduction procedure is applied to HSPA with 12.2 kbps RMC as the primary mode; otherwise, the same HSPA configuration used for body-worn measurements is tested for next to the ear head exposure.

Release 5 HSDPA Data Devices

The 3G SAR test reduction procedure is applied to body SAR with 12.2 kbps RMC as the primary mode. Otherwise, body SAR for HSDPA is measured using an FRC with H-Set 1 in Sub-test 1 and a 12.2 kbps RMC configured in Test Loop Mode 1, for the highest reported SAR configuration in 12.2 kbps RMC without HSDPA. HSDPA is configured according to the applicable UE category of a test device. The number of HS-DSCH / HS-PDSCHs, HARQ processes, minimum inter-TTI interval, transport block sizes and RV coding sequence are defined by the H-set. To maintain a consistent test configuration and stable transmission conditions, QPSK is used in the H-set for SAR testing. HS-DPCCH should be configured with a CQI feedback cycle of 4 ms and a CQI repetition factor of 2 to maintain a constant rate of active CQI slots. DPCCH and DPDCH gain factors (β_c , β_d), and HS-DPCCH power offset parameters (Δ_{ACK} , Δ_{NACK} , Δ_{CQI}) are set according to values indicated in below. The CQI value is determined by the UE category, transport block size, number of HS-PDSCHs and modulation used in the H-set.

Sub-test	β_c	β_d	β_d (SF)	β_c / β_d	$\beta_{hs}^{(1)}$	CM (dB) ⁽²⁾	MPR
1	2 / 15	15 / 15	64	2 / 15	4 / 15	0.0	0
2	12 / 15 ⁽³⁾	15 / 15 ⁽³⁾	64	12 / 15 ⁽³⁾	24 / 15	1.0	0
3	15 / 15	8 / 15	64	15 / 8	30 / 15	1.5	0.5
4	15 / 15	4 / 15	64	15 / 4	30 / 15	1.5	0.5

Note 1: Δ_{ACK} , Δ_{NACK} and $\Delta_{CQI} = 8 \Leftrightarrow A_{hs} = \beta_{hs} / \beta_c = 30 / 15 \Leftrightarrow \beta_{hs} = 30 / 15 * \beta_c$.

Note 2: CM = 1 for $\beta_c / \beta_d = 12 / 15$, $\beta_{hs} / \beta_c = 24 / 15$.

Note 3: For subtest 2 the β_c / β_d ratio of 12 / 15 for the TFC during the measurement period (TF1, TF0) is achieved by setting the signaled gain factors for the reference TFC (TF1, TF1) to $\beta_c = 11 / 15$ and $\beta_d = 15 / 15$.

Release 6 HSUPA Data Devices

The 3G SAR test reduction procedure is applied to body SAR with 12.2 kbps RMC as the primary mode. Otherwise, body SAR for HSPA is measured with E-DCH Sub-test 5, using H-Set 1 and QPSK for FRC and a 12.2 kbps RMC configured in Test Loop Mode 1 and power control algorithm 2, according to the highest reported body SAR configuration in 12.2 kbps RMC without HSPA. When VOIP applies to head exposure, the 3G SAR test reduction procedure is applied with 12.2 kbps RMC as the primary mode. Otherwise, the same HSPA configuration used for body SAR measurements are applied to head exposure testing. Due to inner loop power control requirements in HSPA, a communication test set is required for output power and SAR tests. The 12.2 kbps RMC, FRC H-set 1 and E-DCH configurations for HSPA are configured according to the β values indicated in below.

Sub-test	β_c	β_d	β_d (SF)	β_c / β_d	$\beta_{hs}^{(1)}$	β_{ac}	β_{ed}	β_{ed} (SF)	β_{ed} (codes)	CM ⁽²⁾ (dB)	MPR (dB)	AG ⁽⁴⁾ Index	E-TFCI
1	11 / 15 ⁽³⁾	15 / 15 ⁽³⁾	64	11 / 15 ⁽³⁾	22 / 15	209 / 225	1039 / 225	4	1	1.0	0.0	20	75
2	6 / 15	15 / 15	64	6 / 15	12 / 15	12 / 15	94 / 75	4	1	3.0	2.0	12	67
3	15 / 15	9 / 15	64	15 / 9	30 / 15	30 / 15	$\beta_{ed1}: 47/15$ $\beta_{ed2}: 47/15$	4	2	2.0	1.0	15	92
4	2 / 15	15 / 15	64	2 / 15	4 / 15	2 / 15	56 / 75	4	1	3.0	2.0	17	71
5	15 / 15 ⁽⁴⁾	15 / 15 ⁽⁴⁾	64	15 / 15 ⁽⁴⁾	30 / 15	24 / 15	134 / 15	4	1	1.0	0.0	21	81

Note 1: $\Delta_{ACK}, \Delta_{NACK}$ and $\Delta_{COI} = 8 \Leftrightarrow A_{hs} = \beta_{hs} / \beta_c = 30 / 15 \Leftrightarrow \beta_{hs} = 30 / 15 * \beta_c$
 Note 2: CM = 1 for $\beta_c / \beta_d = 12 / 15, \beta_{hs} / \beta_c = 24 / 15$. For all other combinations of DPDCH, DPCCH, HS-DPCCH, E-DPDCH and E-DPCCH the MPR is based on the relative CM difference.
 Note 3: For subtest 1 the β_c / β_d ratio of 11 / 15 for the TFC during the measurement period (TF1, TF0) is achieved by setting the signaled gain factors for the reference TFC (TF1, TF1) to $\beta_c = 10 / 15$ and $\beta_d = 15 / 15$.
 Note 4: For subtest 5 the β_c / β_d ratio of 15 / 15 for the TFC during the measurement period (TF1, TF0) is achieved by setting the signaled gain factors for the reference TFC (TF1, TF1) to $\beta_c = 14 / 15$ and $\beta_d = 15 / 15$.
 Note 5: Testing UE using E-DPDCH Physical Layer category 1 Sub-test 3 is not required according to TS 25.306 Table 5.1g.
 Note 6: β_{ed} cannot be set directly; it is set by Absolute Grant Value.

DC-HSDPA SAR Guidance

The 3G SAR test reduction procedure is applied to DC-HSDPA with 12.2 kbps RMC as the primary mode. Otherwise, when SAR is required for Rel. 5 HSDPA, SAR is required for Rel. 8 DC-HSDPA. Power is measured for DC-HSDPA according to the H-Set 12, FRC configuration in Table C.8.1.12 of 3GPP TS 34.121-1 to determine SAR test reduction. A primary and a secondary serving HS-DSCH Cell are required to perform the power measurement and for the results to be acceptable.

<Considerations Related to LTE for Setup and Testing>

This device contains LTE transmitter which follows 3GPP standards, supports both QPSK 16QAM and 64QAM modulations, and supported LTE band and channel bandwidth is listed in below. The output power was tested per 3GPP TS 36.521-1 maximum transmit procedures for both QPSK 16QAM and 64QAM modulation. The results please refer to section 4.6 of this report.

EUT Supported LTE Band and Channel Bandwidth						
LTE Band	BW 1.4 MHz	BW 3 MHz	BW 5 MHz	BW 10 MHz	BW 15 MHz	BW 20 MHz
2	V	V	V	V	V	V
4	V	V	V	V	V	V
5	V	V	V	V		
7			V	V	V	V
12	V	V	V	V		
13			V	V		
17			V	V		
26	V	V	V	V	V	
38			V	V	V	V
41			V	V	V	V
42			V	V	V	V
48			V	V	V	V
66	V	V	V	V	V	V

The LTE maximum power reduction (MPR) in accordance with 3GPP TS 36.101 is active all times during LTE operation. The allowed MPR for the maximum output power is specified in below.

Modulation	Channel Bandwidth / RB Configurations						LTE MPR Setting (dB)
	BW 1.4 MHz	BW 3 MHz	BW 5 MHz	BW 10 MHz	BW 15 MHz	BW 20 MHz	
QPSK	> 5	> 4	> 8	> 12	> 16	> 18	1
16QAM	<= 5	<= 4	<= 8	<= 12	<= 16	<= 18	1
16QAM	> 5	> 4	> 8	> 12	> 16	> 18	2
64QAM	<= 5	<= 4	<= 8	<= 12	<= 16	<= 18	2
64QAM	> 5	> 4	> 8	> 12	> 16	> 18	3

Note: MPR is according to the standard and implemented in the circuit (mandatory).

In addition, the device is compliant with additional maximum power reduction (A-MPR) requirements defined in 3GPP TS 36.101 section 6.2.4 that was disabled for all FCC compliance testing.

During LTE SAR testing, the related parameters of operating band, channel bandwidth, uplink channel number, modulation type, and RB was set in base station simulator. When the EUT has registered and communicated to base station simulator, the simulator set to make EUT transmitting the maximum radiated power.

TDD-LTE Setup Configurations

According to KDB 941225 D05, SAR testing for TDD-LTE device must be tested using a fixed periodic duty factor according to the highest transmission duty factor implemented for the device and supported by the defined 3GPP TDD-LTE configurations. The TDD-LTE of this device supports frame structure type 2 defined in 3GPP TS 36.211 section 4.2, and the frame structure configuration can be referred to below.

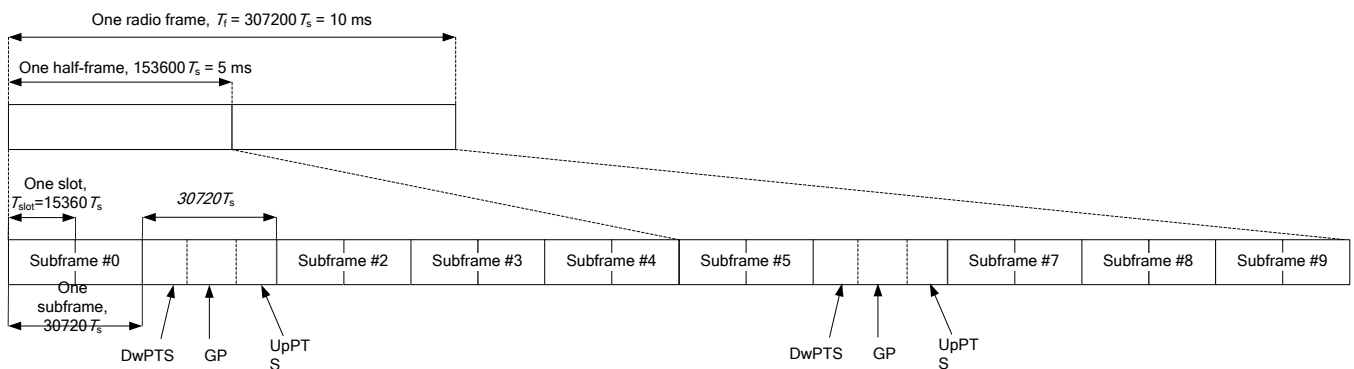

3GPP TS 36.211 Figure 4.2-1: Frame Structure Type 2

Special Subframe Configuration	Normal Cyclic Prefix in Downlink			Extended Cyclic Prefix in Downlink		
	DwPTS	UpPTS		DwPTS	UpPTS	
		Normal Cyclic Prefix in Uplink	Extended Cyclic Prefix in Uplink		Normal Cyclic Prefix in Uplink	Extended Cyclic Prefix in Uplink
0	6592 • Ts	2192 • Ts	2560 • Ts	7680 • Ts	2192 • Ts	2560 • Ts
1	19760 • Ts			20480 • Ts		
2	21952 • Ts			23040 • Ts		
3	24144 • Ts			25600 • Ts		
4	26336 • Ts	4384 • Ts	5120 • Ts	7680 • Ts	4384 • Ts	5120 • Ts
5	6592 • Ts			20480 • Ts		
6	19760 • Ts			23040 • Ts		
7	21952 • Ts			12800 • Ts		
8	24144 • Ts			-	-	-
9	13168 • Ts			-	-	-

3GPP TS 36.211 Table 4.2-1: Configuration of Special Subframe

Uplink-Downlink Configuration	Downlink-to-Uplink Switch-Point Periodicity	Subframe Number										
		0	1	2	3	4	5	6	7	8	9	
0	5 ms	D	S	U	U	U	D	S	U	U	U	
1	5 ms	D	S	U	U	D	D	S	U	U	D	
2	5 ms	D	S	U	D	D	D	S	U	D	D	
3	10 ms	D	S	U	U	U	D	D	D	D	D	
4	10 ms	D	S	U	U	D	D	D	D	D	D	
5	10 ms	D	S	U	D	D	D	D	D	D	D	
6	5 ms	D	S	U	U	U	D	S	U	U	D	

3GPP TS 36.211 Table 4.2-2: Uplink-Downlink Configurations

The variety of different TD-LTE uplink-downlink configurations allows a network operator to allocate the network's capacity between uplink and downlink traffic to meet the needs of the network. The uplink duty cycle of these seven configurations can readily be computed and shown in below.

UL-DL Configuration	0	1	2	3	4	5	6
Highest Duty-Cycle	63.33%	43.33%	23.33%	31.67%	21.67%	11.67%	53.33%

Considering the highest transmission duty cycle, TDD-LTE was tested using Uplink-Downlink Configuration 0 with 6 uplink subframe and 2 special subframe. The special subframe was set to special subframe configuration 7 using extended cyclic prefix uplink. Therefore, SAR testing for TDD-LTE was performed at the maximum output power with highest transmission duty cycle of 63.33%.

LTE Uplink Carrier Aggregation (Intra-Band) Setup Configurations

1. The conducted power for uplink CA active was measured on the highest reported SAR configuration for each exposure condition with both two carrier components was set to largest channel bandwidth.
2. The SAR testing was performed with the single carrier (uplink CA is inactive) for all test positions for each exposure condition. The LTE uplink CA active was verified with maximum output power on the highest SAR configuration of single carrier for each exposure condition. For intra-band contiguous CA, the SCC channel was set to closest available contiguous channel.

EUT Supported Combinations of Uplink Carrier Aggregation	
Intra-Band 2CC Uplink CA Operating Bands	
CA_7C, CA_38C	

LTE Uplink Carrier Aggregation (Inter-Band) Setup Configurations

LTE Uplink CA	2CC Uplink Carrier Aggregation	
	Tx Antenna	
	PCC	SCC
CA_2A-4A	Ant 1	Ant 3
CA_2A-4A	Ant 4	Ant 3
CA_4A-5A	Ant 4	Ant 1
CA_4A-5A	Ant 1	Ant 4
CA_4A-7A	Ant 1	Ant 3
CA_4A-7A	Ant 4	Ant 3

Note:

1. According to October 2018 TCB workshop, uplink CA SAR test guidance as follows:
 - (a). Provide the single uplink SAR values you have obtained for the relevant SAR configuration and frequency bands that employ inter-band uplink carrier aggregation.
 - (b). If the single uplink 1g SAR values for each band are both less than 0.8W/kg and the algebraic summation of the 1g SAR values are less than 1.45W/kg no additional measurements need to be performed.
 - (c). If one on the single uplink 1g SAR values is greater than 0.8W/kg, instead of algebraically summing the 1g SAR values sum up the SAR distributions, like the enlarged zoom scan (volume scan) procedures found in FCC KDB publication 865664 D01 SAR measurement 100MHz to 6GHz V01r04.
 - (d). If the algebraic sum of the 1g SAR values is > 1.45W/kg additional measurements may have to be made. Submit a KDB inquiry for additional guidance.
2. The single carrier of inter band CA uplink power level is the same as Non-CA standalone LTE power level. In this report, simultaneous transmission compliance was evaluated using standalone LTE SAR mode.
3. The single uplink 1g SAR values for each band are both less than 0.8W/kg and the algebraic summation of the 1g SAR value are less than 1.45W/kg, additional measurements are not required.

Please refer to Appendix E for data details

<Considerations Related to 5G NR for Setup and Testing>

1. The 5G NR supports both SA and NSA modes. The details are as follows:

Mode	Band	Duplex	SCS(KHz)	BW(M)
NSA	5G NR n5	FDD	15	5,10,15,20
	5G NR n7	FDD	15	5, 10, 15, 20, 25, 30, 40, 50
			30	10, 15, 20, 25, 30, 40, 50
	5G NR n38	TDD	15	5, 10, 15, 20, 25, 30, 40
			30	10, 15, 20, 25, 30, 40
	5G NR n41	TDD	15	10, 15, 20, 30, 40, 50
			30	10, 15, 20, 30, 40, 50, 60, 70, 80, 90,100
	5G NR n66	FDD	15	5, 10, 15, 20, 25, 30, 35, 40
			30	10, 15, 20, 25, 30, 35, 40
	5G NR n77	TDD	15	10, 15, 20, 40, 50, 60, 70, 80, 90, 100
			30	10, 15, 20, 40, 50
	5G NR n78	TDD	15	10, 15, 20, 40, 50, 60, 70, 80, 90, 100
			30	10, 15, 20, 40, 50, 60, 70, 80, 90, 100
	SA	5G NR n2	FDD	15
30				10, 15, 20
5G NR n5		FDD	15	5,10,15,20
5G NR n7		FDD	15	5, 10, 15, 20, 25, 30, 40, 50
			30	10, 15, 20, 25, 30, 40, 50
5G NR n26		FDD	15	5,10,15,20
5G NR n38		TDD	15	5, 10, 15, 20, 25, 30, 40
			30	10, 15, 20, 25, 30, 40
5G NR n41		TDD	15	10, 15, 20, 30, 40, 50
			30	10, 15, 20, 30, 40, 50, 60, 70, 80, 90,100
5G NR n48		TDD	15	10, 15, 20, 40, 50
			30	10, 15, 20, 30, 40, 50, 60, 70, 80, 90,100
5G NR n66		FDD	15	5, 10, 15, 20, 25, 30, 35, 40
			30	10, 15, 20, 25, 30, 35, 40
5G NR n77	TDD	15	10, 15, 20, 40, 50	
		30	10, 15, 20, 40, 50, 60, 70, 80, 90, 100	
5G NR n78	TDD	15	10, 15, 20, 40, 50	
		30	10, 15, 20, 40, 50, 60, 70, 80, 90, 100	

2. For 5G NR test procedure was following step similar FCC KDB 941225 D05:

(1) For DFT-OFDM and CP-OFDM output power measurement reduction, according to 38.101 maximum power

reduction for power class2 and 3, the CP-OFDM mode will not higher than DFT-OFDM mode, therefore, similar FCC KB 941225 D05 procedure for other modulation output power for each RB allocation configuration is > not ½ dB higher than the same configuration in DFT-QPSK and the reported SAR for the DFT-QPSK configuration is ≤ 1.45 W/kg; CP-OFDM testing is not required.

- (2) For DFT-OFDM output power measurement reduction, according to 38.101 maximum power reduction for power class2 and 3, for 16QAM/64QAM/256QAM and smaller bandwidth output power will spot check largest channel bandwidth worst RB configuration to ensure the 16QAM/64QAM/256QAM and smaller bandwidth output power will not ½ dB higher than the same configuration in the largest supported bandwidth.
- (3) SAR testing start with the largest channel bandwidth and measure SAR for QPSK with 1 RB allocation, using the RB offset and required test channel combination with the highest maximum output power for RB offset at the upper edge, middle and lower edge of each required test channel.
- (4) 50% RB allocation for QPSK SAR testing follows 1RB QPSK allocation procedure.
- (5) QPSK with 100% RB allocation, SAR is not required when the highest maximum output power for 100 % RB allocation is less than the highest maximum output power in 50% and 1 RB allocations and the highest reported SAR for 1 RB and 50% RB allocation are ≤ 0.8 W/kg. Otherwise, SAR is measured for the highest output power channel, and if the reported SAR is > 1.45 W/kg, the remaining required test channels must also be tested.
- (6) Pi/2 BPSK/16QAM/64QAM/256QAM output powers according to 3GPP MPR will not ½ dB higher than the same configuration in QPSK, also reported SAR for the QPSK configuration is less than 1.45 W/kg, Pi/2 BPSK/16QAM/64QAM/256QAM SAR testing are not required.
- (7) Smaller bandwidth output power for each RB allocation configuration for this device will not. ½ dB higher than the same configuration in the largest supported bandwidth, and the reported SAR for the largest supported bandwidth is ≤ 1.45 W/kg, smaller bandwidth SAR testing is not required for this device.

Table 6.2.2.3-1: Maximum power reduction (MPR) for power class 3

Modulation		MPR (dB)		
		Edge RB allocations	Outer RB allocations	Inner RB allocations
DFT-s-OFDM	Pi/2 BPSK	≤ 3.5 ¹	≤ 1.2 ¹	≤ 0.2 ¹
		≤ 0.5 ²		0 ²
	QPSK	≤ 1		0
	16 QAM	≤ 2		≤ 1
	64 QAM	≤ 2.5		
CP-OFDM	256 QAM	≤ 4.5		
	QPSK	≤ 3	≤ 1.5	
	16 QAM	≤ 3	≤ 2	
	64 QAM	≤ 3.5		
		≤ 6.5		
NOTE 1: Applicable for UE operating in TDD mode with Pi/2 BPSK modulation and UE indicates support for UE capability <i>powerBoosting-pi2BPSK</i> and if the IE <i>powerBoostPi2BPSK</i> is set to 1 and 40 % or less slots in radio frame are used for UL transmission for bands n40, n41, n77, n78 and n79. The reference power of 0dB MPR is 26dBm.				
NOTE 2: Applicable for UE operating in FDD mode, or in TDD mode in bands other than n40, n41, n77, n78 and n79 and if the IE <i>powerBoostPi2BPSK</i> is set to 0 and if more than 40% of slots in radio frame are used for UL transmission for bands n40, n41, n77, n78 and n79.				

3. NSA and SA mode should perform SAR separately. For the maximum power of NSA mode is the same as SA total power level. So, SA SAR can represent NSA mode SAR.
4. 5G NR NSA mode, the power level is the same as 5G NR SA mode, so 5G NR NSA mode and SA mode power

table only show one time.

- Due to test setup limitations, SAR testing for NR was performed using Factory Test Mode software to establish the connection.

ENDC Combination	Antenna TX	
	LTE TX	NR TX
DC_2A_n66A	Ant 3	Ant 1
DC_2A_n66A	Ant 3	Ant 4
DC_2A_n77A	Ant 3	Ant 5
DC_2A_n77A	Ant 3	Ant 7
DC_2A_n77A	Ant 3	Ant 2
DC_2A_n77A	Ant 3	Ant 3
DC_2A_n78A	Ant 3	Ant 5
DC_2A_n78A	Ant 3	Ant 7
DC_2A_n78A	Ant 3	Ant 2
DC_2A_n78A	Ant 3	Ant 3
DC_4A_n7A	Ant 3	Ant 1
DC_4A_n7A	Ant 3	Ant 4
DC_4A_n38A	Ant 3	Ant 1
DC_4A_n38A	Ant 3	Ant 4
DC_4A_n41A	Ant 3	Ant 1
DC_4A_n41A	Ant 3	Ant 4
DC_4A_n78A	Ant 3	Ant 5
DC_4A_n78A	Ant 3	Ant 7
DC_4A_n78A	Ant 3	Ant 2
DC_4A_n78A	Ant 3	Ant 3
DC_5A_n7A	Ant 1	Ant 4
DC_5A_n7A	Ant 4	Ant 1
DC_5A_n66A	Ant 1	Ant 4
DC_5A_n66A	Ant 4	Ant 1
DC_5A_n78A	Ant 1	Ant 5
DC_5A_n78A	Ant 1	Ant 7
DC_5A_n78A	Ant 1	Ant 2
DC_5A_n78A	Ant 1	Ant 3
DC_5A_n78A	Ant 4	Ant 5
DC_5A_n78A	Ant 4	Ant 7
DC_5A_n78A	Ant 4	Ant 2
DC_5A_n78A	Ant 4	Ant 3
DC_7A_n5A	Ant 4	Ant 1
DC_7A_n5A	Ant 1	Ant 4



BUREAU VERITAS

FCC SAR Test Report



Certificate #6613.01

ENDC Combination	Antenna TX	
	LTE TX	NR TX
DC_7A_n7A	Ant 3	Ant 1
DC_7A_n7A	Ant 3	Ant 4
DC_7A_n66A	Ant 3	Ant 1
DC_7A_n66A	Ant 3	Ant 4
DC_7A_n78A	Ant 3	Ant 5
DC_7A_n78A	Ant 3	Ant 7
DC_7A_n78A	Ant 3	Ant 2
DC_7A_n78A	Ant 3	Ant 3
DC_26A_n78A	Ant 1	Ant 5
DC_26A_n78A	Ant 1	Ant 7
DC_26A_n78A	Ant 1	Ant 2
DC_26A_n78A	Ant 1	Ant 3
DC_26A_n78A	Ant 4	Ant 5
DC_26A_n78A	Ant 4	Ant 7
DC_26A_n78A	Ant 4	Ant 2
DC_26A_n78A	Ant 4	Ant 3
DC_38A_n78A	Ant 3	Ant 5
DC_38A_n78A	Ant 3	Ant 7
DC_38A_n78A	Ant 3	Ant 2
DC_38A_n78A	Ant 3	Ant 3
DC_41A_n41A	Ant 3	Ant 1
DC_41A_n41A	Ant 3	Ant 4
DC_41A_n78A	Ant 3	Ant 5
DC_41A_n78A	Ant 3	Ant 7
DC_41A_n78A	Ant 3	Ant 2
DC_41A_n78A	Ant 3	Ant 3
DC_66A_n7A	Ant 3	Ant 1
DC_66A_n7A	Ant 3	Ant 4
DC_66A_n38A	Ant 3	Ant 1
DC_66A_n38A	Ant 3	Ant 4
DC_66A_n41A	Ant 3	Ant 1
DC_66A_n41A	Ant 3	Ant 4
DC_66A_n66A	Ant 3	Ant 1
DC_66A_n66A	Ant 3	Ant 4
DC_66A_n78A	Ant 3	Ant 5
DC_66A_n78A	Ant 3	Ant 7
DC_66A_n78A	Ant 3	Ant 2
DC_66A_n78A	Ant 3	Ant 3

Note: For ENDC Simultaneous SAR analysis is performed using standalone SAR summed together and they are more conservatively for ENDC.

<Considerations Related to WLAN for Setup and Testing>

In general, various vendor specific external test software and chipset based internal test modes are typically used for SAR measurement. These chipset based test mode utilities are generally hardware and manufacturer dependent, and often include substantial flexibility to reconfigure or reprogram a device. A Wi-Fi device must be configured to transmit continuously at the required data rate, channel bandwidth and signal modulation, using the highest transmission duty factor supported by the test mode tools for SAR measurement. The test frequencies established using test mode must correspond to the actual channel frequencies. When 802.11 frame gaps are accounted for in the transmission, a maximum transmission duty factor of 92 - 96% is typically achievable in most test mode configurations. A minimum transmission duty factor of 85% is required to avoid certain hardware and device implementation issues related to wide range SAR scaling. In addition, a periodic transmission duty factor is required for current generation SAR systems to measure SAR correctly. The reported SAR must be scaled to 100% transmission duty factor to determine compliance at the maximum tune-up tolerance limit.

According to KDB 248227 D01, this device has installed WLAN engineering testing software which can provide continuous transmitting RF signal. During WLAN SAR testing, this device was operated to transmit continuously at the maximum transmission duty with specified transmission mode, operating frequency, lowest data rate, and maximum output power.

Initial Test Configuration

An initial test configuration is determined for OFDM transmission modes in 2.4 GHz and 5 GHz bands according to the channel bandwidth, modulation and data rate combination(s) with the highest maximum output power specified for production units in each standalone and aggregated frequency band. When the same maximum power is specified for multiple transmission modes in a frequency band, the largest channel bandwidth, lowest order modulation, lowest data rate and lowest order 802.11a/g/n/ac mode is used for SAR measurement, on the highest measured output power channel in the initial test configuration, for each frequency band.

Subsequent Test Configuration

SAR measurement requirements for the remaining 802.11 transmission mode configurations that have not been tested in the initial test configuration are determined separately for each standalone and aggregated frequency band, in each exposure condition, according to the maximum output power specified for production units. Additional power measurements may be required to determine if SAR measurements are required for subsequent highest output power channels in a subsequent test configuration. When the highest reported SAR for the initial test configuration according to the initial test position or fixed exposure position requirements, is adjusted by the ratio of the subsequent test configuration to initial test configuration specified maximum output power and the adjusted SAR is ≤ 1.2 W/kg, SAR is not required for that subsequent test configuration.

SAR Test Configuration and Channel Selection

When multiple channel bandwidth configurations in a frequency band have the same specified maximum output power, the initial test configuration is using largest channel bandwidth, lowest order modulation, lowest data rate,

and lowest order 802.11 mode (i.e., 802.11a is chosen over 802.11n then 802.11ac or 802.11g is chosen over 802.11n). After an initial test configuration is determined, if multiple test channels have the same measured maximum output power, the channel chosen for SAR measurement is determined according to the following.

- 1) The channel closest to mid-band frequency is selected for SAR measurement.
- 2) For channels with equal separation from mid-band frequency; for example, high and low channels or two mid-band channels, the higher frequency (number) channel is selected for SAR measurement.

Test Reduction for U-NII-1 (5.2 GHz) and U-NII-2A (5.3 GHz) Bands

For devices that operate in both U-NII bands using the same transmitter and antenna(s), SAR test reduction is determined according to the following.

- 1) When the same maximum output power is specified for both bands, begin SAR measurement in U-NII-2A band by applying the OFDM SAR requirements. If the highest reported SAR for a test configuration is ≤ 1.2 W/kg, SAR is not required for U-NII-1 band for that configuration (802.11 mode and exposure condition).
- 2) When different maximum output power is specified for the bands, begin SAR measurement in the band with higher specified maximum output power. The highest reported SAR for the tested configuration is adjusted by the ratio of lower to higher specified maximum output power for the two bands. When the adjusted SAR is ≤ 1.2 W/kg, SAR is not required for the band with lower maximum output power in that test configuration.

<Considerations Related to Bluetooth for Setup and Testing>

This device has installed Bluetooth engineering testing software which can provide continuous transmitting RF signal. During Bluetooth SAR testing, this device was operated to transmit continuously at the maximum transmission duty with specified transmission mode, operating frequency, lowest data rate, and maximum output power

4.2 EUT Testing Position

According to KDB 648474 D04, handsets are tested for SAR compliance in head, body-worn accessory and other use configurations described in the following subsections.

4.2.1 Head Exposure Conditions

Head exposure is limited to next to the ear voice mode operations. Head SAR compliance is tested according to the test positions defined in IEEE Std 1528-2013 using the SAM phantom illustrated as below.

1. Define two imaginary lines on the handset
 - (a) The vertical centerline passes through two points on the front side of the handset - the midpoint of the width w_t of the handset at the level of the acoustic output, and the midpoint of the width w_b of the bottom of the handset.
 - (b) The horizontal line is perpendicular to the vertical centerline and passes through the center of the acoustic output. The horizontal line is also tangential to the face of the handset at point A.
 - (c) The two lines intersect at point A. Note that for many handsets, point A coincides with the center of the acoustic output; however, the acoustic output may be located elsewhere on the horizontal line. Also note that the vertical centerline is not necessarily parallel to the front face of the handset, especially for clamshell handsets, handsets with flip covers, and other irregularly shaped handsets.

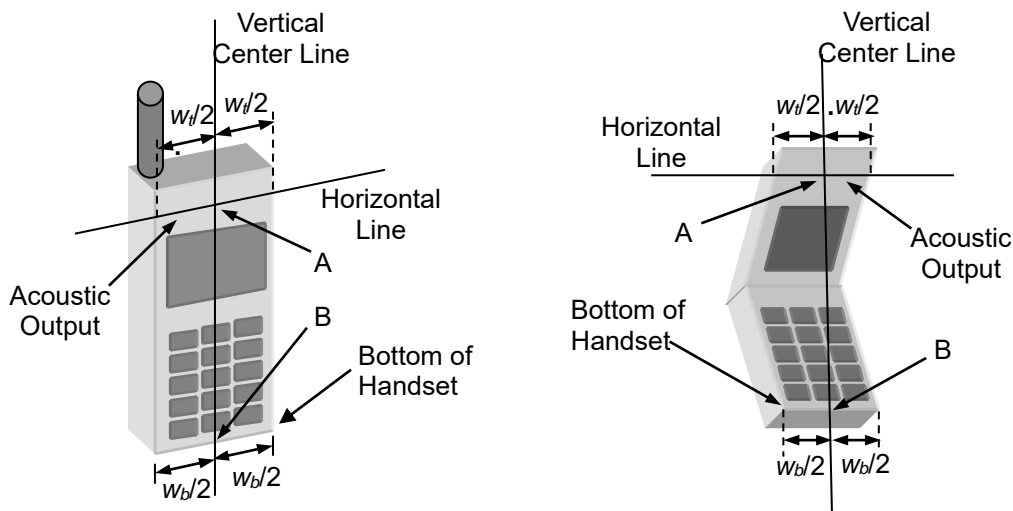

Fig-4.1 Illustration for Handset Vertical and Horizontal Reference Lines

2. Cheek Position

- (a) To position the device with the vertical center line of the body of the device and the horizontal line crossing the center piece in a plane parallel to the sagittal plane of the phantom. While maintaining the device in this plane, align the vertical center line with the reference plane containing the three ear and mouth reference point (M: Mouth, RE: Right Ear, and LE: Left Ear) and align the center of the ear piece with the line RE-LE.
- (b) To move the device towards the phantom with the ear piece aligned with the line LE-RE until the phone touched the ear. While maintaining the device in the reference plane and maintaining the phone contact with the ear, move the bottom of the phone until any point on the front side is in contact with the cheek of the phantom or until

contact with the ear is lost (see Fig-4.2).

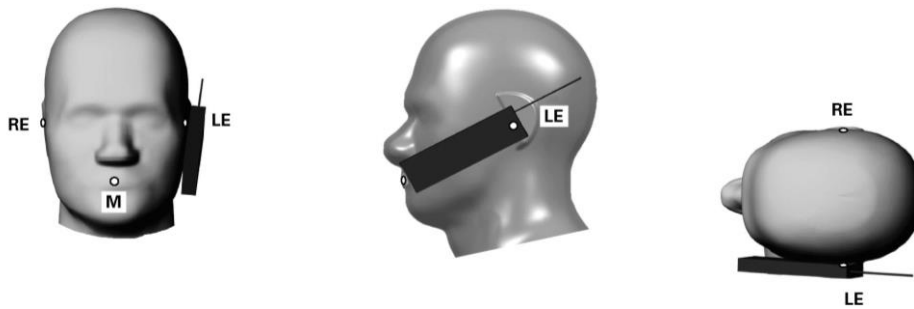

Fig-4.2 Illustration for Cheek Position

3. Tilted Position

(a) To position the device in the "cheek" position described above.

(b) While maintaining the device the reference plane described above and pivoting against the ear, moves it outward away from the mouth by an angle of 15 degrees or until contact with the ear is lost (see Fig-4.3).

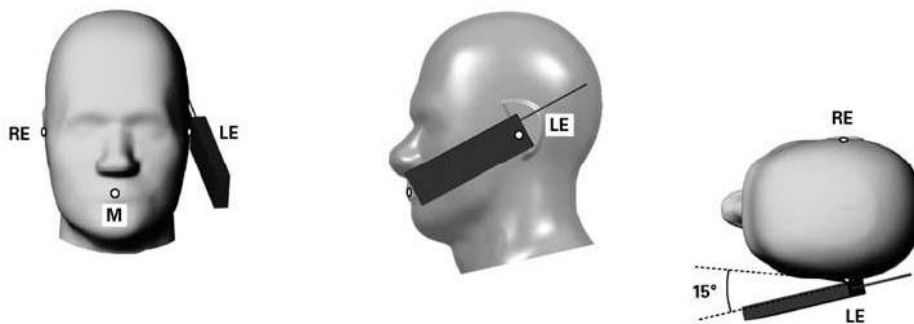

Fig-4.3 Illustration for Tilted Position

4.2.2 Body-worn Accessory Exposure Conditions

Body-worn accessory exposure is typically related to voice mode operations when handsets are carried in body-worn accessories. The body-worn accessory procedures in KDB 447498 D01 are used to test for body-worn accessory SAR compliance, without a headset connected to it. This enables the test results for such configuration to be compatible with that required for hotspot mode when the body-worn accessory test separation distance is greater than or equal to that required for hotspot mode. When the reported SAR for a body-worn accessory, measured without a headset connected to the handset, is > 1.2 W/kg, the highest reported SAR configuration for that wireless mode and frequency band should be repeated for that body-worn accessory with a headset attached to the handset.

Body-worn accessories that do not contain metallic or conductive components may be tested according to worst-case exposure configurations, typically according to the smallest test separation distance required for the group of body-worn accessories with similar operating and exposure characteristics. All body-worn accessories containing metallic components are tested in conjunction with the host device.

Body-worn accessory SAR compliance is based on a single minimum test separation distance for all wireless and operating modes applicable to each body-worn accessory used by the host, and according to the relevant voice and/or data mode transmissions and operations. If a body-worn accessory supports voice only operations in its normal and expected use conditions, testing of data mode for body-worn compliance is not required.

A conservative minimum test separation distance for supporting off-the-shelf body-worn accessories that may be acquired by users of consumer handsets is used to test for body-worn accessory SAR compliance. This distance is determined by the handset manufacturer, according to the requirements of Supplement C 01-01. Devices that are designed to operate on the body of users using lanyards and straps, or without requiring additional body-worn accessories, will be tested using a conservative minimum test separation distance ≤ 5 mm to support compliance.

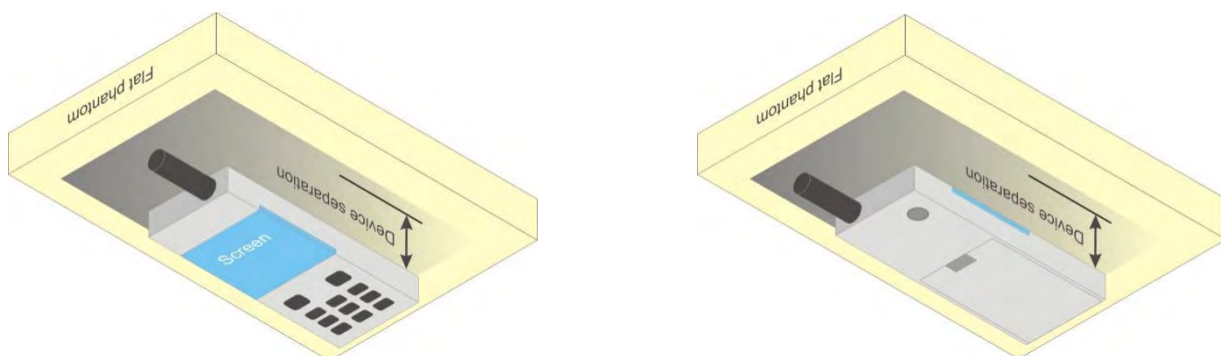
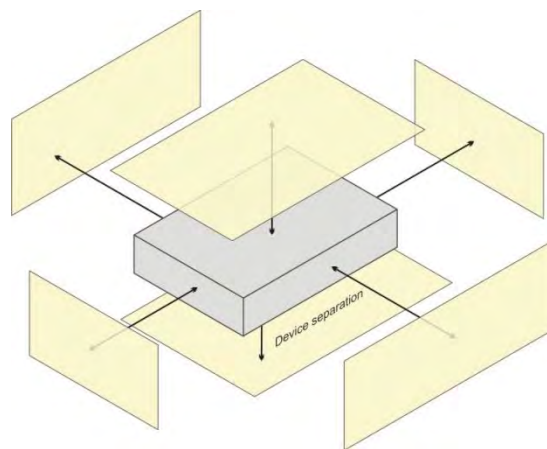

Fig-4.4 Illustration for Body Worn Position

4.2.3 Hotspot Mode Exposure Conditions

For handsets that support hotspot mode operations, with wireless router capabilities and various web browsing functions, the relevant hand and body exposure conditions are tested according to the hotspot SAR procedures in KDB 941225 D06. A test separation distance of 10 mm is required between the phantom and all surfaces and edges with a transmitting antenna located within 25 mm from that surface or edge. When the form factor of a handset is smaller than 9 cm x 5 cm, a test separation distance of 5 mm (instead of 10 mm) is required for testing hotspot mode. When the separation distance required for body-worn accessory testing is larger than or equal to that tested for hotspot mode, in the same wireless mode and for the same surface of the phone, the hotspot mode SAR data may be used to support body-worn accessory SAR compliance for that particular configuration (surface).



Based on the antenna location shown on appendix E of this report, the SAR testing required for hotspot mode is listed as below.

Antenna	Front Face	Rear Face	Left Side	Right Side	Top Side	Bottom Side
Antenna 1	V	V	V	V		V
Antenna 2	V	V	V		V	
Antenna 3	V	V	V		V	
Antenna 4	V	V	V	V	V	
Antenna 5	V	V	V	V	V	
Antenna 6	V	V	V	V	V	
Antenna 7	V	V		V	V	

4.2.4 Extremity Exposure Conditions

For smart phones with a display diagonal dimension > 15 cm or an overall diagonal dimension > 16 cm that provide similar mobile web access and multimedia support found in mini-tablets or UMPC mini-tablets that support voice calls next to the ear, the following phablet procedures should be applied to evaluate SAR compliance for each applicable wireless mode and frequency band. Devices marketed as phablets, regardless of form factors and operating characteristics must be tested as a phablet to determine SAR compliance.

1. The normally required head and body-worn accessory SAR test procedures for handsets, including hotspot mode, must be applied.
2. The UMPC mini-tablet procedures must also be applied to test the SAR of all surfaces and edges with an antenna located at ≤ 25 mm from that surface or edge, in direct contact with a flat phantom, for 10-g extremity SAR according to the body-equivalent tissue dielectric parameters in KDB 865664 to address interactive hand use exposure conditions. The UMPC mini-tablet 1-g SAR at 5 mm is not required. When hotspot mode applies, 10-g extremity SAR is required only for the surfaces and edges with hotspot mode 1-g SAR > 1.2 W/kg. The normal tablet procedures in KDB 616217 are required when the over diagonal dimension of the device is > 20 cm. Hotspot mode SAR is not required when normal tablet procedures are applied. Extremity 10-g SAR is also not required for the front (top) surface of large form factor full size tablets. The more conservative tablet SAR results can be used to support the 10-g extremity SAR for phablet mode.
3. The simultaneous transmission operating configurations applicable to voice and data transmissions for both phone and mini-tablet modes must be taken into consideration separately for 1-g and 10-g SAR to determine the simultaneous transmission SAR test exclusion and measurement requirements for the relevant wireless modes and exposure conditions.

4.2.5 SAR Text Exclusion Evaluations

For NFC:

1. Maximum output power = 2000 mW
2. Duty Cycle = 99%
3. Length of each event = 1 second
4. Events per observation period = 2 times
5. Observation period = 360 seconds

Based on the above data, calculated the time-averaged power: $(2000 \times 0.99 \times 1 \times 2) / 360 = 11$ mW.

According to KDB 447498 D01, the SAR test exclusion condition is based on source-based time-averaged maximum conducted output power, adjusted for tune-up tolerance, and the minimum test separation distance required for the exposure conditions. The SAR exclusion threshold is determined by the following.

Mode	Max. Tune-up Power (mW)	Ant. to Surface (mm)	Exemption limit (mW)	Require SAR Testing?
NFC (13.56MHz)	11	5	442	No

4.3 Tissue Verification

The measuring results for tissue simulating liquid are shown as below.

Test Date	Tissue Type	Frequency (MHz)	Liquid Temp. (°C)	Measured Conductivity (σ)	Measured Permittivity (ϵ_r)	Target Conductivity (σ)	Target Permittivity (ϵ_r)	Conductivity Deviation (%)	Permittivity Deviation (%)
Jul. 24, 2024	Head	750	22.6	0.900	42.931	0.890	41.900	1.12	2.46
Jul. 28, 2024	Head	835	22.7	0.930	40.319	0.900	41.500	3.33	-2.85
Jul. 29, 2024	Head	835	22.4	0.910	43.284	0.900	41.500	1.11	4.30
Jul. 30, 2024	Head	1750	22.5	1.413	39.387	1.370	40.100	3.14	-1.78
Jul. 31, 2024	Head	1750	22.3	1.364	40.084	1.370	40.100	-0.44	-0.04
Aug. 24, 2024	Head	1750	22.6	1.412	39.374	1.370	40.100	3.07	-1.81
Jul. 24, 2024	Head	1950	22.2	1.446	39.276	1.400	40.000	3.29	-1.81
Jul. 30, 2024	Head	1950	22.4	1.446	40.004	1.400	40.000	3.29	0.01
Aug. 24, 2024	Head	1950	22.6	1.432	38.778	1.400	40.000	2.29	-3.06
Aug. 01, 2024	Head	2450	22.6	1.862	38.958	1.800	39.200	3.44	-0.62
Aug. 02, 2024	Head	2550	22.7	1.958	39.192	1.910	39.073	2.51	0.30
Aug. 03, 2024	Head	2550	22.2	1.843	39.562	1.910	39.073	-3.51	1.25
Aug. 04, 2024	Head	2550	22.6	1.845	39.574	1.910	39.073	-3.40	1.28
Aug. 05, 2024	Head	3500	22.5	2.821	39.687	2.821	39.680	0.00	0.02
Aug. 08, 2024	Head	3500	22.6	2.794	39.131	2.821	39.680	-0.96	-1.38
Aug. 10, 2024	Head	3500	22.7	2.894	40.167	2.821	39.680	2.59	1.23
Aug. 06, 2024	Head	3700	22.3	3.010	39.366	3.010	39.360	0.00	0.02
Aug. 07, 2024	Head	3700	22.4	2.981	38.812	3.010	39.360	-0.96	-1.39
Aug. 09, 2024	Head	3700	22.4	3.120	39.971	3.010	39.360	3.65	1.55
Aug. 11, 2024	Head	3900	22.8	3.180	38.519	3.323	37.471	-4.30	2.80
Aug. 12, 2024	Head	5250	22.6	4.568	36.361	4.760	35.900	-4.03	1.28
Aug. 13, 2024	Head	5600	22.1	4.941	34.543	5.070	35.500	-2.54	-2.70
Aug. 14, 2024	Head	5750	22.6	5.140	34.164	5.270	35.300	-2.47	-3.22

Note:

The dielectric properties of the tissue simulating liquid must be measured within 24 hours before the SAR testing and within $\pm 5\%$ of the target values. Liquid temperature during the SAR testing must be within ± 2 °C.

4.4 System Verification

The measuring result for system verification is tabulated as below.

<1g>

Test Date	Mode	Frequency (MHz)	1W Target SAR-1g (W/kg)	Measured SAR-1g (W/kg)	Normalized to 1W SAR-1g (W/kg)	Deviation (%)	Dipole S/N	Probe S/N	DAE S/N
Jul. 24, 2024	Head	750	8.45	2.12	8.48	0.36	1200	7612	1633
Jul. 28, 2024	Head	835	9.60	2.51	10.04	4.58	4d265	7612	1633
Jul. 29, 2024	Head	835	9.60	2.39	9.56	-0.42	4d265	7612	1633
Jul. 30, 2024	Head	1750	36.60	9.59	38.36	4.81	1176	7612	1633
Jul. 31, 2024	Head	1750	36.60	8.94	35.76	-2.30	1176	7612	1633
Aug. 24, 2024	Head	1750	36.60	9.59	38.36	4.81	1176	3985	755
Jul. 24, 2024	Head	1950	40.30	10.10	40.40	0.25	1229	7612	1633
Jul. 30, 2024	Head	1950	40.30	10.40	41.60	3.23	1229	7612	1633
Aug. 24, 2024	Head	1950	40.30	10.09	40.36	0.15	1229	3985	755
Aug. 01, 2024	Head	2450	52.80	12.90	51.60	-2.27	1048	7612	1633
Aug. 02, 2024	Head	2550	53.00	13.60	54.40	2.64	1022	7612	1633
Aug. 03, 2024	Head	2550	53.00	12.90	51.60	-2.64	1022	7612	1633
Aug. 04, 2024	Head	2550	53.00	12.70	50.80	-4.15	1022	7612	1633
Aug. 05, 2024	Head	3500	65.50	6.31	63.10	-3.66	1111	7612	1633
Aug. 08, 2024	Head	3500	65.50	6.25	62.50	-4.58	1111	7612	1633
Aug. 10, 2024	Head	3500	65.50	6.32	63.20	-3.51	1111	7612	1633
Aug. 06, 2024	Head	3700	66.80	6.69	66.90	0.15	1082	7612	1633
Aug. 07, 2024	Head	3700	66.80	6.36	63.60	-4.79	1082	7612	1633
Aug. 09, 2024	Head	3700	66.80	6.35	63.50	-4.94	1082	7612	1633
Aug. 11, 2024	Head	3900	67.90	6.87	68.70	1.18	1055	7612	1633
Aug. 12, 2024	Head	5250	76.90	7.65	76.50	-0.52	1315	7612	1633
Aug. 13, 2024	Head	5600	81.90	8.31	83.10	1.47	1315	7612	1633
Aug. 14, 2024	Head	5750	76.10	7.60	76.00	-0.13	1315	7612	1633

<10g>

Test Date	Mode	Frequency (MHz)	1W Target SAR-10g (W/kg)	Measured SAR-10g (W/kg)	Normalized to 1W SAR-10g (W/kg)	Deviation (%)	Dipole S/N	Probe S/N	DAE S/N
Jul. 24, 2024	Head	750	5.57	1.39	5.56	-0.18	1200	7612	1633
Jul. 28, 2024	Head	835	6.25	1.60	6.40	2.40	4d265	7612	1633
Jul. 29, 2024	Head	835	6.25	1.51	6.04	-3.36	4d265	7612	1633
Jul. 30, 2024	Head	1750	19.20	5.01	20.04	4.38	1176	7612	1633
Jul. 31, 2024	Head	1750	19.20	4.77	19.08	-0.63	1176	7612	1633
Aug. 24, 2024	Head	1750	19.20	5.09	20.36	4.81	1176	3985	755
Jul. 24, 2024	Head	1950	20.30	5.16	20.64	1.67	1229	7612	1633
Jul. 30, 2024	Head	1950	20.30	5.24	20.96	3.25	1229	7612	1633
Aug. 24, 2024	Head	1950	20.30	5.12	20.48	0.89	1229	3985	755
Aug. 01, 2024	Head	2450	24.20	6.03	24.12	-0.33	1048	7612	1633
Aug. 02, 2024	Head	2550	24.20	6.22	24.88	2.81	1022	7612	1633
Aug. 03, 2024	Head	2550	24.20	5.87	23.48	-2.98	1022	7612	1633
Aug. 04, 2024	Head	2550	24.20	5.78	23.12	-4.46	1022	7612	1633
Aug. 05, 2024	Head	3500	24.70	2.46	24.60	-0.40	1111	7612	1633
Aug. 08, 2024	Head	3500	24.70	2.37	23.70	-4.05	1111	7612	1633
Aug. 10, 2024	Head	3500	24.70	2.44	24.40	-1.21	1111	7612	1633
Aug. 06, 2024	Head	3700	24.40	2.50	25.00	2.46	1082	7612	1633
Aug. 07, 2024	Head	3700	24.40	2.38	23.80	-2.46	1082	7612	1633
Aug. 09, 2024	Head	3700	24.40	2.39	23.90	-2.05	1082	7612	1633
Aug. 11, 2024	Head	3900	23.70	2.47	24.70	4.22	1055	7612	1633
Aug. 12, 2024	Head	5250	22.10	2.17	21.70	-1.81	1315	7612	1633
Aug. 13, 2024	Head	5600	23.50	2.33	23.30	-0.85	1315	7612	1633
Aug. 14, 2024	Head	5750	21.70	2.14	21.40	-1.38	1315	7612	1633

Note:

Comparing to the reference SAR value provided by SPEAG, the validation data should be within its specification of 10 %. The result indicates the system check can meet the variation criterion and the plots can be referred to Appendix A of this report.

4.5 Maximum Output Power

4.5.1 Maximum Conducted Power

The maximum conducted average power (Unit: dBm) including tune-up tolerance please refer to Appendix D.

4.5.2 Measured Conducted Power Result

The measuring conducted average power (Unit: dBm) please refer to Appendix D.

4.6 SAR Testing Results

4.6.1 SAR Test Reduction Considerations

<KDB 447498 D04, General RF Exposure Guidance>

Testing of other required channels within the operating mode of a frequency band is not required when the reported SAR for the mid-band or highest output power channel is:

- (1) ≤ 0.8 W/kg or 2.0 W/kg, for 1-g or 10-g respectively, when the transmission band is ≤ 100 MHz
- (2) ≤ 0.6 W/kg or 1.5 W/kg, for 1-g or 10-g respectively, when the transmission band is between 100 MHz and 200 MHz
- (3) ≤ 0.4 W/kg or 1.0 W/kg, for 1-g or 10-g respectively, when the transmission band is ≥ 200 MHz

<KDB 941225 D01, 3G SAR Measurement Procedures>

The mode tested for SAR is referred to as the primary mode. The equivalent modes considered for SAR test reduction are denoted as secondary modes. Both primary and secondary modes must be in the same frequency band. When the maximum output power and tune-up tolerance specified for production units in a secondary mode is $\leq 1/4$ dB higher than the primary mode or when the highest reported SAR of the primary mode is scaled by the ratio of specified maximum output power and tune-up tolerance of secondary to primary mode and the adjusted SAR is ≤ 1.2 W/kg, SAR measurement is not required for the secondary mode.

<KDB 941225 D05, SAR Evaluation Considerations for LTE Devices>

(1) QPSK with 1 RB and 50% RB allocation

Start with the largest channel bandwidth and measure SAR, using the RB offset and required test channel combination with the highest maximum output power among RB offsets at the upper edge, middle and lower edge of each required test channel. When the reported SAR is ≤ 0.8 W/kg, testing of the remaining RB offset configurations and required test channels is not required; otherwise, SAR is required for the remaining required test channels and only for the RB offset configuration with the highest output power for that channel. When the reported SAR of a required test channel is > 1.45 W/kg, SAR is required for all three RB offset configurations for that required test channel.

(2) QPSK with 100% RB allocation

SAR is not required when the highest maximum output power for 100% RB allocation is less than the highest maximum output power in 50% and 1 RB allocations and the highest reported SAR for 1 RB and 50% RB allocation are ≤ 0.8 W/kg. Otherwise, SAR is measured for the highest output power channel; and if the reported SAR is > 1.45 W/kg, the remaining required test channels must also be tested.

(3) Higher order modulations

SAR is required only when the highest maximum output power for the configuration in the higher order modulation is $> 1/2$ dB higher than the same configuration in QPSK or when the reported SAR for the QPSK configuration is $>$

1.45 W/kg.

(4) Other channel bandwidth

SAR is required when the highest maximum output power of the smaller channel bandwidth is $> 1/2$ dB higher than the equivalent channel configurations in the largest channel bandwidth configuration or the reported SAR of a configuration for the largest channel bandwidth is > 1.45 W/kg.

<KDB 941225 D05, SAR Evaluation Considerations for 5G NR Devices>

- 1) For DFT-OFDM and CP-OFDM output power measurement reduction, according to 38.101 maximum power reduction for power class2 and 3, the CP-OFDM mode will not higher than DFT-OFDM mode, therefore, similar FCC KB 941225 D05 procedure for other modulation output power for each RB allocation configuration is $>$ not $1/2$ dB higher than the same configuration in DFT-QPSK and the reported SAR for the DFT-QPSK configuration is ≤ 1.45 W/kg; CP-OFDM testing is not required.
- 2) For DFT-OFDM output power measurement reduction, according to 38.101 maximum power reduction for power class2 and 3, for 16QAM/64QAM/256QAM and smaller bandwidth output power will spot check largest channel bandwidth worst RB configuration to ensure the 16QAM/64QAM/256QAM and smaller bandwidth output power will not $1/2$ dB higher than the same configuration in the largest supported bandwidth.
- 3) SAR testing start with the largest channel bandwidth and measure SAR for QPSK with 1 RB allocation, using the RB offset and required test channel combination with the highest maximum output power for RB offset at the upper edge, middle and lower edge of each required test channel.
- 4) 50% RB allocation for QPSK SAR testing follows 1RB QPSK allocation procedure.
- 5) QPSK with 100% RB allocation, SAR is not required when the highest maximum output power for 100 % RB allocation is less than the highest maximum output power in 50% and 1 RB allocations and the highest reported SAR for 1 RB and 50% RB allocation are ≤ 0.8 W/kg. Otherwise, SAR is measured for the highest output power channel, and if the reported SAR is > 1.45 W/kg, the remaining required test channels must also be tested.
- 6) PI/2 BPSK/16QAM/64QAM/256QAM output powers according to 3GPP MPR will not $1/2$ dB higher than the same configuration in QPSK, also reported SAR for the QPSK configuration is less than 1.45 W/kg, PI/2 BPSK/16QAM/64QAM/256QAM SAR testing are not required.
- 7) Smaller bandwidth output power for each RB allocation configuration for this device will not. $1/2$ dB higher than the same configuration in the largest supported bandwidth, and the reported SAR for the largest supported bandwidth is ≤ 1.45 W/kg, smaller bandwidth SAR testing is not required for this device.

<KDB 248227 D01, SAR Guidance for Wi-Fi Transmitters>

- (1) For handsets operating next to ear, hotspot mode or mini-tablet configurations, the initial test position procedures were applied. The test position with the highest extrapolated peak SAR will be used as the initial test position. When the reported SAR of initial test position is ≤ 0.4 W/kg, SAR testing for remaining test positions is not required. Otherwise, SAR is evaluated at the subsequent highest peak SAR positions until the reported SAR result is ≤ 0.8 W/kg or all test positions are measured.
- (2) For WLAN 2.4 GHz, the highest measured maximum output power channel for DSSS was selected for SAR measurement. When the reported SAR is ≤ 0.8 W/kg, no further SAR testing is required. Otherwise, SAR is evaluated at the next highest measured output power channel. When any reported SAR is > 1.2 W/kg, SAR is required for the third channel. For OFDM modes (802.11g/n), SAR is not required when the highest reported SAR for DSSS is adjusted by the ratio of OFDM to DSSS specified maximum output power and it is ≤ 1.2

W/kg.

- (3) For WLAN 5 GHz, the initial test configuration was selected according to the transmission mode with the highest maximum output power. When the reported SAR of initial test configuration is > 0.8 W/kg, SAR is required for the subsequent highest measured output power channel until the reported SAR result is <= 1.2 W/kg or all required channels are measured. For other transmission modes, SAR is not required when the highest reported SAR for initial test configuration is adjusted by the ratio of subsequent test configuration to initial test configuration specified maximum output power and it is <= 1.2 W/kg.
- (4) For WLAN MIMO mode, the power-based standalone SAR test exclusion or the sum of SAR provision in KDB 447498 to determine simultaneous transmission SAR test exclusion should be applied. Otherwise, SAR for MIMO mode will be measured with all applicable antennas transmitting simultaneously at the specified maximum output power of MIMO operation.

4.6.2 SAR Results for Head Exposure Condition

Plot No.	Band	Mode	Test Position	Ch.	RB#	RB Offset	Power State	Antenna	Sample	Duty Cycle %	Max. Tune-up Power (dBm)	Measured Conducted Power (dBm)	Power Drift (dB)	Measured SAR-1g (W/kg)	Duty Cycle Scaling Factor	Tune-up Scaling Factor	Scaled SAR-1g (W/kg)
	GSM850	GPRS 2Tx Slot	Right Cheek	189	-	-	DS11	Ant1	1	-	31.00	30.65	-0.06	0.192	1.000	1.084	0.21
	GSM850	GPRS 2Tx Slot	Right Tilted	189	-	-	DS11	Ant1	1	-	31.00	30.65	0.13	0.113	1.000	1.084	0.12
	GSM850	GPRS 2Tx Slot	Left Cheek	189	-	-	DS11	Ant1	1	-	31.00	30.65	0.04	0.180	1.000	1.084	0.20
	GSM850	GPRS 2Tx Slot	Left Tilted	189	-	-	DS11	Ant1	1	-	31.00	30.65	0.01	0.108	1.000	1.084	0.12
	GSM850	GPRS 2Tx Slot	Right Cheek	189	-	-	DS11	Ant4	1	-	31.00	29.88	-0.10	0.664	1.000	1.294	0.86
P01	GSM850	GPRS 2Tx Slot	Right Tilted	189	-	-	DS11	Ant4	1	-	31.00	29.88	-0.02	0.812	1.000	1.294	1.05
	GSM850	GPRS 2Tx Slot	Left Cheek	189	-	-	DS11	Ant4	1	-	31.00	29.88	0.01	0.464	1.000	1.294	0.60
	GSM850	GPRS 2Tx Slot	Left Tilted	189	-	-	DS11	Ant4	1	-	31.00	29.88	0.16	0.474	1.000	1.294	0.61
	GSM850	GPRS 2Tx Slot	Right Cheek	128	-	-	DS11	Ant4	1	-	31.00	29.66	-0.17	0.632	1.000	1.361	0.86
	GSM850	GPRS 2Tx Slot	Right Cheek	251	-	-	DS11	Ant4	1	-	31.00	29.61	0.14	0.672	1.000	1.377	0.93
	GSM850	GPRS 2Tx Slot	Right Tilted	128	-	-	DS11	Ant4	1	-	31.00	29.66	-0.16	0.676	1.000	1.361	0.92
	GSM850	GPRS 2Tx Slot	Right Tilted	251	-	-	DS11	Ant4	1	-	31.00	29.61	-0.02	0.760	1.000	1.377	1.05
	GSM1900	GPRS 3Tx Slot	Right Cheek	810	-	-	DS11	Ant1	1	-	26.50	25.93	0.00	0.000	1.000	1.140	0.00
	GSM1900	GPRS 3Tx Slot	Right Tilted	810	-	-	DS11	Ant1	1	-	26.50	25.93	0.00	0.000	1.000	1.140	0.00
	GSM1900	GPRS 3Tx Slot	Left Cheek	810	-	-	DS11	Ant1	1	-	26.50	25.93	0.09	0.030	1.000	1.140	0.03
	GSM1900	GPRS 3Tx Slot	Left Tilted	810	-	-	DS11	Ant1	1	-	26.50	25.93	0.00	0.000	1.000	1.140	0.00
	GSM1900	GPRS 3Tx Slot	Right Cheek	810	-	-	DS11	Ant4	1	-	20.50	19.26	0.01	0.458	1.000	1.330	0.61
P02	GSM1900	GPRS 3Tx Slot	Right Tilted	810	-	-	DS11	Ant4	1	-	20.50	19.26	-0.11	0.585	1.000	1.330	0.78
	GSM1900	GPRS 3Tx Slot	Left Cheek	810	-	-	DS11	Ant4	1	-	20.50	19.26	-0.10	0.216	1.000	1.330	0.29
	GSM1900	GPRS 3Tx Slot	Left Tilted	810	-	-	DS11	Ant4	1	-	20.50	19.26	0.17	0.259	1.000	1.330	0.34
	WCDMA II	RMC12.2K	Right Cheek	9400	-	-	DS11	Ant1	1	-	25.00	24.04	0.00	0.000	1.000	1.247	0.00
	WCDMA II	RMC12.2K	Right Tilted	9400	-	-	DS11	Ant1	1	-	25.00	24.04	0.00	0.000	1.000	1.247	0.00
	WCDMA II	RMC12.2K	Left Cheek	9400	-	-	DS11	Ant1	1	-	25.00	24.04	0.08	0.055	1.000	1.247	0.07
	WCDMA II	RMC12.2K	Left Tilted	9400	-	-	DS11	Ant1	1	-	25.00	24.04	0.00	0.000	1.000	1.247	0.00
	WCDMA II	RMC12.2K	Right Cheek	9400	-	-	DS11	Ant4	1	-	16.50	15.28	-0.18	0.611	1.000	1.324	0.81
	WCDMA II	RMC12.2K	Right Tilted	9400	-	-	DS11	Ant4	1	-	16.50	15.28	0.07	0.641	1.000	1.324	0.85
	WCDMA II	RMC12.2K	Left Cheek	9400	-	-	DS11	Ant4	1	-	16.50	15.28	0.15	0.278	1.000	1.324	0.37
	WCDMA II	RMC12.2K	Left Tilted	9400	-	-	DS11	Ant4	1	-	16.50	15.28	0.13	0.335	1.000	1.324	0.44
	WCDMA II	RMC12.2K	Right Cheek	9262	-	-	DS11	Ant4	1	-	16.50	15.16	0.08	0.639	1.000	1.361	0.87
	WCDMA II	RMC12.2K	Right Cheek	9538	-	-	DS11	Ant4	1	-	16.50	15.07	0.18	0.537	1.000	1.390	0.75
P03	WCDMA II	RMC12.2K	Right Tilted	9262	-	-	DS11	Ant4	1	-	16.50	15.16	-0.02	0.747	1.000	1.361	1.02
	WCDMA II	RMC12.2K	Right Tilted	9538	-	-	DS11	Ant4	1	-	16.50	15.07	0.05	0.567	1.000	1.390	0.79
	WCDMA IV	RMC12.2K	Right Cheek	1413	-	-	DS11	Ant1	1	-	25.00	24.04	0.06	0.102	1.000	1.247	0.13
	WCDMA IV	RMC12.2K	Right Tilted	1413	-	-	DS11	Ant1	1	-	25.00	24.04	0.00	0.000	1.000	1.247	0.00
	WCDMA IV	RMC12.2K	Left Cheek	1413	-	-	DS11	Ant1	1	-	25.00	24.04	-0.17	0.048	1.000	1.247	0.06
	WCDMA IV	RMC12.2K	Left Tilted	1413	-	-	DS11	Ant1	1	-	25.00	24.04	0.00	0.000	1.000	1.247	0.00
	WCDMA IV	RMC12.2K	Right Cheek	1413	-	-	DS11	Ant4	1	-	19.00	17.74	0.04	0.575	1.000	1.337	0.77
P04	WCDMA IV	RMC12.2K	Right Tilted	1413	-	-	DS11	Ant4	1	-	19.00	17.74	-0.07	0.805	1.000	1.337	1.08
	WCDMA IV	RMC12.2K	Left Cheek	1413	-	-	DS11	Ant4	1	-	19.00	17.74	0.12	0.391	1.000	1.337	0.52
	WCDMA IV	RMC12.2K	Left Tilted	1413	-	-	DS11	Ant4	1	-	19.00	17.74	-0.10	0.461	1.000	1.337	0.62
	WCDMA IV	RMC12.2K	Right Tilted	1312	-	-	DS11	Ant4	1	-	19.00	17.58	0.16	0.744	1.000	1.387	1.03
	WCDMA IV	RMC12.2K	Right Tilted	1513	-	-	DS11	Ant4	1	-	19.00	17.62	-0.07	0.714	1.000	1.374	0.98
	WCDMA IV	RMC12.2K	Right Tilted	1413	-	-	DS11	Ant4	2	-	19.00	17.74	0.13	0.787	1.000	1.337	1.05
	WCDMA IV	RMC12.2K	Right Tilted	1413	-	-	DS11	Ant4	3	-	19.00	17.74	0.05	0.762	1.000	1.337	1.02
	WCDMA V	RMC12.2K	Right Cheek	4233	-	-	DS11	Ant1	1	-	25.00	23.82	0.03	0.185	1.000	1.312	0.24
	WCDMA V	RMC12.2K	Right Tilted	4233	-	-	DS11	Ant1	1	-	25.00	23.82	0.16	0.095	1.000	1.312	0.12
	WCDMA V	RMC12.2K	Left Cheek	4233	-	-	DS11	Ant1	1	-	25.00	23.82	-0.07	0.159	1.000	1.312	0.21
	WCDMA V	RMC12.2K	Left Tilted	4233	-	-	DS11	Ant1	1	-	25.00	23.82	0.11	0.082	1.000	1.312	0.11
P05	WCDMA V	RMC12.2K	Right Cheek	4233	-	-	DS11	Ant4	1	-	24.00	22.33	-0.05	0.568	1.000	1.469	0.83



BUREAU VERITAS

FCC SAR Test Report



Certificate #6613.01

Plot No.	Band	Mode	Test Position	Ch.	RB#	RB Offset	Power State	Antenna	Sample	Duty Cycle %	Max. Tune-up Power (dBm)	Measured Conducted Power (dBm)	Power Drift (dB)	Measured SAR-1g (W/kg)	Duty Cycle Scaling Factor	Tune-up Scaling Factor	Scaled SAR-1g (W/kg)
	WCDMA V	RMC12.2K	Right Tilted	4233	-	-	DS11	Ant4	1	-	24.00	22.33	0.02	0.519	1.000	1.469	0.76
	WCDMA V	RMC12.2K	Left Cheek	4233	-	-	DS11	Ant4	1	-	24.00	22.33	-0.19	0.388	1.000	1.469	0.57
	WCDMA V	RMC12.2K	Left Tilted	4233	-	-	DS11	Ant4	1	-	24.00	22.33	0.04	0.386	1.000	1.469	0.57
	WCDMA V	RMC12.2K	Right Cheek	4132	-	-	DS11	Ant4	1	-	24.00	22.25	-0.13	0.304	1.000	1.496	0.45
	WCDMA V	RMC12.2K	Right Cheek	4182	-	-	DS11	Ant4	1	-	24.00	22.14	0.06	0.507	1.000	1.535	0.78
	LTE 2	QPSK20M	Right Cheek	18900	1	50	DS11	Ant1	1	-	25.00	24.30	0.00	0.000	1.000	1.175	0.00
	LTE 2	QPSK20M	Right Tilted	18900	1	50	DS11	Ant1	1	-	25.00	24.30	0.00	0.000	1.000	1.175	0.00
	LTE 2	QPSK20M	Left Cheek	18900	1	50	DS11	Ant1	1	-	25.00	24.30	0.06	0.050	1.000	1.175	0.06
	LTE 2	QPSK20M	Left Tilted	18900	1	50	DS11	Ant1	1	-	25.00	24.30	0.00	0.000	1.000	1.175	0.00
	LTE 2	QPSK20M	Right Cheek	18900	50	25	DS11	Ant1	1	-	24.00	23.33	0.00	0.000	1.000	1.167	0.00
	LTE 2	QPSK20M	Right Tilted	18900	50	25	DS11	Ant1	1	-	24.00	23.33	0.00	0.000	1.000	1.167	0.00
	LTE 2	QPSK20M	Left Cheek	18900	50	25	DS11	Ant1	1	-	24.00	23.33	0.00	0.000	1.000	1.167	0.00
	LTE 2	QPSK20M	Left Tilted	18900	50	25	DS11	Ant1	1	-	24.00	23.33	0.06	0.000	1.000	1.167	0.00
	LTE 2	QPSK20M	Right Cheek	18900	1	50	DS11	Ant4	1	-	15.00	13.98	0.05	0.558	1.000	1.265	0.71
	LTE 2	QPSK20M	Right Tilted	18900	1	50	DS11	Ant4	1	-	15.00	13.98	0.13	0.591	1.000	1.265	0.75
	LTE 2	QPSK20M	Left Cheek	18900	1	50	DS11	Ant4	1	-	15.00	13.98	-0.06	0.252	1.000	1.265	0.32
	LTE 2	QPSK20M	Left Tilted	18900	1	50	DS11	Ant4	1	-	15.00	13.98	0.14	0.302	1.000	1.265	0.38
	LTE 2	QPSK20M	Right Cheek	18900	50	0	DS11	Ant4	1	-	15.00	13.83	0.07	0.575	1.000	1.309	0.75
P06	LTE 2	QPSK20M	Right Tilted	18900	50	0	DS11	Ant4	1	-	15.00	13.83	-0.02	0.577	1.000	1.309	0.76
	LTE 2	QPSK20M	Left Cheek	18900	50	0	DS11	Ant4	1	-	15.00	13.83	-0.11	0.258	1.000	1.309	0.34
	LTE 2	QPSK20M	Left Tilted	18900	50	0	DS11	Ant4	1	-	15.00	13.83	0.03	0.310	1.000	1.309	0.41
	LTE 2	QPSK20M	Right Cheek	18700	1	50	DS11	Ant3	1	-	18.00	17.04	-0.09	0.259	1.000	1.247	0.32
	LTE 2	QPSK20M	Right Tilted	18700	1	50	DS11	Ant3	1	-	18.00	17.04	0.16	0.047	1.000	1.247	0.06
	LTE 2	QPSK20M	Left Cheek	18700	1	50	DS11	Ant3	1	-	18.00	17.04	0.17	0.086	1.000	1.247	0.11
	LTE 2	QPSK20M	Left Tilted	18700	1	50	DS11	Ant3	1	-	18.00	17.04	0.00	0.000	1.000	1.247	0.00
	LTE 2	QPSK20M	Right Cheek	18700	50	25	DS11	Ant3	1	-	18.00	16.78	0.07	0.243	1.000	1.324	0.32
	LTE 2	QPSK20M	Right Tilted	18700	50	25	DS11	Ant3	1	-	18.00	16.78	0.03	0.045	1.000	1.324	0.06
	LTE 2	QPSK20M	Left Cheek	18700	50	25	DS11	Ant3	1	-	18.00	16.78	0.12	0.084	1.000	1.324	0.11
	LTE 2	QPSK20M	Left Tilted	18700	50	25	DS11	Ant3	1	-	18.00	16.78	0.00	0.000	1.000	1.324	0.00
	LTE 7	QPSK20M	Right Cheek	21100	1	50	DS11	Ant1	1	-	25.00	24.01	0.02	0.212	1.000	1.256	0.27
	LTE 7	QPSK20M	Right Tilted	21100	1	50	DS11	Ant1	1	-	25.00	24.01	-0.07	0.072	1.000	1.256	0.09
	LTE 7	QPSK20M	Left Cheek	21100	1	50	DS11	Ant1	1	-	25.00	24.01	0.19	0.102	1.000	1.256	0.13
	LTE 7	QPSK20M	Left Tilted	21100	1	50	DS11	Ant1	1	-	25.00	24.01	-0.16	0.055	1.000	1.256	0.07
	LTE 7	QPSK20M	Right Cheek	21100	50	25	DS11	Ant1	1	-	24.00	23.05	-0.02	0.140	1.000	1.245	0.17
	LTE 7	QPSK20M	Right Tilted	21100	50	25	DS11	Ant1	1	-	24.00	23.05	-0.07	0.059	1.000	1.245	0.07
	LTE 7	QPSK20M	Left Cheek	21100	50	25	DS11	Ant1	1	-	24.00	23.05	0.14	0.086	1.000	1.245	0.11
	LTE 7	QPSK20M	Left Tilted	21100	50	25	DS11	Ant1	1	-	24.00	23.05	0.09	0.045	1.000	1.245	0.06
	LTE 7C	QPSK20M	Right Cheek	PCC:21001 SCC:21199	PCC:1 SCC:1	PCC:99 SCC:0	DS11	Ant1	1	-	25.00	23.24	-0.13	0.148	1.000	1.500	0.22
	LTE 7	QPSK20M	Right Cheek	20850	1	50	DS11	Ant4	1	-	16.00	14.85	0.04	0.419	1.000	1.303	0.55
	LTE 7	QPSK20M	Right Tilted	20850	1	50	DS11	Ant4	1	-	16.00	14.85	-0.07	0.582	1.000	1.303	0.76
	LTE 7	QPSK20M	Left Cheek	20850	1	50	DS11	Ant4	1	-	16.00	14.85	0.13	0.289	1.000	1.303	0.38
	LTE 7	QPSK20M	Left Tilted	20850	1	50	DS11	Ant4	1	-	16.00	14.85	0.06	0.370	1.000	1.303	0.48
	LTE 7	QPSK20M	Right Cheek	20850	50	25	DS11	Ant4	1	-	16.00	14.52	-0.01	0.431	1.000	1.406	0.61
	LTE 7	QPSK20M	Right Tilted	20850	50	25	DS11	Ant4	1	-	16.00	14.52	-0.08	0.580	1.000	1.406	0.82
	LTE 7	QPSK20M	Left Cheek	20850	50	25	DS11	Ant4	1	-	16.00	14.52	-0.05	0.292	1.000	1.406	0.41
	LTE 7	QPSK20M	Left Tilted	20850	50	25	DS11	Ant4	1	-	16.00	14.52	-0.15	0.373	1.000	1.406	0.52
	LTE 7	QPSK20M	Right Tilted	21100	50	25	DS11	Ant4	1	-	16.00	14.44	-0.16	0.672	1.000	1.432	0.96
P07	LTE 7	QPSK20M	Right Tilted	21350	50	25	DS11	Ant4	1	-	16.00	14.39	0.07	0.728	1.000	1.449	1.05
	LTE 7	QPSK20M	Right Tilted	20850	100	0	DS11	Ant4	1	-	16.00	14.55	0.15	0.690	1.000	1.396	0.96
	LTE 7C	QPSK20M	Right Tilted	PCC:21001 SCC:21199	PCC:1 SCC:1	PCC:99 SCC:0	DS11	Ant4	1	-	16.00	15.16	0.18	0.708	1.000	1.213	0.86
	LTE 7	QPSK20M	Right Cheek	20850	1	50	DS11	Ant3	1	-	16.50	15.39	0.11	0.336	1.000	1.291	0.43
	LTE 7	QPSK20M	Right Tilted	20850	1	50	DS11	Ant3	1	-	16.50	15.39	-0.01	0.060	1.000	1.291	0.08
	LTE 7	QPSK20M	Left Cheek	20850	1	50	DS11	Ant3	1	-	16.50	15.39	0.03	0.140	1.000	1.291	0.18
	LTE 7	QPSK20M	Left Tilted	20850	1	50	DS11	Ant3	1	-	16.50	15.39	0.00	0.000	1.000	1.291	0.00
	LTE 7	QPSK20M	Right Cheek	20850	50	25	DS11	Ant3	1	-	16.50	15.08	-0.03	0.305	1.000	1.387	0.42
	LTE 7	QPSK20M	Right Tilted	20850	50	25	DS11	Ant3	1	-	16.50	15.08	-0.11	0.057	1.000	1.387	0.08
	LTE 7	QPSK20M	Left Cheek	20850	50	25	DS11	Ant3	1	-	16.50	15.08	-0.13	0.132	1.000	1.387	0.18
	LTE 7	QPSK20M	Left Tilted	20850	50	25	DS11	Ant3	1	-	16.50	15.08	0.00	0.000	1.000	1.387	0.00
	LTE 12	QPSK10M	Right Cheek	23060	1	0	DS11	Ant1	1	-	25.50	24.51	-0.14	0.151	1.000	1.256	0.19
	LTE 12	QPSK10M	Right Tilted	23060	1	0	DS11	Ant1	1	-	25.50	24.51	-0.05	0.083	1.000	1.256	0.10
	LTE 12	QPSK10M	Left Cheek	23060	1	0	DS11	Ant1	1	-	25.50	24.51	0.05	0.123	1.000	1.256	0.15
	LTE 12	QPSK10M	Left Tilted	23060	1	0	DS11	Ant1	1	-	25.50	24.51	-0.17	0.068	1.000	1.256	0.09
	LTE 12	QPSK10M	Right Cheek	23060	25	0	DS11	Ant1	1	-	24.50	23.54	-0.15	0.114	1.000	1.247	0.14
	LTE 12	QPSK10M	Right Tilted	23060	25	0	DS11	Ant1	1	-	24.50	23.54	0.09	0.068	1.000	1.247	0.08
	LTE 12	QPSK10M	Left Cheek	23060	25	0	DS11	Ant1	1	-	24.50	23.54	-0.02	0.101	1.000	1.247	0.13
	LTE 12	QPSK10M	Left Tilted	23060	25	0	DS11	Ant1	1	-	24.50	23.54	0.09	0.056	1.000	1.247	0.07
	LTE 12	QPSK10M	Right Cheek	23060	1	0	DS11	Ant4	1	-	25.00	24.28	0.04	0.784	1.000	1.180	0.93
	LTE 12	QPSK10M	Right Tilted	23060	1	0	DS11	Ant4	1	-	25.00	24.28	0.15	0.627	1.000	1.180	0.74
	LTE 12	QPSK10M	Left Cheek	23060	1	0	DS11	Ant4	1	-	25.00	24.28	0.03	0.382	1.000	1.180	0.45
	LTE 12	QPSK10M	Left Tilted	23060	1	0	DS11	Ant4	1	-	25.00	24.28	-0.16	0.375	1.000	1.180	0.44
	LTE 12	QPSK10M	Right Cheek	23060	25	0	DS11	Ant4	1	-	24.00	23.26	-0.01	0.561	1.000	1.186	0.67
	LTE 12	QPSK10M	Right Tilted	23060	25	0	DS11	Ant4	1	-	24.00	23.26	-0.13	0.512	1.000	1.186	0.61
	LTE 12	QPSK10M	Left Cheek	23060	25	0	DS11	Ant4	1	-	24.00	23.26	0.19	0.310	1.000	1.186	0.37



BUREAU VERITAS

FCC SAR Test Report



Certificate #6613.01

Plot No.	Band	Mode	Test Position	Ch.	RB#	RB Offset	Power State	Antenna	Sample	Duty Cycle %	Max. Tune-up Power (dBm)	Measured Conducted Power (dBm)	Power Drift (dB)	Measured SAR-1g (W/kg)	Duty Cycle Scaling Factor	Tune-up Scaling Factor	Scaled SAR-1g (W/kg)
	LTE 12	QPSK10M	Left Tilted	23060	25	0	DS11	Ant4	1	-	24.00	23.26	-0.02	0.304	1.000	1.186	0.36
	LTE 12	QPSK10M	Right Cheek	23095	1	0	DS11	Ant4	1	-	25.00	24.14	-0.19	0.773	1.000	1.219	0.94
P08	LTE 12	QPSK10M	Right Cheek	23130	1	0	DS11	Ant4	1	-	25.00	24.09	0.01	0.788	1.000	1.233	0.97
	LTE 12	QPSK10M	Right Cheek	23060	50	0	DS11	Ant4	1	-	24.00	23.23	0.03	0.634	1.000	1.194	0.76
	LTE 13	QPSK10M	Right Cheek	23230	1	49	DS11	Ant1	1	-	25.50	24.53	-0.01	0.120	1.000	1.250	0.15
	LTE 13	QPSK10M	Right Tilted	23230	1	49	DS11	Ant1	1	-	25.50	24.53	0.19	0.085	1.000	1.250	0.11
	LTE 13	QPSK10M	Left Cheek	23230	1	49	DS11	Ant1	1	-	25.50	24.53	0.11	0.119	1.000	1.250	0.15
	LTE 13	QPSK10M	Left Tilted	23230	1	49	DS11	Ant1	1	-	25.50	24.53	0.16	0.088	1.000	1.250	0.11
	LTE 13	QPSK10M	Right Cheek	23230	25	12	DS11	Ant1	1	-	24.50	23.50	-0.18	0.115	1.000	1.259	0.14
	LTE 13	QPSK10M	Right Tilted	23230	25	12	DS11	Ant1	1	-	24.50	23.50	-0.07	0.070	1.000	1.259	0.09
	LTE 13	QPSK10M	Left Cheek	23230	25	12	DS11	Ant1	1	-	24.50	23.50	-0.14	0.100	1.000	1.259	0.13
	LTE 13	QPSK10M	Left Tilted	23230	25	12	DS11	Ant1	1	-	24.50	23.50	0.04	0.070	1.000	1.259	0.09
P09	LTE 13	QPSK10M	Right Cheek	23230	1	49	DS11	Ant4	1	-	25.00	24.13	-0.05	0.684	1.000	1.222	0.84
	LTE 13	QPSK10M	Right Tilted	23230	1	49	DS11	Ant4	1	-	25.00	24.13	-0.14	0.533	1.000	1.222	0.65
	LTE 13	QPSK10M	Left Cheek	23230	1	49	DS11	Ant4	1	-	25.00	24.13	-0.18	0.304	1.000	1.222	0.37
	LTE 13	QPSK10M	Left Tilted	23230	1	49	DS11	Ant4	1	-	25.00	24.13	-0.16	0.296	1.000	1.222	0.36
	LTE 13	QPSK10M	Right Cheek	23230	25	12	DS11	Ant4	1	-	24.00	23.02	-0.05	0.530	1.000	1.253	0.66
	LTE 13	QPSK10M	Right Tilted	23230	25	12	DS11	Ant4	1	-	24.00	23.02	-0.07	0.448	1.000	1.253	0.56
	LTE 13	QPSK10M	Left Cheek	23230	25	12	DS11	Ant4	1	-	24.00	23.02	-0.05	0.253	1.000	1.253	0.32
	LTE 13	QPSK10M	Left Tilted	23230	25	12	DS11	Ant4	1	-	24.00	23.02	-0.11	0.247	1.000	1.253	0.31
	LTE 13	QPSK10M	Right Cheek	23230	50	0	DS11	Ant4	1	-	24.00	22.97	0.18	0.582	1.000	1.268	0.74
	LTE 26	QPSK15M	Right Cheek	26865	1	37	DS11	Ant1	1	-	25.50	24.67	0.19	0.192	1.000	1.211	0.23
	LTE 26	QPSK15M	Right Tilted	26865	1	37	DS11	Ant1	1	-	25.50	24.67	0.00	0.072	1.000	1.211	0.09
	LTE 26	QPSK15M	Left Cheek	26865	1	37	DS11	Ant1	1	-	25.50	24.67	-0.19	0.161	1.000	1.211	0.19
	LTE 26	QPSK15M	Left Tilted	26865	1	37	DS11	Ant1	1	-	25.50	24.67	0.07	0.086	1.000	1.211	0.10
	LTE 26	QPSK15M	Right Cheek	26865	36	0	DS11	Ant1	1	-	24.50	23.61	-0.12	0.135	1.000	1.227	0.17
	LTE 26	QPSK15M	Right Tilted	26865	36	0	DS11	Ant1	1	-	24.50	23.61	-0.16	0.059	1.000	1.227	0.07
	LTE 26	QPSK15M	Left Cheek	26865	36	0	DS11	Ant1	1	-	24.50	23.61	0.14	0.124	1.000	1.227	0.15
	LTE 26	QPSK15M	Left Tilted	26865	36	0	DS11	Ant1	1	-	24.50	23.61	0.19	0.066	1.000	1.227	0.08
	LTE 26	QPSK15M	Right Cheek	26865	1	0	DS11	Ant4	1	-	24.00	23.23	0.17	0.520	1.000	1.194	0.62
P10	LTE 26	QPSK15M	Right Tilted	26865	1	0	DS11	Ant4	1	-	24.00	23.23	0.16	0.642	1.000	1.194	0.77
	LTE 26	QPSK15M	Left Cheek	26865	1	0	DS11	Ant4	1	-	24.00	23.23	0.09	0.457	1.000	1.194	0.55
	LTE 26	QPSK15M	Left Tilted	26865	1	0	DS11	Ant4	1	-	24.00	23.23	0.12	0.472	1.000	1.194	0.56
	LTE 26	QPSK15M	Right Cheek	26865	36	0	DS11	Ant4	1	-	24.00	22.97	-0.04	0.597	1.000	1.268	0.76
	LTE 26	QPSK15M	Right Tilted	26865	36	0	DS11	Ant4	1	-	24.00	22.97	-0.09	0.562	1.000	1.268	0.71
	LTE 26	QPSK15M	Left Cheek	26865	36	0	DS11	Ant4	1	-	24.00	22.97	0.07	0.381	1.000	1.268	0.48
	LTE 26	QPSK15M	Left Tilted	26865	36	0	DS11	Ant4	1	-	24.00	22.97	-0.02	0.369	1.000	1.268	0.47
	LTE 38	QPSK20M	Right Cheek	38000	1	50	DS11	Ant1	1	62.9	25.50	23.99	0.09	0.096	1.006	1.416	0.14
	LTE 38	QPSK20M	Right Tilted	38000	1	50	DS11	Ant1	1	62.9	25.50	23.99	0.13	0.058	1.006	1.416	0.08
	LTE 38	QPSK20M	Left Cheek	38000	1	50	DS11	Ant1	1	62.9	25.50	23.99	0.09	0.063	1.006	1.416	0.09
	LTE 38	QPSK20M	Left Tilted	38000	1	50	DS11	Ant1	1	62.9	25.50	23.99	0.00	0.000	1.006	1.416	0.00
	LTE 38	QPSK20M	Right Cheek	38000	50	0	DS11	Ant1	1	62.9	24.50	22.98	0.15	0.087	1.006	1.419	0.12
	LTE 38	QPSK20M	Right Tilted	38000	50	0	DS11	Ant1	1	62.9	24.50	22.98	-0.06	0.042	1.006	1.419	0.06
	LTE 38	QPSK20M	Left Cheek	38000	50	0	DS11	Ant1	1	62.9	24.50	22.98	-0.11	0.045	1.006	1.419	0.06
	LTE 38	QPSK20M	Left Tilted	38000	50	0	DS11	Ant1	1	62.9	24.50	22.98	0.00	0.000	1.006	1.419	0.00
	LTE 38C	QPSK20M	Right Cheek	PCC:37901 SCC:38099	PCC:1 SCC:1	PCC:99 SCC:0	DS11	Ant1	1	62.9	25.50	23.59	-0.11	0.074	1.006	1.552	0.12
	LTE 38	QPSK20M	Right Cheek	38000	1	0	DS11	Ant4	1	62.9	19.50	18.13	0.07	0.391	1.006	1.371	0.54
	LTE 38	QPSK20M	Right Tilted	38000	1	0	DS11	Ant4	1	62.9	19.50	18.13	-0.03	0.477	1.006	1.371	0.66
	LTE 38	QPSK20M	Left Cheek	38000	1	0	DS11	Ant4	1	62.9	19.50	18.13	-0.09	0.309	1.006	1.371	0.43
	LTE 38	QPSK20M	Left Tilted	38000	1	0	DS11	Ant4	1	62.9	19.50	18.13	0.17	0.373	1.006	1.371	0.51
	LTE 38	QPSK20M	Right Cheek	38000	50	0	DS11	Ant4	1	62.9	19.50	18.03	-0.11	0.439	1.006	1.403	0.62
	LTE 38	QPSK20M	Right Tilted	38000	50	0	DS11	Ant4	1	62.9	19.50	18.03	0.07	0.613	1.006	1.403	0.87
	LTE 38	QPSK20M	Left Cheek	38000	50	0	DS11	Ant4	1	62.9	19.50	18.03	0.14	0.319	1.006	1.403	0.45
	LTE 38	QPSK20M	Left Tilted	38000	50	0	DS11	Ant4	1	62.9	19.50	18.03	-0.18	0.386	1.006	1.403	0.54
	LTE 38	QPSK20M	Right Tilted	37850	50	0	DS11	Ant4	1	62.9	19.50	17.99	-0.01	0.587	1.006	1.416	0.84
	LTE 38	QPSK20M	Right Tilted	38150	50	0	DS11	Ant4	1	62.9	19.50	17.86	0.03	0.613	1.006	1.459	0.90
P11	LTE 38	QPSK20M	Right Tilted	38000	100	0	DS11	Ant4	1	62.9	19.50	17.88	0.11	0.706	1.006	1.452	1.03
	LTE 38C	QPSK20M	Right Tilted	PCC:37901 SCC:38099	PCC:1 SCC:1	PCC:99 SCC:0	DS11	Ant4	1	62.9	19.50	17.85	-0.07	0.655	1.006	1.462	0.96
	LTE 38	QPSK20M	Right Cheek	38000	1	50	DS11	Ant3	1	-	18.00	16.89	0.07	0.164	1.000	1.291	0.21
	LTE 38	QPSK20M	Right Tilted	38000	1	50	DS11	Ant3	1	-	18.00	16.89	0.00	0.000	1.000	1.291	0.00
	LTE 38	QPSK20M	Left Cheek	38000	1	50	DS11	Ant3	1	-	18.00	16.89	0.10	0.081	1.000	1.291	0.10
	LTE 38	QPSK20M	Left Tilted	38000	1	50	DS11	Ant3	1	-	18.00	16.89	0.00	0.000	1.000	1.291	0.00
	LTE 38	QPSK20M	Right Cheek	38000	50	0	DS11	Ant3	1	-	18.00	16.70	0.15	0.167	1.000	1.349	0.23
	LTE 38	QPSK20M	Right Tilted	38000	50	0	DS11	Ant3	1	-	18.00	16.70	0.00	0.000	1.000	1.349	0.00
	LTE 38	QPSK20M	Left Cheek	38000	50	0	DS11	Ant3	1	-	18.00	16.70	-0.19	0.079	1.000	1.349	0.11
	LTE 38	QPSK20M	Left Tilted	38000	50	0	DS11	Ant3	1	-	18.00	16.70	0.00	0.000	1.000	1.349	0.00
	LTE 41	QPSK20M	Right Cheek	39750	1	0	DS11	Ant1	1	62.9	25.50	24.02	-0.09	0.133	1.006	1.406	0.19
	LTE 41	QPSK20M	Right Tilted	39750	1	0	DS11	Ant1	1	62.9	25.50	24.02	-0.16	0.057	1.006	1.406	0.08
	LTE 41	QPSK20M	Left Cheek	39750	1	0	DS11	Ant1	1	62.9	25.50	24.02	-0.06	0.082	1.006	1.406	0.12
	LTE 41	QPSK20M	Left Tilted	39750	1	0	DS11	Ant1	1	62.9	25.50	24.02	-0.10	0.041	1.006	1.406	0.06
	LTE 41	QPSK20M	Right Cheek	39750	50	0	DS11	Ant1	1	62.9	24.50	23.14	-0.19	0.097	1.006	1.368	0.13
	LTE 41	QPSK20M	Right Tilted	39750	50	0	DS11	Ant1	1	62.9	24.50	23.14	0.16	0.033	1.006	1.368	0.05
	LTE 41	QPSK20M	Left Cheek	39750	50	0	DS11	Ant1	1	62.9	24.50	23.14	0.10	0.055	1.006	1.368	0.08



BUREAU VERITAS

FCC SAR Test Report



Certificate #6613.01

Plot No.	Band	Mode	Test Position	Ch.	RB#	RB Offset	Power State	Antenna	Sample	Duty Cycle %	Max. Tune-up Power (dBm)	Measured Conducted Power (dBm)	Power Drift (dB)	Measured SAR-1g (W/kg)	Duty Cycle Scaling Factor	Tune-up Scaling Factor	Scaled SAR-1g (W/kg)
	LTE 41	QPSK20M	Left Tilted	39750	50	0	DSI1	Ant1	1	62.9	24.50	23.14	0.00	0.000	1.006	1.368	0.00
	LTE 41	QPSK20M	Right Cheek	39750	1	0	DSI1	Ant4	1	62.9	18.00	16.76	-0.04	0.355	1.006	1.330	0.48
	LTE 41	QPSK20M	Right Tilted	39750	1	0	DSI1	Ant4	1	62.9	18.00	16.76	0.07	0.429	1.006	1.330	0.57
	LTE 41	QPSK20M	Left Cheek	39750	1	0	DSI1	Ant4	1	62.9	18.00	16.76	-0.13	0.224	1.006	1.330	0.30
	LTE 41	QPSK20M	Left Tilted	39750	1	0	DSI1	Ant4	1	62.9	18.00	16.76	0.04	0.266	1.006	1.330	0.36
	LTE 41	QPSK20M	Right Cheek	39750	50	0	DSI1	Ant4	1	62.9	18.00	16.43	0.17	0.374	1.006	1.435	0.54
	LTE 41	QPSK20M	Right Tilted	39750	50	0	DSI1	Ant4	1	62.9	18.00	16.43	0.05	0.518	1.006	1.435	0.75
	LTE 41	QPSK20M	Left Cheek	39750	50	0	DSI1	Ant4	1	62.9	18.00	16.43	0.19	0.233	1.006	1.435	0.34
	LTE 41	QPSK20M	Left Tilted	39750	50	0	DSI1	Ant4	1	62.9	18.00	16.43	0.06	0.281	1.006	1.435	0.41
	LTE 41	QPSK20M	Right Tilted	40185	50	0	DSI1	Ant4	1	62.9	18.00	16.37	-0.03	0.483	1.006	1.455	0.71
	LTE 41	QPSK20M	Right Tilted	40620	50	0	DSI1	Ant4	1	62.9	18.00	16.40	0.03	0.497	1.006	1.445	0.72
	LTE 41	QPSK20M	Right Tilted	41055	50	0	DSI1	Ant4	1	62.9	18.00	16.28	-0.14	0.493	1.006	1.486	0.74
	LTE 41	QPSK20M	Right Tilted	41490	50	0	DSI1	Ant4	1	62.9	18.00	16.29	0.09	0.423	1.006	1.483	0.63
	LTE 41	QPSK20M	Right Tilted	39750	100	0	DSI1	Ant4	1	62.9	18.00	16.53	0.10	0.448	1.006	1.403	0.63
	LTE 41	QPSK20M	Right Cheek	39750	1	50	DSI1	Ant7	1	62.9	20.00	18.66	0.09	0.123	1.006	1.361	0.17
	LTE 41	QPSK20M	Right Tilted	39750	1	50	DSI1	Ant7	1	62.9	20.00	18.66	0.18	0.105	1.006	1.361	0.14
P12	LTE 41	QPSK20M	Left Cheek	39750	1	50	DSI1	Ant7	1	62.9	20.00	18.66	0.05	0.672	1.006	1.442	0.98
	LTE 41	QPSK20M	Left Tilted	39750	1	50	DSI1	Ant7	1	62.9	20.00	18.66	0.01	0.260	1.006	1.361	0.36
	LTE 41	QPSK20M	Right Cheek	39750	50	25	DSI1	Ant7	1	62.9	20.00	18.54	0.08	0.116	1.006	1.400	0.16
	LTE 41	QPSK20M	Right Tilted	39750	50	25	DSI1	Ant7	1	62.9	20.00	18.54	0.01	0.100	1.006	1.400	0.14
	LTE 41	QPSK20M	Left Cheek	39750	50	25	DSI1	Ant7	1	62.9	20.00	18.54	0.03	0.428	1.006	1.400	0.60
	LTE 41	QPSK20M	Left Tilted	39750	50	25	DSI1	Ant7	1	62.9	20.00	18.54	0.14	0.230	1.006	1.400	0.32
	LTE 41	QPSK20M	Left Cheek	40185	1	50	DSI1	Ant7	1	62.9	20.00	18.51	-0.07	0.463	1.006	1.409	0.66
	LTE 41	QPSK20M	Left Cheek	40620	1	50	DSI1	Ant7	1	62.9	20.00	18.47	-0.17	0.431	1.006	1.422	0.62
	LTE 41	QPSK20M	Left Cheek	41055	1	50	DSI1	Ant7	1	62.9	20.00	18.46	0.13	0.435	1.006	1.426	0.62
	LTE 41	QPSK20M	Left Cheek	41490	1	50	DSI1	Ant7	1	62.9	20.00	18.54	-0.19	0.468	1.006	1.400	0.66
	LTE 41	QPSK20M	Left Cheek	39750	100	0	DSI1	Ant7	1	62.9	20.00	18.55	0.10	0.422	1.006	1.396	0.59
	LTE 41	QPSK20M	Right Cheek	39750	1	50	DSI1	Ant3	1	62.9	21.00	19.72	0.12	0.556	1.006	1.343	0.75
	LTE 41	QPSK20M	Right Tilted	39750	1	50	DSI1	Ant3	1	62.9	21.00	19.72	0.07	0.079	1.006	1.343	0.11
	LTE 41	QPSK20M	Left Cheek	39750	1	50	DSI1	Ant3	1	62.9	21.00	19.72	-0.10	0.408	1.006	1.343	0.55
	LTE 41	QPSK20M	Left Tilted	39750	1	50	DSI1	Ant3	1	62.9	21.00	19.72	0.19	0.060	1.006	1.343	0.08
	LTE 41	QPSK20M	Right Cheek	39750	50	25	DSI1	Ant3	1	62.9	21.00	19.57	0.00	0.627	1.006	1.390	0.88
	LTE 41	QPSK20M	Right Tilted	39750	50	25	DSI1	Ant3	1	62.9	21.00	19.57	-0.04	0.082	1.006	1.390	0.11
	LTE 41	QPSK20M	Left Cheek	39750	50	25	DSI1	Ant3	1	62.9	21.00	19.57	0.05	0.403	1.006	1.390	0.56
	LTE 41	QPSK20M	Left Tilted	39750	50	25	DSI1	Ant3	1	62.9	21.00	19.57	-0.09	0.061	1.006	1.390	0.09
	LTE 41	QPSK20M	Right Cheek	40185	50	25	DSI1	Ant3	1	62.9	21.00	19.41	0.06	0.609	1.006	1.442	0.88
	LTE 41	QPSK20M	Right Cheek	40620	50	25	DSI1	Ant3	1	62.9	21.00	19.43	-0.05	0.585	1.006	1.435	0.85
	LTE 41	QPSK20M	Right Cheek	41055	50	25	DSI1	Ant3	1	62.9	21.00	19.36	0.07	0.584	1.006	1.459	0.86
	LTE 41	QPSK20M	Right Cheek	41490	50	25	DSI1	Ant3	1	62.9	21.00	19.38	0.19	0.600	1.006	1.452	0.88
	LTE 41	QPSK20M	Right Cheek	39750	100	0	DSI1	Ant3	1	62.9	21.00	19.64	-0.05	0.630	1.006	1.368	0.87
	LTE 41 (ENDC Only)	QPSK20M	Right Cheek	39750	1	50	DSI1	Ant3	1	62.9	18.00	16.61	-0.03	0.284	1.006	1.377	0.39
	LTE 41 (ENDC Only)	QPSK20M	Right Tilted	39750	1	50	DSI1	Ant3	1	62.9	18.00	16.61	0.01	0.049	1.006	1.377	0.07
	LTE 41 (ENDC Only)	QPSK20M	Left Cheek	39750	1	50	DSI1	Ant3	1	62.9	18.00	16.61	0.18	0.116	1.006	1.377	0.16
	LTE 41 (ENDC Only)	QPSK20M	Left Tilted	39750	1	50	DSI1	Ant3	1	62.9	18.00	16.61	0.00	0.000	1.006	1.377	0.00
	LTE 41 (ENDC Only)	QPSK20M	Right Cheek	39750	50	25	DSI1	Ant3	1	62.9	18.00	16.57	0.08	0.293	1.006	1.390	0.41
	LTE 41 (ENDC Only)	QPSK20M	Right Tilted	39750	50	25	DSI1	Ant3	1	62.9	18.00	16.57	0.12	0.050	1.006	1.390	0.07
	LTE 41 (ENDC Only)	QPSK20M	Left Cheek	39750	50	25	DSI1	Ant3	1	62.9	18.00	16.57	-0.07	0.115	1.006	1.390	0.16
	LTE 41 (ENDC Only)	QPSK20M	Left Tilted	39750	50	25	DSI1	Ant3	1	62.9	18.00	16.57	0.00	0.000	1.006	1.390	0.00
	LTE 42	QPSK20M	Right Cheek	42190	1	50	DSI1	Ant2	1	62.9	20.50	19.59	0.11	0.629	1.006	1.233	0.78
	LTE 42	QPSK20M	Right Tilted	42190	1	50	DSI1	Ant2	1	62.9	20.50	19.59	0.02	0.312	1.006	1.233	0.39
	LTE 42	QPSK20M	Left Cheek	42190	1	50	DSI1	Ant2	1	62.9	20.50	19.59	0.16	0.173	1.006	1.233	0.21
	LTE 42	QPSK20M	Left Tilted	42190	1	50	DSI1	Ant2	1	62.9	20.50	19.59	0.16	0.125	1.006	1.233	0.16
	LTE 42	QPSK20M	Right Cheek	42190	50	25	DSI1	Ant2	1	62.9	20.50	19.29	-0.14	0.630	1.006	1.321	0.84
	LTE 42	QPSK20M	Right Tilted	42190	50	25	DSI1	Ant2	1	62.9	20.50	19.29	0.07	0.311	1.006	1.321	0.41
	LTE 42	QPSK20M	Left Cheek	42190	50	25	DSI1	Ant2	1	62.9	20.50	19.29	-0.12	0.176	1.006	1.321	0.23
	LTE 42	QPSK20M	Left Tilted	42190	50	25	DSI1	Ant2	1	62.9	20.50	19.29	0.06	0.129	1.006	1.321	0.17
	LTE 42	QPSK20M	Right Cheek	42590	50	25	DSI1	Ant2	1	62.9	20.50	19.21	0.09	0.633	1.006	1.346	0.86
	LTE 42	QPSK20M	Right Cheek	42990	50	25	DSI1	Ant2	1	62.9	20.50	19.04	0.08	0.594	1.006	1.400	0.84
	LTE 42	QPSK20M	Right Cheek	42190	100	0	DSI1	Ant2	1	62.9	20.50	19.27	0.15	0.632	1.006	1.327	0.84
	LTE 42	QPSK20M	Right Cheek	42990	1	50	DSI1	Ant3	1	62.9	20.00	18.55	0.17	0.589	1.006	1.396	0.83
	LTE 42	QPSK20M	Right Tilted	42990	1	50	DSI1	Ant3	1	62.9	20.00	18.55	-0.19	0.118	1.006	1.396	0.17
	LTE 42	QPSK20M	Left Cheek	42990	1	50	DSI1	Ant3	1	62.9	20.00	18.55	-0.04	0.326	1.006	1.396	0.46
	LTE 42	QPSK20M	Left Tilted	42990	1	50	DSI1	Ant3	1	62.9	20.00	18.55	0.06	0.077	1.006	1.396	0.11
	LTE 42	QPSK20M	Right Cheek	42990	50	25	DSI1	Ant3	1	62.9	19.00	17.48	-0.12	0.469	1.006	1.419	0.67
	LTE 42	QPSK20M	Right Tilted	42990	50	25	DSI1	Ant3	1	62.9	19.00	17.48	0.19	0.094	1.006	1.419	0.13
	LTE 42	QPSK20M	Left Cheek	42990	50	25	DSI1	Ant3	1	62.9	19.00	17.48	-0.02	0.257	1.006	1.419	0.37
	LTE 42	QPSK20M	Left Tilted	42990	50	25	DSI1	Ant3	1	62.9	19.00	17.48	0.11	0.061	1.006	1.419	0.09
	LTE 42	QPSK20M	Right Cheek	42190	1	50	DSI1	Ant3	1	62.9	20.00	18.38	-0.12	0.427	1.006	1.452	0.62



BUREAU VERITAS

FCC SAR Test Report



Certificate #6613.01

Plot No.	Band	Mode	Test Position	Ch.	RB#	RB Offset	Power State	Antenna	Sample	Duty Cycle %	Max. Tune-up Power (dBm)	Measured Conducted Power (dBm)	Power Drift (dB)	Measured SAR-1g (W/kg)	Duty Cycle Scaling Factor	Tune-up Scaling Factor	Scaled SAR-1g (W/kg)
	LTE 42	QPSK20M	Right Cheek	42590	1	50	DSI1	Ant3	1	62.9	20.00	18.24	0.01	0.524	1.006	1.500	0.79
	LTE 42	QPSK20M	Right Cheek	42990	100	0	DSI1	Ant3	1	62.9	19.00	17.57	0.09	0.467	1.006	1.390	0.65
	LTE 42 (ENDC Only)	QPSK20M	Right Cheek	42990	1	50	DSI1	Ant3	1	62.9	15.50	14.27	0.02	0.251	1.006	1.327	0.34
	LTE 42 (ENDC Only)	QPSK20M	Right Tilted	42990	1	50	DSI1	Ant3	1	62.9	15.50	14.27	0.18	0.048	1.006	1.327	0.06
	LTE 42 (ENDC Only)	QPSK20M	Left Cheek	42990	1	50	DSI1	Ant3	1	62.9	15.50	14.27	0.06	0.106	1.006	1.327	0.14
	LTE 42 (ENDC Only)	QPSK20M	Left Tilted	42990	1	50	DSI1	Ant3	1	62.9	15.50	14.27	0.00	0.000	1.006	1.327	0.00
	LTE 42 (ENDC Only)	QPSK20M	Right Cheek	42990	50	25	DSI1	Ant3	1	62.9	15.50	14.04	-0.18	0.253	1.006	1.400	0.36
	LTE 42 (ENDC Only)	QPSK20M	Right Tilted	42990	50	25	DSI1	Ant3	1	62.9	15.50	14.04	0.12	0.042	1.006	1.400	0.06
	LTE 42 (ENDC Only)	QPSK20M	Left Cheek	42990	50	25	DSI1	Ant3	1	62.9	15.50	14.04	0.11	0.105	1.006	1.400	0.15
	LTE 42 (ENDC Only)	QPSK20M	Left Tilted	42990	50	25	DSI1	Ant3	1	62.9	15.50	14.04	0.00	0.000	1.006	1.400	0.00
	LTE 42	QPSK20M	Right Cheek	42990	1	50	DSI1	Ant5	1	62.9	18.50	17.11	-0.04	0.399	1.006	1.377	0.55
	LTE 42	QPSK20M	Right Tilted	42990	1	50	DSI1	Ant5	1	62.9	18.50	17.11	0.16	0.483	1.006	1.377	0.67
	LTE 42	QPSK20M	Left Cheek	42990	1	50	DSI1	Ant5	1	62.9	18.50	17.11	0.18	0.527	1.006	1.377	0.73
	LTE 42	QPSK20M	Left Tilted	42990	1	50	DSI1	Ant5	1	62.9	18.50	17.11	-0.15	0.610	1.006	1.377	0.85
	LTE 42	QPSK20M	Right Cheek	42990	50	0	DSI1	Ant5	1	62.9	18.50	17.05	-0.02	0.407	1.006	1.396	0.57
	LTE 42	QPSK20M	Right Tilted	42990	50	0	DSI1	Ant5	1	62.9	18.50	17.05	-0.13	0.489	1.006	1.396	0.69
	LTE 42	QPSK20M	Left Cheek	42990	50	0	DSI1	Ant5	1	62.9	18.50	17.05	-0.06	0.535	1.006	1.396	0.75
	LTE 42	QPSK20M	Left Tilted	42990	50	0	DSI1	Ant5	1	62.9	18.50	17.05	0.05	0.619	1.006	1.396	0.87
	LTE 42	QPSK20M	Left Tilted	42190	1	50	DSI1	Ant5	1	62.9	18.50	16.95	0.17	0.626	1.006	1.429	0.90
P13	LTE 42	QPSK20M	Left Tilted	42590	1	50	DSI1	Ant5	1	62.9	18.50	16.88	0.06	0.735	1.006	1.452	1.07
	LTE 42	QPSK20M	Left Tilted	42190	50	0	DSI1	Ant5	1	62.9	18.50	16.95	-0.18	0.630	1.006	1.429	0.91
	LTE 42	QPSK20M	Left Tilted	42590	50	0	DSI1	Ant5	1	62.9	18.50	17.01	-0.14	0.661	1.006	1.409	0.94
	LTE 42	QPSK20M	Left Tilted	42990	100	0	DSI1	Ant5	1	62.9	18.50	16.97	0.10	0.604	1.006	1.422	0.86
	LTE 42	QPSK20M	Right Cheek	42190	1	50	DSI1	Ant7	1	62.9	21.50	20.27	-0.16	0.078	1.006	1.327	0.10
	LTE 42	QPSK20M	Right Tilted	42190	1	50	DSI1	Ant7	1	62.9	21.50	20.27	-0.11	0.075	1.006	1.327	0.10
	LTE 42	QPSK20M	Left Cheek	42190	1	50	DSI1	Ant7	1	62.9	21.50	20.27	-0.09	0.502	1.006	1.327	0.67
	LTE 42	QPSK20M	Left Tilted	42190	1	50	DSI1	Ant7	1	62.9	21.50	20.27	-0.06	0.182	1.006	1.327	0.24
	LTE 42	QPSK20M	Right Cheek	42190	50	25	DSI1	Ant7	1	62.9	21.50	20.14	-0.05	0.076	1.006	1.368	0.10
	LTE 42	QPSK20M	Right Tilted	42190	50	25	DSI1	Ant7	1	62.9	21.50	20.14	0.07	0.074	1.006	1.368	0.10
	LTE 42	QPSK20M	Left Cheek	42190	50	25	DSI1	Ant7	1	62.9	21.50	20.14	0.17	0.508	1.006	1.368	0.70
	LTE 42	QPSK20M	Left Tilted	42190	50	25	DSI1	Ant7	1	62.9	21.50	20.14	-0.02	0.179	1.006	1.368	0.25
	LTE 42 (ENDC Only)	QPSK20M	Right Cheek	42190	1	50	DSI1	Ant7	1	62.9	20.50	19.12	-0.19	0.059	1.006	1.374	0.08
	LTE 42 (ENDC Only)	QPSK20M	Right Tilted	42190	1	50	DSI1	Ant7	1	62.9	20.50	19.12	0.09	0.054	1.006	1.374	0.07
	LTE 42 (ENDC Only)	QPSK20M	Left Cheek	42190	1	50	DSI1	Ant7	1	62.9	20.50	19.12	0.03	0.450	1.006	1.374	0.62
	LTE 42 (ENDC Only)	QPSK20M	Left Tilted	42190	1	50	DSI1	Ant7	1	62.9	20.50	19.12	-0.05	0.142	1.006	1.374	0.20
	LTE 42 (ENDC Only)	QPSK20M	Right Cheek	42190	50	25	DSI1	Ant7	1	62.9	20.50	19.07	-0.07	0.056	1.006	1.390	0.08
	LTE 42 (ENDC Only)	QPSK20M	Right Tilted	42190	50	25	DSI1	Ant7	1	62.9	20.50	19.07	0.08	0.053	1.006	1.390	0.07
	LTE 42 (ENDC Only)	QPSK20M	Left Cheek	42190	50	25	DSI1	Ant7	1	62.9	20.50	19.07	-0.06	0.448	1.006	1.390	0.63
	LTE 42 (ENDC Only)	QPSK20M	Left Tilted	42190	50	25	DSI1	Ant7	1	62.9	20.50	19.07	0.02	0.139	1.006	1.390	0.19
P14	LTE 48	QPSK20M	Right Cheek	55340	1	50	DSI1	Ant2	1	62.9	21.50	20.55	0.01	0.788	1.006	1.245	0.99
	LTE 48	QPSK20M	Right Tilted	55340	1	50	DSI1	Ant2	1	62.9	21.50	20.55	-0.04	0.251	1.006	1.245	0.31
	LTE 48	QPSK20M	Left Cheek	55340	1	50	DSI1	Ant2	1	62.9	21.50	20.55	0.12	0.137	1.006	1.245	0.17
	LTE 48	QPSK20M	Left Tilted	55340	1	50	DSI1	Ant2	1	62.9	21.50	20.55	0.11	0.101	1.006	1.245	0.13
	LTE 48	QPSK20M	Right Cheek	55340	50	25	DSI1	Ant2	1	62.9	21.00	19.98	-0.09	0.623	1.006	1.265	0.79
	LTE 48	QPSK20M	Right Tilted	55340	50	25	DSI1	Ant2	1	62.9	21.00	19.98	-0.03	0.253	1.006	1.265	0.32
	LTE 48	QPSK20M	Left Cheek	55340	50	25	DSI1	Ant2	1	62.9	21.00	19.98	0.04	0.139	1.006	1.265	0.18
	LTE 48	QPSK20M	Left Tilted	55340	50	25	DSI1	Ant2	1	62.9	21.00	19.98	-0.05	0.103	1.006	1.265	0.13
	LTE 48	QPSK20M	Right Cheek	55830	1	50	DSI1	Ant2	1	62.9	21.50	20.26	0.04	0.573	1.006	1.330	0.77
	LTE 48	QPSK20M	Right Cheek	56150	1	50	DSI1	Ant2	1	62.9	21.50	20.18	0.18	0.561	1.006	1.355	0.77
	LTE 48	QPSK20M	Right Cheek	56640	1	50	DSI1	Ant2	1	62.9	21.50	20.02	-0.01	0.544	1.006	1.406	0.77
	LTE 48	QPSK20M	Right Cheek	55340	100	0	DSI1	Ant2	1	62.9	21.00	19.95	0.05	0.615	1.006	1.274	0.79
	LTE 48	QPSK20M	Right Cheek	56150	1	50	DSI1	Ant3	1	62.9	20.00	18.58	0.11	0.491	1.006	1.387	0.69
	LTE 48	QPSK20M	Right Tilted	56150	1	50	DSI1	Ant3	1	62.9	20.00	18.58	-0.05	0.107	1.006	1.387	0.15
	LTE 48	QPSK20M	Left Cheek	56150	1	50	DSI1	Ant3	1	62.9	20.00	18.58	0.19	0.262	1.006	1.387	0.37
	LTE 48	QPSK20M	Left Tilted	56150	1	50	DSI1	Ant3	1	62.9	20.00	18.58	-0.16	0.063	1.006	1.387	0.09
	LTE 48	QPSK20M	Right Cheek	56150	50	25	DSI1	Ant3	1	62.9	19.00	17.48	-0.08	0.392	1.006	1.419	0.56
	LTE 48	QPSK20M	Right Tilted	56150	50	25	DSI1	Ant3	1	62.9	19.00	17.48	-0.13	0.084	1.006	1.419	0.12
	LTE 48	QPSK20M	Left Cheek	56150	50	25	DSI1	Ant3	1	62.9	19.00	17.48	-0.03	0.212	1.006	1.419	0.30
	LTE 48	QPSK20M	Left Tilted	56150	50	25	DSI1	Ant3	1	62.9	19.00	17.48	0.08	0.054	1.006	1.419	0.08
	LTE 48	QPSK20M	Right Cheek	55340	1	50	DSI1	Ant5	1	62.9	18.50	16.98	-0.16	0.335	1.006	1.419	0.48
	LTE 48	QPSK20M	Right Tilted	55340	1	50	DSI1	Ant5	1	62.9	18.50	16.98	0.02	0.395	1.006	1.419	0.56



BUREAU VERITAS

FCC SAR Test Report



Certificate #6613.01

Plot No.	Band	Mode	Test Position	Ch.	RB#	RB Offset	Power State	Antenna	Sample	Duty Cycle %	Max. Tune-up Power (dBm)	Measured Conducted Power (dBm)	Power Drift (dB)	Measured SAR-1g (W/kg)	Duty Cycle Scaling Factor	Tune-up Scaling Factor	Scaled SAR-1g (W/kg)
	LTE 48	QPSK20M	Left Cheek	55340	1	50	DS11	Ant5	1	62.9	18.50	16.98	0.08	0.418	1.006	1.419	0.60
	LTE 48	QPSK20M	Left Tilted	55340	1	50	DS11	Ant5	1	62.9	18.50	16.98	0.05	0.447	1.006	1.419	0.64
	LTE 48	QPSK20M	Right Cheek	55340	50	0	DS11	Ant5	1	62.9	18.50	16.94	0.12	0.340	1.006	1.432	0.49
	LTE 48	QPSK20M	Right Tilted	55340	50	0	DS11	Ant5	1	62.9	18.50	16.94	0.01	0.401	1.006	1.432	0.58
	LTE 48	QPSK20M	Left Cheek	55340	50	0	DS11	Ant5	1	62.9	18.50	16.94	-0.19	0.423	1.006	1.432	0.61
	LTE 48	QPSK20M	Left Tilted	55340	50	0	DS11	Ant5	1	62.9	18.50	16.94	0.14	0.453	1.006	1.432	0.65
	LTE 48	QPSK20M	Right Cheek	55340	1	50	DS11	Ant7	1	62.9	21.50	20.27	0.05	0.081	1.006	1.327	0.11
	LTE 48	QPSK20M	Right Tilted	55340	1	50	DS11	Ant7	1	62.9	21.50	20.27	-0.03	0.077	1.006	1.327	0.10
	LTE 48	QPSK20M	Left Cheek	55340	1	50	DS11	Ant7	1	62.9	21.50	20.27	-0.01	0.385	1.006	1.327	0.51
	LTE 48	QPSK20M	Left Tilted	55340	1	50	DS11	Ant7	1	62.9	21.50	20.27	0.15	0.170	1.006	1.327	0.23
	LTE 48	QPSK20M	Right Cheek	55340	50	25	DS11	Ant7	1	62.9	21.50	20.15	0.01	0.080	1.006	1.365	0.11
	LTE 48	QPSK20M	Right Tilted	55340	50	25	DS11	Ant7	1	62.9	21.50	20.15	0.09	0.078	1.006	1.365	0.11
	LTE 48	QPSK20M	Left Cheek	55340	50	25	DS11	Ant7	1	62.9	21.50	20.15	0.14	0.394	1.006	1.365	0.54
	LTE 48	QPSK20M	Left Tilted	55340	50	25	DS11	Ant7	1	62.9	21.50	20.15	0.11	0.164	1.006	1.365	0.23
	LTE 66	QPSK20M	Right Cheek	132322	1	50	DS11	Ant1	1	-	25.50	24.51	-0.04	0.084	1.000	1.256	0.11
	LTE 66	QPSK20M	Right Tilted	132322	1	50	DS11	Ant1	1	-	25.50	24.51	0.00	0.000	1.000	1.256	0.00
	LTE 66	QPSK20M	Left Cheek	132322	1	50	DS11	Ant1	1	-	25.50	24.51	0.19	0.047	1.000	1.256	0.06
	LTE 66	QPSK20M	Left Tilted	132322	1	50	DS11	Ant1	1	-	25.50	24.51	0.00	0.000	1.000	1.256	0.00
	LTE 66	QPSK20M	Right Cheek	132322	50	50	DS11	Ant1	1	-	24.50	23.56	-0.16	0.052	1.000	1.242	0.06
	LTE 66	QPSK20M	Right Tilted	132322	50	50	DS11	Ant1	1	-	24.50	23.56	0.00	0.000	1.000	1.242	0.00
	LTE 66	QPSK20M	Left Cheek	132322	50	50	DS11	Ant1	1	-	24.50	23.56	-0.19	0.035	1.000	1.242	0.04
	LTE 66	QPSK20M	Left Tilted	132322	50	50	DS11	Ant1	1	-	24.50	23.56	0.00	0.000	1.000	1.242	0.00
	LTE 66	QPSK20M	Right Cheek	132072	1	50	DS11	Ant4	1	-	17.50	16.38	0.05	0.451	1.000	1.294	0.58
	LTE 66	QPSK20M	Right Tilted	132072	1	50	DS11	Ant4	1	-	17.50	16.38	0.14	0.470	1.000	1.294	0.61
	LTE 66	QPSK20M	Left Cheek	132072	1	50	DS11	Ant4	1	-	17.50	16.38	0.08	0.286	1.000	1.294	0.37
	LTE 66	QPSK20M	Left Tilted	132072	1	50	DS11	Ant4	1	-	17.50	16.38	-0.03	0.345	1.000	1.294	0.45
	LTE 66	QPSK20M	Right Cheek	132072	50	50	DS11	Ant4	1	-	17.50	16.32	0.12	0.476	1.000	1.312	0.62
P15	LTE 66	QPSK20M	Right Tilted	132072	50	50	DS11	Ant4	1	-	17.50	16.32	0.01	0.515	1.000	1.312	0.68
	LTE 66	QPSK20M	Left Cheek	132072	50	50	DS11	Ant4	1	-	17.50	16.32	-0.07	0.297	1.000	1.312	0.39
	LTE 66	QPSK20M	Left Tilted	132072	50	50	DS11	Ant4	1	-	17.50	16.32	0.12	0.364	1.000	1.312	0.48
	LTE 66	QPSK20M	Right Cheek	132322	1	50	DS11	Ant3	1	-	18.00	16.58	-0.02	0.209	1.000	1.387	0.29
	LTE 66	QPSK20M	Right Tilted	132322	1	50	DS11	Ant3	1	-	18.00	16.58	0.12	0.050	1.000	1.387	0.07
	LTE 66	QPSK20M	Left Cheek	132322	1	50	DS11	Ant3	1	-	18.00	16.58	0.03	0.130	1.000	1.387	0.18
	LTE 66	QPSK20M	Left Tilted	132322	1	50	DS11	Ant3	1	-	18.00	16.58	0.00	0.000	1.000	1.387	0.00
	LTE 66	QPSK20M	Right Cheek	132322	50	25	DS11	Ant3	1	-	18.00	16.53	0.16	0.201	1.000	1.403	0.28
	LTE 66	QPSK20M	Right Tilted	132322	50	25	DS11	Ant3	1	-	18.00	16.53	0.15	0.049	1.000	1.403	0.07
	LTE 66	QPSK20M	Left Cheek	132322	50	25	DS11	Ant3	1	-	18.00	16.53	-0.10	0.106	1.000	1.403	0.15
	LTE 66	QPSK20M	Left Tilted	132322	50	25	DS11	Ant3	1	-	18.00	16.53	0.00	0.000	1.000	1.403	0.00
	n2	DFT-QPSK20M	Right Cheek	376000	1	53	DS11	Ant1	1	-	25.00	23.86	0.00	0.000	1.000	1.300	0.00
	n2	DFT-QPSK20M	Right Tilted	376000	1	53	DS11	Ant1	1	-	25.00	23.86	0.00	0.000	1.000	1.300	0.00
	n2	DFT-QPSK20M	Left Cheek	376000	1	53	DS11	Ant1	1	-	25.00	23.86	0.05	0.060	1.000	1.300	0.08
	n2	DFT-QPSK20M	Left Tilted	376000	1	53	DS11	Ant1	1	-	25.00	23.86	0.00	0.000	1.000	1.300	0.00
	n2	DFT-QPSK20M	Right Cheek	376000	50	28	DS11	Ant1	1	-	25.00	24.57	0.00	0.000	1.000	1.104	0.00
	n2	DFT-QPSK20M	Right Tilted	376000	50	28	DS11	Ant1	1	-	25.00	24.57	0.00	0.000	1.000	1.104	0.00
	n2	DFT-QPSK20M	Left Cheek	376000	50	28	DS11	Ant1	1	-	25.00	24.57	-0.08	0.042	1.000	1.104	0.05
	n2	DFT-QPSK20M	Left Tilted	376000	50	28	DS11	Ant1	1	-	25.00	24.57	0.00	0.000	1.000	1.104	0.00
	n2	DFT-QPSK20M	Right Cheek	376000	1	53	DS11	Ant4	1	-	16.00	15.29	-0.12	0.728	1.000	1.178	0.86
	n2	DFT-QPSK20M	Right Tilted	376000	1	53	DS11	Ant4	1	-	16.00	15.29	0.16	0.763	1.000	1.178	0.90
	n2	DFT-QPSK20M	Left Cheek	376000	1	53	DS11	Ant4	1	-	16.00	15.29	0.02	0.335	1.000	1.178	0.39
	n2	DFT-QPSK20M	Left Tilted	376000	1	53	DS11	Ant4	1	-	16.00	15.29	0.17	0.420	1.000	1.178	0.49
	n2	DFT-QPSK20M	Right Cheek	376000	50	28	DS11	Ant4	1	-	16.00	15.37	0.16	0.743	1.000	1.156	0.86
	n2	DFT-QPSK20M	Right Tilted	376000	50	28	DS11	Ant4	1	-	16.00	15.37	0.10	0.769	1.000	1.156	0.89
	n2	DFT-QPSK20M	Left Cheek	376000	50	28	DS11	Ant4	1	-	16.00	15.37	0.16	0.351	1.000	1.156	0.41
	n2	DFT-QPSK20M	Left Tilted	376000	50	28	DS11	Ant4	1	-	16.00	15.37	0.17	0.421	1.000	1.156	0.49
	n2	DFT-QPSK20M	Right Cheek	372000	1	53	DS11	Ant4	1	-	16.00	15.11	0.14	0.740	1.000	1.227	0.91
	n2	DFT-QPSK20M	Right Tilted	380000	1	53	DS11	Ant4	1	-	16.00	14.97	0.10	0.651	1.000	1.268	0.83
P16	n2	DFT-QPSK20M	Right Tilted	372000	1	53	DS11	Ant4	1	-	16.00	15.11	0.01	0.847	1.000	1.227	1.04
	n2	DFT-QPSK20M	Right Tilted	380000	1	53	DS11	Ant4	1	-	16.00	14.97	-0.06	0.698	1.000	1.268	0.88
	n2	DFT-QPSK20M	Right Cheek	372000	50	28	DS11	Ant4	1	-	16.00	15.28	-0.18	0.791	1.000	1.180	0.93
	n2	DFT-QPSK20M	Right Cheek	380000	50	28	DS11	Ant4	1	-	16.00	15.32	0.02	0.659	1.000	1.169	0.77
	n2	DFT-QPSK20M	Right Tilted	372000	50	28	DS11	Ant4	1	-	16.00	15.28	-0.09	0.832	1.000	1.180	0.98
	n2	DFT-QPSK20M	Right Tilted	380000	50	28	DS11	Ant4	1	-	16.00	15.32	0.07	0.695	1.000	1.169	0.81
	n2	DFT-QPSK20M	Right Cheek	376000	100	0	DS11	Ant4	1	-	16.00	15.25	-0.15	0.758	1.000	1.189	0.90
	n2	DFT-QPSK20M	Right Tilted	376000	100	0	DS11	Ant4	1	-	16.00	15.25	-0.02	0.777	1.000	1.189	0.92
	n7	DFT-QPSK50M	Right Cheek	507000	1	135	DS11	Ant1	1	-	25.00	23.40	0.08	0.239	1.000	1.445	0.35
	n7	DFT-QPSK50M	Right Tilted	507000	1	135	DS11	Ant1	1	-	25.00	23.40	-0.16	0.097	1.000	1.445	0.14
	n7	DFT-QPSK50M	Left Cheek	507000	1	135	DS11	Ant1	1	-	25.00	23.40	0.13	0.105	1.000	1.445	0.15
	n7	DFT-QPSK50M	Left Tilted	507000	1	135	DS11	Ant1	1	-	25.00	23.40	0.17	0.063	1.000	1.445	0.09
	n7	DFT-QPSK50M	Right Cheek	507000	135	68	DS11	Ant1	1	-	25.00	24.05	0.15	0.211	1.000	1.245	0.26
	n7	DFT-QPSK50M	Right Tilted	507000	135	68	DS11	Ant1	1	-	25.00	24.05	0.06	0.100	1.000	1.245	0.12
	n7	DFT-QPSK50M	Left Cheek	507000	135	68	DS11	Ant1	1	-	25.00	24.05	0.10	0.118	1.000	1.245	0.15
	n7	DFT-QPSK50M	Left Tilted	507000	135	68	DS11	Ant1	1	-	25.00	24.05	0.11	0.069	1.000	1.245	0.09
	n7	DFT-QPSK50M	Right Cheek	505000	1	135	DS11	Ant4	1	-	17.00	16.15	-0.11	0.548	1.000	1.216	0.67
	n7	DFT-QPSK50M	Right Tilted	505000	1	135	DS11	Ant4	1	-	17.00	16.15	-0.18	0.691	1.000	1.216	0.84
	n7	DFT-QPSK50M	Left Cheek	505000	1	135	DS11	Ant4	1	-	17.00	16.15	-0.04	0.382	1.000	1.216	0.46



Certificate #6613.01

BUREAU VERITAS

FCC SAR Test Report

Plot No.	Band	Mode	Test Position	Ch.	RB#	RB Offset	Power State	Antenna	Sample	Duty Cycle %	Max. Tune-up Power (dBm)	Measured Conducted Power (dBm)	Power Drift (dB)	Measured SAR-1g (W/kg)	Duty Cycle Scaling Factor	Tune-up Scaling Factor	Scaled SAR-1g (W/kg)
	n7	DFT-QPSK50M	Left Tilted	505000	1	135	DS11	Ant4	1	-	17.00	16.15	0.18	0.463	1.000	1.216	0.56
	n7	DFT-QPSK50M	Right Cheek	505000	135	68	DS11	Ant4	1	-	17.00	16.48	0.12	0.551	1.000	1.127	0.62
	n7	DFT-QPSK50M	Right Tilted	505000	135	68	DS11	Ant4	1	-	17.00	16.48	0.19	0.694	1.000	1.127	0.78
	n7	DFT-QPSK50M	Left Cheek	505000	135	68	DS11	Ant4	1	-	17.00	16.48	-0.13	0.386	1.000	1.127	0.44
	n7	DFT-QPSK50M	Left Tilted	505000	135	68	DS11	Ant4	1	-	17.00	16.48	0.19	0.475	1.000	1.127	0.54
	n7	DFT-QPSK50M	Right Tilted	507000	1	135	DS11	Ant4	1	-	17.00	16.09	-0.09	0.676	1.000	1.233	0.83
P17	n7	DFT-QPSK50M	Right Tilted	509000	1	135	DS11	Ant4	1	-	17.00	16.02	0.01	0.824	1.000	1.253	1.03
	n7	DFT-QPSK50M	Right Tilted	505000	270	0	DS11	Ant4	1	-	17.00	16.10	-0.09	0.672	1.000	1.230	0.83
	n12	DFT-QPSK15M	Right Cheek	141500	1	38	DS11	Ant1	1	-	25.50	24.40	0.16	0.149	1.000	1.288	0.19
	n12	DFT-QPSK15M	Right Tilted	141500	1	38	DS11	Ant1	1	-	25.50	24.40	0.15	0.097	1.000	1.288	0.12
	n12	DFT-QPSK15M	Left Cheek	141500	1	38	DS11	Ant1	1	-	25.50	24.40	0.12	0.091	1.000	1.288	0.12
	n12	DFT-QPSK15M	Left Tilted	141500	1	38	DS11	Ant1	1	-	25.50	24.40	-0.08	0.122	1.000	1.288	0.16
	n12	DFT-QPSK15M	Right Cheek	141500	36	22	DS11	Ant1	1	-	25.50	24.56	-0.01	0.152	1.000	1.242	0.19
	n12	DFT-QPSK15M	Right Tilted	141500	36	22	DS11	Ant1	1	-	25.50	24.56	-0.06	0.099	1.000	1.242	0.12
	n12	DFT-QPSK15M	Left Cheek	141500	36	22	DS11	Ant1	1	-	25.50	24.56	-0.04	0.097	1.000	1.242	0.12
	n12	DFT-QPSK15M	Left Tilted	141500	36	22	DS11	Ant1	1	-	25.50	24.56	0.11	0.119	1.000	1.242	0.15
	n12	DFT-QPSK15M	Right Cheek	141500	1	38	DS11	Ant4	1	-	25.00	23.80	-0.19	0.650	1.000	1.318	0.86
P18	n12	DFT-QPSK15M	Right Tilted	141500	1	38	DS11	Ant4	1	-	25.00	23.80	-0.06	0.699	1.000	1.318	0.92
	n12	DFT-QPSK15M	Left Cheek	141500	1	38	DS11	Ant4	1	-	25.00	23.80	-0.08	0.383	1.000	1.318	0.50
	n12	DFT-QPSK15M	Left Tilted	141500	1	38	DS11	Ant4	1	-	25.00	23.80	-0.16	0.421	1.000	1.318	0.55
	n12	DFT-QPSK15M	Right Cheek	141500	36	22	DS11	Ant4	1	-	25.00	23.92	-0.19	0.652	1.000	1.282	0.84
	n12	DFT-QPSK15M	Right Tilted	141500	36	22	DS11	Ant4	1	-	25.00	23.92	0.13	0.694	1.000	1.282	0.89
	n12	DFT-QPSK15M	Left Cheek	141500	36	22	DS11	Ant4	1	-	25.00	23.92	0.15	0.395	1.000	1.282	0.51
	n12	DFT-QPSK15M	Left Tilted	141500	36	22	DS11	Ant4	1	-	25.00	23.92	0.11	0.436	1.000	1.282	0.56
	n12	DFT-QPSK15M	Right Cheek	141300	1	38	DS11	Ant4	1	-	25.00	23.71	-0.09	0.637	1.000	1.346	0.86
	n12	DFT-QPSK15M	Right Cheek	141700	1	38	DS11	Ant4	1	-	25.00	23.72	0.11	0.631	1.000	1.343	0.85
	n12	DFT-QPSK15M	Right Cheek	141300	36	22	DS11	Ant4	1	-	25.00	23.78	0.05	0.634	1.000	1.324	0.84
	n12	DFT-QPSK15M	Right Cheek	141700	36	22	DS11	Ant4	1	-	25.00	23.88	0.09	0.652	1.000	1.294	0.84
	n12	DFT-QPSK15M	Right Tilted	141300	1	38	DS11	Ant4	1	-	25.00	23.71	-0.12	0.670	1.000	1.346	0.90
	n12	DFT-QPSK15M	Right Tilted	141700	1	38	DS11	Ant4	1	-	25.00	23.72	0.10	0.685	1.000	1.343	0.92
	n12	DFT-QPSK15M	Right Tilted	141300	36	22	DS11	Ant4	1	-	25.00	23.78	0.09	0.676	1.000	1.324	0.90
	n12	DFT-QPSK15M	Right Tilted	141700	36	22	DS11	Ant4	1	-	25.00	23.88	-0.05	0.702	1.000	1.294	0.91
	n12	DFT-QPSK15M	Right Cheek	141500	75	0	DS11	Ant4	1	-	24.00	22.74	-0.14	0.653	1.000	1.337	0.87
	n12	DFT-QPSK15M	Right Tilted	141500	75	0	DS11	Ant4	1	-	24.00	22.74	-0.05	0.683	1.000	1.337	0.91
	n26	DFT-QPSK20M	Right Cheek	166300	1	53	DS11	Ant1	1	-	25.50	24.54	0.13	0.221	1.000	1.247	0.28
	n26	DFT-QPSK20M	Right Tilted	166300	1	53	DS11	Ant1	1	-	25.50	24.54	0.01	0.087	1.000	1.247	0.11
	n26	DFT-QPSK20M	Left Cheek	166300	1	53	DS11	Ant1	1	-	25.50	24.54	-0.12	0.176	1.000	1.247	0.22
	n26	DFT-QPSK20M	Left Tilted	166300	1	53	DS11	Ant1	1	-	25.50	24.54	-0.05	0.093	1.000	1.247	0.12
	n26	DFT-QPSK20M	Right Cheek	166300	50	28	DS11	Ant1	1	-	25.50	24.70	0.04	0.181	1.000	1.202	0.22
	n26	DFT-QPSK20M	Right Tilted	166300	50	28	DS11	Ant1	1	-	25.50	24.70	-0.12	0.089	1.000	1.202	0.11
	n26	DFT-QPSK20M	Left Cheek	166300	50	28	DS11	Ant1	1	-	25.50	24.70	0.13	0.179	1.000	1.202	0.22
	n26	DFT-QPSK20M	Left Tilted	166300	50	28	DS11	Ant1	1	-	25.50	24.70	-0.14	0.092	1.000	1.202	0.11
	n26	DFT-QPSK20M	Right Cheek	166300	1	53	DS11	Ant4	1	-	24.00	23.31	0.05	0.657	1.000	1.172	0.77
	n26	DFT-QPSK20M	Right Tilted	166300	1	53	DS11	Ant4	1	-	24.00	23.31	-0.18	0.664	1.000	1.172	0.78
	n26	DFT-QPSK20M	Left Cheek	166300	1	53	DS11	Ant4	1	-	24.00	23.31	0.12	0.426	1.000	1.172	0.50
	n26	DFT-QPSK20M	Left Tilted	166300	1	53	DS11	Ant4	1	-	24.00	23.31	0.02	0.434	1.000	1.172	0.51
	n26	DFT-QPSK20M	Right Cheek	166300	50	28	DS11	Ant4	1	-	24.00	23.35	-0.07	0.673	1.000	1.161	0.78
	n26	DFT-QPSK20M	Right Tilted	166300	50	28	DS11	Ant4	1	-	24.00	23.35	-0.19	0.679	1.000	1.161	0.79
	n26	DFT-QPSK20M	Left Cheek	166300	50	28	DS11	Ant4	1	-	24.00	23.35	0.11	0.421	1.000	1.161	0.49
	n26	DFT-QPSK20M	Left Tilted	166300	50	28	DS11	Ant4	1	-	24.00	23.35	0.18	0.434	1.000	1.161	0.50
	n26	DFT-QPSK20M	Right Cheek	164800	1	53	DS11	Ant4	1	-	24.00	23.14	0.09	0.659	1.000	1.219	0.80
	n26	DFT-QPSK20M	Right Cheek	167800	1	53	DS11	Ant4	1	-	24.00	23.17	-0.06	0.662	1.000	1.211	0.80
	n26	DFT-QPSK20M	Right Tilted	164800	1	53	DS11	Ant4	1	-	24.00	23.14	-0.01	0.654	1.000	1.219	0.80
P19	n26	DFT-QPSK20M	Right Tilted	167800	1	53	DS11	Ant4	1	-	24.00	23.17	0.08	0.687	1.000	1.211	0.83
	n26	DFT-QPSK20M	Right Cheek	164800	50	28	DS11	Ant4	1	-	24.00	23.14	0.06	0.635	1.000	1.219	0.77
	n26	DFT-QPSK20M	Right Cheek	167800	50	28	DS11	Ant4	1	-	24.00	23.18	0.17	0.657	1.000	1.208	0.79
	n26	DFT-QPSK20M	Right Tilted	164800	50	28	DS11	Ant4	1	-	24.00	23.14	-0.02	0.667	1.000	1.219	0.81
	n26	DFT-QPSK20M	Right Tilted	167800	50	28	DS11	Ant4	1	-	24.00	23.18	-0.03	0.671	1.000	1.208	0.81
	n26	DFT-QPSK20M	Right Cheek	166300	100	0	DS11	Ant4	1	-	24.00	22.95	-0.01	0.634	1.000	1.274	0.81
	n26	DFT-QPSK20M	Right Tilted	166300	100	0	DS11	Ant4	1	-	24.00	22.95	0.04	0.645	1.000	1.274	0.82
	n38	DFT-QPSK40M	Right Cheek	518000	1	53	DS11	Ant1	1	100	25.00	24.11	0.10	0.196	1.000	1.227	0.24
	n38	DFT-QPSK40M	Right Tilted	518000	1	53	DS11	Ant1	1	100	25.00	24.11	-0.03	0.105	1.000	1.227	0.13
	n38	DFT-QPSK40M	Left Cheek	518000	1	53	DS11	Ant1	1	100	25.00	24.11	-0.06	0.099	1.000	1.227	0.12
	n38	DFT-QPSK40M	Left Tilted	518000	1	53	DS11	Ant1	1	100	25.00	24.11	-0.04	0.072	1.000	1.227	0.09
	n38	DFT-QPSK40M	Right Cheek	518000	50	28	DS11	Ant1	1	100	25.00	24.14	-0.08	0.191	1.000	1.219	0.23
	n38	DFT-QPSK40M	Right Tilted	518000	50	28	DS11	Ant1	1	100	25.00	24.14	0.04	0.102	1.000	1.219	0.12
	n38	DFT-QPSK40M	Left Cheek	518000	50	28	DS11	Ant1	1	100	25.00	24.14	-0.03	0.097	1.000	1.219	0.12
	n38	DFT-QPSK40M	Left Tilted	518000	50	28	DS11	Ant1	1	100	25.00	24.14	0.11	0.077	1.000	1.219	0.09
	n38	DFT-QPSK40M	Right Cheek	520000	1	53	DS11	Ant4	1	100	16.50	15.45	-0.12	0.448	1.000	1.274	0.57
	n38	DFT-QPSK40M	Right Tilted	520000	1	53	DS11	Ant4	1	100	16.50	15.45	-0.19	0.585	1.000	1.274	0.74
	n38	DFT-QPSK40M	Left Cheek	520000	1	53	DS11	Ant4	1	100	16.50	15.45	-0.16	0.338	1.000	1.274	0.43
	n38	DFT-QPSK40M	Left Tilted	520000	1	53	DS11	Ant4	1	100	16.50	15.45	-0.07	0.410	1.000	1.274	0.52
	n38	DFT-QPSK40M	Right Cheek	520000	50	28	DS11	Ant4	1	100	16.50	15.61	0.03	0.491	1.000	1.227	0.60
P20	n38	DFT-QPSK40M	Right Tilted	520000	50	28	DS11	Ant4	1	100	16.50	15.61	0.06	0.791	1.000	1.227	0.97
	n38	DFT-QPSK40M	Left Cheek	520000	50	28	DS11	Ant4	1	100	16.50	15.61	-0.03	0.356	1.000	1.227	0.44



BUREAU VERITAS

FCC SAR Test Report



Certificate #6613.01

Plot No.	Band	Mode	Test Position	Ch.	RB#	RB Offset	Power State	Antenna	Sample	Duty Cycle %	Max. Tune-up Power (dBm)	Measured Conducted Power (dBm)	Power Drift (dB)	Measured SAR-1g (W/kg)	Duty Cycle Scaling Factor	Tune-up Scaling Factor	Scaled SAR-1g (W/kg)
	n38	DFT-QPSK40M	Left Tilted	520000	50	28	DS11	Ant4	1	100	16.50	15.61	0.10	0.415	1.000	1.227	0.51
	n38	DFT-QPSK40M	Right Tilted	518000	50	28	DS11	Ant4	1	100	16.50	15.55	-0.02	0.614	1.000	1.245	0.76
	n38	DFT-QPSK40M	Right Tilted	519000	50	28	DS11	Ant4	1	100	16.50	15.53	0.04	0.625	1.000	1.250	0.78
	n38	DFT-QPSK40M	Right Tilted	520000	100	0	DS11	Ant4	1	100	16.50	15.46	-0.20	0.623	1.000	1.271	0.79
	n41	DFT-QPSK100M	Right Cheek	518598	1	137	DS11	Ant1	1	100	25.00	24.01	0.06	0.182	1.000	1.256	0.23
	n41	DFT-QPSK100M	Right Tilted	518598	1	137	DS11	Ant1	1	100	25.00	24.01	0.04	0.098	1.000	1.256	0.12
	n41	DFT-QPSK100M	Left Cheek	518598	1	137	DS11	Ant1	1	100	25.00	24.01	0.11	0.109	1.000	1.256	0.14
	n41	DFT-QPSK100M	Left Tilted	518598	1	137	DS11	Ant1	1	100	25.00	24.01	-0.09	0.077	1.000	1.256	0.10
	n41	DFT-QPSK100M	Right Cheek	518598	135	69	DS11	Ant1	1	100	25.00	24.06	-0.14	0.199	1.000	1.242	0.25
	n41	DFT-QPSK100M	Right Tilted	518598	135	69	DS11	Ant1	1	100	25.00	24.06	0.03	0.100	1.000	1.242	0.12
	n41	DFT-QPSK100M	Left Cheek	518598	135	69	DS11	Ant1	1	100	25.00	24.06	-0.16	0.112	1.000	1.242	0.14
	n41	DFT-QPSK100M	Left Tilted	518598	135	69	DS11	Ant1	1	100	25.00	24.06	-0.02	0.076	1.000	1.242	0.09
	n41	DFT-QPSK100M	Right Cheek	518598	1	137	DS11	Ant3	1	100	21.00	20.26	-0.09	0.661	1.000	1.186	0.78
	n41	DFT-QPSK100M	Right Tilted	518598	1	137	DS11	Ant3	1	100	21.00	20.26	0.12	0.119	1.000	1.186	0.14
	n41	DFT-QPSK100M	Left Cheek	518598	1	137	DS11	Ant3	1	100	21.00	20.26	-0.15	0.522	1.000	1.186	0.62
	n41	DFT-QPSK100M	Left Tilted	518598	1	137	DS11	Ant3	1	100	21.00	20.26	0.01	0.075	1.000	1.186	0.09
	n41	DFT-QPSK100M	Right Cheek	518598	135	69	DS11	Ant3	1	100	21.00	20.37	-0.08	0.704	1.000	1.156	0.81
	n41	DFT-QPSK100M	Right Tilted	518598	135	69	DS11	Ant3	1	100	21.00	20.37	0.06	0.123	1.000	1.156	0.14
	n41	DFT-QPSK100M	Left Cheek	518598	135	69	DS11	Ant3	1	100	21.00	20.37	0.09	0.403	1.000	1.156	0.47
	n41	DFT-QPSK100M	Left Tilted	518598	135	69	DS11	Ant3	1	100	21.00	20.37	0.12	0.081	1.000	1.156	0.09
	n41	DFT-QPSK100M	Right Cheek	509202	135	69	DS11	Ant3	1	100	21.00	20.19	0.13	0.762	1.000	1.205	0.92
	n41	DFT-QPSK100M	Right Cheek	528000	135	69	DS11	Ant3	1	100	21.00	19.99	-0.07	0.696	1.000	1.262	0.88
	n41	DFT-QPSK100M	Right Cheek	518598	270	0	DS11	Ant3	1	100	21.00	19.82	-0.12	0.695	1.000	1.312	0.91
	n41	DFT-QPSK100M	Right Cheek	518598	1	137	DS11	Ant4	1	100	16.50	15.77	-0.01	0.593	1.000	1.183	0.70
P21	n41	DFT-QPSK100M	Right Tilted	518598	1	137	DS11	Ant4	1	100	16.50	15.77	0.05	0.902	1.000	1.183	1.07
	n41	DFT-QPSK100M	Left Cheek	518598	1	137	DS11	Ant4	1	100	16.50	15.77	-0.10	0.376	1.000	1.183	0.44
	n41	DFT-QPSK100M	Left Tilted	518598	1	137	DS11	Ant4	1	100	16.50	15.77	0.07	0.481	1.000	1.183	0.57
	n41	DFT-QPSK100M	Right Cheek	518598	135	69	DS11	Ant4	1	100	16.50	15.87	-0.18	0.646	1.000	1.156	0.75
	n41	DFT-QPSK100M	Right Tilted	518598	135	69	DS11	Ant4	1	100	16.50	15.87	-0.17	0.725	1.000	1.156	0.84
	n41	DFT-QPSK100M	Left Cheek	518598	135	69	DS11	Ant4	1	100	16.50	15.87	-0.09	0.482	1.000	1.156	0.56
	n41	DFT-QPSK100M	Left Tilted	518598	135	69	DS11	Ant4	1	100	16.50	15.87	0.10	0.559	1.000	1.156	0.65
	n41	DFT-QPSK100M	Right Tilted	509202	1	137	DS11	Ant4	1	100	16.50	15.69	-0.17	0.728	1.000	1.205	0.88
	n41	DFT-QPSK100M	Right Tilted	528000	1	137	DS11	Ant4	1	100	16.50	15.57	0.12	0.735	1.000	1.239	0.91
	n41	DFT-QPSK100M	Right Tilted	509202	135	69	DS11	Ant4	1	100	16.50	15.63	-0.11	0.750	1.000	1.222	0.92
	n41	DFT-QPSK100M	Right Tilted	528000	135	69	DS11	Ant4	1	100	16.50	15.75	0.08	0.762	1.000	1.189	0.91
	n41	DFT-QPSK100M	Right Tilted	518598	270	0	DS11	Ant4	1	100	16.50	15.72	-0.04	0.737	1.000	1.197	0.88
	n41	DFT-QPSK100M	Right Cheek	518598	1	137	DS11	Ant7	1	100	20.00	19.14	0.15	0.157	1.000	1.219	0.19
	n41	DFT-QPSK100M	Right Tilted	518598	1	137	DS11	Ant7	1	100	20.00	19.14	-0.08	0.131	1.000	1.219	0.16
	n41	DFT-QPSK100M	Left Cheek	518598	1	137	DS11	Ant7	1	100	20.00	19.14	-0.03	0.735	1.000	1.219	0.90
	n41	DFT-QPSK100M	Left Tilted	518598	1	137	DS11	Ant7	1	100	20.00	19.14	-0.15	0.346	1.000	1.219	0.42
	n41	DFT-QPSK100M	Right Cheek	518598	135	69	DS11	Ant7	1	100	20.00	19.16	0.15	0.167	1.000	1.213	0.20
	n41	DFT-QPSK100M	Right Tilted	518598	135	69	DS11	Ant7	1	100	20.00	19.16	0.12	0.135	1.000	1.213	0.16
	n41	DFT-QPSK100M	Left Cheek	518598	135	69	DS11	Ant7	1	100	20.00	19.16	-0.02	0.745	1.000	1.213	0.90
	n41	DFT-QPSK100M	Left Tilted	518598	135	69	DS11	Ant7	1	100	20.00	19.16	-0.06	0.353	1.000	1.213	0.43
	n41	DFT-QPSK100M	Left Cheek	509202	1	137	DS11	Ant7	1	100	20.00	19.08	-0.02	0.742	1.000	1.236	0.92
	n41	DFT-QPSK100M	Left Cheek	528000	1	137	DS11	Ant7	1	100	20.00	19.11	0.06	0.655	1.000	1.227	0.80
	n41	DFT-QPSK100M	Left Cheek	509202	135	69	DS11	Ant7	1	100	20.00	19.11	0.13	0.779	1.000	1.227	0.96
	n41	DFT-QPSK100M	Left Cheek	528000	135	69	DS11	Ant7	1	100	20.00	18.91	-0.06	0.661	1.000	1.285	0.85
	n41	DFT-QPSK100M	Left Cheek	518598	270	0	DS11	Ant7	1	100	20.00	18.88	0.09	0.601	1.000	1.294	0.78
	n48	DFT-QPSK100M	Right Cheek	640000	1	137	DS11	Ant2	1	100	19.50	18.52	-0.03	0.630	1.000	1.253	0.79
	n48	DFT-QPSK100M	Right Tilted	640000	1	137	DS11	Ant2	1	100	19.50	18.52	0.12	0.340	1.000	1.253	0.43
	n48	DFT-QPSK100M	Left Cheek	640000	1	137	DS11	Ant2	1	100	19.50	18.52	-0.08	0.188	1.000	1.253	0.24
	n48	DFT-QPSK100M	Left Tilted	640000	1	137	DS11	Ant2	1	100	19.50	18.52	-0.14	0.154	1.000	1.253	0.19
	n48	DFT-QPSK100M	Right Cheek	640000	135	69	DS11	Ant2	1	100	19.50	18.72	0.13	0.707	1.000	1.197	0.85
	n48	DFT-QPSK100M	Right Tilted	640000	135	69	DS11	Ant2	1	100	19.50	18.72	0.18	0.349	1.000	1.197	0.42
	n48	DFT-QPSK100M	Left Cheek	640000	135	69	DS11	Ant2	1	100	19.50	18.72	0.01	0.190	1.000	1.197	0.23
	n48	DFT-QPSK100M	Left Tilted	640000	135	69	DS11	Ant2	1	100	19.50	18.72	0.09	0.162	1.000	1.197	0.19
	n48	DFT-QPSK100M	Right Cheek	641666	135	69	DS11	Ant2	1	100	19.50	18.60	-0.13	0.676	1.000	1.230	0.83
	n48	DFT-QPSK100M	Right Cheek	643332	135	69	DS11	Ant2	1	100	19.50	18.67	0.04	0.672	1.000	1.211	0.81
	n48	DFT-QPSK100M	Right Cheek	640000	270	0	DS11	Ant2	1	100	19.50	18.65	-0.19	0.653	1.000	1.216	0.79
	n48	DFT-QPSK100M	Right Cheek	643332	1	137	DS11	Ant3	1	100	18.00	17.19	0.08	0.794	1.000	1.205	0.96
	n48	DFT-QPSK100M	Right Tilted	643332	1	137	DS11	Ant3	1	100	18.00	17.19	-0.09	0.125	1.000	1.205	0.15
	n48	DFT-QPSK100M	Left Cheek	643332	1	137	DS11	Ant3	1	100	18.00	17.19	-0.04	0.262	1.000	1.205	0.32
	n48	DFT-QPSK100M	Left Tilted	643332	1	137	DS11	Ant3	1	100	18.00	17.19	0.08	0.061	1.000	1.205	0.07
	n48	DFT-QPSK100M	Right Cheek	643332	135	69	DS11	Ant3	1	100	18.00	17.33	0.05	0.646	1.000	1.167	0.75
	n48	DFT-QPSK100M	Right Tilted	643332	135	69	DS11	Ant3	1	100	18.00	17.33	0.13	0.128	1.000	1.167	0.15
	n48	DFT-QPSK100M	Left Cheek	643332	135	69	DS11	Ant3	1	100	18.00	17.33	-0.06	0.261	1.000	1.167	0.30
	n48	DFT-QPSK100M	Left Tilted	643332	135	69	DS11	Ant3	1	100	18.00	17.33	0.11	0.066	1.000	1.167	0.08
	n48	DFT-QPSK100M	Right Cheek	640000	1	137	DS11	Ant3	1	100	18.00	17.15	-0.14	0.632	1.000	1.216	0.77
	n48	DFT-QPSK100M	Right Cheek	641666	1	137	DS11	Ant3	1	100	18.00	17.13	-0.18	0.631	1.000	1.222	0.77
	n48	DFT-QPSK100M	Right Cheek	643332	270	0	DS11	Ant3	1	100	18.00	17.22	0.17	0.622	1.000	1.197	0.74
	n48	DFT-QPSK100M	Right Cheek	640000	1	137	DS11	Ant5	1	100	17.00	16.14	0.10	0.399	1.000	1.219	0.49
	n48	DFT-QPSK100M	Right Tilted	640000	1	137	DS11	Ant5	1	100	17.00	16.14	0.03	0.474	1.000	1.219	0.58
	n48	DFT-QPSK100M	Left Cheek	640000	1	137	DS11	Ant5	1	100	17.00	16.14	0.14	0.551	1.000	1.219	0.67
	n48	DFT-QPSK100M	Left Tilted	640000	1	137	DS11	Ant5	1	100	17.00	16.14	-0.15	0.654	1.000</		



BUREAU VERITAS

FCC SAR Test Report



Certificate #6613.01

Plot No.	Band	Mode	Test Position	Ch.	RB#	RB Offset	Power State	Antenna	Sample	Duty Cycle %	Max. Tune-up Power (dBm)	Measured Conducted Power (dBm)	Power Drift (dB)	Measured SAR-1g (W/kg)	Duty Cycle Scaling Factor	Tune-up Scaling Factor	Scaled SAR-1g (W/kg)
	n48	DFT-QPSK100M	Right Cheek	640000	135	69	DS11	Ant5	1	100	17.00	16.27	0.12	0.405	1.000	1.183	0.48
	n48	DFT-QPSK100M	Right Tilted	640000	135	69	DS11	Ant5	1	100	17.00	16.27	0.02	0.466	1.000	1.183	0.55
	n48	DFT-QPSK100M	Left Cheek	640000	135	69	DS11	Ant5	1	100	17.00	16.27	0.06	0.556	1.000	1.183	0.66
P22	n48	DFT-QPSK100M	Left Tilted	640000	135	69	DS11	Ant5	1	100	17.00	16.27	-0.07	0.836	1.000	1.183	0.99
	n48	DFT-QPSK100M	Left Cheek	641666	1	137	DS11	Ant5	1	100	17.00	16.08	-0.14	0.459	1.000	1.236	0.57
	n48	DFT-QPSK100M	Left Cheek	643332	1	137	DS11	Ant5	1	100	17.00	15.95	-0.08	0.461	1.000	1.274	0.59
	n48	DFT-QPSK100M	Left Tilted	641666	1	137	DS11	Ant5	1	100	17.00	16.08	-0.12	0.550	1.000	1.236	0.68
	n48	DFT-QPSK100M	Left Tilted	643332	1	137	DS11	Ant5	1	100	17.00	15.95	0.13	0.544	1.000	1.274	0.69
	n48	DFT-QPSK100M	Left Cheek	641666	135	69	DS11	Ant5	1	100	17.00	16.26	-0.09	0.457	1.000	1.186	0.54
	n48	DFT-QPSK100M	Left Cheek	643332	135	69	DS11	Ant5	1	100	17.00	16.21	0.16	0.466	1.000	1.199	0.56
	n48	DFT-QPSK100M	Left Tilted	641666	135	69	DS11	Ant5	1	100	17.00	16.26	0.10	0.559	1.000	1.186	0.66
	n48	DFT-QPSK100M	Left Tilted	643332	135	69	DS11	Ant5	1	100	17.00	16.21	-0.01	0.553	1.000	1.199	0.66
	n48	DFT-QPSK100M	Left Cheek	640000	270	0	DS11	Ant5	1	100	17.00	16.22	0.06	0.532	1.000	1.197	0.64
	n48	DFT-QPSK100M	Left Tilted	640000	270	0	DS11	Ant5	1	100	17.00	16.22	0.08	0.645	1.000	1.197	0.77
	n48	DFT-QPSK100M	Right Cheek	640000	1	137	DS11	Ant7	1	100	19.50	18.14	-0.06	0.118	1.000	1.368	0.16
	n48	DFT-QPSK100M	Right Tilted	640000	1	137	DS11	Ant7	1	100	19.50	18.14	-0.10	0.105	1.000	1.368	0.14
	n48	DFT-QPSK100M	Left Cheek	640000	1	137	DS11	Ant7	1	100	19.50	18.14	-0.12	0.639	1.000	1.368	0.87
	n48	DFT-QPSK100M	Left Tilted	640000	1	137	DS11	Ant7	1	100	19.50	18.14	0.05	0.249	1.000	1.368	0.34
	n48	DFT-QPSK100M	Right Cheek	640000	135	69	DS11	Ant7	1	100	19.50	18.24	-0.14	0.118	1.000	1.337	0.16
	n48	DFT-QPSK100M	Right Tilted	640000	135	69	DS11	Ant7	1	100	19.50	18.24	0.00	0.109	1.000	1.337	0.15
	n48	DFT-QPSK100M	Left Cheek	640000	135	69	DS11	Ant7	1	100	19.50	18.24	0.08	0.722	1.000	1.337	0.97
	n48	DFT-QPSK100M	Left Tilted	640000	135	69	DS11	Ant7	1	100	19.50	18.24	-0.14	0.265	1.000	1.337	0.35
	n48	DFT-QPSK100M	Left Cheek	641666	1	137	DS11	Ant7	1	100	19.50	18.12	0.05	0.699	1.000	1.374	0.96
	n48	DFT-QPSK100M	Left Cheek	643332	1	137	DS11	Ant7	1	100	19.50	17.93	0.03	0.656	1.000	1.435	0.94
	n48	DFT-QPSK100M	Left Cheek	641666	135	69	DS11	Ant7	1	100	19.50	18.20	0.05	0.671	1.000	1.349	0.91
	n48	DFT-QPSK100M	Left Cheek	643332	135	69	DS11	Ant7	1	100	19.50	18.19	-0.13	0.692	1.000	1.352	0.94
	n48	DFT-QPSK100M	Left Cheek	640000	270	0	DS11	Ant7	1	100	19.50	18.18	0.11	0.667	1.000	1.355	0.90
	n66	DFT-QPSK40M	Right Cheek	349000	1	107	DS11	Ant1	1	-	25.50	24.18	0.11	0.094	1.000	1.355	0.13
	n66	DFT-QPSK40M	Right Tilted	349000	1	107	DS11	Ant1	1	-	25.50	24.18	0.00	0.000	1.000	1.355	0.00
	n66	DFT-QPSK40M	Left Cheek	349000	1	107	DS11	Ant1	1	-	25.50	24.18	0.12	0.050	1.000	1.355	0.07
	n66	DFT-QPSK40M	Left Tilted	349000	1	107	DS11	Ant1	1	-	25.50	24.18	0.00	0.000	1.000	1.355	0.00
	n66	DFT-QPSK40M	Right Cheek	349000	108	54	DS11	Ant1	1	-	25.50	24.57	-0.07	0.073	1.000	1.239	0.09
	n66	DFT-QPSK40M	Right Tilted	349000	108	54	DS11	Ant1	1	-	25.50	24.57	0.00	0.000	1.000	1.239	0.00
	n66	DFT-QPSK40M	Left Cheek	349000	108	54	DS11	Ant1	1	-	25.50	24.57	0.12	0.052	1.000	1.239	0.06
	n66	DFT-QPSK40M	Left Tilted	349000	108	54	DS11	Ant1	1	-	25.50	24.57	0.00	0.000	1.000	1.239	0.00
	n66	DFT-QPSK40M	Right Cheek	349000	1	107	DS11	Ant4	1	-	19.40	18.72	-0.01	0.652	1.000	1.169	0.76
	n66	DFT-QPSK40M	Right Tilted	349000	1	107	DS11	Ant4	1	-	19.40	18.72	-0.12	0.687	1.000	1.169	0.80
	n66	DFT-QPSK40M	Left Cheek	349000	1	107	DS11	Ant4	1	-	19.40	18.72	0.08	0.477	1.000	1.169	0.56
	n66	DFT-QPSK40M	Left Tilted	349000	1	107	DS11	Ant4	1	-	19.40	18.72	-0.14	0.566	1.000	1.169	0.66
	n66	DFT-QPSK40M	Right Cheek	349000	108	54	DS11	Ant4	1	-	19.40	18.84	0.12	0.631	1.000	1.138	0.72
	n66	DFT-QPSK40M	Right Tilted	349000	108	54	DS11	Ant4	1	-	19.40	18.84	0.03	0.712	1.000	1.138	0.81
	n66	DFT-QPSK40M	Left Cheek	349000	108	54	DS11	Ant4	1	-	19.40	18.84	0.07	0.467	1.000	1.138	0.53
	n66	DFT-QPSK40M	Left Tilted	349000	108	54	DS11	Ant4	1	-	19.40	18.84	-0.13	0.581	1.000	1.138	0.66
	n66	DFT-QPSK40M	Right Tilted	346000	1	107	DS11	Ant4	1	-	19.40	18.65	0.14	0.748	1.000	1.189	0.89
	n66	DFT-QPSK40M	Right Tilted	352000	1	107	DS11	Ant4	1	-	19.40	18.68	-0.16	0.699	1.000	1.180	0.83
P23	n66	DFT-QPSK40M	Right Tilted	346000	108	54	DS11	Ant4	1	-	19.40	18.69	-0.08	0.819	1.000	1.178	0.96
	n66	DFT-QPSK40M	Right Tilted	352000	108	54	DS11	Ant4	1	-	19.40	18.71	0.15	0.715	1.000	1.172	0.84
	n66	DFT-QPSK40M	Right Tilted	349000	216	0	DS11	Ant4	1	-	19.40	18.53	0.06	0.733	1.000	1.222	0.90
	n66 (ENDC Only)	DFT-QPSK40M	Right Cheek	349000	1	107	DS11	Ant4	1	-	18.50	17.65	-0.09	0.547	1.000	1.216	0.67
	n66 (ENDC Only)	DFT-QPSK40M	Right Tilted	349000	1	107	DS11	Ant4	1	-	18.50	17.65	-0.18	0.651	1.000	1.216	0.79
	n66 (ENDC Only)	DFT-QPSK40M	Left Cheek	349000	1	107	DS11	Ant4	1	-	18.50	17.65	-0.16	0.357	1.000	1.216	0.43
	n66 (ENDC Only)	DFT-QPSK40M	Left Tilted	349000	1	107	DS11	Ant4	1	-	18.50	17.65	-0.04	0.430	1.000	1.216	0.52
	n66 (ENDC Only)	DFT-QPSK40M	Right Cheek	349000	108	54	DS11	Ant4	1	-	18.50	17.72	0.17	0.565	1.000	1.197	0.68
	n66 (ENDC Only)	DFT-QPSK40M	Right Tilted	349000	108	54	DS11	Ant4	1	-	18.50	17.72	0.10	0.565	1.000	1.197	0.68
	n66 (ENDC Only)	DFT-QPSK40M	Left Cheek	349000	108	54	DS11	Ant4	1	-	18.50	17.72	-0.18	0.382	1.000	1.197	0.46
	n66 (ENDC Only)	DFT-QPSK40M	Left Tilted	349000	108	54	DS11	Ant4	1	-	18.50	17.72	-0.07	0.456	1.000	1.197	0.55
	n77	DFT-QPSK100M	Right Cheek	633334	1	137	DS11	Ant2	1	100	18.50	17.57	0.06	0.659	1.000	1.239	0.82
	n77	DFT-QPSK100M	Right Tilted	633334	1	137	DS11	Ant2	1	100	18.50	17.57	0.16	0.393	1.000	1.239	0.49
	n77	DFT-QPSK100M	Left Cheek	633334	1	137	DS11	Ant2	1	100	18.50	17.57	-0.04	0.213	1.000	1.239	0.26
	n77	DFT-QPSK100M	Left Tilted	633334	1	137	DS11	Ant2	1	100	18.50	17.57	0.02	0.160	1.000	1.239	0.20
	n77	DFT-QPSK100M	Right Cheek	633334	135	69	DS11	Ant2	1	100	18.50	17.77	0.06	0.566	1.000	1.183	0.67
	n77	DFT-QPSK100M	Right Tilted	633334	135	69	DS11	Ant2	1	100	18.50	17.77	0.03	0.245	1.000	1.183	0.29
	n77	DFT-QPSK100M	Left Cheek	633334	135	69	DS11	Ant2	1	100	18.50	17.77	0.04	0.129	1.000	1.183	0.15
	n77	DFT-QPSK100M	Left Tilted	633334	135	69	DS11	Ant2	1	100	18.50	17.77	0.14	0.096	1.000	1.183	0.11
	n77	DFT-QPSK100M	Right Cheek	633334	270	0	DS11	Ant2	1	100	18.50	17.62	-0.06	0.640	1.000	1.225	0.78
	n77 (ENDC Only)	DFT-QPSK100M	Right Cheek	633334	1	137	DS11	Ant2	1	100	16.50	15.35	0.11	0.304	1.000	1.303	0.40



BUREAU VERITAS

FCC SAR Test Report



Certificate #6613.01

Plot No.	Band	Mode	Test Position	Ch.	RB#	RB Offset	Power State	Antenna	Sample	Duty Cycle %	Max. Tune-up Power (dBm)	Measured Conducted Power (dBm)	Power Drift (dB)	Measured SAR-1g (W/kg)	Duty Cycle Scaling Factor	Tune-up Scaling Factor	Scaled SAR-1g (W/kg)
	n77 (ENDC Only)	DFT-QPSK100M	Right Tilted	633334	1	137	DSI1	Ant2	1	100	16.50	15.35	0.06	0.142	1.000	1.303	0.19
	n77 (ENDC Only)	DFT-QPSK100M	Left Cheek	633334	1	137	DSI1	Ant2	1	100	16.50	15.35	0.14	0.078	1.000	1.303	0.10
	n77 (ENDC Only)	DFT-QPSK100M	Left Tilted	633334	1	137	DSI1	Ant2	1	100	16.50	15.35	-0.07	0.074	1.000	1.303	0.10
	n77 (ENDC Only)	DFT-QPSK100M	Right Cheek	633334	135	69	DSI1	Ant2	1	100	16.50	15.73	0.01	0.305	1.000	1.194	0.36
	n77 (ENDC Only)	DFT-QPSK100M	Right Tilted	633334	135	69	DSI1	Ant2	1	100	16.50	15.73	-0.11	0.150	1.000	1.194	0.18
	n77 (ENDC Only)	DFT-QPSK100M	Left Cheek	633334	135	69	DSI1	Ant2	1	100	16.50	15.73	-0.17	0.075	1.000	1.194	0.09
	n77 (ENDC Only)	DFT-QPSK100M	Left Tilted	633334	135	69	DSI1	Ant2	1	100	16.50	15.73	0.10	0.067	1.000	1.194	0.08
	n77	DFT-QPSK100M	Right Cheek	650000	1	137	DSI1	Ant2	1	100	18.50	17.49	-0.06	0.561	1.000	1.262	0.71
	n77	DFT-QPSK100M	Right Tilted	650000	1	137	DSI1	Ant2	1	100	18.50	17.49	-0.03	0.272	1.000	1.262	0.34
	n77	DFT-QPSK100M	Left Cheek	650000	1	137	DSI1	Ant2	1	100	18.50	17.49	-0.18	0.146	1.000	1.262	0.18
	n77	DFT-QPSK100M	Left Tilted	650000	1	137	DSI1	Ant2	1	100	18.50	17.49	0.03	0.112	1.000	1.262	0.14
	n77	DFT-QPSK100M	Right Cheek	650000	135	69	DSI1	Ant2	1	100	18.50	17.65	0.07	0.599	1.000	1.216	0.73
	n77	DFT-QPSK100M	Right Tilted	650000	135	69	DSI1	Ant2	1	100	18.50	17.65	0.15	0.284	1.000	1.216	0.35
	n77	DFT-QPSK100M	Left Cheek	650000	135	69	DSI1	Ant2	1	100	18.50	17.65	-0.18	0.154	1.000	1.216	0.19
	n77	DFT-QPSK100M	Left Tilted	650000	135	69	DSI1	Ant2	1	100	18.50	17.65	0.01	0.114	1.000	1.216	0.14
	n77	DFT-QPSK100M	Right Cheek	656000	1	137	DSI1	Ant2	1	100	18.50	17.37	-0.07	0.560	1.000	1.297	0.73
	n77	DFT-QPSK100M	Right Cheek	662000	1	137	DSI1	Ant2	1	100	18.50	17.42	0.04	0.360	1.000	1.282	0.46
	n77	DFT-QPSK100M	Right Cheek	656000	135	69	DSI1	Ant2	1	100	18.50	17.62	0.10	0.520	1.000	1.225	0.64
	n77	DFT-QPSK100M	Right Cheek	662000	135	69	DSI1	Ant2	1	100	18.50	17.57	0.13	0.659	1.000	1.239	0.82
	n77	DFT-QPSK100M	Right Cheek	662000	135	69	DSI1	Ant2	1	100	18.50	17.57	-0.08	0.704	1.000	1.239	0.87
	n77	DFT-QPSK100M	Right Cheek	650000	270	0	DSI1	Ant2	1	100	18.50	17.60	-0.11	0.485	1.000	1.230	0.60
	n77 (ENDC Only)	DFT-QPSK100M	Right Cheek	650000	1	137	DSI1	Ant2	1	100	16.50	15.34	0.06	0.275	1.000	1.306	0.36
	n77 (ENDC Only)	DFT-QPSK100M	Right Tilted	650000	1	137	DSI1	Ant2	1	100	16.50	15.34	-0.10	0.130	1.000	1.306	0.17
	n77 (ENDC Only)	DFT-QPSK100M	Left Cheek	650000	1	137	DSI1	Ant2	1	100	16.50	15.34	0.04	0.070	1.000	1.306	0.09
	n77 (ENDC Only)	DFT-QPSK100M	Left Tilted	650000	1	137	DSI1	Ant2	1	100	16.50	15.34	-0.14	0.062	1.000	1.306	0.08
	n77 (ENDC Only)	DFT-QPSK100M	Right Cheek	650000	135	69	DSI1	Ant2	1	100	16.50	15.62	-0.02	0.289	1.000	1.225	0.35
	n77 (ENDC Only)	DFT-QPSK100M	Right Tilted	650000	135	69	DSI1	Ant2	1	100	16.50	15.62	0.13	0.130	1.000	1.225	0.16
	n77 (ENDC Only)	DFT-QPSK100M	Left Cheek	650000	135	69	DSI1	Ant2	1	100	16.50	15.62	-0.01	0.076	1.000	1.225	0.09
	n77 (ENDC Only)	DFT-QPSK100M	Left Tilted	650000	135	69	DSI1	Ant2	1	100	16.50	15.62	0.06	0.063	1.000	1.225	0.08
	n77	DFT-QPSK100M	Right Cheek	633334	1	137	DSI1	Ant3	1	100	20.00	19.15	0.17	0.719	1.000	1.216	0.87
	n77	DFT-QPSK100M	Right Tilted	633334	1	137	DSI1	Ant3	1	100	20.00	19.15	0.15	0.142	1.000	1.216	0.17
	n77	DFT-QPSK100M	Left Cheek	633334	1	137	DSI1	Ant3	1	100	20.00	19.15	0.07	0.422	1.000	1.216	0.51
	n77	DFT-QPSK100M	Left Tilted	633334	1	137	DSI1	Ant3	1	100	20.00	19.15	-0.09	0.093	1.000	1.216	0.11
	n77	DFT-QPSK100M	Right Cheek	633334	135	69	DSI1	Ant3	1	100	20.00	19.21	0.16	0.743	1.000	1.199	0.89
	n77	DFT-QPSK100M	Right Tilted	633334	135	69	DSI1	Ant3	1	100	20.00	19.21	0.09	0.149	1.000	1.199	0.18
	n77	DFT-QPSK100M	Left Cheek	633334	135	69	DSI1	Ant3	1	100	20.00	19.21	0.06	0.432	1.000	1.199	0.52
	n77	DFT-QPSK100M	Left Tilted	633334	135	69	DSI1	Ant3	1	100	20.00	19.21	0.07	0.090	1.000	1.199	0.11
	n77	DFT-QPSK100M	Right Cheek	633334	270	0	DSI1	Ant3	1	100	20.00	19.08	-0.06	0.686	1.000	1.236	0.85
	n77 (ENDC Only)	DFT-QPSK100M	Right Cheek	633334	1	137	DSI1	Ant3	1	100	17.00	16.20	-0.10	0.302	1.000	1.202	0.36
	n77 (ENDC Only)	DFT-QPSK100M	Right Tilted	633334	1	137	DSI1	Ant3	1	100	17.00	16.20	-0.13	0.301	1.000	1.202	0.36
	n77 (ENDC Only)	DFT-QPSK100M	Left Cheek	633334	1	137	DSI1	Ant3	1	100	17.00	16.20	-0.15	0.136	1.000	1.202	0.16
	n77 (ENDC Only)	DFT-QPSK100M	Left Tilted	633334	1	137	DSI1	Ant3	1	100	17.00	16.20	0.00	0.000	1.000	1.202	0.00
	n77 (ENDC Only)	DFT-QPSK100M	Right Cheek	633334	135	69	DSI1	Ant3	1	100	17.00	16.34	-0.20	0.301	1.000	1.164	0.35
	n77 (ENDC Only)	DFT-QPSK100M	Right Tilted	633334	135	69	DSI1	Ant3	1	100	17.00	16.34	0.10	0.061	1.000	1.164	0.07
	n77 (ENDC Only)	DFT-QPSK100M	Left Cheek	633334	135	69	DSI1	Ant3	1	100	17.00	16.34	-0.01	0.151	1.000	1.164	0.18
	n77 (ENDC Only)	DFT-QPSK100M	Left Tilted	633334	135	69	DSI1	Ant3	1	100	17.00	16.34	0.00	0.000	1.000	1.164	0.00
	n77	DFT-QPSK100M	Right Cheek	662000	1	137	DSI1	Ant3	1	100	20.00	19.13	-0.17	0.745	1.000	1.222	0.91
	n77	DFT-QPSK100M	Right Tilted	662000	1	137	DSI1	Ant3	1	100	20.00	19.13	-0.08	0.163	1.000	1.222	0.20
	n77	DFT-QPSK100M	Left Cheek	662000	1	137	DSI1	Ant3	1	100	20.00	19.13	0.14	0.488	1.000	1.222	0.60
	n77	DFT-QPSK100M	Left Tilted	662000	1	137	DSI1	Ant3	1	100	20.00	19.13	0.11	0.105	1.000	1.222	0.13
	n77	DFT-QPSK100M	Right Cheek	662000	135	69	DSI1	Ant3	1	100	20.00	19.32	-0.03	0.828	1.000	1.169	0.97
	n77	DFT-QPSK100M	Right Tilted	662000	135	69	DSI1	Ant3	1	100	20.00	19.32	0.06	0.170	1.000	1.169	0.20
	n77	DFT-QPSK100M	Left Cheek	662000	135	69	DSI1	Ant3	1	100	20.00	19.32	-0.13	0.513	1.000	1.169	0.60
	n77	DFT-QPSK100M	Left Tilted	662000	135	69	DSI1	Ant3	1	100	20.00	19.32	-0.09	0.107	1.000	1.169	0.13



Certificate #6613.01

BUREAU VERITAS

FCC SAR Test Report

Plot No.	Band	Mode	Test Position	Ch.	RB#	RB Offset	Power State	Antenna	Sample	Duty Cycle %	Max. Tune-up Power (dBm)	Measured Conducted Power (dBm)	Power Drift (dB)	Measured SAR-1g (W/kg)	Duty Cycle Scaling Factor	Tune-up Scaling Factor	Scaled SAR-1g (W/kg)
	n77	DFT-QPSK100M	Right Cheek	650000	1	137	DS11	Ant3	1	100	20.00	19.09	-0.07	0.788	1.000	1.233	0.97
	n77	DFT-QPSK100M	Right Cheek	656000	1	137	DS11	Ant3	1	100	20.00	19.10	0.12	0.682	1.000	1.230	0.84
P24	n77	DFT-QPSK100M	Right Cheek	650000	135	69	DS11	Ant3	1	100	20.00	19.17	-0.09	0.879	1.000	1.211	1.06
	n77	DFT-QPSK100M	Right Cheek	656000	135	69	DS11	Ant3	1	100	20.00	19.28	-0.07	0.709	1.000	1.180	0.84
	n77	DFT-QPSK100M	Right Cheek	662000	270	0	DS11	Ant3	1	100	20.00	19.18	0.14	0.786	1.000	1.208	0.95
	n77 (ENDC Only)	DFT-QPSK100M	Right Cheek	662000	1	137	DS11	Ant3	1	100	17.00	16.12	0.07	0.276	1.000	1.225	0.34
	n77 (ENDC Only)	DFT-QPSK100M	Right Tilted	662000	1	137	DS11	Ant3	1	100	17.00	16.12	-0.15	0.062	1.000	1.225	0.08
	n77 (ENDC Only)	DFT-QPSK100M	Left Cheek	662000	1	137	DS11	Ant3	1	100	17.00	16.12	0.02	0.141	1.000	1.225	0.17
	n77 (ENDC Only)	DFT-QPSK100M	Left Tilted	662000	1	137	DS11	Ant3	1	100	17.00	16.12	-0.04	0.012	1.000	1.225	0.01
	n77 (ENDC Only)	DFT-QPSK100M	Right Cheek	662000	135	69	DS11	Ant3	1	100	17.00	16.28	0.00	0.267	1.000	1.180	0.32
	n77 (ENDC Only)	DFT-QPSK100M	Right Tilted	662000	135	69	DS11	Ant3	1	100	17.00	16.28	0.19	0.057	1.000	1.180	0.07
	n77 (ENDC Only)	DFT-QPSK100M	Left Cheek	662000	135	69	DS11	Ant3	1	100	17.00	16.28	-0.17	0.130	1.000	1.180	0.15
	n77 (ENDC Only)	DFT-QPSK100M	Left Tilted	662000	135	69	DS11	Ant3	1	100	17.00	16.28	0.01	0.051	1.000	1.180	0.06
	n77	DFT-QPSK100M	Right Cheek	633334	1	137	DS11	Ant5	1	100	16.00	14.74	0.08	0.409	1.000	1.337	0.55
	n77	DFT-QPSK100M	Right Tilted	633334	1	137	DS11	Ant5	1	100	16.00	14.74	0.01	0.498	1.000	1.337	0.67
	n77	DFT-QPSK100M	Left Cheek	633334	1	137	DS11	Ant5	1	100	16.00	14.74	0.14	0.537	1.000	1.337	0.72
	n77	DFT-QPSK100M	Left Tilted	633334	1	137	DS11	Ant5	1	100	16.00	14.74	0.13	0.678	1.000	1.337	0.91
	n77	DFT-QPSK100M	Right Cheek	633334	135	69	DS11	Ant5	1	100	16.00	14.91	0.13	0.393	1.000	1.285	0.51
	n77	DFT-QPSK100M	Right Tilted	633334	135	69	DS11	Ant5	1	100	16.00	14.91	0.10	0.475	1.000	1.285	0.61
	n77	DFT-QPSK100M	Left Cheek	633334	135	69	DS11	Ant5	1	100	16.00	14.91	0.13	0.546	1.000	1.285	0.70
	n77	DFT-QPSK100M	Left Tilted	633334	135	69	DS11	Ant5	1	100	16.00	14.91	-0.01	0.714	1.000	1.285	0.92
	n77	DFT-QPSK100M	Left Tilted	633334	270	0	DS11	Ant5	1	100	16.00	14.67	0.11	0.671	1.000	1.358	0.91
	n77 (ENDC Only)	DFT-QPSK100M	Right Cheek	633334	1	137	DS11	Ant5	1	100	14.00	12.91	0.02	0.339	1.000	1.285	0.44
	n77 (ENDC Only)	DFT-QPSK100M	Right Tilted	633334	1	137	DS11	Ant5	1	100	14.00	12.91	0.12	0.346	1.000	1.285	0.44
	n77 (ENDC Only)	DFT-QPSK100M	Left Cheek	633334	1	137	DS11	Ant5	1	100	14.00	12.91	0.14	0.308	1.000	1.285	0.40
	n77 (ENDC Only)	DFT-QPSK100M	Left Tilted	633334	1	137	DS11	Ant5	1	100	14.00	12.91	-0.15	0.376	1.000	1.285	0.48
	n77 (ENDC Only)	DFT-QPSK100M	Right Cheek	633334	135	69	DS11	Ant5	1	100	14.00	13.12	0.12	0.342	1.000	1.225	0.42
	n77 (ENDC Only)	DFT-QPSK100M	Right Tilted	633334	135	69	DS11	Ant5	1	100	14.00	13.12	-0.03	0.374	1.000	1.225	0.46
	n77 (ENDC Only)	DFT-QPSK100M	Left Cheek	633334	135	69	DS11	Ant5	1	100	14.00	13.12	-0.09	0.305	1.000	1.225	0.37
	n77 (ENDC Only)	DFT-QPSK100M	Left Tilted	633334	135	69	DS11	Ant5	1	100	14.00	13.12	0.16	0.414	1.000	1.225	0.51
	n77	DFT-QPSK100M	Right Cheek	662000	1	137	DS11	Ant5	1	100	16.00	14.81	-0.07	0.354	1.000	1.315	0.47
	n77	DFT-QPSK100M	Right Tilted	662000	1	137	DS11	Ant5	1	100	16.00	14.81	0.08	0.467	1.000	1.315	0.61
	n77	DFT-QPSK100M	Left Cheek	662000	1	137	DS11	Ant5	1	100	16.00	14.81	0.02	0.493	1.000	1.315	0.65
	n77	DFT-QPSK100M	Left Tilted	662000	1	137	DS11	Ant5	1	100	16.00	14.81	0.07	0.619	1.000	1.315	0.81
	n77	DFT-QPSK100M	Right Cheek	662000	135	69	DS11	Ant5	1	100	16.00	15.06	-0.18	0.368	1.000	1.242	0.46
	n77	DFT-QPSK100M	Right Tilted	662000	135	69	DS11	Ant5	1	100	16.00	15.06	0.05	0.494	1.000	1.242	0.61
	n77	DFT-QPSK100M	Left Cheek	662000	135	69	DS11	Ant5	1	100	16.00	15.06	-0.01	0.474	1.000	1.242	0.59
	n77	DFT-QPSK100M	Left Tilted	662000	135	69	DS11	Ant5	1	100	16.00	15.06	0.08	0.590	1.000	1.242	0.73
	n77 (ENDC Only)	DFT-QPSK100M	Right Cheek	662000	1	137	DS11	Ant5	1	100	14.00	13.13	0.07	0.204	1.000	1.222	0.25
	n77 (ENDC Only)	DFT-QPSK100M	Right Tilted	662000	1	137	DS11	Ant5	1	100	14.00	13.13	0.09	0.219	1.000	1.222	0.27
	n77 (ENDC Only)	DFT-QPSK100M	Left Cheek	662000	1	137	DS11	Ant5	1	100	14.00	13.13	-0.03	0.247	1.000	1.222	0.30
	n77 (ENDC Only)	DFT-QPSK100M	Left Tilted	662000	1	137	DS11	Ant5	1	100	14.00	13.13	0.12	0.306	1.000	1.222	0.37
	n77 (ENDC Only)	DFT-QPSK100M	Right Cheek	662000	135	69	DS11	Ant5	1	100	14.00	13.18	-0.05	0.215	1.000	1.208	0.26
	n77 (ENDC Only)	DFT-QPSK100M	Right Tilted	662000	135	69	DS11	Ant5	1	100	14.00	13.18	0.07	0.308	1.000	1.208	0.37
	n77 (ENDC Only)	DFT-QPSK100M	Left Cheek	662000	135	69	DS11	Ant5	1	100	14.00	13.18	-0.02	0.306	1.000	1.208	0.37
	n77 (ENDC Only)	DFT-QPSK100M	Left Tilted	662000	135	69	DS11	Ant5	1	100	14.00	13.18	0.09	0.309	1.000	1.208	0.37
	n77 PC2	DFT-QPSK100M	Right Cheek	633334	1	137	DS11	Ant5	1	50	17.50	16.55	-0.18	0.419	1.000	1.245	0.52
	n77 PC2	DFT-QPSK100M	Right Tilted	633334	1	137	DS11	Ant5	1	50	17.50	16.55	0.02	0.549	1.000	1.245	0.68
	n77 PC2	DFT-QPSK100M	Left Cheek	633334	1	137	DS11	Ant5	1	50	17.50	16.55	0.17	0.522	1.000	1.245	0.65
	n77 PC2	DFT-QPSK100M	Left Tilted	633334	1	137	DS11	Ant5	1	50	17.50	16.55	-0.18	0.630	1.000	1.245	0.78
	n77 PC2	DFT-QPSK100M	Right Cheek	633334	135	69	DS11	Ant5	1	50	17.50	16.95	0.12	0.422	1.000	1.135	0.48
	n77 PC2	DFT-QPSK100M	Right Tilted	633334	135	69	DS11	Ant5	1	50	17.50	16.95	0.05	0.543	1.000	1.135	0.62
	n77 PC2	DFT-QPSK100M	Left Cheek	633334	135	69	DS11	Ant5	1	50	17.50	16.95	-0.04	0.546	1.000	1.135	0.62



Certificate #6613.01

BUREAU VERITAS

FCC SAR Test Report

Plot No.	Band	Mode	Test Position	Ch.	RB#	RB Offset	Power State	Antenna	Sample	Duty Cycle %	Max. Tune-up Power (dBm)	Measured Conducted Power (dBm)	Power Drift (dB)	Measured SAR-1g (W/kg)	Duty Cycle Scaling Factor	Tune-up Scaling Factor	Scaled SAR-1g (W/kg)
	n77 PC2	DFT-QPSK100M	Left Tilted	633334	135	69	DSI1	Ant5	1	50	17.50	16.95	-0.16	0.694	1.000	1.135	0.79
	n77 PC2 (ENDC Only)	DFT-QPSK100M	Right Cheek	633334	1	137	DSI1	Ant5	1	50	15.50	14.71	-0.15	0.277	1.000	1.199	0.33
	n77 PC2 (ENDC Only)	DFT-QPSK100M	Right Tilted	633334	1	137	DSI1	Ant5	1	50	15.50	14.71	0.14	0.330	1.000	1.199	0.40
	n77 PC2 (ENDC Only)	DFT-QPSK100M	Left Cheek	633334	1	137	DSI1	Ant5	1	50	15.50	14.71	-0.03	0.295	1.000	1.199	0.35
	n77 PC2 (ENDC Only)	DFT-QPSK100M	Left Tilted	633334	1	137	DSI1	Ant5	1	50	15.50	14.71	-0.13	0.378	1.000	1.199	0.45
	n77 PC2 (ENDC Only)	DFT-QPSK100M	Right Cheek	633334	135	69	DSI1	Ant5	1	50	15.50	14.92	0.05	0.270	1.000	1.143	0.31
	n77 PC2 (ENDC Only)	DFT-QPSK100M	Right Tilted	633334	135	69	DSI1	Ant5	1	50	15.50	14.92	0.02	0.317	1.000	1.143	0.36
	n77 PC2 (ENDC Only)	DFT-QPSK100M	Left Cheek	633334	135	69	DSI1	Ant5	1	50	15.50	14.92	-0.19	0.316	1.000	1.143	0.36
	n77 PC2 (ENDC Only)	DFT-QPSK100M	Left Tilted	633334	135	69	DSI1	Ant5	1	50	15.50	14.92	-0.18	0.449	1.000	1.143	0.51
	n77 PC2	DFT-QPSK100M	Right Cheek	662000	1	137	DSI1	Ant5	1	50	17.50	16.83	0.12	0.324	1.000	1.167	0.38
	n77 PC2	DFT-QPSK100M	Right Tilted	662000	1	137	DSI1	Ant5	1	50	17.50	16.83	-0.05	0.434	1.000	1.167	0.51
	n77 PC2	DFT-QPSK100M	Left Cheek	662000	1	137	DSI1	Ant5	1	50	17.50	16.83	-0.16	0.427	1.000	1.167	0.50
	n77 PC2	DFT-QPSK100M	Left Tilted	662000	1	137	DSI1	Ant5	1	50	17.50	16.83	-0.03	0.536	1.000	1.167	0.63
	n77 PC2	DFT-QPSK100M	Right Cheek	662000	135	69	DSI1	Ant5	1	50	17.50	16.92	0.10	0.337	1.000	1.143	0.39
	n77 PC2	DFT-QPSK100M	Right Tilted	662000	135	69	DSI1	Ant5	1	50	17.50	16.92	0.07	0.439	1.000	1.143	0.50
	n77 PC2	DFT-QPSK100M	Left Cheek	662000	135	69	DSI1	Ant5	1	50	17.50	16.92	-0.04	0.410	1.000	1.143	0.47
	n77 PC2	DFT-QPSK100M	Left Tilted	662000	135	69	DSI1	Ant5	1	50	17.50	16.92	-0.02	0.530	1.000	1.143	0.61
	n77 PC2 (ENDC Only)	DFT-QPSK100M	Right Cheek	662000	1	137	DSI1	Ant5	1	50	15.50	14.77	-0.13	0.193	1.000	1.183	0.23
	n77 PC2 (ENDC Only)	DFT-QPSK100M	Right Tilted	662000	1	137	DSI1	Ant5	1	50	15.50	14.77	-0.04	0.248	1.000	1.183	0.29
	n77 PC2 (ENDC Only)	DFT-QPSK100M	Left Cheek	662000	1	137	DSI1	Ant5	1	50	15.50	14.77	0.19	0.283	1.000	1.183	0.33
	n77 PC2 (ENDC Only)	DFT-QPSK100M	Left Tilted	662000	1	137	DSI1	Ant5	1	50	15.50	14.77	-0.13	0.334	1.000	1.183	0.40
	n77 PC2 (ENDC Only)	DFT-QPSK100M	Right Cheek	662000	135	69	DSI1	Ant5	1	50	15.50	14.97	-0.02	0.212	1.000	1.130	0.24
	n77 PC2 (ENDC Only)	DFT-QPSK100M	Right Tilted	662000	135	69	DSI1	Ant5	1	50	15.50	14.97	0.01	0.271	1.000	1.130	0.31
	n77 PC2 (ENDC Only)	DFT-QPSK100M	Left Cheek	662000	135	69	DSI1	Ant5	1	50	15.50	14.97	0.19	0.272	1.000	1.130	0.31
	n77 PC2 (ENDC Only)	DFT-QPSK100M	Left Tilted	662000	135	69	DSI1	Ant5	1	50	15.50	14.97	0.20	0.330	1.000	1.130	0.37
	n77	DFT-QPSK100M	Right Cheek	633334	1	137	DSI1	Ant7	1	100	19.50	18.54	-0.12	0.058	1.000	1.247	0.07
	n77	DFT-QPSK100M	Right Tilted	633334	1	137	DSI1	Ant7	1	100	19.50	18.54	-0.15	0.060	1.000	1.247	0.07
	n77	DFT-QPSK100M	Left Cheek	633334	1	137	DSI1	Ant7	1	100	19.50	18.54	-0.08	0.320	1.000	1.247	0.40
	n77	DFT-QPSK100M	Left Tilted	633334	1	137	DSI1	Ant7	1	100	19.50	18.54	0.14	0.111	1.000	1.247	0.14
	n77	DFT-QPSK100M	Right Cheek	633334	135	69	DSI1	Ant7	1	100	19.50	18.63	0.16	0.057	1.000	1.222	0.07
	n77	DFT-QPSK100M	Right Tilted	633334	135	69	DSI1	Ant7	1	100	19.50	18.63	0.05	0.056	1.000	1.222	0.07
	n77	DFT-QPSK100M	Left Cheek	633334	135	69	DSI1	Ant7	1	100	19.50	18.63	0.08	0.376	1.000	1.222	0.46
	n77	DFT-QPSK100M	Left Tilted	633334	135	69	DSI1	Ant7	1	100	19.50	18.63	0.14	0.137	1.000	1.222	0.17
	n77 (ENDC Only)	DFT-QPSK100M	Right Cheek	633334	1	137	DSI1	Ant7	1	100	17.00	15.92	0.00	0.000	1.000	1.282	0.00
	n77 (ENDC Only)	DFT-QPSK100M	Right Tilted	633334	1	137	DSI1	Ant7	1	100	17.00	15.92	0.00	0.000	1.000	1.282	0.00
	n77 (ENDC Only)	DFT-QPSK100M	Left Cheek	633334	1	137	DSI1	Ant7	1	100	17.00	15.92	0.14	0.189	1.000	1.282	0.24
	n77 (ENDC Only)	DFT-QPSK100M	Left Tilted	633334	1	137	DSI1	Ant7	1	100	17.00	15.92	-0.15	0.073	1.000	1.282	0.09
	n77 (ENDC Only)	DFT-QPSK100M	Right Cheek	633334	135	69	DSI1	Ant7	1	100	17.00	16.12	0.00	0.000	1.000	1.225	0.00
	n77 (ENDC Only)	DFT-QPSK100M	Right Tilted	633334	135	69	DSI1	Ant7	1	100	17.00	16.12	0.00	0.000	1.000	1.225	0.00
	n77 (ENDC Only)	DFT-QPSK100M	Left Cheek	633334	135	69	DSI1	Ant7	1	100	17.00	16.12	0.14	0.219	1.000	1.225	0.27
	n77 (ENDC Only)	DFT-QPSK100M	Left Tilted	633334	135	69	DSI1	Ant7	1	100	17.00	16.12	-0.13	0.077	1.000	1.225	0.09
	n77	DFT-QPSK100M	Right Cheek	662000	1	137	DSI1	Ant7	1	100	19.50	18.61	0.08	0.124	1.000	1.227	0.15
	n77	DFT-QPSK100M	Right Tilted	662000	1	137	DSI1	Ant7	1	100	19.50	18.61	-0.05	0.119	1.000	1.227	0.15
	n77	DFT-QPSK100M	Left Cheek	662000	1	137	DSI1	Ant7	1	100	19.50	18.61	-0.04	0.773	1.000	1.227	0.95
	n77	DFT-QPSK100M	Left Tilted	662000	1	137	DSI1	Ant7	1	100	19.50	18.61	0.08	0.213	1.000	1.227	0.26
	n77	DFT-QPSK100M	Right Cheek	662000	135	69	DSI1	Ant7	1	100	19.50	18.78	0.18	0.130	1.000	1.180	0.15
	n77	DFT-QPSK100M	Right Tilted	662000	135	69	DSI1	Ant7	1	100	19.50	18.78	0.05	0.120	1.000	1.180	0.14
	n77	DFT-QPSK100M	Left Cheek	662000	135	69	DSI1	Ant7	1	100	19.50	18.78	0.13	0.671	1.000	1.180	0.79
	n77	DFT-QPSK100M	Left Tilted	662000	135	69	DSI1	Ant7	1	100	19.50	18.78	-0.04	0.212	1.000	1.180	0.25
	n77	DFT-QPSK100M	Left Cheek	650000	1	137	DSI1	Ant7	1	100	19.50	18.44	0.14	0.428	1.000	1.276	0.55
	n77	DFT-QPSK100M	Left Cheek	656000	1	137	DSI1	Ant7	1	100	19.50	18.57	-0.09	0.723	1.000	1.239	0.90
	n77	DFT-QPSK100M	Left Cheek	662000	270	0	DSI1	Ant7	1	100	19.50	18.65	0.07	0.615	1.000	1.216	0.75
	n77	DFT-QPSK100M	Right Cheek	662000	1	137	DSI1	Ant7	1	100	17.00	16.07	0.13	0.072	1.000	1.239	0.09



Certificate #6613.01

FCC SAR Test Report

Plot No.	Band	Mode	Test Position	Ch.	RB#	RB Offset	Power State	Antenna	Sample	Duty Cycle %	Max. Tune-up Power (dBm)	Measured Conducted Power (dBm)	Power Drift (dB)	Measured SAR-1g (W/kg)	Duty Cycle Scaling Factor	Tune-up Scaling Factor	Scaled SAR-1g (W/kg)
	(ENDC Only)																
	n77 (ENDC Only)	DFT-QPSK100M	Right Tilted	662000	1	137	DSI1	Ant7	1	100	17.00	16.07	0.19	0.070	1.000	1.239	0.09
	n77 (ENDC Only)	DFT-QPSK100M	Left Cheek	662000	1	137	DSI1	Ant7	1	100	17.00	16.07	0.02	0.346	1.000	1.239	0.43
	n77 (ENDC Only)	DFT-QPSK100M	Left Tilted	662000	1	137	DSI1	Ant7	1	100	17.00	16.07	-0.03	0.122	1.000	1.239	0.15
	n77 (ENDC Only)	DFT-QPSK100M	Right Cheek	662000	135	69	DSI1	Ant7	1	100	17.00	16.23	0.09	0.063	1.000	1.194	0.08
	n77 (ENDC Only)	DFT-QPSK100M	Right Tilted	662000	135	69	DSI1	Ant7	1	100	17.00	16.23	0.13	0.067	1.000	1.194	0.08
	n77 (ENDC Only)	DFT-QPSK100M	Left Cheek	662000	135	69	DSI1	Ant7	1	100	17.00	16.23	-0.04	0.313	1.000	1.194	0.37
	n77 (ENDC Only)	DFT-QPSK100M	Left Tilted	662000	135	69	DSI1	Ant7	1	100	17.00	16.23	-0.09	0.121	1.000	1.194	0.14
	WLAN2.4G	802.11b	Right Cheek	6	-	-	DSI1	Ant6	1	100	13.50	11.96	0.14	0.130	1.000	1.426	0.19
	WLAN2.4G	802.11b	Right Tilted	6	-	-	DSI1	Ant6	1	100	13.50	11.96	-0.19	0.172	1.000	1.426	0.25
P25	WLAN2.4G	802.11b	Left Cheek	6	-	-	DSI1	Ant6	1	100	13.50	11.96	-0.04	0.237	1.000	1.426	0.34
	WLAN2.4G	802.11b	Left Tilted	6	-	-	DSI1	Ant6	1	100	13.50	11.96	0.07	0.204	1.000	1.426	0.29
	WLAN5G	802.11n-HT20	Right Cheek	60	-	-	DSI1	Ant6	1	97.27	10.50	9.11	0.18	0.109	1.028	1.377	0.15
	WLAN5G	802.11n-HT20	Right Tilted	60	-	-	DSI1	Ant6	1	97.27	10.50	9.11	0.03	0.112	1.028	1.377	0.16
P26	WLAN5G	802.11n-HT20	Left Cheek	60	-	-	DSI1	Ant6	1	97.27	10.50	9.11	0.05	0.277	1.028	1.377	0.39
	WLAN5G	802.11n-HT20	Left Tilted	60	-	-	DSI1	Ant6	1	97.27	10.50	9.11	0.12	0.174	1.028	1.377	0.25
	WLAN5G	802.11n-HT20	Left Cheek	60	-	-	DSI1	Ant6	2	97.27	10.50	9.11	0.08	0.257	1.028	1.377	0.36
	WLAN5G	802.11n-HT20	Left Cheek	60	-	-	DSI1	Ant6	3	97.27	10.50	9.11	0.16	0.207	1.028	1.377	0.29
	WLAN5G	802.11n-HT20	Right Cheek	140	-	-	DSI1	Ant6	1	97.27	10.50	9.56	0.08	0.177	1.028	1.242	0.23
	WLAN5G	802.11n-HT20	Right Tilted	140	-	-	DSI1	Ant6	1	97.27	10.50	9.56	-0.15	0.202	1.028	1.242	0.26
	WLAN5G	802.11n-HT20	Left Cheek	140	-	-	DSI1	Ant6	1	97.27	10.50	9.56	0.03	0.221	1.028	1.242	0.28
P27	WLAN5G	802.11n-HT20	Left Tilted	140	-	-	DSI1	Ant6	1	97.27	10.50	9.56	0.06	0.263	1.028	1.242	0.34
	WLAN5G	802.11n-HT20	Right Cheek	149	-	-	DSI1	Ant6	1	97.3	10.50	9.12	-0.04	0.092	1.028	1.374	0.13
	WLAN5G	802.11n-HT20	Right Tilted	149	-	-	DSI1	Ant6	1	97.3	10.50	9.12	0.00	0.107	1.028	1.374	0.15
	WLAN5G	802.11n-HT20	Left Cheek	149	-	-	DSI1	Ant6	1	97.3	10.50	9.12	0.13	0.118	1.028	1.374	0.17
P28	WLAN5G	802.11n-HT20	Left Tilted	149	-	-	DSI1	Ant6	1	97.3	10.50	9.12	0.07	0.194	1.028	1.374	0.27
	BT	GFSK	Right Cheek	39	-	-	DSI1	Ant6	1	76.67	12.00	10.15	0.00	0.000	1.304	1.531	0.00
	BT	GFSK	Right Tilted	39	-	-	DSI1	Ant6	1	76.67	12.00	10.15	0.00	0.000	1.304	1.531	0.00
P29	BT	GFSK	Left Cheek	39	-	-	DSI1	Ant6	1	76.67	12.00	10.15	0.14	0.099	1.304	1.531	0.20
	BT	GFSK	Left Tilted	39	-	-	DSI1	Ant6	1	76.67	12.00	10.15	0.05	0.061	1.304	1.531	0.12

4.6.3 SAR Results for Body-worn Exposure Condition (Separation Distance is 1.0 cm Gap)

Plot No.	Band	Mode	Test Position	Separation Distance (cm)	Ch.	RB#	RB Offset	Power State	Antenna	Sample	Duty Cycle %	Max. Tune-up Power (dBm)	Measured Conducted Power (dBm)	Power Drift (dB)	Measured SAR-1g (W/kg)	Duty Cycle Scaling Factor	Tune-up Scaling Factor	Scaled SAR-1g (W/kg)
	GSM850	GPRS 2Tx Slot	Front Face	1	189	-	-	DSI3/4	Ant1	1	-	31.00	30.65	-0.02	0.198	1.000	1.084	0.21
P30	GSM850	GPRS 2Tx Slot	Rear Face	1	189	-	-	DSI3/4	Ant1	1	-	31.00	30.65	0.01	0.278	1.000	1.084	0.30
	GSM850	GPRS 2Tx Slot	Front Face	1	189	-	-	DSI4	Ant4	1	-	31.00	29.88	0.12	0.109	1.000	1.294	0.14
	GSM850	GPRS 2Tx Slot	Rear Face	1	189	-	-	DSI4	Ant4	1	-	31.00	29.88	-0.02	0.115	1.000	1.294	0.15
	GSM1900	GPRS 3Tx Slot	Front Face	1	810	-	-	DSI3/4	Ant1	1	-	25.00	24.32	0.19	0.363	1.000	1.169	0.42
P31	GSM1900	GPRS 3Tx Slot	Rear Face	1	810	-	-	DSI3/4	Ant1	1	-	25.00	24.32	-0.06	0.367	1.000	1.169	0.43
	GSM1900	GPRS 3Tx Slot	Front Face	2	810	-	-	DSI2	Ant1	1	-	26.50	25.93	-0.03	0.238	1.000	1.140	0.27
	GSM1900	GPRS 3Tx Slot	Rear Face	2	810	-	-	DSI2	Ant1	1	-	26.50	25.93	-0.17	0.278	1.000	1.140	0.32
	GSM1900	GPRS 3Tx Slot	Front Face	1	810	-	-	DSI4	Ant4	1	-	25.00	23.91	-0.14	0.266	1.000	1.285	0.34
	GSM1900	GPRS 3Tx Slot	Rear Face	1	810	-	-	DSI4	Ant4	1	-	25.00	23.91	0.01	0.315	1.000	1.285	0.40
	GSM1900	GPRS 3Tx Slot	Front Face	2	810	-	-	DSI2	Ant4	1	-	26.00	24.76	-0.03	0.143	1.000	1.330	0.19
	GSM1900	GPRS 3Tx Slot	Rear Face	2	810	-	-	DSI2	Ant4	1	-	26.00	24.76	-0.02	0.247	1.000	1.330	0.33
	WCDMA II	RMC12.2K	Front Face	1	9400	-	-	DSI3/4	Ant1	1	-	20.00	19.17	-0.18	0.298	1.000	1.211	0.36
	WCDMA II	RMC12.2K	Rear Face	1	9400	-	-	DSI3/4	Ant1	1	-	20.00	19.17	0.06	0.321	1.000	1.211	0.39
	WCDMA II	RMC12.2K	Front Face	2	9400	-	-	DSI2	Ant1	1	-	25.00	24.04	-0.12	0.218	1.000	1.247	0.27
	WCDMA II	RMC12.2K	Rear Face	2	9400	-	-	DSI2	Ant1	1	-	25.00	24.04	-0.03	0.259	1.000	1.247	0.32
	WCDMA II	RMC12.2K	Front Face	1	9400	-	-	DSI4	Ant4	1	-	20.50	19.20	-0.14	0.386	1.000	1.349	0.52
P32	WCDMA II	RMC12.2K	Rear Face	1	9400	-	-	DSI4	Ant4	1	-	20.50	19.20	-0.06	0.652	1.000	1.349	0.88
	WCDMA II	RMC12.2K	Front Face	2	9400	-	-	DSI2	Ant4	1	-	24.50	23.13	-0.10	0.199	1.000	1.371	0.27
	WCDMA II	RMC12.2K	Rear Face	2	9400	-	-	DSI2	Ant4	1	-	24.50	23.13	-0.13	0.338	1.000	1.371	0.46
	WCDMA II	RMC12.2K	Rear Face	1	9262	-	-	DSI4	Ant4	1	-	20.50	19.17	-0.16	0.588	1.000	1.358	0.80
	WCDMA II	RMC12.2K	Rear Face	1	9538	-	-	DSI4	Ant4	1	-	20.50	19.18	0.17	0.512	1.000	1.355	0.69
	WCDMA IV	RMC12.2K	Front Face	1	1413	-	-	DSI3/4	Ant1	1	-	20.00	19.06	0.18	0.320	1.000	1.242	0.40
	WCDMA IV	RMC12.2K	Rear Face	1	1413	-	-	DSI3/4	Ant1	1	-	20.00	19.06	0.17	0.399	1.000	1.242	0.50
	WCDMA IV	RMC12.2K	Front Face	2	1413	-	-	DSI2	Ant1	1	-	25.00	24.04	0.06	0.227	1.000	1.247	0.28
	WCDMA IV	RMC12.2K	Rear Face	2	1413	-	-	DSI2	Ant1	1	-	25.00	24.04	-0.05	0.282	1.000	1.247	0.35
	WCDMA IV	RMC12.2K	Front Face	1	1413	-	-	DSI4	Ant4	1	-	22.50	21.52	0.11	0.325	1.000	1.253	0.41
P33	WCDMA IV	RMC12.2K	Rear Face	1	1413	-	-	DSI4	Ant4	1	-	22.50	21.52	-0.09	0.530	1.000	1.253	0.66



BUREAU VERITAS

FCC SAR Test Report



Certificate #6613.01

Plot No.	Band	Mode	Test Position	Separation Distance (cm)	Ch.	RB#	RB Offset	Power State	Antenna	Sample	Duty Cycle %	Max. Tune-up Power (dBm)	Measured Conducted Power (dBm)	Power Drift (dB)	Measured SAR-1g (W/kg)	Duty Cycle Scaling Factor	Tune-up Scaling Factor	Scaled SAR-1g (W/kg)
	WCDMA IV	RMC12.2K	Front Face	2	1413	-	-	DSI2	Ant4	1	-	24.50	23.33	-0.08	0.240	1.000	1.309	0.31
	WCDMA IV	RMC12.2K	Rear Face	2	1413	-	-	DSI2	Ant4	1	-	24.50	23.33	0.03	0.355	1.000	1.309	0.46
	WCDMA V	RMC12.2K	Front Face	1	4233	-	-	DSI3/4	Ant1	1	-	25.00	23.82	-0.02	0.204	1.000	1.312	0.27
P34	WCDMA V	RMC12.2K	Rear Face	1	4233	-	-	DSI3/4	Ant1	1	-	25.00	23.82	0.04	0.274	1.000	1.312	0.36
	WCDMA V	RMC12.2K	Front Face	1	4233	-	-	DSI4	Ant4	1	-	25.00	23.32	-0.14	0.139	1.000	1.472	0.20
	WCDMA V	RMC12.2K	Rear Face	1	4233	-	-	DSI4	Ant4	1	-	25.00	23.32	0.01	0.206	1.000	1.472	0.30
	LTE 2	QPSK20M	Front Face	1	18900	1	50	DSI3/4	Ant1	1	-	19.50	18.96	0.12	0.285	1.000	1.132	0.32
	LTE 2	QPSK20M	Rear Face	1	18900	1	50	DSI3/4	Ant1	1	-	19.50	18.96	0.07	0.306	1.000	1.132	0.35
	LTE 2	QPSK20M	Front Face	1	18900	50	25	DSI3/4	Ant1	1	-	19.50	18.85	-0.19	0.301	1.000	1.161	0.35
	LTE 2	QPSK20M	Rear Face	1	18900	50	25	DSI3/4	Ant1	1	-	19.50	18.85	-0.13	0.307	1.000	1.161	0.36
	LTE 2	QPSK20M	Front Face	2	18900	1	50	DSI2	Ant1	1	-	25.00	24.30	0.15	0.222	1.000	1.175	0.26
	LTE 2	QPSK20M	Rear Face	2	18900	1	50	DSI2	Ant1	1	-	25.00	24.30	0.09	0.271	1.000	1.175	0.32
	LTE 2	QPSK20M	Front Face	2	18900	50	25	DSI2	Ant1	1	-	24.00	23.33	0.11	0.183	1.000	1.167	0.21
	LTE 2	QPSK20M	Rear Face	2	18900	50	25	DSI2	Ant1	1	-	24.00	23.33	0.18	0.216	1.000	1.167	0.25
	LTE 2	QPSK20M	Front Face	1	18900	1	50	DSI4	Ant4	1	-	18.50	17.28	0.12	0.279	1.000	1.324	0.37
	LTE 2	QPSK20M	Rear Face	1	18900	1	50	DSI4	Ant4	1	-	18.50	17.28	0.07	0.433	1.000	1.324	0.57
	LTE 2	QPSK20M	Front Face	1	18900	50	0	DSI4	Ant4	1	-	18.50	17.18	0.14	0.268	1.000	1.355	0.36
P35	LTE 2	QPSK20M	Rear Face	1	18900	50	0	DSI4	Ant4	1	-	18.50	17.18	0.12	0.443	1.000	1.355	0.60
	LTE 2	QPSK20M	Front Face	2	18900	1	50	DSI2	Ant4	1	-	24.50	23.16	0.04	0.248	1.000	1.361	0.34
	LTE 2	QPSK20M	Rear Face	2	18900	1	50	DSI2	Ant4	1	-	24.50	23.16	0.18	0.408	1.000	1.361	0.56
	LTE 2	QPSK20M	Front Face	2	18900	50	0	DSI2	Ant4	1	-	23.50	22.19	0.02	0.195	1.000	1.352	0.26
	LTE 2	QPSK20M	Rear Face	2	18900	50	0	DSI2	Ant4	1	-	23.50	22.19	-0.18	0.334	1.000	1.352	0.45
	LTE 2	QPSK20M	Front Face	1	18700	1	50	DSI4	Ant3	1	-	18.00	17.04	0.12	0.064	1.000	1.247	0.08
	LTE 2	QPSK20M	Rear Face	1	18700	1	50	DSI4	Ant3	1	-	18.00	17.04	0.07	0.079	1.000	1.247	0.10
	LTE 2	QPSK20M	Front Face	1	18700	50	25	DSI4	Ant3	1	-	18.00	16.78	-0.07	0.051	1.000	1.324	0.07
	LTE 2	QPSK20M	Rear Face	1	18700	50	25	DSI4	Ant3	1	-	18.00	16.78	0.16	0.077	1.000	1.324	0.10
	LTE 2	QPSK20M	Front Face	2	18700	1	50	DSI2	Ant3	1	-	25.00	23.86	0.03	0.067	1.000	1.300	0.09
	LTE 2	QPSK20M	Rear Face	2	18700	1	50	DSI2	Ant3	1	-	25.00	23.86	-0.01	0.078	1.000	1.300	0.10
	LTE 2	QPSK20M	Front Face	2	18700	50	25	DSI2	Ant3	1	-	24.00	22.87	-0.08	0.055	1.000	1.297	0.07
	LTE 2	QPSK20M	Rear Face	2	18700	50	25	DSI2	Ant3	1	-	24.00	22.87	0.19	0.065	1.000	1.297	0.08
	LTE 7	QPSK20M	Front Face	1	21100	1	50	DSI3/4	Ant1	1	-	23.50	22.65	0.09	0.426	1.000	1.216	0.52
	LTE 7	QPSK20M	Rear Face	1	21100	1	50	DSI3/4	Ant1	1	-	23.50	22.65	0.04	0.439	1.000	1.216	0.53
P36	LTE 7	QPSK20M	Front Face	1	21100	50	25	DSI3/4	Ant1	1	-	23.50	22.54	-0.04	0.466	1.000	1.247	0.58
	LTE 7	QPSK20M	Rear Face	1	21100	50	25	DSI3/4	Ant1	1	-	23.50	22.54	-0.07	0.432	1.000	1.247	0.54
	LTE 7	QPSK20M	Front Face	2	21100	1	50	DSI2	Ant1	1	-	25.00	24.01	0.11	0.230	1.000	1.256	0.29
	LTE 7	QPSK20M	Rear Face	2	21100	1	50	DSI2	Ant1	1	-	25.00	24.01	-0.06	0.244	1.000	1.256	0.31
	LTE 7	QPSK20M	Front Face	2	21100	50	25	DSI2	Ant1	1	-	24.00	23.05	0.08	0.176	1.000	1.245	0.22
	LTE 7	QPSK20M	Rear Face	2	21100	50	25	DSI2	Ant1	1	-	24.00	23.05	-0.12	0.191	1.000	1.245	0.24
	LTE 7C	QPSK20M	Front Face	1	PCC:21001 SCC:21199	PCC:1 SCC:1	PCC:99 SCC:0	DSI3/4	Ant1	1	-	23.50	22.89	0.13	0.401	1.000	1.151	0.46
	LTE 7	QPSK20M	Front Face	1	20850	1	50	DSI4	Ant4	1	-	19.00	17.99	-0.08	0.236	1.000	1.262	0.30
	LTE 7	QPSK20M	Rear Face	1	20850	1	50	DSI4	Ant4	1	-	19.00	17.99	0.02	0.409	1.000	1.262	0.52
	LTE 7	QPSK20M	Front Face	1	20850	50	25	DSI4	Ant4	1	-	19.00	17.80	-0.03	0.202	1.000	1.318	0.27
	LTE 7	QPSK20M	Rear Face	1	20850	50	25	DSI4	Ant4	1	-	19.00	17.80	-0.10	0.417	1.000	1.318	0.55
	LTE 7	QPSK20M	Front Face	2	20850	1	50	DSI2	Ant4	1	-	24.50	23.01	0.06	0.218	1.000	1.409	0.31
	LTE 7	QPSK20M	Rear Face	2	20850	1	50	DSI2	Ant4	1	-	24.50	23.01	0.16	0.351	1.000	1.409	0.49
	LTE 7	QPSK20M	Front Face	2	20850	50	25	DSI2	Ant4	1	-	23.50	21.98	0.08	0.159	1.000	1.419	0.23
	LTE 7	QPSK20M	Rear Face	2	20850	50	25	DSI2	Ant4	1	-	23.50	21.98	-0.07	0.283	1.000	1.419	0.40
	LTE 7C	QPSK20M	Rear Face	1	PCC:21001 SCC:21199	PCC:1 SCC:1	PCC:99 SCC:0	DSI4	Ant4	1	-	19.00	17.97	-0.11	0.387	1.000	1.268	0.49
	LTE 7	QPSK20M	Front Face	1	20850	1	50	DSI4	Ant3	1	-	16.00	14.61	-0.02	0.070	1.000	1.377	0.10
	LTE 7	QPSK20M	Rear Face	1	20850	1	50	DSI4	Ant3	1	-	16.00	14.61	-0.05	0.106	1.000	1.377	0.15
	LTE 7	QPSK20M	Front Face	1	20850	50	25	DSI4	Ant3	1	-	16.00	14.41	-0.07	0.076	1.000	1.442	0.11
	LTE 7	QPSK20M	Rear Face	1	20850	50	25	DSI4	Ant3	1	-	16.00	14.41	0.01	0.110	1.000	1.442	0.16
	LTE 7	QPSK20M	Front Face	2	20850	1	50	DSI2	Ant3	1	-	25.00	23.63	0.14	0.160	1.000	1.371	0.22
	LTE 7	QPSK20M	Rear Face	2	20850	1	50	DSI2	Ant3	1	-	25.00	23.63	-0.01	0.218	1.000	1.371	0.30
	LTE 7	QPSK20M	Front Face	2	20850	50	25	DSI2	Ant3	1	-	24.00	22.55	-0.02	0.128	1.000	1.396	0.18
	LTE 7	QPSK20M	Rear Face	2	20850	50	25	DSI2	Ant3	1	-	24.00	22.55	0.09	0.168	1.000	1.396	0.23
	LTE 12	QPSK10M	Front Face	1	23060	1	0	DSI3/4	Ant1	1	-	25.50	24.51	-0.14	0.203	1.000	1.256	0.25
P37	LTE 12	QPSK10M	Rear Face	1	23060	1	0	DSI3/4	Ant1	1	-	25.50	24.51	0.01	0.237	1.000	1.256	0.30
	LTE 12	QPSK10M	Front Face	1	23060	25	0	DSI3/4	Ant1	1	-	24.50	23.54	0.06	0.172	1.000	1.247	0.21
	LTE 12	QPSK10M	Rear Face	1	23060	25	0	DSI3/4	Ant1	1	-	24.50	23.54	-0.07	0.191	1.000	1.247	0.24
	LTE 12	QPSK10M	Front Face	1	23060	1	0	DSI4	Ant4	1	-	25.00	24.28	0.09	0.109	1.000	1.180	0.13
	LTE 12	QPSK10M	Rear Face	1	23060	1	0	DSI4	Ant4	1	-	25.00	24.28	0.05	0.149	1.000	1.180	0.18
	LTE 12	QPSK10M	Front Face	1	23060	25	0	DSI4	Ant4	1	-	24.00	23.26	-0.10	0.089	1.000	1.186	0.11
	LTE 12	QPSK10M	Rear Face	1	23060	25	0	DSI4	Ant4	1	-	24.00	23.26	0.10	0.117	1.000	1.186	0.14
	LTE 13	QPSK10M	Front Face	1	23230	1	49	DSI3/4	Ant1	1	-	25.50	24.53	0.07	0.155	1.000	1.250	0.19
P38	LTE 13	QPSK10M	Rear Face	1	23230	1	49	DSI3/4	Ant1	1	-	25.50	24.53	0.05	0.203	1.000	1.250	0.25
	LTE 13	QPSK10M	Front Face	1	23230	25	12	DSI3/4	Ant1	1	-	24.50	23.50	-0.07	0.123	1.000	1.259	0.15
	LTE 13	QPSK10M	Rear Face	1	23230	25	12	DSI3/4	Ant1	1	-	24.50	23.50	0.14	0.171	1.000	1.259	0.22
	LTE 13	QPSK10M	Front Face	1	23230	1	49	DSI4	Ant4	1	-	25.00	24.13	-0.02	0.084	1.000	1.222	0.10
	LTE 13	QPSK10M	Rear Face	1	23230	1	49	DSI4	Ant4	1	-	25.00	24.13	0.09	0.127	1.000	1.222	0.16
	LTE 13	QPSK10M	Front Face	1	23230	25	12	DSI4	Ant4	1	-	24.00	23.02	-0.15	0.084	1.000	1.253	0.11
	LTE 13	QPSK10M	Rear Face	1	23230	25	12	DSI4	Ant4	1	-	24.00	23.02	-0.13	0.101	1.000	1.253	0.13
	LTE 26	QPSK15M	Front Face	1	26865	1	37	DSI3/4	Ant1	1	-	25.50	24.67	-0.14	0.205	1.000	1.211	0.25



BUREAU VERITAS

FCC SAR Test Report



Certificate #6613.01

Plot No.	Band	Mode	Test Position	Separation Distance (cm)	Ch.	RB#	RB Offset	Power State	Antenna	Sample	Duty Cycle %	Max. Tune-up Power (dBm)	Measured Conducted Power (dBm)	Power Drift (dB)	Measured SAR-1g (W/kg)	Duty Cycle Scaling Factor	Tune-up Scaling Factor	Scaled SAR-1g (W/kg)
P39	LTE 26	QPSK15M	Rear Face	1	26865	1	37	DSI3/4	Ant1	1	-	25.50	24.67	0.06	0.336	1.000	1.211	0.41
	LTE 26	QPSK15M	Front Face	1	26865	36	0	DSI3/4	Ant1	1	-	24.50	23.61	0.10	0.157	1.000	1.227	0.19
	LTE 26	QPSK15M	Rear Face	1	26865	36	0	DSI3/4	Ant1	1	-	24.50	23.61	-0.16	0.225	1.000	1.227	0.28
	LTE 26	QPSK15M	Front Face	1	26865	1	0	DSI4	Ant4	1	-	25.00	24.01	-0.03	0.174	1.000	1.256	0.22
	LTE 26	QPSK15M	Rear Face	1	26865	1	0	DSI4	Ant4	1	-	25.00	24.01	-0.01	0.237	1.000	1.256	0.30
	LTE 26	QPSK15M	Front Face	1	26865	36	0	DSI4	Ant4	1	-	24.00	22.96	-0.09	0.134	1.000	1.271	0.17
	LTE 26	QPSK15M	Rear Face	1	26865	36	0	DSI4	Ant4	1	-	24.00	22.96	0.18	0.163	1.000	1.271	0.21
	LTE 38	QPSK20M	Front Face	1	38000	1	50	DSI3/4	Ant1	1	62.9	24.50	23.18	-0.05	0.321	1.006	1.355	0.44
	LTE 38	QPSK20M	Rear Face	1	38000	1	50	DSI3/4	Ant1	1	62.9	24.50	23.18	-0.17	0.301	1.006	1.355	0.41
	LTE 38	QPSK20M	Front Face	1	38000	50	0	DSI3/4	Ant1	1	62.9	24.50	23.04	-0.07	0.314	1.006	1.400	0.44
	LTE 38	QPSK20M	Rear Face	1	38000	50	0	DSI3/4	Ant1	1	62.9	24.50	23.04	0.01	0.311	1.006	1.400	0.44
	LTE 38	QPSK20M	Front Face	2	38000	1	50	DSI2	Ant1	1	62.9	25.50	23.99	0.16	0.128	1.006	1.416	0.18
LTE 38	QPSK20M	Rear Face	2	38000	1	50	DSI2	Ant1	1	62.9	25.50	23.99	0.17	0.154	1.006	1.416	0.22	
LTE 38	QPSK20M	Front Face	2	38000	50	0	DSI2	Ant1	1	62.9	24.50	22.98	-0.18	0.105	1.006	1.419	0.15	
LTE 38	QPSK20M	Rear Face	2	38000	50	0	DSI2	Ant1	1	62.9	24.50	22.98	-0.14	0.122	1.006	1.419	0.17	
LTE 38C	QPSK20M	Front Face	1	PCC:37901 SCC:38099	PCC:1 SCC:1	PCC:99 SCC:0	DSI3/4	Ant1	1	62.9	24.50	22.71	-0.09	0.282	1.006	1.510	0.43	
LTE 38	QPSK20M	Front Face	1	38000	1	0	DSI4	Ant4	1	62.9	21.50	20.25	-0.15	0.187	1.006	1.334	0.25	
LTE 38	QPSK20M	Rear Face	1	38000	1	0	DSI4	Ant4	1	62.9	21.50	20.25	-0.05	0.337	1.006	1.334	0.45	
LTE 38	QPSK20M	Front Face	1	38000	50	0	DSI4	Ant4	1	62.9	21.50	20.21	0.08	0.191	1.006	1.346	0.26	
P40	LTE 38	QPSK20M	Rear Face	1	38000	50	0	DSI4	Ant4	1	62.9	21.50	20.21	-0.08	0.424	1.006	1.346	0.57
	LTE 38	QPSK20M	Front Face	2	38000	1	0	DSI2	Ant4	1	62.9	25.00	23.34	-0.18	0.119	1.006	1.466	0.18
	LTE 38	QPSK20M	Rear Face	2	38000	1	0	DSI2	Ant4	1	62.9	25.00	23.34	-0.17	0.207	1.006	1.466	0.31
	LTE 38	QPSK20M	Front Face	2	38000	50	0	DSI2	Ant4	1	62.9	24.00	22.41	-0.09	0.099	1.006	1.442	0.14
	LTE 38	QPSK20M	Rear Face	2	38000	50	0	DSI2	Ant4	1	62.9	24.00	22.41	-0.04	0.146	1.006	1.442	0.21
	LTE 38C	QPSK20M	Rear Face	1	PCC:37901 SCC:38099	PCC:1 SCC:1	PCC:99 SCC:0	DSI4	Ant4	1	62.9	21.50	19.85	0.17	0.374	1.006	1.462	0.55
	LTE 38	QPSK20M	Front Face	1	38000	1	0	DSI4	Ant3	1	-	20.00	18.52	0.19	0.115	1.000	1.406	0.16
	LTE 38	QPSK20M	Rear Face	1	38000	1	0	DSI4	Ant3	1	-	20.00	18.52	-0.13	0.158	1.000	1.406	0.22
	LTE 38	QPSK20M	Front Face	1	38000	50	0	DSI4	Ant3	1	-	20.00	18.58	-0.01	0.126	1.000	1.387	0.17
	LTE 38	QPSK20M	Rear Face	1	38000	50	0	DSI4	Ant3	1	-	20.00	18.58	-0.14	0.162	1.000	1.387	0.22
	LTE 38	QPSK20M	Front Face	2	38000	1	0	DSI2	Ant3	1	-	25.00	23.59	0.18	0.088	1.000	1.384	0.12
	LTE 38	QPSK20M	Rear Face	2	38000	1	0	DSI2	Ant3	1	-	25.00	23.59	-0.14	0.124	1.000	1.384	0.17
LTE 38	QPSK20M	Front Face	2	38000	50	0	DSI2	Ant3	1	-	24.00	22.46	0.06	0.070	1.000	1.426	0.10	
LTE 38	QPSK20M	Rear Face	2	38000	50	0	DSI2	Ant3	1	-	24.00	22.46	-0.10	0.098	1.000	1.426	0.14	
LTE 41	QPSK20M	Front Face	1	39750	1	0	DSI3/4	Ant1	1	62.9	24.50	23.21	0.04	0.311	1.006	1.346	0.42	
LTE 41	QPSK20M	Rear Face	1	39750	1	0	DSI3/4	Ant1	1	62.9	24.50	23.21	-0.06	0.291	1.006	1.346	0.39	
LTE 41	QPSK20M	Front Face	1	39750	50	0	DSI3/4	Ant1	1	62.9	24.50	23.15	0.12	0.315	1.006	1.365	0.43	
LTE 41	QPSK20M	Rear Face	1	39750	50	0	DSI3/4	Ant1	1	62.9	24.50	23.15	0.12	0.288	1.006	1.365	0.40	
LTE 41	QPSK20M	Front Face	2	39750	1	0	DSI2	Ant1	1	62.9	25.50	24.02	0.11	0.122	1.006	1.406	0.17	
LTE 41	QPSK20M	Rear Face	2	39750	1	0	DSI2	Ant1	1	62.9	25.50	24.02	0.00	0.126	1.006	1.406	0.18	
LTE 41	QPSK20M	Front Face	2	39750	50	0	DSI2	Ant1	1	62.9	24.50	23.14	-0.11	0.097	1.006	1.368	0.13	
LTE 41	QPSK20M	Rear Face	2	39750	50	0	DSI2	Ant1	1	62.9	24.50	23.14	-0.07	0.102	1.006	1.368	0.14	
LTE 41	QPSK20M	Front Face	1	39750	1	50	DSI4	Ant3	1	62.9	17.50	16.16	-0.07	0.127	1.006	1.361	0.17	
LTE 41	QPSK20M	Rear Face	1	39750	1	50	DSI4	Ant3	1	62.9	17.50	16.16	0.14	0.147	1.006	1.361	0.20	
LTE 41	QPSK20M	Front Face	1	39750	50	25	DSI4	Ant3	1	62.9	17.50	16.05	0.01	0.125	1.006	1.396	0.18	
LTE 41	QPSK20M	Rear Face	1	39750	50	25	DSI4	Ant3	1	62.9	17.50	16.05	0.13	0.183	1.006	1.396	0.26	
LTE 41	QPSK20M	Front Face	2	39750	1	50	DSI2	Ant3	1	62.9	22.00	20.31	0.00	0.060	1.006	1.476	0.09	
LTE 41	QPSK20M	Rear Face	2	39750	1	50	DSI2	Ant3	1	62.9	22.00	20.31	0.17	0.063	1.006	1.476	0.09	
LTE 41	QPSK20M	Front Face	2	39750	50	25	DSI2	Ant3	1	62.9	21.00	19.38	0.05	0.064	1.006	1.452	0.09	
LTE 41	QPSK20M	Rear Face	2	39750	50	25	DSI2	Ant3	1	62.9	21.00	19.38	-0.16	0.057	1.006	1.452	0.08	
LTE 41 (ENDC Only)	QPSK20M	Front Face	1	39750	1	50	DSI4	Ant3	1	62.9	17.50	16.16	-0.15	0.064	1.006	1.361	0.09	
LTE 41 (ENDC Only)	QPSK20M	Rear Face	1	39750	1	50	DSI4	Ant3	1	62.9	17.50	16.16	0.06	0.102	1.006	1.361	0.14	
LTE 41 (ENDC Only)	QPSK20M	Front Face	1	39750	50	25	DSI4	Ant3	1	62.9	17.50	16.05	-0.17	0.067	1.006	1.396	0.09	
LTE 41 (ENDC Only)	QPSK20M	Rear Face	1	39750	50	25	DSI4	Ant3	1	62.9	17.50	16.05	0.02	0.095	1.006	1.396	0.13	
LTE 41	QPSK20M	Front Face	1	39750	1	0	DSI4	Ant4	1	62.9	22.00	20.59	-0.15	0.170	1.006	1.384	0.24	
LTE 41	QPSK20M	Rear Face	1	39750	1	0	DSI4	Ant4	1	62.9	22.00	20.59	-0.09	0.362	1.006	1.384	0.50	
LTE 41	QPSK20M	Front Face	1	39750	50	0	DSI4	Ant4	1	62.9	22.00	20.46	-0.19	0.186	1.006	1.426	0.27	
P41	LTE 41	QPSK20M	Rear Face	1	39750	50	0	DSI4	Ant4	1	62.9	22.00	20.46	0.09	0.383	1.006	1.426	0.55
	LTE 41	QPSK20M	Front Face	2	39750	1	0	DSI2	Ant4	1	62.9	25.00	23.49	-0.04	0.106	1.006	1.416	0.15
	LTE 41	QPSK20M	Rear Face	2	39750	1	0	DSI2	Ant4	1	62.9	25.00	23.49	-0.12	0.156	1.006	1.416	0.22
	LTE 41	QPSK20M	Front Face	2	39750	50	0	DSI2	Ant4	1	62.9	24.00	22.45	-0.18	0.089	1.006	1.429	0.13
	LTE 41	QPSK20M	Rear Face	2	39750	50	0	DSI2	Ant4	1	62.9	24.00	22.45	0.02	0.134	1.006	1.429	0.19
	LTE 41	QPSK20M	Front Face	1	39750	1	50	DSI2	Ant7	1	62.9	21.00	19.41	0.09	0.117	1.006	1.442	0.17
	LTE 41	QPSK20M	Rear Face	1	39750	1	50	DSI2	Ant7	1	62.9	21.00	19.41	0.10	0.213	1.006	1.442	0.31
	LTE 41	QPSK20M	Front Face	1	39750	50	25	DSI2	Ant7	1	62.9	20.00	18.41	0.15	0.097	1.006	1.442	0.14
	LTE 41	QPSK20M	Rear Face	1	39750	50	25	DSI2	Ant7	1	62.9	20.00	18.41	0.17	0.173	1.006	1.442	0.25
	LTE 42	QPSK20M	Front Face	1	42190	1	50	DSI4	Ant2	1	62.9	22.00	20.98	-0.06	0.202	1.006	1.265	0.26
	LTE 42	QPSK20M	Rear Face	1	42													



BUREAU VERITAS

FCC SAR Test Report



Certificate #6613.01

Plot No.	Band	Mode	Test Position	Separation Distance (cm)	Ch.	RB#	RB Offset	Power State	Antenna	Sample	Duty Cycle %	Max. Tune-up Power (dBm)	Measured Conducted Power (dBm)	Power Drift (dB)	Measured SAR-1g (W/kg)	Duty Cycle Scaling Factor	Tune-up Scaling Factor	Scaled SAR-1g (W/kg)
	LTE 42	QPSK20M	Rear Face	1	42990	1	50	DSI4	Ant3	1	62.9	20.00	18.55	-0.18	0.279	1.006	1.396	0.39
	LTE 42	QPSK20M	Front Face	1	42990	50	25	DSI4	Ant3	1	62.9	19.00	17.48	-0.12	0.142	1.006	1.419	0.20
	LTE 42	QPSK20M	Rear Face	1	42990	50	25	DSI4	Ant3	1	62.9	19.00	17.48	0.12	0.218	1.006	1.419	0.31
	LTE 42	QPSK20M	Front Face	2	42990	1	50	DSI4	Ant3	1	62.9	20.00	18.55	-0.04	0.060	1.006	1.396	0.08
	LTE 42	QPSK20M	Rear Face	2	42990	1	50	DSI4	Ant3	1	62.9	20.00	18.55	0.18	0.099	1.006	1.396	0.14
	LTE 42	QPSK20M	Front Face	2	42990	50	25	DSI4	Ant3	1	62.9	19.00	17.48	0.12	0.048	1.006	1.419	0.07
	LTE 42	QPSK20M	Rear Face	2	42990	50	25	DSI4	Ant3	1	62.9	19.00	17.48	0.13	0.079	1.006	1.419	0.11
	LTE 42 (ENDC Only)	QPSK20M	Front Face	1	42990	1	50	DSI4	Ant3	1	62.9	16.50	15.44	0.03	0.082	1.006	1.276	0.11
	LTE 42 (ENDC Only)	QPSK20M	Rear Face	1	42990	1	50	DSI4	Ant3	1	62.9	16.50	15.44	0.17	0.034	1.006	1.276	0.04
	LTE 42 (ENDC Only)	QPSK20M	Front Face	1	42990	50	25	DSI4	Ant3	1	62.9	16.50	15.21	-0.19	0.085	1.006	1.346	0.12
	LTE 42 (ENDC Only)	QPSK20M	Rear Face	1	42990	50	25	DSI4	Ant3	1	62.9	16.50	15.21	-0.07	0.132	1.006	1.346	0.18
	LTE 42	QPSK20M	Front Face	1	42990	1	50	DSI4	Ant5	1	62.9	22.00	21.19	-0.06	0.339	1.006	1.205	0.41
	LTE 42	QPSK20M	Rear Face	1	42990	1	50	DSI4	Ant5	1	62.9	22.00	21.19	0.02	0.429	1.006	1.205	0.52
	LTE 42	QPSK20M	Front Face	1	42990	50	0	DSI4	Ant5	1	62.9	22.00	20.89	-0.19	0.303	1.006	1.291	0.39
P42	LTE 42	QPSK20M	Rear Face	1	42990	50	0	DSI4	Ant5	1	62.9	22.00	20.89	0.08	0.432	1.006	1.291	0.56
	LTE 42	QPSK20M	Front Face	2	42990	1	50	DSI2	Ant5	1	62.9	24.00	22.47	-0.01	0.162	1.006	1.422	0.23
	LTE 42	QPSK20M	Rear Face	2	42990	1	50	DSI2	Ant5	1	62.9	24.00	22.47	0.03	0.258	1.006	1.422	0.37
	LTE 42	QPSK20M	Front Face	2	42990	50	0	DSI2	Ant5	1	62.9	23.00	21.52	-0.04	0.145	1.006	1.406	0.21
	LTE 42	QPSK20M	Rear Face	2	42990	50	0	DSI2	Ant5	1	62.9	23.00	21.52	-0.17	0.250	1.006	1.406	0.35
	LTE 42 (ENDC Only)	QPSK20M	Front Face	1	42990	1	50	DSI4	Ant5	1	62.9	20.00	19.08	0.11	0.207	1.006	1.236	0.26
	LTE 42 (ENDC Only)	QPSK20M	Rear Face	1	42990	1	50	DSI4	Ant5	1	62.9	20.00	19.08	0.03	0.361	1.006	1.236	0.45
	LTE 42 (ENDC Only)	QPSK20M	Front Face	1	42990	50	0	DSI4	Ant5	1	62.9	20.00	19.03	0.08	0.202	1.006	1.250	0.25
	LTE 42 (ENDC Only)	QPSK20M	Rear Face	1	42990	50	0	DSI4	Ant5	1	62.9	20.00	19.03	-0.14	0.355	1.006	1.250	0.45
	LTE 42	QPSK20M	Front Face	1	42190	1	50	DSI2	Ant7	1	62.9	22.50	21.01	-0.08	0.114	1.006	1.409	0.16
	LTE 42	QPSK20M	Rear Face	1	42190	1	50	DSI2	Ant7	1	62.9	22.50	21.01	0.10	0.352	1.006	1.409	0.50
	LTE 42	QPSK20M	Front Face	1	42190	50	25	DSI2	Ant7	1	62.9	21.50	20.12	0.02	0.088	1.006	1.374	0.12
	LTE 42	QPSK20M	Rear Face	1	42190	50	25	DSI2	Ant7	1	62.9	21.50	20.12	0.14	0.290	1.006	1.374	0.40
	LTE 48	QPSK20M	Front Face	1	55340	1	50	DSI4	Ant2	1	62.9	22.00	20.95	0.17	0.136	1.006	1.274	0.17
	LTE 48	QPSK20M	Rear Face	1	55340	1	50	DSI4	Ant2	1	62.9	22.00	20.95	-0.03	0.104	1.006	1.274	0.13
	LTE 48	QPSK20M	Front Face	1	55340	50	25	DSI4	Ant2	1	62.9	21.00	19.98	-0.17	0.115	1.006	1.265	0.15
	LTE 48	QPSK20M	Rear Face	1	55340	50	25	DSI4	Ant2	1	62.9	21.00	19.98	0.02	0.087	1.006	1.265	0.11
	LTE 48	QPSK20M	Front Face	1	56150	1	50	DSI4	Ant3	1	62.9	20.00	18.58	0.16	0.132	1.006	1.387	0.18
	LTE 48	QPSK20M	Rear Face	1	56150	1	50	DSI4	Ant3	1	62.9	20.00	18.58	0.17	0.200	1.006	1.387	0.28
	LTE 48	QPSK20M	Front Face	1	56150	50	25	DSI4	Ant3	1	62.9	19.00	17.48	-0.10	0.139	1.006	1.419	0.20
	LTE 48	QPSK20M	Rear Face	1	56150	50	25	DSI4	Ant3	1	62.9	19.00	17.48	0.08	0.199	1.006	1.419	0.28
	LTE 48	QPSK20M	Front Face	1	55340	1	50	DSI4	Ant5	1	62.9	22.00	21.25	-0.19	0.276	1.006	1.189	0.33
	LTE 48	QPSK20M	Rear Face	1	55340	1	50	DSI4	Ant5	1	62.9	22.00	21.25	0.09	0.486	1.006	1.189	0.58
	LTE 48	QPSK20M	Front Face	1	55340	50	0	DSI4	Ant5	1	62.9	22.00	20.97	-0.07	0.277	1.006	1.268	0.35
	LTE 48	QPSK20M	Rear Face	1	55340	50	0	DSI4	Ant5	1	62.9	22.00	20.97	-0.01	0.494	1.006	1.268	0.63
	LTE 48	QPSK20M	Front Face	2	55340	1	50	DSI2	Ant5	1	62.9	24.00	22.49	0.14	0.149	1.006	1.416	0.21
	LTE 48	QPSK20M	Rear Face	2	55340	1	50	DSI2	Ant5	1	62.9	24.00	22.49	0.08	0.241	1.006	1.416	0.34
	LTE 48	QPSK20M	Front Face	2	55340	50	0	DSI2	Ant5	1	62.9	23.00	21.53	0.16	0.116	1.006	1.403	0.16
	LTE 48	QPSK20M	Rear Face	2	55340	50	0	DSI2	Ant5	1	62.9	23.00	21.53	0.07	0.195	1.006	1.403	0.28
	LTE 48	QPSK20M	Front Face	1	55340	1	50	DSI2	Ant7	1	62.9	22.00	20.50	-0.08	0.091	1.006	1.413	0.13
	LTE 48	QPSK20M	Rear Face	1	55340	1	50	DSI2	Ant7	1	62.9	22.00	20.50	0.14	0.510	1.006	1.435	0.74
	LTE 48	QPSK20M	Front Face	1	55340	50	25	DSI2	Ant7	1	62.9	21.50	20.16	-0.10	0.079	1.006	1.361	0.11
P43	LTE 48	QPSK20M	Rear Face	1	55340	50	25	DSI2	Ant7	1	62.9	21.50	20.16	-0.08	0.552	1.006	1.361	0.76
	LTE 66	QPSK20M	Front Face	1	132322	1	50	DSI3/4	Ant1	1	-	19.00	17.98	0.09	0.249	1.000	1.265	0.31
	LTE 66	QPSK20M	Rear Face	1	132322	1	50	DSI3/4	Ant1	1	-	19.00	17.98	0.13	0.304	1.000	1.265	0.38
	LTE 66	QPSK20M	Front Face	1	132322	50	25	DSI3/4	Ant1	1	-	19.00	17.88	0.07	0.243	1.000	1.294	0.31
	LTE 66	QPSK20M	Rear Face	1	132322	50	25	DSI3/4	Ant1	1	-	19.00	17.88	0.15	0.314	1.000	1.294	0.41
	LTE 66	QPSK20M	Front Face	2	132322	1	50	DSI2	Ant1	1	-	25.50	24.51	0.18	0.248	1.000	1.256	0.31
	LTE 66	QPSK20M	Rear Face	2	132322	1	50	DSI2	Ant1	1	-	25.50	24.51	0.04	0.304	1.000	1.256	0.38
	LTE 66	QPSK20M	Front Face	2	132322	50	50	DSI2	Ant1	1	-	24.50	23.56	0.18	0.202	1.000	1.242	0.25
	LTE 66	QPSK20M	Rear Face	2	132322	50	50	DSI2	Ant1	1	-	24.50	23.56	0.14	0.251	1.000	1.242	0.31
	LTE 66	QPSK20M	Front Face	1	132072	1	50	DSI4	Ant4	1	-	21.50	20.38	-0.16	0.268	1.000	1.294	0.35
P44	LTE 66	QPSK20M	Rear Face	1	132072	1	50	DSI4	Ant4	1	-	21.50	20.38	-0.06	0.438	1.000	1.294	0.57
	LTE 66	QPSK20M	Front Face	1	132072	50	25	DSI4	Ant4	1	-	21.50	20.17	-0.04	0.290	1.000	1.358	0.39
	LTE 66	QPSK20M	Rear Face	1	132072	50	25	DSI4	Ant4	1	-	21.50	20.17	-0.15	0.405	1.000	1.358	0.55
	LTE 66	QPSK20M	Front Face	2	132072	1	50	DSI2	Ant4	1	-	25.00	23.63	-0.09	0.159	1.000	1.371	0.22
	LTE 66	QPSK20M	Rear Face	2	132072	1	50	DSI2	Ant4	1	-	25.00	23.63	0.05	0.215	1.000	1.371	0.29
	LTE 66	QPSK20M	Front Face	2	132072	50	50	DSI2	Ant4	1	-	24.00	22.81	0.11	0.130	1.000	1.315	0.17
	LTE 66	QPSK20M	Rear Face	2	132072	50	50	DSI2	Ant4	1	-	24.00	22.81	-0.15	0.179	1.000	1.315	0.24
	LTE 66	QPSK20M	Front Face	1	132322	1	50	DSI4	Ant3	1	-	21.00	19.72	-0.04	0.087	1.000	1.343	0.12
	LTE 66	QPSK20M	Rear Face	1	132322	1	50	DSI4	Ant3	1	-	21.00	19.72	0.10	0.123	1.000	1.343	0.17
	LTE 66	QPSK20M	Front Face	1	132322	50	25	DSI4	Ant3	1	-	21.00	19.62	-0.09	0.087	1.000	1.374	0.12
	LTE 66	QPSK20M	Rear Face	1	132322	50	25	DSI4	Ant3	1	-	21.00	19.62	0.16	0.124	1.000	1.374	0.17
	LTE 66	QPSK20M	Front Face	2	132322	1	50	DSI2	Ant3	1	-	25.50	23.95	0.01	0.050	1.000	1.429	0.07



BUREAU VERITAS

FCC SAR Test Report



Certificate #6613.01

Plot No.	Band	Mode	Test Position	Separation Distance (cm)	Ch.	RB#	RB Offset	Power State	Antenna	Sample	Duty Cycle %	Max. Tune-up Power (dBm)	Measured Conducted Power (dBm)	Power Drift (dB)	Measured SAR-1g (W/kg)	Duty Cycle Scaling Factor	Tune-up Scaling Factor	Scaled SAR-1g (W/kg)
	LTE 66	QPSK20M	Rear Face	2	132322	1	50	DSI2	Ant3	1	-	25.50	23.95	0.14	0.068	1.000	1.429	0.10
	LTE 66	QPSK20M	Front Face	2	132322	50	25	DSI2	Ant3	1	-	24.50	22.98	0.00	0.000	1.000	1.419	0.00
	LTE 66	QPSK20M	Rear Face	2	132322	50	25	DSI2	Ant3	1	-	24.50	22.98	-0.09	0.055	1.000	1.419	0.08
	n2	DFT-QPSK20M	Front Face	1	376000	1	53	DSI3/4	Ant1	1	-	19.00	18.25	-0.19	0.284	1.000	1.189	0.34
	n2	DFT-QPSK20M	Rear Face	1	376000	1	53	DSI3/4	Ant1	1	-	19.00	18.25	0.02	0.306	1.000	1.189	0.36
	n2	DFT-QPSK20M	Front Face	1	376000	50	28	DSI3/4	Ant1	1	-	19.00	18.31	0.06	0.265	1.000	1.172	0.31
	n2	DFT-QPSK20M	Rear Face	1	376000	50	28	DSI3/4	Ant1	1	-	19.00	18.31	0.13	0.276	1.000	1.172	0.32
	n2	DFT-QPSK20M	Front Face	2	376000	1	53	DSI2	Ant1	1	-	25.00	23.86	-0.12	0.216	1.000	1.300	0.28
	n2	DFT-QPSK20M	Rear Face	2	376000	1	53	DSI2	Ant1	1	-	25.00	23.86	0.08	0.265	1.000	1.300	0.34
	n2	DFT-QPSK20M	Front Face	2	376000	50	28	DSI2	Ant1	1	-	25.00	24.57	-0.14	0.210	1.000	1.104	0.23
	n2	DFT-QPSK20M	Rear Face	2	376000	50	28	DSI2	Ant1	1	-	25.00	24.57	-0.11	0.262	1.000	1.104	0.29
	n2	DFT-QPSK20M	Front Face	1	376000	1	53	DSI4	Ant4	1	-	19.50	18.78	-0.04	0.360	1.000	1.180	0.42
P45	n2	DFT-QPSK20M	Rear Face	1	376000	1	53	DSI4	Ant4	1	-	19.50	18.78	-0.09	0.600	1.000	1.180	0.71
	n2	DFT-QPSK20M	Front Face	1	376000	50	28	DSI4	Ant4	1	-	19.50	18.85	0.18	0.385	1.000	1.161	0.45
	n2	DFT-QPSK20M	Rear Face	1	376000	50	28	DSI4	Ant4	1	-	19.50	18.85	-0.08	0.566	1.000	1.161	0.66
	n2	DFT-QPSK20M	Front Face	2	376000	1	53	DSI2	Ant4	1	-	24.50	23.54	-0.13	0.225	1.000	1.247	0.28
	n2	DFT-QPSK20M	Rear Face	2	376000	1	53	DSI2	Ant4	1	-	24.50	23.54	0.10	0.396	1.000	1.247	0.49
	n2	DFT-QPSK20M	Front Face	2	376000	50	28	DSI2	Ant4	1	-	24.50	23.84	0.06	0.229	1.000	1.164	0.27
	n2	DFT-QPSK20M	Rear Face	2	376000	50	28	DSI2	Ant4	1	-	24.50	23.84	-0.03	0.401	1.000	1.164	0.47
	n7	DFT-QPSK50M	Front Face	1	507000	1	135	DSI3/4	Ant1	1	-	23.00	21.76	0.17	0.387	1.000	1.330	0.51
	n7	DFT-QPSK50M	Rear Face	1	507000	1	135	DSI3/4	Ant1	1	-	23.00	21.76	-0.17	0.341	1.000	1.330	0.45
	n7	DFT-QPSK50M	Front Face	1	507000	135	68	DSI3/4	Ant1	1	-	23.00	21.88	-0.12	0.386	1.000	1.294	0.50
	n7	DFT-QPSK50M	Rear Face	1	507000	135	68	DSI3/4	Ant1	1	-	23.00	21.88	0.00	0.360	1.000	1.294	0.47
	n7	DFT-QPSK50M	Front Face	2	507000	1	135	DSI2	Ant1	1	-	25.00	23.40	0.02	0.196	1.000	1.445	0.28
	n7	DFT-QPSK50M	Rear Face	2	507000	1	135	DSI2	Ant1	1	-	25.00	23.40	-0.07	0.210	1.000	1.445	0.30
	n7	DFT-QPSK50M	Front Face	2	507000	135	68	DSI2	Ant1	1	-	25.00	24.05	-0.15	0.204	1.000	1.245	0.25
	n7	DFT-QPSK50M	Rear Face	2	507000	135	68	DSI2	Ant1	1	-	25.00	24.05	0.07	0.213	1.000	1.245	0.27
	n7	DFT-QPSK50M	Front Face	1	505000	1	135	DSI4	Ant4	1	-	19.50	18.74	0.05	0.260	1.000	1.191	0.31
P46	n7	DFT-QPSK50M	Rear Face	1	505000	1	135	DSI4	Ant4	1	-	19.50	18.74	-0.02	0.503	1.000	1.191	0.60
	n7	DFT-QPSK50M	Front Face	1	505000	135	68	DSI4	Ant4	1	-	19.50	18.85	-0.16	0.258	1.000	1.161	0.30
	n7	DFT-QPSK50M	Rear Face	1	505000	135	68	DSI4	Ant4	1	-	19.50	18.85	0.15	0.501	1.000	1.161	0.58
	n7	DFT-QPSK50M	Front Face	2	505000	1	135	DSI2	Ant4	1	-	24.50	23.57	-0.12	0.201	1.000	1.239	0.25
	n7	DFT-QPSK50M	Rear Face	2	505000	1	135	DSI2	Ant4	1	-	24.50	23.57	0.05	0.344	1.000	1.239	0.43
	n7	DFT-QPSK50M	Front Face	2	505000	135	68	DSI2	Ant4	1	-	24.50	24.04	0.02	0.203	1.000	1.112	0.23
	n7	DFT-QPSK50M	Rear Face	2	505000	135	68	DSI2	Ant4	1	-	24.50	24.04	0.09	0.345	1.000	1.112	0.38
	n12	DFT-QPSK15M	Front Face	1	141500	1	38	DSI3/4	Ant1	1	-	25.50	24.40	0.06	0.169	1.000	1.288	0.22
	n12	DFT-QPSK15M	Rear Face	1	141500	1	38	DSI3/4	Ant1	1	-	25.50	24.40	-0.01	0.181	1.000	1.288	0.23
	n12	DFT-QPSK15M	Front Face	1	141500	36	22	DSI3/4	Ant1	1	-	25.50	24.56	0.12	0.172	1.000	1.242	0.21
P47	n12	DFT-QPSK15M	Rear Face	1	141500	36	22	DSI3/4	Ant1	1	-	25.50	24.56	0.01	0.195	1.000	1.242	0.24
	n12	DFT-QPSK15M	Front Face	1	141500	1	38	DSI3/4	Ant4	1	-	25.00	23.80	0.07	0.109	1.000	1.318	0.14
	n12	DFT-QPSK15M	Rear Face	1	141500	1	38	DSI3/4	Ant4	1	-	25.00	23.80	0.06	0.146	1.000	1.318	0.19
	n12	DFT-QPSK15M	Front Face	1	141500	36	22	DSI3/4	Ant4	1	-	25.00	23.92	0.04	0.107	1.000	1.282	0.14
	n12	DFT-QPSK15M	Rear Face	1	141500	36	22	DSI3/4	Ant4	1	-	25.00	23.92	0.05	0.147	1.000	1.282	0.19
	n26	DFT-QPSK20M	Front Face	1	166300	1	53	DSI3/4	Ant1	1	-	25.50	24.54	0.04	0.223	1.000	1.247	0.28
P48	n26	DFT-QPSK20M	Rear Face	1	166300	1	53	DSI3/4	Ant1	1	-	25.50	24.54	0.01	0.379	1.000	1.247	0.47
	n26	DFT-QPSK20M	Front Face	1	166300	50	28	DSI3/4	Ant1	1	-	25.50	24.70	-0.17	0.216	1.000	1.202	0.26
	n26	DFT-QPSK20M	Rear Face	1	166300	50	28	DSI3/4	Ant1	1	-	25.50	24.70	0.13	0.315	1.000	1.202	0.38
	n26	DFT-QPSK20M	Front Face	1	166300	1	53	DSI4	Ant4	1	-	25.00	24.03	-0.05	0.181	1.000	1.250	0.23
	n26	DFT-QPSK20M	Rear Face	1	166300	1	53	DSI4	Ant4	1	-	25.00	24.03	-0.04	0.231	1.000	1.250	0.29
	n26	DFT-QPSK20M	Front Face	1	166300	50	28	DSI4	Ant4	1	-	25.00	24.20	0.06	0.170	1.000	1.202	0.20
	n26	DFT-QPSK20M	Rear Face	1	166300	50	28	DSI4	Ant4	1	-	25.00	24.20	0.13	0.230	1.000	1.202	0.28
	n38	DFT-QPSK40M	Front Face	1	518000	1	53	DSI3/4	Ant1	1	100	23.50	22.53	0.04	0.403	1.000	1.250	0.50
	n38	DFT-QPSK40M	Rear Face	1	518000	1	53	DSI3/4	Ant1	1	100	23.50	22.53	0.19	0.414	1.000	1.250	0.52
	n38	DFT-QPSK40M	Front Face	1	518000	50	28	DSI3/4	Ant1	1	100	23.50	22.54	-0.18	0.389	1.000	1.247	0.49
	n38	DFT-QPSK40M	Rear Face	1	518000	50	28	DSI3/4	Ant1	1	100	23.50	22.54	0.15	0.411	1.000	1.247	0.51
	n38	DFT-QPSK40M	Front Face	2	518000	1	53	DSI2	Ant1	1	100	25.00	24.11	-0.14	0.209	1.000	1.227	0.26
	n38	DFT-QPSK40M	Rear Face	2	518000	1	53	DSI2	Ant1	1	100	25.00	24.11	0.08	0.233	1.000	1.227	0.29
	n38	DFT-QPSK40M	Front Face	2	518000	50	28	DSI2	Ant1	1	100	25.00	24.14	0.15	0.200	1.000	1.219	0.24
	n38	DFT-QPSK40M	Rear Face	2	518000	50	28	DSI2	Ant1	1	100	25.00	24.14	0.06	0.217	1.000	1.219	0.26
	n38	DFT-QPSK40M	Front Face	1	520000	1	53	DSI4	Ant4	1	100	20.00	19.11	0.01	0.288	1.000	1.227	0.35
P49	n38	DFT-QPSK40M	Rear Face	1	520000	1	53	DSI4	Ant4	1	100	20.00	19.11	-0.04	0.505	1.000	1.227	0.62
	n38	DFT-QPSK40M	Front Face	1	520000	50	28	DSI4	Ant4	1	100	20.00	19.16	-0.17	0.292	1.000	1.213	0.35
	n38	DFT-QPSK40M	Rear Face	1	520000	50	28	DSI4	Ant4	1	100	20.00	19.16	-0.10	0.502	1.000	1.213	0.61
	n38	DFT-QPSK40M	Front Face	2	520000	1	53	DSI2	Ant4	1	100	24.50	23.54	0.14	0.192	1.000	1.247	0.24
	n38	DFT-QPSK40M	Rear Face	2	520000	1	53	DSI2	Ant4	1	100	24.50	23.54	0.12	0.320	1.000	1.247	0.40
	n38	DFT-QPSK40M	Front Face	2	520000	50	28	DSI2	Ant4	1	100	24.50	23.59	0.18	0.197	1.000	1.233	0.24
	n38	DFT-QPSK40M	Rear Face	2	520000	50	28	DSI2	Ant4	1	100	24.50	23.59	0.06	0.332	1.000	1.233	0.41
	n41	DFT-QPSK100M	Front Face	1	518598	1	137	DSI3/4	Ant1	1	100	22.50	21.38	-0.19	0.344	1.000	1.294	0.45
	n41	DFT-QPSK100M	Rear Face	1	518598	1	137	DSI3/4	Ant1	1	100	22.50	21.38	-0.05	0.370	1.000	1.294	0.48
	n41	DFT-QPSK100M	Front Face	1	518598	135	69	DSI3/4	Ant1	1	100	22.50	21.48	-0.07	0.358	1.000	1.265	0.45
	n41	DFT-QPSK100M	Rear Face	1	518598	135	69	DSI3/4	Ant1	1	100	22.50	21.48	-0.11	0.360	1.000	1.265	0.46
	n41	DFT-QPSK100M	Front Face	2	518598	1	137	DSI2	Ant1	1	100	25.00	24.01	-0.14	0.203	1.000	1.256	0.25
	n41	DFT-QPSK100M	Rear Face	2	518598	1	137	DSI2	Ant1	1	100	25.00	24.01	-0.13	0.230	1.000	1.256	0.29
	n41	DFT-QPSK100M	Front Face	2	518598	135	69	DSI2	Ant1	1	100	25.00	24.06	0.16	0			



BUREAU VERITAS

FCC SAR Test Report



Certificate #6613.01

Plot No.	Band	Mode	Test Position	Separation Distance (cm)	Ch.	RB#	RB Offset	Power State	Antenna	Sample	Duty Cycle %	Max. Tune-up Power (dBm)	Measured Conducted Power (dBm)	Power Drift (dB)	Measured SAR-1g (W/kg)	Duty Cycle Scaling Factor	Tune-up Scaling Factor	Scaled SAR-1g (W/kg)
	n41	DFT-QPSK100M	Rear Face	2	518598	135	69	DSI2	Ant1	1	100	25.00	24.06	0.13	0.231	1.000	1.242	0.29
	n41	DFT-QPSK100M	Front Face	1	518598	1	137	DSI4	Ant3	1	100	20.50	19.53	-0.19	0.166	1.000	1.250	0.21
	n41	DFT-QPSK100M	Rear Face	1	518598	1	137	DSI4	Ant3	1	100	20.50	19.53	-0.13	0.274	1.000	1.250	0.34
	n41	DFT-QPSK100M	Front Face	1	518598	135	69	DSI4	Ant3	1	100	20.50	19.61	-0.09	0.165	1.000	1.227	0.20
	n41	DFT-QPSK100M	Rear Face	1	518598	135	69	DSI4	Ant3	1	100	20.50	19.61	-0.12	0.273	1.000	1.227	0.34
	n41	DFT-QPSK100M	Front Face	2	518598	1	137	DSI2	Ant3	1	100	22.00	21.26	-0.19	0.063	1.000	1.186	0.07
	n41	DFT-QPSK100M	Rear Face	2	518598	1	137	DSI2	Ant3	1	100	22.00	21.26	-0.05	0.086	1.000	1.186	0.10
	n41	DFT-QPSK100M	Front Face	2	518598	135	69	DSI2	Ant3	1	100	22.00	21.28	-0.17	0.063	1.000	1.180	0.07
	n41	DFT-QPSK100M	Rear Face	2	518598	135	69	DSI2	Ant3	1	100	22.00	21.28	0.09	0.086	1.000	1.180	0.10
	n41	DFT-QPSK100M	Front Face	1	518598	1	137	DSI4	Ant4	1	100	20.00	19.27	-0.16	0.283	1.000	1.183	0.33
	n41	DFT-QPSK100M	Rear Face	1	518598	1	137	DSI4	Ant4	1	100	20.00	19.27	-0.13	0.541	1.000	1.183	0.64
	n41	DFT-QPSK100M	Front Face	1	518598	135	69	DSI4	Ant4	1	100	20.00	19.29	-0.08	0.299	1.000	1.178	0.35
P50	n41	DFT-QPSK100M	Rear Face	1	518598	135	69	DSI4	Ant4	1	100	20.00	19.29	-0.02	0.553	1.000	1.178	0.65
	n41	DFT-QPSK100M	Front Face	2	518598	1	137	DSI2	Ant4	1	100	24.50	24.04	0.13	0.232	1.000	1.112	0.26
	n41	DFT-QPSK100M	Rear Face	2	518598	1	137	DSI2	Ant4	1	100	24.50	24.04	-0.18	0.288	1.000	1.112	0.32
	n41	DFT-QPSK100M	Front Face	2	518598	135	69	DSI2	Ant4	1	100	24.50	24.06	-0.11	0.235	1.000	1.107	0.26
	n41	DFT-QPSK100M	Rear Face	2	518598	135	69	DSI2	Ant4	1	100	24.50	24.06	-0.17	0.390	1.000	1.107	0.43
	n41	DFT-QPSK100M	Front Face	1	518598	1	137	DSI2	Ant7	1	100	21.00	20.24	-0.17	0.137	1.000	1.191	0.16
	n41	DFT-QPSK100M	Rear Face	1	518598	1	137	DSI2	Ant7	1	100	21.00	20.24	0.15	0.243	1.000	1.191	0.29
	n41	DFT-QPSK100M	Front Face	1	518598	135	69	DSI2	Ant7	1	100	21.00	20.30	-0.11	0.141	1.000	1.175	0.17
	n41	DFT-QPSK100M	Rear Face	1	518598	135	69	DSI2	Ant7	1	100	21.00	20.30	0.09	0.243	1.000	1.175	0.29
	n48	DFT-QPSK100M	Front Face	1	640000	1	137	DSI4	Ant2	1	100	23.50	22.55	0.18	0.361	1.000	1.245	0.45
	n48	DFT-QPSK100M	Rear Face	1	640000	1	137	DSI4	Ant2	1	100	23.50	22.55	0.13	0.227	1.000	1.245	0.28
	n48	DFT-QPSK100M	Front Face	1	640000	135	69	DSI4	Ant2	1	100	23.50	22.68	0.14	0.353	1.000	1.208	0.43
	n48	DFT-QPSK100M	Rear Face	1	640000	135	69	DSI4	Ant2	1	100	23.50	22.68	0.09	0.257	1.000	1.208	0.31
	n48	DFT-QPSK100M	Front Face	1	643332	1	137	DSI4	Ant3	1	100	18.50	17.79	-0.18	0.208	1.000	1.178	0.24
	n48	DFT-QPSK100M	Rear Face	1	643332	1	137	DSI4	Ant3	1	100	18.50	17.79	-0.15	0.316	1.000	1.178	0.37
	n48	DFT-QPSK100M	Front Face	1	643332	135	69	DSI4	Ant3	1	100	18.50	17.84	0.19	0.212	1.000	1.164	0.25
	n48	DFT-QPSK100M	Rear Face	1	643332	135	69	DSI4	Ant3	1	100	18.50	17.84	-0.06	0.332	1.000	1.164	0.39
	n48	DFT-QPSK100M	Front Face	2	643332	1	137	DSI2	Ant3	1	100	20.00	19.26	-0.16	0.107	1.000	1.186	0.13
	n48	DFT-QPSK100M	Rear Face	2	643332	1	137	DSI2	Ant3	1	100	20.00	19.26	-0.12	0.145	1.000	1.186	0.17
	n48	DFT-QPSK100M	Front Face	2	643332	135	69	DSI2	Ant3	1	100	20.00	19.26	0.01	0.111	1.000	1.186	0.13
	n48	DFT-QPSK100M	Rear Face	2	643332	135	69	DSI2	Ant3	1	100	20.00	19.26	0.18	0.152	1.000	1.186	0.18
	n48	DFT-QPSK100M	Front Face	1	640000	1	137	DSI4	Ant5	1	100	20.00	18.92	0.09	0.259	1.000	1.282	0.33
	n48	DFT-QPSK100M	Rear Face	1	640000	1	137	DSI4	Ant5	1	100	20.00	18.92	-0.08	0.484	1.000	1.282	0.62
	n48	DFT-QPSK100M	Front Face	1	640000	135	69	DSI4	Ant5	1	100	20.00	19.05	0.18	0.265	1.000	1.245	0.33
	n48	DFT-QPSK100M	Rear Face	1	640000	135	69	DSI4	Ant5	1	100	20.00	19.05	0.10	0.388	1.000	1.245	0.48
	n48	DFT-QPSK100M	Front Face	2	640000	1	137	DSI2	Ant5	1	100	24.00	23.04	0.14	0.267	1.000	1.247	0.33
	n48	DFT-QPSK100M	Rear Face	2	640000	1	137	DSI2	Ant5	1	100	24.00	23.04	-0.05	0.350	1.000	1.247	0.44
	n48	DFT-QPSK100M	Front Face	2	640000	135	69	DSI2	Ant5	1	100	24.00	23.18	-0.17	0.254	1.000	1.208	0.31
	n48	DFT-QPSK100M	Rear Face	2	640000	135	69	DSI2	Ant5	1	100	24.00	23.18	-0.04	0.389	1.000	1.208	0.47
	n48	DFT-QPSK100M	Front Face	1	640000	1	137	DSI2	Ant7	1	100	18.50	17.10	0.05	0.118	1.000	1.380	0.16
	n48	DFT-QPSK100M	Rear Face	1	640000	1	137	DSI2	Ant7	1	100	18.50	17.10	-0.01	0.544	1.000	1.380	0.75
	n48	DFT-QPSK100M	Front Face	1	640000	135	69	DSI2	Ant7	1	100	18.50	17.25	0.12	0.123	1.000	1.334	0.16
	n48	DFT-QPSK100M	Rear Face	1	640000	135	69	DSI2	Ant7	1	100	18.50	17.25	-0.15	0.580	1.000	1.334	0.77
	n48	DFT-QPSK100M	Front Face	1	641666	1	137	DSI2	Ant7	1	100	18.50	17.05	-0.12	0.705	1.000	1.396	0.98
P51	n48	DFT-QPSK100M	Rear Face	1	643332	1	137	DSI2	Ant7	1	100	18.50	17.01	0.03	0.764	1.000	1.409	1.08
	n48	DFT-QPSK100M	Rear Face	1	640000	270	0	DSI2	Ant7	1	100	18.50	17.20	-0.14	0.589	1.000	1.349	0.79
	n66	DFT-QPSK40M	Front Face	1	349000	1	107	DSI3/4	Ant1	1	-	20.00	18.86	0.16	0.282	1.000	1.300	0.37
	n66	DFT-QPSK40M	Rear Face	1	349000	1	107	DSI3/4	Ant1	1	-	20.00	18.86	-0.02	0.396	1.000	1.300	0.51
	n66	DFT-QPSK40M	Front Face	1	349000	108	54	DSI3/4	Ant1	1	-	20.00	18.91	0.12	0.281	1.000	1.285	0.36
	n66	DFT-QPSK40M	Rear Face	1	349000	108	54	DSI3/4	Ant1	1	-	20.00	18.91	-0.17	0.373	1.000	1.285	0.48
	n66	DFT-QPSK40M	Front Face	2	349000	1	107	DSI2	Ant1	1	-	25.50	24.18	0.15	0.241	1.000	1.355	0.33
	n66	DFT-QPSK40M	Rear Face	2	349000	1	107	DSI2	Ant1	1	-	25.50	24.18	0.06	0.289	1.000	1.355	0.39
	n66	DFT-QPSK40M	Front Face	2	349000	108	54	DSI2	Ant1	1	-	25.50	24.57	0.10	0.248	1.000	1.239	0.31
	n66	DFT-QPSK40M	Rear Face	2	349000	108	54	DSI2	Ant1	1	-	25.50	24.57	0.17	0.293	1.000	1.239	0.36
	n66	DFT-QPSK40M	Front Face	1	349000	1	107	DSI4	Ant4	1	-	23.00	22.19	0.10	0.361	1.000	1.205	0.44
P52	n66	DFT-QPSK40M	Rear Face	1	349000	1	107	DSI4	Ant4	1	-	23.00	22.19	-0.13	0.647	1.000	1.205	0.78
	n66	DFT-QPSK40M	Front Face	1	349000	108	54	DSI4	Ant4	1	-	23.00	22.38	0.13	0.367	1.000	1.153	0.42
	n66	DFT-QPSK40M	Rear Face	1	349000	108	54	DSI4	Ant4	1	-	23.00	22.38	-0.10	0.563	1.000	1.153	0.65
	n66	DFT-QPSK40M	Front Face	2	349000	1	107	DSI2	Ant4	1	-	25.00	23.94	0.03	0.158	1.000	1.276	0.20
	n66	DFT-QPSK40M	Rear Face	2	349000	1	107	DSI2	Ant4	1	-	25.00	23.94	-0.11	0.208	1.000	1.276	0.27
	n66	DFT-QPSK40M	Front Face	2	349000	108	54	DSI2	Ant4	1	-	25.00	24.18	0.14	0.161	1.000	1.208	0.19
	n66	DFT-QPSK40M	Rear Face	2	349000	108	54	DSI2	Ant4	1	-	25.00	24.18	0.07	0.216	1.000	1.208	0.26
	n66 (ENDC Only)	DFT-QPSK40M	Front Face	1	349000	1	107	DSI4	Ant4	1	-	20.00	19.05	-0.01	0.198	1.000	1.245	0.25
	n66 (ENDC Only)	DFT-QPSK40M	Rear Face	1	349000	1	107	DSI4	Ant4	1	-	20.00	19.05	0.06	0.240	1.000	1.245	0.30
	n66 (ENDC Only)	DFT-QPSK40M	Front Face	1	349000	108	54	DSI4	Ant4	1	-	20.00	19.07	-0.14	0.184	1.000	1.239	0.23
	n66 (ENDC Only)	DFT-QPSK40M	Rear Face	1	349000	108	54	DSI4	Ant4	1	-	20.00	19.07	-0.19	0.305	1.000	1.239	0.38
	n77	DFT-QPSK100M	Front Face	1	633334	1	137	DSI4	Ant2	1	100	22.00	20.75	-0.05	0.286	1.000	1.334	0.38
	n77	DFT-QPSK100M	Rear Face	1	633334	1	137	DSI4	Ant2	1	100	22.00	20.75	0.15	0.231	1.000	1.334	0.31
	n77	DFT-QPSK100M	Front Face	1	633334	135	69	DSI4	Ant2	1	100	22.00	20.89	0.16	0.286	1.000	1.291	0.37



Certificate #6613.01

BUREAU VERITAS

FCC SAR Test Report

Plot No.	Band	Mode	Test Position	Separation Distance (cm)	Ch.	RB#	RB Offset	Power State	Antenna	Sample	Duty Cycle %	Max. Tune-up Power (dBm)	Measured Conducted Power (dBm)	Power Drift (dB)	Measured SAR-1g (W/kg)	Duty Cycle Scaling Factor	Tune-up Scaling Factor	Scaled SAR-1g (W/kg)
	n77	DFT-QPSK100M	Rear Face	1	633334	135	69	DSI4	Ant2	1	100	22.00	20.89	-0.17	0.230	1.000	1.291	0.30
	n77	DFT-QPSK100M	Front Face	2	633334	1	137	DSI2	Ant2	1	100	25.00	24.26	0.14	0.132	1.000	1.186	0.16
	n77	DFT-QPSK100M	Rear Face	2	633334	1	137	DSI2	Ant2	1	100	25.00	24.26	-0.06	0.120	1.000	1.186	0.14
	n77	DFT-QPSK100M	Front Face	2	633334	135	69	DSI2	Ant2	1	100	25.00	24.32	-0.01	0.141	1.000	1.169	0.16
	n77	DFT-QPSK100M	Rear Face	2	633334	135	69	DSI2	Ant2	1	100	25.00	24.32	-0.05	0.132	1.000	1.169	0.15
	n77	DFT-QPSK100M	Front Face	1	650000	1	137	DSI4	Ant2	1	100	22.00	20.97	0.07	0.194	1.000	1.294	0.25
	n77	DFT-QPSK100M	Rear Face	1	650000	1	137	DSI4	Ant2	1	100	22.00	20.97	0.16	0.234	1.000	1.294	0.30
	n77	DFT-QPSK100M	Front Face	1	650000	135	69	DSI4	Ant2	1	100	22.00	21.06	0.18	0.207	1.000	1.268	0.26
	n77	DFT-QPSK100M	Rear Face	1	650000	135	69	DSI4	Ant2	1	100	22.00	21.06	0.16	0.218	1.000	1.268	0.28
	n77	DFT-QPSK100M	Front Face	2	650000	1	137	DSI2	Ant2	1	100	25.00	23.88	-0.12	0.091	1.000	1.294	0.12
	n77	DFT-QPSK100M	Rear Face	2	650000	1	137	DSI2	Ant2	1	100	25.00	23.88	0.09	0.074	1.000	1.294	0.10
	n77	DFT-QPSK100M	Front Face	2	650000	135	69	DSI2	Ant2	1	100	25.00	23.97	0.10	0.101	1.000	1.268	0.13
	n77	DFT-QPSK100M	Rear Face	2	650000	135	69	DSI2	Ant2	1	100	25.00	23.97	-0.07	0.073	1.000	1.268	0.09
	n77	DFT-QPSK100M	Front Face	1	633334	1	137	DSI4	Ant3	1	100	20.00	18.98	0.04	0.169	1.000	1.265	0.21
	n77	DFT-QPSK100M	Rear Face	1	633334	1	137	DSI4	Ant3	1	100	20.00	18.98	0.19	0.288	1.000	1.265	0.36
	n77	DFT-QPSK100M	Front Face	1	633334	135	69	DSI4	Ant3	1	100	20.00	19.10	-0.10	0.179	1.000	1.230	0.22
	n77	DFT-QPSK100M	Rear Face	1	633334	135	69	DSI4	Ant3	1	100	20.00	19.10	0.18	0.299	1.000	1.230	0.37
	n77	DFT-QPSK100M	Front Face	2	633334	1	137	DSI2	Ant3	1	100	20.50	19.73	0.19	0.117	1.000	1.194	0.14
	n77	DFT-QPSK100M	Rear Face	2	633334	1	137	DSI2	Ant3	1	100	20.50	19.73	-0.02	0.199	1.000	1.194	0.24
	n77	DFT-QPSK100M	Front Face	2	633334	135	69	DSI2	Ant3	1	100	20.50	19.87	0.14	0.117	1.000	1.156	0.14
	n77	DFT-QPSK100M	Rear Face	2	633334	135	69	DSI2	Ant3	1	100	20.50	19.87	0.12	0.200	1.000	1.156	0.23
	n77 (ENDC Only)	DFT-QPSK100M	Front Face	1	633334	1	137	DSI4	Ant3	1	100	16.50	15.46	0.09	0.081	1.000	1.271	0.10
	n77 (ENDC Only)	DFT-QPSK100M	Rear Face	1	633334	1	137	DSI4	Ant3	1	100	16.50	15.46	0.15	0.134	1.000	1.271	0.17
	n77 (ENDC Only)	DFT-QPSK100M	Front Face	1	633334	135	69	DSI4	Ant3	1	100	16.50	15.59	0.05	0.083	1.000	1.233	0.10
	n77 (ENDC Only)	DFT-QPSK100M	Rear Face	1	633334	135	69	DSI4	Ant3	1	100	16.50	15.59	0.16	0.127	1.000	1.233	0.16
	n77	DFT-QPSK100M	Front Face	1	662000	1	137	DSI4	Ant3	1	100	20.00	19.15	-0.07	0.208	1.000	1.216	0.25
	n77	DFT-QPSK100M	Rear Face	1	662000	1	137	DSI4	Ant3	1	100	20.00	19.15	-0.02	0.312	1.000	1.216	0.38
	n77	DFT-QPSK100M	Front Face	1	662000	135	69	DSI4	Ant3	1	100	20.00	19.29	-0.02	0.221	1.000	1.178	0.26
	n77	DFT-QPSK100M	Rear Face	1	662000	135	69	DSI4	Ant3	1	100	20.00	19.29	-0.19	0.315	1.000	1.178	0.37
	n77	DFT-QPSK100M	Front Face	2	662000	1	137	DSI2	Ant3	1	100	20.50	19.92	-0.17	0.170	1.000	1.143	0.19
	n77	DFT-QPSK100M	Rear Face	2	662000	1	137	DSI2	Ant3	1	100	20.50	19.92	0.06	0.242	1.000	1.143	0.28
	n77	DFT-QPSK100M	Front Face	2	662000	135	69	DSI2	Ant3	1	100	20.50	19.95	-0.12	0.171	1.000	1.135	0.19
	n77	DFT-QPSK100M	Rear Face	2	662000	135	69	DSI2	Ant3	1	100	20.50	19.95	0.14	0.240	1.000	1.135	0.27
	n77 (ENDC Only)	DFT-QPSK100M	Front Face	1	662000	1	137	DSI4	Ant3	1	100	16.50	15.59	0.03	0.104	1.000	1.233	0.13
	n77 (ENDC Only)	DFT-QPSK100M	Rear Face	1	662000	1	137	DSI4	Ant3	1	100	16.50	15.59	-0.14	0.155	1.000	1.233	0.19
	n77 (ENDC Only)	DFT-QPSK100M	Front Face	1	662000	135	69	DSI4	Ant3	1	100	16.50	15.72	-0.19	0.099	1.000	1.197	0.12
	n77 (ENDC Only)	DFT-QPSK100M	Rear Face	1	662000	135	69	DSI4	Ant3	1	100	16.50	15.72	0.08	0.121	1.000	1.197	0.14
	n77	DFT-QPSK100M	Front Face	1	633334	1	137	DSI4	Ant5	1	100	20.00	18.99	0.16	0.337	1.000	1.262	0.43
	n77	DFT-QPSK100M	Rear Face	1	633334	1	137	DSI4	Ant5	1	100	20.00	18.99	-0.19	0.493	1.000	1.262	0.62
	n77	DFT-QPSK100M	Front Face	1	633334	135	69	DSI4	Ant5	1	100	20.00	19.17	0.02	0.325	1.000	1.211	0.39
	n77	DFT-QPSK100M	Rear Face	1	633334	135	69	DSI4	Ant5	1	100	20.00	19.17	-0.04	0.507	1.000	1.211	0.61
	n77	DFT-QPSK100M	Front Face	2	633334	1	137	DSI2	Ant5	1	100	24.50	23.23	-0.06	0.404	1.000	1.340	0.54
	n77	DFT-QPSK100M	Rear Face	2	633334	1	137	DSI2	Ant5	1	100	24.50	23.23	0.01	0.636	1.000	1.340	0.85
	n77	DFT-QPSK100M	Front Face	2	633334	135	69	DSI2	Ant5	1	100	24.50	23.31	-0.03	0.431	1.000	1.315	0.57
	n77	DFT-QPSK100M	Rear Face	2	633334	135	69	DSI2	Ant5	1	100	24.50	23.31	0.08	0.587	1.000	1.315	0.77
	n77 (ENDC Only)	DFT-QPSK100M	Front Face	1	633334	1	137	DSI4	Ant5	1	100	17.50	16.45	-0.06	0.183	1.000	1.274	0.23
	n77 (ENDC Only)	DFT-QPSK100M	Rear Face	1	633334	1	137	DSI4	Ant5	1	100	17.50	16.45	-0.02	0.276	1.000	1.274	0.35
	n77 (ENDC Only)	DFT-QPSK100M	Front Face	1	633334	135	69	DSI4	Ant5	1	100	17.50	16.56	-0.15	0.187	1.000	1.242	0.23
	n77 (ENDC Only)	DFT-QPSK100M	Rear Face	1	633334	135	69	DSI4	Ant5	1	100	17.50	16.56	0.16	0.302	1.000	1.242	0.37
	n77	DFT-QPSK100M	Front Face	1	662000	1	137	DSI4	Ant5	1	100	20.00	18.92	0.08	0.219	1.000	1.282	0.28
	n77	DFT-QPSK100M	Rear Face	1	662000	1	137	DSI4	Ant5	1	100	20.00	18.92	-0.01	0.314	1.000	1.282	0.40
	n77	DFT-QPSK100M	Front Face	1	662000	135	69	DSI4	Ant5	1	100	20.00	19.02	0.02	0.209	1.000	1.253	0.26
	n77	DFT-QPSK100M	Rear Face	1	662000	135	69	DSI4	Ant5	1	100	20.00	19.02	-0.15	0.305	1.000	1.253	0.38
	n77	DFT-QPSK100M	Front Face	2	662000	1	137	DSI2	Ant5	1	100	24.50	23.13	0.03	0.217	1.000	1.371	0.30
	n77	DFT-QPSK100M	Rear Face	2	662000	1	137	DSI2	Ant5	1	100	24.50	23.13	-0.08	0.358	1.000	1.371	0.49
	n77	DFT-QPSK100M	Front Face	2	662000	135	69	DSI2	Ant5	1	100	24.50	23.17	-0.16	0.236	1.000	1.358	0.32
	n77	DFT-QPSK100M	Rear Face	2	662000	135	69	DSI2	Ant5	1	100	24.50	23.17	0.11	0.352	1.000	1.358	0.48
	n77 (ENDC Only)	DFT-QPSK100M	Front Face	1	662000	1	137	DSI4	Ant5	1	100	17.50	16.45	-0.09	0.112	1.000	1.274	0.14
	n77 (ENDC Only)	DFT-QPSK100M	Rear Face	1	662000	1	137	DSI4	Ant5	1	100	17.50	16.45	-0.14	0.181	1.000	1.274	0.23
	n77 (ENDC Only)	DFT-QPSK100M	Front Face	1	662000	135	69	DSI4	Ant5	1	100	17.50	16.61	0.11	0.121	1.000	1.227	0.15
	n77	DFT-QPSK100M	Rear Face	1	662000	135	69	DSI4	Ant5	1	100	17.50	16.61	0.03	0.189	1.000	1.227	0.23



BUREAU VERITAS

FCC SAR Test Report



Certificate #6613.01

Plot No.	Band	Mode	Test Position	Separation Distance (cm)	Ch.	RB#	RB Offset	Power State	Antenna	Sample	Duty Cycle %	Max. Tune-up Power (dBm)	Measured Conducted Power (dBm)	Power Drift (dB)	Measured SAR-1g (W/kg)	Duty Cycle Scaling Factor	Tune-up Scaling Factor	Scaled SAR-1g (W/kg)
	(ENDC Only)																	
	n77 PC2	DFT-QPSK100M	Front Face	1	633334	1	137	DSI4	Ant5	1	50	21.50	20.67	0.05	0.266	1.000	1.211	0.32
	n77 PC2	DFT-QPSK100M	Rear Face	1	633334	1	137	DSI4	Ant5	1	50	21.50	20.67	-0.15	0.434	1.000	1.211	0.53
	n77 PC2	DFT-QPSK100M	Front Face	1	633334	135	69	DSI4	Ant5	1	50	21.50	20.91	-0.13	0.270	1.000	1.146	0.31
	n77 PC2	DFT-QPSK100M	Rear Face	1	633334	135	69	DSI4	Ant5	1	50	21.50	20.91	-0.04	0.422	1.000	1.146	0.48
	n77 PC2	DFT-QPSK100M	Front Face	2	633334	1	137	DSI2	Ant5	1	50	26.00	25.31	0.01	0.305	1.000	1.172	0.36
	n77 PC2	DFT-QPSK100M	Rear Face	2	633334	1	137	DSI2	Ant5	1	50	26.00	25.31	-0.16	0.519	1.000	1.172	0.61
	n77 PC2	DFT-QPSK100M	Front Face	2	633334	135	69	DSI2	Ant5	1	50	26.00	25.46	-0.02	0.327	1.000	1.132	0.37
	n77 PC2	DFT-QPSK100M	Rear Face	2	633334	135	69	DSI2	Ant5	1	50	26.00	25.46	0.05	0.532	1.000	1.132	0.60
	n77 PC2 (ENDC Only)	DFT-QPSK100M	Front Face	1	633334	1	137	DSI4	Ant5	1	50	19.00	18.13	-0.12	0.149	1.000	1.222	0.18
	n77 PC2 (ENDC Only)	DFT-QPSK100M	Rear Face	1	633334	1	137	DSI4	Ant5	1	50	19.00	18.13	-0.01	0.244	1.000	1.222	0.30
	n77 PC2 (ENDC Only)	DFT-QPSK100M	Front Face	1	633334	135	69	DSI4	Ant5	1	50	19.00	18.32	0.15	0.156	1.000	1.169	0.18
	n77 PC2 (ENDC Only)	DFT-QPSK100M	Rear Face	1	633334	135	69	DSI4	Ant5	1	50	19.00	18.32	0.19	0.232	1.000	1.169	0.27
	n77 PC2	DFT-QPSK100M	Front Face	1	662000	1	137	DSI4	Ant5	1	50	21.50	20.76	-0.11	0.162	1.000	1.186	0.19
	n77 PC2	DFT-QPSK100M	Rear Face	1	662000	1	137	DSI4	Ant5	1	50	21.50	20.76	-0.07	0.235	1.000	1.186	0.28
	n77 PC2	DFT-QPSK100M	Front Face	1	662000	135	69	DSI4	Ant5	1	50	21.50	20.93	-0.10	0.170	1.000	1.140	0.19
	n77 PC2	DFT-QPSK100M	Rear Face	1	662000	135	69	DSI4	Ant5	1	50	21.50	20.93	-0.08	0.258	1.000	1.140	0.29
	n77 PC2	DFT-QPSK100M	Front Face	2	662000	1	137	DSI2	Ant5	1	50	26.00	25.45	-0.02	0.184	1.000	1.135	0.21
	n77 PC2	DFT-QPSK100M	Rear Face	2	662000	1	137	DSI2	Ant5	1	50	26.00	25.45	0.16	0.279	1.000	1.135	0.32
	n77 PC2	DFT-QPSK100M	Front Face	2	662000	135	69	DSI2	Ant5	1	50	26.00	25.54	0.10	0.187	1.000	1.112	0.21
	n77 PC2	DFT-QPSK100M	Rear Face	2	662000	135	69	DSI2	Ant5	1	50	26.00	25.54	0.03	0.289	1.000	1.112	0.32
	n77 PC2 (ENDC Only)	DFT-QPSK100M	Front Face	1	662000	1	137	DSI4	Ant5	1	50	19.00	18.26	0.04	0.094	1.000	1.186	0.11
	n77 PC2 (ENDC Only)	DFT-QPSK100M	Rear Face	1	662000	1	137	DSI4	Ant5	1	50	19.00	18.26	0.16	0.150	1.000	1.186	0.18
	n77 PC2 (ENDC Only)	DFT-QPSK100M	Front Face	1	662000	135	69	DSI4	Ant5	1	50	19.00	18.43	-0.04	0.096	1.000	1.140	0.11
	n77 PC2 (ENDC Only)	DFT-QPSK100M	Rear Face	1	662000	135	69	DSI4	Ant5	1	50	19.00	18.43	0.15	0.144	1.000	1.140	0.16
	n77	DFT-QPSK100M	Front Face	1	633334	1	137	DSI2	Ant7	1	100	20.50	19.78	0.02	0.088	1.000	1.180	0.10
	n77	DFT-QPSK100M	Rear Face	1	633334	1	137	DSI2	Ant7	1	100	20.50	19.78	0.14	0.286	1.000	1.180	0.34
	n77	DFT-QPSK100M	Front Face	1	633334	135	69	DSI2	Ant7	1	100	20.50	19.90	-0.11	0.083	1.000	1.148	0.10
	n77	DFT-QPSK100M	Rear Face	1	633334	135	69	DSI2	Ant7	1	100	20.50	19.90	0.17	0.321	1.000	1.148	0.37
	n77 (ENDC Only)	DFT-QPSK100M	Front Face	1	633334	1	137	DSI2	Ant7	1	100	18.50	17.53	-0.02	0.063	1.000	1.250	0.08
	n77 (ENDC Only)	DFT-QPSK100M	Rear Face	1	633334	1	137	DSI2	Ant7	1	100	18.50	17.53	0.12	0.179	1.000	1.250	0.22
	n77 (ENDC Only)	DFT-QPSK100M	Front Face	1	633334	135	69	DSI2	Ant7	1	100	18.50	17.78	-0.06	0.052	1.000	1.180	0.06
	n77 (ENDC Only)	DFT-QPSK100M	Rear Face	1	633334	135	69	DSI2	Ant7	1	100	18.50	17.78	0.08	0.200	1.000	1.180	0.24
	n77	DFT-QPSK100M	Front Face	1	662000	1	137	DSI2	Ant7	1	100	20.50	19.65	-0.06	0.164	1.000	1.216	0.20
	n77	DFT-QPSK100M	Rear Face	1	662000	1	137	DSI2	Ant7	1	100	20.50	19.65	0.13	0.774	1.000	1.216	0.94
	n77	DFT-QPSK100M	Front Face	1	662000	135	69	DSI2	Ant7	1	100	20.50	19.97	0.05	0.150	1.000	1.130	0.17
P53	n77	DFT-QPSK100M	Rear Face	1	662000	135	69	DSI2	Ant7	1	100	20.50	19.97	-0.01	0.855	1.000	1.130	0.97
	n77	DFT-QPSK100M	Rear Face	1	650000	1	137	DSI2	Ant7	1	100	20.50	19.56	0.08	0.546	1.000	1.242	0.68
	n77	DFT-QPSK100M	Rear Face	1	656000	1	137	DSI2	Ant7	1	100	20.50	19.63	0.01	0.499	1.000	1.222	0.61
	n77	DFT-QPSK100M	Rear Face	1	650000	135	69	DSI2	Ant7	1	100	20.50	19.80	-0.01	0.553	1.000	1.175	0.65
	n77	DFT-QPSK100M	Rear Face	1	656000	135	69	DSI2	Ant7	1	100	20.50	19.65	0.17	0.507	1.000	1.216	0.62
	n77	DFT-QPSK100M	Rear Face	1	662000	270	0	DSI2	Ant7	1	100	20.50	19.68	0.13	0.712	1.000	1.208	0.86
	n77 (ENDC Only)	DFT-QPSK100M	Front Face	1	662000	1	137	DSI2	Ant7	1	100	18.50	17.78	-0.16	0.084	1.000	1.180	0.10
	n77 (ENDC Only)	DFT-QPSK100M	Rear Face	1	662000	1	137	DSI2	Ant7	1	100	18.50	17.78	0.04	0.579	1.000	1.180	0.68
	n77 (ENDC Only)	DFT-QPSK100M	Front Face	1	662000	135	69	DSI2	Ant7	1	100	18.50	17.99	0.10	0.096	1.000	1.125	0.11
	n77 (ENDC Only)	DFT-QPSK100M	Rear Face	1	662000	135	69	DSI2	Ant7	1	100	18.50	17.99	-0.04	0.603	1.000	1.125	0.68
	WLAN2.4G	802.11b	Front Face	1	6	-	-	DSI2	Ant6	1	100	18.50	16.81	0.15	0.130	1.000	1.476	0.19
P54	WLAN2.4G	802.11b	Rear Face	1	6	-	-	DSI2	Ant6	1	100	18.50	16.81	-0.06	0.157	1.000	1.476	0.23
P55	WLAN5G	802.11n-HT20	Front Face	1	60	-	-	DSI2	Ant6	1	97.27	16.00	14.49	-0.03	0.124	1.028	1.416	0.18
	WLAN5G	802.11n-HT20	Rear Face	1	60	-	-	DSI2	Ant6	1	97.27	16.00	14.49	-0.04	0.060	1.028	1.416	0.09
	WLAN5G	802.11n-HT20	Front Face	1	140	-	-	DSI2	Ant6	1	97.27	16.00	14.82	-0.10	0.128	1.028	1.312	0.17
P56	WLAN5G	802.11n-HT20	Rear Face	1	140	-	-	DSI2	Ant6	1	97.27	16.00	14.82	-0.07	0.149	1.028	1.312	0.20
	WLAN5G	802.11n-HT20	Front Face	1	149	-	-	DSI2	Ant6	1	97.3	16.00	14.44	-0.11	0.136	1.028	1.432	0.20
P57	WLAN5G	802.11n-HT20	Rear Face	1	149	-	-	DSI2	Ant6	1	97.3	16.00	14.44	-0.09	0.160	1.028	1.432	0.24
	WLAN5G	802.11n-HT20	Rear Face	1	149	-	-	DSI2	Ant6	2	97.3	16.00	14.44	0.16	0.151	1.028	1.432	0.22
	WLAN5G	802.11n-HT20	Rear Face	1	149	-	-	DSI2	Ant6	3	97.3	16.00	14.44	0.14	0.155	1.028	1.432	0.23
	BT	GFSK	Front Face	1	39	-	-	DSI2	Ant6	1	76.67	12.00	10.15	0.00	0.000	1.304	1.531	0.00
P58	BT	GFSK	Rear Face	1	39	-	-	DSI2	Ant6	1	76.67	12.00	10.15	0.06	0.022	1.304	1.531	0.04

4.6.4 SAR Results for Hotspot Exposure Condition (Separation Distance is 1.0 cm Gap)

Plot No.	Band	Mode	Test Position	Separation Distance (cm)	Ch.	RB#	RB Offset	Power State	Antenna	Sample	Duty Cycle %	Max. Tune-up Power (dBm)	Measured Conducted Power (dBm)	Power Drift (dB)	Measured SAR-1g (W/kg)	Duty Cycle Scaling Factor	Tune-up Scaling Factor	Scaled SAR-1g (W/kg)
P59	GSM850	GPRS 2Tx Slot	Front Face	1	189	-	-	DSI3/4	Ant1	1	-	31.00	30.65	-0.02	0.198	1.000	1.084	0.21
	GSM850	GPRS 2Tx Slot	Rear Face	1	189	-	-	DSI3/4	Ant1	1	-	31.00	30.65	0.01	0.278	1.000	1.084	0.30
	GSM850	GPRS 2Tx Slot	Left Side	1	189	-	-	DSI2	Ant1	1	-	31.00	30.65	-0.06	0.122	1.000	1.084	0.13
	GSM850	GPRS 2Tx Slot	Right Side	1	189	-	-	DSI2	Ant1	1	-	31.00	30.65	0.17	0.249	1.000	1.084	0.27
	GSM850	GPRS 2Tx Slot	Bottom Side	1	189	-	-	DSI3/4	Ant1	1	-	31.00	30.65	-0.09	0.251	1.000	1.084	0.27
	GSM850	GPRS 2Tx Slot	Front Face	1	189	-	-	DSI4	Ant4	1	-	31.00	29.88	0.12	0.109	1.000	1.294	0.14
	GSM850	GPRS 2Tx Slot	Rear Face	1	189	-	-	DSI4	Ant4	1	-	31.00	29.88	-0.02	0.115	1.000	1.294	0.15
	GSM850	GPRS 2Tx Slot	Left Side	1	189	-	-	DSI2	Ant4	1	-	31.00	29.88	0.02	0.110	1.000	1.294	0.14
	GSM850	GPRS 2Tx Slot	Right Side	1	189	-	-	DSI2	Ant4	1	-	31.00	29.88	-0.14	0.090	1.000	1.294	0.12
GSM850	GPRS 2Tx Slot	Top Side	1	189	-	-	DSI4	Ant4	1	-	31.00	29.88	0.15	0.129	1.000	1.294	0.17	
GSM1900	GPRS 3Tx Slot	Front Face	1	810	-	-	DSI3/4	Ant1	1	-	25.00	24.32	0.19	0.363	1.000	1.169	0.42	
GSM1900	GPRS 3Tx Slot	Rear Face	1	810	-	-	DSI3/4	Ant1	1	-	25.00	24.32	-0.06	0.367	1.000	1.169	0.43	
GSM1900	GPRS 3Tx Slot	Left Side	1	810	-	-	DSI2	Ant1	1	-	26.50	25.93	0.00	0.000	1.000	1.140	0.00	
GSM1900	GPRS 3Tx Slot	Right Side	1	810	-	-	DSI2	Ant1	1	-	26.50	25.93	-0.10	0.060	1.000	1.140	0.07	
GSM1900	GPRS 3Tx Slot	Bottom Side	1	810	-	-	DSI3/4	Ant1	1	-	25.00	24.32	-0.07	0.906	1.000	1.169	1.06	
GSM1900	GPRS 3Tx Slot	Front Face	2	810	-	-	DSI2	Ant1	1	-	26.50	25.93	-0.03	0.238	1.000	1.140	0.27	
GSM1900	GPRS 3Tx Slot	Rear Face	2	810	-	-	DSI2	Ant1	1	-	26.50	25.93	-0.17	0.278	1.000	1.140	0.32	
GSM1900	GPRS 3Tx Slot	Bottom Side	2	810	-	-	DSI2	Ant1	1	-	26.50	25.93	-0.02	0.570	1.000	1.140	0.65	
GSM1900	GPRS 3Tx Slot	Bottom Side	1	512	-	-	DSI3/4	Ant1	1	-	25.00	24.22	0.09	0.791	1.000	1.197	0.95	
P60	GSM1900	GPRS 3Tx Slot	Bottom Side	1	661	-	-	DSI3/4	Ant1	1	-	25.00	24.28	-0.08	0.921	1.000	1.180	1.09
	GSM1900	GPRS 3Tx Slot	Bottom Side	1	661	-	-	DSI3/4	Ant1	2	-	25.00	24.28	-0.17	0.854	1.000	1.180	1.01
	GSM1900	GPRS 3Tx Slot	Bottom Side	1	661	-	-	DSI3/4	Ant1	3	-	25.00	24.28	-0.13	0.901	1.000	1.180	1.06
	GSM1900	GPRS 3Tx Slot	Front Face	1	810	-	-	DSI4	Ant4	1	-	25.00	23.91	-0.14	0.266	1.000	1.285	0.34
	GSM1900	GPRS 3Tx Slot	Rear Face	1	810	-	-	DSI4	Ant4	1	-	25.00	23.91	0.01	0.315	1.000	1.285	0.40
	GSM1900	GPRS 3Tx Slot	Left Side	1	810	-	-	DSI2	Ant4	1	-	26.00	24.76	-0.03	0.089	1.000	1.330	0.12
	GSM1900	GPRS 3Tx Slot	Right Side	1	810	-	-	DSI2	Ant4	1	-	26.00	24.76	-0.15	0.036	1.000	1.330	0.05
	GSM1900	GPRS 3Tx Slot	Top Side	1	810	-	-	DSI4	Ant4	1	-	25.00	23.91	0.02	0.562	1.000	1.285	0.72
	GSM1900	GPRS 3Tx Slot	Front Face	2	810	-	-	DSI2	Ant4	1	-	26.00	24.76	-0.03	0.143	1.000	1.330	0.19
	GSM1900	GPRS 3Tx Slot	Rear Face	2	810	-	-	DSI2	Ant4	1	-	26.00	24.76	-0.02	0.247	1.000	1.330	0.33
	GSM1900	GPRS 3Tx Slot	Top Side	2	810	-	-	DSI2	Ant4	1	-	26.00	24.76	-0.15	0.345	1.000	1.330	0.46
WCDMA II	RMC12.2K	Front Face	1	9400	-	-	DSI3/4	Ant1	1	-	20.00	19.17	-0.18	0.298	1.000	1.211	0.36	
WCDMA II	RMC12.2K	Rear Face	1	9400	-	-	DSI3/4	Ant1	1	-	20.00	19.17	0.06	0.321	1.000	1.211	0.39	
WCDMA II	RMC12.2K	Left Side	1	9400	-	-	DSI2	Ant1	1	-	25.00	24.04	0.00	0.000	1.000	1.247	0.00	
WCDMA II	RMC12.2K	Right Side	1	9400	-	-	DSI2	Ant1	1	-	25.00	24.04	0.14	0.082	1.000	1.247	0.10	
WCDMA II	RMC12.2K	Bottom Side	1	9400	-	-	DSI3/4	Ant1	1	-	20.00	19.17	0.02	0.669	1.000	1.211	0.81	
WCDMA II	RMC12.2K	Front Face	2	9400	-	-	DSI2	Ant1	1	-	25.00	24.04	-0.12	0.218	1.000	1.247	0.27	
WCDMA II	RMC12.2K	Rear Face	2	9400	-	-	DSI2	Ant1	1	-	25.00	24.04	-0.03	0.259	1.000	1.247	0.32	
WCDMA II	RMC12.2K	Bottom Side	2	9400	-	-	DSI2	Ant1	1	-	25.00	24.04	0.11	0.497	1.000	1.247	0.62	
WCDMA II	RMC12.2K	Bottom Side	1	9262	-	-	DSI3/4	Ant1	1	-	20.00	19.03	-0.19	0.494	1.000	1.250	0.62	
WCDMA II	RMC12.2K	Bottom Side	1	9538	-	-	DSI3/4	Ant1	1	-	20.00	18.99	0.01	0.650	1.000	1.262	0.82	
WCDMA II	RMC12.2K	Front Face	1	9400	-	-	DSI4	Ant4	1	-	20.50	19.20	-0.14	0.386	1.000	1.349	0.52	
WCDMA II	RMC12.2K	Rear Face	1	9400	-	-	DSI4	Ant4	1	-	20.50	19.20	-0.06	0.652	1.000	1.349	0.88	
WCDMA II	RMC12.2K	Left Side	1	9400	-	-	DSI2	Ant4	1	-	24.50	23.13	0.16	0.220	1.000	1.371	0.30	
WCDMA II	RMC12.2K	Right Side	1	9400	-	-	DSI2	Ant4	1	-	24.50	23.13	-0.17	0.065	1.000	1.371	0.09	
P61	WCDMA II	RMC12.2K	Top Side	1	9400	-	-	DSI4	Ant4	1	-	20.50	19.20	0.05	0.753	1.000	1.349	1.02
	WCDMA II	RMC12.2K	Front Face	2	9400	-	-	DSI2	Ant4	1	-	24.50	23.13	-0.10	0.199	1.000	1.371	0.27
	WCDMA II	RMC12.2K	Rear Face	2	9400	-	-	DSI2	Ant4	1	-	24.50	23.13	-0.13	0.338	1.000	1.371	0.46
	WCDMA II	RMC12.2K	Top Side	2	9400	-	-	DSI2	Ant4	1	-	24.50	23.13	0.09	0.456	1.000	1.371	0.63
	WCDMA II	RMC12.2K	Rear Face	1	9262	-	-	DSI4	Ant4	1	-	20.50	19.17	-0.16	0.588	1.000	1.358	0.80
	WCDMA II	RMC12.2K	Rear Face	1	9538	-	-	DSI4	Ant4	1	-	20.50	19.18	0.17	0.512	1.000	1.355	0.69
	WCDMA II	RMC12.2K	Top Side	1	9262	-	-	DSI4	Ant4	1	-	20.50	19.17	0.03	0.715	1.000	1.358	0.97
WCDMA II	RMC12.2K	Top Side	1	9538	-	-	DSI4	Ant4	1	-	20.50	19.18	0.18	0.702	1.000	1.355	0.95	
WCDMA IV	RMC12.2K	Front Face	1	1413	-	-	DSI3/4	Ant1	1	-	20.00	19.06	0.18	0.320	1.000	1.242	0.40	
WCDMA IV	RMC12.2K	Rear Face	1	1413	-	-	DSI3/4	Ant1	1	-	20.00	19.06	0.17	0.399	1.000	1.242	0.50	
WCDMA IV	RMC12.2K	Left Side	1	1413	-	-	DSI2	Ant1	1	-	25.00	24.04	0.00	0.000	1.000	1.247	0.00	
WCDMA IV	RMC12.2K	Right Side	1	1413	-	-	DSI2	Ant1	1	-	25.00	24.04	-0.04	0.098	1.000	1.247	0.12	
P62	WCDMA IV	RMC12.2K	Bottom Side	1	1413	-	-	DSI3/4	Ant1	1	-	20.00	19.06	0.01	0.719	1.000	1.242	0.89
	WCDMA IV	RMC12.2K	Front Face	2	1413	-	-	DSI2	Ant1	1	-	25.00	24.04	0.06	0.227	1.000	1.247	0.28
	WCDMA IV	RMC12.2K	Rear Face	2	1413	-	-	DSI2	Ant1	1	-	25.00	24.04	-0.05	0.282	1.000	1.247	0.35
	WCDMA IV	RMC12.2K	Bottom Side	2	1413	-	-	DSI2	Ant1	1	-	25.00	24.04	0.20	0.467	1.000	1.247	0.58
	WCDMA IV	RMC12.2K	Bottom Side	1	1312	-	-	DSI3/4	Ant1	1	-	20.00	18.79	-0.01	0.563	1.000	1.321	0.74
	WCDMA IV	RMC12.2K	Bottom Side	1	1513	-	-	DSI3/4	Ant1	1	-	20.00	18.95	-0.18	0.592	1.000	1.274	0.75
	WCDMA IV	RMC12.2K	Front Face	1	1413	-	-	DSI4	Ant4	1	-	22.50	21.52	0.11	0.325	1.000	1.253	0.41
	WCDMA IV	RMC12.2K	Rear Face	1	1413	-	-	DSI4	Ant4	1	-	22.50	21.52	-0.09	0.530	1.000	1.253	0.66
	WCDMA IV	RMC12.2K	Left Side	1	1413	-	-	DSI2	Ant4	1	-	24.50	23.33	0.03	0.158	1.000	1.309	0.21
	WCDMA IV	RMC12.2K	Right Side	1	1413	-	-	DSI2	Ant4	1	-	24.50	23.33	0.14	0.101	1.000	1.309	0.13
	WCDMA IV	RMC12.2K	Top Side	1	1413	-	-	DSI4	Ant4	1	-	22.50	21.52	0.16	0.590	1.000	1.253	0.74
WCDMA IV	RMC12.2K	Front Face	2	1413	-	-	DSI2	Ant4	1	-	24.50	23.33	-0.08	0.240	1.000	1.309	0.31	
WCDMA IV	RMC12.2K	Rear Face	2	1413	-	-	DSI2	Ant4	1	-	24.50	23.33	0.03	0.355	1.000	1.309	0.46	
WCDMA IV	RMC12.2K	Top Side	2	1413	-	-	DSI2	Ant4	1	-	24.50	23.33	-0.11	0.420	1.000	1.309	0.55	
WCDMA V	RMC12.2K	Front Face	1	4233	-	-	DSI3/4	Ant1	1	-	25.00	23.82	-0.02	0.204	1.000	1.312	0.27	



BUREAU VERITAS

FCC SAR Test Report



Certificate #6613.01

Plot No.	Band	Mode	Test Position	Separation Distance (cm)	Ch.	RB#	RB Offset	Power State	Antenna	Sample	Duty Cycle %	Max. Tune-up Power (dBm)	Measured Conducted Power (dBm)	Power Drift (dB)	Measured SAR-1g (W/kg)	Duty Cycle Scaling Factor	Tune-up Scaling Factor	Scaled SAR-1g (W/kg)
P63	WCDMA V	RMC12.2K	Rear Face	1	4233	-	-	DSI3/4	Ant1	1	-	25.00	23.82	0.04	0.274	1.000	1.312	0.36
	WCDMA V	RMC12.2K	Left Side	1	4233	-	-	DSI2	Ant1	1	-	25.00	23.82	0.03	0.000	1.000	1.312	0.00
	WCDMA V	RMC12.2K	Right Side	1	4233	-	-	DSI2	Ant1	1	-	25.00	23.82	-0.06	0.087	1.000	1.312	0.11
	WCDMA V	RMC12.2K	Bottom Side	1	4233	-	-	DSI3/4	Ant1	1	-	25.00	23.82	0.20	0.227	1.000	1.312	0.30
	WCDMA V	RMC12.2K	Front Face	1	4233	-	-	DSI4	Ant4	1	-	25.00	23.32	-0.14	0.139	1.000	1.472	0.20
	WCDMA V	RMC12.2K	Rear Face	1	4233	-	-	DSI4	Ant4	1	-	25.00	23.32	0.01	0.206	1.000	1.472	0.30
	WCDMA V	RMC12.2K	Left Side	1	4233	-	-	DSI2	Ant4	1	-	25.00	23.32	0.03	0.089	1.000	1.472	0.13
	WCDMA V	RMC12.2K	Right Side	1	4233	-	-	DSI2	Ant4	1	-	25.00	23.32	-0.13	0.050	1.000	1.472	0.07
	WCDMA V	RMC12.2K	Top Side	1	4233	-	-	DSI4	Ant4	1	-	25.00	23.32	0.15	0.163	1.000	1.472	0.24
	LTE 2	QPSK20M	Front Face	1	18900	1	50	DSI3/4	Ant1	1	-	19.50	18.96	0.12	0.285	1.000	1.132	0.32
	LTE 2	QPSK20M	Rear Face	1	18900	1	50	DSI3/4	Ant1	1	-	19.50	18.96	0.07	0.306	1.000	1.132	0.35
	LTE 2	QPSK20M	Left Side	1	18900	1	50	DSI2	Ant1	1	-	25.00	24.30	0.09	0.085	1.000	1.175	0.10
	LTE 2	QPSK20M	Right Side	1	18900	1	50	DSI2	Ant1	1	-	25.00	24.30	-0.05	0.139	1.000	1.175	0.16
	LTE 2	QPSK20M	Bottom Side	1	18900	1	50	DSI3/4	Ant1	1	-	19.50	18.96	0.15	0.641	1.000	1.132	0.73
	LTE 2	QPSK20M	Front Face	1	18900	50	25	DSI3/4	Ant1	1	-	19.50	18.85	-0.19	0.301	1.000	1.161	0.35
	LTE 2	QPSK20M	Rear Face	1	18900	50	25	DSI3/4	Ant1	1	-	19.50	18.85	-0.13	0.307	1.000	1.161	0.36
	LTE 2	QPSK20M	Left Side	1	18900	50	25	DSI2	Ant1	1	-	24.00	23.33	-0.09	0.060	1.000	1.167	0.07
	LTE 2	QPSK20M	Right Side	1	18900	50	25	DSI2	Ant1	1	-	24.00	23.33	-0.14	0.101	1.000	1.167	0.12
	LTE 2	QPSK20M	Bottom Side	1	18900	50	25	DSI3/4	Ant1	1	-	19.50	18.85	0.10	0.647	1.000	1.161	0.75
	LTE 2	QPSK20M	Front Face	2	18900	1	50	DSI2	Ant1	1	-	25.00	24.30	0.15	0.222	1.000	1.175	0.26
	LTE 2	QPSK20M	Rear Face	2	18900	1	50	DSI2	Ant1	1	-	25.00	24.30	0.09	0.271	1.000	1.175	0.32
	LTE 2	QPSK20M	Bottom Side	2	18900	1	50	DSI2	Ant1	1	-	25.00	24.30	-0.15	0.517	1.000	1.175	0.61
	LTE 2	QPSK20M	Front Face	2	18900	50	25	DSI2	Ant1	1	-	24.00	23.33	0.11	0.183	1.000	1.167	0.21
	LTE 2	QPSK20M	Rear Face	2	18900	50	25	DSI2	Ant1	1	-	24.00	23.33	0.18	0.216	1.000	1.167	0.25
	LTE 2	QPSK20M	Bottom Side	2	18900	50	25	DSI2	Ant1	1	-	24.00	23.33	-0.07	0.411	1.000	1.167	0.48
	LTE 2	QPSK20M	Front Face	1	18900	1	50	DSI4	Ant4	1	-	18.50	17.28	0.12	0.279	1.000	1.324	0.37
	LTE 2	QPSK20M	Rear Face	1	18900	1	50	DSI4	Ant4	1	-	18.50	17.28	0.07	0.433	1.000	1.324	0.57
	LTE 2	QPSK20M	Left Side	1	18900	1	50	DSI2	Ant4	1	-	24.50	23.16	-0.10	0.252	1.000	1.361	0.34
	LTE 2	QPSK20M	Right Side	1	18900	1	50	DSI2	Ant4	1	-	24.50	23.16	0.13	0.085	1.000	1.361	0.12
	LTE 2	QPSK20M	Top Side	1	18900	1	50	DSI4	Ant4	1	-	18.50	17.28	0.14	0.535	1.000	1.324	0.71
	LTE 2	QPSK20M	Front Face	1	18900	50	0	DSI4	Ant4	1	-	18.50	17.18	0.14	0.268	1.000	1.355	0.36
	LTE 2	QPSK20M	Rear Face	1	18900	50	0	DSI4	Ant4	1	-	18.50	17.18	0.12	0.443	1.000	1.355	0.60
	LTE 2	QPSK20M	Left Side	1	18900	50	0	DSI2	Ant4	1	-	23.50	22.19	0.04	0.214	1.000	1.352	0.29
	LTE 2	QPSK20M	Right Side	1	18900	50	0	DSI2	Ant4	1	-	23.50	22.19	0.00	0.070	1.000	1.352	0.09
P64	LTE 2	QPSK20M	Top Side	1	18900	50	0	DSI4	Ant4	1	-	18.50	17.18	0.02	0.563	1.000	1.355	0.76
	LTE 2	QPSK20M	Front Face	2	18900	1	50	DSI2	Ant4	1	-	24.50	23.16	0.04	0.248	1.000	1.361	0.34
	LTE 2	QPSK20M	Rear Face	2	18900	1	50	DSI2	Ant4	1	-	24.50	23.16	0.18	0.408	1.000	1.361	0.56
	LTE 2	QPSK20M	Top Side	2	18900	1	50	DSI2	Ant4	1	-	24.50	23.16	-0.07	0.539	1.000	1.361	0.73
	LTE 2	QPSK20M	Front Face	2	18900	50	0	DSI2	Ant4	1	-	23.50	22.19	0.02	0.195	1.000	1.352	0.26
	LTE 2	QPSK20M	Rear Face	2	18900	50	0	DSI2	Ant4	1	-	23.50	22.19	-0.18	0.334	1.000	1.352	0.45
	LTE 2	QPSK20M	Top Side	2	18900	50	0	DSI2	Ant4	1	-	23.50	22.19	0.14	0.450	1.000	1.352	0.61
	LTE 2	QPSK20M	Front Face	1	18700	1	50	DSI4	Ant3	1	-	18.00	17.04	0.12	0.064	1.000	1.247	0.08
	LTE 2	QPSK20M	Rear Face	1	18700	1	50	DSI4	Ant3	1	-	18.00	17.04	0.07	0.079	1.000	1.247	0.10
	LTE 2	QPSK20M	Left Side	1	18700	1	50	DSI4	Ant3	1	-	18.00	17.04	-0.03	0.139	1.000	1.247	0.17
	LTE 2	QPSK20M	Top Side	1	18700	1	50	DSI2	Ant3	1	-	25.00	23.86	-0.20	0.040	1.000	1.300	0.05
	LTE 2	QPSK20M	Front Face	1	18700	50	25	DSI4	Ant3	1	-	18.00	16.78	-0.07	0.051	1.000	1.324	0.07
	LTE 2	QPSK20M	Rear Face	1	18700	50	25	DSI4	Ant3	1	-	18.00	16.78	0.16	0.077	1.000	1.324	0.10
	LTE 2	QPSK20M	Left Side	1	18700	50	25	DSI4	Ant3	1	-	18.00	16.78	-0.07	0.146	1.000	1.324	0.19
	LTE 2	QPSK20M	Top Side	1	18700	50	25	DSI2	Ant3	1	-	24.00	22.87	0.00	0.000	1.000	1.297	0.00
	LTE 2	QPSK20M	Front Face	2	18700	1	50	DSI2	Ant3	1	-	25.00	23.86	0.03	0.067	1.000	1.300	0.09
	LTE 2	QPSK20M	Rear Face	2	18700	1	50	DSI2	Ant3	1	-	25.00	23.86	-0.01	0.078	1.000	1.300	0.10
	LTE 2	QPSK20M	Left Side	1.5	18700	1	50	DSI2	Ant3	1	-	25.00	23.86	-0.06	0.261	1.000	1.300	0.34
	LTE 2	QPSK20M	Front Face	2	18700	50	25	DSI2	Ant3	1	-	24.00	22.87	-0.08	0.055	1.000	1.297	0.07
	LTE 2	QPSK20M	Rear Face	2	18700	50	25	DSI2	Ant3	1	-	24.00	22.87	0.19	0.065	1.000	1.297	0.08
	LTE 2	QPSK20M	Left Side	1.5	18700	50	25	DSI2	Ant3	1	-	24.00	22.87	-0.09	0.210	1.000	1.297	0.27
	LTE 7	QPSK20M	Front Face	1	21100	1	50	DSI3/4	Ant1	1	-	23.50	22.65	0.09	0.426	1.000	1.216	0.52
	LTE 7	QPSK20M	Rear Face	1	21100	1	50	DSI3/4	Ant1	1	-	23.50	22.65	0.04	0.439	1.000	1.216	0.53
	LTE 7	QPSK20M	Left Side	1	21100	1	50	DSI2	Ant1	1	-	25.00	24.01	-0.03	0.177	1.000	1.256	0.22
	LTE 7	QPSK20M	Right Side	1	21100	1	50	DSI2	Ant1	1	-	25.00	24.01	-0.09	0.206	1.000	1.256	0.26
	LTE 7	QPSK20M	Bottom Side	1	21100	1	50	DSI3/4	Ant1	1	-	23.50	22.65	-0.08	0.701	1.000	1.216	0.85
	LTE 7	QPSK20M	Front Face	1	21100	50	25	DSI3/4	Ant1	1	-	23.50	22.54	-0.04	0.466	1.000	1.247	0.58
	LTE 7	QPSK20M	Rear Face	1	21100	50	25	DSI3/4	Ant1	1	-	23.50	22.54	-0.07	0.432	1.000	1.247	0.54
	LTE 7	QPSK20M	Left Side	1	21100	50	25	DSI2	Ant1	1	-	24.00	23.05	0.12	0.141	1.000	1.245	0.18
	LTE 7	QPSK20M	Right Side	1	21100	50	25	DSI2	Ant1	1	-	24.00	23.05	0.12	0.170	1.000	1.245	0.21
	LTE 7	QPSK20M	Bottom Side	1	21100	50	25	DSI3/4	Ant1	1	-	23.50	22.54	0.15	0.754	1.000	1.247	0.94
	LTE 7	QPSK20M	Front Face	2	21100	1	50	DSI2	Ant1	1	-	25.00	24.01	0.11	0.230	1.000	1.256	0.29
	LTE 7	QPSK20M	Rear Face	2	21100	1	50	DSI2	Ant1	1	-	25.00	24.01	-0.06	0.244	1.000	1.256	0.31
	LTE 7	QPSK20M	Bottom Side	2	21100	1	50	DSI2	Ant1	1	-	25.00	24.01	0.04	0.293	1.000	1.256	0.37
	LTE 7	QPSK20M	Front Face	2	21100	50	25	DSI2	Ant1	1	-	24.00	23.05	0.08	0.176	1.000	1.245	0.22
	LTE 7	QPSK20M	Rear Face	2	21100	50	25	DSI2	Ant1	1	-	24.00	23.05	-0.12	0.191	1.000	1.245	0.24
	LTE 7	QPSK20M	Bottom Side	2	21100	50	25	DSI2	Ant1	1	-	24.00	23.05	-0.05	0.228	1.000	1.245	0.28
	LTE 7	QPSK20M	Bottom Side	1	20850	1	50	DSI3/4	Ant1	1	-	23.50	22.58	-0.08	0.656	1.000	1.236	0.81
P65	LTE 7	QPSK20M	Bottom Side	1	21350	1	50	DSI3/4	Ant1	1	-	23.50	22.42	-0.04	0.780	1.000	1.282	1.00
	LTE 7	QPSK20M	Bottom Side	1	20850	50	25	DSI3/4	Ant1	1	-	23.50	22.42	-0.06	0.663	1.000	1.282	0.85
	LTE 7	QPSK20M	Bottom Side	1	21350	50	25	DSI3/4	Ant1	1	-	23.50	22.36	-0.03	0.735	1.000	1.300	0.96



BUREAU VERITAS

FCC SAR Test Report



Certificate #6613.01

Plot No.	Band	Mode	Test Position	Separation Distance (cm)	Ch.	RB#	RB Offset	Power State	Antenna	Sample	Duty Cycle %	Max. Tune-up Power (dBm)	Measured Conducted Power (dBm)	Power Drift (dB)	Measured SAR-1g (W/kg)	Duty Cycle Scaling Factor	Tune-up Scaling Factor	Scaled SAR-1g (W/kg)
	LTE 7	QPSK20M	Bottom Side	1	21100	100	0	DSI3/4	Ant1	1	-	23.50	22.52	-0.20	0.709	1.000	1.253	0.89
	LTE 7C	QPSK20M	Bottom Side	1	PCC:21001 SCC:21199	PCC:1 SCC:1	PCC:99 SCC:0	DSI3/4	Ant1	1	-	23.50	22.89	0.03	0.751	1.000	1.151	0.86
	LTE 7	QPSK20M	Front Face	1	20850	1	50	DSI4	Ant4	1	-	19.00	17.99	-0.08	0.236	1.000	1.262	0.30
	LTE 7	QPSK20M	Rear Face	1	20850	1	50	DSI4	Ant4	1	-	19.00	17.99	0.02	0.409	1.000	1.262	0.52
	LTE 7	QPSK20M	Left Side	1	20850	1	50	DSI2	Ant4	1	-	24.50	23.01	-0.06	0.218	1.000	1.409	0.31
	LTE 7	QPSK20M	Right Side	1	20850	1	50	DSI2	Ant4	1	-	24.50	23.01	-0.07	0.095	1.000	1.409	0.13
	LTE 7	QPSK20M	Top Side	1	20850	1	50	DSI4	Ant4	1	-	19.00	17.99	0.14	0.537	1.000	1.262	0.68
	LTE 7	QPSK20M	Front Face	1	20850	50	25	DSI4	Ant4	1	-	19.00	17.80	-0.03	0.202	1.000	1.318	0.27
	LTE 7	QPSK20M	Rear Face	1	20850	50	25	DSI4	Ant4	1	-	19.00	17.80	-0.10	0.417	1.000	1.318	0.55
	LTE 7	QPSK20M	Left Side	1	20850	50	25	DSI2	Ant4	1	-	23.50	21.98	0.14	0.175	1.000	1.419	0.25
	LTE 7	QPSK20M	Right Side	1	20850	50	25	DSI2	Ant4	1	-	23.50	21.98	-0.09	0.075	1.000	1.419	0.11
	LTE 7	QPSK20M	Top Side	1	20850	50	25	DSI4	Ant4	1	-	19.00	17.80	0.03	0.538	1.000	1.318	0.71
	LTE 7	QPSK20M	Front Face	2	20850	1	50	DSI2	Ant4	1	-	24.50	23.01	0.06	0.218	1.000	1.409	0.31
	LTE 7	QPSK20M	Rear Face	2	20850	1	50	DSI2	Ant4	1	-	24.50	23.01	0.16	0.351	1.000	1.409	0.49
	LTE 7	QPSK20M	Top Side	2	20850	1	50	DSI2	Ant4	1	-	24.50	23.01	-0.14	0.497	1.000	1.409	0.70
	LTE 7	QPSK20M	Front Face	2	20850	50	25	DSI2	Ant4	1	-	23.50	21.98	0.08	0.159	1.000	1.419	0.23
	LTE 7	QPSK20M	Rear Face	2	20850	50	25	DSI2	Ant4	1	-	23.50	21.98	-0.07	0.283	1.000	1.419	0.40
	LTE 7	QPSK20M	Top Side	2	20850	50	25	DSI2	Ant4	1	-	23.50	21.98	-0.07	0.394	1.000	1.419	0.56
	LTE 7C	QPSK20M	Top Side	1	PCC:21001 SCC:21199	PCC:1 SCC:1	PCC:99 SCC:0	DSI4	Ant4	1	-	19.00	17.97	0.09	0.501	1.000	1.268	0.64
	LTE 7	QPSK20M	Front Face	1	20850	1	50	DSI4	Ant3	1	-	16.00	14.61	-0.02	0.070	1.000	1.377	0.10
	LTE 7	QPSK20M	Rear Face	1	20850	1	50	DSI4	Ant3	1	-	16.00	14.61	-0.05	0.106	1.000	1.377	0.15
	LTE 7	QPSK20M	Left Side	1	20850	1	50	DSI4	Ant3	1	-	16.00	14.61	0.13	0.208	1.000	1.377	0.29
	LTE 7	QPSK20M	Top Side	1	20850	1	50	DSI2	Ant3	1	-	25.00	23.63	-0.01	0.045	1.000	1.371	0.06
	LTE 7	QPSK20M	Front Face	1	20850	50	25	DSI4	Ant3	1	-	16.00	14.41	-0.07	0.076	1.000	1.442	0.11
	LTE 7	QPSK20M	Rear Face	1	20850	50	25	DSI4	Ant3	1	-	16.00	14.41	0.01	0.110	1.000	1.442	0.16
	LTE 7	QPSK20M	Left Side	1	20850	50	25	DSI4	Ant3	1	-	16.00	14.41	0.09	0.196	1.000	1.442	0.28
	LTE 7	QPSK20M	Top Side	1	20850	50	25	DSI2	Ant3	1	-	24.00	22.55	-0.17	0.031	1.000	1.396	0.04
	LTE 7	QPSK20M	Front Face	2	20850	1	50	DSI2	Ant3	1	-	25.00	23.63	0.14	0.160	1.000	1.371	0.22
	LTE 7	QPSK20M	Rear Face	2	20850	1	50	DSI2	Ant3	1	-	25.00	23.63	-0.01	0.218	1.000	1.371	0.30
	LTE 7	QPSK20M	Left Side	1.5	20850	1	50	DSI2	Ant3	1	-	25.00	23.63	-0.10	0.698	1.000	1.371	0.96
	LTE 7	QPSK20M	Front Face	2	20850	50	25	DSI2	Ant3	1	-	24.00	22.55	-0.02	0.128	1.000	1.396	0.18
	LTE 7	QPSK20M	Rear Face	2	20850	50	25	DSI2	Ant3	1	-	24.00	22.55	0.09	0.168	1.000	1.396	0.23
	LTE 7	QPSK20M	Left Side	1.5	20850	50	25	DSI2	Ant3	1	-	24.00	22.55	-0.14	0.544	1.000	1.396	0.76
	LTE 7	QPSK20M	Left Side	1.5	21100	1	50	DSI2	Ant3	1	-	25.00	23.59	0.16	0.711	1.000	1.384	0.98
	LTE 7	QPSK20M	Left Side	1.5	21350	1	50	DSI2	Ant3	1	-	25.00	23.51	0.18	0.654	1.000	1.409	0.92
	LTE 7	QPSK20M	Left Side	1.5	20850	100	0	DSI2	Ant3	1	-	24.00	22.49	0.05	0.568	1.000	1.416	0.80
	LTE 12	QPSK10M	Front Face	1	23060	1	0	DSI3/4	Ant1	1	-	25.50	24.51	-0.14	0.203	1.000	1.256	0.25
	LTE 12	QPSK10M	Rear Face	1	23060	1	0	DSI3/4	Ant1	1	-	25.50	24.51	0.01	0.237	1.000	1.256	0.30
	LTE 12	QPSK10M	Left Side	1	23060	1	0	DSI2	Ant1	1	-	25.50	24.51	0.01	0.191	1.000	1.256	0.24
P66	LTE 12	QPSK10M	Right Side	1	23060	1	0	DSI2	Ant1	1	-	25.50	24.51	0.09	0.361	1.000	1.256	0.45
	LTE 12	QPSK10M	Bottom Side	1	23060	1	0	DSI3/4	Ant1	1	-	25.50	24.51	-0.13	0.187	1.000	1.256	0.23
	LTE 12	QPSK10M	Front Face	1	23060	25	0	DSI3/4	Ant1	1	-	24.50	23.54	0.06	0.172	1.000	1.247	0.21
	LTE 12	QPSK10M	Rear Face	1	23060	25	0	DSI3/4	Ant1	1	-	24.50	23.54	-0.07	0.191	1.000	1.247	0.24
	LTE 12	QPSK10M	Left Side	1	23060	25	0	DSI2	Ant1	1	-	24.50	23.54	0.01	0.161	1.000	1.247	0.20
	LTE 12	QPSK10M	Right Side	1	23060	25	0	DSI2	Ant1	1	-	24.50	23.54	0.05	0.297	1.000	1.247	0.37
	LTE 12	QPSK10M	Bottom Side	1	23060	25	0	DSI3/4	Ant1	1	-	24.50	23.54	0.11	0.147	1.000	1.247	0.18
	LTE 12	QPSK10M	Front Face	1	23060	1	0	DSI4	Ant4	1	-	25.00	24.28	0.09	0.109	1.000	1.180	0.13
	LTE 12	QPSK10M	Rear Face	1	23060	1	0	DSI4	Ant4	1	-	25.00	24.28	0.05	0.149	1.000	1.180	0.18
	LTE 12	QPSK10M	Left Side	1	23060	1	0	DSI2	Ant4	1	-	25.00	24.28	0.03	0.199	1.000	1.180	0.23
	LTE 12	QPSK10M	Right Side	1	23060	1	0	DSI2	Ant4	1	-	25.00	24.28	0.02	0.072	1.000	1.180	0.08
	LTE 12	QPSK10M	Top Side	1	23060	1	0	DSI4	Ant4	1	-	25.00	24.28	-0.11	0.164	1.000	1.180	0.19
	LTE 12	QPSK10M	Front Face	1	23060	25	0	DSI4	Ant4	1	-	24.00	23.26	-0.10	0.089	1.000	1.186	0.11
	LTE 12	QPSK10M	Rear Face	1	23060	25	0	DSI4	Ant4	1	-	24.00	23.26	0.10	0.117	1.000	1.186	0.14
	LTE 12	QPSK10M	Left Side	1	23060	25	0	DSI2	Ant4	1	-	24.00	23.26	0.16	0.159	1.000	1.186	0.19
	LTE 12	QPSK10M	Right Side	1	23060	25	0	DSI2	Ant4	1	-	24.00	23.26	-0.09	0.059	1.000	1.186	0.07
	LTE 12	QPSK10M	Top Side	1	23060	25	0	DSI4	Ant4	1	-	24.00	23.26	-0.14	0.121	1.000	1.186	0.14
	LTE 13	QPSK10M	Front Face	1	23230	1	49	DSI3/4	Ant1	1	-	25.50	24.53	0.07	0.155	1.000	1.250	0.19
	LTE 13	QPSK10M	Rear Face	1	23230	1	49	DSI3/4	Ant1	1	-	25.50	24.53	0.05	0.203	1.000	1.250	0.25
	LTE 13	QPSK10M	Left Side	1	23230	1	49	DSI2	Ant1	1	-	25.50	24.53	-0.09	0.109	1.000	1.250	0.14
P67	LTE 13	QPSK10M	Right Side	1	23230	1	49	DSI2	Ant1	1	-	25.50	24.53	0.06	0.219	1.000	1.250	0.27
	LTE 13	QPSK10M	Bottom Side	1	23230	1	49	DSI3/4	Ant1	1	-	25.50	24.53	-0.11	0.209	1.000	1.250	0.26
	LTE 13	QPSK10M	Front Face	1	23230	25	12	DSI3/4	Ant1	1	-	24.50	23.50	-0.07	0.123	1.000	1.259	0.15
	LTE 13	QPSK10M	Rear Face	1	23230	25	12	DSI3/4	Ant1	1	-	24.50	23.50	0.14	0.171	1.000	1.259	0.22
	LTE 13	QPSK10M	Left Side	1	23230	25	12	DSI2	Ant1	1	-	24.50	23.50	0.19	0.091	1.000	1.259	0.11
	LTE 13	QPSK10M	Right Side	1	23230	25	12	DSI2	Ant1	1	-	24.50	23.50	0.19	0.203	1.000	1.259	0.26
	LTE 13	QPSK10M	Bottom Side	1	23230	25	12	DSI3/4	Ant1	1	-	24.50	23.50	-0.03	0.167	1.		



Certificate #6613.01

BUREAU VERITAS

FCC SAR Test Report

Plot No.	Band	Mode	Test Position	Separation Distance (cm)	Ch.	RB#	RB Offset	Power State	Antenna	Sample	Duty Cycle %	Max. Tune-up Power (dBm)	Measured Conducted Power (dBm)	Power Drift (dB)	Measured SAR-1g (W/kg)	Duty Cycle Scaling Factor	Tune-up Scaling Factor	Scaled SAR-1g (W/kg)
	LTE 13	QPSK10M	Right Side	1	23230	25	12	DSI2	Ant4	1	-	24.00	23.02	0.12	0.070	1.000	1.253	0.09
	LTE 13	QPSK10M	Top Side	1	23230	25	12	DSI4	Ant4	1	-	24.00	23.02	-0.06	0.097	1.000	1.253	0.12
P68	LTE 26	QPSK15M	Front Face	1	26865	1	37	DSI3/4	Ant1	1	-	25.50	24.67	-0.14	0.205	1.000	1.211	0.25
	LTE 26	QPSK15M	Rear Face	1	26865	1	37	DSI3/4	Ant1	1	-	25.50	24.67	0.06	0.336	1.000	1.211	0.41
	LTE 26	QPSK15M	Left Side	1	26865	1	37	DSI2	Ant1	1	-	25.50	24.67	0.15	0.091	1.000	1.211	0.11
	LTE 26	QPSK15M	Right Side	1	26865	1	37	DSI2	Ant1	1	-	25.50	24.67	0.06	0.216	1.000	1.211	0.26
	LTE 26	QPSK15M	Bottom Side	1	26865	1	37	DSI3/4	Ant1	1	-	25.50	24.67	-0.11	0.273	1.000	1.211	0.33
	LTE 26	QPSK15M	Front Face	1	26865	36	0	DSI3/4	Ant1	1	-	24.50	23.61	0.10	0.157	1.000	1.227	0.19
	LTE 26	QPSK15M	Rear Face	1	26865	36	0	DSI3/4	Ant1	1	-	24.50	23.61	-0.16	0.225	1.000	1.227	0.28
	LTE 26	QPSK15M	Left Side	1	26865	36	0	DSI2	Ant1	1	-	24.50	23.61	-0.01	0.075	1.000	1.227	0.09
	LTE 26	QPSK15M	Right Side	1	26865	36	0	DSI2	Ant1	1	-	24.50	23.61	-0.05	0.171	1.000	1.227	0.21
	LTE 26	QPSK15M	Bottom Side	1	26865	36	0	DSI3/4	Ant1	1	-	24.50	23.61	-0.02	0.211	1.000	1.227	0.26
	LTE 26	QPSK15M	Front Face	1	26865	1	0	DSI4	Ant4	1	-	25.00	24.01	-0.03	0.174	1.000	1.256	0.22
	LTE 26	QPSK15M	Rear Face	1	26865	1	0	DSI4	Ant4	1	-	25.00	24.01	-0.01	0.237	1.000	1.256	0.30
	LTE 26	QPSK15M	Left Side	1	26865	1	0	DSI2	Ant4	1	-	25.00	24.01	-0.05	0.155	1.000	1.256	0.19
	LTE 26	QPSK15M	Right Side	1	26865	1	0	DSI2	Ant4	1	-	25.00	24.01	0.17	0.099	1.000	1.256	0.12
	LTE 26	QPSK15M	Top Side	1	26865	1	0	DSI4	Ant4	1	-	25.00	24.01	-0.11	0.196	1.000	1.256	0.25
	LTE 26	QPSK15M	Front Face	1	26865	36	0	DSI4	Ant4	1	-	24.00	22.96	-0.09	0.134	1.000	1.271	0.17
	LTE 26	QPSK15M	Rear Face	1	26865	36	0	DSI4	Ant4	1	-	24.00	22.96	0.18	0.163	1.000	1.271	0.21
	LTE 26	QPSK15M	Left Side	1	26865	36	0	DSI2	Ant4	1	-	24.00	22.96	-0.17	0.124	1.000	1.271	0.16
	LTE 26	QPSK15M	Right Side	1	26865	36	0	DSI2	Ant4	1	-	24.00	22.96	-0.05	0.076	1.000	1.271	0.10
	LTE 26	QPSK15M	Top Side	1	26865	36	0	DSI4	Ant4	1	-	24.00	22.96	0.12	0.156	1.000	1.271	0.20
LTE 38	QPSK20M	Front Face	1	38000	1	50	DSI3/4	Ant1	1	62.9	24.50	23.18	-0.05	0.321	1.006	1.355	0.44	
LTE 38	QPSK20M	Rear Face	1	38000	1	50	DSI3/4	Ant1	1	62.9	24.50	23.18	-0.17	0.301	1.006	1.355	0.41	
LTE 38	QPSK20M	Left Side	1	38000	1	50	DSI2	Ant1	1	62.9	25.50	23.99	0.02	0.112	1.006	1.416	0.16	
LTE 38	QPSK20M	Right Side	1	38000	1	50	DSI2	Ant1	1	62.9	25.50	23.99	0.13	0.140	1.006	1.416	0.20	
LTE 38	QPSK20M	Bottom Side	1	38000	1	50	DSI3/4	Ant1	1	62.9	24.50	23.18	-0.01	0.507	1.006	1.355	0.69	
LTE 38	QPSK20M	Front Face	1	38000	50	0	DSI3/4	Ant1	1	62.9	24.50	23.04	-0.07	0.314	1.006	1.400	0.44	
LTE 38	QPSK20M	Rear Face	1	38000	50	0	DSI3/4	Ant1	1	62.9	24.50	23.04	0.01	0.311	1.006	1.400	0.44	
LTE 38	QPSK20M	Left Side	1	38000	50	0	DSI2	Ant1	1	62.9	24.50	22.98	0.06	0.100	1.006	1.419	0.14	
LTE 38	QPSK20M	Right Side	1	38000	50	0	DSI2	Ant1	1	62.9	24.50	22.98	0.15	0.119	1.006	1.419	0.17	
LTE 38	QPSK20M	Bottom Side	1	38000	50	0	DSI3/4	Ant1	1	62.9	24.50	23.04	0.17	0.502	1.006	1.400	0.71	
LTE 38	QPSK20M	Front Face	2	38000	1	50	DSI2	Ant1	1	62.9	25.50	23.99	0.16	0.128	1.006	1.416	0.18	
LTE 38	QPSK20M	Rear Face	2	38000	1	50	DSI2	Ant1	1	62.9	25.50	23.99	0.17	0.154	1.006	1.416	0.22	
LTE 38	QPSK20M	Bottom Side	2	38000	1	50	DSI2	Ant1	1	62.9	25.50	23.99	-0.04	0.215	1.006	1.416	0.31	
LTE 38	QPSK20M	Front Face	2	38000	50	0	DSI2	Ant1	1	62.9	24.50	22.98	-0.18	0.105	1.006	1.419	0.15	
LTE 38	QPSK20M	Rear Face	2	38000	50	0	DSI2	Ant1	1	62.9	24.50	22.98	-0.14	0.122	1.006	1.419	0.17	
LTE 38	QPSK20M	Bottom Side	2	38000	50	0	DSI2	Ant1	1	62.9	24.50	22.98	0.17	0.171	1.006	1.419	0.24	
LTE 38C	QPSK20M	Bottom Side	1	PCC:37901 SCC:38099	PCC:1 SCC:1	PCC:99 SCC:0	DSI3/4	Ant1	1	62.9	24.50	22.71	0.03	0.457	1.006	1.510	0.69	
LTE 38	QPSK20M	Front Face	1	38000	1	0	DSI4	Ant4	1	62.9	21.50	20.25	-0.15	0.187	1.006	1.334	0.25	
LTE 38	QPSK20M	Rear Face	1	38000	1	0	DSI4	Ant4	1	62.9	21.50	20.25	-0.05	0.337	1.006	1.334	0.45	
LTE 38	QPSK20M	Left Side	1	38000	1	0	DSI2	Ant4	1	62.9	25.00	23.34	0.08	0.116	1.006	1.466	0.17	
LTE 38	QPSK20M	Right Side	1	38000	1	0	DSI2	Ant4	1	62.9	25.00	23.34	0.13	0.071	1.006	1.466	0.10	
LTE 38	QPSK20M	Top Side	1	38000	1	0	DSI4	Ant4	1	62.9	21.50	20.18	-0.12	0.414	1.006	1.355	0.56	
LTE 38	QPSK20M	Front Face	1	38000	50	0	DSI4	Ant4	1	62.9	21.50	20.21	0.08	0.191	1.006	1.346	0.26	
LTE 38	QPSK20M	Rear Face	1	38000	50	0	DSI4	Ant4	1	62.9	21.50	20.21	-0.08	0.424	1.006	1.346	0.57	
LTE 38	QPSK20M	Left Side	1	38000	50	0	DSI2	Ant4	1	62.9	24.00	22.41	-0.05	0.090	1.006	1.442	0.13	
LTE 38	QPSK20M	Right Side	1	38000	50	0	DSI2	Ant4	1	62.9	24.00	22.41	0.18	0.055	1.006	1.442	0.08	
P69	LTE 38	QPSK20M	Top Side	1	38000	50	0	DSI4	Ant4	1	62.9	21.50	20.17	0.02	0.578	1.006	1.358	0.79
	LTE 38	QPSK20M	Front Face	2	38000	1	0	DSI2	Ant4	1	62.9	25.00	23.34	-0.18	0.119	1.006	1.466	0.18
	LTE 38	QPSK20M	Rear Face	2	38000	1	0	DSI2	Ant4	1	62.9	25.00	23.34	-0.17	0.207	1.006	1.466	0.31
	LTE 38	QPSK20M	Top Side	2	38000	1	0	DSI2	Ant4	1	62.9	25.00	23.34	0.13	0.294	1.006	1.466	0.43
	LTE 38	QPSK20M	Front Face	2	38000	50	0	DSI2	Ant4	1	62.9	24.00	22.41	-0.09	0.099	1.006	1.442	0.14
	LTE 38	QPSK20M	Rear Face	2	38000	50	0	DSI2	Ant4	1	62.9	24.00	22.41	-0.04	0.146	1.006	1.442	0.21
	LTE 38	QPSK20M	Top Side	2	38000	50	0	DSI2	Ant4	1	62.9	24.00	22.41	0.01	0.235	1.006	1.442	0.34
	LTE 38C	QPSK20M	Top Side	1	PCC:37901 SCC:38099	PCC:1 SCC:1	PCC:99 SCC:0	DSI4	Ant4	1	62.9	21.50	19.85	-0.14	0.511	1.006	1.462	0.75
	LTE 38	QPSK20M	Front Face	1	38000	1	0	DSI4	Ant3	1	-	20.00	18.52	0.19	0.115	1.000	1.406	0.16
	LTE 38	QPSK20M	Rear Face	1	38000	1	0	DSI4	Ant3	1	-	20.00	18.52	-0.13	0.158	1.000	1.406	0.22
	LTE 38	QPSK20M	Left Side	1	38000	1	0	DSI4	Ant3	1	-	20.00	18.52	-0.07	0.302	1.000	1.406	0.42
	LTE 38	QPSK20M	Top Side	1	38000	1	0	DSI2	Ant3	1	-	25.00	23.59	0.07	0.052	1.000	1.384	0.07
LTE 38	QPSK20M	Front Face	1	38000	50	0	DSI4	Ant3	1	-	20.00	18.58	-0.01	0.126	1.000	1.387	0.17	
LTE 38	QPSK20M	Rear Face	1	38000	50	0	DSI4	Ant3	1	-	20.00	18.58	-0.14	0.162	1.000	1.387	0.22	
LTE 38	QPSK20M	Left Side	1	38000	50	0	DSI4	Ant3	1	-	20.00	18.58	0.01	0.286	1.000	1.387	0.40	
LTE 38	QPSK20M	Top Side	1	38000	50	0	DSI2	Ant3	1	-	24.00	22.46	0.06	0.048	1.000	1.426	0.07	
LTE 38	QPSK20M	Front Face	2	38000	1	0	DSI2	Ant3	1	-	25.00	23.59	0.18	0.088	1.000	1.384	0.12	
LTE 38	QPSK20M	Rear Face	2	38000	1	0	DSI2	Ant3	1	-	25.00	23.59	-0.14	0.124	1.000	1.384	0.17	
LTE 38	QPSK20M	Left Side	1.5	38000	1	0	DSI2	Ant3	1	-	25.00	23.59	-0.18	0.224				



BUREAU VERITAS

FCC SAR Test Report



Certificate #6613.01

Plot No.	Band	Mode	Test Position	Separation Distance (cm)	Ch.	RB#	RB Offset	Power State	Antenna	Sample	Duty Cycle %	Max. Tune-up Power (dBm)	Measured Conducted Power (dBm)	Power Drift (dB)	Measured SAR-1g (W/kg)	Duty Cycle Scaling Factor	Tune-up Scaling Factor	Scaled SAR-1g (W/kg)
	LTE 41	QPSK20M	Right Side	1	39750	1	0	DSI2	Ant1	1	62.9	25.50	24.02	0.13	0.154	1.006	1.406	0.22
	LTE 41	QPSK20M	Bottom Side	1	39750	1	0	DSI3/4	Ant1	1	62.9	24.50	23.21	-0.07	0.418	1.006	1.346	0.57
	LTE 41	QPSK20M	Front Face	1	39750	50	0	DSI3/4	Ant1	1	62.9	24.50	23.15	0.12	0.315	1.006	1.365	0.43
	LTE 41	QPSK20M	Rear Face	1	39750	50	0	DSI3/4	Ant1	1	62.9	24.50	23.15	0.12	0.288	1.006	1.365	0.40
	LTE 41	QPSK20M	Left Side	1	39750	50	0	DSI2	Ant1	1	62.9	24.50	23.14	-0.08	0.086	1.006	1.368	0.12
	LTE 41	QPSK20M	Right Side	1	39750	50	0	DSI2	Ant1	1	62.9	24.50	23.14	0.18	0.124	1.006	1.368	0.17
	LTE 41	QPSK20M	Bottom Side	1	39750	50	0	DSI3/4	Ant1	1	62.9	24.50	23.15	-0.05	0.425	1.006	1.365	0.58
	LTE 41	QPSK20M	Front Face	2	39750	1	0	DSI2	Ant1	1	62.9	25.50	24.02	0.11	0.122	1.006	1.406	0.17
	LTE 41	QPSK20M	Rear Face	2	39750	1	0	DSI2	Ant1	1	62.9	25.50	24.02	0.00	0.126	1.006	1.406	0.18
	LTE 41	QPSK20M	Bottom Side	2	39750	1	0	DSI2	Ant1	1	62.9	25.50	24.02	0.18	0.131	1.006	1.406	0.19
	LTE 41	QPSK20M	Front Face	2	39750	50	0	DSI2	Ant1	1	62.9	24.50	23.14	-0.11	0.097	1.006	1.368	0.13
	LTE 41	QPSK20M	Rear Face	2	39750	50	0	DSI2	Ant1	1	62.9	24.50	23.14	-0.07	0.102	1.006	1.368	0.14
	LTE 41	QPSK20M	Bottom Side	2	39750	50	0	DSI2	Ant1	1	62.9	24.50	23.14	0.02	0.109	1.006	1.368	0.15
	LTE 41	QPSK20M	Front Face	1	39750	1	50	DSI4	Ant3	1	62.9	17.50	16.16	-0.07	0.127	1.006	1.361	0.17
	LTE 41	QPSK20M	Rear Face	1	39750	1	50	DSI4	Ant3	1	62.9	17.50	16.16	0.14	0.147	1.006	1.361	0.20
	LTE 41	QPSK20M	Left Side	1	39750	1	50	DSI4	Ant3	1	62.9	17.50	16.16	0.05	0.324	1.006	1.361	0.44
	LTE 41	QPSK20M	Top Side	1	39750	1	50	DSI2	Ant3	1	62.9	22.00	20.31	0.00	0.000	1.006	1.476	0.00
	LTE 41	QPSK20M	Front Face	1	39750	50	25	DSI4	Ant3	1	62.9	17.50	16.05	0.01	0.125	1.006	1.396	0.18
	LTE 41	QPSK20M	Rear Face	1	39750	50	25	DSI4	Ant3	1	62.9	17.50	16.05	0.13	0.183	1.006	1.396	0.26
	LTE 41	QPSK20M	Left Side	1	39750	50	25	DSI4	Ant3	1	62.9	17.50	16.05	0.01	0.345	1.006	1.396	0.48
	LTE 41	QPSK20M	Top Side	1	39750	50	25	DSI2	Ant3	1	62.9	21.00	19.38	0.00	0.000	1.006	1.452	0.00
	LTE 41	QPSK20M	Front Face	2	39750	1	50	DSI2	Ant3	1	62.9	22.00	20.31	0.00	0.060	1.006	1.476	0.09
	LTE 41	QPSK20M	Rear Face	2	39750	1	50	DSI2	Ant3	1	62.9	22.00	20.31	0.17	0.063	1.006	1.476	0.09
	LTE 41	QPSK20M	Left Side	1.5	39750	1	50	DSI2	Ant3	1	62.9	22.00	20.31	-0.18	0.162	1.006	1.476	0.24
	LTE 41	QPSK20M	Front Face	2	39750	50	25	DSI2	Ant3	1	62.9	21.00	19.38	0.05	0.064	1.006	1.452	0.09
	LTE 41	QPSK20M	Rear Face	2	39750	50	25	DSI2	Ant3	1	62.9	21.00	19.38	-0.16	0.057	1.006	1.452	0.08
	LTE 41	QPSK20M	Left Side	1.5	39750	50	25	DSI2	Ant3	1	62.9	21.00	19.38	-0.13	0.156	1.006	1.452	0.23
	LTE 41 (ENDC Only)	QPSK20M	Front Face	1	39750	1	50	DSI4	Ant3	1	62.9	17.50	16.16	-0.15	0.064	1.006	1.361	0.09
	LTE 41 (ENDC Only)	QPSK20M	Rear Face	1	39750	1	50	DSI4	Ant3	1	62.9	17.50	16.16	0.06	0.102	1.006	1.361	0.14
	LTE 41 (ENDC Only)	QPSK20M	Left Side	1	39750	1	50	DSI4	Ant3	1	62.9	17.50	16.16	-0.16	0.170	1.006	1.361	0.23
	LTE 41 (ENDC Only)	QPSK20M	Front Face	1	39750	50	25	DSI4	Ant3	1	62.9	17.50	16.05	-0.17	0.067	1.006	1.396	0.09
	LTE 41 (ENDC Only)	QPSK20M	Rear Face	1	39750	50	25	DSI4	Ant3	1	62.9	17.50	16.05	0.02	0.095	1.006	1.396	0.13
	LTE 41 (ENDC Only)	QPSK20M	Left Side	1	39750	50	25	DSI4	Ant3	1	62.9	17.50	16.05	-0.19	0.171	1.006	1.396	0.24
	LTE 41	QPSK20M	Front Face	1	39750	1	0	DSI4	Ant4	1	62.9	22.00	20.59	-0.15	0.170	1.006	1.384	0.24
	LTE 41	QPSK20M	Rear Face	1	39750	1	0	DSI4	Ant4	1	62.9	22.00	20.59	-0.09	0.362	1.006	1.384	0.50
	LTE 41	QPSK20M	Left Side	1	39750	1	0	DSI2	Ant4	1	62.9	25.00	23.49	0.15	0.105	1.006	1.416	0.15
	LTE 41	QPSK20M	Right Side	1	39750	1	0	DSI2	Ant4	1	62.9	25.00	23.49	0.18	0.048	1.006	1.416	0.07
	LTE 41	QPSK20M	Top Side	1	39750	1	0	DSI4	Ant4	1	62.9	22.00	20.59	-0.17	0.473	1.006	1.384	0.66
	LTE 41	QPSK20M	Front Face	1	39750	50	0	DSI4	Ant4	1	62.9	22.00	20.46	-0.19	0.186	1.006	1.426	0.27
	LTE 41	QPSK20M	Rear Face	1	39750	50	0	DSI4	Ant4	1	62.9	22.00	20.46	0.09	0.383	1.006	1.426	0.55
	LTE 41	QPSK20M	Left Side	1	39750	50	0	DSI2	Ant4	1	62.9	24.00	22.45	-0.04	0.091	1.006	1.429	0.13
	LTE 41	QPSK20M	Right Side	1	39750	50	0	DSI2	Ant4	1	62.9	24.00	22.45	-0.18	0.040	1.006	1.429	0.06
P70	LTE 41	QPSK20M	Top Side	1	39750	50	0	DSI4	Ant4	1	62.9	22.00	20.46	0.13	0.485	1.006	1.426	0.70
	LTE 41	QPSK20M	Front Face	2	39750	1	0	DSI2	Ant4	1	62.9	25.00	23.49	-0.04	0.106	1.006	1.416	0.15
	LTE 41	QPSK20M	Rear Face	2	39750	1	0	DSI2	Ant4	1	62.9	25.00	23.49	-0.12	0.156	1.006	1.416	0.22
	LTE 41	QPSK20M	Top Side	2	39750	1	0	DSI2	Ant4	1	62.9	25.00	23.49	0.04	0.254	1.006	1.416	0.36
	LTE 41	QPSK20M	Front Face	2	39750	50	0	DSI2	Ant4	1	62.9	24.00	22.45	-0.18	0.089	1.006	1.429	0.13
	LTE 41	QPSK20M	Rear Face	2	39750	50	0	DSI2	Ant4	1	62.9	24.00	22.45	0.02	0.134	1.006	1.429	0.19
	LTE 41	QPSK20M	Top Side	2	39750	50	0	DSI2	Ant4	1	62.9	24.00	22.45	0.05	0.222	1.006	1.429	0.32
	LTE 41	QPSK20M	Front Face	1	39750	1	50	DSI2	Ant7	1	62.9	21.00	19.41	0.09	0.117	1.006	1.442	0.17
	LTE 41	QPSK20M	Rear Face	1	39750	1	50	DSI2	Ant7	1	62.9	21.00	19.41	0.10	0.213	1.006	1.442	0.31
	LTE 41	QPSK20M	Left Side	1	39750	1	50	DSI2	Ant7	1	62.9	21.00	19.41	-0.17	0.041	1.006	1.442	0.06
	LTE 41	QPSK20M	Right Side	1	39750	1	50	DSI2	Ant7	1	62.9	21.00	19.41	0.11	0.199	1.006	1.442	0.29
	LTE 41	QPSK20M	Top Side	1	39750	1	50	DSI2	Ant7	1	62.9	21.00	19.41	0.15	0.090	1.006	1.442	0.13
	LTE 41	QPSK20M	Front Face	1	39750	50	25	DSI2	Ant7	1	62.9	20.00	18.41	0.15	0.097	1.006	1.442	0.14
	LTE 41	QPSK20M	Rear Face	1	39750	50	25	DSI2	Ant7	1	62.9	20.00	18.41	0.17	0.173	1.006	1.442	0.25
	LTE 41	QPSK20M	Left Side	1	39750	50	25	DSI2	Ant7	1	62.9	20.00	18.41	-0.01	0.058	1.006	1.442	0.08
	LTE 41	QPSK20M	Right Side	1	39750	50	25	DSI2	Ant7	1	62.9	20.00	18.41	-0.12	0.155	1.006	1.442	0.22
	LTE 41	QPSK20M	Top Side	1	39750	50	25	DSI2	Ant7	1	62.9	20.00	18.41	-0.04	0.076	1.006	1.442	0.11
	LTE 42	QPSK20M	Front Face	1	42190	1	50	DSI4	Ant2	1	62.9	22.00	20.98	-0.06	0.202	1.006	1.265	0.26
	LTE 42	QPSK20M	Rear Face	1	42190	1	50	DSI4	Ant2	1	62.9	22.00	20.98	0.05	0.173	1.006	1.265	0.22
	LTE 42	QPSK20M	Left Side	1	42190	1	50	DSI4	Ant2	1	62.9	22.00	20.98	0.15	0.189	1.006	1.265	0.24
	LTE 42	QPSK20M	Top Side	1	42190	1	50	DSI2	Ant2	1	62.9	22.00	20.98	-0.08	0.093	1.006	1.265	0.12
	LTE 42	QPSK20M	Front Face	1	42190	50	25	DSI4	Ant2	1	62.9	21.00	20.02	0.19	0.164	1.006	1.253	0.21
	LTE 42	QPSK20M	Rear Face	1	42190	50	25	DSI4	Ant2	1	62.9	21.00	20.02	0.15	0.134	1.006	1.253	0.17
	LTE 42	QPSK20M	Left Side	1	42190	50	25	DSI4	Ant2	1	62.9	21.00	20.02	0.09	0.153	1.006	1.253	0.19
	LTE 42	QPSK20M	Top Side	1	42190	50	25	DSI2	Ant2	1	62.9	21.00	20.02	-0.02	0.070	1.006	1.253	0.09
	LTE 42	QPSK20M	Front Face	1	42990	1	50	DSI4	Ant3	1	62.9	20.00	18.55	0.19	0.173	1.006	1.396	0.24
	LTE 42	QPSK20M	Rear Face	1	42990	1	50	DSI4	Ant3	1	62.9	20.00	18.55	-0.18	0.279	1.006	1.396	0.39
	LTE 42	QPSK20M	Left Side	1	42990	1	50	DSI4	Ant3	1	62.9	20.00	18.55	0.11	0.565	1.006	1.396	0.79



BUREAU VERITAS

FCC SAR Test Report

Certificate #6613.01

Plot No.	Band	Mode	Test Position	Separation Distance (cm)	Ch.	RB#	RB Offset	Power State	Antenna	Sample	Duty Cycle %	Max. Tune-up Power (dBm)	Measured Conducted Power (dBm)	Power Drift (dB)	Measured SAR-1g (W/kg)	Duty Cycle Scaling Factor	Tune-up Scaling Factor	Scaled SAR-1g (W/kg)
	LTE 42	QPSK20M	Top Side	1	42990	1	50	DSI2	Ant3	1	62.9	20.00	18.55	0.00	0.000	1.006	1.396	0.00
	LTE 42	QPSK20M	Front Face	1	42990	50	25	DSI4	Ant3	1	62.9	19.00	17.48	-0.12	0.142	1.006	1.419	0.20
	LTE 42	QPSK20M	Rear Face	1	42990	50	25	DSI4	Ant3	1	62.9	19.00	17.48	0.12	0.218	1.006	1.419	0.31
	LTE 42	QPSK20M	Left Side	1	42990	50	25	DSI4	Ant3	1	62.9	19.00	17.48	-0.14	0.449	1.006	1.419	0.64
	LTE 42	QPSK20M	Top Side	1	42990	50	25	DSI2	Ant3	1	62.9	19.00	17.48	0.00	0.000	1.006	1.419	0.00
	LTE 42	QPSK20M	Front Face	2	42990	1	50	DSI4	Ant3	1	62.9	20.00	18.55	-0.04	0.060	1.006	1.396	0.08
	LTE 42	QPSK20M	Rear Face	2	42990	1	50	DSI4	Ant3	1	62.9	20.00	18.55	0.18	0.099	1.006	1.396	0.14
	LTE 42	QPSK20M	Left Side	1.5	42990	1	50	DSI4	Ant3	1	62.9	20.00	18.55	0.07	0.288	1.006	1.396	0.40
	LTE 42	QPSK20M	Front Face	2	42990	50	25	DSI4	Ant3	1	62.9	19.00	17.48	0.12	0.048	1.006	1.419	0.07
	LTE 42	QPSK20M	Rear Face	2	42990	50	25	DSI4	Ant3	1	62.9	19.00	17.48	0.13	0.079	1.006	1.419	0.11
	LTE 42	QPSK20M	Left Side	1.5	42990	50	25	DSI4	Ant3	1	62.9	19.00	17.48	0.10	0.232	1.006	1.419	0.33
	LTE 42 (ENDC Only)	QPSK20M	Front Face	1	42990	1	50	DSI4	Ant3	1	62.9	16.50	15.44	0.03	0.082	1.006	1.276	0.11
	LTE 42 (ENDC Only)	QPSK20M	Rear Face	1	42990	1	50	DSI4	Ant3	1	62.9	16.50	15.44	0.17	0.034	1.006	1.276	0.04
	LTE 42 (ENDC Only)	QPSK20M	Left Side	1	42990	1	50	DSI4	Ant3	1	62.9	16.50	15.44	-0.09	0.262	1.006	1.276	0.34
	LTE 42 (ENDC Only)	QPSK20M	Front Face	1	42990	50	25	DSI4	Ant3	1	62.9	16.50	15.21	-0.19	0.085	1.006	1.346	0.12
	LTE 42 (ENDC Only)	QPSK20M	Rear Face	1	42990	50	25	DSI4	Ant3	1	62.9	16.50	15.21	-0.07	0.132	1.006	1.346	0.18
	LTE 42 (ENDC Only)	QPSK20M	Left Side	1	42990	50	25	DSI4	Ant3	1	62.9	16.50	15.21	0.11	0.257	1.006	1.346	0.35
	LTE 42	QPSK20M	Front Face	1	42990	1	50	DSI4	Ant5	1	62.9	22.00	21.19	-0.06	0.339	1.006	1.205	0.41
	LTE 42	QPSK20M	Rear Face	1	42990	1	50	DSI4	Ant5	1	62.9	22.00	21.19	0.02	0.429	1.006	1.205	0.52
	LTE 42	QPSK20M	Left Side	1	42990	1	50	DSI2	Ant5	1	62.9	24.00	22.47	-0.10	0.203	1.006	1.422	0.29
	LTE 42	QPSK20M	Right Side	1	42990	1	50	DSI2	Ant5	1	62.9	24.00	22.47	-0.04	0.131	1.006	1.422	0.19
	LTE 42	QPSK20M	Top Side	1	42990	1	50	DSI4	Ant5	1	62.9	22.00	21.19	0.14	0.694	1.006	1.205	0.84
	LTE 42	QPSK20M	Front Face	1	42990	50	0	DSI4	Ant5	1	62.9	22.00	20.89	-0.19	0.303	1.006	1.291	0.39
	LTE 42	QPSK20M	Rear Face	1	42990	50	0	DSI4	Ant5	1	62.9	22.00	20.89	0.08	0.432	1.006	1.291	0.56
	LTE 42	QPSK20M	Left Side	1	42990	50	0	DSI2	Ant5	1	62.9	23.00	21.52	0.11	0.165	1.006	1.406	0.23
	LTE 42	QPSK20M	Right Side	1	42990	50	0	DSI2	Ant5	1	62.9	23.00	21.52	-0.17	0.107	1.006	1.406	0.15
	LTE 42	QPSK20M	Top Side	1	42990	50	0	DSI4	Ant5	1	62.9	22.00	20.89	0.07	0.713	1.006	1.291	0.93
	LTE 42	QPSK20M	Top Side	1	42190	1	50	DSI4	Ant5	1	62.9	22.00	21.09	0.03	0.696	1.006	1.233	0.86
P71	LTE 42	QPSK20M	Top Side	1	42590	1	50	DSI4	Ant5	1	62.9	22.00	21.06	0.02	0.759	1.006	1.242	0.95
	LTE 42	QPSK20M	Top Side	1	42190	50	0	DSI4	Ant5	1	62.9	22.00	20.79	0.08	0.698	1.006	1.321	0.93
	LTE 42	QPSK20M	Top Side	1	42590	50	0	DSI4	Ant5	1	62.9	22.00	20.88	0.12	0.721	1.006	1.294	0.94
	LTE 42	QPSK20M	Top Side	1	42990	100	0	DSI4	Ant5	1	62.9	22.00	20.85	0.17	0.712	1.006	1.303	0.93
	LTE 42	QPSK20M	Front Face	2	42990	1	50	DSI2	Ant5	1	62.9	24.00	22.47	-0.01	0.162	1.006	1.422	0.23
	LTE 42	QPSK20M	Rear Face	2	42990	1	50	DSI2	Ant5	1	62.9	24.00	22.47	0.03	0.258	1.006	1.422	0.37
	LTE 42	QPSK20M	Top Side	2	42990	1	50	DSI2	Ant5	1	62.9	24.00	22.47	0.14	0.311	1.006	1.422	0.45
	LTE 42	QPSK20M	Front Face	2	42990	50	0	DSI2	Ant5	1	62.9	23.00	21.52	-0.04	0.145	1.006	1.406	0.21
	LTE 42	QPSK20M	Rear Face	2	42990	50	0	DSI2	Ant5	1	62.9	23.00	21.52	-0.17	0.250	1.006	1.406	0.35
	LTE 42	QPSK20M	Top Side	2	42990	50	0	DSI2	Ant5	1	62.9	23.00	21.52	-0.18	0.275	1.006	1.406	0.39
	LTE 42 (ENDC Only)	QPSK20M	Front Face	1	42990	1	50	DSI4	Ant5	1	62.9	20.00	19.08	0.11	0.207	1.006	1.236	0.26
	LTE 42 (ENDC Only)	QPSK20M	Rear Face	1	42990	1	50	DSI4	Ant5	1	62.9	20.00	19.08	0.03	0.361	1.006	1.236	0.45
	LTE 42 (ENDC Only)	QPSK20M	Top Side	1	42990	1	50	DSI4	Ant5	1	62.9	20.00	19.08	-0.19	0.476	1.006	1.236	0.59
	LTE 42 (ENDC Only)	QPSK20M	Front Face	1	42990	50	0	DSI4	Ant5	1	62.9	20.00	19.03	0.08	0.202	1.006	1.250	0.25
	LTE 42 (ENDC Only)	QPSK20M	Rear Face	1	42990	50	0	DSI4	Ant5	1	62.9	20.00	19.03	-0.14	0.355	1.006	1.250	0.45
	LTE 42 (ENDC Only)	QPSK20M	Top Side	1	42990	50	0	DSI4	Ant5	1	62.9	20.00	19.03	-0.10	0.481	1.006	1.250	0.61
	LTE 42	QPSK20M	Front Face	1	42190	1	50	DSI2	Ant7	1	62.9	22.50	21.01	-0.08	0.114	1.006	1.409	0.16
	LTE 42	QPSK20M	Rear Face	1	42190	1	50	DSI2	Ant7	1	62.9	22.50	21.01	0.10	0.352	1.006	1.409	0.50
	LTE 42	QPSK20M	Right Side	1	42190	1	50	DSI2	Ant7	1	62.9	22.50	21.01	0.12	0.412	1.006	1.409	0.58
	LTE 42	QPSK20M	Top Side	1	42190	1	50	DSI2	Ant7	1	62.9	22.50	21.01	0.07	0.140	1.006	1.409	0.20
	LTE 42	QPSK20M	Front Face	1	42190	50	25	DSI2	Ant7	1	62.9	21.50	20.12	0.02	0.088	1.006	1.374	0.12
	LTE 42	QPSK20M	Rear Face	1	42190	50	25	DSI2	Ant7	1	62.9	21.50	20.12	0.14	0.290	1.006	1.374	0.40
	LTE 42	QPSK20M	Right Side	1	42190	50	25	DSI2	Ant7	1	62.9	21.50	20.12	-0.11	0.325	1.006	1.374	0.45
	LTE 42	QPSK20M	Top Side	1	42190	50	25	DSI2	Ant7	1	62.9	21.50	20.12	0.11	0.110	1.006	1.374	0.15
	LTE 48	QPSK20M	Front Face	1	55340	1	50	DSI4	Ant2	1	62.9	22.00	20.95	0.17	0.136	1.006	1.274	0.17
	LTE 48	QPSK20M	Rear Face	1	55340	1	50	DSI4	Ant2	1	62.9	22.00	20.95	-0.03	0.104	1.006	1.274	0.13
	LTE 48	QPSK20M	Left Side	1	55340	1	50	DSI4	Ant2	1	62.9	22.00	20.95	-0.10	0.119	1.006	1.274	0.15
	LTE 48	QPSK20M	Top Side	1	55340	1	50	DSI2	Ant2	1	62.9	22.00	20.95	0.09	0.068	1.006	1.274	0.09
	LTE 48	QPSK20M	Front Face	1	55340	50	25	DSI4	Ant2	1	62.9	21.00	19.98	-0.17	0.115	1.006	1.265	0.15
	LTE 48	QPSK20M	Rear Face	1	55340	50	25	DSI4	Ant2	1	62.9	21.00	19.98	0.02	0.087	1.006	1.265	0.11
	LTE 48	QPSK20M	Left Side	1	55340	50	25	DSI4	Ant2	1	62.9	21.00	19.98	-0.19	0.096	1.006	1.265	0.12
	LTE 48	QPSK20M	Top Side	1	55340	50	25	DSI2	Ant2	1	62.9	21.00	19.98	0.00	0.054	1.006	1.265	0.07
	LTE 48	QPSK20M	Front Face	1	56150	1	50	DSI4	Ant3	1	62.9	20.00	18.58	0.16	0.132	1.006	1.387	0.18
	LTE 48	QPSK20M	Rear Face	1	56150	1	50	DSI4	Ant3	1	62.9	20.00	18.58	0.17	0.200	1.006	1.387	0.28
	LTE 48	QPSK20M	Left Side	1	56150	1	50	DSI4	Ant3	1	62.9	20.00	18.58	0.07	0.426	1.006	1.429	0.61
	LTE 48	QPSK20M	Top Side	1	56150	1	50	DSI2	Ant3	1	62.9	20.00	18.58	0.00	0.000	1.006	1.387	0.00



Certificate #6613.01

BUREAU
VERITAS

FCC SAR Test Report

Plot No.	Band	Mode	Test Position	Separation Distance (cm)	Ch.	RB#	RB Offset	Power State	Antenna	Sample	Duty Cycle %	Max. Tune-up Power (dBm)	Measured Conducted Power (dBm)	Power Drift (dB)	Measured SAR-1g (W/kg)	Duty Cycle Scaling Factor	Tune-up Scaling Factor	Scaled SAR-1g (W/kg)
	LTE 48	QPSK20M	Front Face	1	56150	50	25	DSI4	Ant3	1	62.9	19.00	17.48	-0.10	0.139	1.006	1.419	0.20
	LTE 48	QPSK20M	Rear Face	1	56150	50	25	DSI4	Ant3	1	62.9	19.00	17.48	0.08	0.199	1.006	1.419	0.28
	LTE 48	QPSK20M	Left Side	1	56150	50	25	DSI4	Ant3	1	62.9	19.00	17.48	-0.14	0.425	1.006	1.435	0.61
	LTE 48	QPSK20M	Top Side	1	56150	50	25	DSI2	Ant3	1	62.9	19.00	17.48	0.00	0.000	1.006	1.419	0.00
	LTE 48	QPSK20M	Front Face	1	55340	1	50	DSI4	Ant5	1	62.9	22.00	21.25	-0.19	0.276	1.006	1.189	0.33
	LTE 48	QPSK20M	Rear Face	1	55340	1	50	DSI4	Ant5	1	62.9	22.00	21.25	0.09	0.486	1.006	1.189	0.58
	LTE 48	QPSK20M	Left Side	1	55340	1	50	DSI2	Ant5	1	62.9	24.00	22.49	-0.16	0.213	1.006	1.416	0.30
	LTE 48	QPSK20M	Right Side	1	55340	1	50	DSI2	Ant5	1	62.9	24.00	22.49	-0.09	0.096	1.006	1.416	0.14
	LTE 48	QPSK20M	Top Side	1	55340	1	50	DSI4	Ant5	1	62.9	22.00	21.25	0.18	0.612	1.006	1.189	0.73
	LTE 48	QPSK20M	Front Face	1	55340	50	0	DSI4	Ant5	1	62.9	22.00	20.97	-0.07	0.277	1.006	1.268	0.35
	LTE 48	QPSK20M	Rear Face	1	55340	50	0	DSI4	Ant5	1	62.9	22.00	20.97	-0.01	0.494	1.006	1.268	0.63
	LTE 48	QPSK20M	Left Side	1	55340	50	0	DSI2	Ant5	1	62.9	23.00	21.53	0.02	0.170	1.006	1.403	0.24
	LTE 48	QPSK20M	Right Side	1	55340	50	0	DSI2	Ant5	1	62.9	23.00	21.53	0.00	0.080	1.006	1.403	0.11
	LTE 48	QPSK20M	Top Side	1	55340	50	0	DSI4	Ant5	1	62.9	22.00	20.97	-0.14	0.629	1.006	1.268	0.80
	LTE 48	QPSK20M	Top Side	1	55830	1	50	DSI4	Ant5	1	62.9	22.00	21.12	-0.07	0.560	1.006	1.225	0.69
	LTE 48	QPSK20M	Top Side	1	56150	1	50	DSI4	Ant5	1	62.9	22.00	21.09	0.13	0.512	1.006	1.233	0.64
	LTE 48	QPSK20M	Top Side	1	56640	1	50	DSI4	Ant5	1	62.9	22.00	21.22	0.02	0.435	1.006	1.197	0.52
	LTE 48	QPSK20M	Top Side	1	55830	50	0	DSI4	Ant5	1	62.9	22.00	20.75	0.10	0.576	1.006	1.334	0.77
	LTE 48	QPSK20M	Top Side	1	56150	50	0	DSI4	Ant5	1	62.9	22.00	20.80	0.15	0.519	1.006	1.318	0.69
	LTE 48	QPSK20M	Top Side	1	56640	50	0	DSI4	Ant5	1	62.9	22.00	20.79	0.02	0.440	1.006	1.321	0.59
P72	LTE 48	QPSK20M	Top Side	1	55340	100	0	DSI4	Ant5	1	62.9	22.00	20.82	0.04	0.663	1.006	1.312	0.88
	LTE 48	QPSK20M	Front Face	2	55340	1	50	DSI2	Ant5	1	62.9	24.00	22.49	0.14	0.149	1.006	1.416	0.21
	LTE 48	QPSK20M	Rear Face	2	55340	1	50	DSI2	Ant5	1	62.9	24.00	22.49	0.08	0.241	1.006	1.416	0.34
	LTE 48	QPSK20M	Top Side	2	55340	1	50	DSI2	Ant5	1	62.9	24.00	22.49	-0.05	0.313	1.006	1.416	0.45
	LTE 48	QPSK20M	Front Face	2	55340	50	0	DSI2	Ant5	1	62.9	23.00	21.53	0.16	0.116	1.006	1.403	0.16
	LTE 48	QPSK20M	Rear Face	2	55340	50	0	DSI2	Ant5	1	62.9	23.00	21.53	0.07	0.195	1.006	1.403	0.28
	LTE 48	QPSK20M	Top Side	2	55340	50	0	DSI2	Ant5	1	62.9	23.00	21.53	0.15	0.252	1.006	1.403	0.36
	LTE 48	QPSK20M	Front Face	1	55340	1	50	DSI2	Ant7	1	62.9	22.00	20.50	-0.08	0.091	1.006	1.413	0.13
	LTE 48	QPSK20M	Rear Face	1	55340	1	50	DSI2	Ant7	1	62.9	22.00	20.50	0.14	0.510	1.006	1.435	0.74
	LTE 48	QPSK20M	Right Side	1	55340	1	50	DSI2	Ant7	1	62.9	22.00	20.50	-0.10	0.321	1.006	1.413	0.46
	LTE 48	QPSK20M	Top Side	1	55340	1	50	DSI2	Ant7	1	62.9	22.00	20.50	0.10	0.116	1.006	1.413	0.16
	LTE 48	QPSK20M	Front Face	1	55340	50	25	DSI2	Ant7	1	62.9	21.50	20.16	-0.10	0.079	1.006	1.361	0.11
	LTE 48	QPSK20M	Rear Face	1	55340	50	25	DSI2	Ant7	1	62.9	21.50	20.16	-0.08	0.552	1.006	1.361	0.76
	LTE 48	QPSK20M	Right Side	1	55340	50	25	DSI2	Ant7	1	62.9	21.50	20.16	-0.17	0.298	1.006	1.361	0.41
	LTE 48	QPSK20M	Top Side	1	55340	50	25	DSI2	Ant7	1	62.9	21.50	20.16	-0.16	0.102	1.006	1.361	0.14
	LTE 66	QPSK20M	Front Face	1	132322	1	50	DSI3/4	Ant1	1	-	19.00	17.98	0.09	0.249	1.000	1.265	0.31
	LTE 66	QPSK20M	Rear Face	1	132322	1	50	DSI3/4	Ant1	1	-	19.00	17.98	0.13	0.304	1.000	1.265	0.38
	LTE 66	QPSK20M	Left Side	1	132322	1	50	DSI2	Ant1	1	-	25.50	24.51	0.00	0.000	1.000	1.256	0.00
	LTE 66	QPSK20M	Right Side	1	132322	1	50	DSI2	Ant1	1	-	25.50	24.51	-0.04	0.142	1.000	1.256	0.18
	LTE 66	QPSK20M	Bottom Side	1	132322	1	50	DSI3/4	Ant1	1	-	19.00	17.98	-0.11	0.504	1.000	1.265	0.64
	LTE 66	QPSK20M	Front Face	1	132322	50	25	DSI3/4	Ant1	1	-	19.00	17.88	0.07	0.243	1.000	1.294	0.31
	LTE 66	QPSK20M	Rear Face	1	132322	50	25	DSI3/4	Ant1	1	-	19.00	17.88	0.15	0.314	1.000	1.294	0.41
	LTE 66	QPSK20M	Left Side	1	132322	50	25	DSI2	Ant1	1	-	24.50	23.56	0.00	0.000	1.000	1.242	0.00
	LTE 66	QPSK20M	Right Side	1	132322	50	25	DSI2	Ant1	1	-	24.50	23.56	-0.10	0.118	1.000	1.242	0.15
P73	LTE 66	QPSK20M	Bottom Side	1	132322	50	25	DSI3/4	Ant1	1	-	19.00	17.88	0.19	0.510	1.000	1.294	0.66
	LTE 66	QPSK20M	Front Face	2	132322	1	50	DSI2	Ant1	1	-	25.50	24.51	0.18	0.248	1.000	1.256	0.31
	LTE 66	QPSK20M	Rear Face	2	132322	1	50	DSI2	Ant1	1	-	25.50	24.51	0.04	0.304	1.000	1.256	0.38
	LTE 66	QPSK20M	Bottom Side	2	132322	1	50	DSI2	Ant1	1	-	25.50	24.51	-0.14	0.515	1.000	1.256	0.65
	LTE 66	QPSK20M	Front Face	2	132322	50	50	DSI2	Ant1	1	-	24.50	23.56	0.18	0.202	1.000	1.242	0.25
	LTE 66	QPSK20M	Rear Face	2	132322	50	50	DSI2	Ant1	1	-	24.50	23.56	0.14	0.251	1.000	1.242	0.31
	LTE 66	QPSK20M	Bottom Side	2	132322	50	50	DSI2	Ant1	1	-	24.50	23.56	-0.19	0.420	1.000	1.242	0.52
	LTE 66	QPSK20M	Front Face	1	132072	1	50	DSI4	Ant4	1	-	21.50	20.38	-0.16	0.268	1.000	1.294	0.35
	LTE 66	QPSK20M	Rear Face	1	132072	1	50	DSI4	Ant4	1	-	21.50	20.38	-0.06	0.438	1.000	1.294	0.57
	LTE 66	QPSK20M	Left Side	1	132072	1	50	DSI2	Ant4	1	-	25.00	23.63	0.19	0.161	1.000	1.371	0.22
	LTE 66	QPSK20M	Right Side	1	132072	1	50	DSI2	Ant4	1	-	25.00	23.63	0.15	0.112	1.000	1.371	0.15
	LTE 66	QPSK20M	Top Side	1	132072	1	50	DSI4	Ant4	1	-	21.50	20.38	-0.02	0.423	1.000	1.294	0.55
	LTE 66	QPSK20M	Front Face	1	132072	50	25	DSI4	Ant4	1	-	21.50	20.17	-0.04	0.290	1.000	1.358	0.39
	LTE 66	QPSK20M	Rear Face	1	132072	50	25	DSI4	Ant4	1	-	21.50	20.17	-0.15	0.405	1.000	1.358	0.55
	LTE 66	QPSK20M	Left Side	1	132072	50	25	DSI2	Ant4	1	-	24.00	22.81	-0.02	0.157	1.000	1.315	0.21
	LTE 66	QPSK20M	Right Side	1	132072	50	25	DSI2	Ant4	1	-	24.00	22.81	-0.04	0.096	1.000	1.315	0.13
	LTE 66	QPSK20M	Top Side	1	132072	50	25	DSI4	Ant4	1	-	21.50	20.17	-0.11	0.415	1.000	1.358	0.56
	LTE 66	QPSK20M	Front Face	2	132072	1	50	DSI2	Ant4	1	-	25.00	23.63	-0.09	0.159	1.000	1.371	0.22
	LTE 66	QPSK20M	Rear Face	2	132072	1	50	DSI2	Ant4	1	-	25.00	23.63	0.05	0.215	1.000	1.371	0.29
	LTE 66	QPSK20M	Top Side	2	132072	1	50	DSI2	Ant4	1	-	25.00	23.63	0.05	0.262	1.000	1.371	0.36
	LTE 66	QPSK20M	Front Face	2	132072	50	50	DSI2	Ant4	1	-	24.00	22.81	0.11	0.130	1.000	1.315	0.17
	LTE 66	QPSK20M	Rear Face	2	132072	50	50	DSI2	Ant4	1	-	24.00	22.81	-0.15	0.179	1.000	1.315	0.24
	LTE 66	QPSK20M	Top Side	2	132072	50	50	DSI2	Ant4	1	-	24.00	22.81	-0.03	0.220	1.000	1.315	0.29
	LTE 66	QPSK20M	Front Face	1	132322	1	50	DSI4	Ant3	1	-	21.00	19.72	-0.04	0.087	1.000	1.343	0.12
	LTE 66	QPSK20M	Rear Face	1	132322	1	50	DSI4	Ant3	1	-	21.00	19.72	0.10	0.123	1.000	1.343	0.17
	LTE 66	QPSK20M	Left Side	1	132322	1	50	DSI4	Ant3	1	-	21.00	19.72	0.06	0.209	1.000	1.343	0.28
	LTE 66	QPSK20M	Top Side	1	132322	1	50	DSI2	Ant3	1	-	25.50	23.95	-0.10	0.049	1.000	1.429	0.07
	LTE 66	QPSK20M	Front Face	1	132322	50	25	DSI4	Ant3	1	-	21.00	19.62	-0.09	0.087	1.000	1.374	0.12
	LTE 66	QPSK20M	Rear Face	1	132322	50	25	DSI4	Ant3	1	-	21.00	19.62	0.16	0.124	1.000	1.374	0.17
	LTE 66	QPSK20M	Left Side	1	132322	50	25	DSI4	Ant3	1	-	21.00						



BUREAU VERITAS

FCC SAR Test Report



Certificate #6613.01

Plot No.	Band	Mode	Test Position	Separation Distance (cm)	Ch.	RB#	RB Offset	Power State	Antenna	Sample	Duty Cycle %	Max. Tune-up Power (dBm)	Measured Conducted Power (dBm)	Power Drift (dB)	Measured SAR-1g (W/kg)	Duty Cycle Scaling Factor	Tune-up Scaling Factor	Scaled SAR-1g (W/kg)
	LTE 66	QPSK20M	Front Face	2	132322	1	50	DSI2	Ant3	1	-	25.50	23.95	0.01	0.050	1.000	1.429	0.07
	LTE 66	QPSK20M	Rear Face	2	132322	1	50	DSI2	Ant3	1	-	25.50	23.95	0.14	0.068	1.000	1.429	0.10
	LTE 66	QPSK20M	Left Side	1.5	132322	1	50	DSI2	Ant3	1	-	25.50	23.95	0.09	0.204	1.000	1.429	0.29
	LTE 66	QPSK20M	Front Face	2	132322	50	25	DSI2	Ant3	1	-	24.50	22.98	0.00	0.000	1.000	1.419	0.00
	LTE 66	QPSK20M	Rear Face	2	132322	50	25	DSI2	Ant3	1	-	24.50	22.98	-0.09	0.055	1.000	1.419	0.08
	LTE 66	QPSK20M	Left Side	1.5	132322	50	25	DSI2	Ant3	1	-	24.50	22.98	0.20	0.159	1.000	1.419	0.23
	LTE 66	QPSK20M	Rear Face	2	132322	1	50	DSI2	Ant3	1	-	25.50	23.95	0.14	0.068	1.000	1.429	0.10
	LTE 66	QPSK20M	Left Side	1.5	132322	1	50	DSI2	Ant3	1	-	25.50	23.95	0.09	0.204	1.000	1.429	0.29
	LTE 66	QPSK20M	Front Face	2	132322	50	25	DSI2	Ant3	1	-	24.50	22.98	0.00	0.000	1.000	1.419	0.00
	LTE 66	QPSK20M	Rear Face	2	132322	50	25	DSI2	Ant3	1	-	24.50	22.98	-0.09	0.055	1.000	1.419	0.08
	LTE 66	QPSK20M	Left Side	1.5	132322	50	25	DSI2	Ant3	1	-	24.50	22.98	0.20	0.159	1.000	1.419	0.23
	n2	DFT-QPSK20M	Front Face	1	376000	1	53	DSI3/4	Ant1	1	-	19.00	18.25	-0.19	0.284	1.000	1.189	0.34
	n2	DFT-QPSK20M	Rear Face	1	376000	1	53	DSI3/4	Ant1	1	-	19.00	18.25	0.02	0.306	1.000	1.189	0.36
	n2	DFT-QPSK20M	Left Side	1	376000	1	53	DSI2	Ant1	1	-	25.00	23.86	-0.01	0.081	1.000	1.300	0.11
	n2	DFT-QPSK20M	Right Side	1	376000	1	53	DSI2	Ant1	1	-	25.00	23.86	0.17	0.132	1.000	1.300	0.17
	n2	DFT-QPSK20M	Bottom Side	1	376000	1	53	DSI3/4	Ant1	1	-	19.00	18.25	-0.08	0.676	1.000	1.189	0.80
	n2	DFT-QPSK20M	Front Face	1	376000	50	28	DSI3/4	Ant1	1	-	19.00	18.31	0.06	0.265	1.000	1.172	0.31
	n2	DFT-QPSK20M	Rear Face	1	376000	50	28	DSI3/4	Ant1	1	-	19.00	18.31	0.13	0.276	1.000	1.172	0.32
	n2	DFT-QPSK20M	Left Side	1	376000	50	28	DSI2	Ant1	1	-	25.00	24.57	0.08	0.073	1.000	1.104	0.08
	n2	DFT-QPSK20M	Right Side	1	376000	50	28	DSI2	Ant1	1	-	25.00	24.57	0.08	0.137	1.000	1.104	0.15
	n2	DFT-QPSK20M	Bottom Side	1	376000	50	28	DSI3/4	Ant1	1	-	19.00	18.31	-0.14	0.613	1.000	1.172	0.72
	n2	DFT-QPSK20M	Front Face	2	376000	1	53	DSI2	Ant1	1	-	25.00	23.86	-0.12	0.216	1.000	1.300	0.28
	n2	DFT-QPSK20M	Rear Face	2	376000	1	53	DSI2	Ant1	1	-	25.00	23.86	0.08	0.265	1.000	1.300	0.34
	n2	DFT-QPSK20M	Bottom Side	2	376000	1	53	DSI2	Ant1	1	-	25.00	23.86	-0.13	0.542	1.000	1.300	0.70
	n2	DFT-QPSK20M	Front Face	2	376000	50	28	DSI2	Ant1	1	-	25.00	24.57	-0.14	0.210	1.000	1.104	0.23
	n2	DFT-QPSK20M	Rear Face	2	376000	50	28	DSI2	Ant1	1	-	25.00	24.57	-0.11	0.262	1.000	1.104	0.29
	n2	DFT-QPSK20M	Bottom Side	2	376000	50	28	DSI2	Ant1	1	-	25.00	24.57	0.13	0.524	1.000	1.104	0.58
	n2	DFT-QPSK20M	Bottom Side	1	372000	1	53	DSI3/4	Ant1	1	-	19.00	18.16	0.04	0.422	1.000	1.213	0.51
	n2	DFT-QPSK20M	Bottom Side	1	380000	1	53	DSI3/4	Ant1	1	-	19.00	18.13	-0.17	0.639	1.000	1.222	0.78
	n2	DFT-QPSK20M	Bottom Side	1	376000	100	0	DSI3/4	Ant1	1	-	19.00	18.16	0.08	0.504	1.000	1.213	0.61
	n2	DFT-QPSK20M	Front Face	1	376000	1	53	DSI4	Ant4	1	-	19.50	18.78	-0.04	0.360	1.000	1.180	0.42
	n2	DFT-QPSK20M	Rear Face	1	376000	1	53	DSI4	Ant4	1	-	19.50	18.78	-0.09	0.600	1.000	1.180	0.71
	n2	DFT-QPSK20M	Left Side	1	376000	1	53	DSI2	Ant4	1	-	24.50	23.54	0.03	0.317	1.000	1.247	0.40
	n2	DFT-QPSK20M	Right Side	1	376000	1	53	DSI2	Ant4	1	-	24.50	23.54	-0.16	0.110	1.000	1.247	0.14
	n2	DFT-QPSK20M	Top Side	1	376000	1	53	DSI4	Ant4	1	-	19.50	18.85	0.17	0.757	1.000	1.161	0.88
	n2	DFT-QPSK20M	Front Face	1	376000	50	28	DSI4	Ant4	1	-	19.50	18.85	0.18	0.385	1.000	1.161	0.45
	n2	DFT-QPSK20M	Rear Face	1	376000	50	28	DSI4	Ant4	1	-	19.50	18.85	-0.08	0.566	1.000	1.161	0.66
	n2	DFT-QPSK20M	Left Side	1	376000	50	28	DSI2	Ant4	1	-	24.50	23.84	0.16	0.352	1.000	1.164	0.41
	n2	DFT-QPSK20M	Right Side	1	376000	50	28	DSI2	Ant4	1	-	24.50	23.84	0.10	0.099	1.000	1.164	0.12
	n2	DFT-QPSK20M	Top Side	1	376000	50	28	DSI4	Ant4	1	-	19.50	18.85	0.03	0.763	1.000	1.161	0.89
	n2	DFT-QPSK20M	Front Face	2	376000	1	53	DSI2	Ant4	1	-	24.50	23.54	-0.13	0.225	1.000	1.247	0.28
	n2	DFT-QPSK20M	Rear Face	2	376000	1	53	DSI2	Ant4	1	-	24.50	23.54	0.10	0.396	1.000	1.247	0.49
	n2	DFT-QPSK20M	Top Side	2	376000	1	53	DSI2	Ant4	1	-	24.50	23.54	0.15	0.516	1.000	1.247	0.64
	n2	DFT-QPSK20M	Front Face	2	376000	50	28	DSI2	Ant4	1	-	24.50	23.84	0.06	0.229	1.000	1.164	0.27
	n2	DFT-QPSK20M	Rear Face	2	376000	50	28	DSI2	Ant4	1	-	24.50	23.84	-0.03	0.401	1.000	1.164	0.47
	n2	DFT-QPSK20M	Top Side	2	376000	50	28	DSI2	Ant4	1	-	24.50	23.84	-0.06	0.551	1.000	1.164	0.64
P74	n2	DFT-QPSK20M	Top Side	1	372000	1	53	DSI4	Ant4	1	-	19.50	18.75	0.09	0.788	1.000	1.189	0.94
	n2	DFT-QPSK20M	Top Side	1	380000	1	53	DSI4	Ant4	1	-	19.50	18.68	0.15	0.615	1.000	1.208	0.74
	n2	DFT-QPSK20M	Top Side	1	372000	50	28	DSI4	Ant4	1	-	19.50	18.79	0.07	0.749	1.000	1.178	0.88
	n2	DFT-QPSK20M	Top Side	1	380000	50	28	DSI4	Ant4	1	-	19.50	18.71	0.18	0.767	1.000	1.199	0.92
	n2	DFT-QPSK20M	Top Side	1	376000	100	0	DSI4	Ant4	1	-	19.50	18.70	0.11	0.752	1.000	1.202	0.90
	n7	DFT-QPSK50M	Front Face	1	507000	1	135	DSI3/4	Ant1	1	-	23.00	21.76	0.17	0.387	1.000	1.330	0.51
	n7	DFT-QPSK50M	Rear Face	1	507000	1	135	DSI3/4	Ant1	1	-	23.00	21.76	-0.17	0.341	1.000	1.330	0.45
	n7	DFT-QPSK50M	Left Side	1	507000	1	135	DSI2	Ant1	1	-	25.00	23.40	-0.05	0.176	1.000	1.445	0.25
	n7	DFT-QPSK50M	Right Side	1	507000	1	135	DSI2	Ant1	1	-	25.00	23.40	-0.14	0.217	1.000	1.445	0.31
	n7	DFT-QPSK50M	Bottom Side	1	507000	1	135	DSI3/4	Ant1	1	-	23.00	21.76	-0.07	0.541	1.000	1.330	0.72
	n7	DFT-QPSK50M	Front Face	1	507000	135	68	DSI3/4	Ant1	1	-	23.00	21.88	-0.12	0.386	1.000	1.294	0.50
	n7	DFT-QPSK50M	Rear Face	1	507000	135	68	DSI3/4	Ant1	1	-	23.00	21.88	0.00	0.360	1.000	1.294	0.47
	n7	DFT-QPSK50M	Left Side	1	507000	135	68	DSI2	Ant1	1	-	25.00	24.05	-0.11	0.212	1.000	1.245	0.26
	n7	DFT-QPSK50M	Right Side	1	507000	135	68	DSI2	Ant1	1	-	25.00	24.05	-0.05	0.248	1.000	1.245	0.31
	n7	DFT-QPSK50M	Bottom Side	1	507000	135	68	DSI3/4	Ant1	1	-	23.00	21.67	0.18	0.525	1.000	1.358	0.71
	n7	DFT-QPSK50M	Front Face	2	507000	1	135	DSI2	Ant1	1	-	25.00	23.40	0.02	0.196	1.000	1.445	0.28
	n7	DFT-QPSK50M	Rear Face	2	507000	1	135	DSI2	Ant1	1	-	25.00	23.40	-0.07	0.210	1.000	1.445	0.30
	n7	DFT-QPSK50M	Bottom Side	2	507000	1	135	DSI2	Ant1	1	-	25.00	23.40	-0.12	0.279	1.000	1.445	0.40
	n7	DFT-QPSK50M	Front Face	2	507000	135	68	DSI2	Ant1	1	-	25.00	24.05	-0.15	0.204	1.000	1.245	0.25
	n7	DFT-QPSK50M	Rear Face	2	507000	135	68	DSI2	Ant1	1	-	25.00	24.05	0.07	0.213	1.000	1.245	0.27
	n7	DFT-QPSK50M	Bottom Side	2	507000	135	68	DSI2	Ant1	1	-	25.00	24.05	0.11	0.290	1.000	1.245	0.36
	n7	DFT-QPSK50M	Front Face	1	505000	1	135	DSI4	Ant4	1	-	19.50	18.74	0.05	0.260	1.000	1.191	0.31
	n7	DFT-QPSK50M	Rear Face	1	505000	1	135	DSI4	Ant4	1	-	19.50	18.74	-0.02	0.503	1.000	1.191	0.60
	n7	DFT-QPSK50M	Left Side	1	505000	1	135	DSI2	Ant4	1	-	24.50	23.57	0.13	0.223	1.000	1.239	0.28
	n7	DFT-QPSK50M	Right Side	1	505000	1	135	DSI2	Ant4	1	-	24.50	23.57	0.18	0.106	1.000	1.239	0.13
P75	n7	DFT-QPSK50M	Top Side	1	505000	1	135	DSI4	Ant4	1	-	19.50	18.74	0.01	0.701	1.000	1.191	0.84
	n7	DFT-QPSK50M	Front Face	1	505000	135	68	DSI4	Ant4	1	-	19.50	18.85	-0.16	0.258	1.000	1.161	0.30
	n7	DFT-QPSK50M	Rear Face	1	505000	135	68	DSI4	Ant4	1	-	19.50	18.85	0.15	0.501	1.000	1.161	0.58
	n7	DFT-QPSK50M	Left Side	1	505000	135	68	DSI2	Ant4	1	-	24.50	24.04</					



BUREAU VERITAS

FCC SAR Test Report



Certificate #6613.01

Plot No.	Band	Mode	Test Position	Separation Distance (cm)	Ch.	RB#	RB Offset	Power State	Antenna	Sample	Duty Cycle %	Max. Tune-up Power (dBm)	Measured Conducted Power (dBm)	Power Drift (dB)	Measured SAR-1g (W/kg)	Duty Cycle Scaling Factor	Tune-up Scaling Factor	Scaled SAR-1g (W/kg)
	n7	DFT-QPSK50M	Right Side	1	505000	135	68	DSI2	Ant4	1	-	24.50	24.04	0.19	0.101	1.000	1.112	0.11
	n7	DFT-QPSK50M	Top Side	1	505000	135	68	DSI4	Ant4	1	-	19.50	18.85	-0.11	0.718	1.000	1.161	0.83
	n7	DFT-QPSK50M	Front Face	2	505000	1	135	DSI2	Ant4	1	-	24.50	23.57	-0.12	0.201	1.000	1.239	0.25
	n7	DFT-QPSK50M	Rear Face	2	505000	1	135	DSI2	Ant4	1	-	24.50	23.57	0.05	0.344	1.000	1.239	0.43
	n7	DFT-QPSK50M	Top Side	2	505000	1	135	DSI2	Ant4	1	-	24.50	23.57	0.16	0.491	1.000	1.239	0.61
	n7	DFT-QPSK50M	Front Face	2	505000	135	68	DSI2	Ant4	1	-	24.50	24.04	0.02	0.203	1.000	1.112	0.23
	n7	DFT-QPSK50M	Rear Face	2	505000	135	68	DSI2	Ant4	1	-	24.50	24.04	0.09	0.345	1.000	1.112	0.38
	n7	DFT-QPSK50M	Top Side	2	505000	135	68	DSI2	Ant4	1	-	24.50	24.04	0.05	0.510	1.000	1.112	0.57
	n7	DFT-QPSK50M	Top Side	1	507000	1	135	DSI4	Ant4	1	-	19.50	18.69	0.08	0.681	1.000	1.205	0.82
	n7	DFT-QPSK50M	Top Side	1	509000	1	135	DSI4	Ant4	1	-	19.50	18.70	0.13	0.679	1.000	1.202	0.82
	n7	DFT-QPSK50M	Top Side	1	507000	135	68	DSI4	Ant4	1	-	19.50	18.80	-0.10	0.592	1.000	1.175	0.70
	n7	DFT-QPSK50M	Top Side	1	509000	135	68	DSI4	Ant4	1	-	19.50	18.78	-0.12	0.590	1.000	1.180	0.70
	n7	DFT-QPSK50M	Top Side	1	505000	270	0	DSI4	Ant4	1	-	19.50	18.63	0.08	0.637	1.000	1.222	0.78
	n12	DFT-QPSK15M	Front Face	1	141500	1	38	DSI3/4	Ant1	1	-	25.50	24.40	0.06	0.169	1.000	1.288	0.22
	n12	DFT-QPSK15M	Rear Face	1	141500	1	38	DSI3/4	Ant1	1	-	25.50	24.40	-0.01	0.181	1.000	1.288	0.23
	n12	DFT-QPSK15M	Left Side	1	141500	1	38	DSI2	Ant1	1	-	25.50	24.40	0.04	0.037	1.000	1.288	0.05
	n12	DFT-QPSK15M	Right Side	1	141500	1	38	DSI2	Ant1	1	-	25.50	24.40	0.12	0.112	1.000	1.288	0.14
	n12	DFT-QPSK15M	Bottom Side	1	141500	1	38	DSI3/4	Ant1	1	-	25.50	24.40	0.09	0.166	1.000	1.288	0.21
	n12	DFT-QPSK15M	Front Face	1	141500	36	22	DSI3/4	Ant1	1	-	25.50	24.56	0.12	0.172	1.000	1.242	0.21
P76	n12	DFT-QPSK15M	Rear Face	1	141500	36	22	DSI3/4	Ant1	1	-	25.50	24.56	0.01	0.195	1.000	1.242	0.24
	n12	DFT-QPSK15M	Left Side	1	141500	36	22	DSI2	Ant1	1	-	25.50	24.56	0.01	0.038	1.000	1.242	0.05
	n12	DFT-QPSK15M	Right Side	1	141500	36	22	DSI2	Ant1	1	-	25.50	24.56	0.05	0.109	1.000	1.242	0.14
	n12	DFT-QPSK15M	Bottom Side	1	141500	36	22	DSI3/4	Ant1	1	-	25.50	24.56	-0.13	0.160	1.000	1.242	0.20
	n12	DFT-QPSK15M	Front Face	1	141500	1	38	DSI3/4	Ant4	1	-	25.00	23.80	0.07	0.109	1.000	1.318	0.14
	n12	DFT-QPSK15M	Rear Face	1	141500	1	38	DSI3/4	Ant4	1	-	25.00	23.80	0.06	0.146	1.000	1.318	0.19
	n12	DFT-QPSK15M	Left Side	1	141500	1	38	DSI2	Ant4	1	-	25.00	23.80	-0.18	0.116	1.000	1.318	0.15
	n12	DFT-QPSK15M	Right Side	1	141500	1	38	DSI2	Ant4	1	-	25.00	23.80	0.04	0.089	1.000	1.318	0.12
	n12	DFT-QPSK15M	Top Side	1	141500	1	38	DSI3/4	Ant4	1	-	25.00	23.80	0.15	0.155	1.000	1.318	0.20
	n12	DFT-QPSK15M	Front Face	1	141500	36	22	DSI3/4	Ant4	1	-	25.00	23.92	0.04	0.107	1.000	1.282	0.14
	n12	DFT-QPSK15M	Rear Face	1	141500	36	22	DSI3/4	Ant4	1	-	25.00	23.92	0.05	0.147	1.000	1.282	0.19
	n12	DFT-QPSK15M	Left Side	1	141500	36	22	DSI2	Ant4	1	-	25.00	23.92	0.14	0.183	1.000	1.282	0.23
	n12	DFT-QPSK15M	Right Side	1	141500	36	22	DSI2	Ant4	1	-	25.00	23.92	-0.11	0.076	1.000	1.282	0.10
	n12	DFT-QPSK15M	Top Side	1	141500	36	22	DSI3/4	Ant4	1	-	25.00	23.92	0.08	0.146	1.000	1.282	0.19
	n26	DFT-QPSK20M	Front Face	1	166300	1	53	DSI3/4	Ant1	1	-	25.50	24.54	0.04	0.223	1.000	1.247	0.28
P77	n26	DFT-QPSK20M	Rear Face	1	166300	1	53	DSI3/4	Ant1	1	-	25.50	24.54	0.01	0.379	1.000	1.247	0.47
	n26	DFT-QPSK20M	Left Side	1	166300	1	53	DSI2	Ant1	1	-	25.50	24.54	-0.07	0.095	1.000	1.247	0.12
	n26	DFT-QPSK20M	Right Side	1	166300	1	53	DSI2	Ant1	1	-	25.50	24.54	0.01	0.226	1.000	1.247	0.28
	n26	DFT-QPSK20M	Bottom Side	1	166300	1	53	DSI3/4	Ant1	1	-	25.50	24.54	0.09	0.291	1.000	1.247	0.36
	n26	DFT-QPSK20M	Front Face	1	166300	50	28	DSI3/4	Ant1	1	-	25.50	24.70	-0.17	0.216	1.000	1.202	0.26
	n26	DFT-QPSK20M	Rear Face	1	166300	50	28	DSI3/4	Ant1	1	-	25.50	24.70	0.13	0.315	1.000	1.202	0.38
	n26	DFT-QPSK20M	Left Side	1	166300	50	28	DSI2	Ant1	1	-	25.50	24.70	-0.01	0.096	1.000	1.202	0.12
	n26	DFT-QPSK20M	Right Side	1	166300	50	28	DSI2	Ant1	1	-	25.50	24.70	0.06	0.218	1.000	1.202	0.26
	n26	DFT-QPSK20M	Bottom Side	1	166300	50	28	DSI3/4	Ant1	1	-	25.50	24.70	0.05	0.287	1.000	1.202	0.35
	n26	DFT-QPSK20M	Front Face	1	166300	1	53	DSI4	Ant4	1	-	25.00	24.03	-0.05	0.181	1.000	1.250	0.23
	n26	DFT-QPSK20M	Rear Face	1	166300	1	53	DSI4	Ant4	1	-	25.00	24.03	-0.04	0.231	1.000	1.250	0.29
	n26	DFT-QPSK20M	Left Side	1	166300	1	53	DSI2	Ant4	1	-	25.00	24.03	0.13	0.150	1.000	1.250	0.19
	n26	DFT-QPSK20M	Right Side	1	166300	1	53	DSI2	Ant4	1	-	25.00	24.03	0.07	0.103	1.000	1.250	0.13
	n26	DFT-QPSK20M	Top Side	1	166300	1	53	DSI4	Ant4	1	-	25.00	24.03	0.16	0.208	1.000	1.250	0.26
	n26	DFT-QPSK20M	Front Face	1	166300	50	28	DSI4	Ant4	1	-	25.00	24.20	0.06	0.170	1.000	1.202	0.20
	n26	DFT-QPSK20M	Rear Face	1	166300	50	28	DSI4	Ant4	1	-	25.00	24.20	0.13	0.230	1.000	1.202	0.28
	n26	DFT-QPSK20M	Left Side	1	166300	50	28	DSI2	Ant4	1	-	25.00	24.20	0.06	0.149	1.000	1.202	0.18
	n26	DFT-QPSK20M	Right Side	1	166300	50	28	DSI2	Ant4	1	-	25.00	24.20	-0.05	0.094	1.000	1.202	0.11
	n26	DFT-QPSK20M	Top Side	1	166300	50	28	DSI4	Ant4	1	-	25.00	24.20	-0.13	0.219	1.000	1.202	0.26
	n38	DFT-QPSK40M	Front Face	1	518000	1	53	DSI3/4	Ant1	1	100	23.50	22.53	0.04	0.403	1.000	1.250	0.50
	n38	DFT-QPSK40M	Rear Face	1	518000	1	53	DSI3/4	Ant1	1	100	23.50	22.53	0.19	0.414	1.000	1.250	0.52
	n38	DFT-QPSK40M	Left Side	1	518000	1	53	DSI2	Ant1	1	100	25.00	24.11	-0.01	0.151	1.000	1.227	0.19
	n38	DFT-QPSK40M	Right Side	1	518000	1	53	DSI2	Ant1	1	100	25.00	24.11	0.16	0.158	1.000	1.227	0.19
	n38	DFT-QPSK40M	Bottom Side	1	518000	1	53	DSI3/4	Ant1	1	100	23.50	22.53	-0.04	0.689	1.000	1.250	0.86
	n38	DFT-QPSK40M	Front Face	1	518000	50	28	DSI3/4	Ant1	1	100	23.50	22.54	-0.18	0.389	1.000	1.247	0.49
	n38	DFT-QPSK40M	Rear Face	1	518000	50	28	DSI3/4	Ant1	1	100	23.50	22.54	0.15	0.411	1.000	1.247	0.51
	n38	DFT-QPSK40M	Left Side	1	518000	50	28	DSI2	Ant1	1	100	25.00	24.14	0.16	0.138	1.000	1.219	0.17
	n38	DFT-QPSK40M	Right Side	1	518000	50	28	DSI2	Ant1	1	100	25.00	24.14	0.15	0.126	1.000	1.219	0.15
	n38	DFT-QPSK40M	Bottom Side	1	518000	50	28	DSI3/4	Ant1	1	100	23.50	22.54	-0.13	0.688	1.000	1.247	0.86
	n38	DFT-QPSK40M	Front Face	2	518000	1	53	DSI2	Ant1	1	100	25.00	24.11	-0.14	0.209	1.000	1.227	0.26
	n38	DFT-QPSK40M	Rear Face	2	518000	1	53	DSI2	Ant1	1	100	25.00	24.11	0.08	0.233	1.000	1.227	0.29
	n38	DFT-QPSK40M	Bottom Side	2	518000	1	53	DSI2	Ant1	1	100	25.00	24.11	0.05	0.351	1.000	1.227	0.43
	n38	DFT-QPSK40M	Front Face	2	518000	50	28	DSI2	Ant1	1	100	25.00	24.14	0.15	0.200	1.000	1.219	0.24
	n38	DFT-QPSK40M	Rear Face	2	518000	50	28	DSI2	Ant1	1	100	25.00	24.14	0.06	0.217	1.000	1.219	0.26
	n38	DFT-QPSK40M	Bottom Side	2	518000	50	28	DSI2	Ant1	1	100	25.00	24.14	0.04	0.327	1.000	1.219	0.40
	n38	DFT-QPSK40M	Bottom Side	1	519000	1	53	DSI3/4	Ant1	1	100	23.50	22.42	0.01	0.674	1.000	1.282	0.86
	n38	DFT-QPSK40M	Bottom Side	1	520000	1	53	DSI3/4	Ant1	1	100	23.50	22.46	0.12	0.680	1.000	1.271	0.86
	n38	DFT-QPSK40M	Bottom Side	1	519000	50	28	DSI3/4	Ant1	1	100	23.50	22.49	0.10	0.680	1.000	1.262	0.86
	n38	DFT-QPSK40M	Bottom Side	1	520000	50	28	DSI3/4	Ant1	1	100	23.50	22.47	-0.03	0.681	1.000	1.268	0.86
	n38	DFT-QPSK40M	Bottom Side	1	518000	100	0	DSI3/4	Ant1	1	100	23.50	22.48	0.03	0.666	1.000	1.265	0.8



BUREAU VERITAS

FCC SAR Test Report



Certificate #6613.01

Plot No.	Band	Mode	Test Position	Separation Distance (cm)	Ch.	RB#	RB Offset	Power State	Antenna	Sample	Duty Cycle %	Max. Tune-up Power (dBm)	Measured Conducted Power (dBm)	Power Drift (dB)	Measured SAR-1g (W/kg)	Duty Cycle Scaling Factor	Tune-up Scaling Factor	Scaled SAR-1g (W/kg)
	n38	DFT-QPSK40M	Front Face	1	520000	1	53	DSI4	Ant4	1	100	20.00	19.11	0.01	0.288	1.000	1.227	0.35
	n38	DFT-QPSK40M	Rear Face	1	520000	1	53	DSI4	Ant4	1	100	20.00	19.11	-0.04	0.505	1.000	1.227	0.62
	n38	DFT-QPSK40M	Left Side	1	520000	1	53	DSI2	Ant4	1	100	24.50	23.54	0.09	0.165	1.000	1.247	0.21
	n38	DFT-QPSK40M	Right Side	1	520000	1	53	DSI2	Ant4	1	100	24.50	23.54	0.07	0.129	1.000	1.247	0.16
P78	n38	DFT-QPSK40M	Top Side	1	520000	1	53	DSI4	Ant4	1	100	20.00	19.11	-0.04	0.731	1.000	1.227	0.90
	n38	DFT-QPSK40M	Front Face	1	520000	50	28	DSI4	Ant4	1	100	20.00	19.16	-0.17	0.292	1.000	1.213	0.35
	n38	DFT-QPSK40M	Rear Face	1	520000	50	28	DSI4	Ant4	1	100	20.00	19.16	-0.10	0.502	1.000	1.213	0.61
	n38	DFT-QPSK40M	Left Side	1	520000	50	28	DSI2	Ant4	1	100	24.50	23.59	0.17	0.159	1.000	1.233	0.20
	n38	DFT-QPSK40M	Right Side	1	520000	50	28	DSI2	Ant4	1	100	24.50	23.59	0.11	0.123	1.000	1.233	0.15
	n38	DFT-QPSK40M	Top Side	1	520000	50	28	DSI4	Ant4	1	100	20.00	19.16	-0.08	0.717	1.000	1.213	0.87
	n38	DFT-QPSK40M	Front Face	2	520000	1	53	DSI2	Ant4	1	100	24.50	23.54	0.14	0.192	1.000	1.247	0.24
	n38	DFT-QPSK40M	Rear Face	2	520000	1	53	DSI2	Ant4	1	100	24.50	23.54	0.12	0.320	1.000	1.247	0.40
	n38	DFT-QPSK40M	Top Side	2	520000	1	53	DSI2	Ant4	1	100	24.50	23.54	0.17	0.456	1.000	1.247	0.57
	n38	DFT-QPSK40M	Front Face	2	520000	50	28	DSI2	Ant4	1	100	24.50	23.59	0.18	0.197	1.000	1.233	0.24
	n38	DFT-QPSK40M	Rear Face	2	520000	50	28	DSI2	Ant4	1	100	24.50	23.59	0.06	0.332	1.000	1.233	0.41
	n38	DFT-QPSK40M	Top Side	2	520000	50	28	DSI2	Ant4	1	100	24.50	23.59	-0.02	0.463	1.000	1.233	0.57
	n38	DFT-QPSK40M	Top Side	1	518000	1	53	DSI4	Ant4	1	100	20.00	19.05	-0.01	0.629	1.000	1.245	0.78
	n38	DFT-QPSK40M	Top Side	1	519000	1	53	DSI4	Ant4	1	100	20.00	19.09	0.19	0.627	1.000	1.233	0.77
	n38	DFT-QPSK40M	Top Side	1	518000	50	28	DSI4	Ant4	1	100	20.00	19.04	0.08	0.715	1.000	1.247	0.89
	n38	DFT-QPSK40M	Top Side	1	519000	50	28	DSI4	Ant4	1	100	20.00	19.06	-0.18	0.714	1.000	1.242	0.89
	n38	DFT-QPSK40M	Top Side	1	520000	100	0	DSI4	Ant4	1	100	20.00	18.96	0.16	0.696	1.000	1.271	0.88
	n41	DFT-QPSK100M	Front Face	1	518598	1	137	DSI3/4	Ant1	1	100	22.50	21.38	-0.19	0.344	1.000	1.294	0.45
	n41	DFT-QPSK100M	Rear Face	1	518598	1	137	DSI3/4	Ant1	1	100	22.50	21.38	-0.05	0.370	1.000	1.294	0.48
	n41	DFT-QPSK100M	Left Side	1	518598	1	137	DSI2	Ant1	1	100	25.00	24.01	0.18	0.183	1.000	1.256	0.23
	n41	DFT-QPSK100M	Right Side	1	518598	1	137	DSI2	Ant1	1	100	25.00	24.01	-0.10	0.223	1.000	1.256	0.28
	n41	DFT-QPSK100M	Bottom Side	1	518598	1	137	DSI3/4	Ant1	1	100	22.50	21.38	0.18	0.584	1.000	1.294	0.76
	n41	DFT-QPSK100M	Front Face	1	518598	135	69	DSI3/4	Ant1	1	100	22.50	21.48	-0.07	0.358	1.000	1.265	0.45
	n41	DFT-QPSK100M	Rear Face	1	518598	135	69	DSI3/4	Ant1	1	100	22.50	21.48	-0.11	0.360	1.000	1.265	0.46
	n41	DFT-QPSK100M	Left Side	1	518598	135	69	DSI2	Ant1	1	100	25.00	24.06	-0.01	0.182	1.000	1.242	0.23
	n41	DFT-QPSK100M	Right Side	1	518598	135	69	DSI2	Ant1	1	100	25.00	24.06	-0.03	0.226	1.000	1.242	0.28
	n41	DFT-QPSK100M	Bottom Side	1	518598	135	69	DSI3/4	Ant1	1	100	22.50	21.48	-0.02	0.615	1.000	1.265	0.78
	n41	DFT-QPSK100M	Front Face	2	518598	1	137	DSI2	Ant1	1	100	25.00	24.01	-0.14	0.203	1.000	1.256	0.25
	n41	DFT-QPSK100M	Rear Face	2	518598	1	137	DSI2	Ant1	1	100	25.00	24.01	-0.13	0.230	1.000	1.256	0.29
	n41	DFT-QPSK100M	Bottom Side	2	518598	1	137	DSI2	Ant1	1	100	25.00	24.01	0.08	0.354	1.000	1.256	0.44
	n41	DFT-QPSK100M	Front Face	2	518598	135	69	DSI2	Ant1	1	100	25.00	24.06	0.16	0.217	1.000	1.242	0.27
	n41	DFT-QPSK100M	Rear Face	2	518598	135	69	DSI2	Ant1	1	100	25.00	24.06	0.13	0.231	1.000	1.242	0.29
	n41	DFT-QPSK100M	Bottom Side	2	518598	135	69	DSI2	Ant1	1	100	25.00	24.06	0.05	0.359	1.000	1.242	0.45
	n41	DFT-QPSK100M	Front Face	1	518598	1	137	DSI4	Ant3	1	100	20.50	19.53	-0.19	0.166	1.000	1.250	0.21
	n41	DFT-QPSK100M	Rear Face	1	518598	1	137	DSI4	Ant3	1	100	20.50	19.53	-0.13	0.274	1.000	1.250	0.34
	n41	DFT-QPSK100M	Left Side	1	518598	1	137	DSI4	Ant3	1	100	20.50	19.53	0.02	0.442	1.000	1.250	0.55
	n41	DFT-QPSK100M	Top Side	1	518598	1	137	DSI2	Ant3	1	100	22.00	21.26	0.00	0.000	1.000	1.186	0.00
	n41	DFT-QPSK100M	Front Face	1	518598	135	69	DSI4	Ant3	1	100	20.50	19.61	-0.09	0.165	1.000	1.227	0.20
	n41	DFT-QPSK100M	Rear Face	1	518598	135	69	DSI4	Ant3	1	100	20.50	19.61	-0.12	0.273	1.000	1.227	0.34
	n41	DFT-QPSK100M	Left Side	1	518598	135	69	DSI4	Ant3	1	100	20.50	19.61	-0.07	0.465	1.000	1.227	0.57
	n41	DFT-QPSK100M	Top Side	1	518598	135	69	DSI2	Ant3	1	100	22.00	21.28	0.18	0.044	1.000	1.180	0.05
	n41	DFT-QPSK100M	Front Face	2	518598	1	137	DSI2	Ant3	1	100	22.00	21.26	-0.19	0.063	1.000	1.186	0.07
	n41	DFT-QPSK100M	Rear Face	2	518598	1	137	DSI2	Ant3	1	100	22.00	21.26	-0.05	0.086	1.000	1.186	0.10
	n41	DFT-QPSK100M	Left Side	1.5	518598	1	137	DSI2	Ant3	1	100	22.00	21.26	0.03	0.267	1.000	1.186	0.32
	n41	DFT-QPSK100M	Front Face	2	518598	135	69	DSI2	Ant3	1	100	22.00	21.28	-0.17	0.063	1.000	1.180	0.07
	n41	DFT-QPSK100M	Rear Face	2	518598	135	69	DSI2	Ant3	1	100	22.00	21.28	0.09	0.086	1.000	1.180	0.10
	n41	DFT-QPSK100M	Left Side	1.5	518598	135	69	DSI2	Ant3	1	100	22.00	21.28	-0.01	0.279	1.000	1.180	0.33
	n41	DFT-QPSK100M	Front Face	1	518598	1	137	DSI4	Ant4	1	100	20.00	19.27	-0.16	0.283	1.000	1.183	0.33
	n41	DFT-QPSK100M	Rear Face	1	518598	1	137	DSI4	Ant4	1	100	20.00	19.27	-0.13	0.541	1.000	1.183	0.64
	n41	DFT-QPSK100M	Left Side	1	518598	1	137	DSI2	Ant4	1	100	24.50	24.04	0.16	0.184	1.000	1.112	0.20
	n41	DFT-QPSK100M	Right Side	1	518598	1	137	DSI2	Ant4	1	100	24.50	24.04	-0.13	0.135	1.000	1.112	0.15
	n41	DFT-QPSK100M	Top Side	1	518598	1	137	DSI4	Ant4	1	100	20.00	19.27	-0.04	0.641	1.000	1.183	0.76
	n41	DFT-QPSK100M	Front Face	1	518598	135	69	DSI4	Ant4	1	100	20.00	19.29	-0.08	0.299	1.000	1.178	0.35
	n41	DFT-QPSK100M	Rear Face	1	518598	135	69	DSI4	Ant4	1	100	20.00	19.29	-0.02	0.553	1.000	1.178	0.65
	n41	DFT-QPSK100M	Left Side	1	518598	135	69	DSI2	Ant4	1	100	24.50	24.06	-0.05	0.195	1.000	1.107	0.22
	n41	DFT-QPSK100M	Right Side	1	518598	135	69	DSI2	Ant4	1	100	24.50	24.06	0.18	0.133	1.000	1.107	0.15
	n41	DFT-QPSK100M	Top Side	1	518598	135	69	DSI4	Ant4	1	100	20.00	19.29	0.06	0.769	1.000	1.178	0.91
	n41	DFT-QPSK100M	Front Face	2	518598	1	137	DSI2	Ant4	1	100	24.50	24.04	0.13	0.232	1.000	1.112	0.26
	n41	DFT-QPSK100M	Rear Face	2	518598	1	137	DSI2	Ant4	1	100	24.50	24.04	-0.18	0.288	1.000	1.112	0.32
	n41	DFT-QPSK100M	Top Side	2	518598	1	137	DSI2	Ant4	1	100	24.50	24.04	0.08	0.553	1.000	1.112	0.61
	n41	DFT-QPSK100M	Front Face	2	518598	135	69	DSI2	Ant4	1	100	24.50	24.06	-0.11	0.235	1.000	1.107	0.26
	n41	DFT-QPSK100M	Rear Face	2	518598	135	69	DSI2	Ant4	1	100	24.50	24.06	-0.17	0.390	1.000	1.107	0.43
	n41	DFT-QPSK100M	Top Side	2	518598	135	69	DSI2	Ant4	1	100	24.50	24.06	-0.10	0.556	1.000	1.107	0.62
P79	n41	DFT-QPSK100M	Top Side	1	509202	135	69	DSI4	Ant4	1	100	20.00	19.11	0.01	0.809	1.000	1.227	0.99
	n41	DFT-QPSK100M	Top Side	1	528000	135	69	DSI4	Ant4	1	100	20.00	19.18	-0.09	0.666	1.000	1.208	0.80
	n41	DFT-QPSK100M	Top Side	1	518598	270	0	DSI4	Ant4	1	100	20.00	19.14	-0.05	0.682	1.000	1.219	0.83
	n41	DFT-QPSK100M	Front Face	1	518598	1	137	DSI2	Ant7	1	100	21.00	20.24	-0.17	0.137	1.000	1.191	0.16
	n41	DFT-QPSK100M	Rear Face	1	518598	1	137	DSI2	Ant7	1	100	21.00	20.24	0.15	0.243	1.000	1.191	0.29
	n41	DFT-QPSK100M	Right Side	1	518598	1	137	DSI2	Ant7	1	100	21.00</						