



# FCC RF Test Report

APPLICANT : Xiaomi Communications Co., Ltd.  
EQUIPMENT : Mobile Phone  
BRAND NAME : Redmi  
MODEL NAME : 24090RA29G  
FCC ID : 2AFZZRA29G  
STANDARD : 47 CFR Part 96  
CLASSIFICATION : Citizens Band End User Devices (CBE)  
EQUIPMENT TYPE : End User Equipment  
TEST DATE(S) : Jul. 23, 2024 ~ Jul. 24, 2024

We, Sporton International Inc. (Kunshan), would like to declare that the tested sample has been evaluated in accordance with the procedures given in ANSI C63.26 and shown compliance with the applicable technical standards.

The test results in this report apply exclusively to the tested model / sample. Without written approval of Sporton International Inc. (Kunshan), the test report shall not be reproduced except in full.

Jason Jia



Approved by: Jason Jia

**Sporton International Inc. (Kunshan)**

No. 1098, Pengxi North Road, Kunshan Economic Development Zone Jiangsu Province 215300  
People's Republic of China



# Table of Contents

**History of this test report..... 3**

**Summary of Test Result..... 4**

**1 General Description ..... 5**

    1.1 Applicant..... 5

    1.2 Manufacturer ..... 5

    1.3 Feature of Equipment Under Test..... 5

    1.4 Maximum EIRP Power and Emission Designator ..... 6

    1.5 Testing Site..... 6

    1.6 Test Software ..... 6

    1.7 Applied Standards ..... 7

**2 Test Configuration of Equipment Under Test ..... 8**

    2.1 Test Mode..... 8

    2.2 Connection Diagram of Test System ..... 9

    2.3 Support Unit used in test configuration ..... 9

    2.4 Measurement Results Explanation Example ..... 9

    2.5 Frequency List of Low/Middle/High Channels..... 10

**3 Conducted Test Items..... 11**

    3.1 Measuring Instruments..... 11

    3.2 Test Setup ..... 11

    3.3 Conducted Output Power ..... 12

    3.4 EIRP ..... 13

    3.5 Occupied Bandwidth ..... 14

    3.6 Conducted Band Edge ..... 15

    3.7 Conducted Spurious Emission ..... 16

    3.8 Frequency Stability..... 17

**4 Radiated Test Items ..... 18**

    4.1 Measuring Instruments..... 18

    4.2 Test Setup ..... 18

    4.3 Test Result of Radiated Test..... 19

    4.4 Radiated Spurious Emission ..... 20

**5 List of Measuring Equipment..... 21**

**6 Measurement Uncertainty ..... 22**

**Appendix A. Test Results of Conducted Test**

**Appendix B. Test Results of Radiated Test**

**Appendix C. Test Setup Photographs**



### History of this test report

Report No.	Version	Description	Issued Date
FG471506F	01	Initial issue of report	Aug. 19, 2024



### Summary of Test Result

Report Clause	Ref Std. Clause	Test Items	Result (PASS/FAIL)	Remark
3.3	§2.1046	Conducted Output Power	Reporting only	-
-	§96.41	Peak-to-Average Ratio	Not Applicable	Not applicable for End User Devices
3.4	§96.41	Maximum E.I.R.P	Pass	-
		Maximum Power Spectral Density	Not Applicable	Not applicable for End User Devices
3.5	§2.1049 §96.41	Occupied Bandwidth	Reporting only	-
3.6	§2.1051 §96.41	Conducted Band Edge Measurement Adjacent Channel Leakage Ratio	Pass	-
3.7	§2.1051 §96.41	Conducted Spurious Emission	Pass	
3.8	§2.1055	Frequency Stability for Temperature & Voltage	Pass	-
4.4	§2.1051 §96.41	Radiated Spurious Emission	Pass	Under limit 7.27 dB at 7231.00 MHz

<b>Conformity Assessment Condition:</b>
1. The test results (PASS/FAIL) with all measurement uncertainty excluded are presented against the regulation limits or in accordance with the requirements stipulated by the applicant/manufacturer who shall bear all the risks of non-compliance that may potentially occur if measurement uncertainty is taken into account.
2. The measurement uncertainty please refer to each test result in the section "Measurement Uncertainty"
<b>Disclaimer:</b>
The product specifications of the EUT presented in the test report that may affect the test assessments are declared by the manufacturer who shall take full responsibility for the authenticity.



# 1 General Description

## 1.1 Applicant

Xiaomi Communications Co., Ltd.

#019, 9th Floor, Building 6, 33 Xi'erqi Middle Road, Haidian District, Beijing, China, 100085

## 1.2 Manufacturer

Xiaomi Communications Co., Ltd.

#019, 9th Floor, Building 6, 33 Xi'erqi Middle Road, Haidian District, Beijing, China, 100085

## 1.3 Feature of Equipment Under Test

Product Feature	
Equipment	Mobile Phone
Brand Name	Redmi
Model Name	24090RA29G
FCC ID	2AFZZRA29G
Tx Frequency	LTE Band 48: 3550 MHz ~ 3700 MHz
Rx Frequency	LTE Band 48: 3550 MHz ~ 3700 MHz
Bandwidth	5MHz / 10MHz / 15MHz / 20MHz
Maximum Output Power to Antenna	<ANT2> : LTE Band 48: 19.10 dBm <ANT3> : LTE Band 48: 20.44 dBm <ANT5> : LTE Band 48: 24.41 dBm <ANT7> : LTE Band 48: 22.16 dBm
Antenna Gain	<ANT2> : LTE Band 42 : -1.8 dBi <ANT3> : LTE Band 42 : -4.9 dBi <ANT5> : LTE Band 42 : -2.5 dBi <ANT7> : LTE Band 42 : -4.0 dBi
Type of Modulation	QPSK / 16QAM / 64QAM / 256QAM
IMEI Code	Conducted: 861793070041148/861793070041155 Radiation: 861793070039324/861793070039332
HW Version	135300O16
SW Version	Xiaomi HyperOS 1.0
EUT Stage	Identical Prototype

### Remark:

1. The above EUT's information was declared by manufacturer. Please refer to the specifications or user's manual for more detailed description.
2. The maximum EIRP is calculated from max output power and antenna gain, only the maximum EIRP of Ant. 5 is shown in the report.

### 1.4 Maximum EIRP Power and Emission Designator

LTE Band 48		QPSK		16QAM/64QAM/256QAM	
BW (MHz)	Frequency Range (MHz)	Maximum EIRP(W)	Emission Designator (99%OBW)	Maximum EIRP(W)	Emission Designator (99%OBW)
5	3552.5~3697.5	0.1531	4M49G7D	0.1247	4M50W7D
10	3555~3695	0.1538	9M05G7D	0.1236	9M07W7D
15	3557.5~3692.5	0.1542	13M5G7D	0.1233	13M4W7D
20	3560~3690	0.1552	17M9G7D	0.1250	17M9W7D

Note: All modulations have been tested, only the worst test results are shown in the report.

### 1.5 Testing Site

Sporton International Inc. (Kunshan) is accredited to ISO/IEC 17025:2017 by American Association for Laboratory Accreditation with Certificate Number 5145.02.

<b>Test Firm</b>	Sporton International Inc. (Kunshan)		
<b>Test Site Location</b>	No. 1098, Pengxi North Road, Kunshan Economic Development Zone Jiangsu Province 215300 People's Republic of China TEL : +86-512-57900158		
<b>Test Site No.</b>	<b>Sporton Site No.</b>	<b>FCC Designation No.</b>	<b>FCC Test Firm Registration No.</b>
	03CH04-KS TH01-KS	CN1257	314309

### 1.6 Test Software

Item	Site	Manufacture	Name	Version
1.	TH01-KS	SPORTON	FCC LTE_Ver2.0 Auto_china_210503	2.0
2.	03CH04-KS	AUDIX	E3	210616



## **1.7 Applied Standards**

According to the specifications of the manufacturer, the EUT must comply with the requirements of the following standards:

- ♦ ANSI C63.26-2015
- ♦ 47 CFR Part 96
- ♦ FCC KDB 971168 D01 Power Meas. License Digital Systems v03r01
- ♦ FCC KDB 940660 D01 Part 96 CBRS v03
- ♦ FCC KDB 412172 D01 Determining ERP and EIRP v01r01

**Remark:**

1. All test items were verified and recorded according to the standards and without any deviation during the test.
2. This EUT has also been tested and complied with the requirements of FCC Part 15, Subpart B, recorded in a separate test report.



## 2 Test Configuration of Equipment Under Test

### 2.1 Test Mode

Antenna port conducted and radiated test items listed below are performed according to KDB 971168 D01 Power Meas. License Digital Systems v03r01 with maximum output power.

For radiated measurement, pre-scanned in three orthogonal panels, X, Y, Z. The worst cases (Z plane) were recorded in this report.

Test Items	Band	Bandwidth (MHz)						Modulation				RB #			Test Channel			
		1.4	3	5	10	15	20	QPSK	16 QAM	64 QAM	256 QAM	1	Half	Full	L	M	H	
Max. Output Power	48	-	-	v	v	v	v	v	v	v	v	v			v	v	v	v
Adjacent Channel Leakage Ratio	48	-	-	v	v	v	v	v	v	v	v	v			v	v	v	v
26dB and 99% Bandwidth	48	-	-	v	v	v	v	v	v						v		v	
Conducted Band Edge	48	-	-	v	v	v	v	v	v	v	v	v			v	v	v	v
Conducted Spurious Emission	48	-	-	v	v	v	v	v								v	v	v
E.I.R.P	48	-	-	v	v	v	v	v	v	v	v	v			v	v	v	v
Frequency Stability	48	-	-	v				v									v	
Radiated Spurious Emission	48	Worst Case															v	
Remark	1. The mark "v" means that this configuration is chosen for testing 2. The mark "-" means that this bandwidth is not supported. 3. The device is investigated from 30MHz to 10 times of fundamental signal for radiated spurious emission test under different RB size/offset and modulations in exploratory test. Subsequently, only the worst case emissions are reported..																	



## 2.2 Connection Diagram of Test System

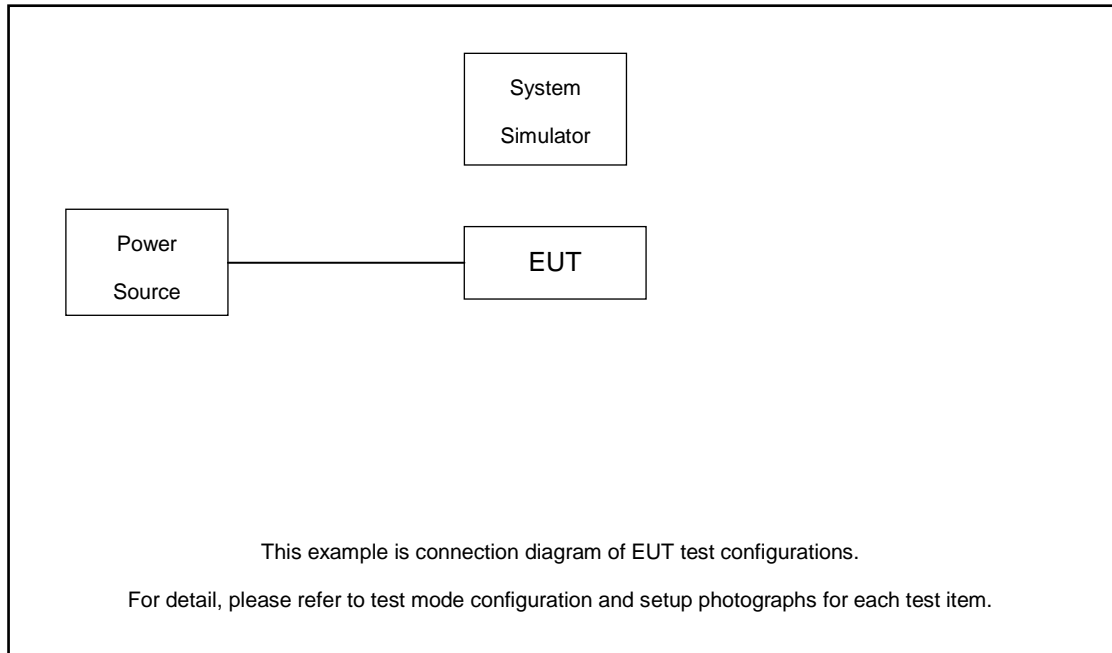

## 2.3 Support Unit used in test configuration

Item	Equipment	Trade Name	Model No.	FCC ID	Data Cable	Power Cord
1.	Power Supply	GWINSTEK	PSS-2002	N/A	N/A	Unshielded, 1.8 m
2.	LTE Base Station	Anritsu	MT8821C	N/A	N/A	Unshielded, 1.8 m

## 2.4 Measurement Results Explanation Example

### For all conducted test items:

The offset level is set in the spectrum analyzer to compensate the RF cable loss between EUT conducted output port and spectrum analyzer. With the offset compensation, the spectrum analyzer reading level is exactly the EUT RF output level.

The spectrum analyzer offset is derived from RF cable loss.

*Offset = RF cable loss.*

Following shows an offset computation example with cable loss 6.5 dB.

Example :

$$\begin{aligned} \text{Offset(dB)} &= \text{RF cable loss(dB)}. \\ &= 6.5 \text{ (dB)} \end{aligned}$$



## 2.5 Frequency List of Low/Middle/High Channels

LTE Band 48 Channel and Frequency List				
BW [MHz]	Channel/Frequency(MHz)	Lowest	Middle	Highest
20	Channel	55340	55990	56640
	Frequency	3560.0	3625.0	3690.0
15	Channel	55315	55990	56665
	Frequency	3557.5	3625.0	3692.5
10	Channel	55290	55990	56690
	Frequency	3555.0	3625.0	3695.0
5	Channel	55265	55990	56715
	Frequency	3552.5	3625.0	3697.5

### 3 Conducted Test Items

#### 3.1 Measuring Instruments

See list of measuring instruments of this test report.

#### 3.2 Test Setup

##### 3.2.1 Conducted Output Power / ACLR

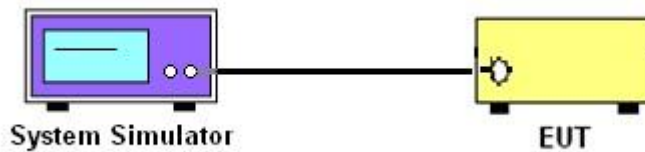

##### 3.2.2 26dB & 99% Occupied Bandwidth, Conducted Band-Edge and Conducted Spurious Emission

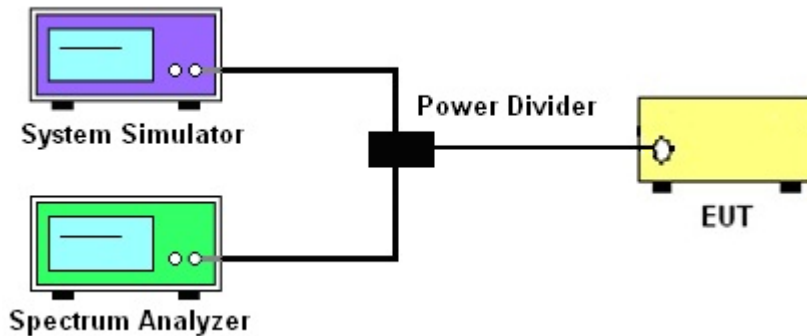

##### 3.2.3 Frequency Stability

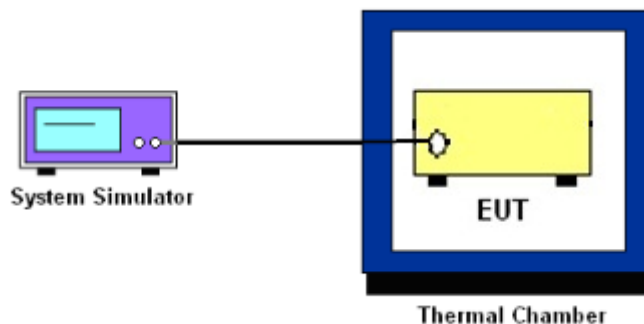

##### 3.2.4 Test Result of Conducted Test

Please refer to Appendix A.



### **3.3 Conducted Output Power**

#### **3.3.1 Description of the Conducted Output Power Measurement**

A system simulator was used to establish communication with the EUT. Its parameters were set to force the EUT transmitting at maximum output power. The measured power in the radio frequency on the transmitter output terminals shall be reported.

#### **3.3.2 Test Procedures**

1. The transmitter output port was connected to the system simulator.
2. Set EUT at maximum power through the system simulator.
3. Select lowest, middle, and highest channels for each band and different modulation.
4. Measure and record the power level from the system simulator.

### 3.4 EIRP

#### 3.4.1 Description of the EIRP Measurement

EIRP limits for CBRS equipment as below table:

Device		Maximum EIRP (dBm/10 MHz)	Maximum PSD (dBm/MHz)
Applied	End User Device	23	n/a
<input type="checkbox"/>	Category A CBSD	30	20
<input type="checkbox"/>	Category B CBSD	47	37

**Remark:** The worst case EIRP shown in this section is found with LTE operating only using 1RB. As such, the EIRP/10MHz and full channel EIRP values will be identical since 1RB is fully contained within all available channel bandwidths for LTE Band 48 (i.e. 5, 10, 15, 20MHz)

#### 3.4.2 Test Procedures for EIRP

1. Establishing a communications link with the call box (Base station) to measure the Maximum conducted power, the parameters were set to force the EUT transmitting at maximum output power level. Use the average power measurement function to measure total channel power of each channel bandwidth (per ANSI C63.26-2015 Section 5.2.1)
2. Determining ERP and/or EIRP from conducted RF output power measurements (Per ANSI C63.26-2015 Section 5.2.5.5)
  - EIRP =  $P_T + G_T - L_C$ , ERP = EIRP -2.15, where
  - $P_T$  = transmitter output power in dBm
  - $G_T$  = gain of the transmitting antenna in dBi
  - $L_C$  = signal attenuation in the connecting cable between the transmitter and antenna in dB



## 3.5 Occupied Bandwidth

### 3.5.1 Description of Occupied Bandwidth Measurement

The occupied bandwidth is the width of a frequency band such that, below the lower and above the upper frequency limits, the mean powers emitted are each equal to a specified percentage 0.5% of the total mean transmitted power.

The 26 dB emission bandwidth is defined as the frequency range between two points, one above and one below the carrier frequency, at which the spectral density of the emission is attenuated 26 dB below the maximum in-band spectral density of the modulated signal. Spectral density (power per unit bandwidth) is to be measured with a detector of resolution bandwidth equal to approximately 1.0% of the emission bandwidth.

### 3.5.2 Test Procedures

The testing follows ANSI C63.26-2015 Section 5.4.3 (26dB) and Section 5.4.4 (99OB)

1. The EUT was connected to spectrum analyzer and system simulator via a power divider.
2. The spectrum analyzer center frequency is set to the nominal EUT channel center frequency. The span range for the spectrum analyzer shall be between two and five times the anticipated OBW.
3. The nominal resolution bandwidth (RBW) shall be in the range of 1 to 5 % of the anticipated OBW, and the VBW shall be at least 3 times the RBW.
4. Set the detection mode to peak, and the trace mode to max hold.
5. Determine the reference value: Set the EUT to transmit a modulated signal. Allow the trace to stabilize. Set the spectrum analyzer marker to the highest level of the displayed trace.  
(this is the reference value)
6. Determine the “-26 dB down amplitude” as equal to (Reference Value – X).
7. Place two markers, one at the lowest and the other at the highest frequency of the envelope of the spectral display such that each marker is at or slightly below the “-X dB down amplitude” determined in step 6. If a marker is below this “-X dB down amplitude” value it shall be placed as close as possible to this value. The OBW is the positive frequency difference between the two markers.
8. Use the 99 % power bandwidth function of the spectrum analyzer and report the measured bandwidth.



## 3.6 Conducted Band Edge

### 3.6.1 Description of Conducted Band Edge Measurement

Part 96.41 (e) (1) (ii)

For End User Devices the emission limits outside the fundamental are as follows:

Within 0 MHz to B MHz above and below the assigned channel  $\leq -13$  dBm/MHz

Greater than B MHz above and below the assigned channel  $\leq -25$  dBm/MHz

where B is the bandwidth in megahertz of the assigned channel or multiple contiguous channels of the End User Device.

Notwithstanding the emission limits in this paragraph, the Adjacent Channel Leakage Ratio for End User Devices shall be at least 30 dB.

Part 96.41 (e) (2)

For CBSDs and End User Devices, the conducted power of emissions below 3540 MHz or above 3710 MHz shall not exceed  $-25$  dBm/MHz, and the conducted power of emissions below 3530 MHz or above 3720 MHz shall not exceed  $-40$ dBm/MHz

### 3.6.2 Test Procedures

The testing follows FCC KDB 971168 D01 v03r01 Section 6.1.

1. The EUT was connected to spectrum analyzer and system simulator via a power divider.
2. The band edges of low and high channels for the highest RF powers were measured.
3. Set RBW  $\geq 1\%$  EBW in the 1MHz band immediately outside and adjacent to the band edge.
4. Beyond the 1 MHz band from the band edge, RBW=1MHz was used
5. Offset has included the duty factor for LTE Band 48. Duty factor  $=10 \log (1/x)$ , where x is the measured duty cycle.
6. Set spectrum analyzer with RMS detector.
7. The RF fundamental frequency should be excluded against the limit line in the operating frequency band.



## 3.7 Conducted Spurious Emission

### 3.7.1 Description of Conducted Spurious Emission Measurement

96.41 (e)(2)

The conducted power of any emissions below 3530 MHz or above 3720 MHz shall not exceed -40dBm/MHz.

### 3.7.2 Test Procedures

The testing follows FCC KDB 971168 D01 v03r01 Section 6.1.

1. The EUT was connected to spectrum analyzer and system simulator via a power divider.
2. The RF output of EUT was connected to the spectrum analyzer by RF cable and attenuator. The path loss was compensated to the results for each measurement.
3. The middle channel for the highest RF power within the transmitting frequency was measured.
4. The conducted spurious emission for the whole frequency range was taken.
5. Make the measurement with the spectrum analyzer's RBW = 1MHz, VBW = 3MHz.
6. Set spectrum analyzer with RMS detector.
7. Taking the record of maximum spurious emission.
8. The RF fundamental frequency should be excluded against the limit line in the operating frequency band.
9. The limit line is -40dBm/MHz.





## **3.8 Frequency Stability**

### **3.8.1 Description of Frequency Stability Measurement**

The frequency stability shall be measured by variation of ambient temperature and variation of primary supply voltage to ensure that the fundamental emission stays within the authorized frequency block.

### **3.8.2 Test Procedures for Temperature Variation**

The testing follows FCC KDB 971168 D01 v03r01 Section 9.0.

1. The EUT was set up in the thermal chamber and connected with the system simulator.
2. With power OFF, the temperature was decreased to -30°C and the EUT was stabilized before testing. Power was applied and the maximum change in frequency was recorded within one minute.
3. With power OFF, the temperature was raised in 10°C step up to 50°C. The EUT was stabilized at each step for at least half an hour. Power was applied and the maximum frequency change was recorded within one minute.

### **3.8.3 Test Procedures for Voltage Variation**

The testing follows FCC KDB 971168 D01 v03r01 Section 9.0.

1. The EUT was placed in a temperature chamber at 25±5° C and connected with the system simulator.
2. The power supply voltage to the EUT was varied from 85% to 115% of the nominal value measured at the input to the EUT.
3. The variation in frequency was measured for the worst case.

## 4 Radiated Test Items

### 4.1 Measuring Instruments

See list of measuring instruments of this test report.

### 4.2 Test Setup

#### 4.2.1 For radiated test below 30MHz

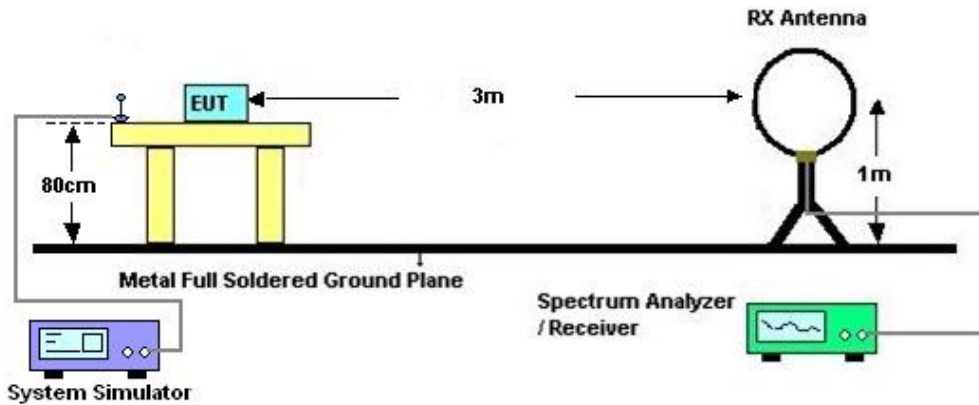

#### 4.2.2 For radiated test from 30MHz to 1GHz

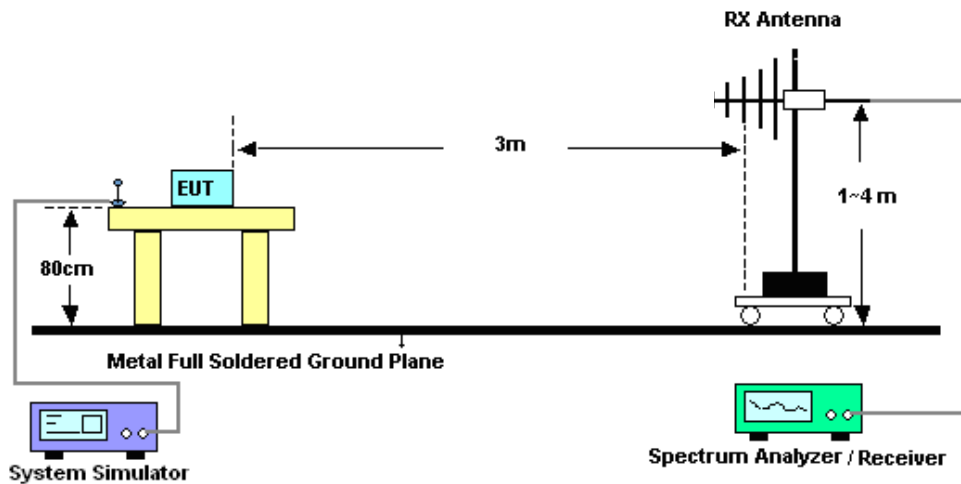

### 4.2.3 For radiated test above 1GHz

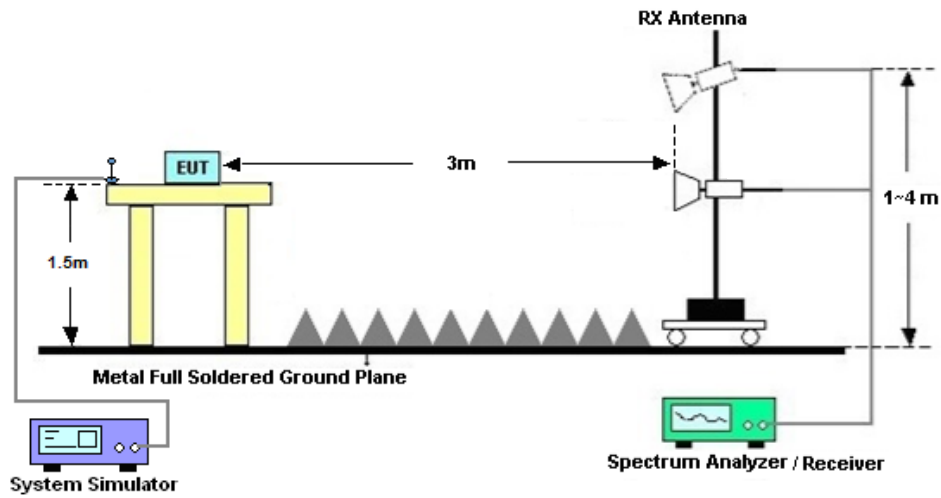

### 4.3 Test Result of Radiated Test

The low frequency, which started from 9 kHz to 30MHz, was pre-scanned and the result which was 20dB lower than the limit line was not reported.

Please refer to Appendix B.



## 4.4 Radiated Spurious Emission

### 4.4.1 Description of Radiated Spurious Emission Measurement

The radiated spurious emission was measured by substitution method according to ANSI C63.26-2015. The power of any emission outside of the authorized operating frequency ranges must be attenuated below the transmitter power (P) by a factor of at least -40dBm / MHz. The spectrum is scanned from 30 MHz up to a frequency including its 10th harmonic.

### 4.4.2 Test Procedures

1. The EUT was placed on a turntable with 0.8 meter height for frequency below 1GHz and 1.5 meter height for frequency above 1GHz respectively above ground.
2. The EUT was set 3 meters from the receiving antenna mounted on the antenna tower.
3. The table was rotated 360 degrees to determine the position of the highest spurious emission.
4. The height of the receiving antenna is varied between 1m to 4m to search the maximum spurious emission for both horizontal and vertical polarizations.
5. During the measurement, the system simulator parameters were set to force the EUT transmitting at maximum output power.
6. Make the measurement with the spectrum analyzer's RBW = 1MHz, VBW = 3MHz, taking the record of maximum spurious emission.
7. A horn antenna was substituted in place of the EUT and was driven by a signal generator. Tune the output power of signal generator to the same emission level with EUT maximum spurious emission.  
$$\text{EIRP (dBm)} = \text{S.G. Power} - \text{Tx Cable Loss} + \text{Tx Antenna Gain}$$
$$\text{ERP (dBm)} = \text{EIRP} - 2.15$$
8. The RF fundamental frequency should be excluded against the limit line in the operating frequency band.  
The limit line is -40dBm/MHz



## 5 List of Measuring Equipment

Instrument	Manufacturer	Model No.	Serial No.	Characteristics	Calibration Date	Test Date	Due Date	Remark
Spectrum Analyzer	R&S	FSV40	101040	10Hz~40GHz	Oct. 11, 2023	Jul. 23, 2024~ Jul. 24, 2024	Oct. 10, 2024	Conducted (TH01-KS)
Power divider	STI	STI08-0055	-	0.5~40GHz	NCR	Jul. 23, 2024~ Jul. 24, 2024	NCR	Conducted (TH01-KS)
Temperature & humidity chamber	Hongzhan	LP-150U	H2014011 440	-40~+150°C 20%~95%RH	Jul. 04, 2024	Jul. 23, 2024~ Jul. 24, 2024	Jul. 03, 2025	Conducted (TH01-KS)
EXA Spectrum Analyzer	Keysight	N9010B	MY574710 79	10Hz-44G,MAX 30dB	Oct. 11, 2023	Jul. 23, 2024	Oct. 10, 2024	Radiation (03CH04-KS)
Loop Antenna	R&S	HFH2-Z2E	101125	9kHz~30MHz	Sep. 11 2023	Jul. 23, 2024	Sep. 10, 2024	Radiation (03CH04-KS)
Bilog Antenna	TeseQ	CBL6111D	59913	30MHz-1GHz	Aug. 19, 2023	Jul. 23, 2024	Aug. 18, 2024	Radiation (03CH04-KS)
Double Ridge Horn Antenna	ETS-Lindgren	3117	75957	1GHz~18GHz	Oct. 23, 2023	Jul. 23, 2024	Oct. 22, 2024	Radiation (03CH04-KS)
SHF-EHF Horn	Com-power	AH-840	101070	18GHz~40GHz	Jan. 27, 2024	Jul. 23, 2024	Jan. 26, 2025	Radiation (03CH04-KS)
Amplifier	SONOMA	310N	413740	9KHz-1GHz	Jan. 03, 2024	Jul. 23, 2024	Jan. 02, 2025	Radiation (03CH04-KS)
Amplifier	EM	EM18G40GA	060728	18~40GHz	Jan. 02, 2024	Jul. 23, 2024	Jan. 01, 2025	Radiation (03CH04-KS)
high gain Amplifier	EM	EM01G18GA	060840	1Ghz-18Ghz	Oct. 11, 2023	Jul. 23, 2024	Oct. 10, 2024	Radiation (03CH04-KS)
Amplifier	EM	EM01G18GA	060892	1Ghz-18Ghz	Oct. 11, 2023	Jul. 23, 2024	Oct. 10, 2024	Radiation (03CH04-KS)
AC Power Source	Chroma	61601	F1040900 04	N/A	NCR	Jul. 23, 2024	NCR	Radiation (03CH04-KS)
Turn Table	ChamPro	EM 1000-T	060762-T	0~360 degree	NCR	Jul. 23, 2024	NCR	Radiation (03CH04-KS)
Antenna Mast	ChamPro	EM 1000-A	060762-A	1 m~4 m	NCR	Jul. 23, 2024	NCR	Radiation (03CH04-KS)

NCR: No Calibration Required



## 6 Measurement Uncertainty

### Uncertainty of Conducted Measurement

Conducted Spurious Emission & Bandedge	±2.26 dB
Occupied Channel Bandwidth	±0.1%
Conducted Power	±0.46 dB
Conducted Power Density	±0.88 dB
Peak to Average Ratio	±0.46 dB
Frequency Stability	±0.4 Hz

### Uncertainty of Radiated Emission Measurement (30 MHz ~ 1000 MHz)

Measuring Uncertainty for a Level of Confidence of 95% (U = 2Uc(y))	2.83 dB
---	---------

### Uncertainty of Radiated Emission Measurement (1 GHz ~ 18 GHz)

Measuring Uncertainty for a Level of Confidence of 95% (U = 2Uc(y))	2.83 dB
---	---------

### Uncertainty of Radiated Emission Measurement (18 GHz ~ 40 GHz)

Measuring Uncertainty for a Level of Confidence of 95% (U = 2Uc(y))	2.82 dB
---	---------

----- THE END -----



### Appendix A. Test Results of Conducted Test

Test Engineer :	Smile Wang	Temperature :	22~23°C
		Relative Humidity :	40~42%

### Conducted Output Power(Average power) and EIRP

#### LTE Band 48\_ANT 5

BW [MHz]	Modulation	RB Size	RB Offset	Power Low Ch. / Freq.	Power Middle Ch. / Freq.	Power High Ch. / Freq.	EIRP(W)		
Channel				55340	55990	56640	EIRP(W)		
Frequency (MHz)				3560	3625	3690	L	M	H
20	QPSK	1	0	24.41	24.36	24.38	0.1552	0.1535	0.1542
20	QPSK	1	99	24.38	24.39	24.35	0.1542	0.1545	0.1531
20	QPSK	100	0	23.42	23.45	23.38	0.1236	0.1245	0.1225
20	16QAM	1	0	23.47	23.46	23.41	0.1250	0.1247	0.1233
20	64QAM	1	0	22.37	22.35	22.36	0.0971	0.0966	0.0968
20	256QAM	1	0	19.38	19.41	19.62	0.0488	0.0491	0.0515
Channel				55315	55990	56665	EIRP(W)		
Frequency (MHz)				3557.5	3625	3692.5	L	M	H
15	QPSK	1	0	24.33	24.38	24.34	0.1524	0.1542	0.1528
15	16QAM	1	0	23.36	23.41	23.31	0.1219	0.1233	0.1205
Channel				55290	55990	56690	EIRP(W)		
Frequency (MHz)				3555	3625	3695	L	M	H
10	QPSK	1	0	24.37	24.36	24.26	0.1538	0.1535	0.1500
10	16QAM	1	0	23.40	23.42	23.34	0.1230	0.1236	0.1213
Channel				55265	55990	56715	EIRP(W)		
Frequency (MHz)				3552.5	3625	3697.5	L	M	H
5	QPSK	1	0	24.30	24.35	24.32	0.1514	0.1531	0.1521
5	16QAM	1	0	23.46	23.45	23.30	0.1247	0.1245	0.1202



ACLR

LTE Band 48 / 5MHz

QPSK

Lowest Channel / 1RB0

Lowest Channel / 1RBmax

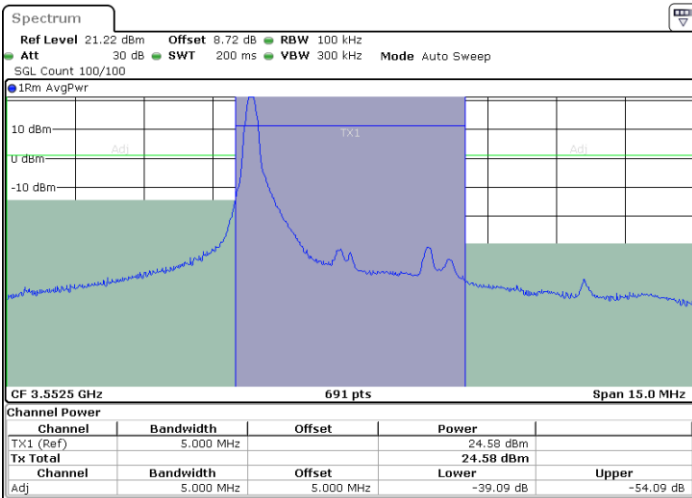

Date: 24.JUL.2024 03:49:16

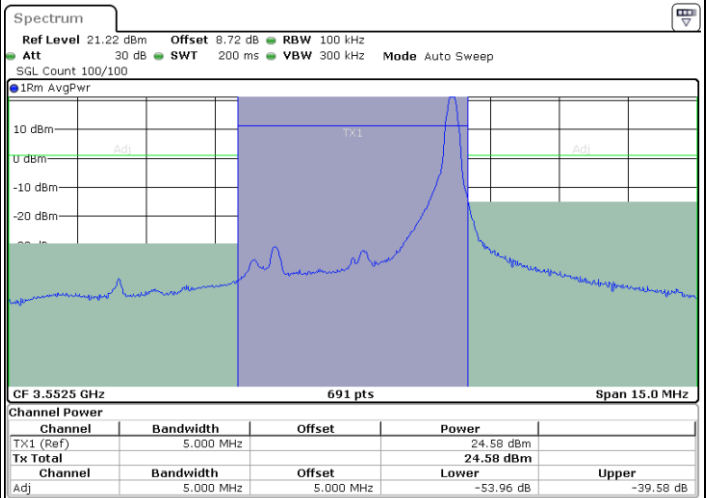

Date: 24.JUL.2024 03:52:24

Lowest Channel / FullRB



Date: 24.JUL.2024 03:55:28





LTE Band 48 / 5MHz

QPSK

Middle Channel / 1RB0

Middle Channel / 1RBmax

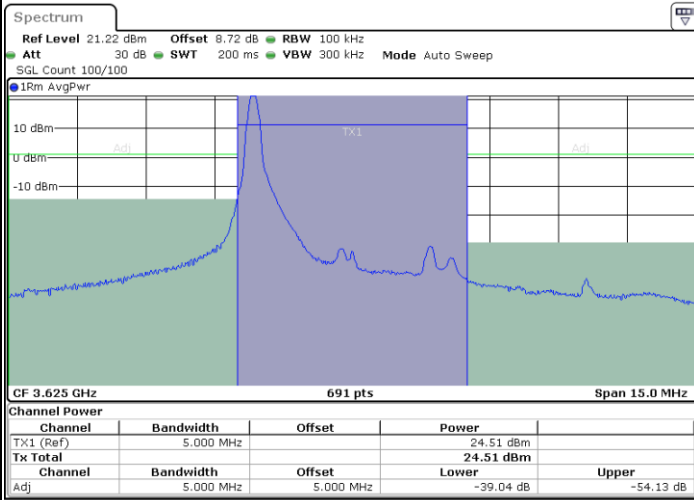

Date: 24.JUL.2024 03:58:30

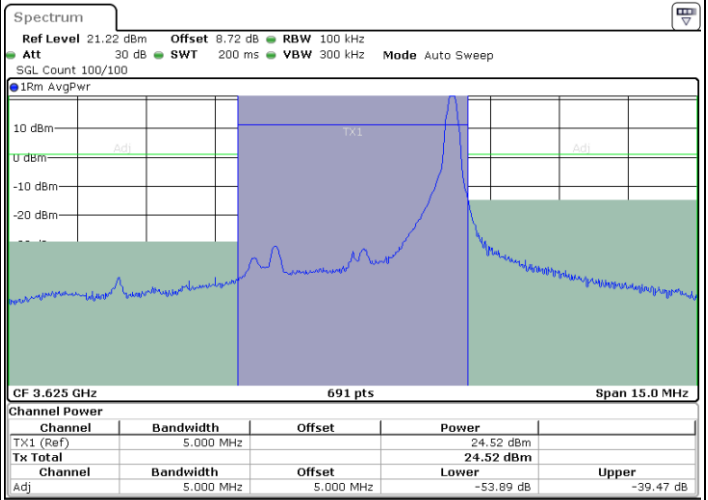

Date: 24.JUL.2024 04:01:28

Middle Channel / FullRB

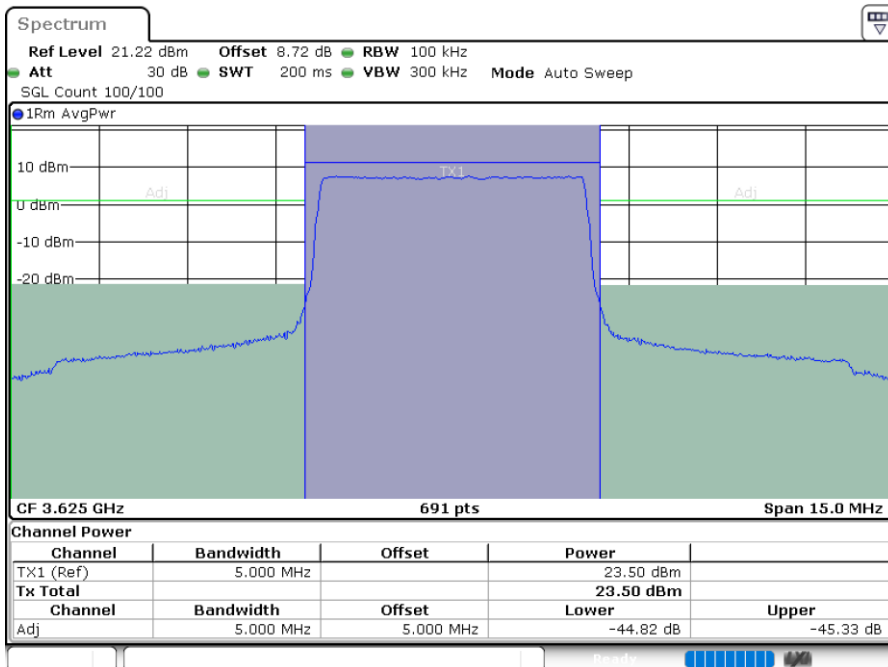

Date: 24.JUL.2024 04:04:25



LTE Band 48 / 5MHz

QPSK

Highest Channel / 1RB0

Highest Channel / 1RBmax

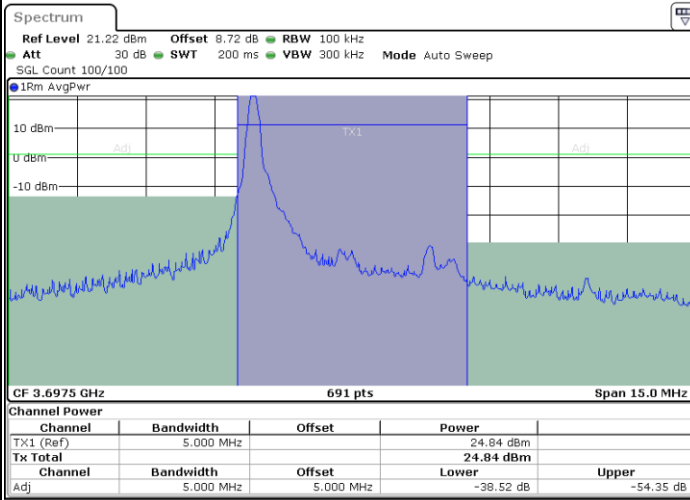

Date: 24.JUL.2024 04:07:24

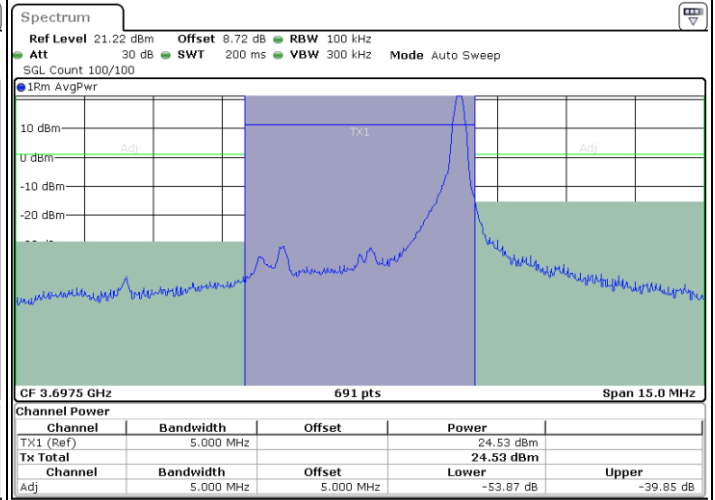

Date: 24.JUL.2024 04:27:54

Highest Channel / FullRB

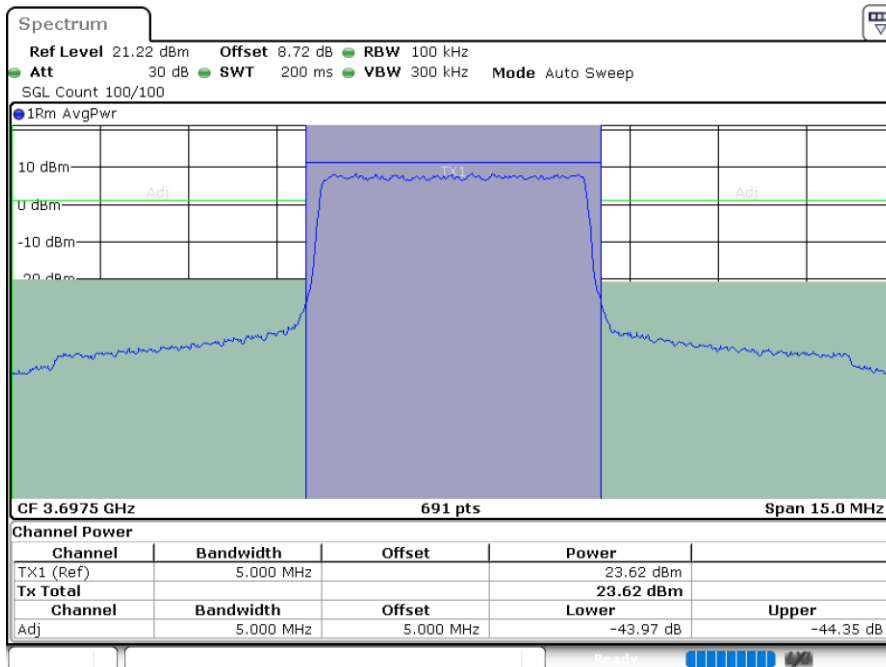

Date: 24.JUL.2024 04:31:03



LTE Band 48 / 5MHz

16QAM

Lowest Channel / 1RB0

Lowest Channel / 1RBmax

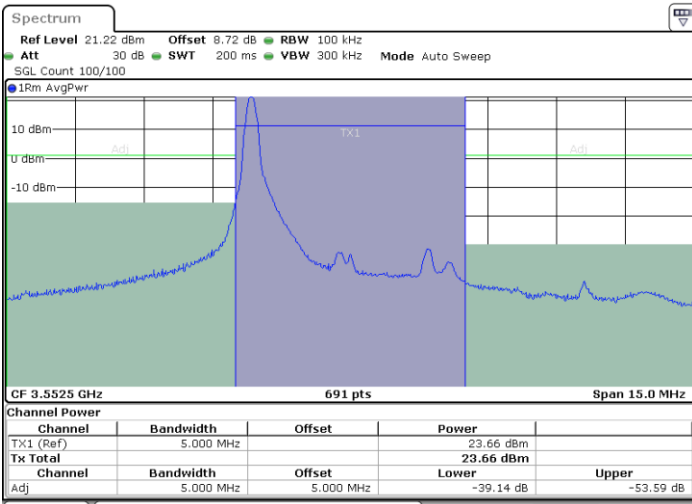

Date: 24.JUL.2024 03:50:08

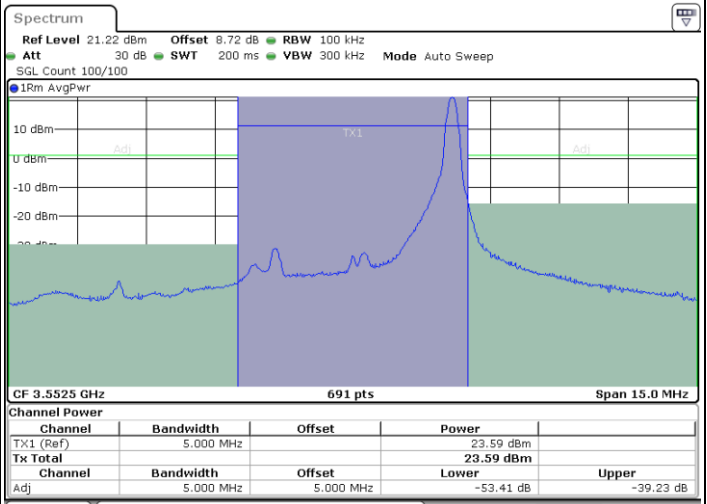

Date: 24.JUL.2024 03:53:12

Lowest Channel / FullRB

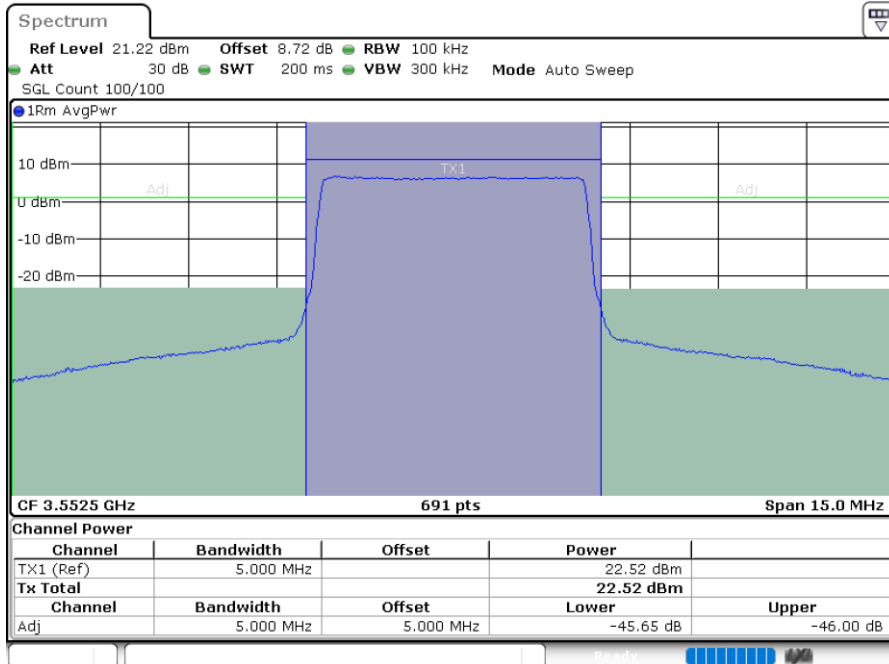

Date: 24.JUL.2024 03:56:14



LTE Band 48 / 5MHz

16QAM

Middle Channel / 1RB0

Middle Channel / 1RBmax

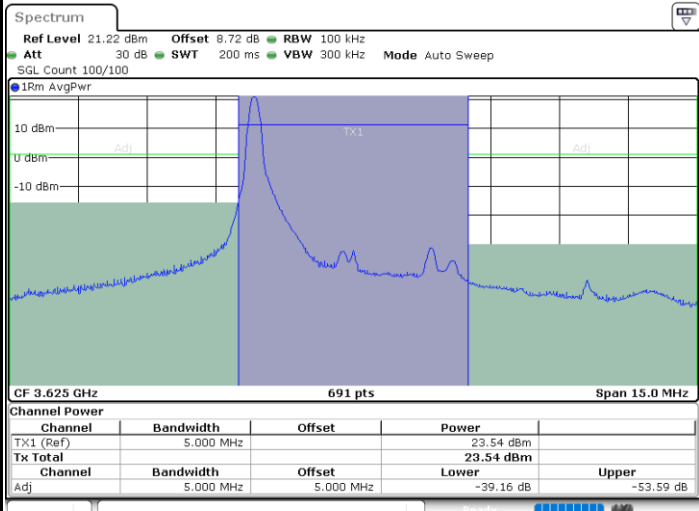

Date: 24.JUL.2024 03:59:15

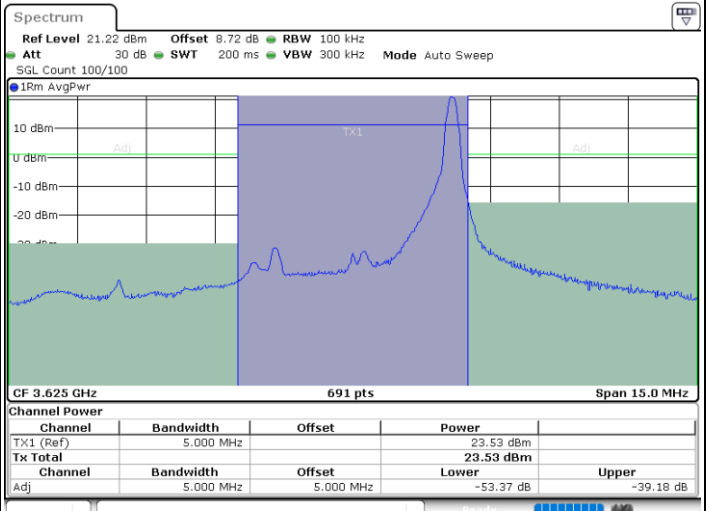

Date: 24.JUL.2024 04:02:12

Middle Channel / FullRB

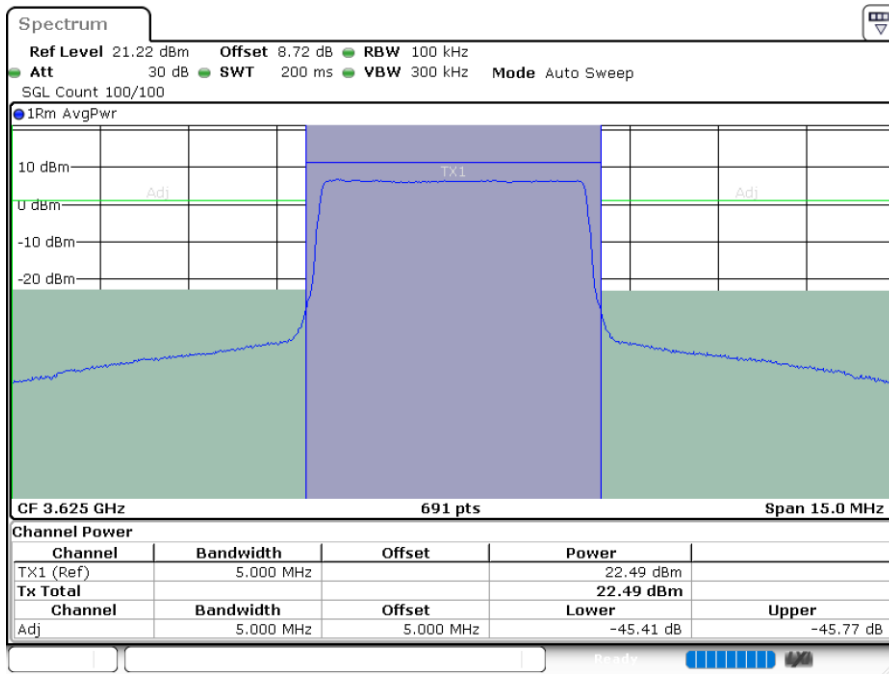

Date: 24.JUL.2024 04:05:10



LTE Band 48 / 5MHz

16QAM

Highest Channel / 1RB0

Highest Channel / 1RBmax

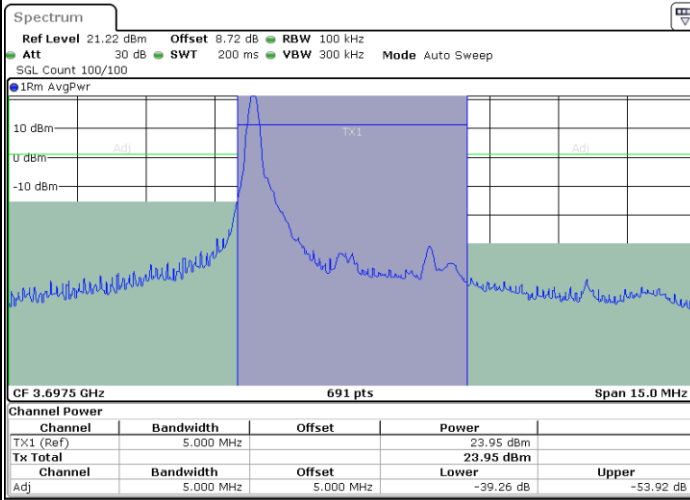

Date: 24.JUL.2024 04:08:13

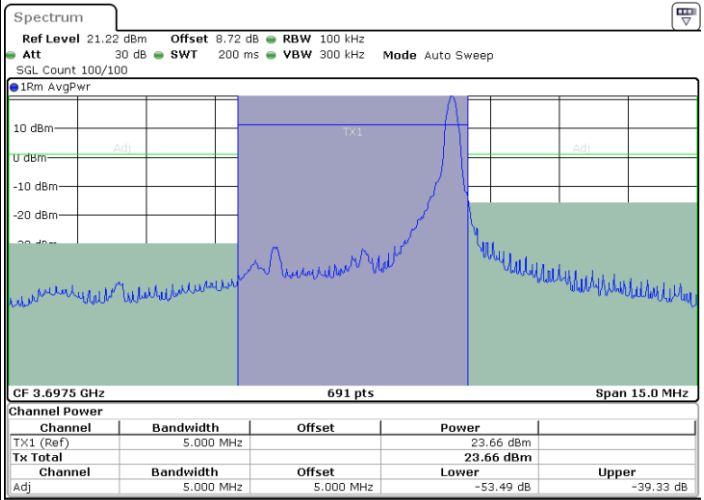

Date: 24.JUL.2024 04:28:44

Highest Channel / FullRB

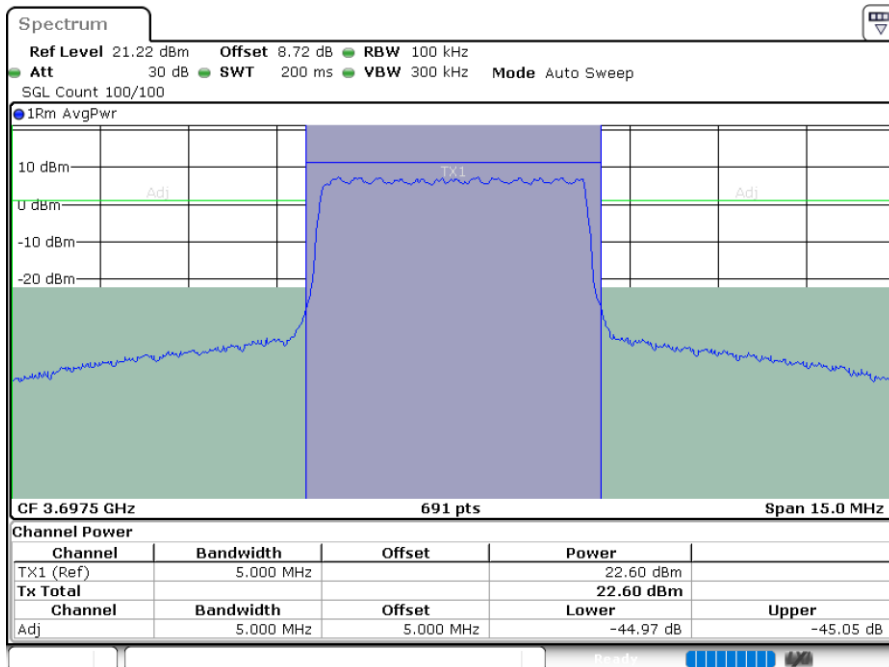

Date: 24.JUL.2024 04:31:49



LTE Band 48 / 5MHz

64QAM

Lowest Channel / 1RB0

Lowest Channel / 1RBmax

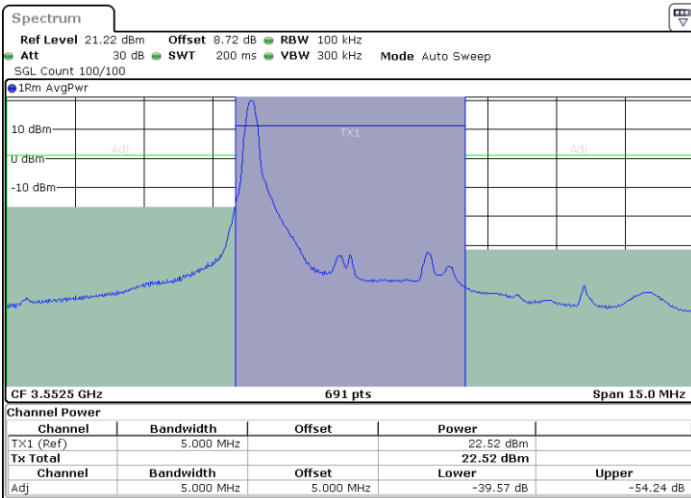

Date: 24.JUL.2024 03:50:54

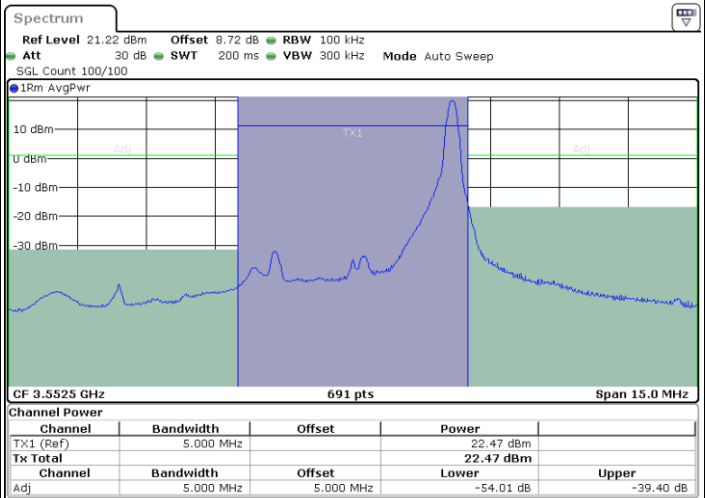

Date: 24.JUL.2024 03:53:58

Lowest Channel / FullRB

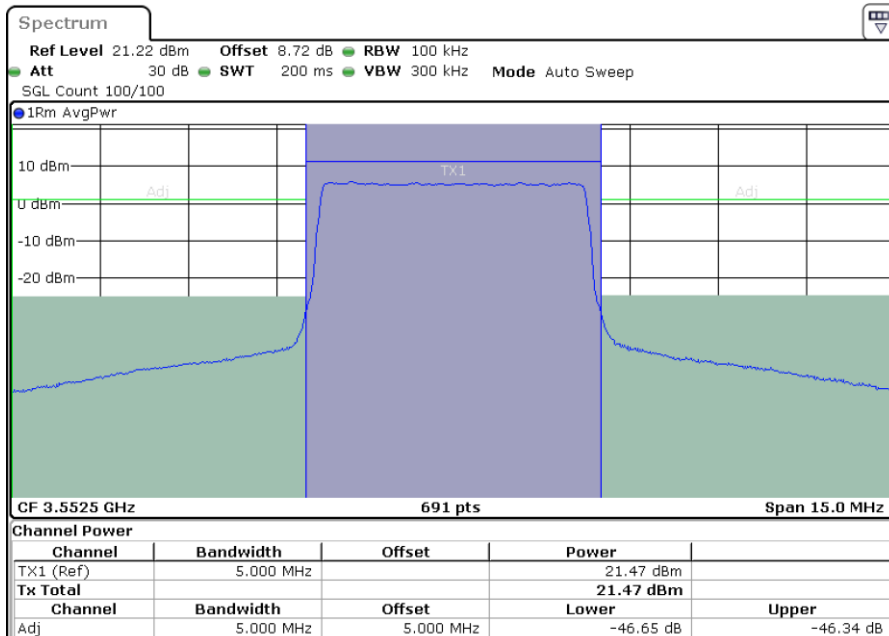

Date: 24.JUL.2024 03:56:59



LTE Band 48 / 5MHz

64QAM

Middle Channel / 1RB0

Middle Channel / 1RBmax

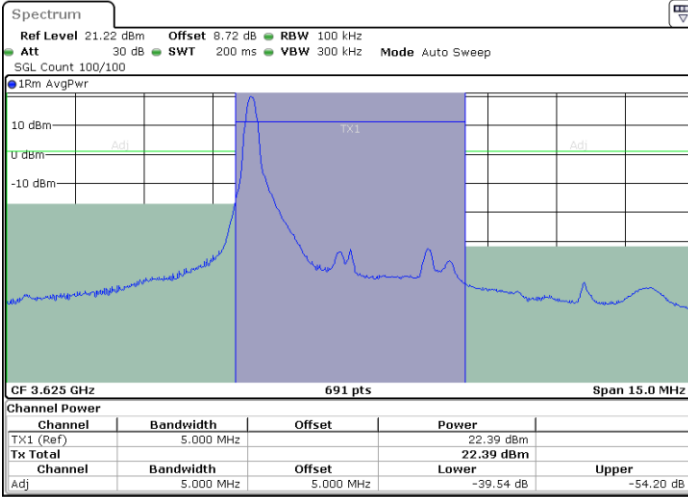

Date: 24.JUL.2024 03:59:59

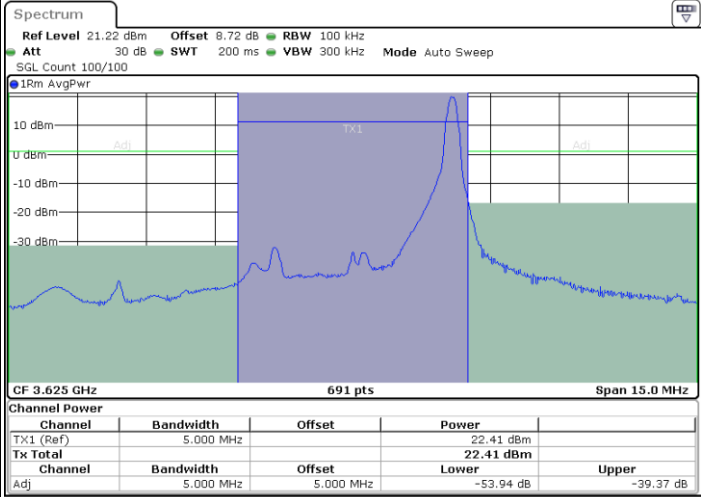

Date: 24.JUL.2024 04:02:57

Middle Channel / FullRB

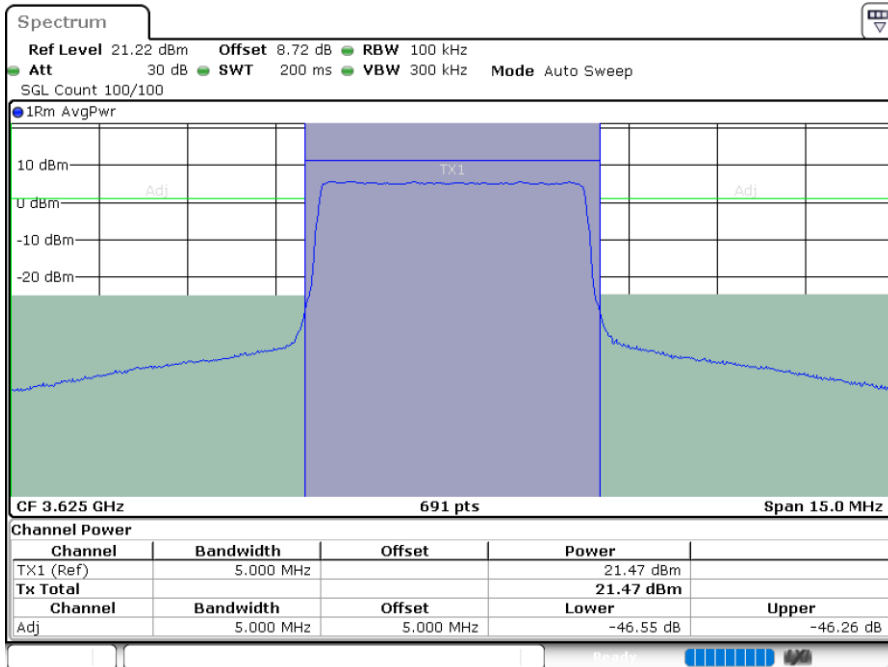

Date: 24.JUL.2024 04:05:54



LTE Band 48 / 5MHz

64QAM

Highest Channel / 1RB0

Highest Channel / 1RBmax

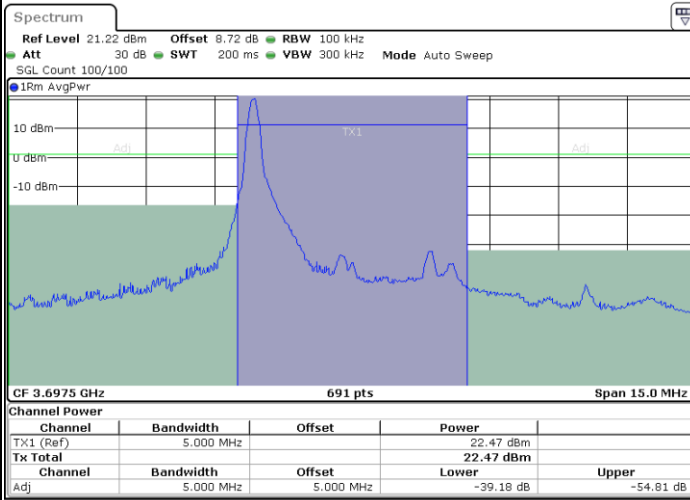

Date: 24.JUL.2024 04:26:23

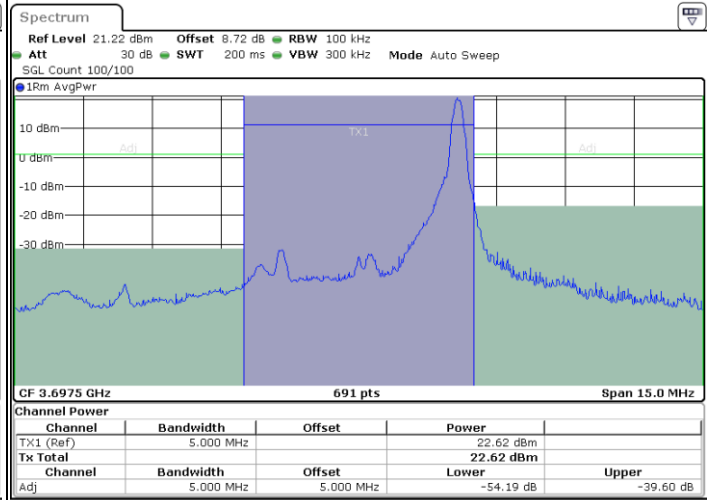

Date: 24.JUL.2024 04:29:30

Highest Channel / FullRB

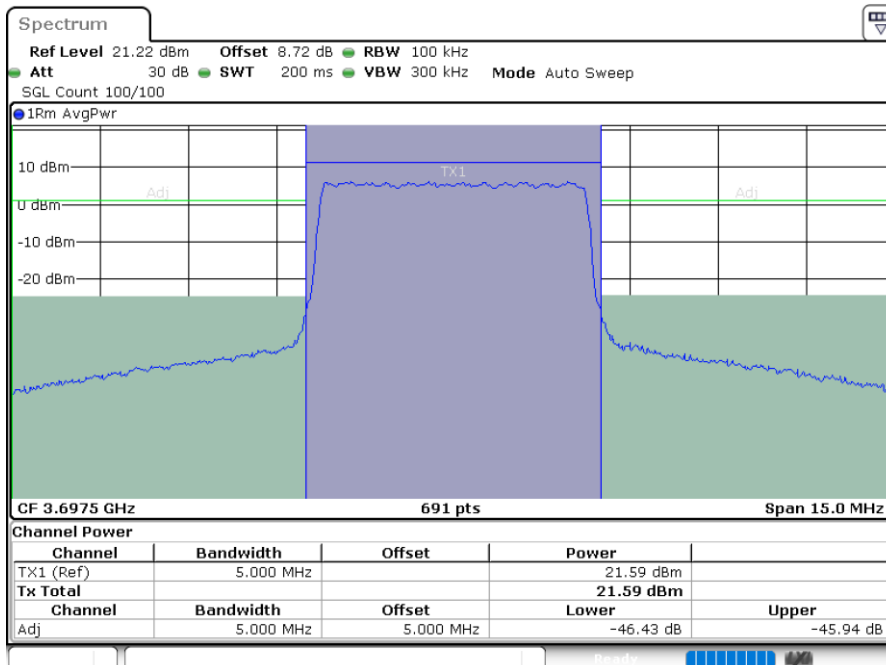

Date: 24.JUL.2024 04:32:35





LTE Band 48 / 5MHz

256QAM

Lowest Channel / 1RB0

Lowest Channel / 1RBmax

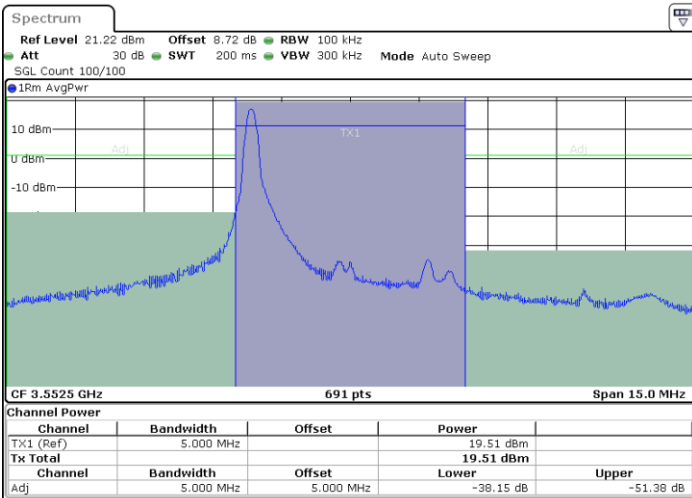

Date: 24.JUL.2024 03:51:39

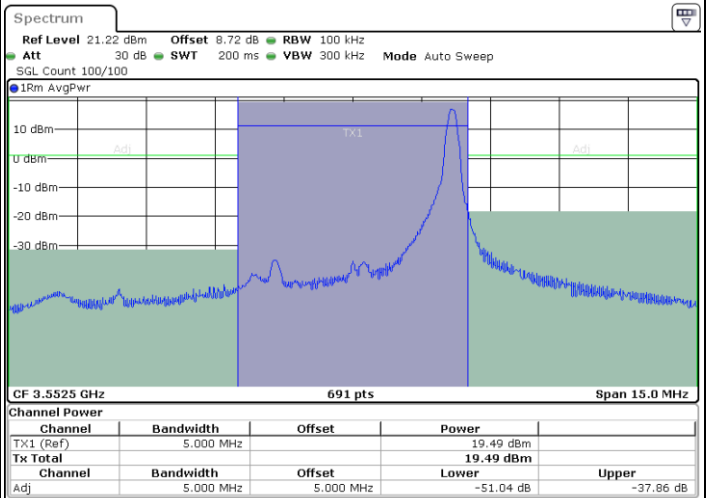

Date: 24.JUL.2024 03:54:43

Lowest Channel / FullRB

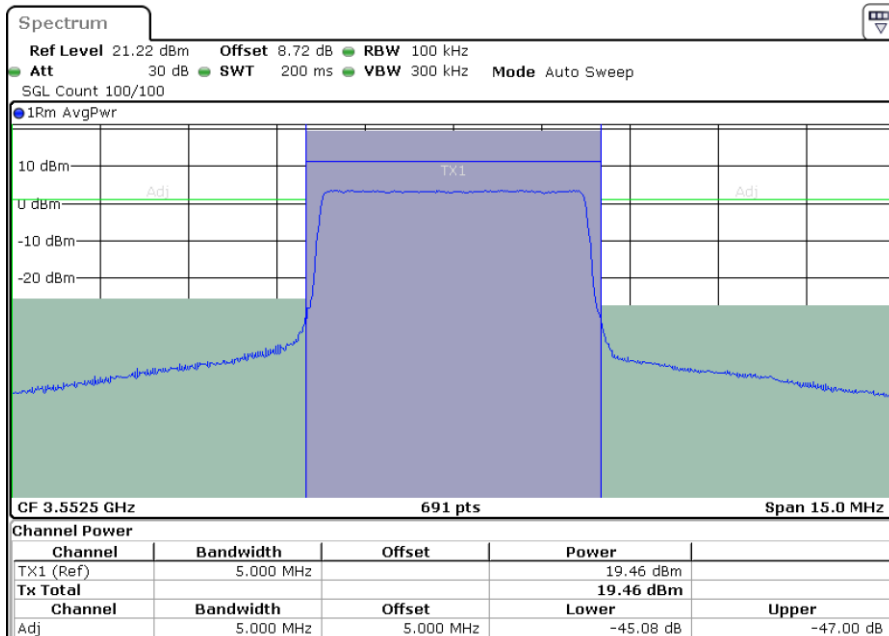

Date: 24.JUL.2024 03:57:45



LTE Band 48 / 5MHz

256QAM

Middle Channel / 1RB0

Middle Channel / 1RBmax

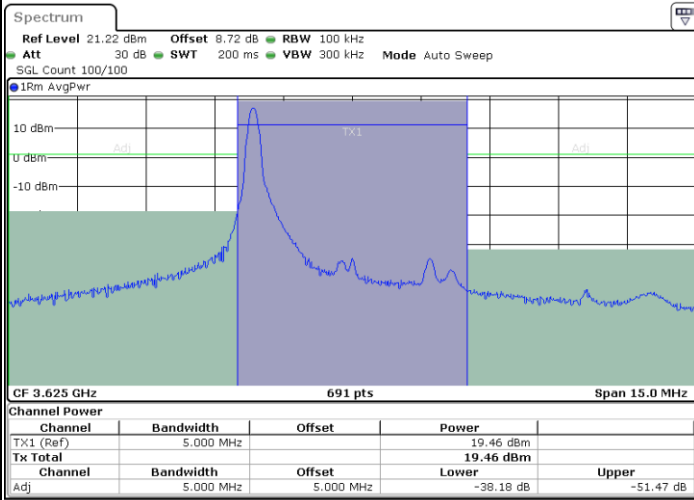

Date: 24.JUL.2024 04:00:43

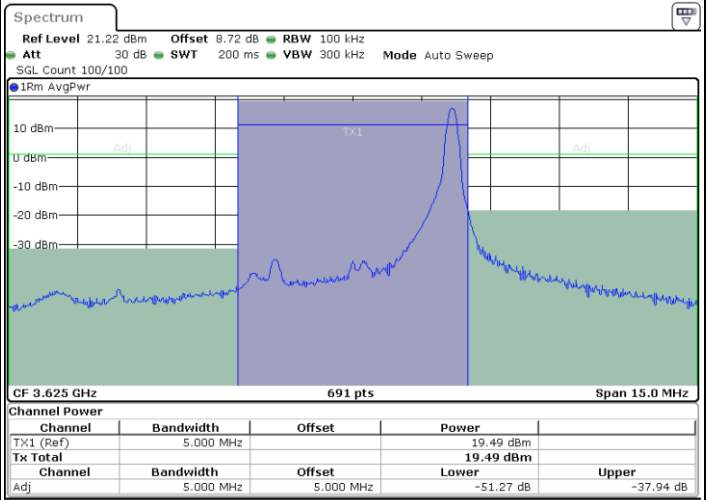

Date: 24.JUL.2024 04:03:41

Middle Channel / FullRB

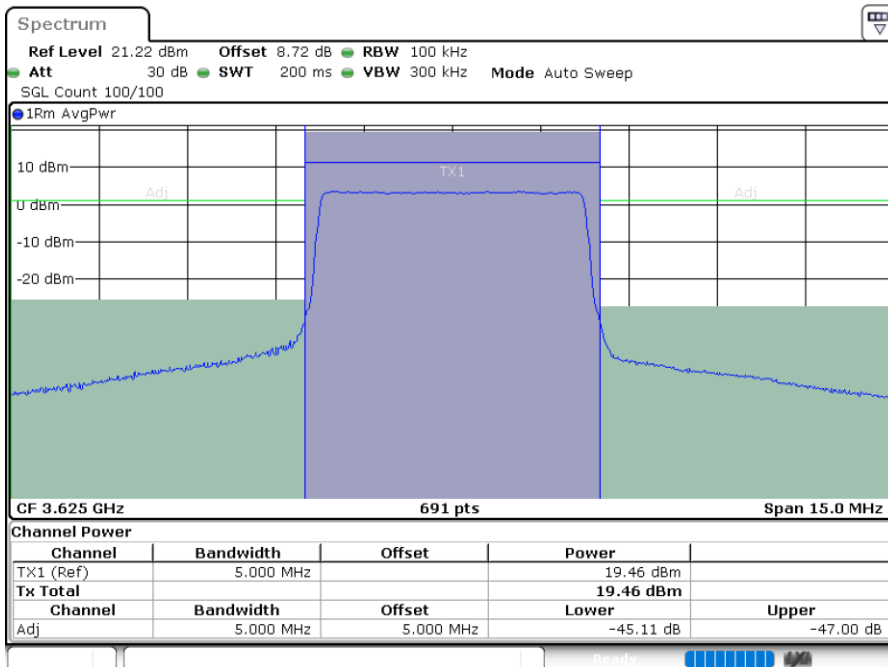

Date: 24.JUL.2024 04:06:38



LTE Band 48 / 5MHz

256QAM

Highest Channel / 1RB0

Highest Channel / 1RBmax

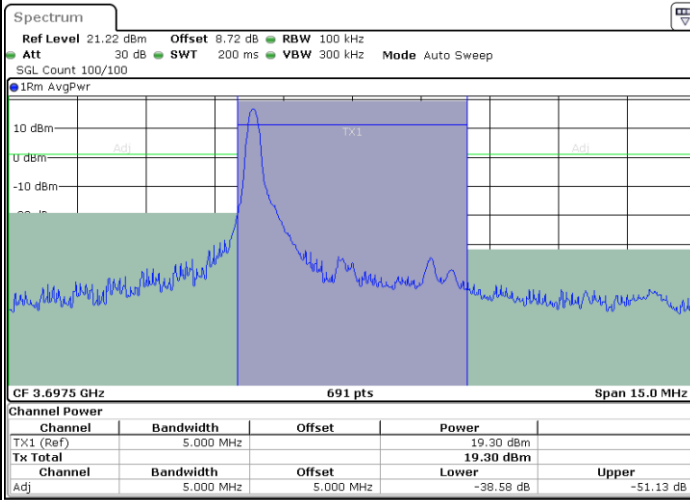

Date: 24.JUL.2024 04:27:08

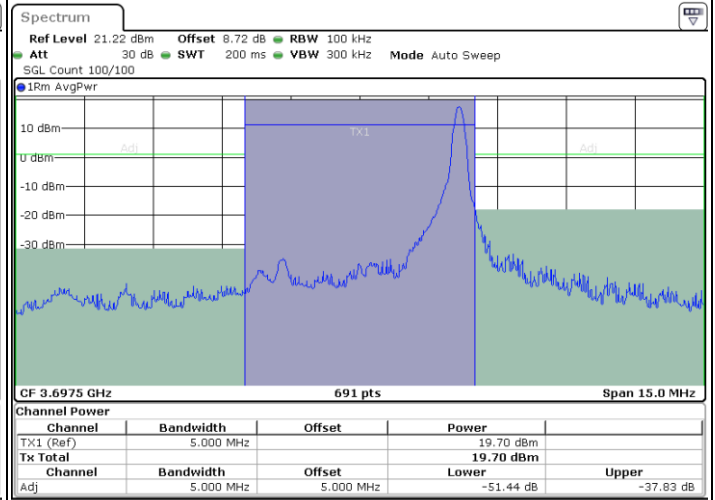

Date: 24.JUL.2024 04:30:17

Highest Channel / FullRB

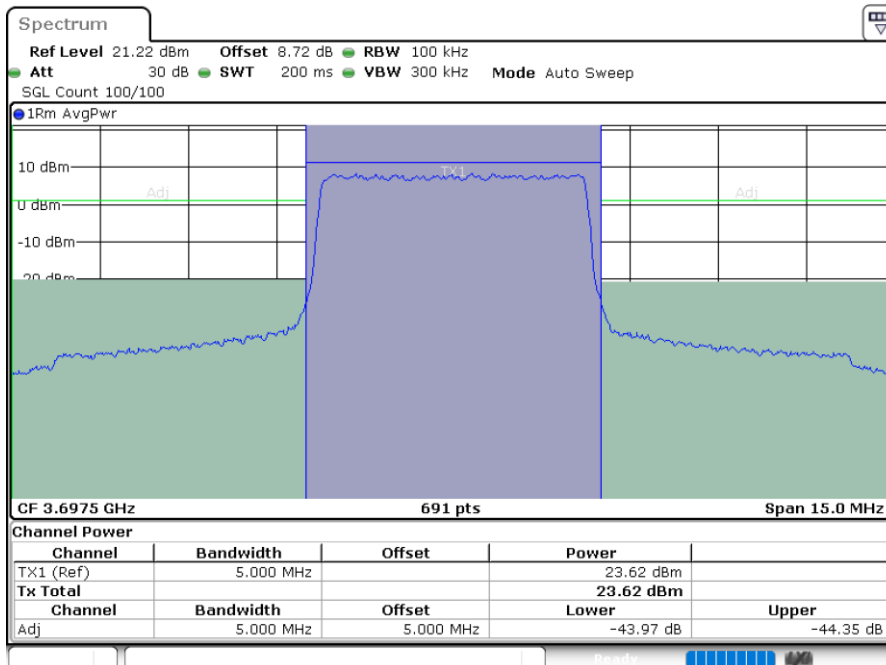

Date: 24.JUL.2024 04:31:03



LTE Band 48 / 10MHz

QPSK

Lowest Channel / 1RB0

Lowest Channel / 1RBmax

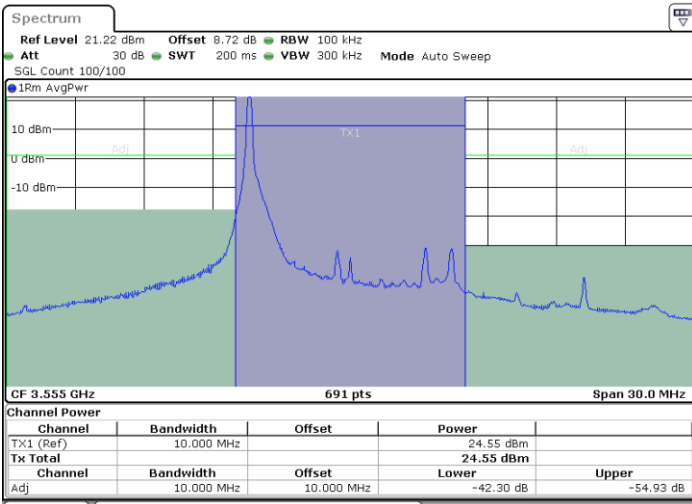

Date: 24.JUL.2024 04:34:50

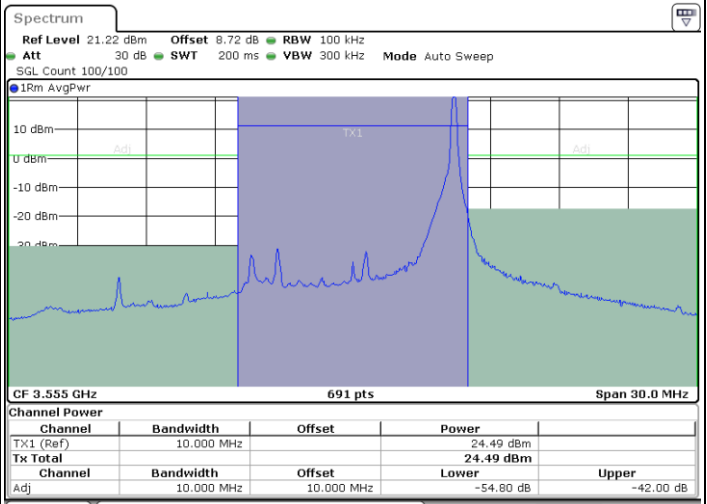

Date: 24.JUL.2024 04:37:56

Lowest Channel / FullRB

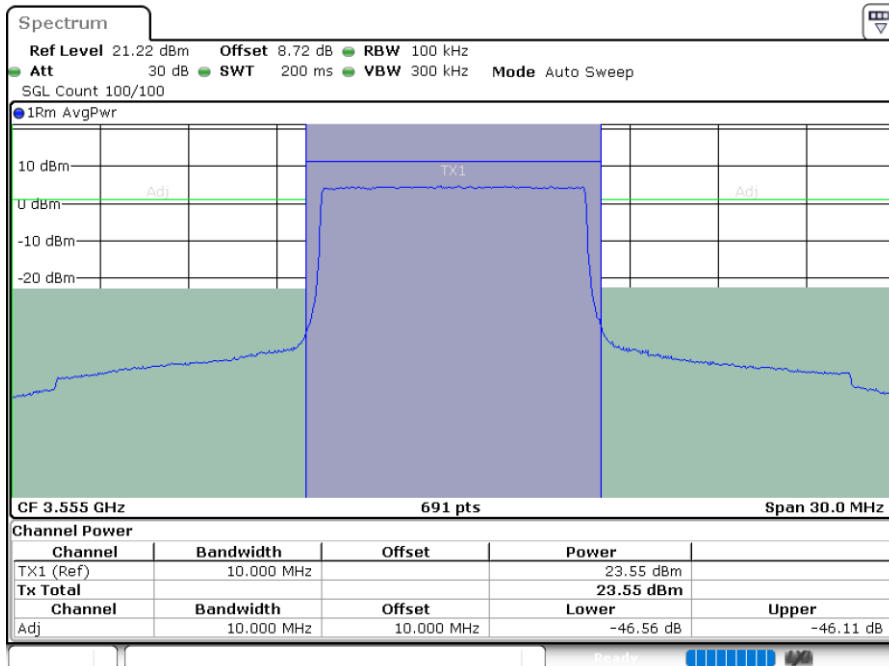

Date: 24.JUL.2024 04:41:01



LTE Band 48 / 10MHz

QPSK

Middle Channel / 1RB0

Middle Channel / 1RBmax

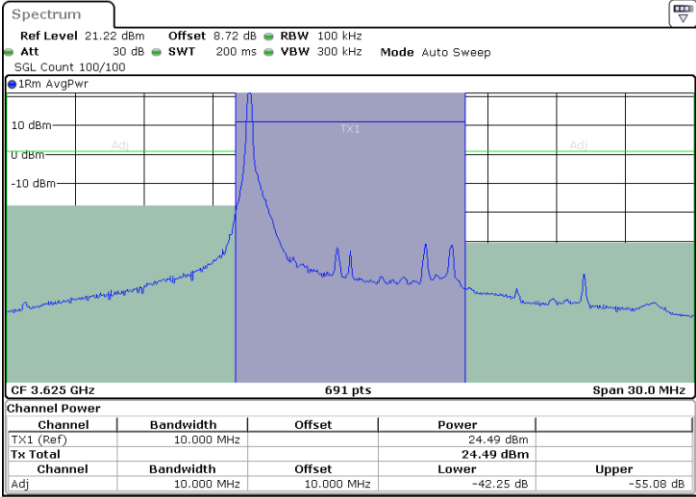

Date: 24.JUL.2024 04:44:04

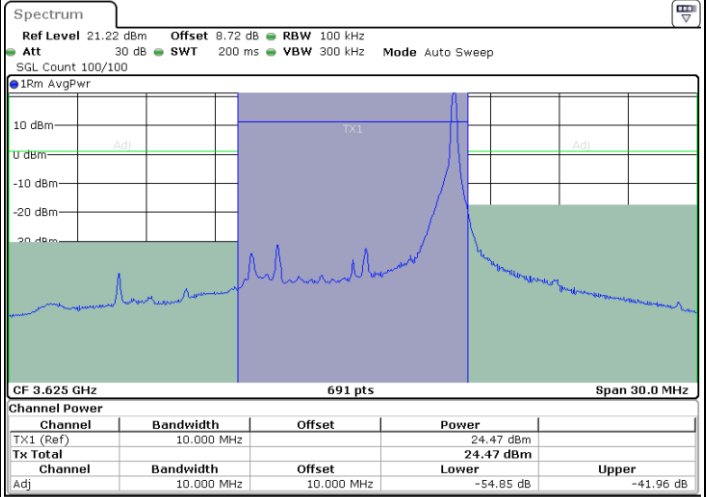

Date: 24.JUL.2024 04:47:04

Middle Channel / FullRB

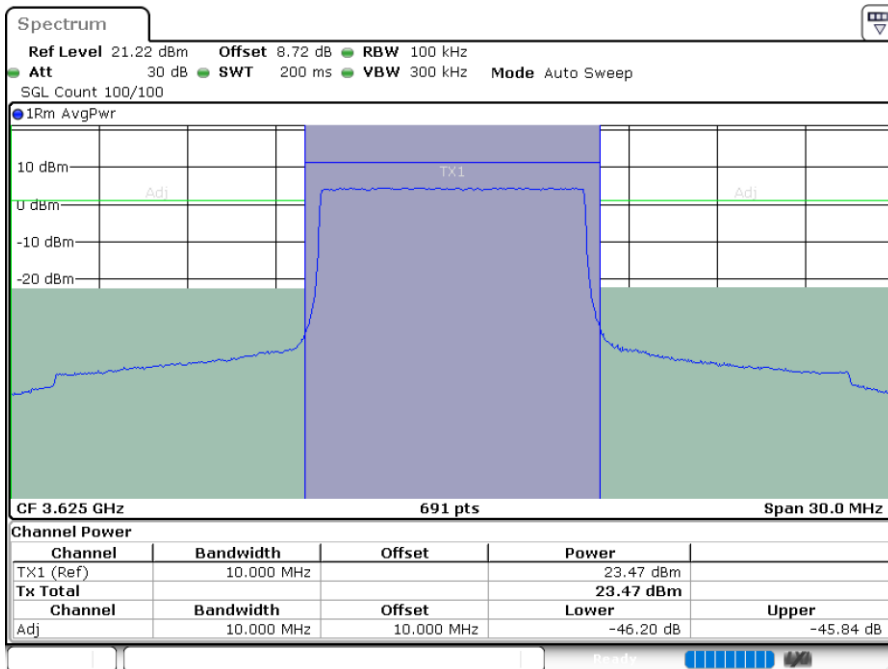

Date: 24.JUL.2024 04:50:04



LTE Band 48 / 10MHz

QPSK

Highest Channel / 1RB0

Highest Channel / 1RBmax

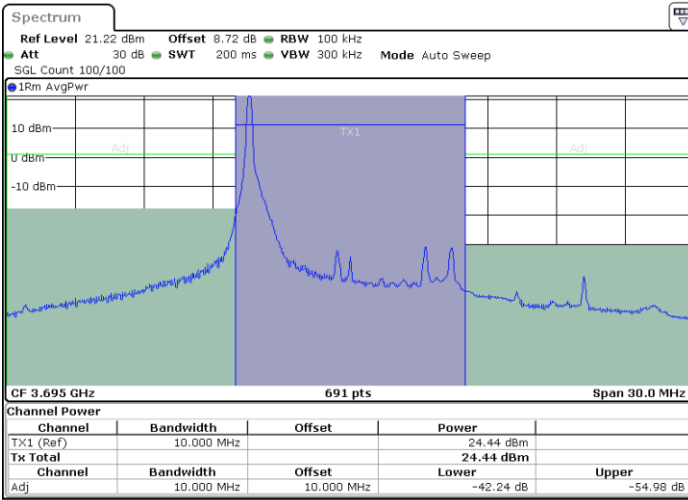

Date: 24.JUL.2024 04:53:05

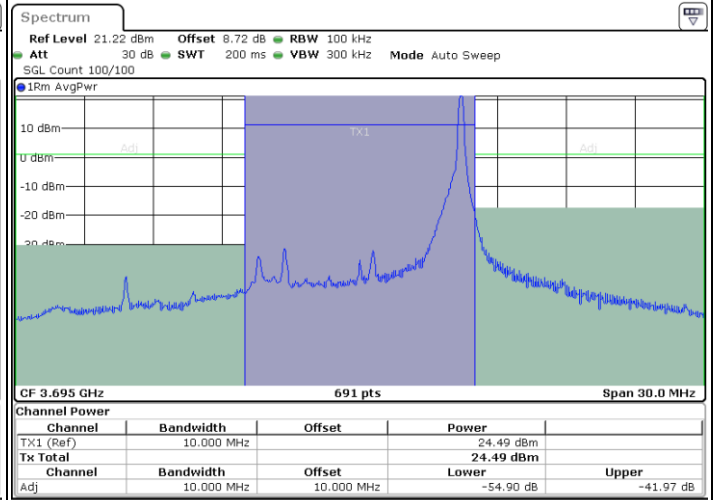

Date: 24.JUL.2024 04:56:17

Highest Channel / FullRB

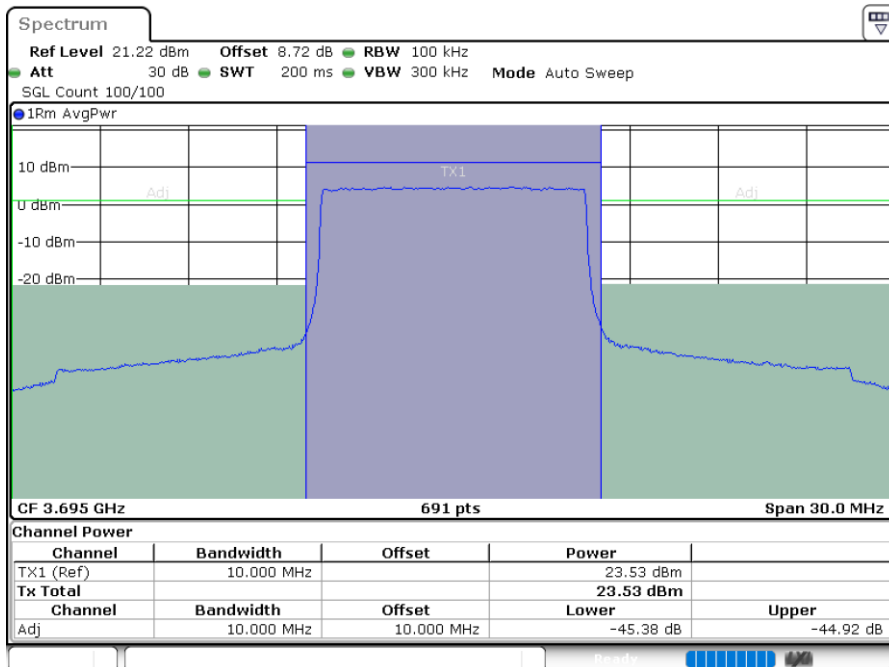

Date: 24.JUL.2024 04:59:26



LTE Band 48 / 10MHz

16QAM

Lowest Channel / 1RB0

Lowest Channel / 1RBmax

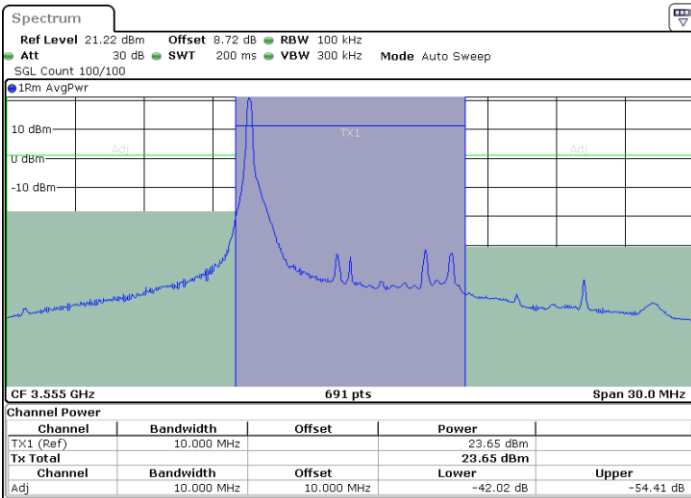

Date: 24.JUL.2024 04:35:39

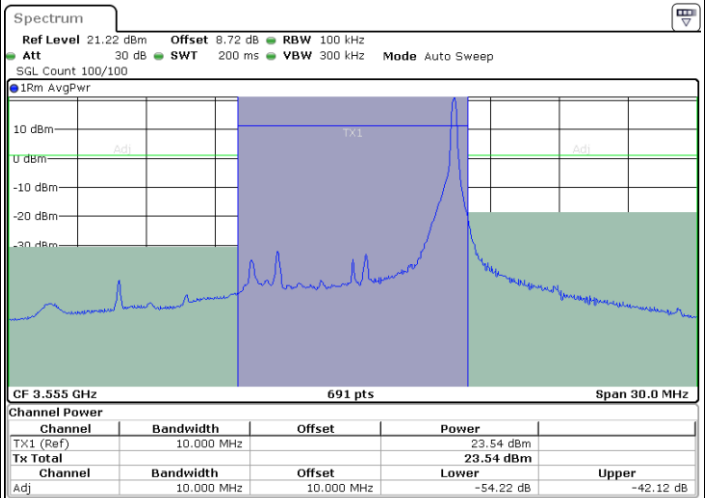

Date: 24.JUL.2024 04:38:44

Lowest Channel / FullRB

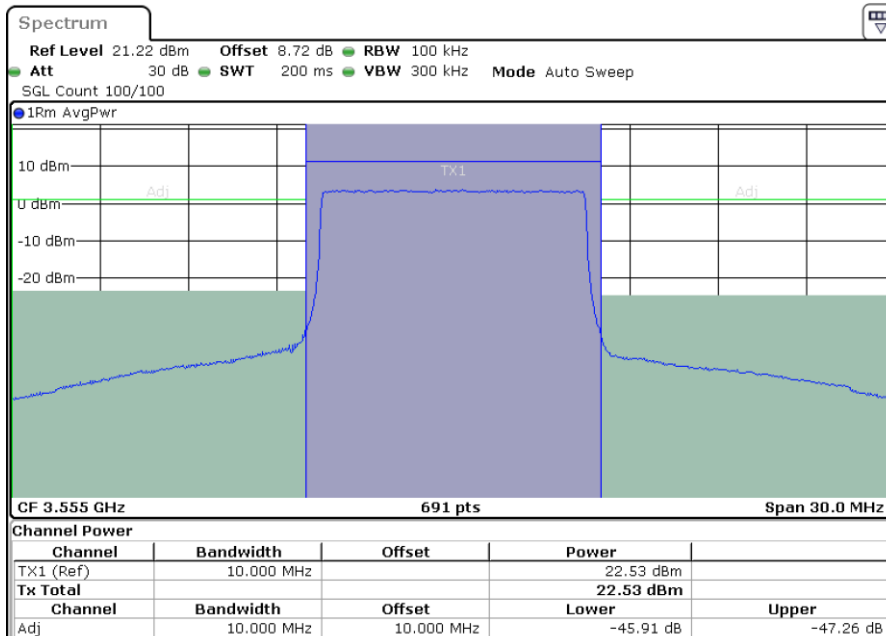

Date: 24.JUL.2024 04:41:46



LTE Band 48 / 10MHz

16QAM

Middle Channel / 1RB0

Middle Channel / 1RBmax

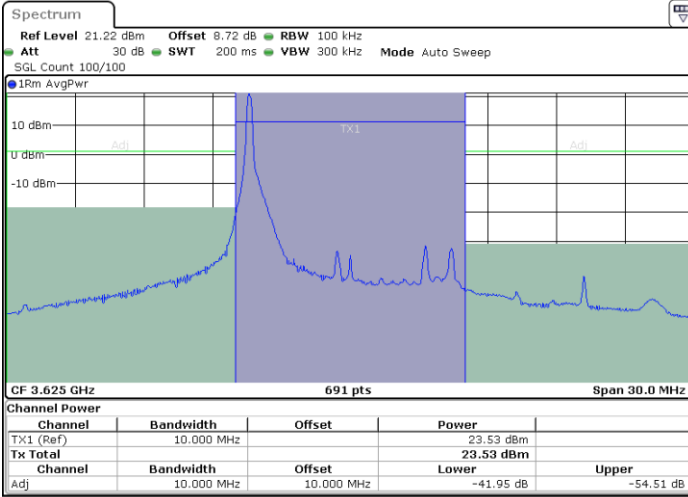

Date: 24.JUL.2024 04:44:49

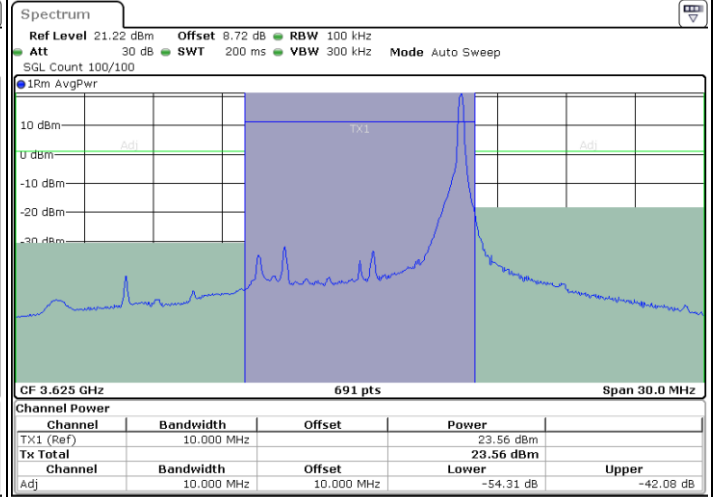

Date: 24.JUL.2024 04:47:49

Middle Channel / FullRB

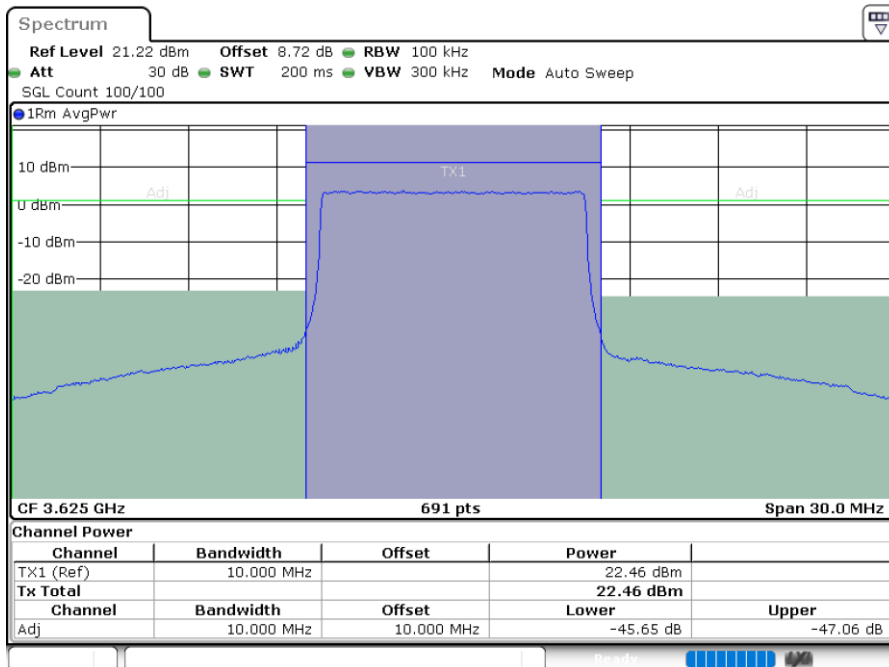

Date: 24.JUL.2024 04:50:49





LTE Band 48 / 10MHz

16QAM

Highest Channel / 1RB0

Highest Channel / 1RBmax

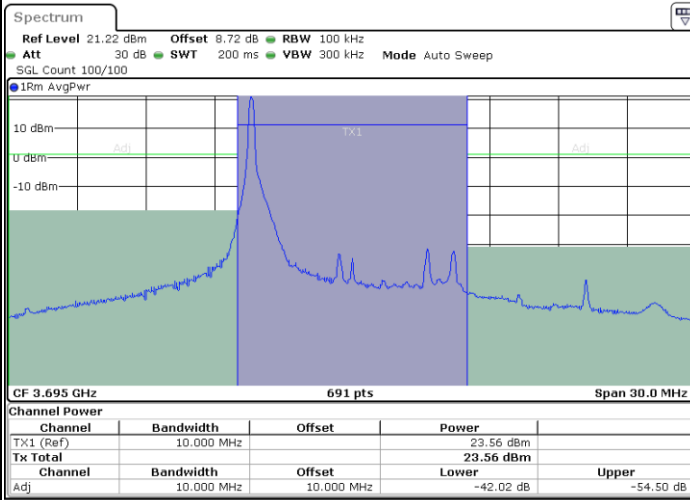

Date: 24.JUL.2024 04:53:58

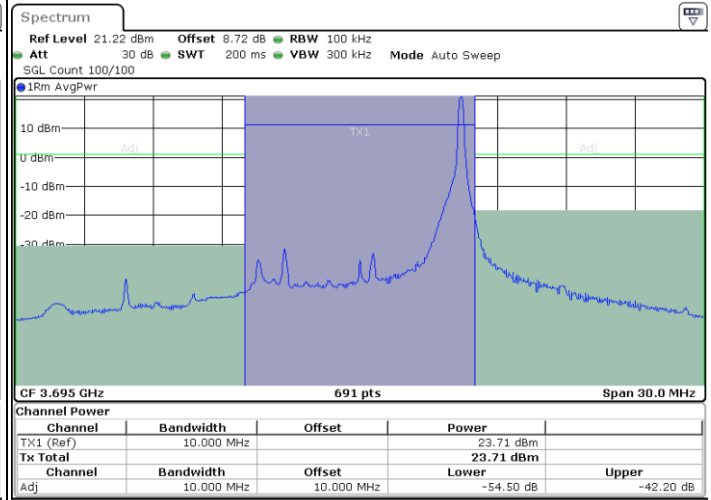

Date: 24.JUL.2024 04:57:07

Highest Channel / FullRB

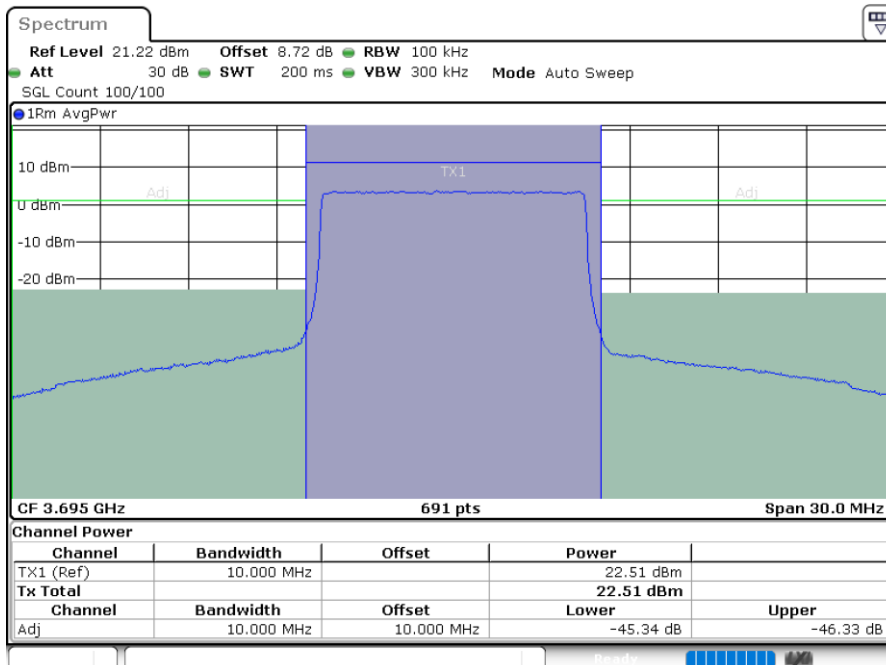

Date: 24.JUL.2024 05:00:12



LTE Band 48 / 10MHz

64QAM

Lowest Channel / 1RB0

Lowest Channel / 1RBmax

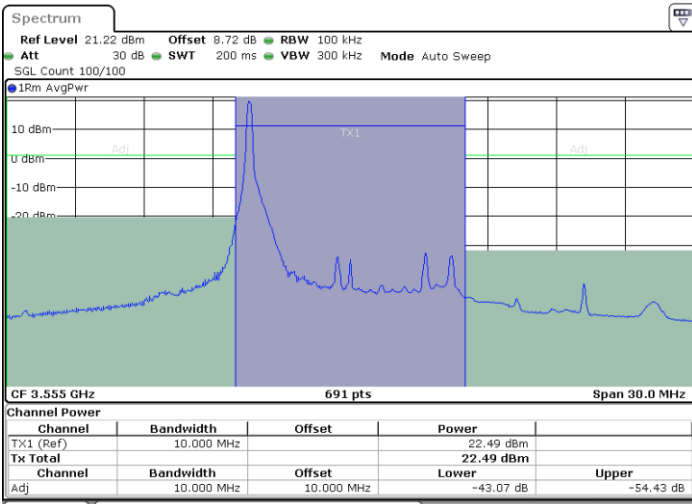

Date: 24.JUL.2024 04:36:24

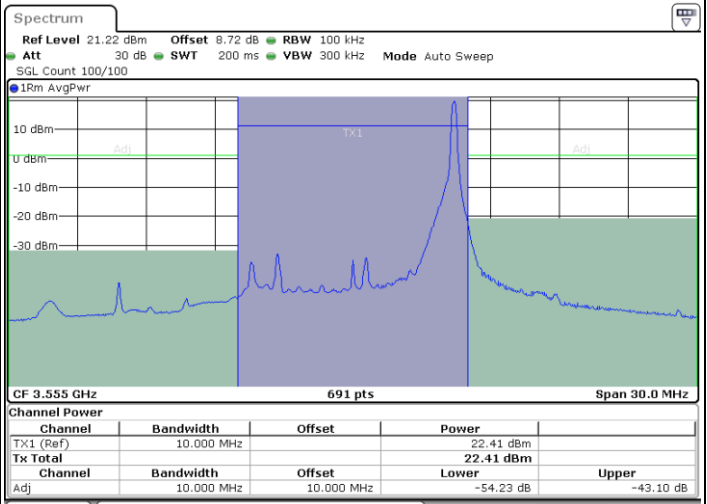

Date: 24.JUL.2024 04:39:30

Lowest Channel / FullRB

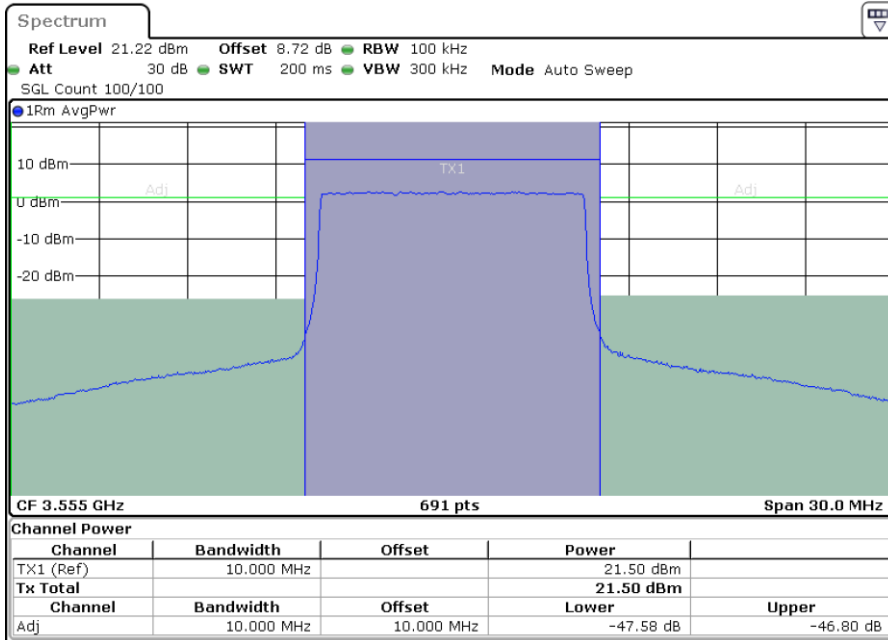

Date: 24.JUL.2024 04:42:32



LTE Band 48 / 10MHz

64QAM

Middle Channel / 1RB0

Middle Channel / 1RBmax

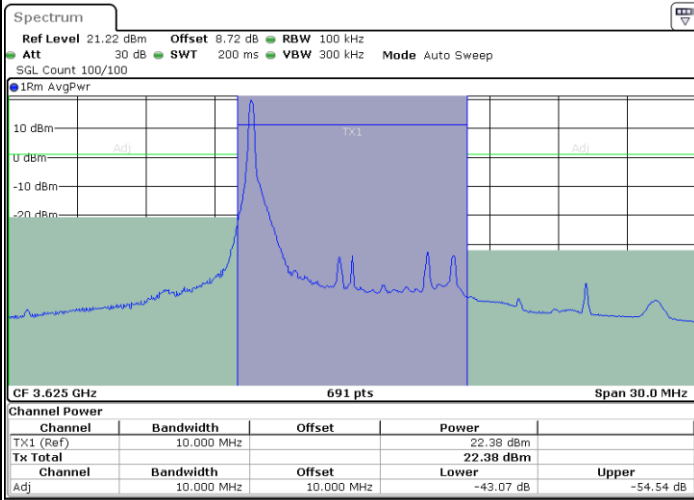

Date: 24.JUL.2024 04:45:33

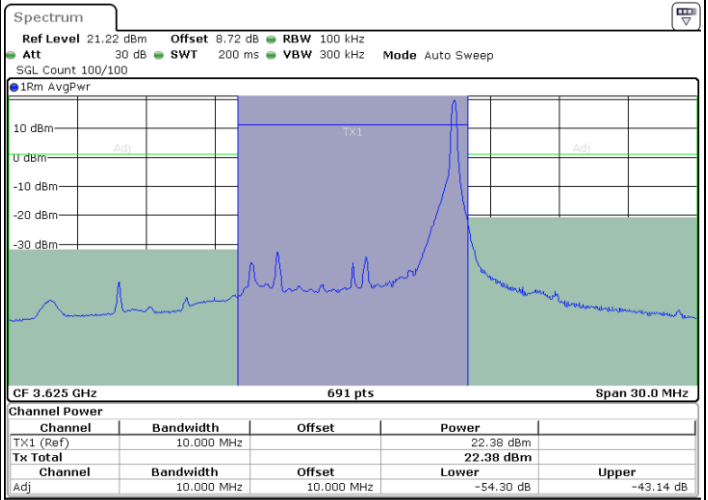

Date: 24.JUL.2024 04:48:34

Middle Channel / FullRB

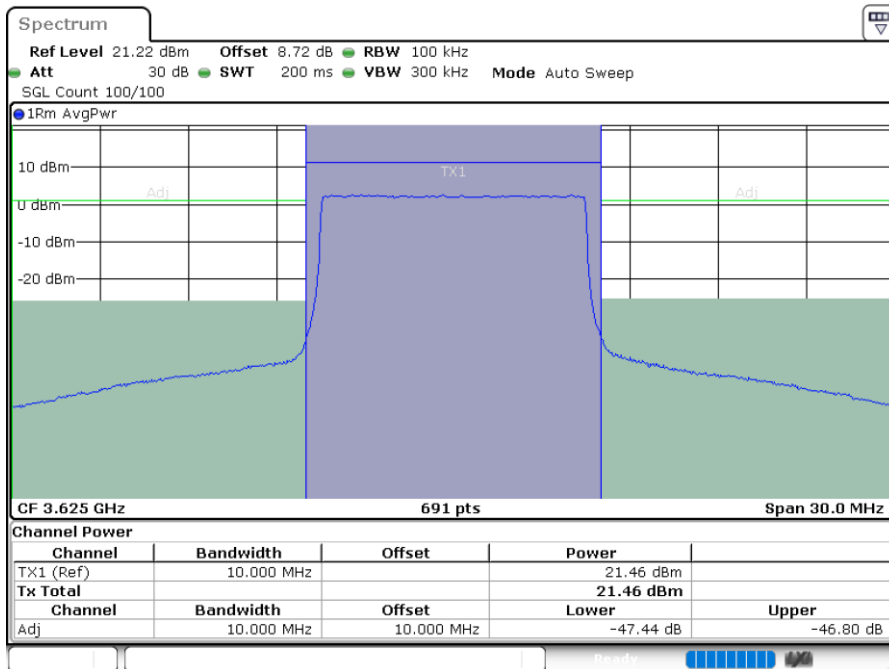

Date: 24.JUL.2024 04:51:34



LTE Band 48 / 10MHz

64QAM

Highest Channel / 1RB0

Highest Channel / 1RBmax

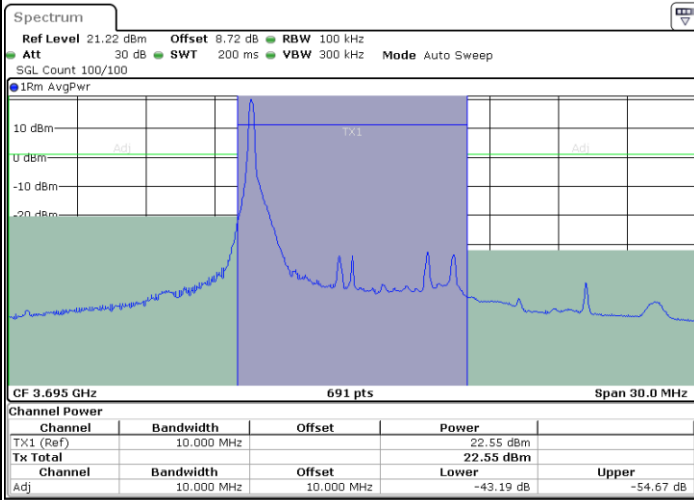

Date: 24.JUL.2024 04:54:44

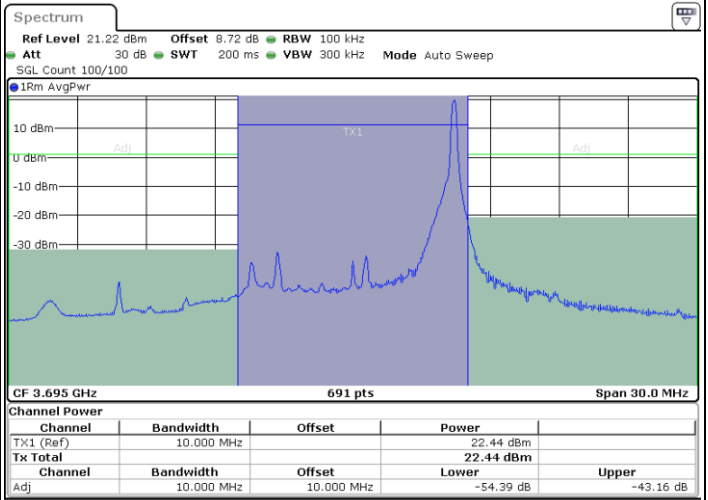

Date: 24.JUL.2024 04:57:53

Highest Channel / FullRB

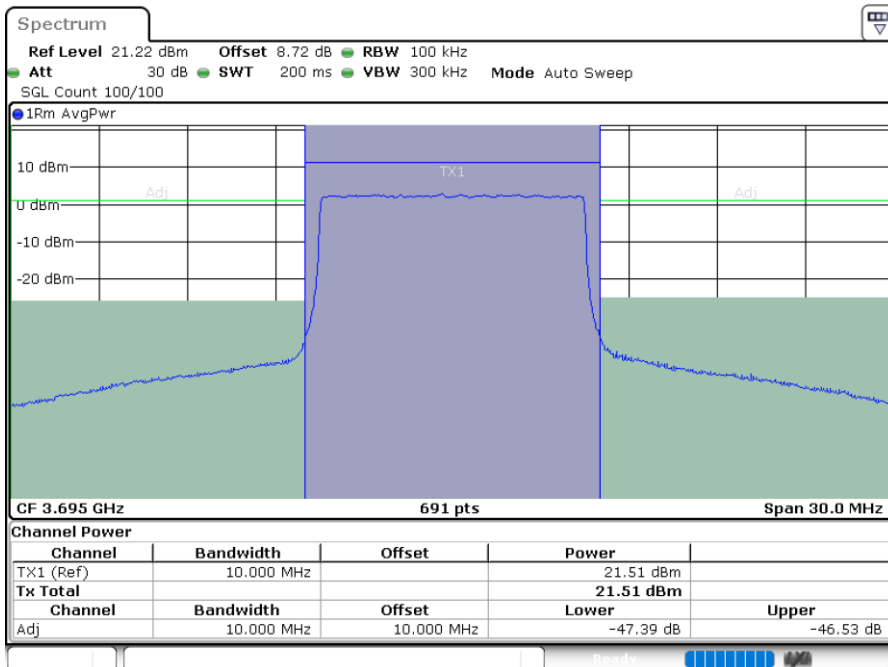

Date: 24.JUL.2024 05:00:58



LTE Band 48 / 10MHz

256QAM

Lowest Channel / 1RB0

Lowest Channel / 1RBmax

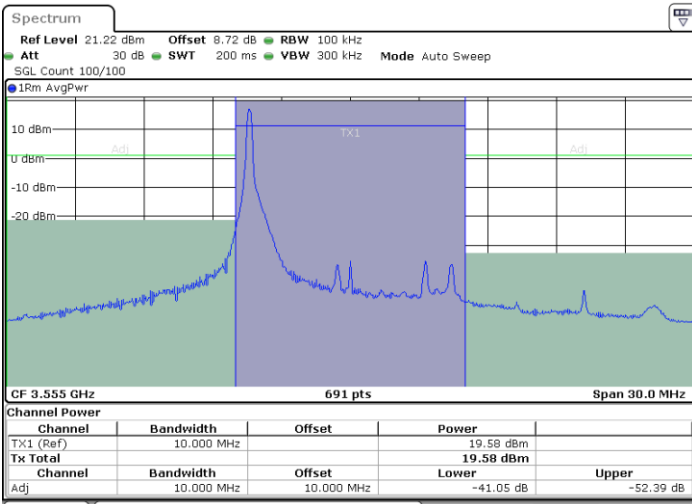

Date: 24.JUL.2024 04:37:10

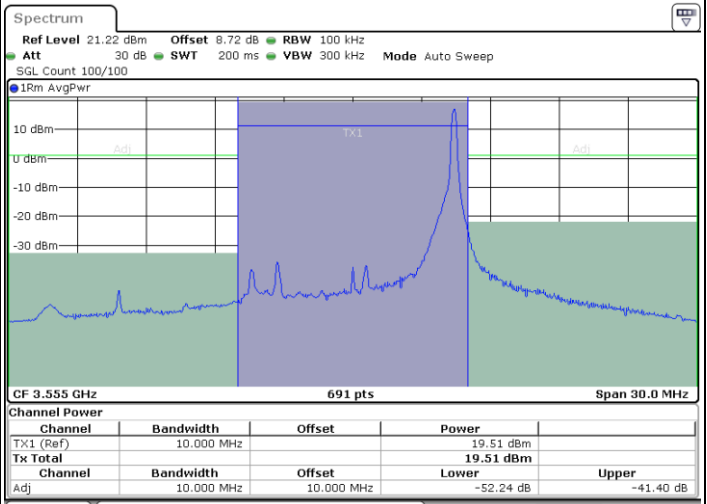

Date: 24.JUL.2024 04:40:15

Lowest Channel / FullRB

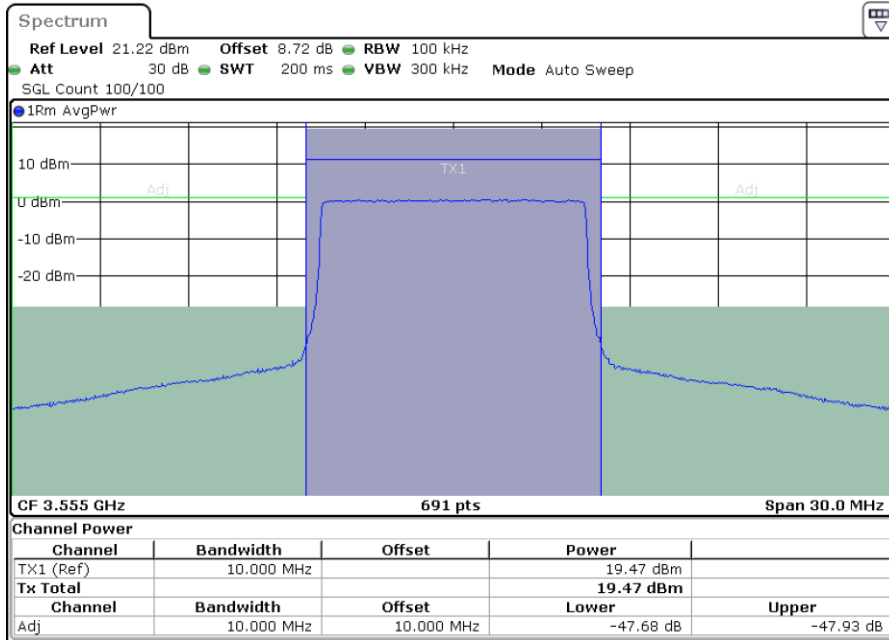

Date: 24.JUL.2024 04:43:18



LTE Band 48 / 10MHz

256QAM

Middle Channel / 1RB0

Middle Channel / 1RBmax

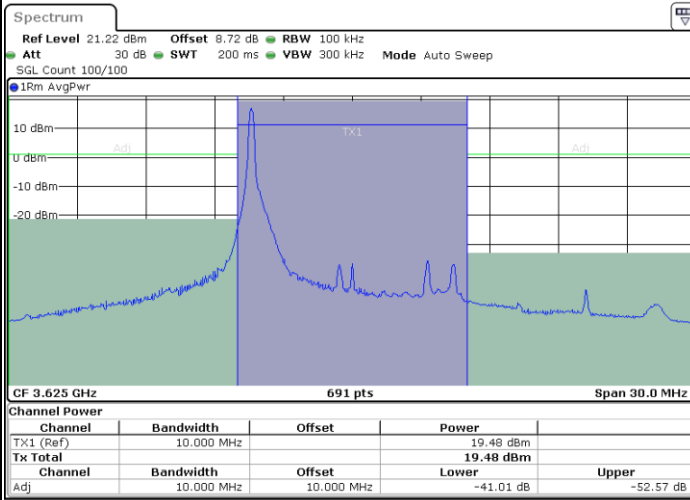

Date: 24.JUL.2024 04:46:19

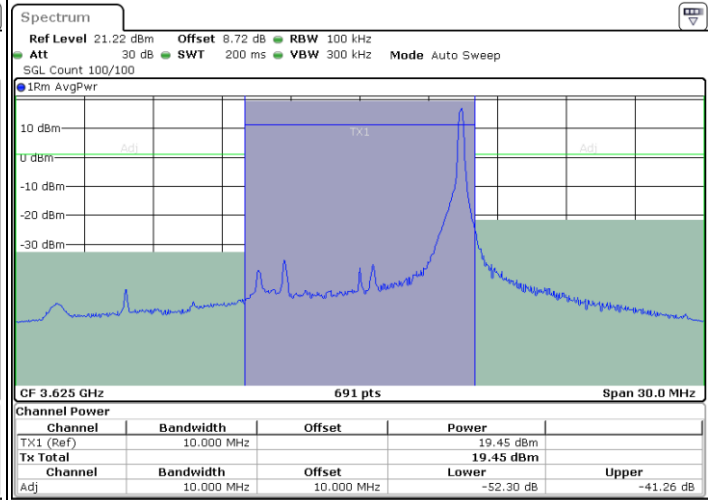

Date: 24.JUL.2024 04:49:19

Middle Channel / FullRB

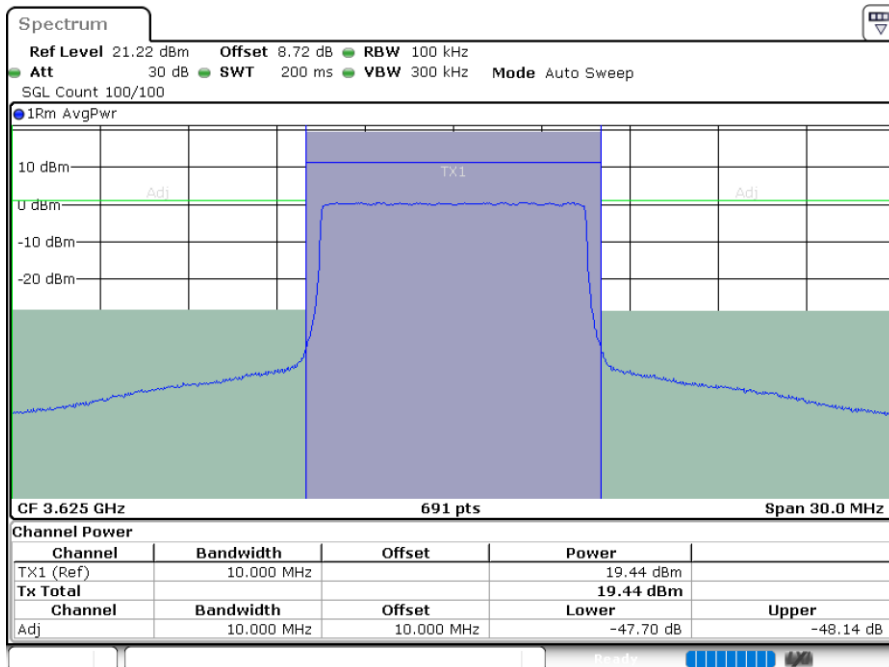

Date: 24.JUL.2024 04:52:19



LTE Band 48 / 10MHz

256QAM

Highest Channel / 1RB0

Highest Channel / 1RBmax

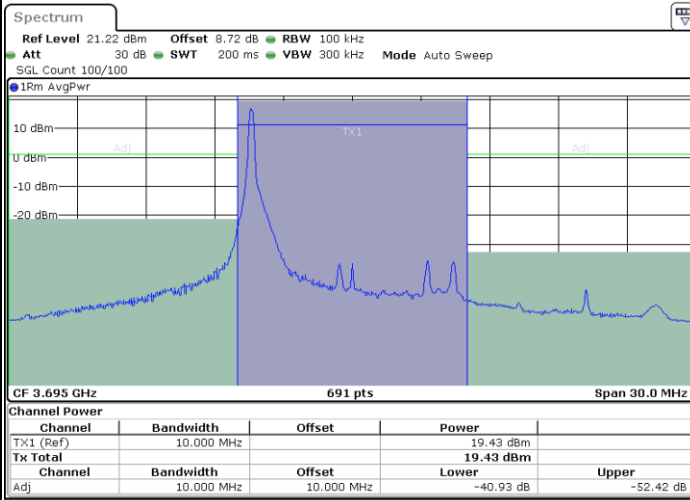

Date: 24.JUL.2024 04:55:31

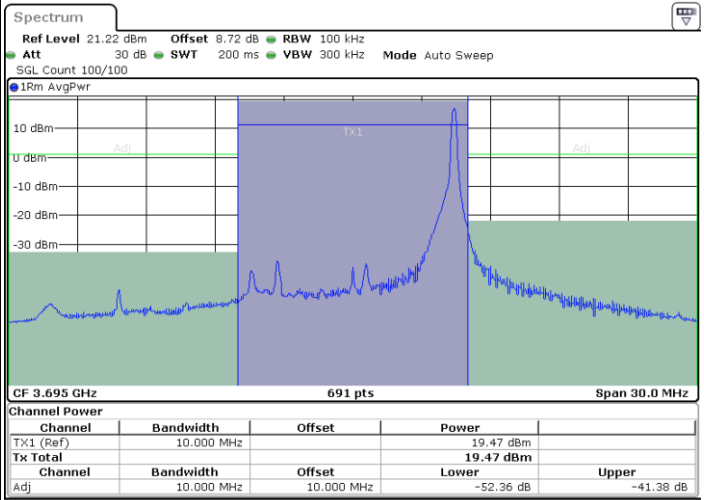

Date: 24.JUL.2024 04:58:39

Highest Channel / FullRB

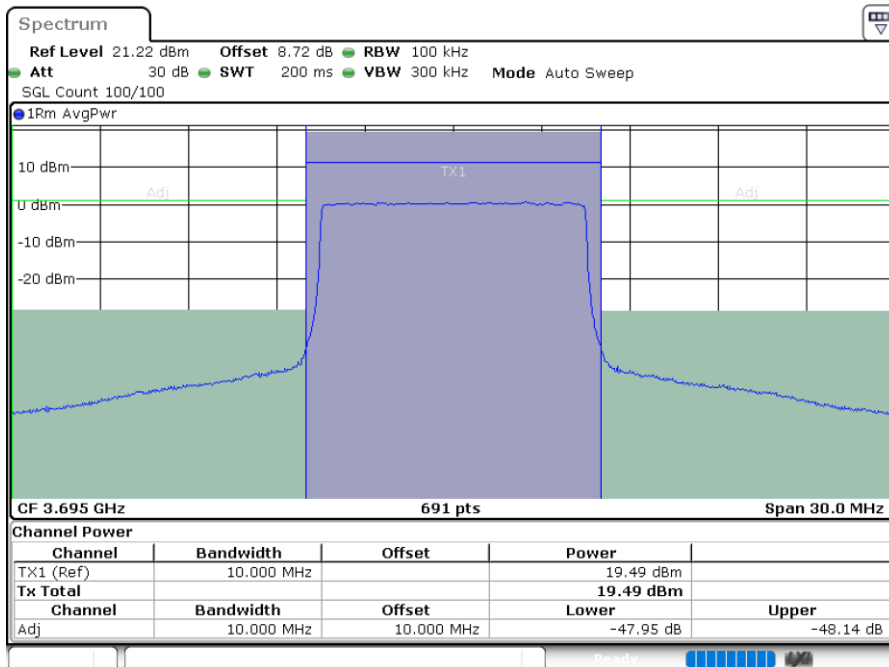

Date: 24.JUL.2024 05:01:44



LTE Band 48 / 15MHz

QPSK

Lowest Channel / 1RB0

Lowest Channel / 1RBmax

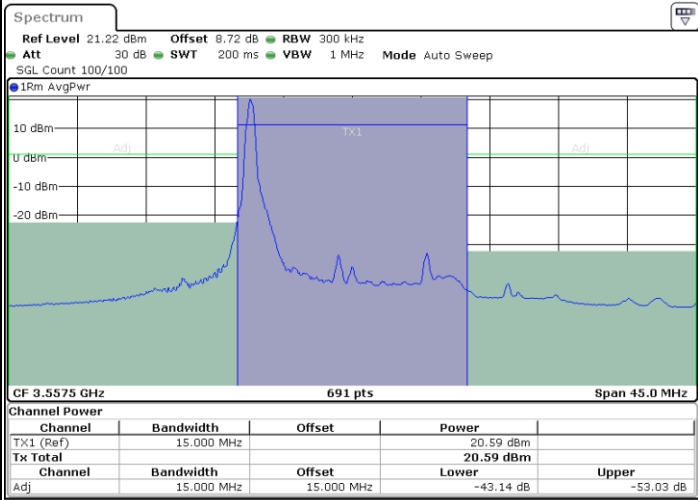

Date: 24.JUL.2024 05:03:12

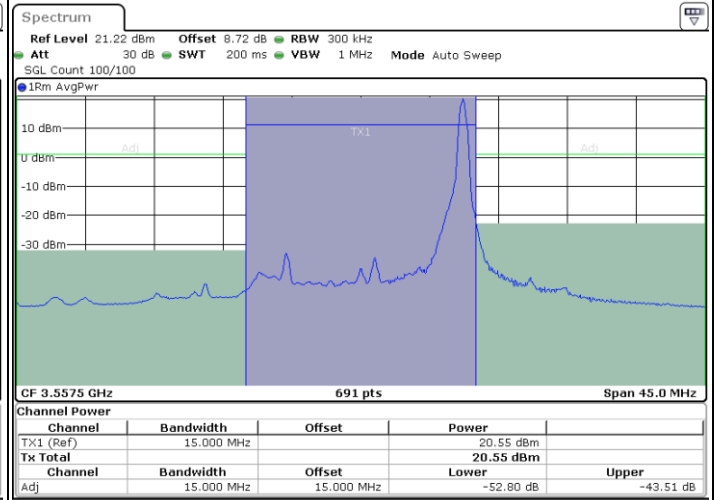

Date: 24.JUL.2024 05:06:19

Lowest Channel / FullRB

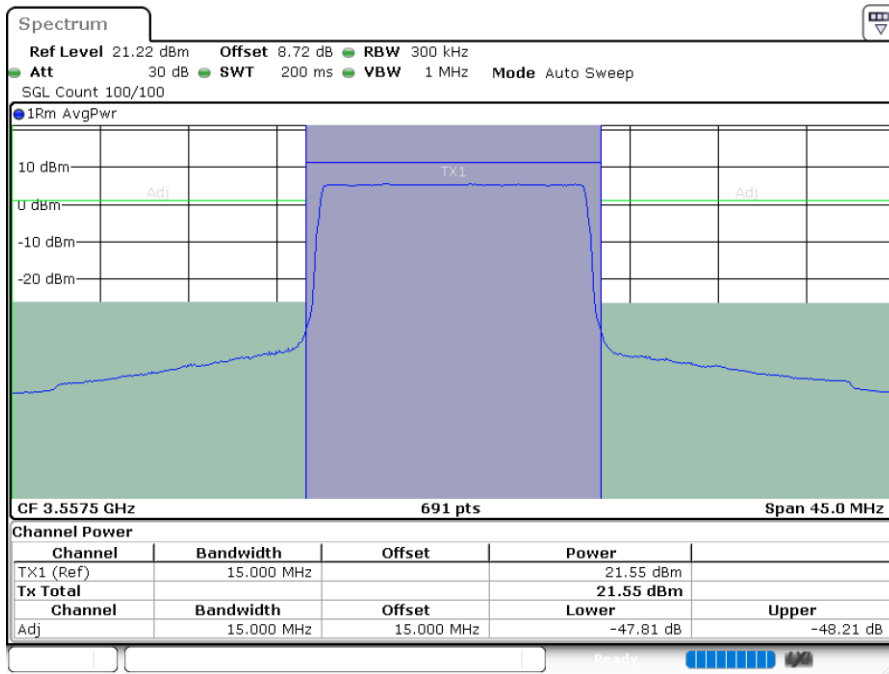

Date: 24.JUL.2024 05:09:22





LTE Band 48 / 15MHz

QPSK

Middle Channel / 1RB0

Middle Channel / 1RBmax

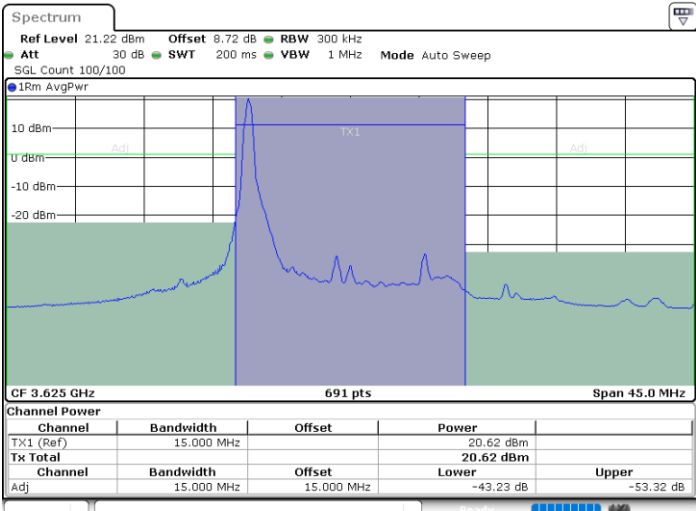

Date: 24.JUL.2024 05:12:21

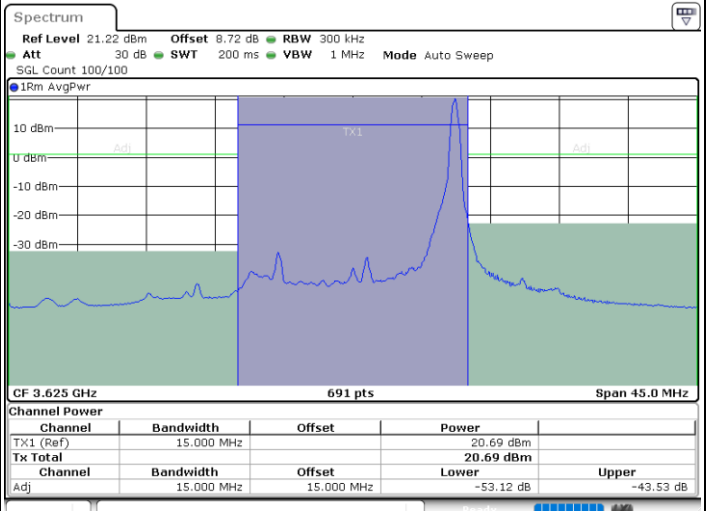

Date: 24.JUL.2024 05:15:19

Middle Channel / FullRB

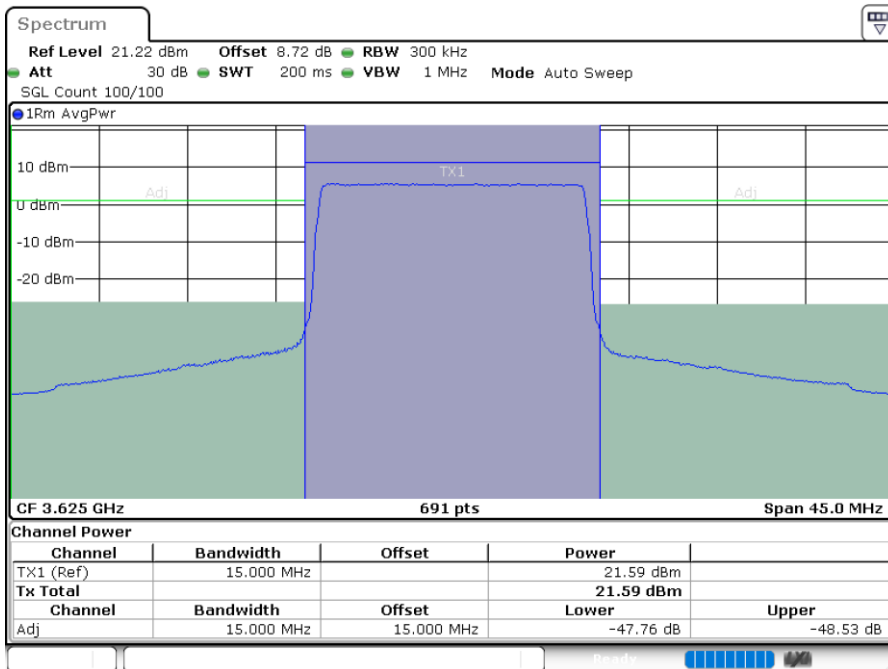

Date: 24.JUL.2024 05:18:15



LTE Band 48 / 15MHz

QPSK

Highest Channel / 1RB0

Highest Channel / 1RBmax

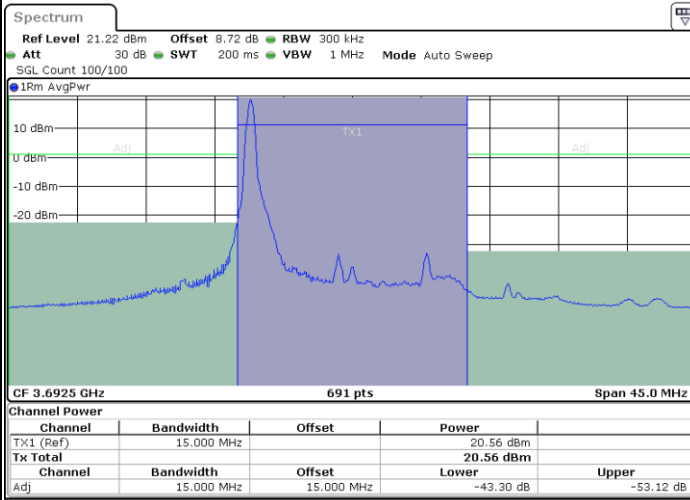

Date: 24.JUL.2024 05:21:13

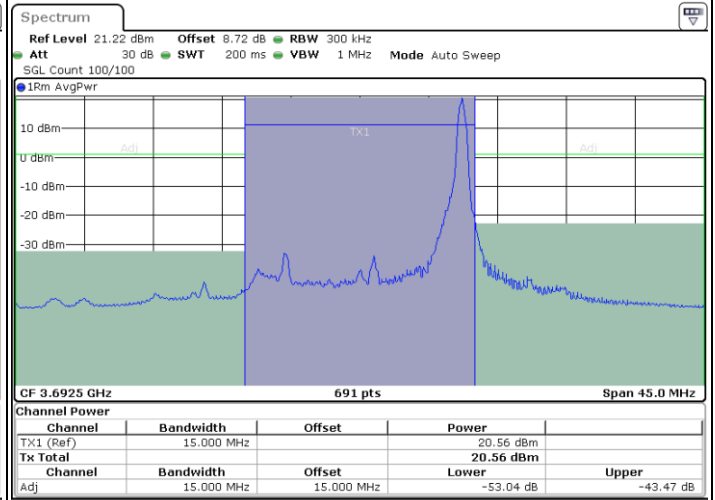

Date: 24.JUL.2024 05:24:19

Highest Channel / FullRB

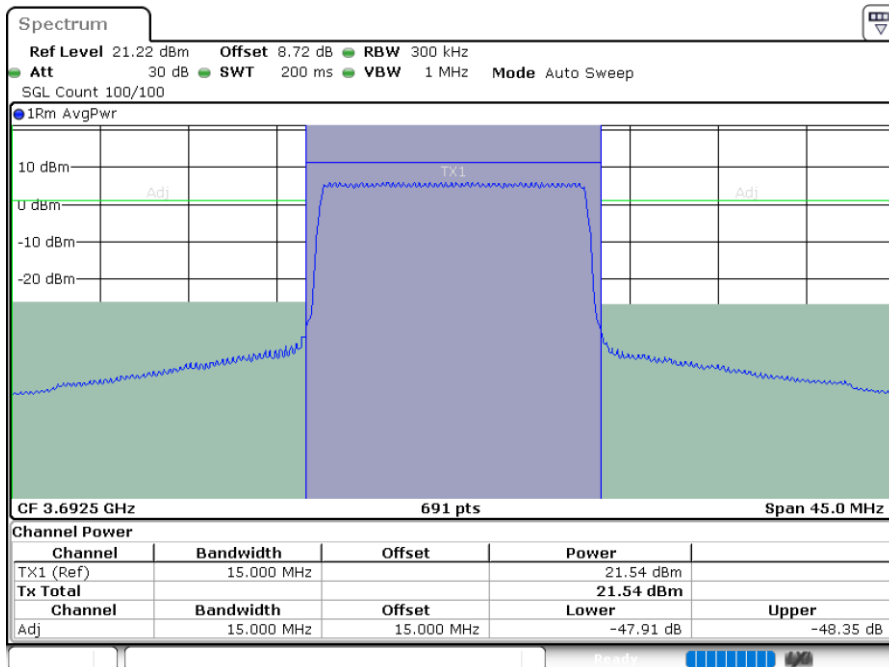

Date: 24.JUL.2024 05:27:32



LTE Band 48 / 15MHz

16QAM

Lowest Channel / 1RB0

Lowest Channel / 1RBmax

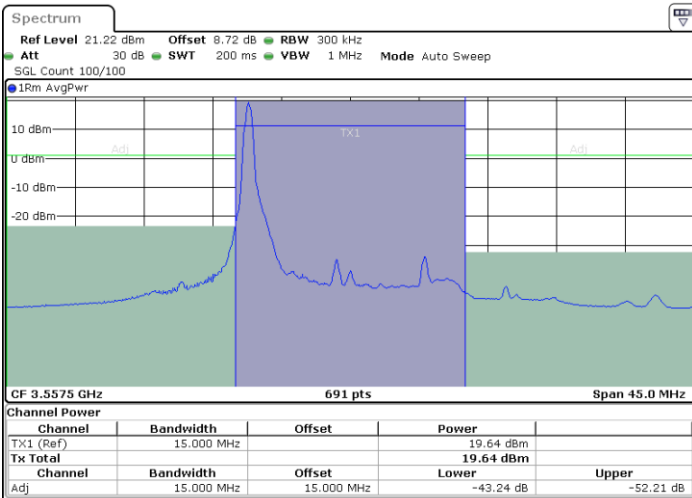

Date: 24.JUL.2024 05:04:04

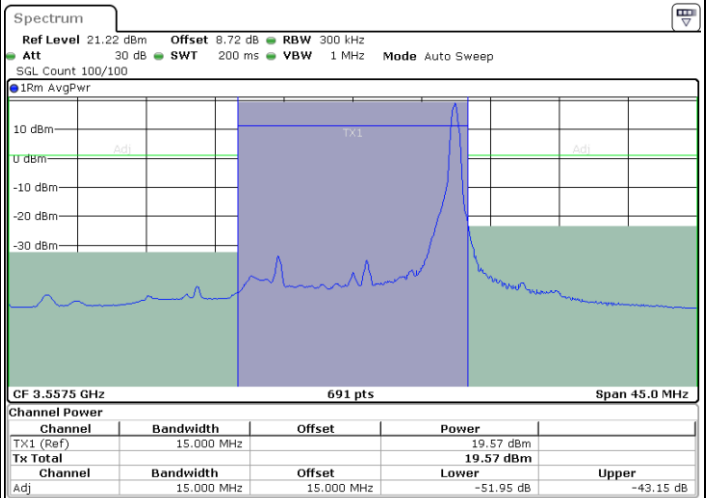

Date: 24.JUL.2024 05:07:07

Lowest Channel / FullRB

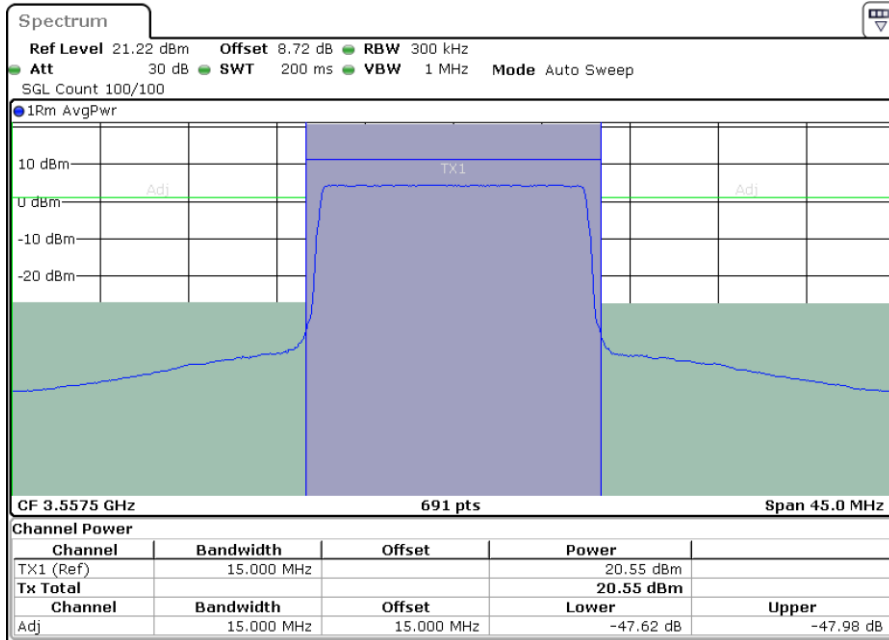

Date: 24.JUL.2024 05:10:06



LTE Band 48 / 15MHz

16QAM

Middle Channel / 1RB0

Middle Channel / 1RBmax

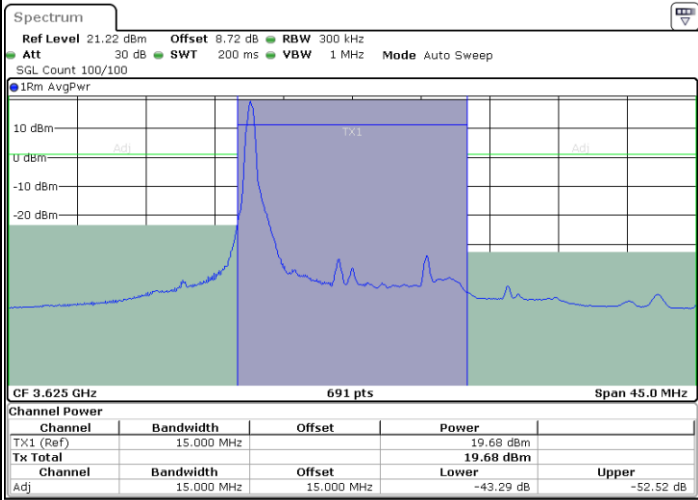

Date: 24.JUL.2024 05:13:05

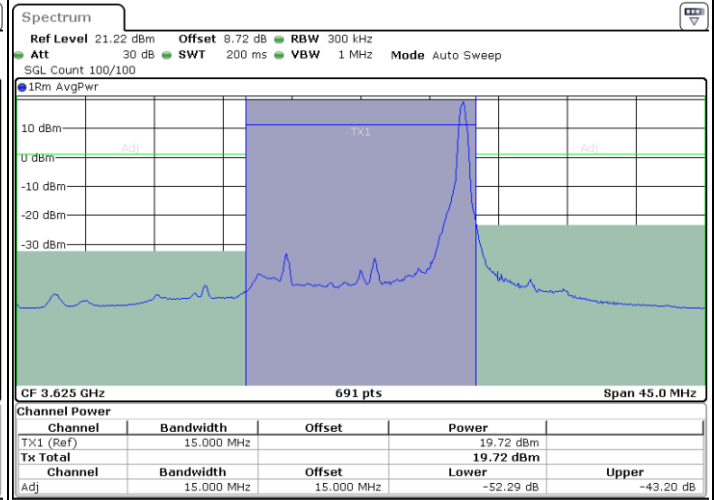

Date: 24.JUL.2024 05:16:02

Middle Channel / FullRB

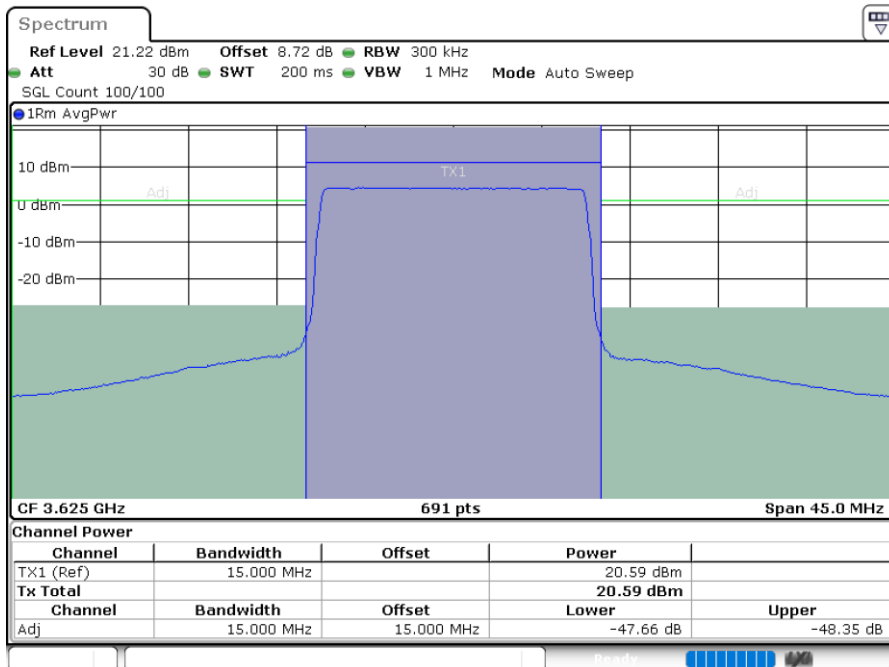

Date: 24.JUL.2024 05:19:00



LTE Band 48 / 15MHz

16QAM

Highest Channel / 1RB0

Highest Channel / 1RBmax

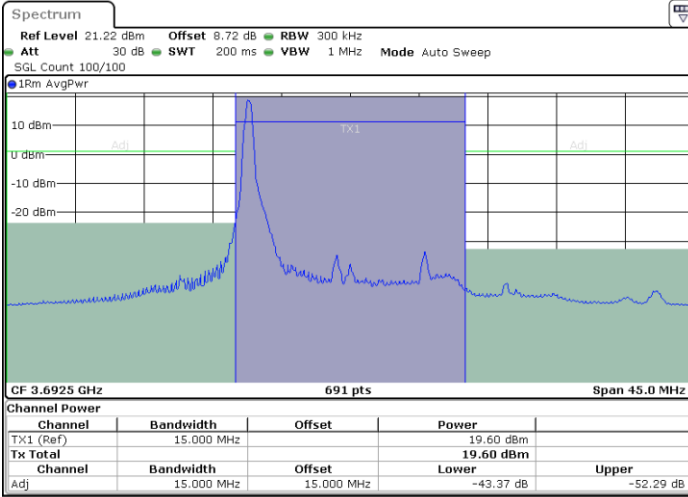

Date: 24.JUL.2024 05:22:05

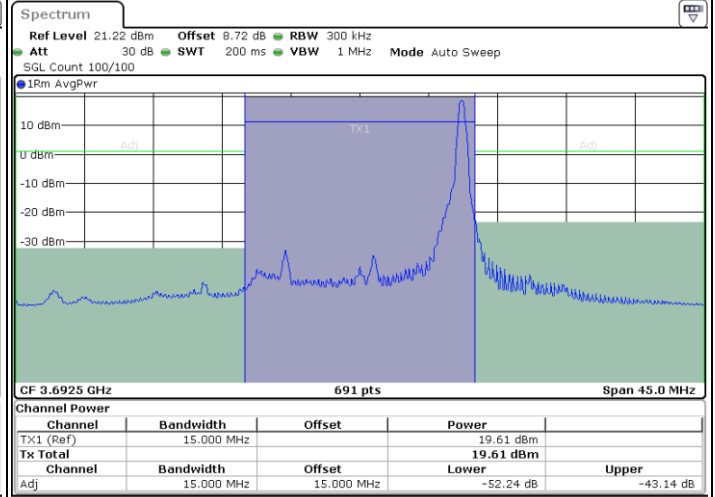

Date: 24.JUL.2024 05:25:17

Highest Channel / FullRB

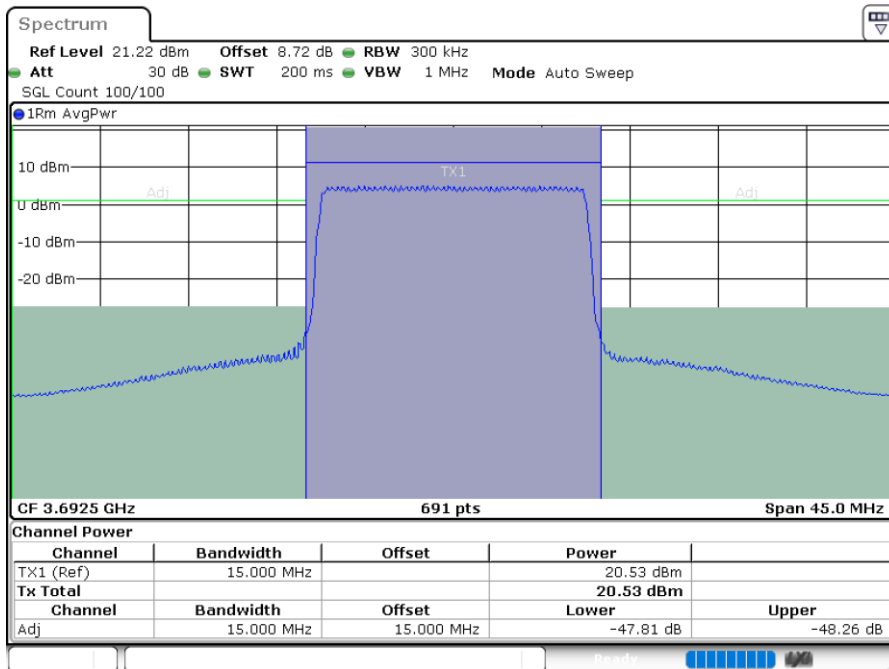

Date: 24.JUL.2024 05:28:17



LTE Band 48 / 15MHz

64QAM

Lowest Channel / 1RB0

Lowest Channel / 1RBmax

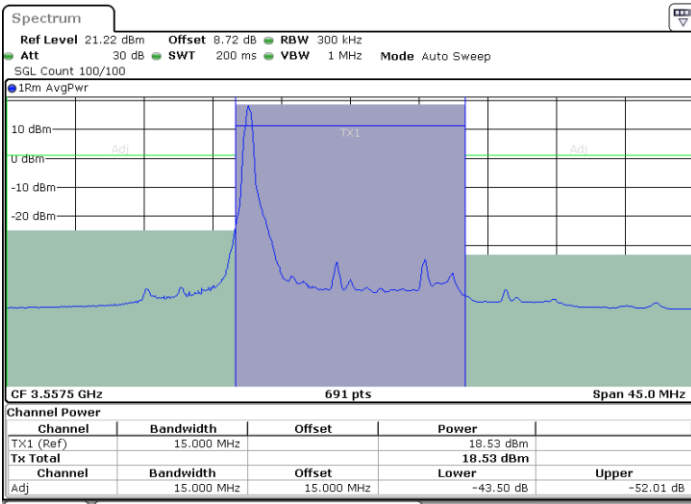

Date: 24.JUL.2024 05:04:49

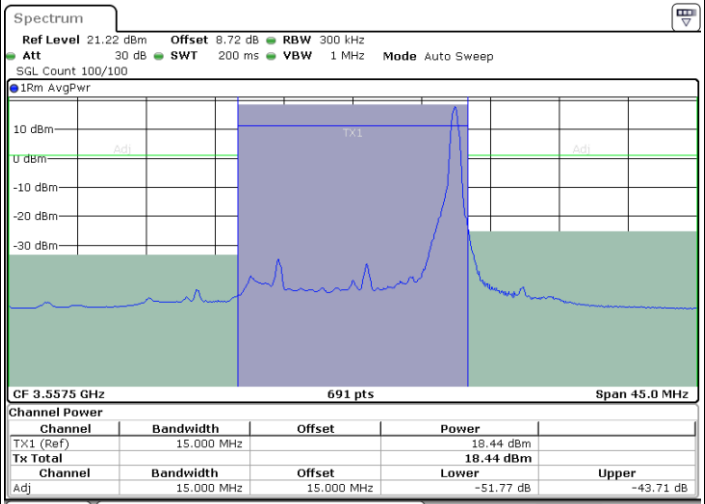

Date: 24.JUL.2024 05:07:52

Lowest Channel / FullRB

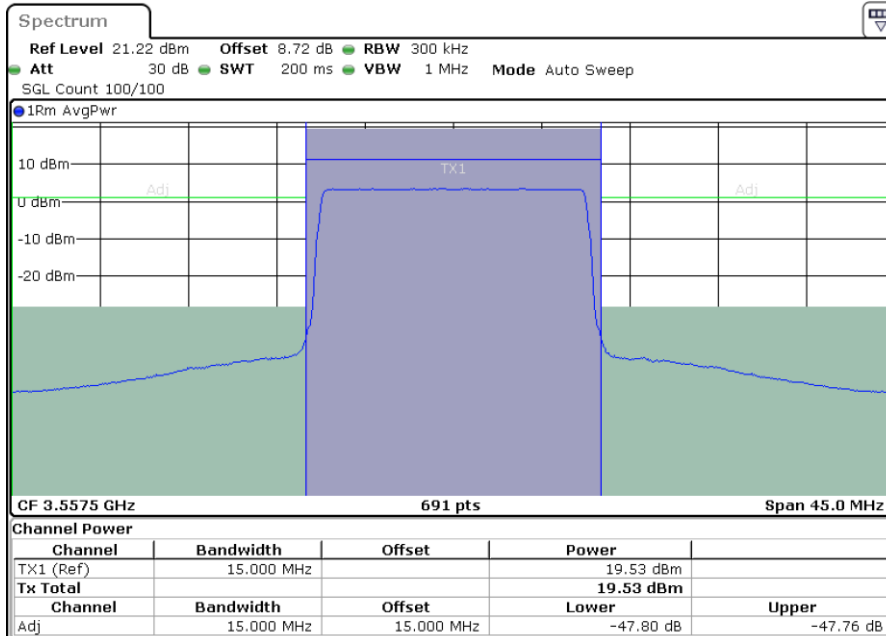

Date: 24.JUL.2024 05:10:51



LTE Band 48 / 15MHz

64QAM

Middle Channel / 1RB0

Middle Channel / 1RBmax

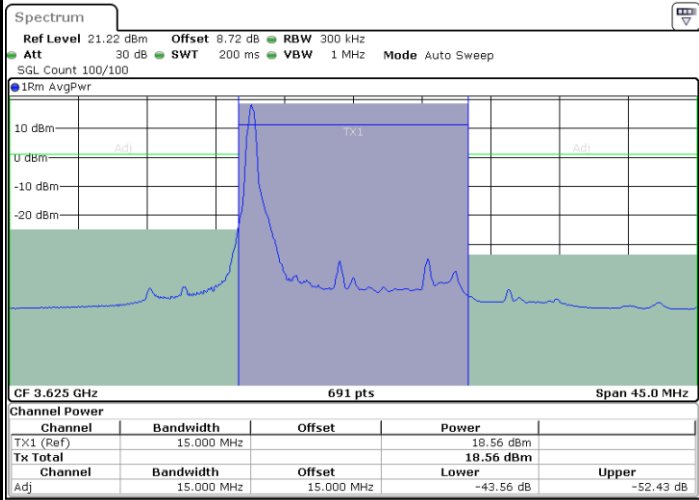

Date: 24.JUL.2024 05:13:50

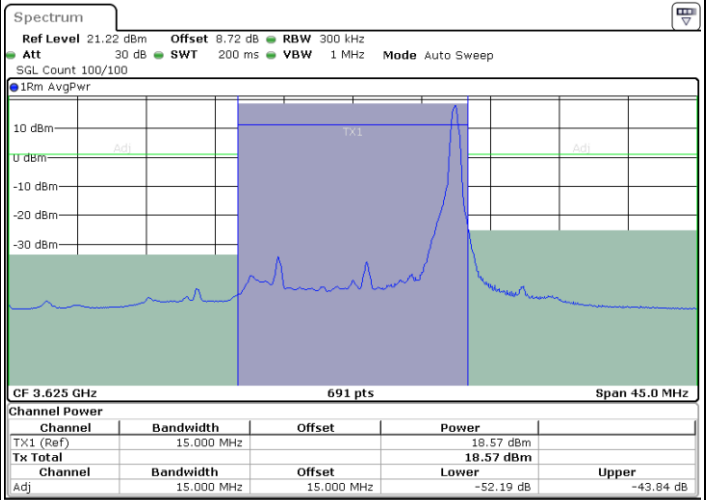

Date: 24.JUL.2024 05:16:47

Middle Channel / FullRB

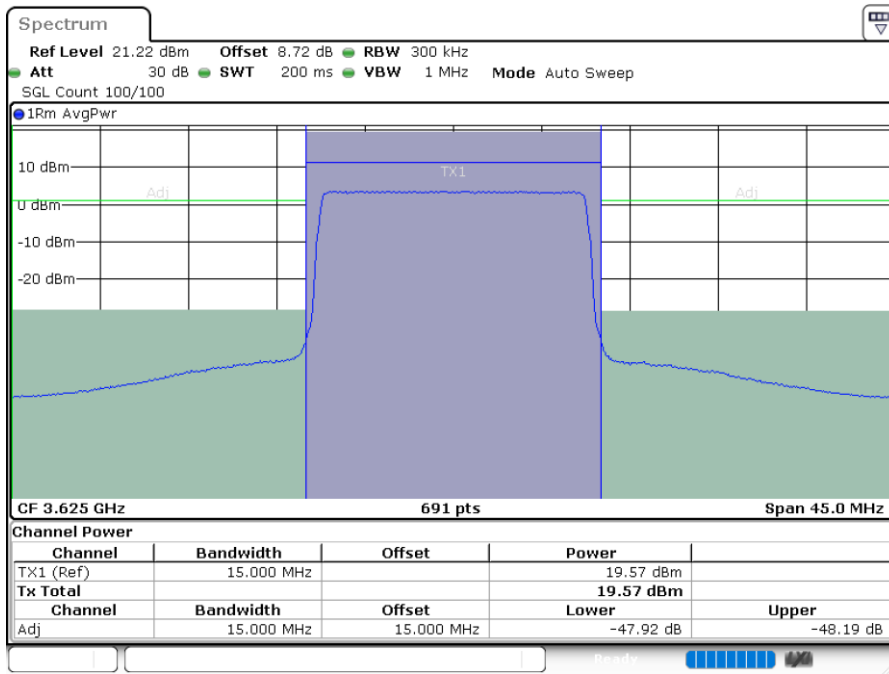

Date: 24.JUL.2024 05:19:44