

# TEST REPORT

**Application No.:** SEWM2309000395RG  
**Applicant:** Xiaomi Communications Co., Ltd.  
**Address of Applicant:** #019, 9th Floor, Building 6, 33 Xi'erqi Middle Road, Haidian District, Beijing, China, 100085  
**Manufacturer:** Xiaomi Communications Co., Ltd.  
**Address of Manufacturer:** #019, 9th Floor, Building 6, 33 Xi'erqi Middle Road, Haidian District, Beijing, China, 100085  
**EUT Description:** Mobile Phone  
**Model No.:** 23122PCD1G  
**Trade Mark:** POCO  
**FCC ID:** 2AFZZPCD1G  
**Standards:** FCC 47 CFR Part 2, Subpart J  
 FCC 47 CFR Part 15, Subpart C  
**Date of Receipt:** 2023/07/31 (for original report SEWM2307000261RG05)  
 2023/09/23 (for new report SEWM2309000395RG05)  
**Date of Test:** 2023/08/05 to 2023/08/22 (for original report SEWM2307000261RG05)  
 2023/09/23 to 2023/10/09 (for new report SEWM2309000395RG05)  
**Date of Issue:** 2023/10/27

<b>Test Result :</b>	<b>PASS *</b>
----------------------	---------------

\* In the configuration tested, the EUT detailed in this report complied with the standards specified above.

Authorized Signature:

Well Wei  
 Wireless Laboratory Manager



Unless otherwise agreed in writing, this document is issued by the Company subject to its General Conditions of Service printed overleaf, available on request or accessible at <http://www.sgs.com/en/Terms-and-Conditions.aspx> and, for electronic format documents, subject to Terms and Conditions for Electronic Documents at <http://www.sgs.com/en/Terms-and-Conditions/Terms-e-Documents.aspx>. Attention is drawn to the limitation of liability, indemnification and jurisdiction issues defined therein. Any holder of this document is advised that information contained hereon reflects the Company's findings at the time of its intervention only and within the limits of Client's instructions, if any. The Company's sole responsibility is to its Client and this document does not exonerate parties to a transaction from exercising all their rights and obligations under the transaction documents. This document cannot be reproduced except in full, without prior written approval of the Company. Any unauthorized alteration, forgery or falsification of the content or appearance of this document is unlawful and offenders may be prosecuted to the fullest extent of the law. Unless otherwise stated the results shown in this test report refer only to the sample(s) tested and such sample(s) are retained for 30 days only.  
**Attention: To check the authenticity of testing/inspection report & certificate, please contact us at telephone: (86-755) 8307 1443, or email: [CN.Doccheck@sgs.com](mailto:CN.Doccheck@sgs.com)**  
 South of No. 6 Plant, No. 1, Runsheng Road, Suzhou Industrial Park, Suzhou Area, China (Jiangsu) Pilot Free Trade Zone 215000 t (86-512) 62992980 www.sgsgroup.com.cn  
 中国·苏州·中国(江苏)自由贸易试验区苏州片区苏州工业园区润胜路1号的6号厂房南楼 邮编: 215000 t (86-512) 62992980 sgs.china@sgs.com

# 1 Version

Revision Record				
Version	Chapter	Date	Modifier	Remark
01		2023/10/27		Original

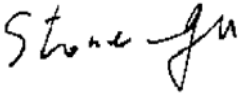
<b>Prepared By</b>		 <hr/> <b>(Yves Cheng) / Test Engineer</b>
<b>Checked By</b>		 <hr/> <b>(Stone Gu) / Reviewer</b>



Unless otherwise agreed in writing, this document is issued by the Company subject to its General Conditions of Service printed overleaf, available on request or accessible at <http://www.sgs.com/en/Terms-and-Conditions.aspx> and, for electronic format documents, subject to Terms and Conditions for Electronic Documents at <http://www.sgs.com/en/Terms-and-Conditions/Terms-e-Document.aspx>. Attention is drawn to the limitation of liability, indemnification and jurisdiction issues defined therein. Any holder of this document is advised that information contained hereon reflects the Company's findings at the time of its intervention only and within the limits of Client's instructions, if any. The Company's sole responsibility is to its Client and this document does not exonerate parties to a transaction from exercising all their rights and obligations under the transaction documents. This document cannot be reproduced except in full, without prior written approval of the Company. Any unauthorized alteration, forgery or falsification of the content or appearance of this document is unlawful and offenders may be prosecuted to the fullest extent of the law. Unless otherwise stated the results shown in this test report refer only to the sample(s) tested and such sample(s) are retained for 30 days only.

Attention: To check the authenticity of testing/inspection report & certificate, please contact us at telephone: (86-755) 8307 1443, or email: [CN.Doccheck@sgs.com](mailto:CN.Doccheck@sgs.com)

South of No. 6 Plant, No. 1, Runsheng Road, Suzhou Industrial Park, Suzhou Area, China (Jiangsu) Pilot Free Trade Zone 215000 t (86-512) 62992980 www.sgs.com.cn  
 中国·苏州·中国(江苏)自由贸易试验区苏州片区苏州工业园区润胜路1号的6号厂房南楼 邮编: 215000 t (86-512) 62992980 sgs.china@sgs.com

## 2 Test Summary

Test Item	FCC Rule No.	Test Method	Test Result	Result
Antenna Requirement	15.203/15.247(b)	--	Clause 4.1	PASS
AC Power Line Conducted Emission	15.207	ANSI C63.10-2020 Section 6.2	Clause 4.2	PASS
Duty Cycle	--	ANSI C63.10-2020 Section 11.6	Clause 4.3	For Report Purpose
Conducted Output Power	15.247 (b)(3)	ANSI C63.10-2020 Section 11.9.1.2	Clause 4.4	PASS
DTS (6 dB) Bandwidth & 99% Occupied Bandwidth	15.247 (a)(2)	ANSI C63.10-2020 Section 11.8 Option 2 / 6.9.3	Clause 4.5	PASS
Power Spectral Density	15.247 (e)	ANSI C63.10-2020 Section 11.10.2	Clause 4.6	PASS
Band-edge for RF Conducted Emissions	15.247(d)	ANSI C63.10-2020 Section 11.11	Clause 4.7	PASS
RF Conducted Spurious Emissions	15.247(d)	ANSI C63.10-2020 Section 11.11	Clause 4.8	PASS
Radiated Spurious Emissions	15.247(d);15.205/15.209	ANSI C63.10-2020 Section 11.12	Clause 4.9	PASS
Restricted bands around fundamental frequency (Radiated Emission)	15.247(d);15.205/15.209	ANSI C63.10-2020 Section 11.12	Clause 4.10	PASS



Unless otherwise agreed in writing, this document is issued by the Company subject to its General Conditions of Service printed overleaf, available on request or accessible at <http://www.sgs.com/en/Terms-and-Conditions.aspx> and, for electronic format documents, subject to Terms and Conditions for Electronic Documents at <http://www.sgs.com/en/Terms-and-Conditions/Terms-e-Documents.aspx>. Attention is drawn to the limitation of liability, indemnification and jurisdiction issues defined therein. Any holder of this document is advised that information contained hereon reflects the Company's findings at the time of its intervention only and within the limits of Client's instructions, if any. The Company's sole responsibility is to its Client and this document does not exonerate parties to a transaction from exercising all their rights and obligations under the transaction documents. This document cannot be reproduced except in full, without prior written approval of the Company. Any unauthorized alteration, forgery or falsification of the content or appearance of this document is unlawful and offenders may be prosecuted to the fullest extent of the law. Unless otherwise stated the results shown in this test report refer only to the sample(s) tested and such sample(s) are retained for 30 days only.

Attention: To check the authenticity of testing/inspection report & certificate, please contact us at telephone: (86-755) 8307 1443, or email: [CN.Doccheck@sgs.com](mailto:CN.Doccheck@sgs.com)

South of No. 6 Plant, No. 1, Runsheng Road, Suzhou Industrial Park, Suzhou Area, China (Jiangsu) Pilot Free Trade Zone 215000 t (86-512) 62992980 www.sgs.com.cn  
 中国·苏州·中国(江苏)自由贸易试验区苏州片区苏州工业园区润胜路1号的6号厂房南楼 邮编: 215000 t (86-512) 62992980 sgs.china@sgs.com

Report No.: SEWM2309000395RG05

Rev.: 01

Page: 4 of 131

Remark for report SEWM2309000395RG05 issue on 2023/10/27:

This test report (Report No.: SEWM2309000395RG05 issue on 2023/10/27) is based on the original test report (Report No.: SEWM2307000261RG05 issue on 2023/08/25) .

Review this report and original report, this report just changing the parts according to the declaration letter from client.

Considering to the difference, pre-scan were performed on the sample in this report to find the items which can be influential to the result in the original test report for fully retest.

Therefore in this report the items of Power, Transmitter emission Above 1GHz and Restricted bands around fundamental frequency were performed based on the worst case of the original report with report number SEWM2307000261RG05 issue on 2023/08/25 and other test data in this report are based on the previous report with report number SEWM2307000261RG05 issue on 2023/08/25, the FCC ID of the original test report is 2AFZZRA50G.



Unless otherwise agreed in writing, this document is issued by the Company subject to its General Conditions of Service printed overleaf, available on request or accessible at <http://www.sgs.com/en/Terms-and-Conditions.aspx> and, for electronic format documents, subject to Terms and Conditions for Electronic Documents at <http://www.sgs.com/en/Terms-and-Conditions/Terms-e-Documents.aspx>. Attention is drawn to the limitation of liability, indemnification and jurisdiction issues defined therein. Any holder of this document is advised that information contained hereon reflects the Company's findings at the time of its intervention only and within the limits of Client's instructions, if any. The Company's sole responsibility is to its Client and this document does not exonerate parties to a transaction from exercising all their rights and obligations under the transaction documents. This document cannot be reproduced except in full, without prior written approval of the Company. Any unauthorized alteration, forgery or falsification of the content or appearance of this document is unlawful and offenders may be prosecuted to the fullest extent of the law. Unless otherwise stated the results shown in this test report refer only to the sample(s) tested and such sample(s) are retained for 30 days only.  
**Attention: To check the authenticity of testing/inspection report & certificate, please contact us at telephone: (86-755) 8307 1443, or email: [CN.Doccheck@sgs.com](mailto:CN.Doccheck@sgs.com)**

South of No. 6 Plant, No. 1, Runsheng Road, Suzhou Industrial Park, Suzhou Area, China (Jiangsu) Pilot Free Trade Zone 215000  
中国·苏州·中国(江苏)自由贸易试验区苏州片区苏州工业园区润胜路1号的6号厂房南楼 邮编: 215000

t (86-512) 62992980 www.sgs.com.cn  
t (86-512) 62992980 sgs.china@sgs.com

## Contents

1	Version .....	2
2	Test Summary .....	3
3	General Information .....	6
3.1	Details of Client .....	6
3.2	Test Location .....	6
3.3	Test Facility .....	6
3.4	General Description of EUT .....	7
3.5	Test Environment and Mode .....	9
3.6	Description of Support Units .....	9
3.7	Worst-case configuration and mode .....	9
4	Test results and Measurement Data .....	10
4.1	Antenna Requirement .....	10
4.2	AC Power Line Conducted Emissions .....	12
4.3	Duty Cycle .....	16
4.4	Conducted Output Power .....	17
4.5	DTS (6 dB) Bandwidth & 99% Occupied Bandwidth .....	18
4.6	Power Spectral Density .....	19
4.7	Band-edge for RF Conducted Emissions .....	20
4.8	RF Conducted Spurious Emissions .....	21
4.9	Radiated Spurious Emissions .....	22
4.10	Restricted bands around fundamental frequency .....	25
5	Measurement Uncertainty (95% confidence levels, k=2) .....	28
6	Equipment List .....	29
7	Photographs - Setup Photos .....	31



Unless otherwise agreed in writing, this document is issued by the Company subject to its General Conditions of Service printed overleaf, available on request or accessible at <http://www.sgs.com/en/Terms-and-Conditions.aspx> and, for electronic format documents, subject to Terms and Conditions for Electronic Documents at <http://www.sgs.com/en/Terms-and-Conditions/Terms-e-Document.aspx>. Attention is drawn to the limitation of liability, indemnification and jurisdiction issues defined therein. Any holder of this document is advised that information contained hereon reflects the Company's findings at the time of its intervention only and within the limits of Client's instructions, if any. The Company's sole responsibility is to its Client and this document does not exonerate parties to a transaction from exercising all their rights and obligations under the transaction documents. This document cannot be reproduced except in full, without prior written approval of the Company. Any unauthorized alteration, forgery or falsification of the content or appearance of this document is unlawful and offenders may be prosecuted to the fullest extent of the law. Unless otherwise stated the results shown in this test report refer only to the sample(s) tested and such sample(s) are retained for 30 days only.

Attention: To check the authenticity of testing/inspection report & certificate, please contact us at telephone: (86-755) 8307 1443, or email: [CN.Doccheck@sgs.com](mailto:CN.Doccheck@sgs.com)

South of No. 6 Plant, No. 1, Runsheng Road, Suzhou Industrial Park, Suzhou Area, China (Jiangsu) Pilot Free Trade Zone 215000  
 中国·苏州·中国(江苏)自由贸易试验区苏州片区苏州工业园区润胜路1号的6号厂房南楼 邮编: 215000

t (86-512) 62992980 www.sgs.com.cn  
 t (86-512) 62992980 sgs.china@sgs.com

### 3 General Information

#### 3.1 Details of Client

Applicant:	Xiaomi Communications Co., Ltd.
Address of Applicant:	#019, 9th Floor, Building 6, 33 Xi'erqi Middle Road, Haidian District, Beijing, China, 100085
Manufacturer:	Xiaomi Communications Co., Ltd.
Address of Manufacturer:	#019, 9th Floor, Building 6, 33 Xi'erqi Middle Road, Haidian District, Beijing, China, 100085

#### 3.2 Test Location

Company:	SGS-CSTC Standards Technical Services (Suzhou) Co., Ltd.
Address:	South of No. 6 Plant, No. 1, Runsheng Road, Suzhou Industrial Park, Suzhou Area, China (Jiangsu) Pilot Free Trade Zone
Post code:	215000
Test engineer:	Ives Cheng, Tizzy Song

#### 3.3 Test Facility

The test facility is recognized, certified, or accredited by the following organizations:

- **A2LA (Certificate No. 6336.01)**

SGS-CSTC STANDARDS TECHNICAL SERVICES (SUZHOU) CO., LTD. is accredited by the American Association for Laboratory Accreditation(A2LA). Certificate No. 6336.01.

- **Innovation, Science and Economic Development Canada**

SGS-CSTC STANDARDS TECHNICAL SERVICES (SUZHOU) CO., LTD. has been recognized by ISED as an accredited testing laboratory.

CAB identifier: CN0120.

IC#: 27594.

- **FCC –Designation Number: CN1312**

SGS-CSTC STANDARDS TECHNICAL SERVICES (SUZHOU) CO., LTD. has been recognized as an accredited testing laboratory.

Designation Number: CN1312.

Test Firm Registration Number: 717327



Unless otherwise agreed in writing, this document is issued by the Company subject to its General Conditions of Service printed overleaf, available on request or accessible at <http://www.sgs.com/en/Terms-and-Conditions.aspx> and, for electronic format documents, subject to Terms and Conditions for Electronic Documents at <http://www.sgs.com/en/Terms-and-Conditions/Terms-e-Documents.aspx>. Attention is drawn to the limitation of liability, indemnification and jurisdiction issues defined therein. Any holder of this document is advised that information contained hereon reflects the Company's findings at the time of its intervention only and within the limits of Client's instructions, if any. The Company's sole responsibility is to its Client and this document does not exonerate parties to a transaction from exercising all their rights and obligations under the transaction documents. This document cannot be reproduced except in full, without prior written approval of the Company. Any unauthorized alteration, forgery or falsification of the content or appearance of this document is unlawful and offenders may be prosecuted to the fullest extent of the law. Unless otherwise stated the results shown in this test report refer only to the sample(s) tested and such sample(s) are retained for 30 days only.  
**Attention: To check the authenticity of testing/inspection report & certificate, please contact us at telephone: (86-755) 8307 1443, or email: CN.Doccheck@sgs.com**

South of No. 6 Plant, No. 1, Runsheng Road, Suzhou Industrial Park, Suzhou Area, China (Jiangsu) Pilot Free Trade Zone 215000  
 中国·苏州·中国(江苏)自由贸易试验区苏州片区苏州工业园区润胜路1号的6号厂房南座 邮编: 215000

t (86-512) 62992980 www.sgs.com.cn  
 t (86-512) 62992980 sgs.china@sgs.com

### 3.4 General Description of EUT

EUT Description:	Mobile Phone	
Model No.:	23122PCD1G	
Trade Mark:	POCO	
Hardware Version:	13510N16	
Software Version:	MIUI 14	
Power Supply:	Lithium Battery (3.91V)	
IMEI:	RF Conducted	IMEI1: 867837060041800 IMEI2: 867837060041818
	RSE & AC power line	IMEI1: 867837060041388 IMEI2: 867837060041396
Operation Frequency:	802.11b/g/n(HT20):	2412MHz to 2462MHz
	802.11n(HT40):	2422MHz to 2452MHz
Modulation Type:	802.11b:	DSSS (DBPSK, DQPSK, CCK)
	802.11g/n:	OFDM (BPSK, QPSK, 16QAM, 64QAM)
Number of Channels:	802.11b/g/n(HT20): 11 802.11n(HT40): 7	
Channel Spacing:	5MHz	
Smart System:	<input checked="" type="checkbox"/> SISO	802.11b/g/n
	<input checked="" type="checkbox"/> MIMO	802.11n: 2Tx & 2Rx
	<input checked="" type="checkbox"/> Diversity	802.11b/g: 2Tx & 2Rx
Antenna Type:	IFA Antenna	
Antenna Gain:	-3.1dBi (Ant10); 1.53dBi (Ant8)	
	Note: The antenna gain are derived from the gain information report provided by the manufacturer.	
RF Cable:	1.0dB	
Remark:	As above information is provided and confirmed by the applicant. SGS is not liable to the accuracy, suitability, reliability or/and integrity of the information.	



Unless otherwise agreed in writing, this document is issued by the Company subject to its General Conditions of Service printed overleaf, available on request or accessible at <http://www.sgs.com/en/Terms-and-Conditions.aspx> and, for electronic format documents, subject to Terms and Conditions for Electronic Documents at <http://www.sgs.com/en/Terms-and-Conditions/Terms-e-Document.aspx>. Attention is drawn to the limitation of liability, indemnification and jurisdiction issues defined therein. Any holder of this document is advised that information contained hereon reflects the Company's findings at the time of its intervention only and within the limits of Client's instructions, if any. The Company's sole responsibility is to its Client and this document does not exonerate parties to a transaction from exercising all their rights and obligations under the transaction documents. This document cannot be reproduced except in full, without prior written approval of the Company. Any unauthorized alteration, forgery or falsification of the content or appearance of this document is unlawful and offenders may be prosecuted to the fullest extent of the law. Unless otherwise stated the results shown in this test report refer only to the sample(s) tested and such sample(s) are retained for 30 days only.

Attention: To check the authenticity of testing/inspection report & certificate, please contact us at telephone: (86-755) 8307 1443, or email: [CN.Doccheck@sgs.com](mailto:CN.Doccheck@sgs.com)

South of No. 6 Plant, No. 1, Runsheng Road, Suzhou Industrial Park, Suzhou Area, China (Jiangsu) Pilot Free Trade Zone 215000  
中国·苏州·中国(江苏)自由贸易试验区苏州片区苏州工业园区润胜路1号的6号厂房南楼 邮编: 215000

t (86-512) 62992980 www.sgs.com.cn  
t (86-512) 62992980 sgs.china@sgs.com

Operation Frequency of each channel (802.11b/g/n HT20)							
Channel	Frequency	Channel	Frequency	Channel	Frequency	Channel	Frequency
1	2412MHz	4	2427MHz	7	2442MHz	10	2457MHz
2	2417MHz	5	2432MHz	8	2447MHz	11	2462MHz
3	2422MHz	6	2437MHz	9	2452MHz		
Operation Frequency of each channel (802.11n HT40)							
Channel	Frequency	Channel	Frequency	Channel	Frequency	Channel	Frequency
3	2422MHz	6	2437MHz	9	2452MHz		
4	2427MHz	7	2442MHz				
5	2432MHz	8	2447MHz				
Remark: In section 15.31(m), regards to the operating frequency range over 10 MHz, the Lowest frequency, the middle frequency, and the highest frequency of channel were selected to perform the test, and the selected channel see below:							
Channel		Frequency for 802.11 b/g/n (HT20)		Frequency for 802.11n (HT40)			
The Lowest channel		2412MHz		2422MHz			
The Middle channel		2437MHz		2437MHz			
The Highest channel		2462MHz		2452MHz			



Unless otherwise agreed in writing, this document is issued by the Company subject to its General Conditions of Service printed overleaf, available on request or accessible at <http://www.sgs.com/en/Terms-and-Conditions.aspx> and, for electronic format documents, subject to Terms and Conditions for Electronic Documents at <http://www.sgs.com/en/Terms-and-Conditions/Terms-e-Documents.aspx>. Attention is drawn to the limitation of liability, indemnification and jurisdiction issues defined therein. Any holder of this document is advised that information contained hereon reflects the Company's findings at the time of its intervention only and within the limits of Client's instructions, if any. The Company's sole responsibility is to its Client and this document does not exonerate parties to a transaction from exercising all their rights and obligations under the transaction documents. This document cannot be reproduced except in full, without prior written approval of the Company. Any unauthorized alteration, forgery or falsification of the content or appearance of this document is unlawful and offenders may be prosecuted to the fullest extent of the law. Unless otherwise stated the results shown in this test report refer only to the sample(s) tested and such sample(s) are retained for 30 days only.

Attention: To check the authenticity of testing/inspection report & certificate, please contact us at telephone: (86-755) 8307 1443, or email: [CN.Doccheck@sgs.com](mailto:CN.Doccheck@sgs.com)

South of No. 6 Plant, No. 1, Runsheng Road, Suzhou Industrial Park, Suzhou Area, China (Jiangsu) Pilot Free Trade Zone 215000 t (86-512) 62992980 www.sgs.com.cn  
 中国·苏州·中国(江苏)自由贸易试验区苏州片区工业园区润胜路1号的6号厂房南楼 邮编: 215000 t (86-512) 62992980 sgs.china@sgs.com



### 3.5 Test Environment and Mode

Environment Parameter	101.0 kPa Selected Values During Tests	
Relative Humidity	44-46 % RH Ambient	
Value	Temperature(°C)	Voltage(Vdc)
NTNV	22~23	3.91
Remark: NV: Normal Voltage NT: Normal Temperature		

### 3.6 Description of Support Units

The EUT has been tested as an independent unit.

### 3.7 Worst-case configuration and mode

Low data rate was used to test on antenna port conducted tests and radiated spurious emissions since it has the highest maximum power. Following are the worst-case data rates set for test:

Modulation Type	SISO - Data Rate	CDD/MIMO - Data Rate
802.11b	1 Mbps	2 Mbps
802.11g	6 Mbps	12 Mbps
802.11n (HT 20)	MCS0 (6.5 Mbps)	MCS0 (13 Mbps)
802.11n (HT 40)	MCS0 (13.5 Mbps)	MCS0 (27 Mbps)



Unless otherwise agreed in writing, this document is issued by the Company subject to its General Conditions of Service printed overleaf, available on request or accessible at <http://www.sgs.com/en/Terms-and-Conditions.aspx> and, for electronic format documents, subject to Terms and Conditions for Electronic Documents at <http://www.sgs.com/en/Terms-and-Conditions/Terms-e-Document.aspx>. Attention is drawn to the limitation of liability, indemnification and jurisdiction issues defined therein. Any holder of this document is advised that information contained hereon reflects the Company's findings at the time of its intervention only and within the limits of Client's instructions, if any. The Company's sole responsibility is to its Client and this document does not exonerate parties to a transaction from exercising all their rights and obligations under the transaction documents. This document cannot be reproduced except in full, without prior written approval of the Company. Any unauthorized alteration, forgery or falsification of the content or appearance of this document is unlawful and offenders may be prosecuted to the fullest extent of the law. Unless otherwise stated the results shown in this test report refer only to the sample(s) tested and such sample(s) are retained for 30 days only.

Attention: To check the authenticity of testing/inspection report & certificate, please contact us at telephone: (86-755) 8307 1443, or email: [CN.Doccheck@sgs.com](mailto:CN.Doccheck@sgs.com)

South of No. 6 Plant, No. 1, Runsheng Road, Suzhou Industrial Park, Suzhou Area, China (Jiangsu) Pilot Free Trade Zone 215000  
 中国·苏州·中国(江苏)自由贸易试验区苏州片区苏州工业园区润胜路1号的6号厂房南楼 邮编: 215000

t (86-512) 62992980 www.sgs.com.cn  
 t (86-512) 62992980 sgs.china@sgs.com

## 4 Test results and Measurement Data

### 4.1 Antenna Requirement

<b>Standard requirement:</b>	47 CFR Part 15C Section 15.203 /247(b)
<p>15.203 requirement:                  An intentional radiator shall be designed to ensure that no antenna other than that furnished by the responsible party shall be used with the device. The use of a permanently attached antenna or of an antenna that uses a unique coupling to the intentional radiator, the manufacturer may design the unit so that a broken antenna can be replaced by the user, but the use of a standard antenna jack or electrical connector is prohibited.</p> <p>15.247(b) (4) requirement:                  The conducted output power limit specified in paragraph (b) of this section is based on the use of antennas with directional gains that do not exceed 6 dBi. Except as shown in paragraph (c) of this section, if transmitting antennas of directional gain greater than 6 dBi are used, the conducted output power from the intentional radiator shall be reduced below the stated values in paragraphs (b)(1), (b)(2), and (b)(3) of this section, as appropriate, by the amount in dB that the directional gain of the antenna exceeds 6 dBi.</p>	
<p>The antenna is IFA Antenna and no consideration of replacement.                  The best case gain of the antenna is -3.1dBi (Ant10); 1.53dBi (Ant8)*</p> <p><i>*Note:                  The antenna gain are derived from the gain information report provided by the manufacturer.</i></p> <p><i>Remark:                  As above information is provided and confirmed by the applicant. SGS is not liable to the accuracy, suitability, reliability or/and integrity of the information.</i></p>	



Unless otherwise agreed in writing, this document is issued by the Company subject to its General Conditions of Service printed overleaf, available on request or accessible at <http://www.sgs.com/en/Terms-and-Conditions.aspx> and, for electronic format documents, subject to Terms and Conditions for Electronic Documents at <http://www.sgs.com/en/Terms-and-Conditions/Terms-e-Documents.aspx>. Attention is drawn to the limitation of liability, indemnification and jurisdiction issues defined therein. Any holder of this document is advised that information contained hereon reflects the Company's findings at the time of its intervention only and within the limits of Client's instructions, if any. The Company's sole responsibility is to its Client and this document does not exonerate parties to a transaction from exercising all their rights and obligations under the transaction documents. This document cannot be reproduced except in full, without prior written approval of the Company. Any unauthorized alteration, forgery or falsification of the content or appearance of this document is unlawful and offenders may be prosecuted to the fullest extent of the law. Unless otherwise stated the results shown in this test report refer only to the sample(s) tested and such sample(s) are retained for 30 days only.

**Attention:** To check the authenticity of testing/inspection report & certificate, please contact us at telephone: (86-755) 8307 1443, or email: [CN.Doccheck@sgs.com](mailto:CN.Doccheck@sgs.com)

South of No. 6 Plant, No. 1, Runsheng Road, Suzhou Industrial Park, Suzhou Area, China (Jiangsu) Pilot Free Trade Zone 215000 t (86-512) 62992980 www.sgsgroup.com.cn  
 中国·苏州·中国(江苏)自由贸易试验区苏州片区苏州工业园区润胜路1号的6号厂房南楼 邮编: 215000 t (86-512) 62992980 sgs.china@sgs.com

**Cyclic Delay Diversity (CDD) System:**

FCC KDB 662911 D01 Multiple Transmitter Output v02r01

If all antennas have the same gain,  $G_{ANT}$ , Directional gain =  $G_{ANT}$  + Array Gain, where Array Gain is as follows.

- For power spectral density (PSD) measurements on all devices,  
 $Array\ Gain = 10 \log(N_{ANT}/N_{SS} = 1) \text{ dB}$ .

- For power measurements on IEEE 802.11 devices:  
 $Array\ Gain = 0 \text{ dB}$  (i.e., no array gain) for  $N_{ANT} \leq 4$ ;

For power, the directional gain may be calculated by using the formulas applicable to equal gain antennas with  $G_{ANT}$  set equal to the gain of the antenna having the highest gain.

For PSD, the directional gain calculation is following F)2)f)ii) of KDB 662911 D01 v02r01.

**The Power and PSD limit should be modified if the directional gain of eut is over 6dbi.**

The EUT supports CDD System.

Unequal antenna gain:

ANT Gain10 (dBi)	ANT Gain8 (dBi)	Power DG (dBi)	PSD DG (dBi)	Power Limit Reduction(dB)	PSD Limit Reduction(dB)
-3.1	1.53	1.53	2.53	0	0

Power Limit Reduction = Directional gain – 6dBi, (Directional gain < 6dBi ) =0

PSD Limit Reduction = Directional gain – 6dBi, (Directional gain < 6dBi ) =0



Unless otherwise agreed in writing, this document is issued by the Company subject to its General Conditions of Service printed overleaf, available on request or accessible at <http://www.sgs.com/en/Terms-and-Conditions.aspx> and, for electronic format documents, subject to Terms and Conditions for Electronic Documents at <http://www.sgs.com/en/Terms-and-Conditions/Terms-e-Documents.aspx>. Attention is drawn to the limitation of liability, indemnification and jurisdiction issues defined therein. Any holder of this document is advised that information contained hereon reflects the Company's findings at the time of its intervention only and within the limits of Client's instructions, if any. The Company's sole responsibility is to its Client and this document does not exonerate parties to a transaction from exercising all their rights and obligations under the transaction documents. This document cannot be reproduced except in full, without prior written approval of the Company. Any unauthorized alteration, forgery or falsification of the content or appearance of this document is unlawful and offenders may be prosecuted to the fullest extent of the law. Unless otherwise stated the results shown in this test report refer only to the sample(s) tested and such sample(s) are retained for 30 days only.  
**Attention: To check the authenticity of testing/inspection report & certificate, please contact us at telephone: (86-755) 8307 1443, or email: CN.Doccheck@sgs.com**

South of No. 6 Plant, No. 1, Runsheng Road, Suzhou Industrial Park, Suzhou Area, China (Jiangsu) Pilot Free Trade Zone 215000 t (86-512) 62992980 www.sgs.com.cn  
 中国·苏州·中国(江苏)自由贸易试验区苏州片区苏州工业园区润胜路1号的6号厂房南楼 邮编: 215000 t (86-512) 62992980 sgs.china@sgs.com

### 4.2 AC Power Line Conducted Emissions

Test Requirement:	47 CFR Part 15C Section 15.207		
Test Method:	ANSI C63.10-2020 Section 6.2		
Test Frequency Range:	150kHz to 30MHz		
Receiver Setup:	RBW = 9kHz, VBW = 30kHz		
Limit:	Frequency range (MHz)	Limit (dBuV)	
		Quasi-peak	Average
	0.15-0.5	66 to 56*	56 to 46*
	0.5-5	56	46
	5-30	60	50
* Decreases with the logarithm of the frequency.			
Test Procedure:	<p>1) The mains terminal disturbance voltage test was conducted in a shielded room.</p> <p>2) The EUT was connected to AC power source through a LISN 1 (Line Impedance Stabilization Network) which provides a 50Ω/50μH + 5Ω linear impedance. The power cables of all other units of the EUT were connected to a second LISN 2, which was bonded to the ground reference plane in the same way as the LISN 1 for the unit being measured. A multiple socket outlet strip was used to connect multiple power cables to a single LISN provided the rating of the LISN was not exceeded.</p> <p>3) The tabletop EUT was placed upon a non-metallic table 0.8m above the ground reference plane. And for floor-standing arrangement, the EUT was placed on the horizontal ground reference plane,</p> <p>4) The test was performed with a vertical ground reference plane. The rear of the EUT shall be 0.4 m from the vertical ground reference plane. The vertical ground reference plane was bonded to the horizontal ground reference plane. The LISN 1 was placed 0.8 m from the boundary of the unit under test and bonded to a ground reference plane for LISNs mounted on top of the ground reference plane. This distance was between the closest points of the LISN 1 and the EUT. All other units of the EUT and associated equipment was at least 0.8 m from the LISN 2. In order to find the maximum emission, the relative positions of equipment and all of the interface cables must be changed according to ANSI C63.10-2020 on conducted measurement.</p>		



Unless otherwise agreed in writing, this document is issued by the Company subject to its General Conditions of Service printed overleaf, available on request or accessible at <http://www.sgs.com/en/Terms-and-Conditions.aspx> and, for electronic format documents, subject to Terms and Conditions for Electronic Documents at <http://www.sgs.com/en/Terms-and-Conditions/Terms-e-Documents.aspx>. Attention is drawn to the limitation of liability, indemnification and jurisdiction issues defined therein. Any holder of this document is advised that information contained hereon reflects the Company's findings at the time of its intervention only and within the limits of Client's instructions, if any. The Company's sole responsibility is to its Client and this document does not exonerate parties to a transaction from exercising all their rights and obligations under the transaction documents. This document cannot be reproduced except in full, without prior written approval of the Company. Any unauthorized alteration, forgery or falsification of the content or appearance of this document is unlawful and offenders may be prosecuted to the fullest extent of the law. Unless otherwise stated the results shown in this test report refer only to the sample(s) tested and such sample(s) are retained for 30 days only.

Attention: To check the authenticity of testing/inspection report & certificate, please contact us at telephone: (86-755) 8307 1443, or email: [CN.Doccheck@sgs.com](mailto:CN.Doccheck@sgs.com)

South of No. 6 Plant, No. 1, Runsheng Road, Suzhou Industrial Park, Suzhou Area, China (Jiangsu) Pilot Free Trade Zone 215000  
 中国·苏州·中国(江苏)自由贸易试验区苏州片区苏州工业园区润胜路1号的6号厂房南楼 邮编: 215000

t (86-512) 62992980 www.sgs.com.cn  
 t (86-512) 62992980 sgs.china@sgs.com

<p>Test Setup:</p>	
<p>Exploratory Test Mode:</p>	<p>Transmitting with all kind of modulations, data rates at lowest, middle and highest channel. Charge + Transmitting mode.</p>
<p>Final Test Mode:</p>	<p>Refer to section 3.7 for details. Only the worst case is recorded in the report.</p>
<p>Instruments Used:</p>	<p>Refer to section 6 for details.</p>
<p>Test Results:</p>	<p>Pass</p>



Unless otherwise agreed in writing, this document is issued by the Company subject to its General Conditions of Service printed overleaf, available on request or accessible at <http://www.sgs.com/en/Terms-and-Conditions.aspx> and, for electronic format documents, subject to Terms and Conditions for Electronic Documents at <http://www.sgs.com/en/Terms-and-Conditions/Terms-e-Document.aspx>. Attention is drawn to the limitation of liability, indemnification and jurisdiction issues defined therein. Any holder of this document is advised that information contained hereon reflects the Company's findings at the time of its intervention only and within the limits of Client's instructions, if any. The Company's sole responsibility is to its Client and this document does not exonerate parties to a transaction from exercising all their rights and obligations under the transaction documents. This document cannot be reproduced except in full, without prior written approval of the Company. Any unauthorized alteration, forgery or falsification of the content or appearance of this document is unlawful and offenders may be prosecuted to the fullest extent of the law. Unless otherwise stated the results shown in this test report refer only to the sample(s) tested and such sample(s) are retained for 30 days only.  
Attention: To check the authenticity of testing/inspection report & certificate, please contact us at telephone: (86-755) 8307 1443, or email: [CN.Doccheck@sgs.com](mailto:CN.Doccheck@sgs.com)

South of No. 6 Plant, No. 1, Runsheng Road, Suzhou Industrial Park, Suzhou Area, China (Jiangsu) Pilot Free Trade Zone 215000 t (86-512) 62992980 www.sgs.com.cn  
中国·苏州·中国(江苏)自由贸易试验区苏州片区苏州工业园区润胜路1号的6号厂房南楼 邮编: 215000 t (86-512) 62992980 sgs.china@sgs.com

Measurement Data

An initial pre-scan was performed on the live and neutral lines with peak detector. Quasi-Peak and Average measurement were performed at the frequencies with maximized peak emission were detected.

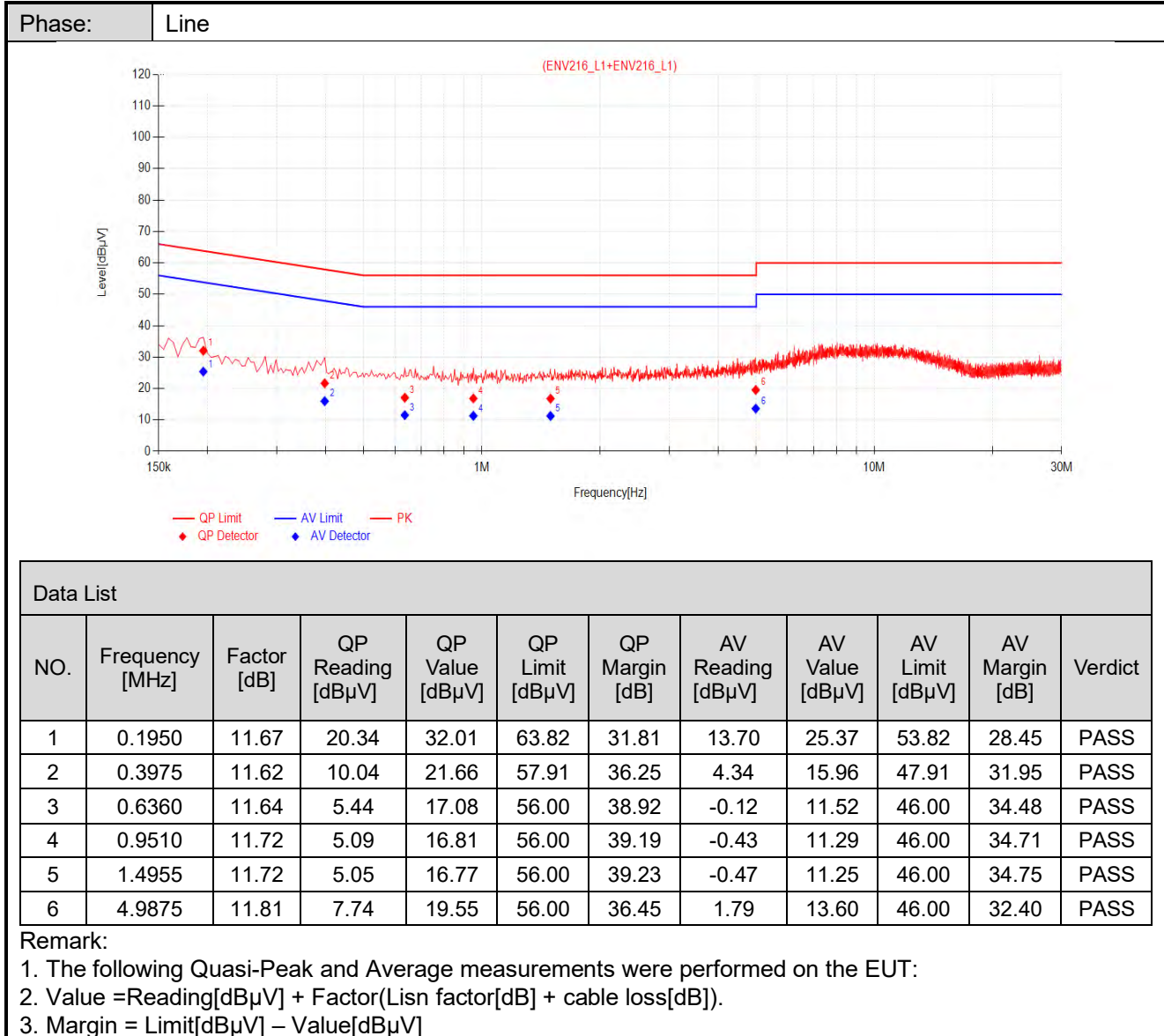

Phase: Neutral

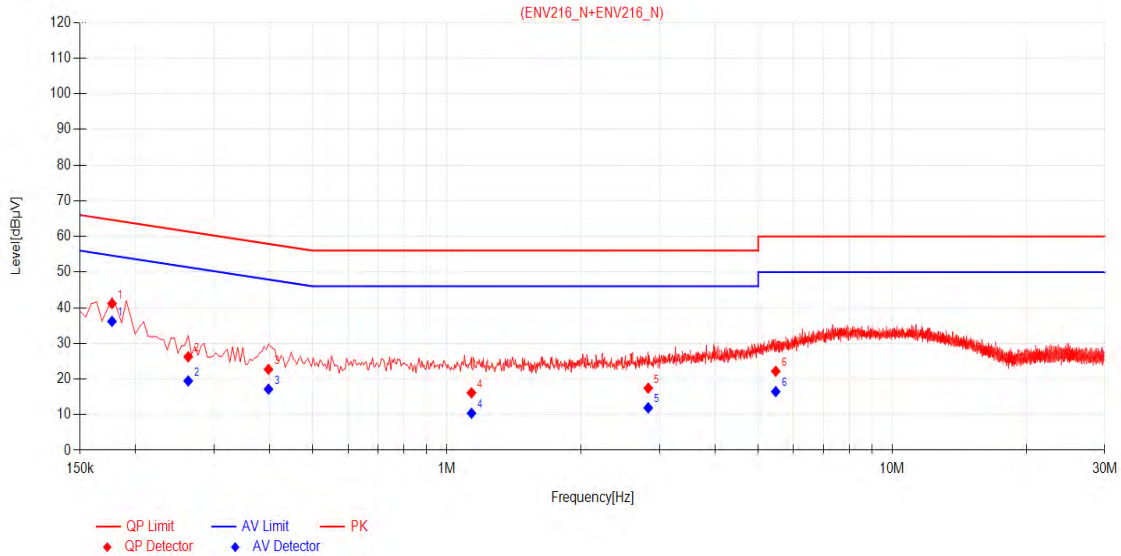

Data List											
NO.	Frequency [MHz]	Factor [dB]	QP Reading [dBµV]	QP Value [dBµV]	QP Limit [dBµV]	QP Margin [dB]	AV Reading [dBµV]	AV Value [dBµV]	AV Limit [dBµV]	AV Margin [dB]	Verdict
1	0.1770	11.73	29.43	41.16	64.63	23.47	24.42	36.15	54.63	18.48	PASS
2	0.2625	11.63	14.61	26.24	61.35	35.11	7.83	19.46	51.35	31.89	PASS
3	0.3975	11.62	11.08	22.70	57.91	35.21	5.53	17.15	47.91	30.76	PASS
4	1.1355	11.72	4.42	16.14	56.00	39.86	-1.33	10.39	46.00	35.61	PASS
5	2.8320	11.74	5.71	17.45	56.00	38.55	0.17	11.91	46.00	34.09	PASS
6	5.4735	11.84	10.34	22.18	60.00	37.82	4.63	16.47	50.00	33.53	PASS

Remark:

- The following Quasi-Peak and Average measurements were performed on the EUT:
- Value = Reading[dBµV] + Factor(Lisn factor[dB] + cable loss[dB]).
- Margin = Limit[dBµV] – Value[dBµV]



Unless otherwise agreed in writing, this document is issued by the Company subject to its General Conditions of Service printed overleaf, available on request or accessible at <http://www.sgs.com/en/Terms-and-Conditions.aspx> and, for electronic format documents, subject to Terms and Conditions for Electronic Documents at <http://www.sgs.com/en/Terms-and-Conditions/Terms-e-Documents.aspx>. Attention is drawn to the limitation of liability, indemnification and jurisdiction issues defined therein. Any holder of this document is advised that information contained hereon reflects the Company's findings at the time of its intervention only and within the limits of Client's instructions, if any. The Company's sole responsibility is to its Client and this document does not exonerate parties to a transaction from exercising all their rights and obligations under the transaction documents. This document cannot be reproduced except in full, without prior written approval of the Company. Any unauthorized alteration, forgery or falsification of the content or appearance of this document is unlawful and offenders may be prosecuted to the fullest extent of the law. Unless otherwise stated the results shown in this test report refer only to the sample(s) tested and such sample(s) are retained for 30 days only.

Attention: To check the authenticity of testing/inspection report & certificate, please contact us at telephone: (86-755) 8307 1443, or email: [CN.Doccheck@sgs.com](mailto:CN.Doccheck@sgs.com)  
 South of No. 6 Plant, No. 1, Runsheng Road, Suzhou Industrial Park, Suzhou Area, China (Jiangsu) Pilot Free Trade Zone 215000 t (86-512) 62992980 www.sgs.com.cn  
 中国·苏州·中国(江苏)自由贸易试验区苏州片区苏州工业园区润胜路1号的6号厂房南楼 邮编: 215000 t (86-512) 62992980 sgs.china@sgs.com

### 4.3 Duty Cycle

Test Requirement:	ANSI C63.10-2020 Section 11.6
Test Method:	ANSI C63.10-2020 Section 11.6
Test Setup:	
Instruments Used:	Refer to section 6 for details
Exploratory Test Mode:	Transmitting with all kind of modulations, data rates
Final Test Mode:	Refer to section 3.7 for details.
Limit:	No restriction limits
Test Results:	For Report Purpose
The detailed test data see: <b>Appendix</b>	



Unless otherwise agreed in writing, this document is issued by the Company subject to its General Conditions of Service printed overleaf, available on request or accessible at <http://www.sgs.com/en/Terms-and-Conditions.aspx> and, for electronic format documents, subject to Terms and Conditions for Electronic Documents at <http://www.sgs.com/en/Terms-and-Conditions/Terms-e-Document.aspx>. Attention is drawn to the limitation of liability, indemnification and jurisdiction issues defined therein. Any holder of this document is advised that information contained hereon reflects the Company's findings at the time of its intervention only and within the limits of Client's instructions, if any. The Company's sole responsibility is to its Client and this document does not exonerate parties to a transaction from exercising all their rights and obligations under the transaction documents. This document cannot be reproduced except in full, without prior written approval of the Company. Any unauthorized alteration, forgery or falsification of the content or appearance of this document is unlawful and offenders may be prosecuted to the fullest extent of the law. Unless otherwise stated the results shown in this test report refer only to the sample(s) tested and such sample(s) are retained for 30 days only.

Attention: To check the authenticity of testing/inspection report & certificate, please contact us at telephone: (86-755) 8307 1443, or email: [CN.Doccheck@sgs.com](mailto:CN.Doccheck@sgs.com)

South of No. 6 Plant, No. 1, Runsheng Road, Suzhou Industrial Park, Suzhou Area, China (Jiangsu) Pilot Free Trade Zone 215000 t (86-512) 62992980 www.sgs.com.cn  
 中国·苏州·中国(江苏)自由贸易试验区苏州片区苏州工业园区润胜路1号的6号厂房南楼 邮编: 215000 t (86-512) 62992980 sgs.china@sgs.com

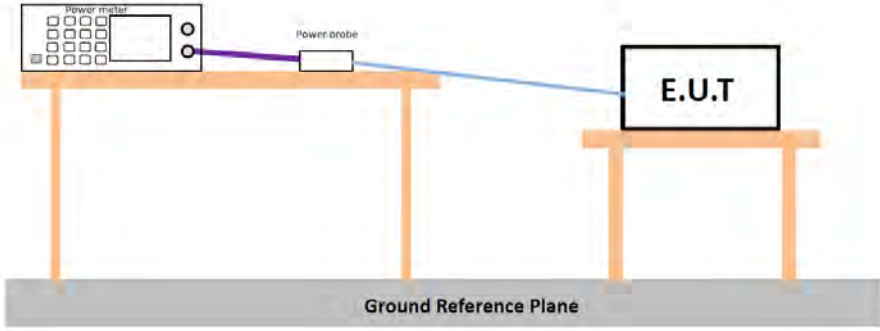

### 4.4 Conducted Output Power

Test Requirement:	47 CFR Part 15C Section 15.247 (b)(3)
Test Method:	ANSI C63.10-2020 Section 11.9.1.2
Test Setup:	 <p>* Test with power meter (Detector function: Peak)</p>
Test Instruments:	Refer to section 6 for details.
Exploratory Test Mode:	Transmitting with all kind of modulations, data rates
Final Test Mode:	Refer to section 3.7 for details.
Limit:	30dBm
Test Results:	Pass
The detailed test data see: <b>Appendix</b>	



Unless otherwise agreed in writing, this document is issued by the Company subject to its General Conditions of Service printed overleaf, available on request or accessible at <http://www.sgs.com/en/Terms-and-Conditions.aspx> and, for electronic format documents, subject to Terms and Conditions for Electronic Documents at <http://www.sgs.com/en/Terms-and-Conditions/Terms-e-Documents.aspx>. Attention is drawn to the limitation of liability, indemnification and jurisdiction issues defined therein. Any holder of this document is advised that information contained hereon reflects the Company's findings at the time of its intervention only and within the limits of Client's instructions, if any. The Company's sole responsibility is to its Client and this document does not exonerate parties to a transaction from exercising all their rights and obligations under the transaction documents. This document cannot be reproduced except in full, without prior written approval of the Company. Any unauthorized alteration, forgery or falsification of the content or appearance of this document is unlawful and offenders may be prosecuted to the fullest extent of the law. Unless otherwise stated the results shown in this test report refer only to the sample(s) tested and such sample(s) are retained for 30 days only.

Attention: To check the authenticity of testing/inspection report & certificate, please contact us at telephone: (86-755) 8307 1443, or email: [CN.Doccheck@sgs.com](mailto:CN.Doccheck@sgs.com)

South of No. 6 Plant, No. 1, Runsheng Road, Suzhou Industrial Park, Suzhou Area, China (Jiangsu) Pilot Free Trade Zone 215000 t (86-512) 62992980 www.sgs.com.cn  
 中国·苏州·中国(江苏)自由贸易试验区苏州片区苏州工业园区润胜路1号的6号厂房南楼 邮编: 215000 t (86-512) 62992980 sgs.china@sgs.com

### 4.5 DTS (6 dB) Bandwidth & 99% Occupied Bandwidth

Test Requirement:	47 CFR Part 15C Section 15.247 (a)(2)
Test Method:	ANSI C63.10-2020 Section 11.8 Option 2 / 6.9.3
Test Setup:	
Instruments Used:	Refer to section 6 for details.
Exploratory Test Mode:	Transmitting with all kind of modulations, data rates
Final Test Mode:	Refer to section 3.7 for details.
Limit:	≥ 500 kHz for DTS Bandwidth
Test Results:	Pass
The detailed test data see: <b>Appendix</b>	



Unless otherwise agreed in writing, this document is issued by the Company subject to its General Conditions of Service printed overleaf, available on request or accessible at <http://www.sgs.com/en/Terms-and-Conditions.aspx> and, for electronic format documents, subject to Terms and Conditions for Electronic Documents at <http://www.sgs.com/en/Terms-and-Conditions/Terms-e-Document.aspx>. Attention is drawn to the limitation of liability, indemnification and jurisdiction issues defined therein. Any holder of this document is advised that information contained hereon reflects the Company's findings at the time of its intervention only and within the limits of Client's instructions, if any. The Company's sole responsibility is to its Client and this document does not exonerate parties to a transaction from exercising all their rights and obligations under the transaction documents. This document cannot be reproduced except in full, without prior written approval of the Company. Any unauthorized alteration, forgery or falsification of the content or appearance of this document is unlawful and offenders may be prosecuted to the fullest extent of the law. Unless otherwise stated the results shown in this test report refer only to the sample(s) tested and such sample(s) are retained for 30 days only.

Attention: To check the authenticity of testing/inspection report & certificate, please contact us at telephone: (86-755) 8307 1443, or email: [CN\\_Doccheck@sgs.com](mailto:CN_Doccheck@sgs.com)

South of No. 6 Plant, No. 1, Runsheng Road, Suzhou Industrial Park, Suzhou Area, China (Jiangsu) Pilot Free Trade Zone 215000 t (86-512) 62992980 www.sgs.com.cn  
 中国·苏州·中国(江苏)自由贸易试验区苏州片区苏州工业园区润胜路1号的6号厂房南楼 邮编: 215000 t (86-512) 62992980 sgs.china@sgs.com

### 4.6 Power Spectral Density

Test Requirement:	47 CFR Part 15C Section 15.247 (e)
Test Method:	ANSI C63.10-2020 Section 11.10.2
Test Setup:	
Test Instruments:	Refer to section 6 for details.
Exploratory Test Mode:	Transmitting with all kind of modulations, data rates
Final Test Mode:	Refer to section 3.7 for details.
Limit:	≤8.00dBm/3kHz
Test Results:	Pass
The detailed test data see: <b>Appendix</b>	



Unless otherwise agreed in writing, this document is issued by the Company subject to its General Conditions of Service printed overleaf, available on request or accessible at <http://www.sgs.com/en/Terms-and-Conditions.aspx> and, for electronic format documents, subject to Terms and Conditions for Electronic Documents at <http://www.sgs.com/en/Terms-and-Conditions/Terms-e-Document.aspx>. Attention is drawn to the limitation of liability, indemnification and jurisdiction issues defined therein. Any holder of this document is advised that information contained hereon reflects the Company's findings at the time of its intervention only and within the limits of Client's instructions, if any. The Company's sole responsibility is to its Client and this document does not exonerate parties to a transaction from exercising all their rights and obligations under the transaction documents. This document cannot be reproduced except in full, without prior written approval of the Company. Any unauthorized alteration, forgery or falsification of the content or appearance of this document is unlawful and offenders may be prosecuted to the fullest extent of the law. Unless otherwise stated the results shown in this test report refer only to the sample(s) tested and such sample(s) are retained for 30 days only.

Attention: To check the authenticity of testing/inspection report & certificate, please contact us at telephone: (86-755) 8307 1443, or email: [CN.Doccheck@sgs.com](mailto:CN.Doccheck@sgs.com)

South of No. 6 Plant, No. 1, Runsheng Road, Suzhou Industrial Park, Suzhou Area, China (Jiangsu) Pilot Free Trade Zone 215000 t (86-512) 62992980 www.sgsgroup.com.cn  
 中国·苏州·中国(江苏)自由贸易试验区苏州片区苏州工业园区润胜路1号的6号厂房南楼 邮编: 215000 t (86-512) 62992980 sgs.china@sgs.com

### 4.7 Band-edge for RF Conducted Emissions

Test Requirement:	47 CFR Part 15C Section 15.247 (d)
Test Method:	ANSI C63.10-2020 Section 11.11
Test Setup:	
Instruments Used:	Refer to section 6 for details.
Exploratory Test Mode:	Transmitting with all kind of modulations, data rates
Final Test Mode:	Refer to section 3.7 for details.
Limit:	In any 100 kHz bandwidth outside the frequency band in which the spread spectrum intentional radiator is operating, the radio frequency power that is produced by the intentional radiator shall be at least 20 dB below that in the 100 kHz bandwidth within the band that contains the highest level of the desired power, based on either an RF conducted or a radiated measurement.
Test Results:	Pass
The detailed test data see: <b>Appendix</b>	



Unless otherwise agreed in writing, this document is issued by the Company subject to its General Conditions of Service printed overleaf, available on request or accessible at <http://www.sgs.com/en/Terms-and-Conditions.aspx> and, for electronic format documents, subject to Terms and Conditions for Electronic Documents at <http://www.sgs.com/en/Terms-and-Conditions/Terms-e-Documents.aspx>. Attention is drawn to the limitation of liability, indemnification and jurisdiction issues defined therein. Any holder of this document is advised that information contained hereon reflects the Company's findings at the time of its intervention only and within the limits of Client's instructions, if any. The Company's sole responsibility is to its Client and this document does not exonerate parties to a transaction from exercising all their rights and obligations under the transaction documents. This document cannot be reproduced except in full, without prior written approval of the Company. Any unauthorized alteration, forgery or falsification of the content or appearance of this document is unlawful and offenders may be prosecuted to the fullest extent of the law. Unless otherwise stated the results shown in this test report refer only to the sample(s) tested and such sample(s) are retained for 30 days only.

Attention: To check the authenticity of testing/inspection report & certificate, please contact us at telephone: (86-755) 8307 1443, or email: [CN\\_Doccheck@sgs.com](mailto:CN_Doccheck@sgs.com)

South of No. 6 Plant, No. 1, Runsheng Road, Suzhou Industrial Park, Suzhou Area, China (Jiangsu) Pilot Free Trade Zone 215000 t (86-512) 62992980 www.sgs.com.cn  
 中国·苏州·中国(江苏)自由贸易试验区苏州片区苏州工业园区润胜路1号的6号厂房南楼 邮编: 215000 t (86-512) 62992980 sgs.china@sgs.com

### 4.8 RF Conducted Spurious Emissions

Test Requirement:	47 CFR Part 15C Section 15.247 (d)
Test Method:	ANSI C63.10-2020 Section 11.11
Test Setup:	
Instruments Used:	Refer to section 6 for details.
Exploratory Test Mode:	Transmitting with all kind of modulations, data rates
Final Test Mode:	Refer to section 3.7 for details.
Limit:	In any 100 kHz bandwidth outside the frequency band in which the spread spectrum intentional radiator is operating, the radio frequency power that is produced by the intentional radiator shall be at least 20 dB below that in the 100 kHz bandwidth within the band that contains the highest level of the desired power, based on either an RF conducted or a radiated measurement.
Test Results:	Pass
The detailed test data see: <b>Appendix</b>	



Unless otherwise agreed in writing, this document is issued by the Company subject to its General Conditions of Service printed overleaf, available on request or accessible at <http://www.sgs.com/en/Terms-and-Conditions.aspx> and, for electronic format documents, subject to Terms and Conditions for Electronic Documents at <http://www.sgs.com/en/Terms-and-Conditions/Terms-e-Document.aspx>. Attention is drawn to the limitation of liability, indemnification and jurisdiction issues defined therein. Any holder of this document is advised that information contained hereon reflects the Company's findings at the time of its intervention only and within the limits of Client's instructions, if any. The Company's sole responsibility is to its Client and this document does not exonerate parties to a transaction from exercising all their rights and obligations under the transaction documents. This document cannot be reproduced except in full, without prior written approval of the Company. Any unauthorized alteration, forgery or falsification of the content or appearance of this document is unlawful and offenders may be prosecuted to the fullest extent of the law. Unless otherwise stated the results shown in this test report refer only to the sample(s) tested and such sample(s) are retained for 30 days only.

Attention: To check the authenticity of testing/inspection report & certificate, please contact us at telephone: (86-755) 8307 1443, or email: [CN.Doccheck@sgs.com](mailto:CN.Doccheck@sgs.com)

South of No. 6 Plant, No. 1, Runsheng Road, Suzhou Industrial Park, Suzhou Area, China (Jiangsu) Pilot Free Trade Zone 215000 t (86-512) 62992980 www.sgs.com.cn  
 中国·苏州·中国(江苏)自由贸易试验区苏州片区苏州工业园区润胜路1号的6号厂房南楼 邮编: 215000 t (86-512) 62992980 sgs.china@sgs.com

### 4.9 Radiated Spurious Emissions

Test Requirement:	47 CFR Part 15C Section 15.209 and 15.205				
Test Method:	ANSI C63.10-2020 Section 11.12				
Test Site:	Measurement Distance: 3m (Semi-Anechoic Chamber)				
Test Frequency:	9kHz ~ 25GHz				
Receiver Setup:	Frequency	Detector	RBW	VBW	Remark
	0.009MHz-0.090MHz	Peak	10kHz	30kHz	Peak
	0.009MHz-0.090MHz	Average	10kHz	30kHz	Average
	0.090MHz-0.110MHz	Quasi-peak	10kHz	30kHz	Quasi-peak
	0.110MHz-0.490MHz	Peak	10kHz	30kHz	Peak
	0.110MHz-0.490MHz	Average	10kHz	30kHz	Average
	0.490MHz -30MHz	Quasi-peak	10kHz	30kHz	Quasi-peak
	30MHz-1GHz	Quasi-peak	120kHz	300kHz	Quasi-peak
Above 1GHz	Peak	1MHz	3MHz	Peak	
	Peak	1MHz	3MHz	Peak	
Limit:	Frequency	Field strength (microvolt/meter)	Limit (dBuV/m)	Remark	Measurement distance (m)
	0.009MHz-0.490MHz	2400/F(kHz)	-	-	300
	0.490MHz-1.705MHz	24000/F(kHz)	-	-	30
	1.705MHz-30MHz	30	-	-	30
	30MHz-88MHz	100	40.0	Quasi-peak	3
	88MHz-216MHz	150	43.5	Quasi-peak	3
	216MHz-960MHz	200	46.0	Quasi-peak	3
	960MHz-1GHz	500	54.0	Quasi-peak	3
	Above 1GHz	500	54.0	Average	3
<p>Remark: 15.35(b), Unless otherwise specified, the limit on peak radio frequency emissions is 20dB above the maximum permitted average emission limit applicable to the equipment under test. This peak limit applies to the total peak emission level radiated by the device.</p>					



Unless otherwise agreed in writing, this document is issued by the Company subject to its General Conditions of Service printed overleaf, available on request or accessible at <http://www.sgs.com/en/Terms-and-Conditions.aspx> and, for electronic format documents, subject to Terms and Conditions for Electronic Documents at <http://www.sgs.com/en/Terms-and-Conditions/Terms-e-Documents.aspx>. Attention is drawn to the limitation of liability, indemnification and jurisdiction issues defined therein. Any holder of this document is advised that information contained hereon reflects the Company's findings at the time of its intervention only and within the limits of Client's instructions, if any. The Company's sole responsibility is to its Client and this document does not exonerate parties to a transaction from exercising all their rights and obligations under the transaction documents. This document cannot be reproduced except in full, without prior written approval of the Company. Any unauthorized alteration, forgery or falsification of the content or appearance of this document is unlawful and offenders may be prosecuted to the fullest extent of the law. Unless otherwise stated the results shown in this test report refer only to the sample(s) tested and such sample(s) are retained for 30 days only.

Attention: To check the authenticity of testing/inspection report & certificate, please contact us at telephone: (86-755) 8307 1443, or email: [CN.Doccheck@sgs.com](mailto:CN.Doccheck@sgs.com)

South of No. 6 Plant, No. 1, Runsheng Road, Suzhou Industrial Park, Suzhou Area, China (Jiangsu) Pilot Free Trade Zone 215000  
 中国·苏州·中国(江苏)自由贸易试验区苏州片区苏州工业园区润胜路1号的6号厂房南楼 邮编: 215000

t (86-512) 62992980 www.sgs.com.cn  
 t (86-512) 62992980 sgs.china@sgs.com

Test Setup:

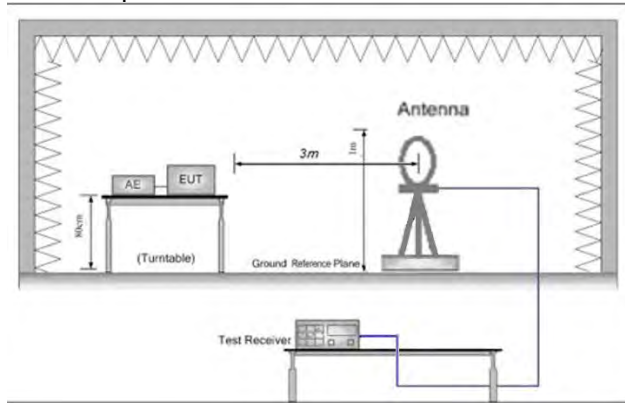

Figure 1. Below 30MHz

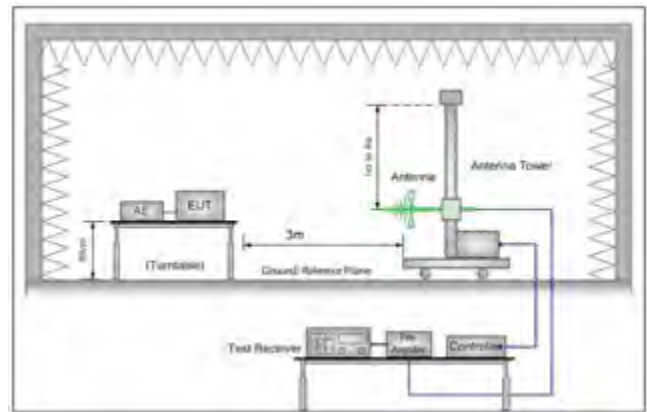

Figure 2. 30MHz to 1GHz

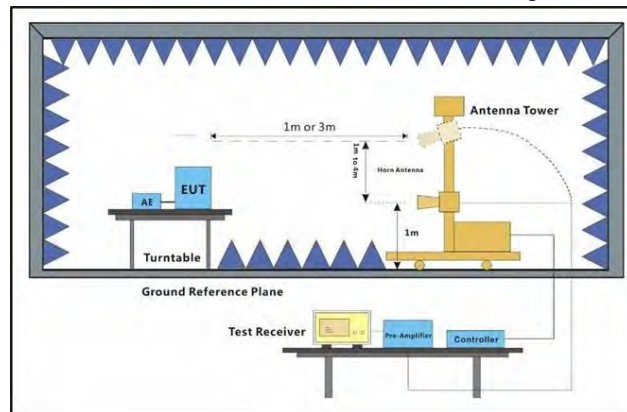

Figure 3. Above 1 GHz

Test Procedure:

- For below 1GHz, the EUT was placed on the top of a rotating table 0.8 meters above the ground at a 3 or 10 meter semi-anechoic chamber. The table was rotated 360 degrees to determine the position of the highest radiation.
- For above 1GHz, the EUT was placed on the top of a rotating table 1.5 meters above the ground at a 3 meter semi-anechoic chamber. The table was rotated 360 degrees to determine the position of the highest radiation (Distance from antenna to EUT is 1m for measurements >18GHz).
- The EUT was set 3 or 10 meters away from the interference-receiving antenna, which was mounted on the top of a variable-height antenna tower.
- The antenna height is varied from one meter to four meters above the ground to determine the maximum value of the field strength. Both horizontal and vertical polarizations of the antenna are set to make the measurement.
- For each suspected emission, the EUT was arranged to its worst case and then the antenna was tuned to heights from 1 meter to 4 meters (for the test frequency of below 30MHz, the antenna was tuned to heights 1 meter) and the rotatable table was turned from 0 degrees to 360 degrees to find the



Unless otherwise agreed in writing, this document is issued by the Company subject to its General Conditions of Service printed overleaf, available on request or accessible at <http://www.sgs.com/en/Terms-and-Conditions.aspx> and, for electronic format documents, subject to Terms and Conditions for Electronic Documents at <http://www.sgs.com/en/Terms-and-Conditions/Terms-e-Document.aspx>. Attention is drawn to the limitation of liability, indemnification and jurisdiction issues defined therein. Any holder of this document is advised that information contained hereon reflects the Company's findings at the time of its intervention only and within the limits of Client's instructions, if any. The Company's sole responsibility is to its Client and this document does not exonerate parties to a transaction from exercising all their rights and obligations under the transaction documents. This document cannot be reproduced except in full, without prior written approval of the Company. Any unauthorized alteration, forgery or falsification of the content or appearance of this document is unlawful and offenders may be prosecuted to the fullest extent of the law. Unless otherwise stated the results shown in this test report refer only to the sample(s) tested and such sample(s) are retained for 30 days only.

Attention: To check the authenticity of testing/inspection report & certificate, please contact us at telephone: (86-755) 8307 1443, or email: [CN.Doccheck@sgs.com](mailto:CN.Doccheck@sgs.com)  
 South of No. 6 Plant, No. 1, Runsheng Road, Suzhou Industrial Park, Suzhou Area, China (Jiangsu) Pilot Free Trade Zone 215000 t (86-512) 62992980 www.sgs.com.cn  
 中国·苏州·中国(江苏)自由贸易试验区苏州片区苏州工业园区润胜路1号的6号厂房南楼 邮编: 215000 t (86-512) 62992980 sgs.china@sgs.com

	<p>maximum reading.</p> <p>f. The test-receiver system was set to Peak Detect Function and Specified Bandwidth with Maximum Hold Mode.</p> <p>g. Test the EUT in the lowest channel, the middle channel ,the Highest channel.</p> <p>h. The radiation measurements are performed in X, Y, Z axis positioning for Transmitting mode, And found the X axis positioning which it is worse case.</p> <p>i. Repeat above procedures until all frequencies measured was complete.</p> <p>j. The low frequency, which started from 9 kHz to 30MHz, was pre-scanned and the result which was 20dB lower than the limit line was not reported</p> <p>k. The disturbance above 18GHz was very low, and the harmonics were the highest point could be found when testing, so only the harmonics had been displayed.</p> <p>l. At a measurement distance of 1 meter the limit line was increased by <math>20 \cdot \text{LOG}(3/1) = 9.54 \text{ dB}</math>.</p>
Test Configuration:	<p>Measurements below 30MHz</p> <ul style="list-style-type: none"> <li>• RBW = 10 kHz</li> <li>• VBW = 30 kHz</li> <li>• Detector = Peak &amp; Average &amp; Quasi-peak</li> <li>• Trace mode = max hold</li> </ul> <p>Measurements Below 1000MHz</p> <ul style="list-style-type: none"> <li>• RBW = 120 kHz</li> <li>• VBW = 300 kHz</li> <li>• Detector = Quasi-peak</li> <li>• Trace mode = max hold</li> </ul> <p>Peak Measurements Above 1000 MHz</p> <ul style="list-style-type: none"> <li>• RBW = 1 MHz</li> <li>• VBW <math>\geq 3 \text{ MHz}</math></li> <li>• Detector = Peak</li> <li>• Sweep time = auto</li> <li>• Trace mode = max hold</li> </ul> <p>Average Measurements Above 1000MHz</p> <ul style="list-style-type: none"> <li>• RBW = 1 MHz</li> <li>• VBW = 10 Hz, when duty cycle is no less than 98 percent.</li> <li>• VBW <math>\geq 1/T</math>, when duty cycle is less than 98 percent where T is the minimum transmission duration over which the transmitter is on and is transmitting at its maximum power control level for the tested mode of operation.</li> </ul>
Exploratory Test Mode:	<p>Transmitting with all kind of modulations, data rates.</p> <p>Charge + Transmitting mode.</p>
Final Test Mode:	<p>Refer to section 3.7 for details.</p> <p>For below 1GHz part, through pre-scan all channels, but only the worst case is recorded in the report.</p>
Instruments Used:	Refer to section 6 for details.
Test Results:	Pass
The detailed test data see: <b>Appendix</b>	



Unless otherwise agreed in writing, this document is issued by the Company subject to its General Conditions of Service printed overleaf, available on request or accessible at <http://www.sgs.com/en/Terms-and-Conditions.aspx> and, for electronic format documents, subject to Terms and Conditions for Electronic Documents at <http://www.sgs.com/en/Terms-and-Conditions/Terms-e-Document.aspx>. Attention is drawn to the limitation of liability, indemnification and jurisdiction issues defined therein. Any holder of this document is advised that information contained hereon reflects the Company's findings at the time of its intervention only and within the limits of Client's instructions, if any. The Company's sole responsibility is to its Client and this document does not exonerate parties to a transaction from exercising all their rights and obligations under the transaction documents. This document cannot be reproduced except in full, without prior written approval of the Company. Any unauthorized alteration, forgery or falsification of the content or appearance of this document is unlawful and offenders may be prosecuted to the fullest extent of the law. Unless otherwise stated the results shown in this test report refer only to the sample(s) tested and such sample(s) are retained for 30 days only.

Attention: To check the authenticity of testing/inspection report & certificate, please contact us at telephone: (86-755) 8307 1443, or email: [CN.Doccheck@sgs.com](mailto:CN.Doccheck@sgs.com)

South of No. 6 Plant, No. 1, Runsheng Road, Suzhou Industrial Park, Suzhou Area, China (Jiangsu) Pilot Free Trade Zone 215000 t (86-512) 62992980 www.sgsgroup.com.cn  
 中国·苏州·中国(江苏)自由贸易试验区苏州片区苏州工业园区润胜路1号的6号厂房南楼 邮编: 215000 t (86-512) 62992980 sgs.china@sgs.com



### 4.10 Restricted bands around fundamental frequency

Test Requirement:	47 CFR Part 15C Section 15.209 and 15.205		
Test Method:	ANSI C63.10-2020 Section 11.12		
Test Site:	Measurement Distance: 3m (Semi-Anechoic Chamber)		
Limit:	Frequency	Limit (dBuV/m)	Remark
	30MHz-88MHz	40.0	Quasi-peak
	88MHz-216MHz	43.5	Quasi-peak
	216MHz-960MHz	46.0	Quasi-peak
	960MHz-1GHz	54.0	Quasi-peak
	Above 1GHz	54.0	Average Value
		74.0	Peak Value

Test Setup:

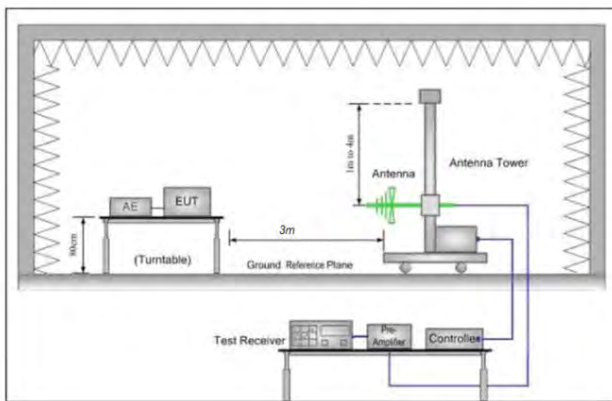

Figure 1. 30MHz to 1GHz

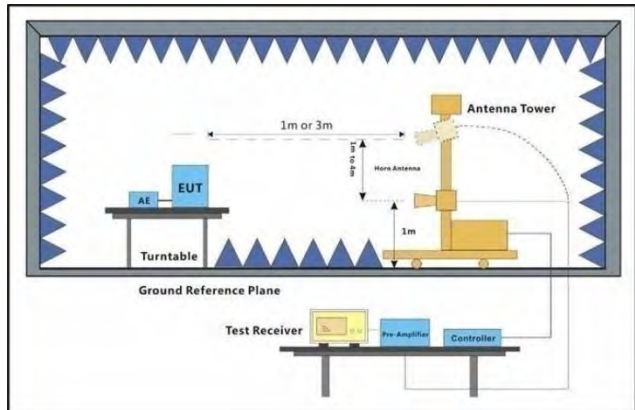

Figure 2. Above 1 GHz



Unless otherwise agreed in writing, this document is issued by the Company subject to its General Conditions of Service printed overleaf, available on request or accessible at <http://www.sgs.com/en/Terms-and-Conditions.aspx> and, for electronic format documents, subject to Terms and Conditions for Electronic Documents at <http://www.sgs.com/en/Terms-and-Conditions/Terms-e-Documents.aspx>. Attention is drawn to the limitation of liability, indemnification and jurisdiction issues defined therein. Any holder of this document is advised that information contained hereon reflects the Company's findings at the time of its intervention only and within the limits of Client's instructions, if any. The Company's sole responsibility is to its Client and this document does not exonerate parties to a transaction from exercising all their rights and obligations under the transaction documents. This document cannot be reproduced except in full, without prior written approval of the Company. Any unauthorized alteration, forgery or falsification of the content or appearance of this document is unlawful and offenders may be prosecuted to the fullest extent of the law. Unless otherwise stated the results shown in this test report refer only to the sample(s) tested and such sample(s) are retained for 30 days only.

Attention: To check the authenticity of testing/inspection report & certificate, please contact us at telephone: (86-755) 8307 1443, or email: [CN.Doccheck@sgs.com](mailto:CN.Doccheck@sgs.com)

South of No. 6 Plant, No. 1, Runsheng Road, Suzhou Industrial Park, Suzhou Area, China (Jiangsu) Pilot Free Trade Zone 215000  
 中国·苏州·中国(江苏)自由贸易试验区苏州片区苏州工业园区润胜路1号的6号厂房南楼 邮编: 215000

t (86-512) 62992980 www.sgs.com.cn  
 t (86-512) 62992980 sgs.china@sgs.com

<p>Test Procedure:</p>	<ol style="list-style-type: none"> <li>a. For below 1GHz, the EUT was placed on the top of a rotating table 0.8 meters above the ground at a 3 or 10 meter semi-anechoic chamber. The table was rotated 360 degrees to determine the position of the highest radiation.</li> <li>b. For above 1GHz, the EUT was placed on the top of a rotating table 1.5 meters above the ground at a 3 meter semi-anechoic chamber. The table was rotated 360 degrees to determine the position of the highest radiation.</li> <li>c. The EUT was set 3 or 10 meters away from the interference-receiving antenna, which was mounted on the top of a variable-height antenna tower.</li> <li>d. The antenna height is varied from one meter to four meters above the ground to determine the maximum value of the field strength. Both horizontal and vertical polarizations of the antenna are set to make the measurement.</li> <li>e. For each suspected emission, the EUT was arranged to its worst case and then the antenna was tuned to heights from 1 meter to 4 meters and the rotatable table was turned from 0 degrees to 360 degrees to find the maximum reading.</li> <li>f. The test-receiver system was set to Peak Detect Function and Specified Bandwidth with Maximum Hold Mode.</li> <li>g. Place a marker at the end of the restricted band closest to the transmit frequency to show compliance. Also measure any emissions in the restricted bands. Save the spectrum analyzer plot. Repeat for each power and modulation for lowest and highest channel</li> <li>h. Test the EUT in the lowest channel , the Highest channel</li> <li>i. The radiation measurements are performed in X, Y, Z axis positioning for Transmitting mode, And found the X axis positioning which it is worse case.</li> <li>j. Repeat above procedures until all frequencies measured was complete.</li> </ol>
<p>Test Configuration:</p>	<p>Measurements Below 1000MHz</p> <ul style="list-style-type: none"> <li>• RBW = 120 kHz</li> <li>• VBW = 300 kHz</li> <li>• Detector = Quasi-peak</li> <li>• Trace mode = max hold</li> </ul> <p>Peak Measurements Above 1000 MHz</p> <ul style="list-style-type: none"> <li>• RBW = 1 MHz</li> <li>• VBW ≥ 3 MHz</li> <li>• Detector = Peak</li> <li>• Sweep time = auto</li> <li>• Trace mode = max hold</li> </ul> <p>Average Measurements Above 1000MHz</p> <ul style="list-style-type: none"> <li>• RBW = 1 MHz</li> <li>• VBW = 10 Hz, when duty cycle is no less than 98 percent.</li> <li>• VBW ≥ 1/T, when duty cycle is less than 98 percent where T is the minimum transmission duration over which the transmitter is on and is transmitting at its maximum power control level for the tested mode of operation.</li> </ul>
<p>Exploratory Test Mode:</p>	<p>Transmitting with all kind of modulations, data rates. Charge + Transmitting mode.</p>
<p>Final Test Mode:</p>	<p>Refer to section 3.7 for details.</p>
<p>Instruments Used:</p>	<p>Refer to section 6 for details.</p>



Unless otherwise agreed in writing, this document is issued by the Company subject to its General Conditions of Service printed overleaf, available on request or accessible at <http://www.sgs.com/en/Terms-and-Conditions.aspx> and, for electronic format documents, subject to Terms and Conditions for Electronic Documents at <http://www.sgs.com/en/Terms-and-Conditions/Terms-e-Documents.aspx>. Attention is drawn to the limitation of liability, indemnification and jurisdiction issues defined therein. Any holder of this document is advised that information contained hereon reflects the Company's findings at the time of its intervention only and within the limits of Client's instructions, if any. The Company's sole responsibility is to its Client and this document does not exonerate parties to a transaction from exercising all their rights and obligations under the transaction documents. This document cannot be reproduced except in full, without prior written approval of the Company. Any unauthorized alteration, forgery or falsification of the content or appearance of this document is unlawful and offenders may be prosecuted to the fullest extent of the law. Unless otherwise stated the results shown in this test report refer only to the sample(s) tested and such sample(s) are retained for 30 days only.

Attention: To check the authenticity of testing/inspection report & certificate, please contact us at telephone: (86-755) 8307 1443, or email: [CN.Doccheck@sgs.com](mailto:CN.Doccheck@sgs.com)

South of No. 6 Plant, No. 1, Pansheng Road, Suzhou Industrial Park, Suzhou Area, China (Jiangsu) Pilot Free Trade Zone 215000 t (86-512) 62992980 www.sgs.com.cn  
 中国·苏州·中国(江苏)自由贸易试验区苏州片区苏州工业园区海胜路1号的6号厂房南楼 邮编: 215000 t (86-512) 62992980 sgs.china@sgs.com



Report No.: SEWM2309000395RG05

Rev.: 01

Page: 27 of 131

Test Results:	Pass
The detailed test data see: <b>Appendix</b>	



Unless otherwise agreed in writing, this document is issued by the Company subject to its General Conditions of Service printed overleaf, available on request or accessible at <http://www.sgs.com/en/Terms-and-Conditions.aspx> and, for electronic format documents, subject to Terms and Conditions for Electronic Documents at <http://www.sgs.com/en/Terms-and-Conditions/Terms-e-Documents.aspx>. Attention is drawn to the limitation of liability, indemnification and jurisdiction issues defined therein. Any holder of this document is advised that information contained hereon reflects the Company's findings at the time of its intervention only and within the limits of Client's instructions, if any. The Company's sole responsibility is to its Client and this document does not exonerate parties to a transaction from exercising all their rights and obligations under the transaction documents. This document cannot be reproduced except in full, without prior written approval of the Company. Any unauthorized alteration, forgery or falsification of the content or appearance of this document is unlawful and offenders may be prosecuted to the fullest extent of the law. Unless otherwise stated the results shown in this test report refer only to the sample(s) tested and such sample(s) are retained for 30 days only.

Attention: To check the authenticity of testing/inspection report & certificate, please contact us at telephone: (86-755) 8307 1443, or email: [CN.Doccheck@sgs.com](mailto:CN.Doccheck@sgs.com)

South of No. 6 Plant, No. 1, Runsheng Road, Suzhou Industrial Park, Suzhou Area, China (Jiangsu) Pilot Free Trade Zone 215000 t (86-512) 62992980 www.sgs.com.cn  
 中国·苏州·中国(江苏)自由贸易试验区苏州片区苏州工业园区润胜路1号的6号厂房南楼 邮编: 215000 t (86-512) 62992980 sgs.china@sgs.com

## 5 Measurement Uncertainty (95% confidence levels, k=2)

No.	Item	Measurement Uncertainty
1	Total RF power, conducted	±0.54dB
2	RF power density, conducted	±1.03dB
3	Spurious emissions, conducted	±0.54dB
4	Radio Frequency	±1.0 %
5	Duty Cycle	±0.37%
6	Occupied Bandwidth	±1.0 %
7	Conduction Emission	± 2.90dB (150kHz to 30MHz)
8	Radiated Emission	± 3.13dB (9k to 30MHz)
		± 4.88dB (30M to 1GHz)
		± 4.75dB (1GHz to 18GHz)
		± 4.77dB (Above 18GHz)

**Remark:**

The  $U_{lab}$  (lab Uncertainty) is less than  $U_{CISPR/ETSI}$  (CISPR/ETSI Uncertainty), so the test results  
 – compliance is deemed to occur if no measured disturbance level exceeds the disturbance limit;  
 – non-compliance is deemed to occur if any measured disturbance level exceeds the disturbance limit.



Unless otherwise agreed in writing, this document is issued by the Company subject to its General Conditions of Service printed overleaf, available on request or accessible at <http://www.sgs.com/en/Terms-and-Conditions.aspx> and, for electronic format documents, subject to Terms and Conditions for Electronic Documents at <http://www.sgs.com/en/Terms-and-Conditions/Terms-e-Documents.aspx>. Attention is drawn to the limitation of liability, indemnification and jurisdiction issues defined therein. Any holder of this document is advised that information contained hereon reflects the Company's findings at the time of its intervention only and within the limits of Client's instructions, if any. The Company's sole responsibility is to its Client and this document does not exonerate parties to a transaction from exercising all their rights and obligations under the transaction documents. This document cannot be reproduced except in full, without prior written approval of the Company. Any unauthorized alteration, forgery or falsification of the content or appearance of this document is unlawful and offenders may be prosecuted to the fullest extent of the law. Unless otherwise stated the results shown in this test report refer only to the sample(s) tested and such sample(s) are retained for 30 days only.  
**Attention: To check the authenticity of testing/inspection report & certificate, please contact us at telephone: (86-755) 8307 1443, or email: CN.Doccheck@sgs.com**

South of No. 6 Plant, No. 1, Runsheng Road, Suzhou Industrial Park, Suzhou Area, China (Jiangsu) Pilot Free Trade Zone 215000  
 中国·苏州·中国(江苏)自由贸易试验区苏州片区苏州工业园区润胜路1号的6号厂房南楼 邮编: 215000

t (86-512) 62992980 www.sgs.com.cn  
 t (86-512) 62992980 sgs.china@sgs.com

## 6 Equipment List

RF Test Equipment					
Test Equipment	Manufacturer	Model No.	Inventory No.	Cal. date (yyyy/mm/dd)	Cal.Due date (yyyy/mm/dd)
Shielding Room	Brilliant-emc	N/A	SUWI-04-01-06	2021/05/08	2024/05/07
Temperature and humidity meter	MingGao	TH101B	SUWI-01-01-07	2023/02/06	2024/02/05
Measurement Software	Tonscend	JS1120-3 Test System V 3.3.20	SUWI-02-09-09	NCR	NCR
Signal Analyzer	ROHDE&SCHWARZ	FSW43	SUWI-01-02-04	2023/05/11	2024/05/10
Temperature Chamber	ESPEC	SU-242	SUWI-01-13-01	2023/02/06	2024/02/05
Wideband Radio Communication Tester	ROHDE&SCHWARZ	CMW500	SUWI-01-16-05	2023/02/06	2024/02/05
DC Power Supply	HYELEC	HY3005B	SUWI-01-18-01	2023/02/06	2024/02/05
Power meter	Anritsu	ML2495A	SUWI-01-31-01	2022/11/23	2023/11/22
Pulse power sensor	Anritsu	MA2411B	SUWI-01-32-01	2022/11/23	2023/11/22
MXG Vector signal genitor	KEYSIGHT	N5182B	SUWI-01-38-01	2023/02/06	2024/02/05
Signal Generator	ROHDE&SCHWARZ	SMM100A	SN:101716	2023/02/22	2024/02/21

Conduction Test Equipment					
Test Equipment	Manufacturer	Model No.	Inventory No.	Cal. date (yyyy/mm/dd)	Cal.Due date (yyyy/mm/dd)
Shielding Room	Brilliant-emc	N/A	SUWI-04-03-01	2021/05/08	2024/05/07
Test receiver	ROHDE&SCHWARZ	ESR7	SUWI-01-10-01	2023/02/08	2024/02/07
Temperature and humidity meter	MingGao	TH101B	SUWI-01-01-06	2023/02/07	2024/02/06
Artificial network	ROHDE&SCHWARZ	ENV216	SUWI-01-19-03	2023/02/08	2024/02/07
Artificial network	ROHDE&SCHWARZ	ENV216	SUWI-01-19-04	2023/02/08	2024/02/07
Measurement Software	Tonscend	JS32-CE V4.0.0.2	SUWI-02-09-05	NCR	NCR



Unless otherwise agreed in writing, this document is issued by the Company subject to its General Conditions of Service printed overleaf, available on request or accessible at <http://www.sgs.com/en/Terms-and-Conditions.aspx> and, for electronic format documents, subject to Terms and Conditions for Electronic Documents at <http://www.sgs.com/en/Terms-and-Conditions/Terms-e-Documents.aspx>. Attention is drawn to the limitation of liability, indemnification and jurisdiction issues defined therein. Any holder of this document is advised that information contained hereon reflects the Company's findings at the time of its intervention only and within the limits of Client's instructions, if any. The Company's sole responsibility is to its Client and this document does not exonerate parties to a transaction from exercising all their rights and obligations under the transaction documents. This document cannot be reproduced except in full, without prior written approval of the Company. Any unauthorized alteration, forgery or falsification of the content or appearance of this document is unlawful and offenders may be prosecuted to the fullest extent of the law. Unless otherwise stated the results shown in this test report refer only to the sample(s) tested and such sample(s) are retained for 30 days only.

Attention: To check the authenticity of testing/inspection report & certificate, please contact us at telephone: (86-755) 8307 1443, or email: [CN.Doccheck@sgs.com](mailto:CN.Doccheck@sgs.com)

South of No. 6 Plant, No. 1, Runsheng Road, Suzhou Industrial Park, Suzhou Area, China (Jiangsu) Pilot Free Trade Zone 215000  
 中国·苏州·中国(江苏)自由贸易试验区苏州片区苏州工业园区润胜路1号的6号厂房南楼 邮编: 215000

t (86-512) 62992980 www.sgsgroup.com.cn  
 t (86-512) 62992980 sgs.china@sgs.com

Report No.: SEWM2309000395RG05

Rev.: 01

Page: 30 of 131

RSE Test System					
Test Equipment	Manufacturer	Model No.	Inventory No.	Cal. date (yyyy/mm/dd)	Cal.Due date (yyyy/mm/dd)
Semi-Anechoic Chamber	Brilliant-emc	N/A	SUWI-04-02-02	2021/11/25	2024/11/24
Temperature and humidity meter	MingGao	TH101B	SUWI-01-01-13	2023/02/07	2024/02/06
Signal Analyzer	ROHDE&SCHWARZ	FSW43	SUWI-01-02-04	2023/05/11	2024/05/10
Signal Analyzer	KEYSIGHT	N9020A	SUWI-01-02-06	2022/11/23	2023/11/22
Test receiver	ROHDE&SCHWARZ	ESR7	SUWI-01-10-01	2023/02/08	2024/02/07
Receiving antenna	SCHWRZBECK MESS-ELEKTRONIK	VULB 9168	SUWI-01-11-04	2021/12/05	2023/12/04
Receiving antenna	SCHWRZBECK MESS-ELEKTRONIK	BBHA 9120D	SUWI-01-11-05	2021/12/05	2023/12/04
Receiving antenna	SCHWRZBECK MESS-ELEKTRONIK	BBHA 9170	SUWI-01-11-03	2023/05/12	2024/05/11
Active Loop Antenna	SCHWRZBECK MESS-ELEKTRONIK	FMZB 1519B	SUWI-01-21-01	2023/05/13	2024/05/12
Amplifier	Tonscend	TAP9K3G32	SUWI-01-14-06	2022/11/23	2023/11/22
Amplifier	Tonscend	TAP01018050	SUWI-01-14-04	2022/11/23	2023/11/22
Amplifier	Tonscend	TAP30M7G30	SUWI-01-14-05	2022/11/23	2023/11/22
Measurement Software	Tonscend	JS32-RE V4.0.0.0	SUWI-02-09-04	NCR	NCR



Unless otherwise agreed in writing, this document is issued by the Company subject to its General Conditions of Service printed overleaf, available on request or accessible at <http://www.sgs.com/en/Terms-and-Conditions.aspx> and, for electronic format documents, subject to Terms and Conditions for Electronic Documents at <http://www.sgs.com/en/Terms-and-Conditions/Terms-e-Documents.aspx>. Attention is drawn to the limitation of liability, indemnification and jurisdiction issues defined therein. Any holder of this document is advised that information contained hereon reflects the Company's findings at the time of its intervention only and within the limits of Client's instructions, if any. The Company's sole responsibility is to its Client and this document does not exonerate parties to a transaction from exercising all their rights and obligations under the transaction documents. This document cannot be reproduced except in full, without prior written approval of the Company. Any unauthorized alteration, forgery or falsification of the content or appearance of this document is unlawful and offenders may be prosecuted to the fullest extent of the law. Unless otherwise stated the results shown in this test report refer only to the sample(s) tested and such sample(s) are retained for 30 days only.

Attention: To check the authenticity of testing/inspection report & certificate, please contact us at telephone: (86-755) 8307 1443, or email: [CN.Doccheck@sgs.com](mailto:CN.Doccheck@sgs.com)

South of No. 6 Plant, No. 1, Runsheng Road, Suzhou Industrial Park, Suzhou Area, China (Jiangsu) Pilot Free Trade Zone 215000 t (86-512) 62992980 www.sgs.com.cn  
 中国·苏州·中国(江苏)自由贸易试验区苏州片区苏州工业园区润胜路1号的6号厂房南楼 邮编: 215000 t (86-512) 62992980 sgs.china@sgs.com

Report No.: SEWM2309000395RG05

Rev.: 01

Page: 31 of 131

## 7 Photographs - Setup Photos

Refer to Appendix A.2 WLAN Setup Photos.



Unless otherwise agreed in writing, this document is issued by the Company subject to its General Conditions of Service printed overleaf, available on request or accessible at <http://www.sgs.com/en/Terms-and-Conditions.aspx> and, for electronic format documents, subject to Terms and Conditions for Electronic Documents at <http://www.sgs.com/en/Terms-and-Conditions/Terms-e-Document.aspx>. Attention is drawn to the limitation of liability, indemnification and jurisdiction issues defined therein. Any holder of this document is advised that information contained hereon reflects the Company's findings at the time of its intervention only and within the limits of Client's instructions, if any. The Company's sole responsibility is to its Client and this document does not exonerate parties to a transaction from exercising all their rights and obligations under the transaction documents. This document cannot be reproduced except in full, without prior written approval of the Company. Any unauthorized alteration, forgery or falsification of the content or appearance of this document is unlawful and offenders may be prosecuted to the fullest extent of the law. Unless otherwise stated the results shown in this test report refer only to the sample(s) tested and such sample(s) are retained for 30 days only.  
**Attention: To check the authenticity of testing/inspection report & certificate, please contact us at telephone: (86-755) 8307 1443, or email: [CN.Doccheck@sgs.com](mailto:CN.Doccheck@sgs.com)**

South of No. 6 Plant, No. 1, Runsheng Road, Suzhou Industrial Park, Suzhou Area, China (Jiangsu) Pilot Free Trade Zone 215000  
中国·苏州·中国(江苏)自由贸易试验区苏州片区苏州工业园区润胜路1号的6号厂房南楼 邮编: 215000

t (86-512) 62992980 www.sgs.com.cn  
t (86-512) 62992980 sgs.china@sgs.com

Report No.: SEWM2309000395RG05

Rev.: 01

Page: 32 of 131

# Appendix



Unless otherwise agreed in writing, this document is issued by the Company subject to its General Conditions of Service printed overleaf, available on request or accessible at <http://www.sgs.com/en/Terms-and-Conditions.aspx> and, for electronic format documents, subject to Terms and Conditions for Electronic Documents at <http://www.sgs.com/en/Terms-and-Conditions/Terms-e-Document.aspx>. Attention is drawn to the limitation of liability, indemnification and jurisdiction issues defined therein. Any holder of this document is advised that information contained hereon reflects the Company's findings at the time of its intervention only and within the limits of Client's instructions, if any. The Company's sole responsibility is to its Client and this document does not exonerate parties to a transaction from exercising all their rights and obligations under the transaction documents. This document cannot be reproduced except in full, without prior written approval of the Company. Any unauthorized alteration, forgery or falsification of the content or appearance of this document is unlawful and offenders may be prosecuted to the fullest extent of the law. Unless otherwise stated the results shown in this test report refer only to the sample(s) tested and such sample(s) are retained for 30 days only.

Attention: To check the authenticity of testing/inspection report & certificate, please contact us at telephone: (86-755) 8307 1443, or email: [CN.Doccheck@sgs.com](mailto:CN.Doccheck@sgs.com)

South of No. 6 Plant, No. 1, Runsheng Road, Suzhou Industrial Park, Suzhou Area, China (Jiangsu) Pilot Free Trade Zone 215000 t (86-512) 62992980 www.sgs.com.cn  
中国·苏州·中国(江苏)自由贸易试验区苏州片区苏州工业园区润胜路1号的6号厂房南楼 邮编: 215000 t (86-512) 62992980 sgs.china@sgs.com



**DTS Bandwidth  
Test Result**

TestMode	Antenna	Frequency[MHz]	DTS BW [MHz]	FL[MHz]	FH[MHz]	Limit[MHz]	Verdict
11b-CDD	Ant10	2412	8.12	2407.92	2416.04	≥0.5	PASS
11b-CDD	Ant8	2412	8.16	2407.92	2416.08	≥0.5	PASS
11b-CDD	Ant10	2437	8.12	2432.92	2441.04	≥0.5	PASS
11b-CDD	Ant8	2437	8.12	2432.92	2441.04	≥0.5	PASS
11b-CDD	Ant10	2462	8.16	2457.92	2466.08	≥0.5	PASS
11b-CDD	Ant8	2462	8.16	2457.92	2466.08	≥0.5	PASS
11g-CDD	Ant10	2412	15.20	2404.36	2419.56	≥0.5	PASS
11g-CDD	Ant8	2412	15.76	2404.16	2419.92	≥0.5	PASS
11g-CDD	Ant10	2437	16.00	2429.16	2445.16	≥0.5	PASS
11g-CDD	Ant8	2437	16.36	2428.80	2445.16	≥0.5	PASS
11g-CDD	Ant10	2462	16.00	2453.80	2469.80	≥0.5	PASS
11g-CDD	Ant8	2462	16.12	2453.80	2469.92	≥0.5	PASS
11n20MIMO	Ant10	2412	15.20	2404.36	2419.56	≥0.5	PASS
11n20MIMO	Ant8	2412	15.20	2404.36	2419.56	≥0.5	PASS
11n20MIMO	Ant10	2437	16.84	2428.56	2445.40	≥0.5	PASS
11n20MIMO	Ant8	2437	16.88	2428.56	2445.44	≥0.5	PASS
11n20MIMO	Ant10	2462	16.88	2453.52	2470.40	≥0.5	PASS
11n20MIMO	Ant8	2462	16.04	2453.52	2469.56	≥0.5	PASS
11n40MIMO	Ant10	2422	35.28	2404.32	2439.60	≥0.5	PASS
11n40MIMO	Ant8	2422	35.28	2404.32	2439.60	≥0.5	PASS
11n40MIMO	Ant10	2437	35.84	2418.76	2454.60	≥0.5	PASS
11n40MIMO	Ant8	2437	35.28	2419.32	2454.60	≥0.5	PASS
11n40MIMO	Ant10	2452	33.92	2433.76	2467.68	≥0.5	PASS
11n40MIMO	Ant8	2452	35.84	2433.76	2469.60	≥0.5	PASS



Unless otherwise agreed in writing, this document is issued by the Company subject to its General Conditions of Service printed overleaf, available on request or accessible at <http://www.sgs.com/en/Terms-and-Conditions.aspx> and, for electronic format documents, subject to Terms and Conditions for Electronic Documents at <http://www.sgs.com/en/Terms-and-Conditions/Terms-e-Documents.aspx>. Attention is drawn to the limitation of liability, indemnification and jurisdiction issues defined therein. Any holder of this document is advised that information contained hereon reflects the Company's findings at the time of its intervention only and within the limits of Client's instructions, if any. The Company's sole responsibility is to its Client and this document does not exonerate parties to a transaction from exercising all their rights and obligations under the transaction documents. This document cannot be reproduced except in full, without prior written approval of the Company. Any unauthorized alteration, forgery or falsification of the content or appearance of this document is unlawful and offenders may be prosecuted to the fullest extent of the law. Unless otherwise stated the results shown in this test report refer only to the sample(s) tested and such sample(s) are retained for 30 days only.

Attention: To check the authenticity of testing/inspection report & certificate, please contact us at telephone: (86-755) 8307 1443, or email: [CN.Doccheck@sgs.com](mailto:CN.Doccheck@sgs.com)

South of No. 6 Plant, No. 1, Runsheng Road, Suzhou Industrial Park, Suzhou Area, China (Jiangsu) Pilot Free Trade Zone 215000 t (86-512) 62992980 www.sgsgroup.com.cn  
 中国·苏州·中国(江苏)自由贸易试验区苏州片区苏州工业园区润胜路1号的6号厂房南楼 邮编: 215000 t (86-512) 62992980 sgs.china@sgs.com

Test Graphs

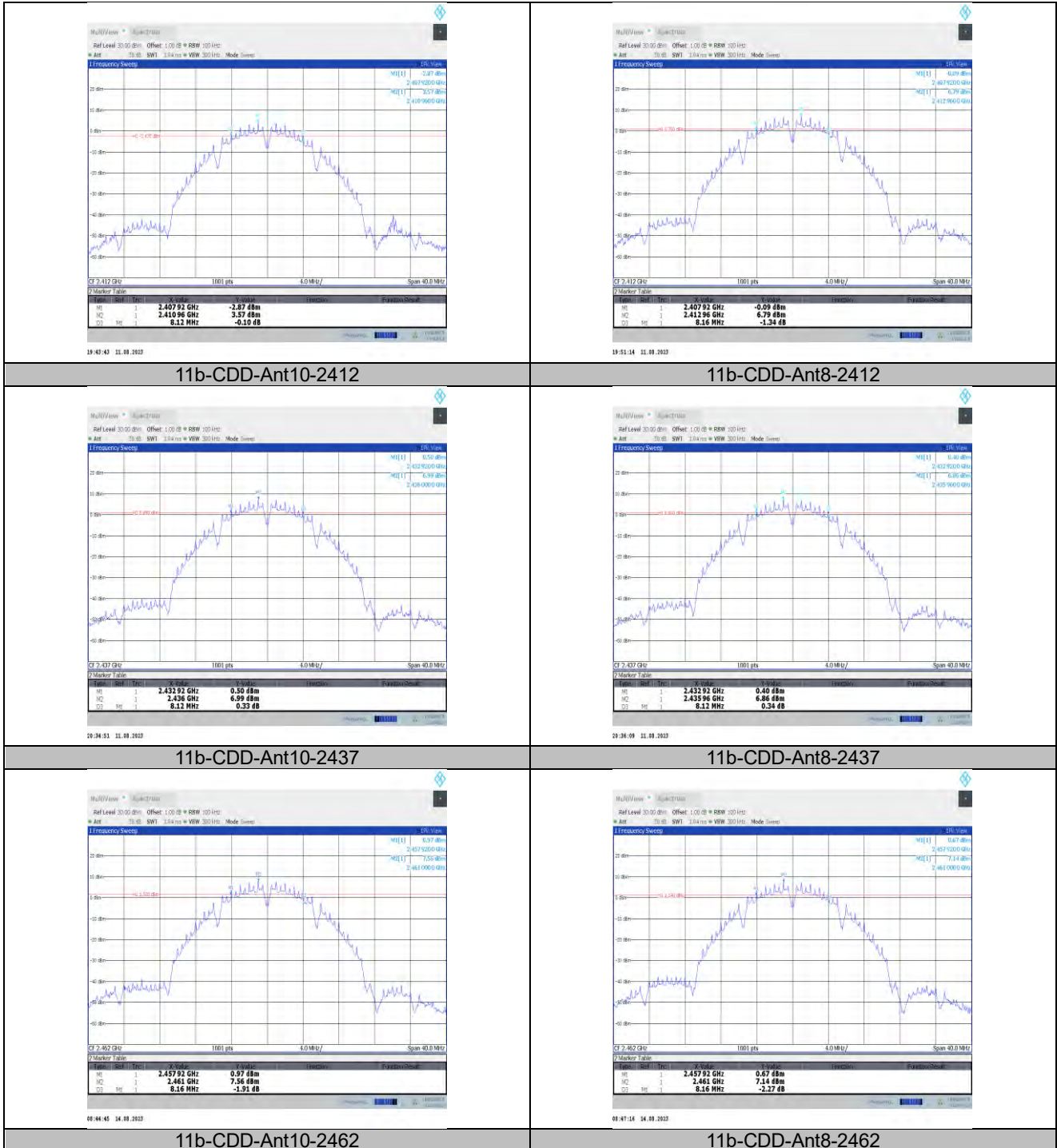

Unless otherwise agreed in writing, this document is issued by the Company subject to its General Conditions of Service printed overleaf, available on request or accessible at <http://www.sgs.com/en/Terms-and-Conditions.aspx> and, for electronic format documents, subject to Terms and Conditions for Electronic Documents at <http://www.sgs.com/en/Terms-and-Conditions/Terms-e-Document.aspx>. Attention is drawn to the limitation of liability, indemnification and jurisdiction issues defined therein. Any holder of this document is advised that information contained hereon reflects the Company's findings at the time of its intervention only and within the limits of Client's instructions, if any. The Company's sole responsibility is to its Client and this document does not exonerate parties to a transaction from exercising all their rights and obligations under the transaction documents. This document cannot be reproduced except in full, without prior written approval of the Company. Any unauthorized alteration, forgery or falsification of the content or appearance of this document is unlawful and offenders may be prosecuted to the fullest extent of the law. Unless otherwise stated the results shown in this test report refer only to the sample(s) tested and such sample(s) are retained for 30 days only.

**Attention:** To check the authenticity of testing/inspection report & certificate, please contact us at telephone: (86-755) 8307 1443, or email: [CN.Doccheck@sgs.com](mailto:CN.Doccheck@sgs.com)

South of No. 6 Plant, No. 1, Runsheng Road, Suzhou Industrial Park, Suzhou Area, China (Jiangsu) Pilot Free Trade Zone 215000 t (86-512) 62992980 www.sgs.com.cn  
 中国·苏州·中国(江苏)自由贸易试验区苏州片区苏州工业园区润胜路1号的6号厂房南楼 邮编: 215000 t (86-512) 62992980 sgs.china@sgs.com

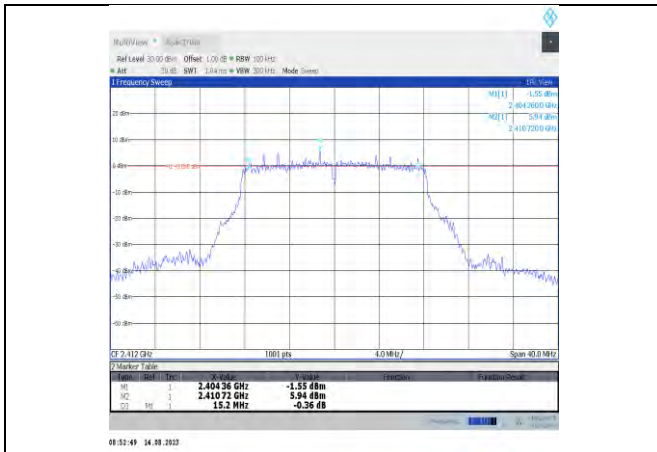

11g-CDD-Ant10-2412

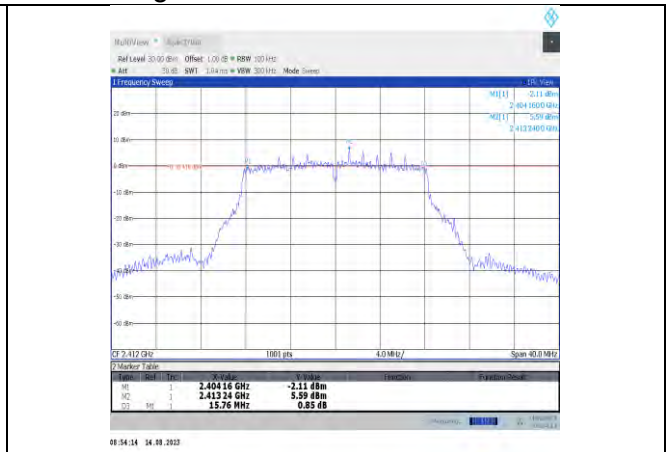

11g-CDD-Ant8-2412

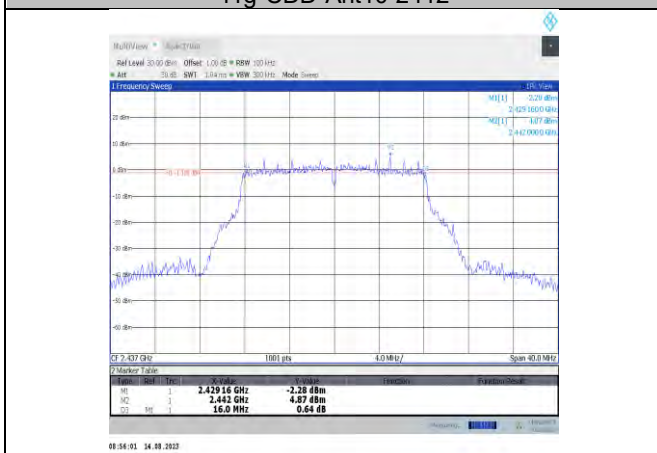

11g-CDD-Ant10-2437

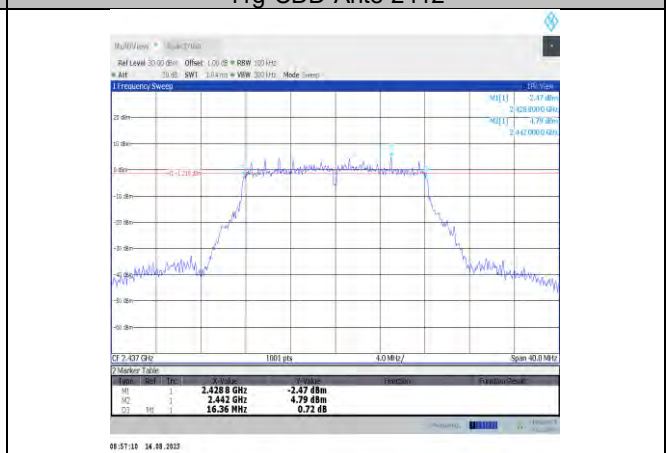

11g-CDD-Ant8-2437



11g-CDD-Ant10-2462



11g-CDD-Ant8-2462



Unless otherwise agreed in writing, this document is issued by the Company subject to its General Conditions of Service printed overleaf, available on request or accessible at <http://www.sgs.com/en/Terms-and-Conditions.aspx> and, for electronic format documents, subject to Terms and Conditions for Electronic Documents at <http://www.sgs.com/en/Terms-and-Conditions/Terms-e-Documents.aspx>. Attention is drawn to the limitation of liability, indemnification and jurisdiction issues defined therein. Any holder of this document is advised that information contained hereon reflects the Company's findings at the time of its intervention only and within the limits of Client's instructions, if any. The Company's sole responsibility is to its Client and this document does not exonerate parties to a transaction from exercising all their rights and obligations under the transaction documents. This document cannot be reproduced except in full, without prior written approval of the Company. Any unauthorized alteration, forgery or falsification of the content or appearance of this document is unlawful and offenders may be prosecuted to the fullest extent of the law. Unless otherwise stated the results shown in this test report refer only to the sample(s) tested and such sample(s) are retained for 30 days only.

Attention: To check the authenticity of testing/inspection report & certificate, please contact us at telephone: (86-755) 8307 1443, or email: [CN.Doccheck@sgs.com](mailto:CN.Doccheck@sgs.com)  
 South of No. 6 Plant, No. 1, Runsheng Road, Suzhou Industrial Park, Suzhou Area, China (Jiangsu) Pilot Free Trade Zone 215000 t (86-512) 62992980 www.sgs.com.cn  
 中国·苏州·中国(江苏)自由贸易试验区苏州片区苏州工业园区润胜路1号的6号厂房南楼 邮编: 215000 t (86-512) 62992980 sgs.china@sgs.com

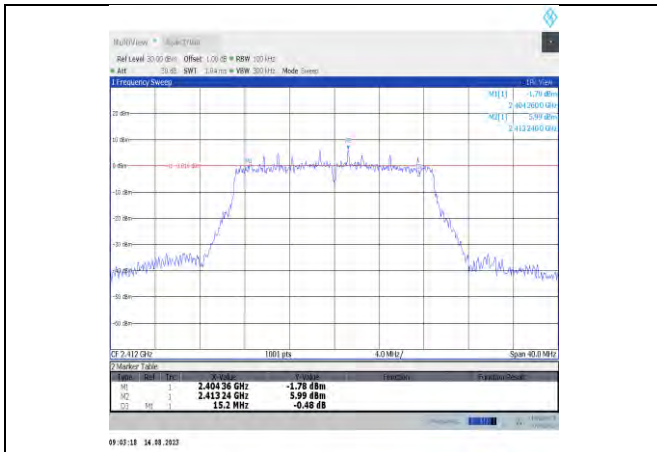

11n20MIMO-Ant10-2412

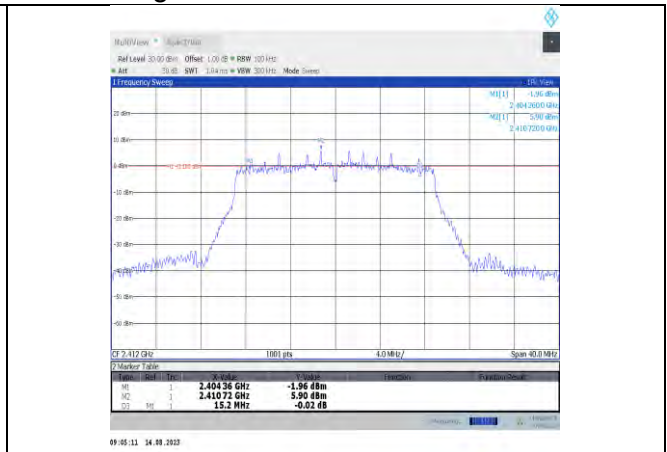

11n20MIMO-Ant8-2412

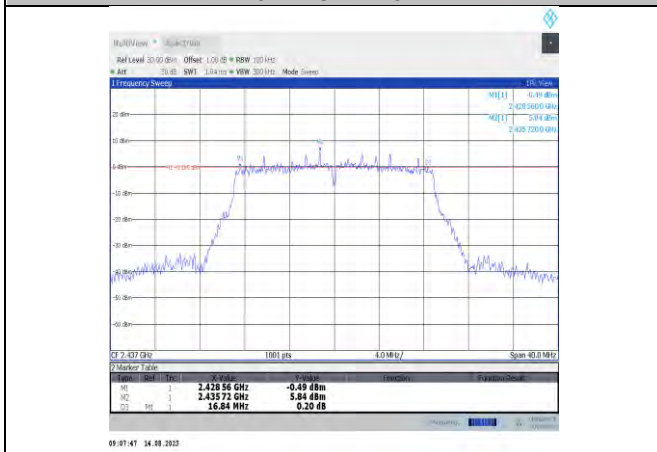

11n20MIMO-Ant10-2437

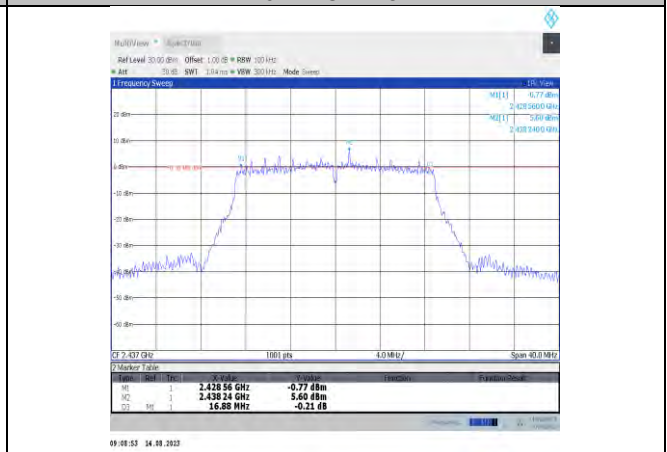

11n20MIMO-Ant8-2437

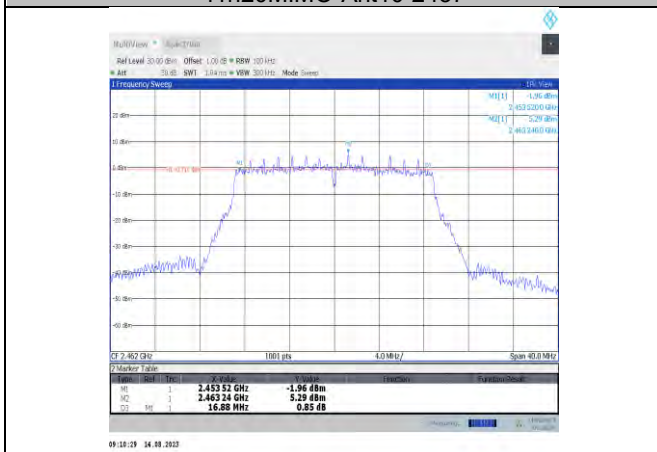

11n20MIMO-Ant10-2462

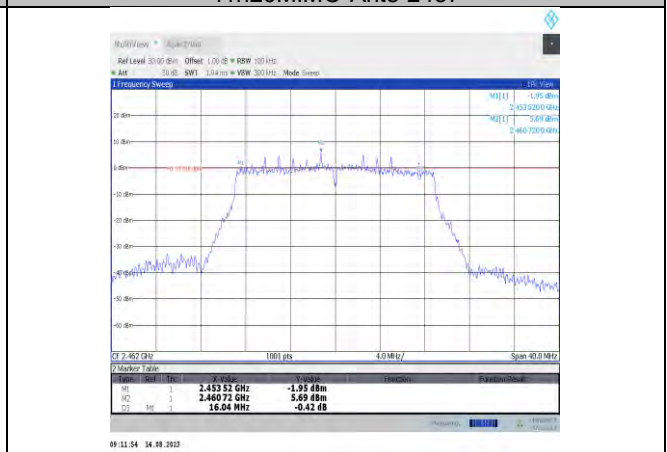

11n20MIMO-Ant8-2462



Unless otherwise agreed in writing, this document is issued by the Company subject to its General Conditions of Service printed overleaf, available on request or accessible at <http://www.sgs.com/en/Terms-and-Conditions.aspx> and, for electronic format documents, subject to Terms and Conditions for Electronic Documents at <http://www.sgs.com/en/Terms-and-Conditions/Terms-e-Documents.aspx>. Attention is drawn to the limitation of liability, indemnification and jurisdiction issues defined therein. Any holder of this document is advised that information contained hereon reflects the Company's findings at the time of its intervention only and within the limits of Client's instructions, if any. The Company's sole responsibility is to its Client and this document does not exonerate parties to a transaction from exercising all their rights and obligations under the transaction documents. This document cannot be reproduced except in full, without prior written approval of the Company. Any unauthorized alteration, forgery or falsification of the content or appearance of this document is unlawful and offenders may be prosecuted to the fullest extent of the law. Unless otherwise stated the results shown in this test report refer only to the sample(s) tested and such sample(s) are retained for 30 days only.

Attention: To check the authenticity of testing/inspection report & certificate, please contact us at telephone: (86-755) 8307 1443, or email: [CN.Doccheck@sgs.com](mailto:CN.Doccheck@sgs.com)  
 South of No. 6 Plant, No. 1, Runsheng Road, Suzhou Industrial Park, Suzhou Area, China (Jiangsu) Pilot Free Trade Zone 215000 t (86-512) 62992980 www.sgs.com.cn  
 中国·苏州·中国(江苏)自由贸易试验区苏州片区苏州工业园区润胜路1号的6号厂房南楼 邮编: 215000 t (86-512) 62992980 sgs.china@sgs.com



11n40MIMO-Ant10-2422

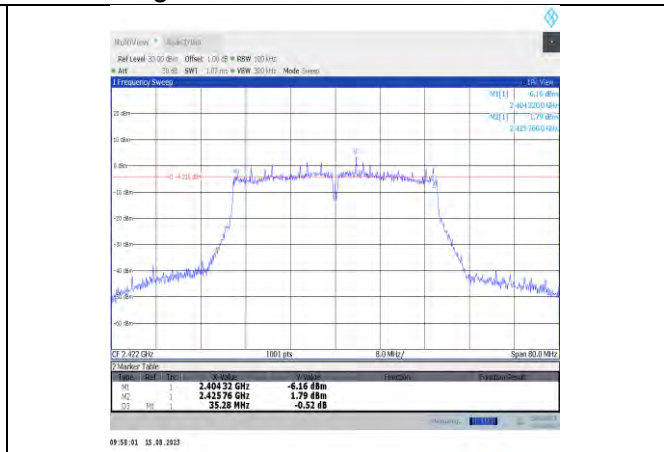

11n40MIMO-Ant8-2422

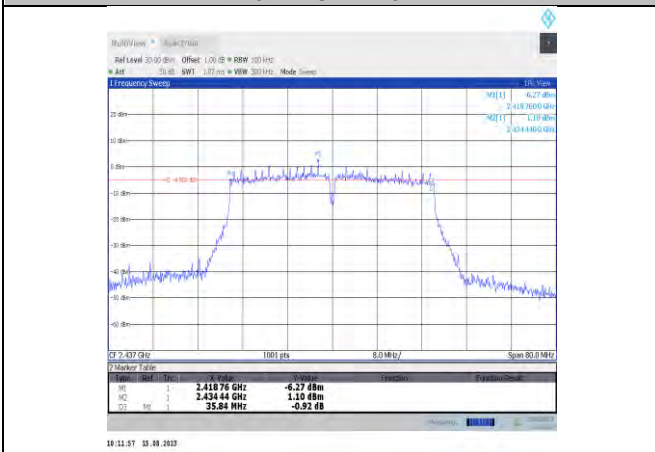

11n40MIMO-Ant10-2437

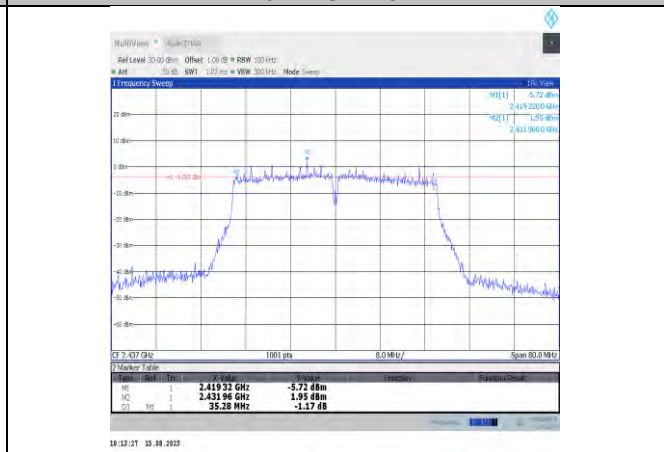

11n40MIMO-Ant8-2437

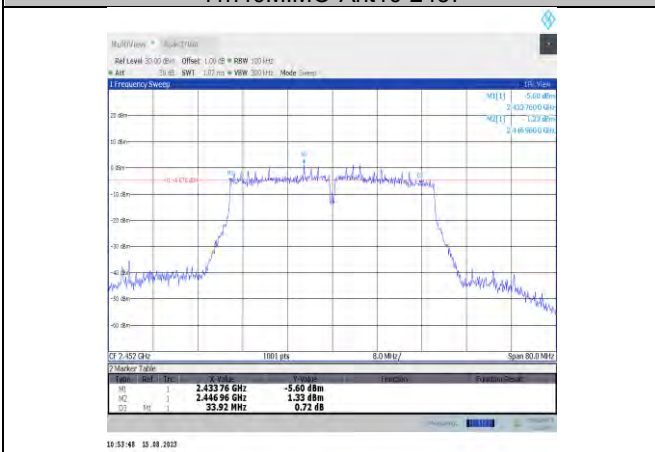

11n40MIMO-Ant10-2452

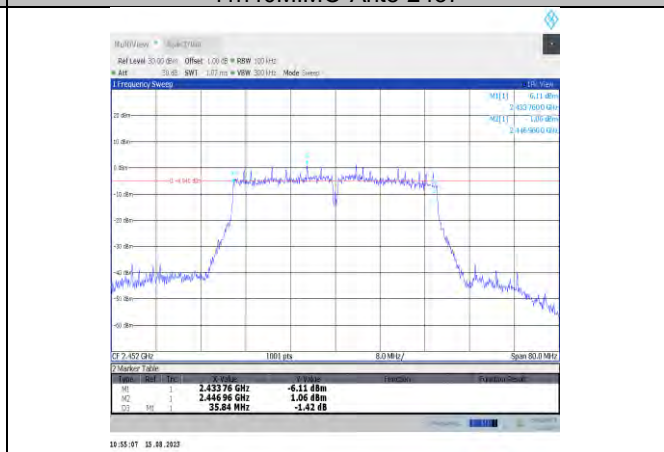

11n40MIMO-Ant8-2452



Unless otherwise agreed in writing, this document is issued by the Company subject to its General Conditions of Service printed overleaf, available on request or accessible at <http://www.sgs.com/en/Terms-and-Conditions.aspx> and, for electronic format documents, subject to Terms and Conditions for Electronic Documents at <http://www.sgs.com/en/Terms-and-Conditions/Terms-e-Documents.aspx>. Attention is drawn to the limitation of liability, indemnification and jurisdiction issues defined therein. Any holder of this document is advised that information contained hereon reflects the Company's findings at the time of its intervention only and within the limits of Client's instructions, if any. The Company's sole responsibility is to its Client and this document does not exonerate parties to a transaction from exercising all their rights and obligations under the transaction documents. This document cannot be reproduced except in full, without prior written approval of the Company. Any unauthorized alteration, forgery or falsification of the content or appearance of this document is unlawful and offenders may be prosecuted to the fullest extent of the law. Unless otherwise stated the results shown in this test report refer only to the sample(s) tested and such sample(s) are retained for 30 days only.

Attention: To check the authenticity of testing/inspection report & certificate, please contact us at telephone: (86-755) 8307 1443, or email: [CN.Doccheck@sgs.com](mailto:CN.Doccheck@sgs.com)  
 South of No. 6 Plant, No. 1, Runsheng Road, Suzhou Industrial Park, Suzhou Area, China (Jiangsu) Pilot Free Trade Zone 215000 t (86-512) 62992980 www.sgs.com.cn  
 中国·苏州·中国(江苏)自由贸易试验区苏州片区苏州工业园区润胜路1号的6号厂房南楼 邮编: 215000 t (86-512) 62992980 sgs.china@sgs.com

### Occupied Channel Bandwidth Test Result

TestMode	Antenna	Channel Frequency[MHz]	OCB [MHz]	FL[MHz]	FH[MHz]	Verdict
11b-CDD	Ant10	2412	13.519	2405.0673	2418.5862	For Report Purpose
11b-CDD	Ant8	2412	13.756	2405.1931	2418.9487	
11b-CDD	Ant10	2437	13.65	2430.1109	2443.7610	
11b-CDD	Ant8	2437	13.663	2430.1052	2443.7682	
11b-CDD	Ant10	2462	13.759	2455.0390	2468.7985	
11b-CDD	Ant8	2462	13.847	2454.9921	2468.8393	
11g-CDD	Ant10	2412	16.831	2403.6018	2420.4329	
11g-CDD	Ant8	2412	16.847	2403.5738	2420.4210	
11g-CDD	Ant10	2437	16.815	2428.5997	2445.4147	
11g-CDD	Ant8	2437	16.825	2428.5707	2445.3959	
11g-CDD	Ant10	2462	16.825	2453.5135	2470.3382	
11g-CDD	Ant8	2462	16.888	2453.4983	2470.3858	
11n20MIMO	Ant10	2412	17.894	2403.0318	2420.9257	
11n20MIMO	Ant8	2412	17.917	2403.0300	2420.9465	
11n20MIMO	Ant10	2437	17.923	2428.0215	2445.9441	
11n20MIMO	Ant8	2437	17.94	2428.0269	2445.9670	
11n20MIMO	Ant10	2462	17.943	2452.9804	2470.9237	
11n20MIMO	Ant8	2462	17.969	2452.9656	2470.9348	
11n40MIMO	Ant10	2422	36.41	2403.8112	2440.2215	
11n40MIMO	Ant8	2422	36.346	2403.8457	2440.1917	
11n40MIMO	Ant10	2437	36.424	2418.7436	2455.1672	
11n40MIMO	Ant8	2437	36.401	2418.7821	2455.1827	
11n40MIMO	Ant10	2452	36.43	2433.7094	2470.1396	
11n40MIMO	Ant8	2452	36.455	2433.6978	2470.1529	



Unless otherwise agreed in writing, this document is issued by the Company subject to its General Conditions of Service printed overleaf, available on request or accessible at <http://www.sgs.com/en/Terms-and-Conditions.aspx> and, for electronic format documents, subject to Terms and Conditions for Electronic Documents at <http://www.sgs.com/en/Terms-and-Conditions/Terms-e-Documents.aspx>. Attention is drawn to the limitation of liability, indemnification and jurisdiction issues defined therein. Any holder of this document is advised that information contained hereon reflects the Company's findings at the time of its intervention only and within the limits of Client's instructions, if any. The Company's sole responsibility is to its Client and this document does not exonerate parties to a transaction from exercising all their rights and obligations under the transaction documents. This document cannot be reproduced except in full, without prior written approval of the Company. Any unauthorized alteration, forgery or falsification of the content or appearance of this document is unlawful and offenders may be prosecuted to the fullest extent of the law. Unless otherwise stated the results shown in this test report refer only to the sample(s) tested and such sample(s) are retained for 30 days only.

Attention: To check the authenticity of testing/inspection report & certificate, please contact us at telephone: (86-755) 8307 1443, or email: [CN.Doccheck@sgs.com](mailto:CN.Doccheck@sgs.com)

South of No. 6 Plant, No. 1, Runsheng Road, Suzhou Industrial Park, Suzhou Area, China (Jiangsu) Pilot Free Trade Zone 215000 t (86-512) 62992980 www.sgs.com.cn  
 中国·苏州·中国(江苏)自由贸易试验区苏州片区苏州工业园区润胜路1号的6号厂房南楼 邮编: 215000 t (86-512) 62992980 sgs.china@sgs.com

Test Graphs

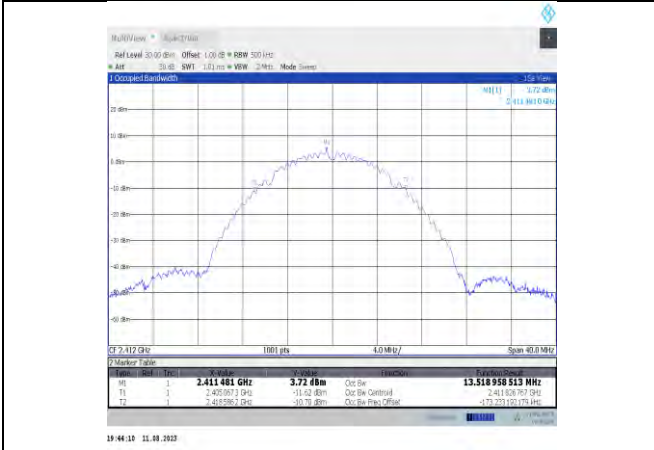

11b-CDD-Ant10-2412

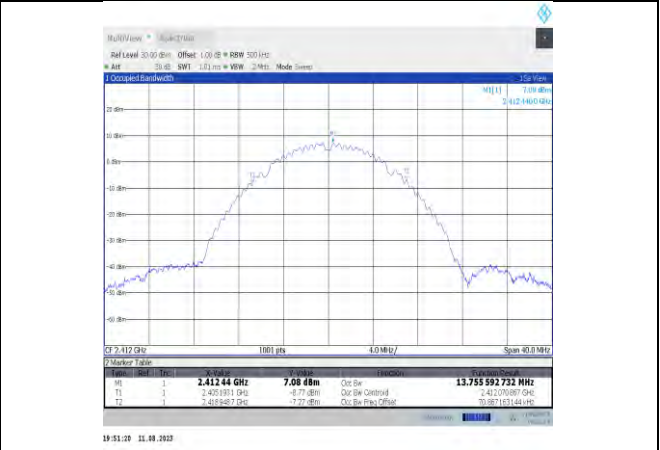

11b-CDD-Ant8-2412



11b-CDD-Ant10-2437

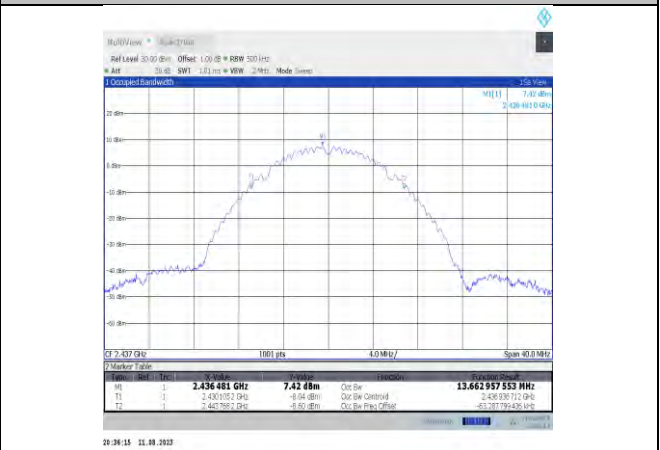

11b-CDD-Ant8-2437



11b-CDD-Ant10-2462



11b-CDD-Ant8-2462



Unless otherwise agreed in writing, this document is issued by the Company subject to its General Conditions of Service printed overleaf, available on request or accessible at <http://www.sgs.com/en/Terms-and-Conditions.aspx> and, for electronic format documents, subject to Terms and Conditions for Electronic Documents at <http://www.sgs.com/en/Terms-and-Conditions/Terms-e-Documents.aspx>. Attention is drawn to the limitation of liability, indemnification and jurisdiction issues defined therein. Any holder of this document is advised that information contained hereon reflects the Company's findings at the time of its intervention only and within the limits of Client's instructions, if any. The Company's sole responsibility is to its Client and this document does not exonerate parties to a transaction from exercising all their rights and obligations under the transaction documents. This document cannot be reproduced except in full, without prior written approval of the Company. Any unauthorized alteration, forgery or falsification of the content or appearance of this document is unlawful and offenders may be prosecuted to the fullest extent of the law. Unless otherwise stated the results shown in this test report refer only to the sample(s) tested and such sample(s) are retained for 30 days only.

**Attention: To check the authenticity of testing/inspection report & certificate, please contact us at telephone: (86-755) 8307 1443, or email: CN.Doccheck@sgs.com**

South of No. 6 Plant, No. 1, Runsheng Road, Suzhou Industrial Park, Suzhou Area, China (Jiangsu) Pilot Free Trade Zone 215000 t (86-512) 62992980 www.sgs.com.cn  
 中国·苏州·中国(江苏)自由贸易试验区苏州片区苏州工业园区润胜路1号的6号厂房南楼 邮编: 215000 t (86-512) 62992980 sgs.china@sgs.com



11g-CDD-Ant10-2412



11g-CDD-Ant8-2412



11g-CDD-Ant10-2437



11g-CDD-Ant8-2437



11g-CDD-Ant10-2462



11g-CDD-Ant8-2462



Unless otherwise agreed in writing, this document is issued by the Company subject to its General Conditions of Service printed overleaf, available on request or accessible at <http://www.sgs.com/en/Terms-and-Conditions.aspx>, and for electronic format documents, subject to Terms and Conditions for Electronic Documents at <http://www.sgs.com/en/Terms-and-Conditions/Terms-e-Documents.aspx>. Attention is drawn to the limitation of liability, indemnification and jurisdiction issues defined therein. Any holder of this document is advised that information contained hereon reflects the Company's findings at the time of its intervention only and within the limits of Client's instructions, if any. The Company's sole responsibility is to its Client and this document does not exonerate parties to a transaction from exercising all their rights and obligations under the transaction documents. This document cannot be reproduced except in full, without prior written approval of the Company. Any unauthorized alteration, forgery or falsification of the content or appearance of this document is unlawful and offenders may be prosecuted to the fullest extent of the law. Unless otherwise stated the results shown in this test report refer only to the sample(s) tested and such sample(s) are retained for 30 days only.

Attention: To check the authenticity of testing/inspection report & certificate, please contact us at telephone: (86-755) 8307 1443, or email: [CN.Doccheck@sgs.com](mailto:CN.Doccheck@sgs.com)

South of No. 6 Plant, No. 1, Runsheng Road, Suzhou Industrial Park, Suzhou Area, China (Jiangsu) Pilot Free Trade Zone 215000 t (86-512) 62992980 www.sgs.com.cn  
 中国·苏州·中国(江苏)自由贸易试验区苏州片区苏州工业园区润胜路1号的6号厂房南楼 邮编: 215000 t (86-512) 62992980 sgs.china@sgs.com





11n20MIMO-Ant10-2412



11n20MIMO-Ant8-2412



11n20MIMO-Ant10-2437



11n20MIMO-Ant8-2437



11n20MIMO-Ant10-2462



11n20MIMO-Ant8-2462



Unless otherwise agreed in writing, this document is issued by the Company subject to its General Conditions of Service printed overleaf, available on request or accessible at <http://www.sgs.com/en/Terms-and-Conditions.aspx>, and for electronic format documents, subject to Terms and Conditions for Electronic Documents at <http://www.sgs.com/en/Terms-and-Conditions/Terms-e-Document.aspx>. Attention is drawn to the limitation of liability, indemnification and jurisdiction issues defined therein. Any holder of this document is advised that information contained hereon reflects the Company's findings at the time of its intervention only and within the limits of Client's instructions, if any. The Company's sole responsibility is to its Client and this document does not exonerate parties to a transaction from exercising all their rights and obligations under the transaction documents. This document cannot be reproduced except in full, without prior written approval of the Company. Any unauthorized alteration, forgery or falsification of the content or appearance of this document is unlawful and offenders may be prosecuted to the fullest extent of the law. Unless otherwise stated the results shown in this test report refer only to the sample(s) tested and such sample(s) are retained for 30 days only.

Attention: To check the authenticity of testing/inspection report & certificate, please contact us at telephone: (86-755) 8307 1443, or email: [CN.Doccheck@sgs.com](mailto:CN.Doccheck@sgs.com)  
 South of No. 6 Plant, No. 1, Runsheng Road, Suzhou Industrial Park, Suzhou Area, China (Jiangsu) Pilot Free Trade Zone 215000 t (86-512) 62992980 www.sgs.com.cn  
 中国·苏州·中国(江苏)自由贸易试验区苏州片区苏州工业园区润胜路1号的6号厂房南楼 邮编: 215000 t (86-512) 62992980 sgs.china@sgs.com



11n40MIMO-Ant10-2422



11n40MIMO-Ant8-2422



11n40MIMO-Ant10-2437

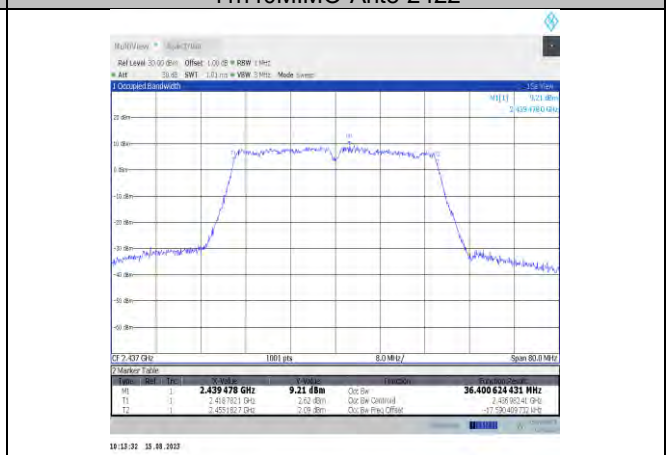

11n40MIMO-Ant8-2437



11n40MIMO-Ant10-2452

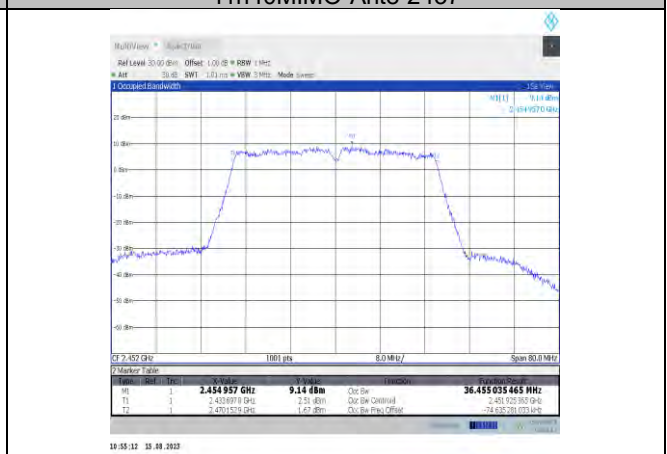

11n40MIMO-Ant8-2452



Unless otherwise agreed in writing, this document is issued by the Company subject to its General Conditions of Service printed overleaf, available on request or accessible at <http://www.sgs.com/en/Terms-and-Conditions.aspx>, and for electronic format documents, subject to Terms and Conditions for Electronic Documents at <http://www.sgs.com/en/Terms-and-Conditions/Terms-e-Documents.aspx>. Attention is drawn to the limitation of liability, indemnification and jurisdiction issues defined therein. Any holder of this document is advised that information contained hereon reflects the Company's findings at the time of its intervention only and within the limits of Client's instructions, if any. The Company's sole responsibility is to its Client and this document does not exonerate parties to a transaction from exercising all their rights and obligations under the transaction documents. This document cannot be reproduced except in full, without prior written approval of the Company. Any unauthorized alteration, forgery or falsification of the content or appearance of this document is unlawful and offenders may be prosecuted to the fullest extent of the law. Unless otherwise stated the results shown in this test report refer only to the sample(s) tested and such sample(s) are retained for 30 days only.

Attention: To check the authenticity of testing/inspection report & certificate, please contact us at telephone: (86-755) 8307 1443, or email: [CN.Doccheck@sgs.com](mailto:CN.Doccheck@sgs.com)

South of No. 6 Plant, No. 1, Runsheng Road, Suzhou Industrial Park, Suzhou Area, China (Jiangsu) Pilot Free Trade Zone 215000 t (86-512) 62992980 www.sgs.com.cn  
 中国·苏州·中国(江苏)自由贸易试验区苏州片区苏州工业园区润胜路1号的6号厂房南楼 邮编: 215000 t (86-512) 62992980 sgs.china@sgs.com

**Maximum conducted output power for SEWM2307000261RG05**  
**Test Result Peak**

TestMode	Antenna	Frequency[MHz]	Peak Power[dBm]	Conducted Limit[dBm]	Verdict
11b-CDD	Ant10	2412	18.14	≤30.00	PASS
11b-CDD	Ant8	2412	17.64	≤30.00	PASS
11b-CDD	total	2412	20.91	≤30.00	PASS
11b-CDD	Ant10	2437	18.16	≤30.00	PASS
11b-CDD	Ant8	2437	17.61	≤30.00	PASS
11b-CDD	total	2437	20.90	≤30.00	PASS
11b-CDD	Ant10	2462	18.10	≤30.00	PASS
11b-CDD	Ant8	2462	17.88	≤30.00	PASS
11b-CDD	total	2462	21.00	≤30.00	PASS
11g-CDD	Ant10	2412	20.32	≤30.00	PASS
11g-CDD	Ant8	2412	20.03	≤30.00	PASS
11g-CDD	total	2412	23.19	≤30.00	PASS
11g-CDD	Ant10	2437	20.31	≤30.00	PASS
11g-CDD	Ant8	2437	20.01	≤30.00	PASS
11g-CDD	total	2437	23.17	≤30.00	PASS
11g-CDD	Ant10	2462	20.39	≤30.00	PASS
11g-CDD	Ant8	2462	19.98	≤30.00	PASS
11g-CDD	total	2462	23.20	≤30.00	PASS
11n20MIMO	Ant10	2412	19.24	≤30.00	PASS
11n20MIMO	Ant8	2412	19.09	≤30.00	PASS
11n20MIMO	total	2412	22.17	≤30.00	PASS
11n20MIMO	Ant10	2437	19.16	≤30.00	PASS
11n20MIMO	Ant8	2437	19.09	≤30.00	PASS
11n20MIMO	total	2437	22.14	≤30.00	PASS
11n20MIMO	Ant10	2462	19.32	≤30.00	PASS
11n20MIMO	Ant8	2462	19.11	≤30.00	PASS
11n20MIMO	total	2462	22.23	≤30.00	PASS
11n40MIMO	Ant10	2422	19.99	≤30.00	PASS
11n40MIMO	Ant8	2422	19.98	≤30.00	PASS
11n40MIMO	total	2422	23.00	≤30.00	PASS
11n40MIMO	Ant10	2437	19.84	≤30.00	PASS
11n40MIMO	Ant8	2437	19.74	≤30.00	PASS
11n40MIMO	total	2437	22.80	≤30.00	PASS
11n40MIMO	Ant10	2452	19.92	≤30.00	PASS
11n40MIMO	Ant8	2452	19.21	≤30.00	PASS
11n40MIMO	total	2452	22.59	≤30.00	PASS



Unless otherwise agreed in writing, this document is issued by the Company subject to its General Conditions of Service printed overleaf, available on request or accessible at <http://www.sgs.com/en/Terms-and-Conditions.aspx> and, for electronic format documents, subject to Terms and Conditions for Electronic Documents at <http://www.sgs.com/en/Terms-and-Conditions/Terms-e-Documents.aspx>. Attention is drawn to the limitation of liability, indemnification and jurisdiction issues defined therein. Any holder of this document is advised that information contained hereon reflects the Company's findings at the time of its intervention only and within the limits of Client's instructions, if any. The Company's sole responsibility is to its Client and this document does not exonerate parties to a transaction from exercising all their rights and obligations under the transaction documents. This document cannot be reproduced except in full, without prior written approval of the Company. Any unauthorized alteration, forgery or falsification of the content or appearance of this document is unlawful and offenders may be prosecuted to the fullest extent of the law. Unless otherwise stated the results shown in this test report refer only to the sample(s) tested and such sample(s) are retained for 30 days only.

Attention: To check the authenticity of testing/inspection report & certificate, please contact us at telephone: (86-755) 8307 1443, or email: [CN.Doccheck@sgs.com](mailto:CN.Doccheck@sgs.com)

South of No. 6 Plant, No. 1, Runsheng Road, Suzhou Industrial Park, Suzhou Area, China (Jiangsu) Pilot Free Trade Zone 215000 t (86-512) 62992980 www.sgs.com.cn  
 中国·苏州·中国(江苏)自由贸易试验区苏州片区苏州工业园区润胜路1号的6号厂房南楼 邮编: 215000 t (86-512) 62992980 sgs.china@sgs.com

**Maximum conducted output power for SEWM2309000395RG05**  
**Test Result Peak**

TestMode	Antenna	Frequency[MHz]	Peak Power[dBm]	Conducted Limit[dBm]	Verdict
11b-CDD	Ant10	2412	17.60	≤30.00	PASS
11b-CDD	Ant8	2412	18.03	≤30.00	PASS
11b-CDD	total	2412	20.83	≤30.00	PASS
11b-CDD	Ant10	2437	17.58	≤30.00	PASS
11b-CDD	Ant8	2437	18.01	≤30.00	PASS
11b-CDD	total	2437	20.81	≤30.00	PASS
11b-CDD	Ant10	2462	17.88	≤30.00	PASS
11b-CDD	Ant8	2462	17.84	≤30.00	PASS
11b-CDD	total	2462	20.87	≤30.00	PASS
11g-CDD	Ant10	2412	20.01	≤30.00	PASS
11g-CDD	Ant8	2412	20.30	≤30.00	PASS
11g-CDD	total	2412	23.17	≤30.00	PASS
11g-CDD	Ant10	2437	20.03	≤30.00	PASS
11g-CDD	Ant8	2437	20.28	≤30.00	PASS
11g-CDD	total	2437	23.17	≤30.00	PASS
11g-CDD	Ant10	2462	20.00	≤30.00	PASS
11g-CDD	Ant8	2462	20.37	≤30.00	PASS
11g-CDD	total	2462	23.20	≤30.00	PASS
11n20MIMO	Ant10	2412	19.05	≤30.00	PASS
11n20MIMO	Ant8	2412	19.23	≤30.00	PASS
11n20MIMO	total	2412	22.15	≤30.00	PASS
11n20MIMO	Ant10	2437	19.07	≤30.00	PASS
11n20MIMO	Ant8	2437	19.19	≤30.00	PASS
11n20MIMO	total	2437	22.14	≤30.00	PASS
11n20MIMO	Ant10	2462	19.10	≤30.00	PASS
11n20MIMO	Ant8	2462	19.30	≤30.00	PASS
11n20MIMO	total	2462	22.21	≤30.00	PASS
11n40MIMO	Ant10	2422	19.87	≤30.00	PASS
11n40MIMO	Ant8	2422	19.97	≤30.00	PASS
11n40MIMO	total	2422	22.93	≤30.00	PASS
11n40MIMO	Ant10	2437	19.64	≤30.00	PASS
11n40MIMO	Ant8	2437	19.83	≤30.00	PASS
11n40MIMO	total	2437	22.75	≤30.00	PASS
11n40MIMO	Ant10	2452	19.61	≤30.00	PASS
11n40MIMO	Ant8	2452	19.89	≤30.00	PASS
11n40MIMO	total	2452	22.76	≤30.00	PASS



Unless otherwise agreed in writing, this document is issued by the Company subject to its General Conditions of Service printed overleaf, available on request or accessible at <http://www.sgs.com/en/Terms-and-Conditions.aspx> and, for electronic format documents, subject to Terms and Conditions for Electronic Documents at <http://www.sgs.com/en/Terms-and-Conditions/Terms-e-Documents.aspx>. Attention is drawn to the limitation of liability, indemnification and jurisdiction issues defined therein. Any holder of this document is advised that information contained hereon reflects the Company's findings at the time of its intervention only and within the limits of Client's instructions, if any. The Company's sole responsibility is to its Client and this document does not exonerate parties to a transaction from exercising all their rights and obligations under the transaction documents. This document cannot be reproduced except in full, without prior written approval of the Company. Any unauthorized alteration, forgery or falsification of the content or appearance of this document is unlawful and offenders may be prosecuted to the fullest extent of the law. Unless otherwise stated the results shown in this test report refer only to the sample(s) tested and such sample(s) are retained for 30 days only.

Attention: To check the authenticity of testing/inspection report & certificate, please contact us at telephone: (86-755) 8307 1443, or email: [CN.Doccheck@sgs.com](mailto:CN.Doccheck@sgs.com)

South of No. 6 Plant, No. 1, Runsheng Road, Suzhou Industrial Park, Suzhou Area, China (Jiangsu) Pilot Free Trade Zone 215000 t (86-512) 62992980 www.sgs.com.cn  
 中国·苏州·中国(江苏)自由贸易试验区苏州片区苏州工业园区润胜路1号的6号厂房南楼 邮编: 215000 t (86-512) 62992980 sgs.china@sgs.com

**Maximum power spectral density  
Test Result**

TestMode	Antenna	Frequency[MHz]	Result[dBm/3kHz]	Limit[dBm/3kHz]	Verdict
11b-CDD	Ant10	2412	-9.12	≤8.00	PASS
11b-CDD	Ant8	2412	-9.66	≤8.00	PASS
11b-CDD	total	2412	-6.37	≤8.00	PASS
11b-CDD	Ant10	2437	-10.08	≤8.00	PASS
11b-CDD	Ant8	2437	-10.41	≤8.00	PASS
11b-CDD	total	2437	-7.23	≤8.00	PASS
11b-CDD	Ant10	2462	-11.29	≤8.00	PASS
11b-CDD	Ant8	2462	-10.07	≤8.00	PASS
11b-CDD	total	2462	-7.63	≤8.00	PASS
11g-CDD	Ant10	2412	-10.87	≤8.00	PASS
11g-CDD	Ant8	2412	-10.78	≤8.00	PASS
11g-CDD	total	2412	-7.81	≤8.00	PASS
11g-CDD	Ant10	2437	-11.09	≤8.00	PASS
11g-CDD	Ant8	2437	-10.42	≤8.00	PASS
11g-CDD	total	2437	-7.73	≤8.00	PASS
11g-CDD	Ant10	2462	-11.73	≤8.00	PASS
11g-CDD	Ant8	2462	-11.07	≤8.00	PASS
11g-CDD	total	2462	-8.38	≤8.00	PASS
11n20MIMO	Ant10	2412	-11.26	≤8.00	PASS
11n20MIMO	Ant8	2412	-10.92	≤8.00	PASS
11n20MIMO	total	2412	-8.08	≤8.00	PASS
11n20MIMO	Ant10	2437	-11.52	≤8.00	PASS
11n20MIMO	Ant8	2437	-11.00	≤8.00	PASS
11n20MIMO	total	2437	-8.24	≤8.00	PASS
11n20MIMO	Ant10	2462	-9.82	≤8.00	PASS
11n20MIMO	Ant8	2462	-10.57	≤8.00	PASS
11n20MIMO	total	2462	-7.17	≤8.00	PASS
11n40MIMO	Ant10	2422	-13.49	≤8.00	PASS
11n40MIMO	Ant8	2422	-13.14	≤8.00	PASS
11n40MIMO	total	2422	-10.30	≤8.00	PASS
11n40MIMO	Ant10	2437	-14.15	≤8.00	PASS
11n40MIMO	Ant8	2437	-13.74	≤8.00	PASS
11n40MIMO	total	2437	-10.93	≤8.00	PASS
11n40MIMO	Ant10	2452	-15.32	≤8.00	PASS
11n40MIMO	Ant8	2452	-14.53	≤8.00	PASS
11n40MIMO	total	2452	-11.90	≤8.00	PASS



Unless otherwise agreed in writing, this document is issued by the Company subject to its General Conditions of Service printed overleaf, available on request or accessible at <http://www.sgs.com/en/Terms-and-Conditions.aspx> and, for electronic format documents, subject to Terms and Conditions for Electronic Documents at <http://www.sgs.com/en/Terms-and-Conditions/Terms-e-Documents.aspx>. Attention is drawn to the limitation of liability, indemnification and jurisdiction issues defined therein. Any holder of this document is advised that information contained hereon reflects the Company's findings at the time of its intervention only and within the limits of Client's instructions, if any. The Company's sole responsibility is to its Client and this document does not exonerate parties to a transaction from exercising all their rights and obligations under the transaction documents. This document cannot be reproduced except in full, without prior written approval of the Company. Any unauthorized alteration, forgery or falsification of the content or appearance of this document is unlawful and offenders may be prosecuted to the fullest extent of the law. Unless otherwise stated the results shown in this test report refer only to the sample(s) tested and such sample(s) are retained for 30 days only.

Attention: To check the authenticity of testing/inspection report & certificate, please contact us at telephone: (86-755) 8307 1443, or email: [CN.Doccheck@sgs.com](mailto:CN.Doccheck@sgs.com)

South of No. 6 Plant, No. 1, Runsheng Road, Suzhou Industrial Park, Suzhou Area, China (Jiangsu) Pilot Free Trade Zone 215000  
 中国·苏州·中国(江苏)自由贸易试验区苏州片区苏州工业园区润胜路1号的6号厂房南楼 邮编: 215000

t (86-512) 62992980 www.sgs.com.cn  
 t (86-512) 62992980 sgs.china@sgs.com

Test Graphs

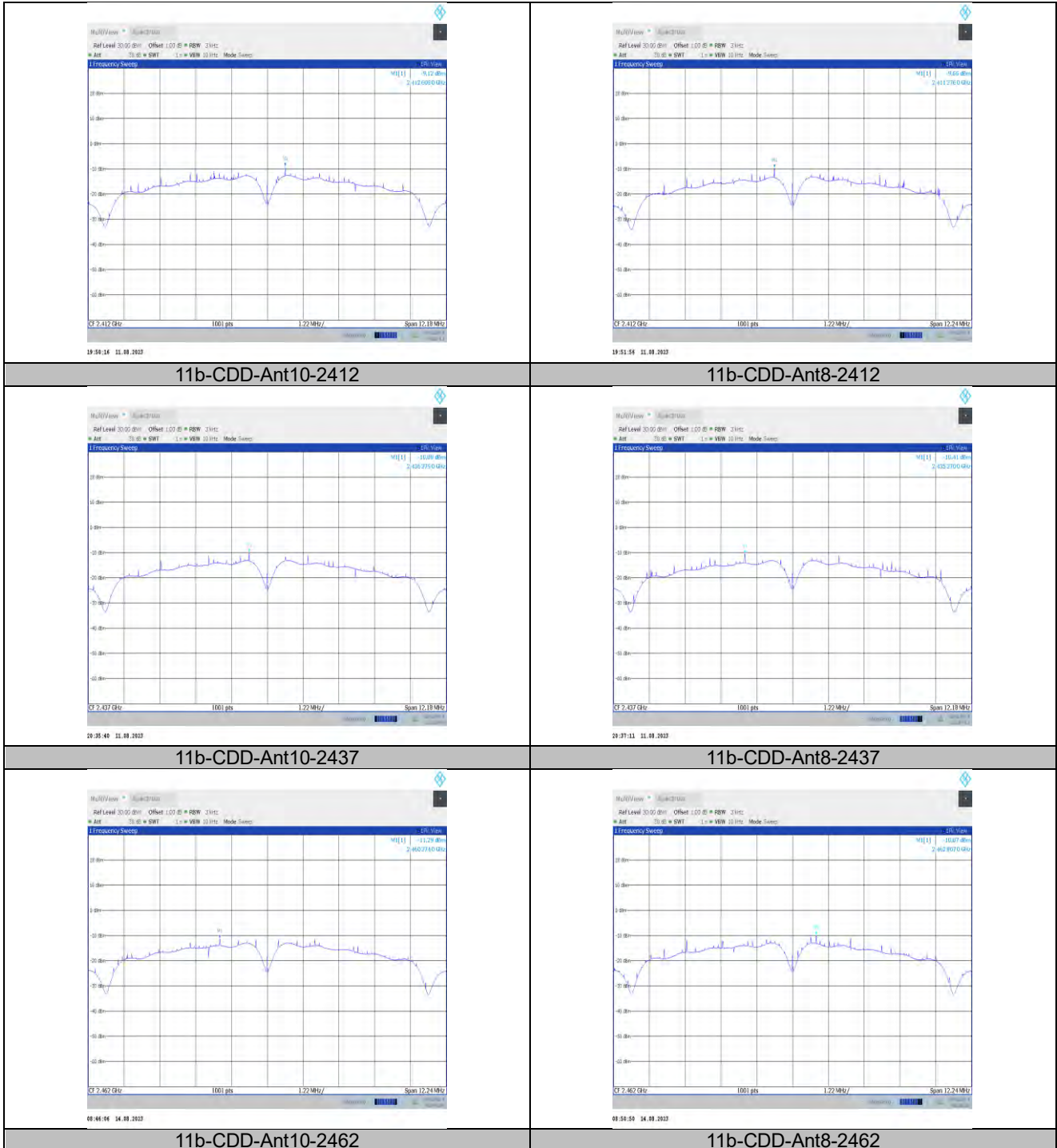

Unless otherwise agreed in writing, this document is issued by the Company subject to its General Conditions of Service printed overleaf, available on request or accessible at <http://www.sgs.com/en/Terms-and-Conditions.aspx> and, for electronic format documents, subject to Terms and Conditions for Electronic Documents at <http://www.sgs.com/en/Terms-and-Conditions/Terms-e-Document.aspx>. Attention is drawn to the limitation of liability, indemnification and jurisdiction issues defined therein. Any holder of this document is advised that information contained hereon reflects the Company's findings at the time of its intervention only and within the limits of Client's instructions, if any. The Company's sole responsibility is to its Client and this document does not exonerate parties to a transaction from exercising all their rights and obligations under the transaction documents. This document cannot be reproduced except in full, without prior written approval of the Company. Any unauthorized alteration, forgery or falsification of the content or appearance of this document is unlawful and offenders may be prosecuted to the fullest extent of the law. Unless otherwise stated the results shown in this test report refer only to the sample(s) tested and such sample(s) are retained for 30 days only.

Attention: To check the authenticity of testing/inspection report & certificate, please contact us at telephone: (86-755) 8307 1443, or email: [CN.Doccheck@sgs.com](mailto:CN.Doccheck@sgs.com)

South of No. 6 Plant, No. 1, Runsheng Road, Suzhou Industrial Park, Suzhou Area, China (Jiangsu) Pilot Free Trade Zone 215000 t (86-512) 62992980 www.sgs.com.cn  
 中国·苏州·中国(江苏)自由贸易试验区苏州片区苏州工业园区润胜路1号的6号厂房南楼 邮编: 215000 t (86-512) 62992980 sgs.china@sgs.com

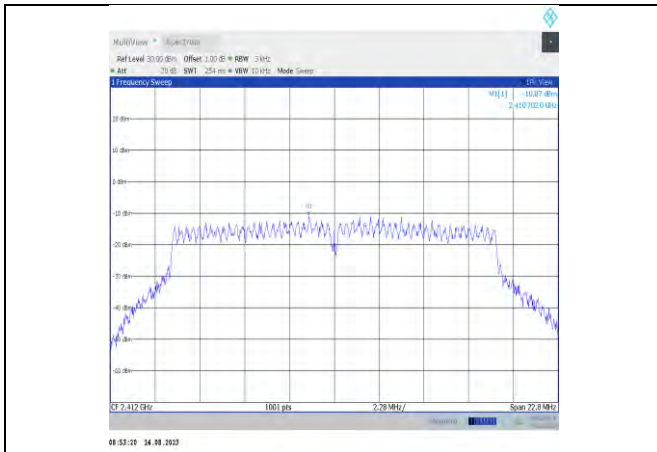

11g-CDD-Ant10-2412

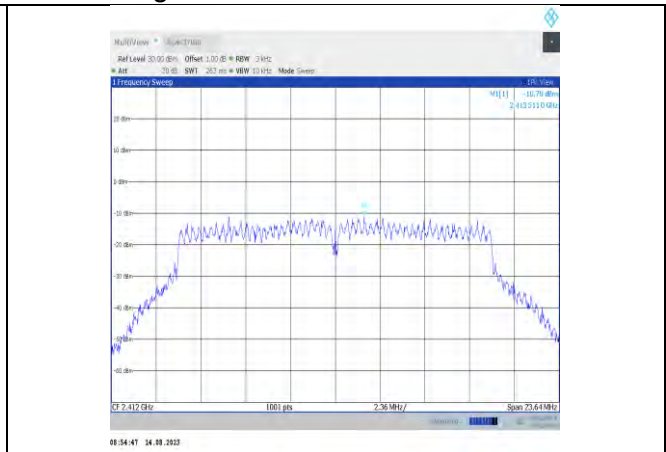

11g-CDD-Ant8-2412

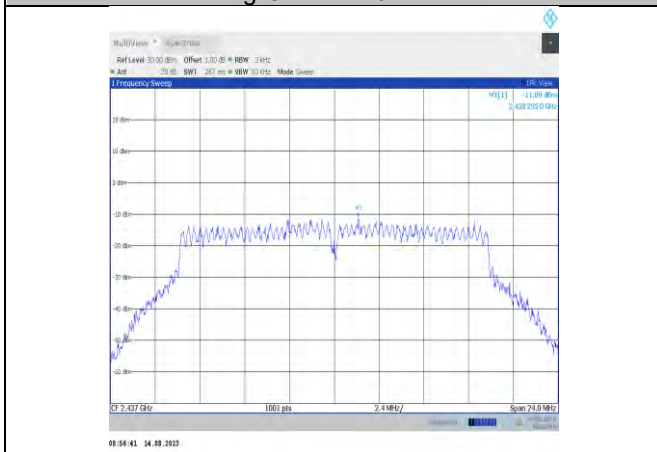

11g-CDD-Ant10-2437

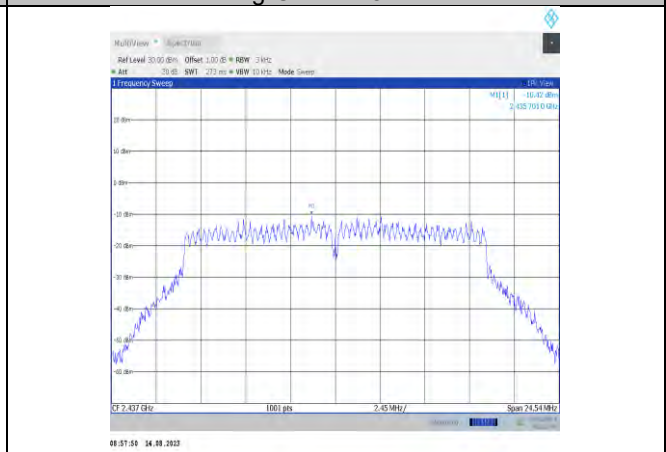

11g-CDD-Ant8-2437

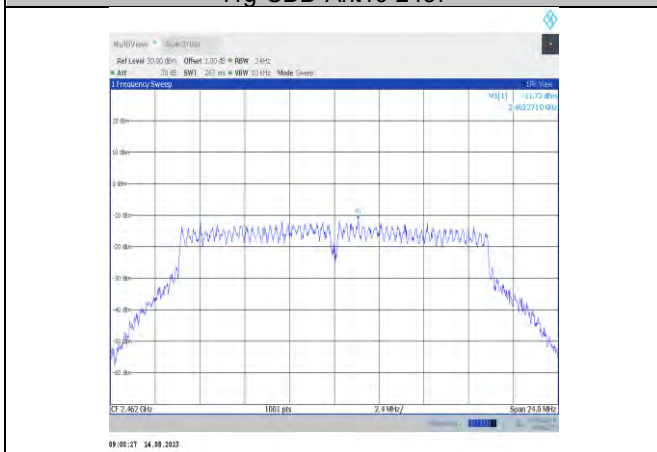

11g-CDD-Ant10-2462

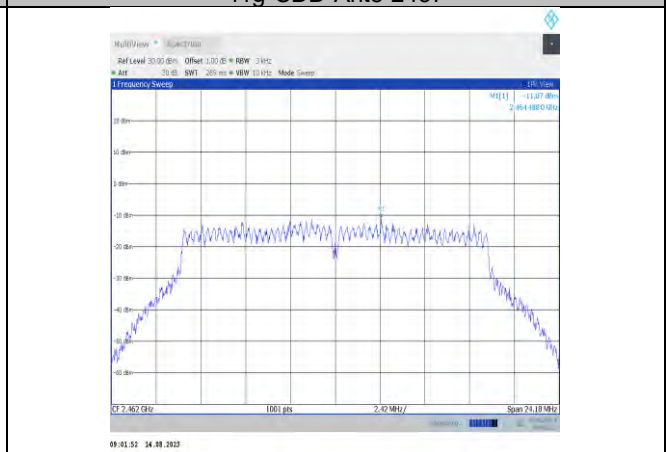

11g-CDD-Ant8-2462



Unless otherwise agreed in writing, this document is issued by the Company subject to its General Conditions of Service printed overleaf, available on request or accessible at <http://www.sgs.com/en/Terms-and-Conditions.aspx> and, for electronic format documents, subject to Terms and Conditions for Electronic Documents at <http://www.sgs.com/en/Terms-and-Conditions/Terms-e-Documents.aspx>. Attention is drawn to the limitation of liability, indemnification and jurisdiction issues defined therein. Any holder of this document is advised that information contained hereon reflects the Company's findings at the time of its intervention only and within the limits of Client's instructions, if any. The Company's sole responsibility is to its Client and this document does not exonerate parties to a transaction from exercising all their rights and obligations under the transaction documents. This document cannot be reproduced except in full, without prior written approval of the Company. Any unauthorized alteration, forgery or falsification of the content or appearance of this document is unlawful and offenders may be prosecuted to the fullest extent of the law. Unless otherwise stated the results shown in this test report refer only to the sample(s) tested and such sample(s) are retained for 30 days only.

Attention: To check the authenticity of testing/inspection report & certificate, please contact us at telephone: (86-755) 8307 1443, or email: [CN.Doccheck@sgs.com](mailto:CN.Doccheck@sgs.com)  
 South of No. 6 Plant, No. 1, Runsheng Road, Suzhou Industrial Park, Suzhou Area, China (Jiangsu) Pilot Free Trade Zone 215000 t (86-512) 62992980 www.sgs.com.cn  
 中国·苏州·中国(江苏)自由贸易试验区苏州片区苏州工业园区润胜路1号的6号厂房南座 邮编: 215000 t (86-512) 62992980 sgs.china@sgs.com

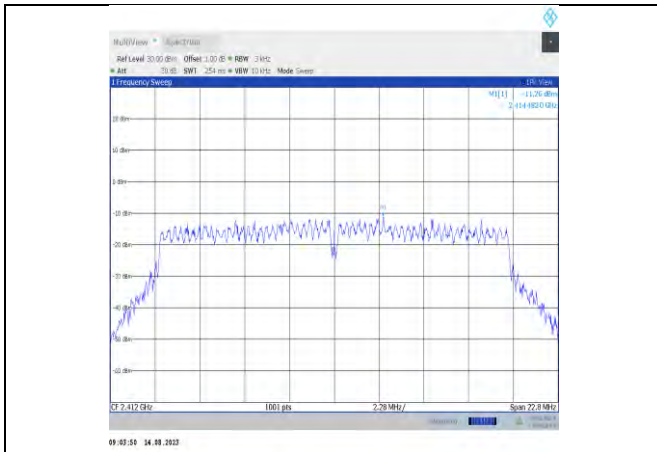

11n20MIMO-Ant10-2412

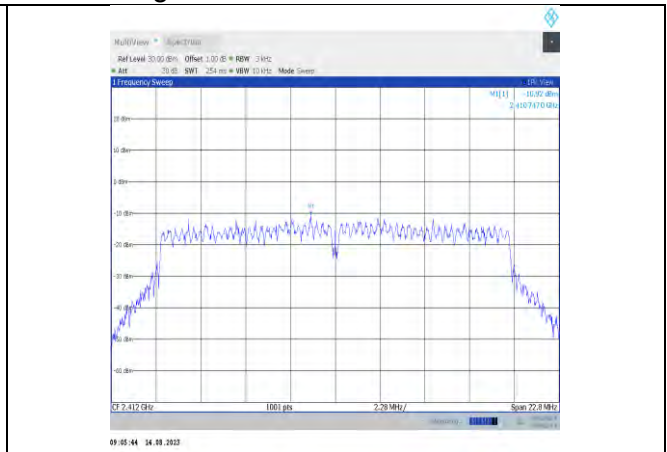

11n20MIMO-Ant8-2412

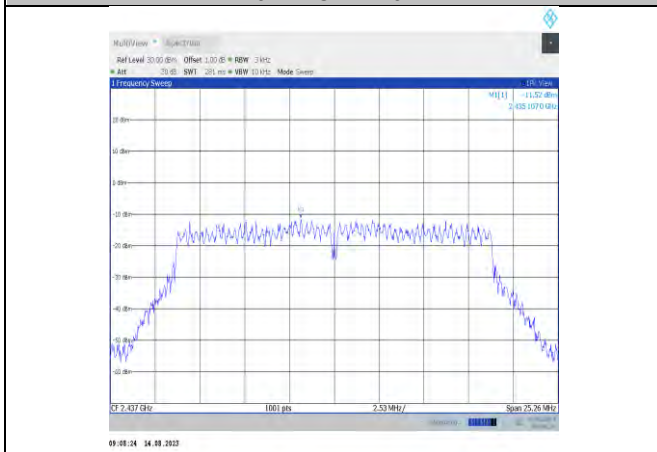

11n20MIMO-Ant10-2437

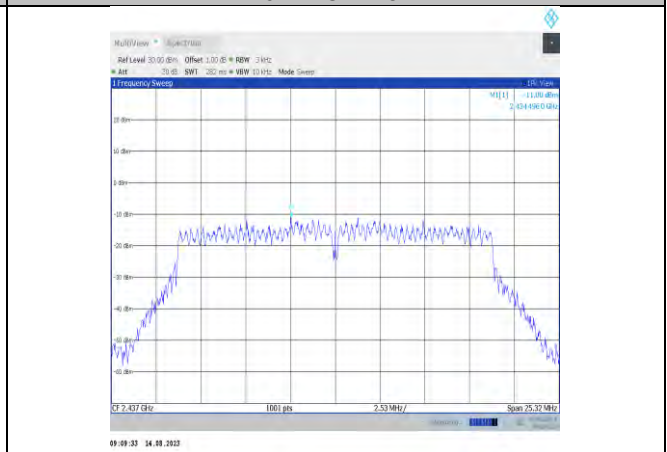

11n20MIMO-Ant8-2437

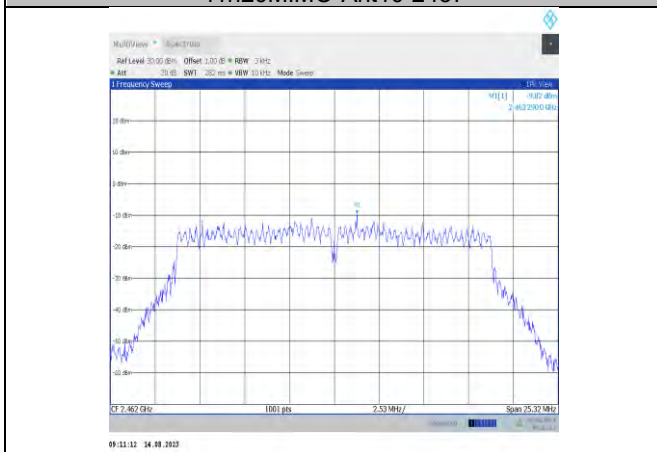

11n20MIMO-Ant10-2462

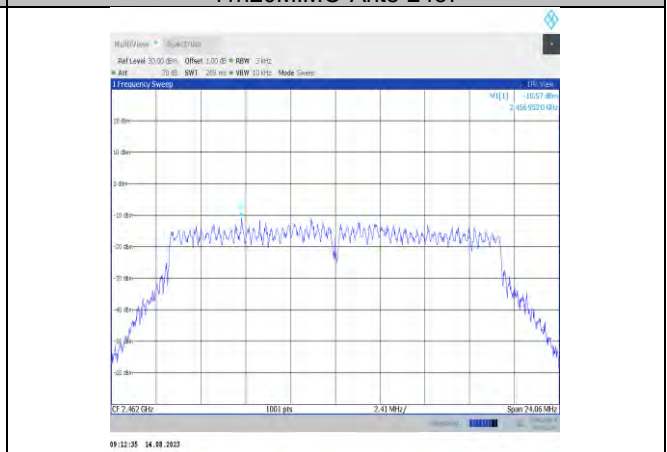

11n20MIMO-Ant8-2462



Unless otherwise agreed in writing, this document is issued by the Company subject to its General Conditions of Service printed overleaf, available on request or accessible at <http://www.sgs.com/en/Terms-and-Conditions.aspx> and, for electronic format documents, subject to Terms and Conditions for Electronic Documents at <http://www.sgs.com/en/Terms-and-Conditions/Terms-e-Document.aspx>. Attention is drawn to the limitation of liability, indemnification and jurisdiction issues defined therein. Any holder of this document is advised that information contained hereon reflects the Company's findings at the time of its intervention only and within the limits of Client's instructions, if any. The Company's sole responsibility is to its Client and this document does not exonerate parties to a transaction from exercising all their rights and obligations under the transaction documents. This document cannot be reproduced except in full, without prior written approval of the Company. Any unauthorized alteration, forgery or falsification of the content or appearance of this document is unlawful and offenders may be prosecuted to the fullest extent of the law. Unless otherwise stated the results shown in this test report refer only to the sample(s) tested and such sample(s) are retained for 30 days only.

Attention: To check the authenticity of testing/inspection report & certificate, please contact us at telephone: (86-755) 8307 1443, or email: [CN.Doccheck@sgs.com](mailto:CN.Doccheck@sgs.com)

South of No. 6 Plant, No. 1, Runsheng Road, Suzhou Area, China (Jiangsu) Pilot Free Trade Zone 215000 t (86-512) 62992980 www.sgs.com.cn  
 中国·苏州·中国(江苏)自由贸易试验区苏州片区苏州工业园区润胜路1号的6号厂房南楼 邮编: 215000 t (86-512) 62992980 sgs.china@sgs.com



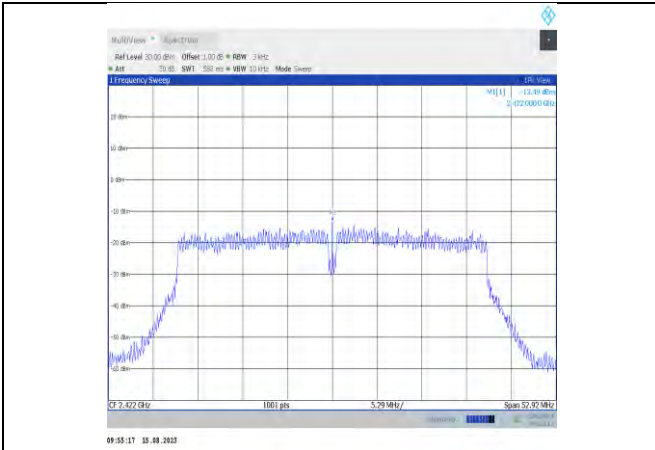

11n40MIMO-Ant10-2422

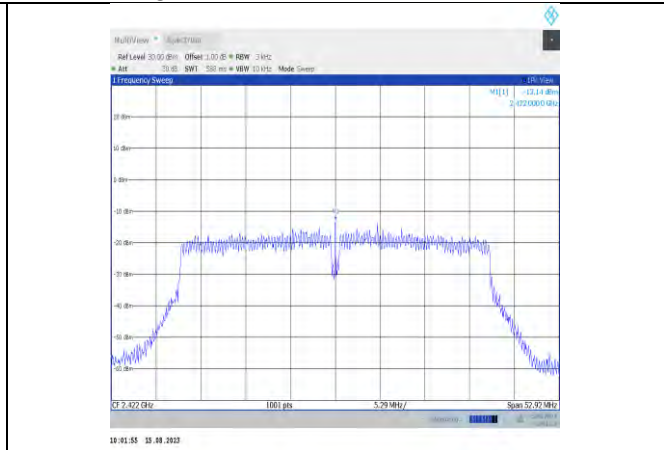

11n40MIMO-Ant8-2422

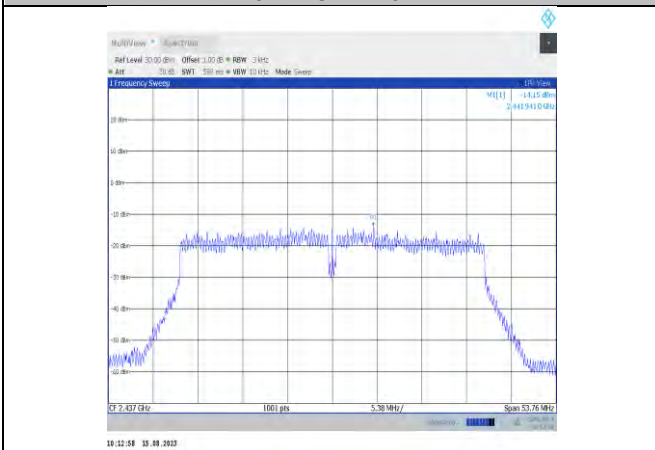

11n40MIMO-Ant10-2437

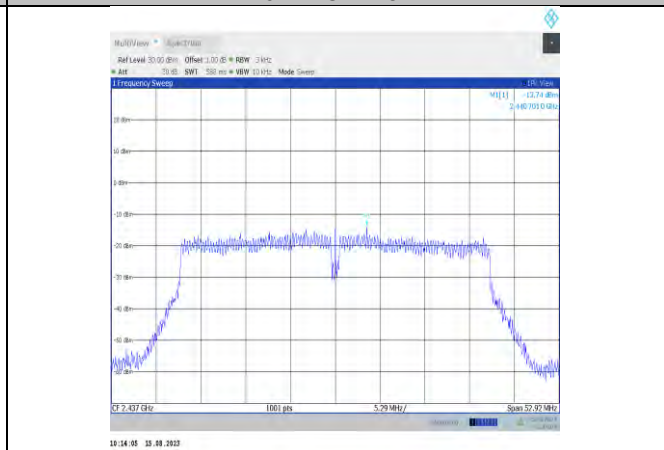

11n40MIMO-Ant8-2437

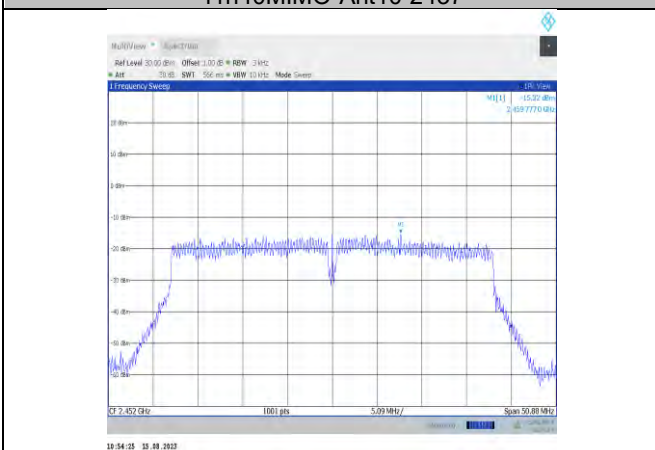

11n40MIMO-Ant10-2452

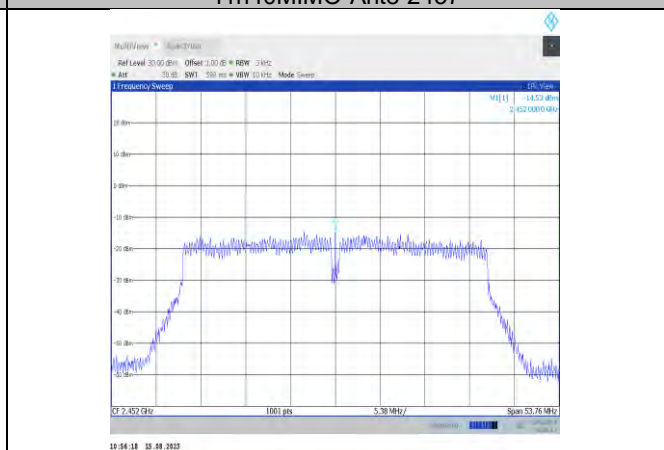

11n40MIMO-Ant8-2452



Unless otherwise agreed in writing, this document is issued by the Company subject to its General Conditions of Service printed overleaf, available on request or accessible at <http://www.sgs.com/en/Terms-and-Conditions.aspx> and, for electronic format documents, subject to Terms and Conditions for Electronic Documents at <http://www.sgs.com/en/Terms-and-Conditions/Terms-e-Documents.aspx>. Attention is drawn to the limitation of liability, indemnification and jurisdiction issues defined therein. Any holder of this document is advised that information contained hereon reflects the Company's findings at the time of its intervention only and within the limits of Client's instructions, if any. The Company's sole responsibility is to its Client and this document does not exonerate parties to a transaction from exercising all their rights and obligations under the transaction documents. This document cannot be reproduced except in full, without prior written approval of the Company. Any unauthorized alteration, forgery or falsification of the content or appearance of this document is unlawful and offenders may be prosecuted to the fullest extent of the law. Unless otherwise stated the results shown in this test report refer only to the sample(s) tested and such sample(s) are retained for 30 days only.

Attention: To check the authenticity of testing/inspection report & certificate, please contact us at telephone: (86-755) 8307 1443, or email: [CN.Doccheck@sgs.com](mailto:CN.Doccheck@sgs.com)  
 South of No. 6 Plant, No. 1, Runsheng Road, Suzhou Industrial Park, Suzhou Area, China (Jiangsu) Pilot Free Trade Zone 215000 t (86-512) 62992980 www.sgs.com.cn  
 中国·苏州·中国(江苏)自由贸易试验区苏州片区苏州工业园区润胜路1号的6号厂房南座 邮编: 215000 t (86-512) 62992980 sgs.china@sgs.com

### Band edge measurements Test Graphs

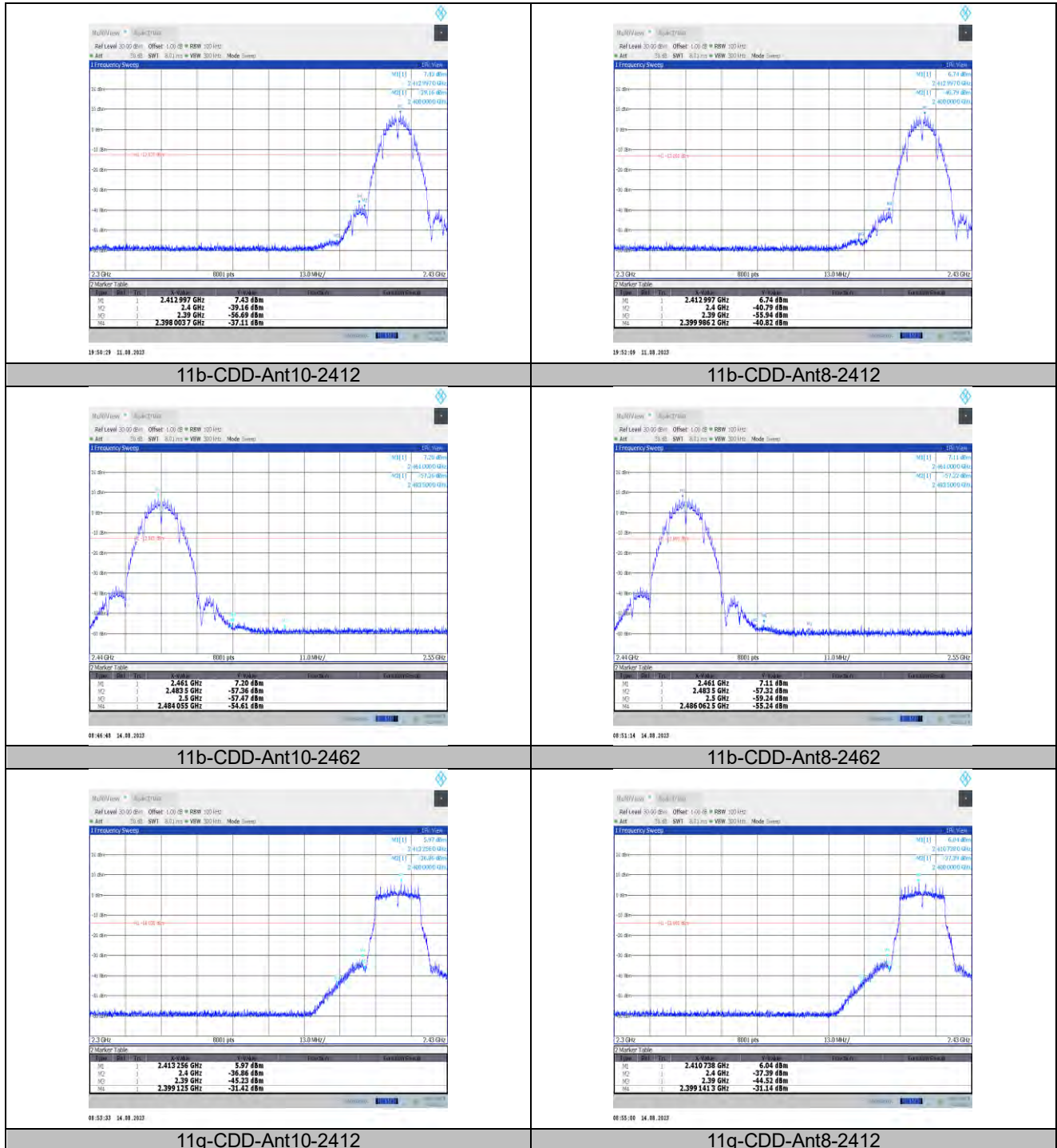

Unless otherwise agreed in writing, this document is issued by the Company subject to its General Conditions of Service printed overleaf, available on request or accessible at <http://www.sgs.com/en/Terms-and-Conditions.aspx> and, for electronic format documents, subject to Terms and Conditions for Electronic Documents at <http://www.sgs.com/en/Terms-and-Conditions/Terms-e-Documents.aspx>. Attention is drawn to the limitation of liability, indemnification and jurisdiction issues defined therein. Any holder of this document is advised that information contained hereon reflects the Company's findings at the time of its intervention only and within the limits of Client's instructions, if any. The Company's sole responsibility is to its Client and this document does not exonerate parties to a transaction from exercising all their rights and obligations under the transaction documents. This document cannot be reproduced except in full, without prior written approval of the Company. Any unauthorized alteration, forgery or falsification of the content or appearance of this document is unlawful and offenders may be prosecuted to the fullest extent of the law. Unless otherwise stated the results shown in this test report refer only to the sample(s) tested and such sample(s) are retained for 30 days only.

Attention: To check the authenticity of testing/inspection report & certificate, please contact us at telephone: (86-755) 8307 1443, or email: [CN.Doccheck@sgs.com](mailto:CN.Doccheck@sgs.com)

South of No. 6 Plant, No. 1, Runsheng Road, Suzhou Industrial Park, Suzhou Area, China (Jiangsu) Pilot Free Trade Zone      215000      t (86-512) 62992980      www.sgs.com.cn  
 中国·苏州·中国(江苏)自由贸易试验区苏州片区苏州工业园区润胜路1号的6号厂房南楼      邮编: 215000      t (86-512) 62992980      sgs.china@sgs.com

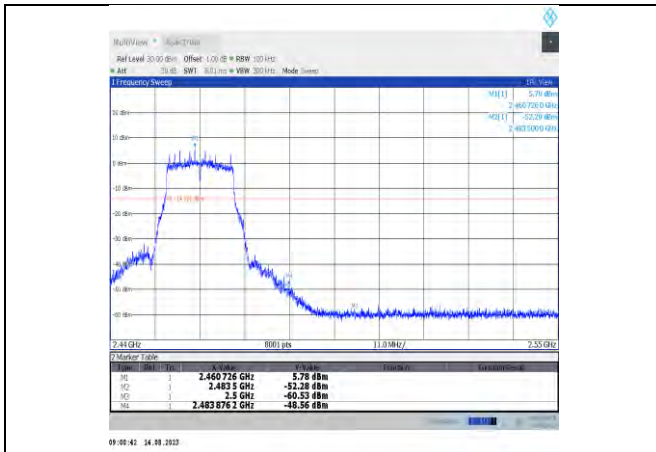

11g-CDD-Ant10-2462

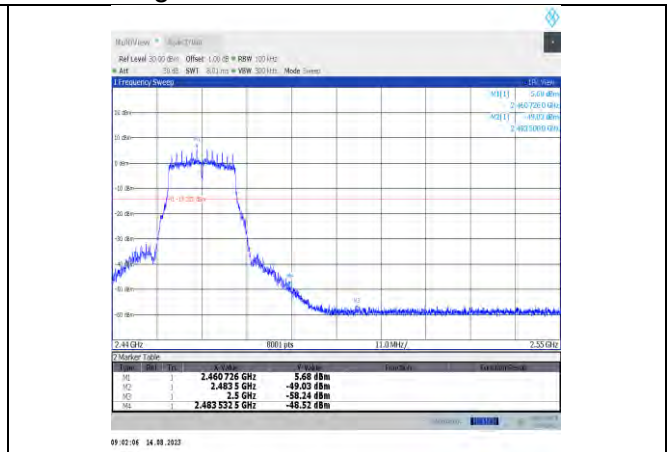

11g-CDD-Ant8-2462

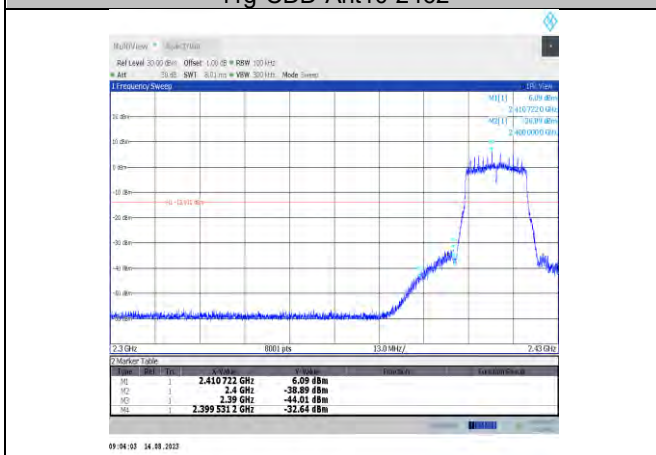

11n20MIMO-Ant10-2412

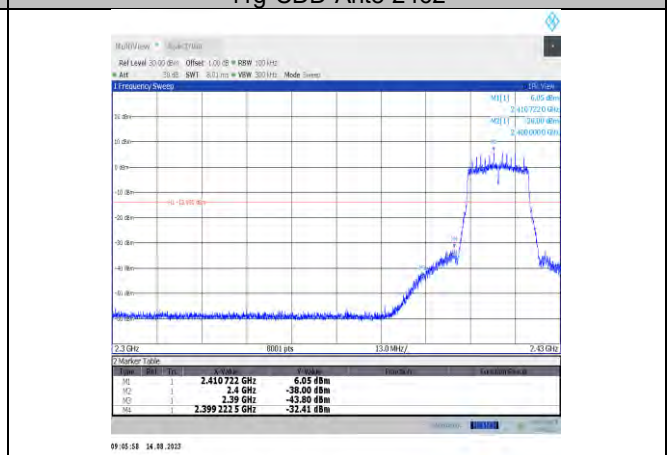

11n20MIMO-Ant8-2412

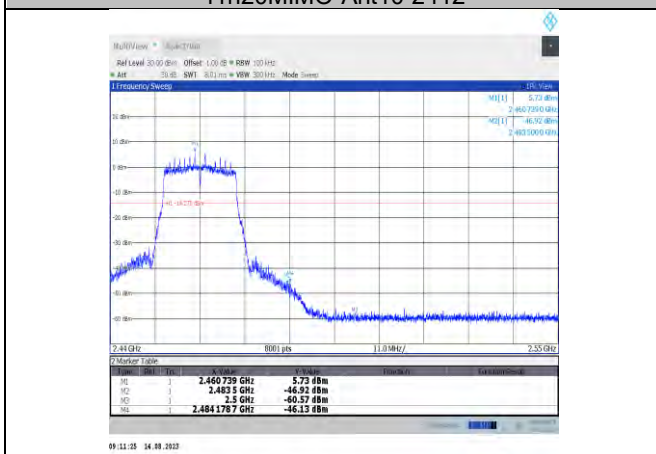

11n20MIMO-Ant10-2462

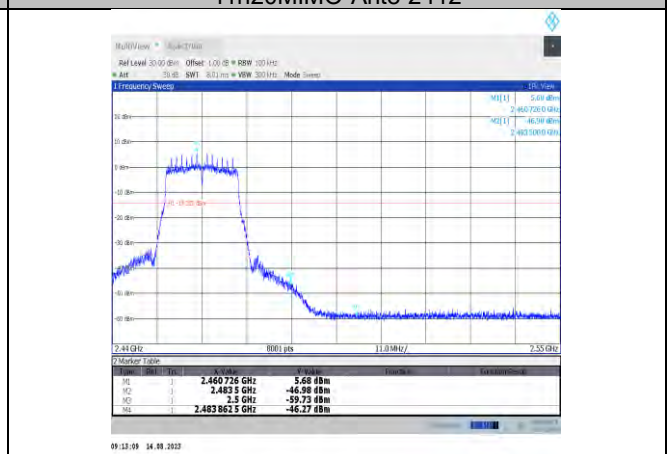

11n20MIMO-Ant8-2462



Unless otherwise agreed in writing, this document is issued by the Company subject to its General Conditions of Service printed overleaf, available on request or accessible at <http://www.sgs.com/en/Terms-and-Conditions.aspx> and, for electronic format documents, subject to Terms and Conditions for Electronic Documents at <http://www.sgs.com/en/Terms-and-Conditions/Terms-e-Documents.aspx>. Attention is drawn to the limitation of liability, indemnification and jurisdiction issues defined therein. Any holder of this document is advised that information contained hereon reflects the Company's findings at the time of its intervention only and within the limits of Client's instructions, if any. The Company's sole responsibility is to its Client and this document does not exonerate parties to a transaction from exercising all their rights and obligations under the transaction documents. This document cannot be reproduced except in full, without prior written approval of the Company. Any unauthorized alteration, forgery or falsification of the content or appearance of this document is unlawful and offenders may be prosecuted to the fullest extent of the law. Unless otherwise stated the results shown in this test report refer only to the sample(s) tested and such sample(s) are retained for 30 days only.

Attention: To check the authenticity of testing/inspection report & certificate, please contact us at telephone: (86-756) 83071443, or email: [CN.Doccheck@sgs.com](mailto:CN.Doccheck@sgs.com)  
 South of No. 6 Plant, No. 1, Runsheng Road, Suzhou Industrial Park, Suzhou Area, China (Jiangsu) Pilot Free Trade Zone 215000 t (86-512) 62992980 www.sgs.com.cn  
 中国·苏州·中国(江苏)自由贸易试验区苏州片区苏州工业园区润胜路1号的6号厂房南楼 邮编: 215000 t (86-512) 62992980 sgs.china@sgs.com

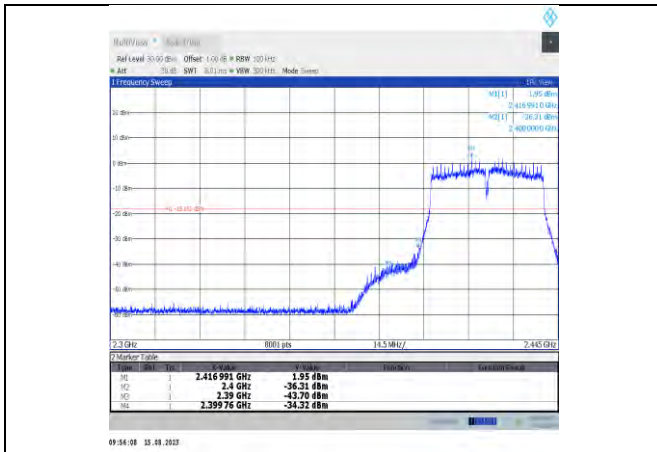

11n40MIMO-Ant10-2422

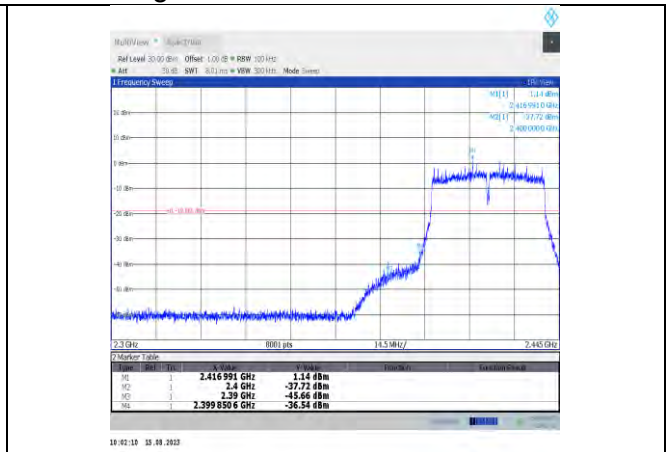

11n40MIMO-Ant8-2422

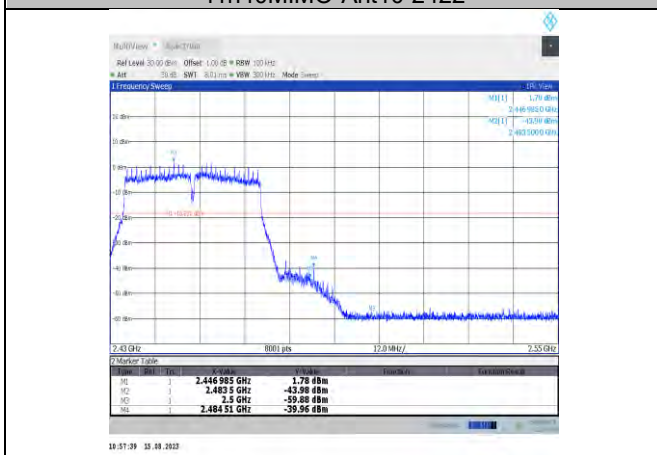

11n40MIMO-Ant10-2452

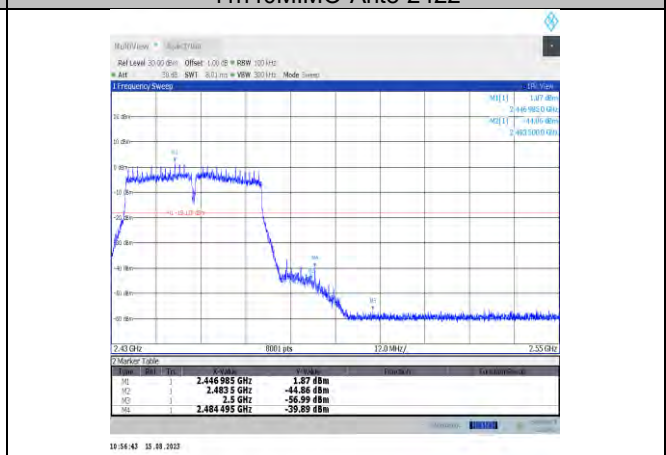

11n40MIMO-Ant8-2452



Unless otherwise agreed in writing, this document is issued by the Company subject to its General Conditions of Service printed overleaf, available on request or accessible at <http://www.sgs.com/en/Terms-and-Conditions.aspx> and, for electronic format documents, subject to Terms and Conditions for Electronic Documents at <http://www.sgs.com/en/Terms-and-Conditions/Terms-e-Documents.aspx>. Attention is drawn to the limitation of liability, indemnification and jurisdiction issues defined therein. Any holder of this document is advised that information contained hereon reflects the Company's findings at the time of its intervention only and within the limits of Client's instructions, if any. The Company's sole responsibility is to its Client and this document does not exonerate parties to a transaction from exercising all their rights and obligations under the transaction documents. This document cannot be reproduced except in full, without prior written approval of the Company. Any unauthorized alteration, forgery or falsification of the content or appearance of this document is unlawful and offenders may be prosecuted to the fullest extent of the law. Unless otherwise stated the results shown in this test report refer only to the sample(s) tested and such sample(s) are retained for 30 days only.

Attention: To check the authenticity of testing/inspection report & certificate, please contact us at telephone: (86-755) 8307 1443, or email: [CN.Doccheck@sgs.com](mailto:CN.Doccheck@sgs.com)  
 South of No. 6 Plant, No. 1, Runsheng Road, Suzhou Industrial Park, Suzhou Area, China (Jiangsu) Pilot Free Trade Zone 215000 t (86-512) 62992980 www.sgs.com.cn  
 中国·苏州·中国(江苏)自由贸易试验区苏州片区苏州工业园区润胜路1号的6号厂房南楼 邮编: 215000 t (86-512) 62992980 sgs.china@sgs.com

### Conducted Spurious Emission Test Graphs

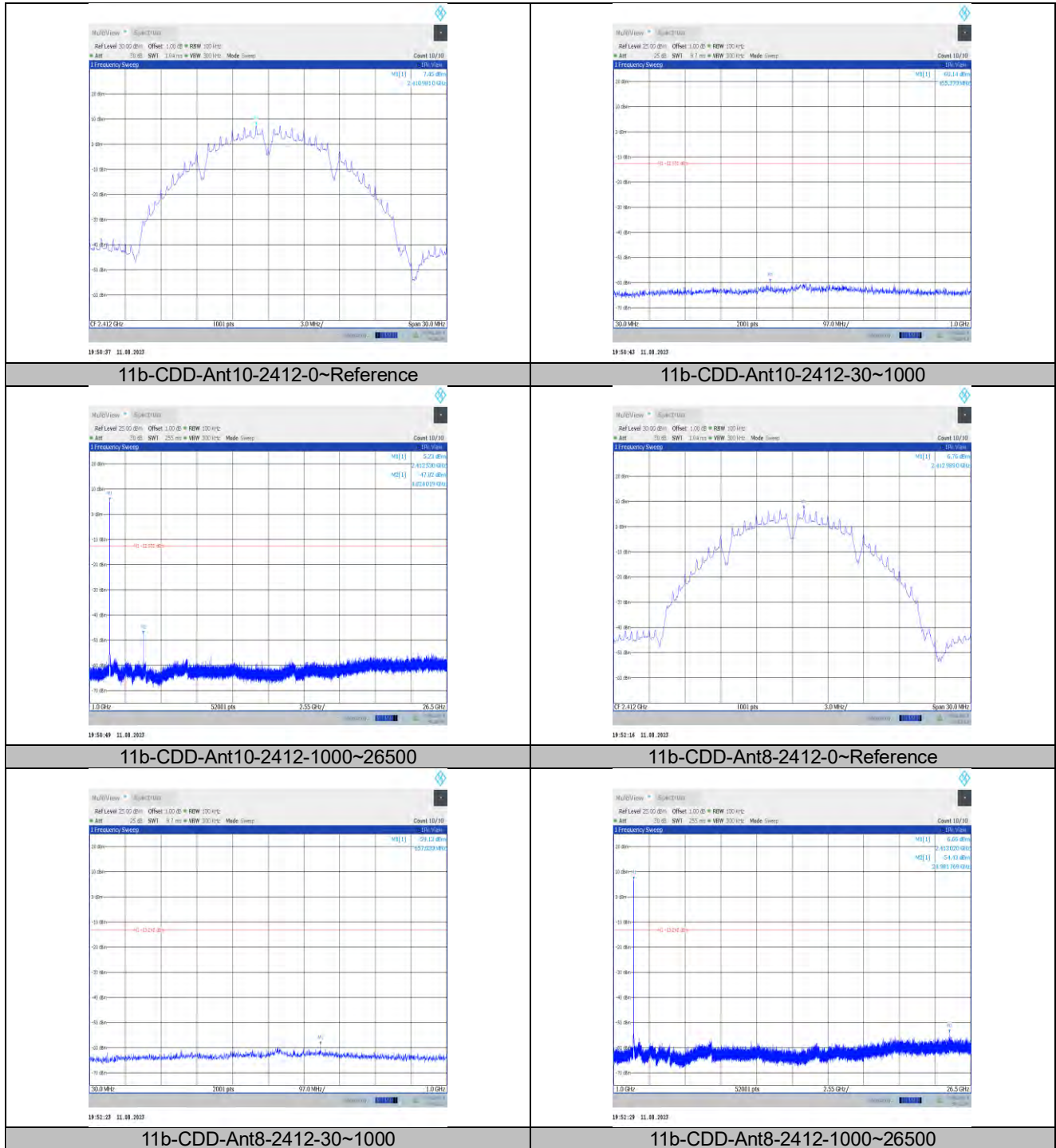

Unless otherwise agreed in writing, this document is issued by the Company subject to its General Conditions of Service printed overleaf, available on request or accessible at <http://www.sgs.com/en/Terms-and-Conditions.aspx> and, for electronic format documents, subject to Terms and Conditions for Electronic Documents at <http://www.sgs.com/en/Terms-and-Conditions/Terms-e-Documents.aspx>. Attention is drawn to the limitation of liability, indemnification and jurisdiction issues defined therein. Any holder of this document is advised that information contained hereon reflects the Company's findings at the time of its intervention only and within the limits of Client's instructions, if any. The Company's sole responsibility is to its Client and this document does not exonerate parties to a transaction from exercising all their rights and obligations under the transaction documents. This document cannot be reproduced except in full, without prior written approval of the Company. Any unauthorized alteration, forgery or falsification of the content or appearance of this document is unlawful and offenders may be prosecuted to the fullest extent of the law. Unless otherwise stated the results shown in this test report refer only to the sample(s) tested and such sample(s) are retained for 30 days only.

Attention: To check the authenticity of testing/inspection report & certificate, please contact us at telephone: (86-755) 8307 1443, or email: [CN\\_Doccheck@sgs.com](mailto:CN_Doccheck@sgs.com)  
 South of No. 6 Plant, No. 1, Runsheng Road, Suzhou Industrial Park, Suzhou Area, China (Jiangsu) Pilot Free Trade Zone 215000 t (86-512) 62992980 www.sgs.com.cn  
 中国·苏州·中国(江苏)自由贸易试验区苏州片区苏州工业园区润胜路1号的6号厂房南楼 邮编: 215000 t (86-512) 62992980 sgs.china@sgs.com

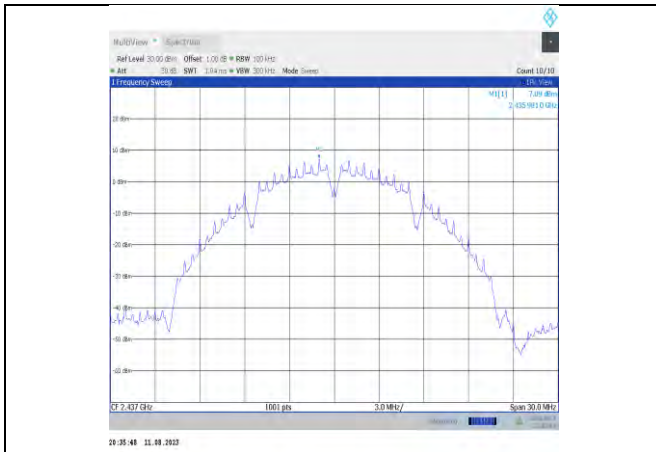

11b-CDD-Ant10-2437-0~Reference

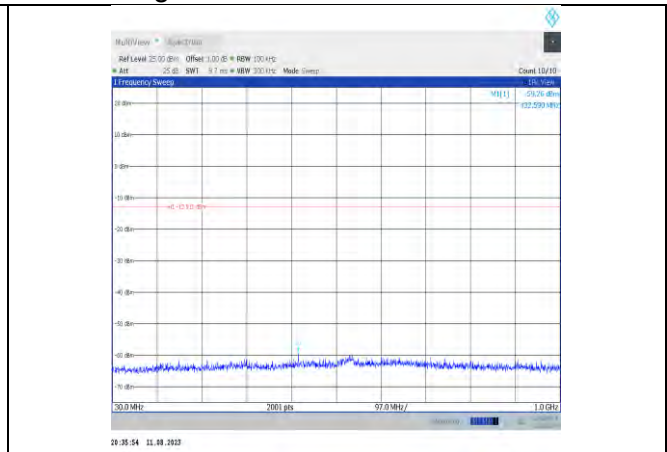

11b-CDD-Ant10-2437-30~1000

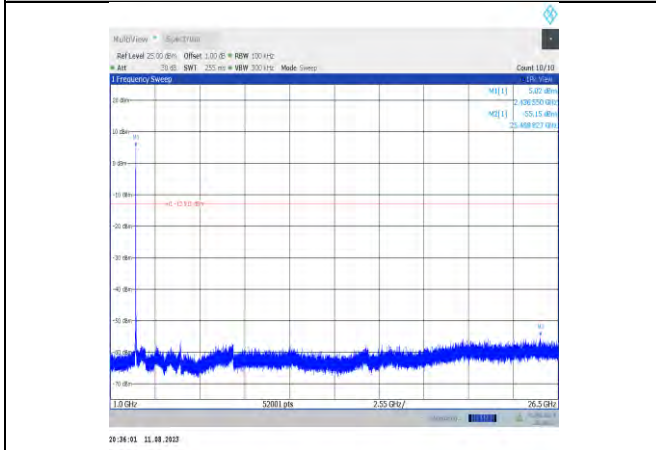

11b-CDD-Ant10-2437-1000~26500

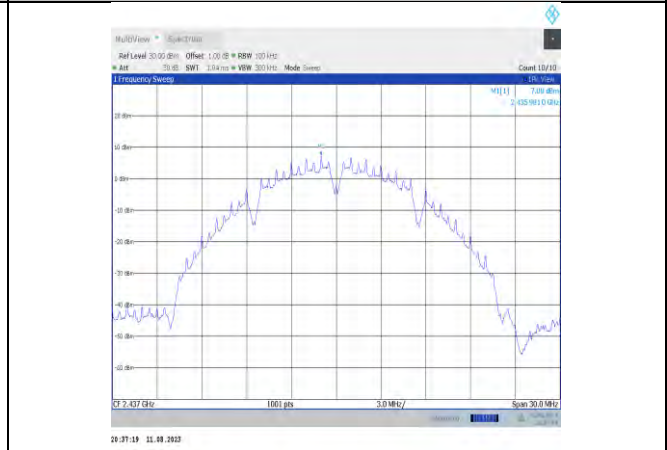

11b-CDD-Ant8-2437-0~Reference

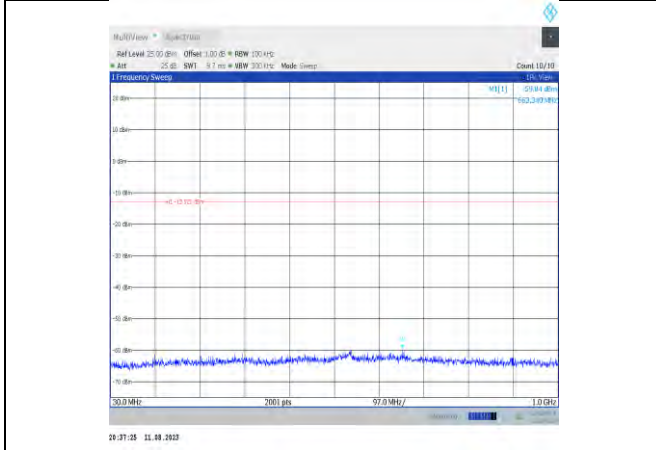

11b-CDD-Ant8-2437-30~1000

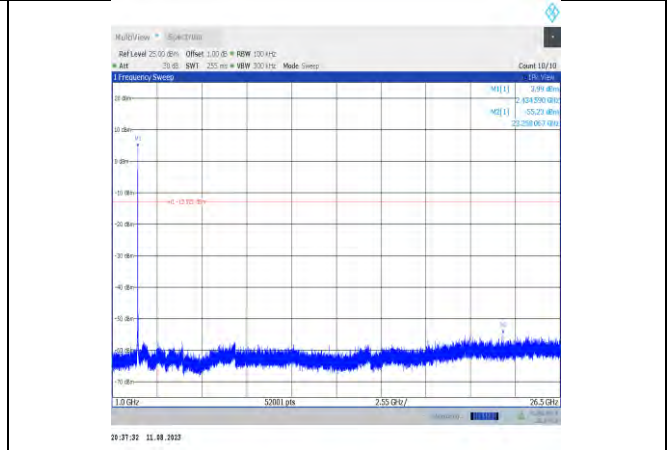

11b-CDD-Ant8-2437-1000~26500



Unless otherwise agreed in writing, this document is issued by the Company subject to its General Conditions of Service printed overleaf, available on request or accessible at <http://www.sgs.com/en/Terms-and-Conditions.aspx> and, for electronic format documents, subject to Terms and Conditions for Electronic Documents at <http://www.sgs.com/en/Terms-and-Conditions/Terms-e-Documents.aspx>. Attention is drawn to the limitation of liability, indemnification and jurisdiction issues defined therein. Any holder of this document is advised that information contained hereon reflects the Company's findings at the time of its intervention only and within the limits of Client's instructions, if any. The Company's sole responsibility is to its Client and this document does not exonerate parties to a transaction from exercising all their rights and obligations under the transaction documents. This document cannot be reproduced except in full, without prior written approval of the Company. Any unauthorized alteration, forgery or falsification of the content or appearance of this document is unlawful and offenders may be prosecuted to the fullest extent of the law. Unless otherwise stated the results shown in this test report refer only to the sample(s) tested and such sample(s) are retained for 30 days only.

Attention: To check the authenticity of testing/inspection report & certificate, please contact us at telephone: (86-755) 8307 1443, or email: [CN.Doccheck@sgs.com](mailto:CN.Doccheck@sgs.com)  
 South of No. 6 Plant, No. 1, Runsheng Road, Suzhou Industrial Park, Suzhou Area, China (Jiangsu) Pilot Free Trade Zone 215000 t (86-512) 62992980 www.sgs.com.cn  
 中国·苏州·中国(江苏)自由贸易试验区苏州片区苏州工业园区润胜路1号的6号厂房南座 邮编: 215000 t (86-512) 62992980 sgs.china@sgs.com

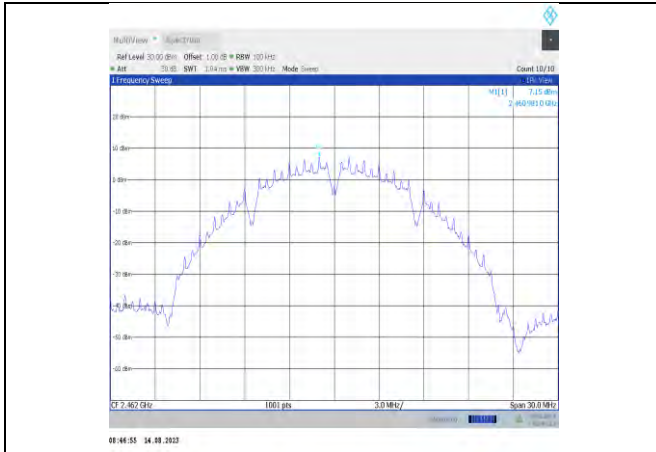

11b-CDD-Ant10-2462-0~Reference

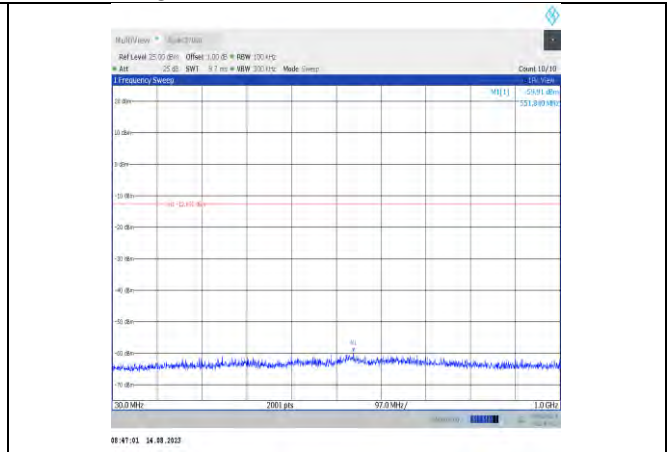

11b-CDD-Ant10-2462-30~1000

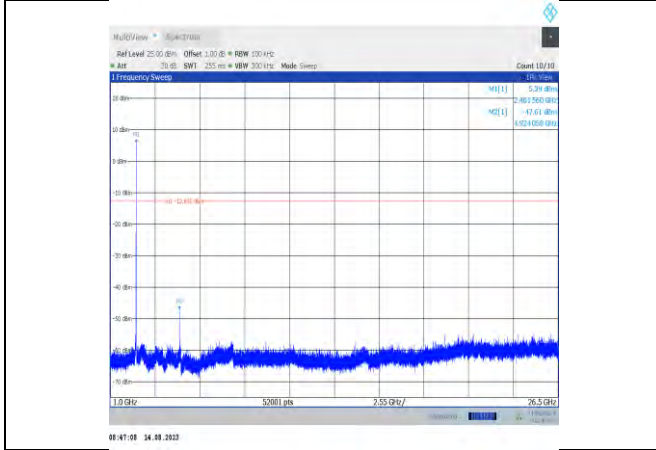

11b-CDD-Ant10-2462-1000~26500

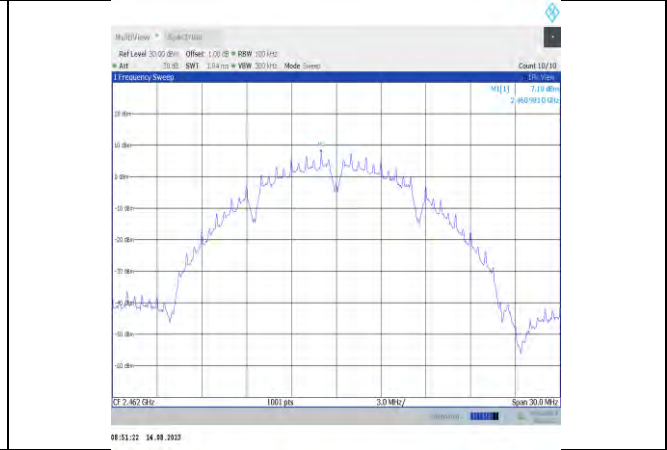

11b-CDD-Ant8-2462-0~Reference

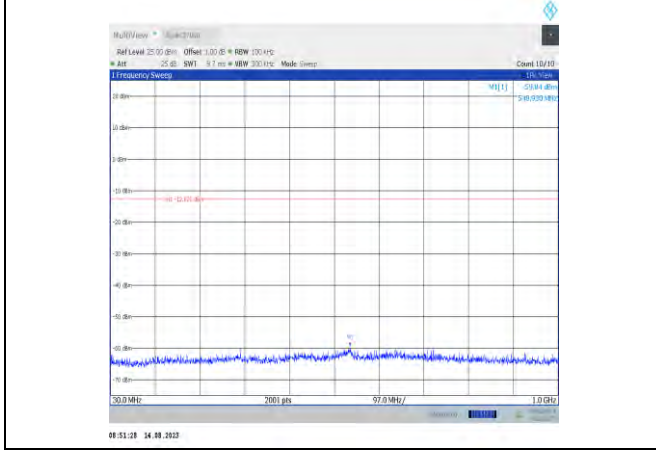

11b-CDD-Ant8-2462-30~1000

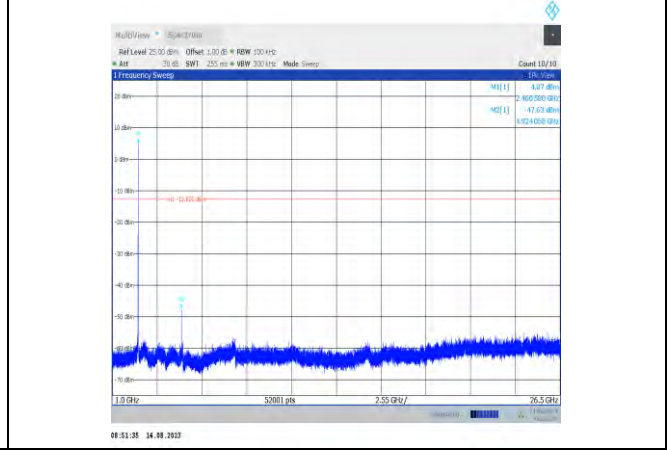

11b-CDD-Ant8-2462-1000~26500



Unless otherwise agreed in writing, this document is issued by the Company subject to its General Conditions of Service printed overleaf, available on request or accessible at <http://www.sgs.com/en/Terms-and-Conditions.aspx> and, for electronic format documents, subject to Terms and Conditions for Electronic Documents at <http://www.sgs.com/en/Terms-and-Conditions/Terms-e-Documents.aspx>. Attention is drawn to the limitation of liability, indemnification and jurisdiction issues defined therein. Any holder of this document is advised that information contained hereon reflects the Company's findings at the time of its intervention only and within the limits of Client's instructions, if any. The Company's sole responsibility is to its Client and this document does not exonerate parties to a transaction from exercising all their rights and obligations under the transaction documents. This document cannot be reproduced except in full, without prior written approval of the Company. Any unauthorized alteration, forgery or falsification of the content or appearance of this document is unlawful and offenders may be prosecuted to the fullest extent of the law. Unless otherwise stated the results shown in this test report refer only to the sample(s) tested and such sample(s) are retained for 30 days only.

Attention: To check the authenticity of testing/inspection report & certificate, please contact us at telephone: (86-755) 8307 1443, or email: [CN.Doccheck@sgs.com](mailto:CN.Doccheck@sgs.com)  
 South of No. 6 Plant, No. 1, Runsheng Road, Suzhou Industrial Park, Suzhou Area, China (Jiangsu) Pilot Free Trade Zone 215000 t (86-512) 62992980 www.sgs.com.cn  
 中国·苏州·中国(江苏)自由贸易试验区苏州片区苏州工业园区润胜路1号的6号厂房南座 邮编: 215000 t (86-512) 62992980 sgs.china@sgs.com

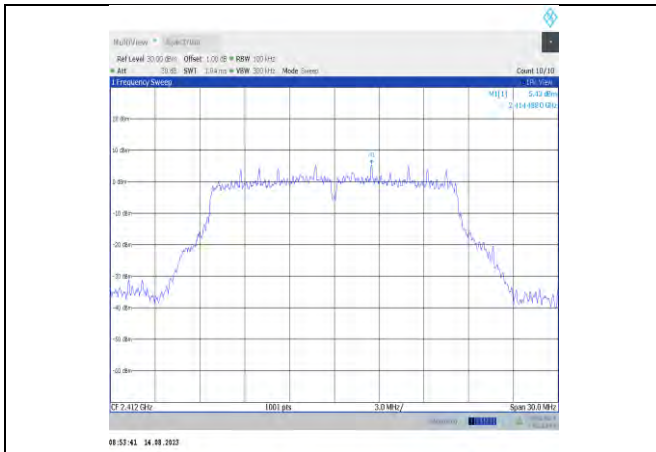

11g-CDD-Ant10-2412-0~Reference

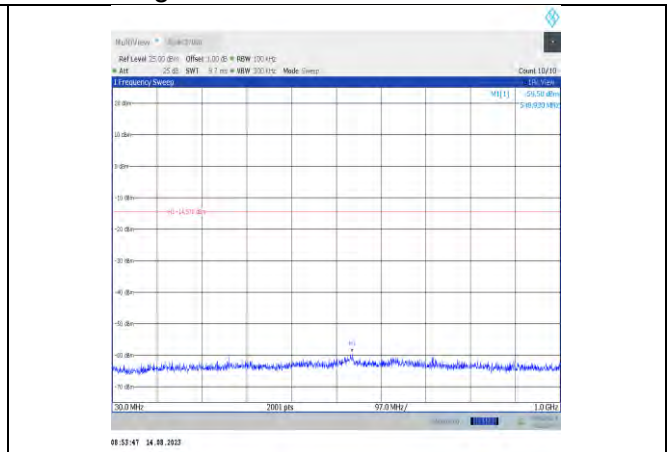

11g-CDD-Ant10-2412-30~1000

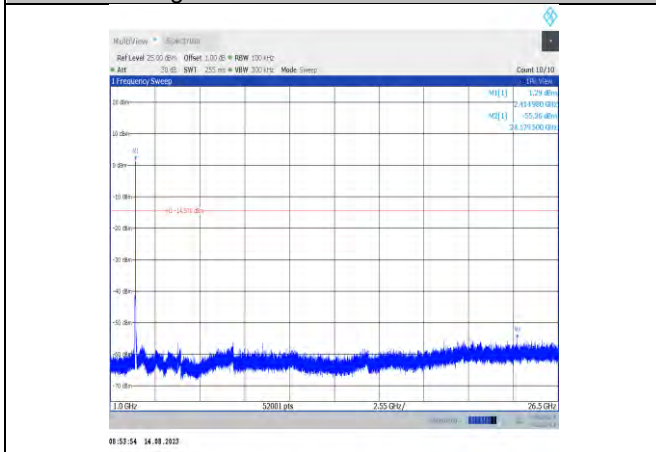

11g-CDD-Ant10-2412-1000~26500

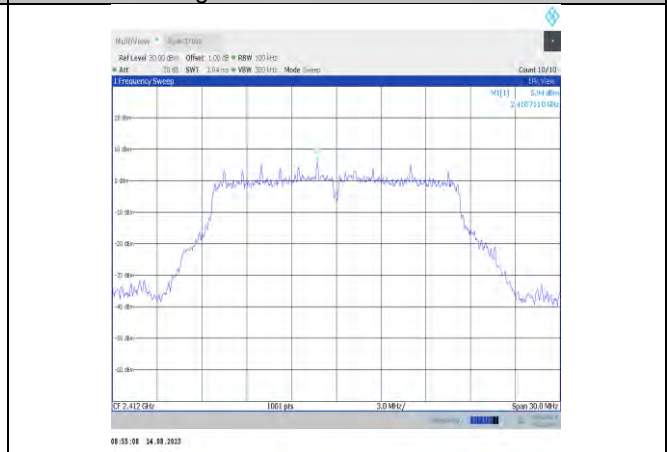

11g-CDD-Ant8-2412-0~Reference

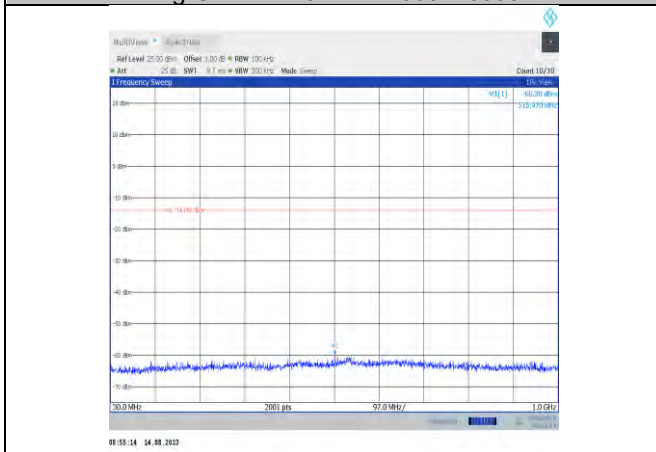

11g-CDD-Ant8-2412-30~1000

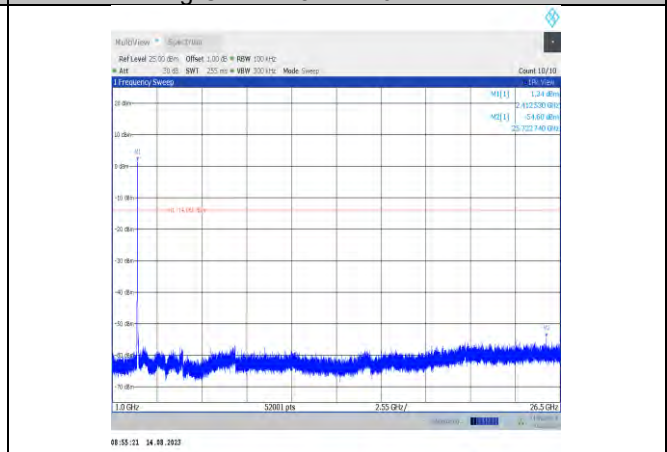

11g-CDD-Ant8-2412-1000~26500



Unless otherwise agreed in writing, this document is issued by the Company subject to its General Conditions of Service printed overleaf, available on request or accessible at <http://www.sgs.com/en/Terms-and-Conditions.aspx> and, for electronic format documents, subject to Terms and Conditions for Electronic Documents at <http://www.sgs.com/en/Terms-and-Conditions/Terms-e-Documents.aspx>. Attention is drawn to the limitation of liability, indemnification and jurisdiction issues defined therein. Any holder of this document is advised that information contained hereon reflects the Company's findings at the time of its intervention only and within the limits of Client's instructions, if any. The Company's sole responsibility is to its Client and this document does not exonerate parties to a transaction from exercising all their rights and obligations under the transaction documents. This document cannot be reproduced except in full, without prior written approval of the Company. Any unauthorized alteration, forgery or falsification of the content or appearance of this document is unlawful and offenders may be prosecuted to the fullest extent of the law. Unless otherwise stated the results shown in this test report refer only to the sample(s) tested and such sample(s) are retained for 30 days only.

Attention: To check the authenticity of testing/inspection report & certificate, please contact us at telephone: (86-755) 8307 1443, or email: [CN.Doccheck@sgs.com](mailto:CN.Doccheck@sgs.com)  
 South of No. 6 Plant, No. 1, Runsheng Road, Suzhou Industrial Park, Suzhou Area, China (Jiangsu) Pilot Free Trade Zone 215000 t (86-512) 62992980 www.sgs.com.cn  
 中国·苏州·中国(江苏)自由贸易试验区苏州片区苏州工业园区润胜路1号的6号厂房南楼 邮编: 215000 t (86-512) 62992980 sgs.china@sgs.com



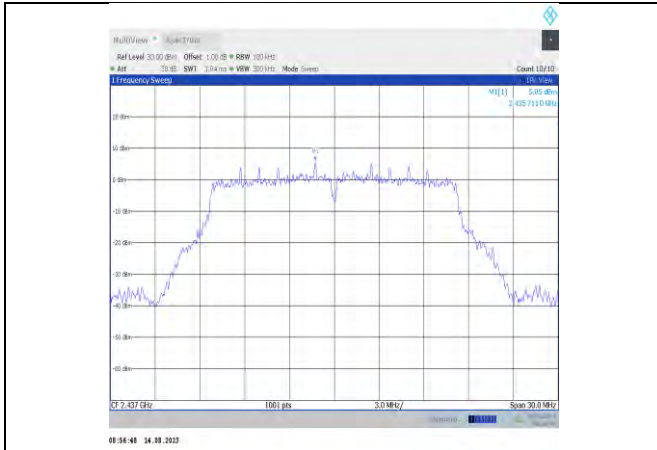

11g-CDD-Ant10-2437-0~Reference

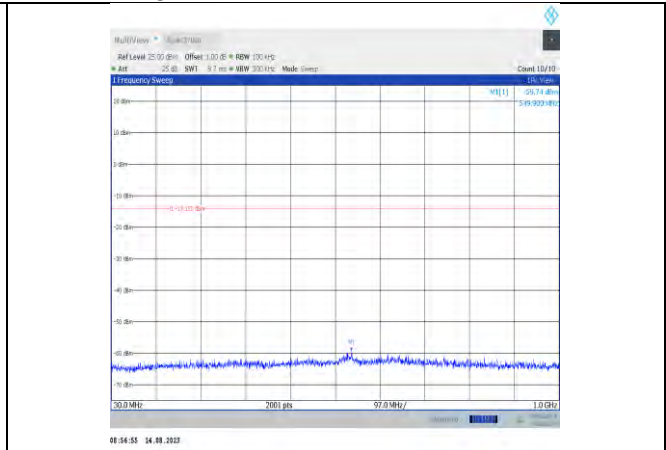

11g-CDD-Ant10-2437-30~1000

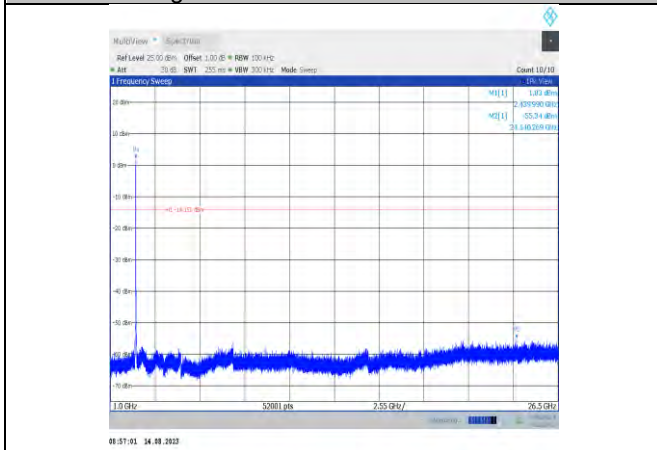

11g-CDD-Ant10-2437-1000~26500

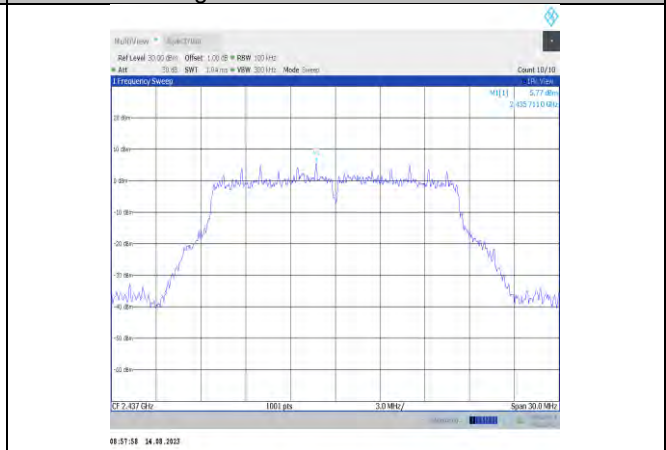

11g-CDD-Ant8-2437-0~Reference

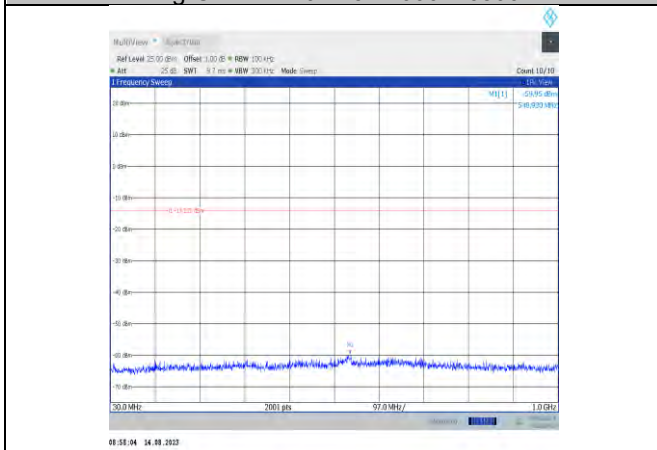

11g-CDD-Ant8-2437-30~1000

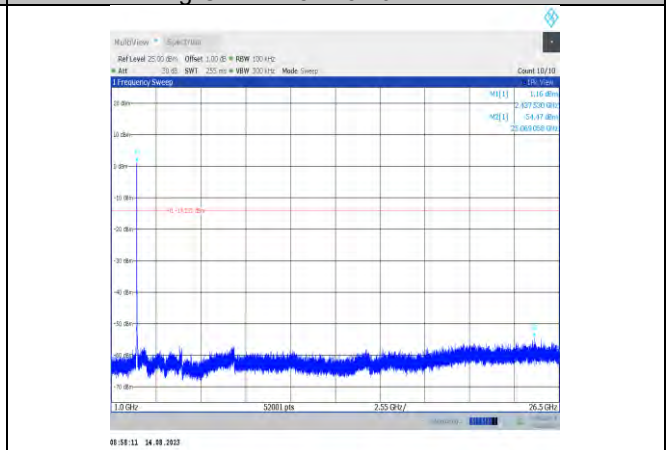

11g-CDD-Ant8-2437-1000~26500



Unless otherwise agreed in writing, this document is issued by the Company subject to its General Conditions of Service printed overleaf, available on request or accessible at <http://www.sgs.com/en/Terms-and-Conditions.aspx> and, for electronic format documents, subject to Terms and Conditions for Electronic Documents at <http://www.sgs.com/en/Terms-and-Conditions/Terms-e-Documents.aspx>. Attention is drawn to the limitation of liability, indemnification and jurisdiction issues defined therein. Any holder of this document is advised that information contained hereon reflects the Company's findings at the time of its intervention only and within the limits of Client's instructions, if any. The Company's sole responsibility is to its Client and this document does not exonerate parties to a transaction from exercising all their rights and obligations under the transaction documents. This document cannot be reproduced except in full, without prior written approval of the Company. Any unauthorized alteration, forgery or falsification of the content or appearance of this document is unlawful and offenders may be prosecuted to the fullest extent of the law. Unless otherwise stated the results shown in this test report refer only to the sample(s) tested and such sample(s) are retained for 30 days only.

Attention: To check the authenticity of testing/inspection report & certificate, please contact us at telephone: (86-755) 8307 1443, or email: [CN.Doccheck@sgs.com](mailto:CN.Doccheck@sgs.com)  
 South of No. 6 Plant, No. 1, Runsheng Road, Suzhou Industrial Park, Suzhou Area, China (Jiangsu) Pilot Free Trade Zone 215000 t (86-512) 62992980 www.sgs.com.cn  
 中国·苏州·中国(江苏)自由贸易试验区苏州片区苏州工业园区润胜路1号的6号厂房南楼 邮编: 215000 t (86-512) 62992980 sgs.china@sgs.com

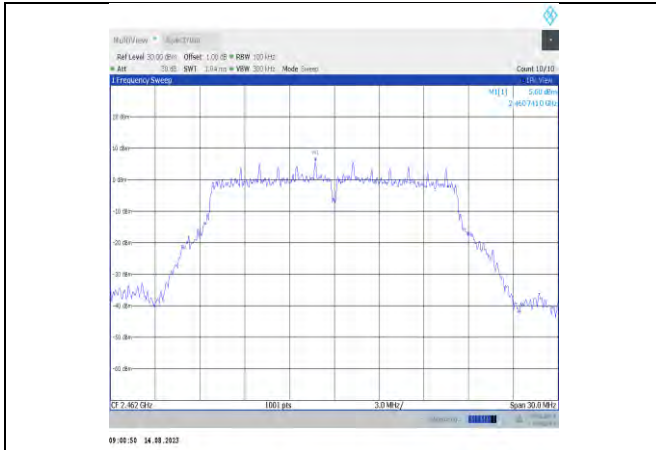

11g-CDD-Ant10-2462-0~Reference

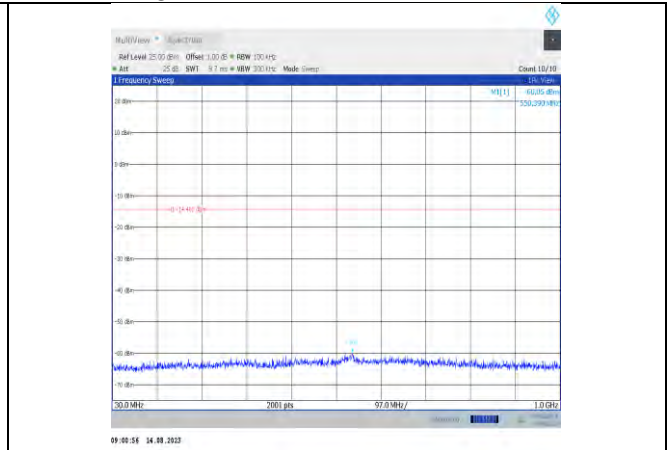

11g-CDD-Ant10-2462-30~1000

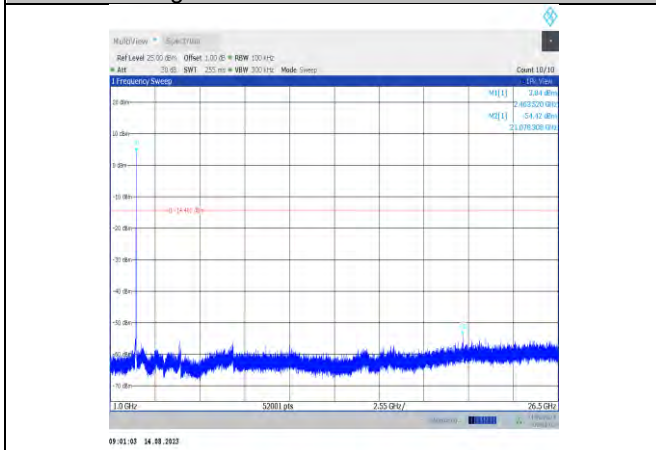

11g-CDD-Ant10-2462-1000~26500

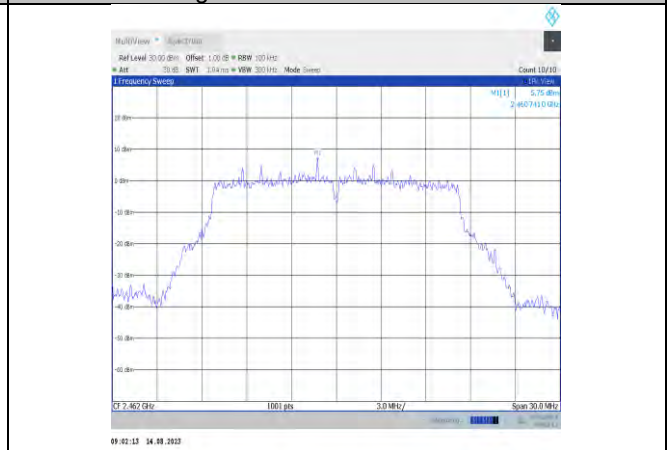

11g-CDD-Ant8-2462-0~Reference

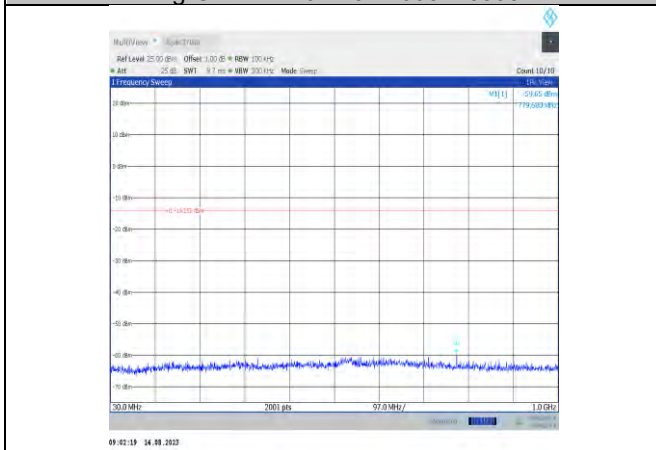

11g-CDD-Ant8-2462-30~1000

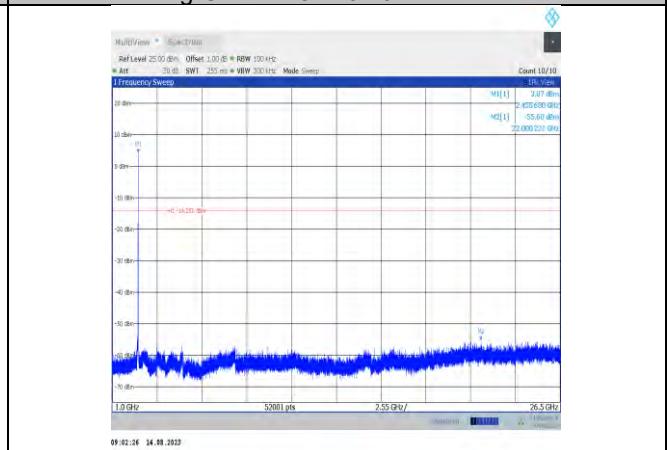

11g-CDD-Ant8-2462-1000~26500



Unless otherwise agreed in writing, this document is issued by the Company subject to its General Conditions of Service printed overleaf, available on request or accessible at <http://www.sgs.com/en/Terms-and-Conditions.aspx> and, for electronic format documents, subject to Terms and Conditions for Electronic Documents at <http://www.sgs.com/en/Terms-and-Conditions/Terms-e-Documents.aspx>. Attention is drawn to the limitation of liability, indemnification and jurisdiction issues defined therein. Any holder of this document is advised that information contained hereon reflects the Company's findings at the time of its intervention only and within the limits of Client's instructions, if any. The Company's sole responsibility is to its Client and this document does not exonerate parties to a transaction from exercising all their rights and obligations under the transaction documents. This document cannot be reproduced except in full, without prior written approval of the Company. Any unauthorized alteration, forgery or falsification of the content or appearance of this document is unlawful and offenders may be prosecuted to the fullest extent of the law. Unless otherwise stated the results shown in this test report refer only to the sample(s) tested and such sample(s) are retained for 30 days only.

Attention: To check the authenticity of testing/inspection report & certificate, please contact us at telephone: (86-755) 8307 1443, or email: [CN.Doccheck@sgs.com](mailto:CN.Doccheck@sgs.com)  
 South of No. 6 Plant, No. 1, Runsheng Road, Suzhou Industrial Park, Suzhou Area, China (Jiangsu) Pilot Free Trade Zone 215000 t (86-512) 62992980 www.sgs.com.cn  
 中国·苏州·中国(江苏)自由贸易试验区苏州片区苏州工业园区润胜路1号的6号厂房南楼 邮编: 215000 t (86-512) 62992980 sgs.china@sgs.com

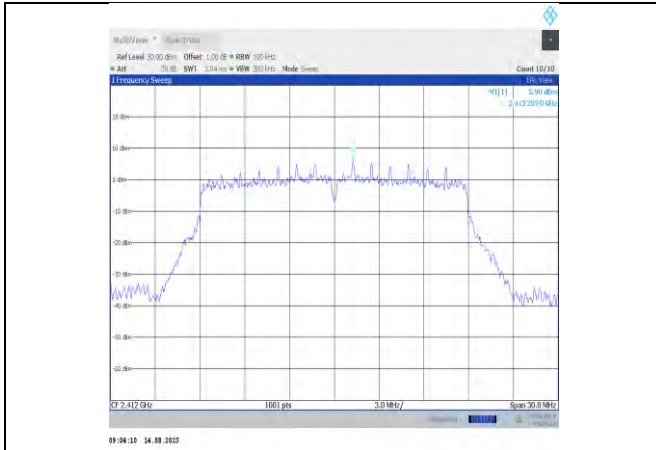

11n20MIMO-Ant10-2412-0~Reference

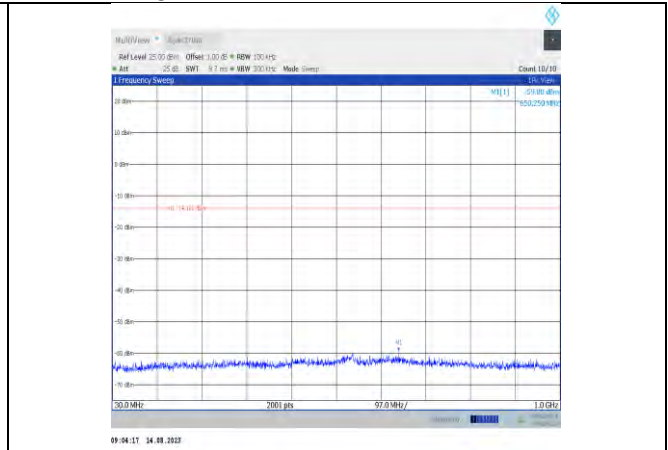

11n20MIMO-Ant10-2412-30~1000

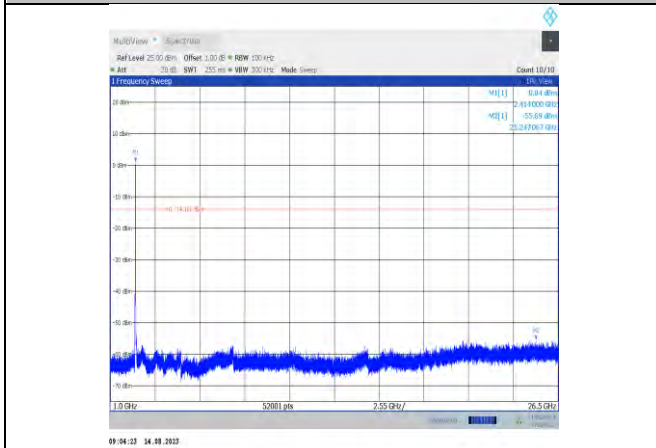

11n20MIMO-Ant10-2412-1000~26500

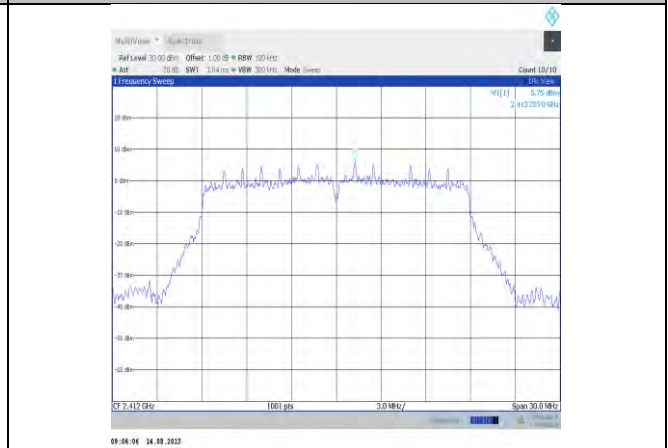

11n20MIMO-Ant8-2412-0~Reference

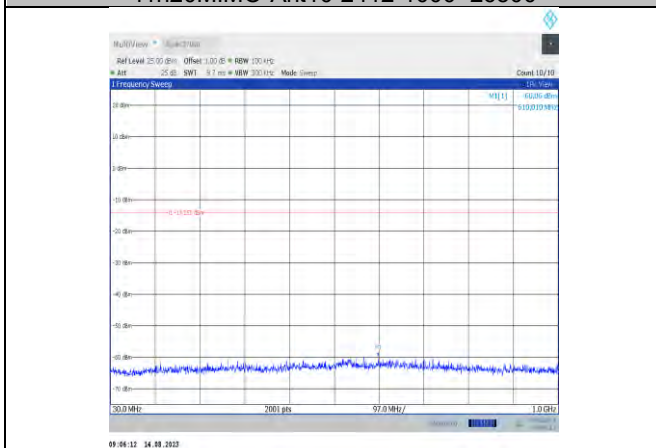

11n20MIMO-Ant8-2412-30~1000

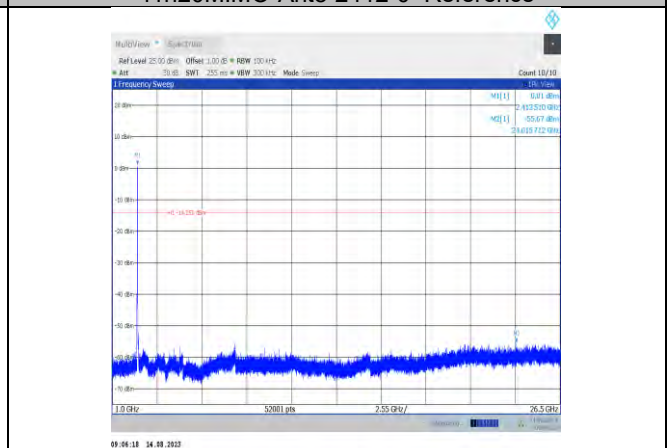

11n20MIMO-Ant8-2412-1000~26500



Unless otherwise agreed in writing, this document is issued by the Company subject to its General Conditions of Service printed overleaf, available on request or accessible at <http://www.sgs.com/en/Terms-and-Conditions.aspx> and, for electronic format documents, subject to Terms and Conditions for Electronic Documents at <http://www.sgs.com/en/Terms-and-Conditions/Terms-e-Documents.aspx>. Attention is drawn to the limitation of liability, indemnification and jurisdiction issues defined therein. Any holder of this document is advised that information contained hereon reflects the Company's findings at the time of its intervention only and within the limits of Client's instructions, if any. The Company's sole responsibility is to its Client and this document does not exonerate parties to a transaction from exercising all their rights and obligations under the transaction documents. This document cannot be reproduced except in full, without prior written approval of the Company. Any unauthorized alteration, forgery or falsification of the content or appearance of this document is unlawful and offenders may be prosecuted to the fullest extent of the law. Unless otherwise stated the results shown in this test report refer only to the sample(s) tested and such sample(s) are retained for 30 days only.

Attention: To check the authenticity of testing/inspection report & certificate, please contact us at telephone: (86-755) 8307 1443, or email: [CN.Doccheck@sgs.com](mailto:CN.Doccheck@sgs.com)  
 South of No. 6 Plant, No. 1, Runsheng Road, Suzhou Industrial Park, Suzhou Area, China (Jiangsu) Pilot Free Trade Zone 215000 t (86-512) 62992980 www.sgs.com.cn  
 中国·苏州·中国(江苏)自由贸易试验区苏州片区苏州工业园区润胜路1号的6号厂房南座 邮编: 215000 t (86-512) 62992980 sgs.china@sgs.com

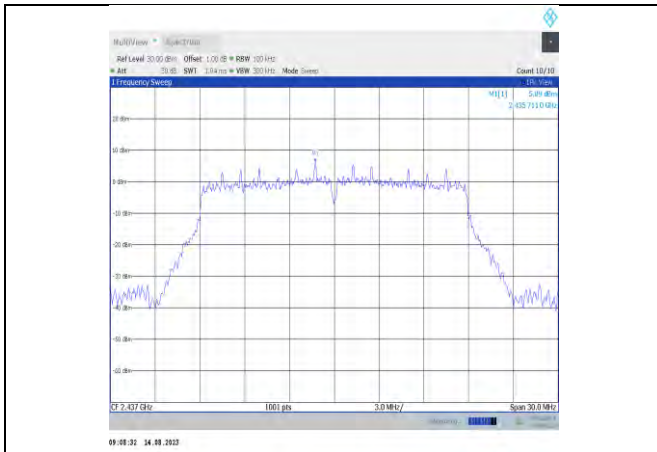

11n20MIMO-Ant10-2437-0~Reference

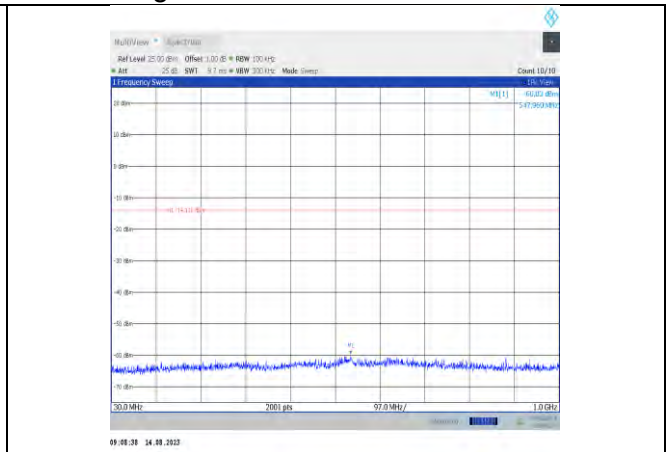

11n20MIMO-Ant10-2437-30~1000

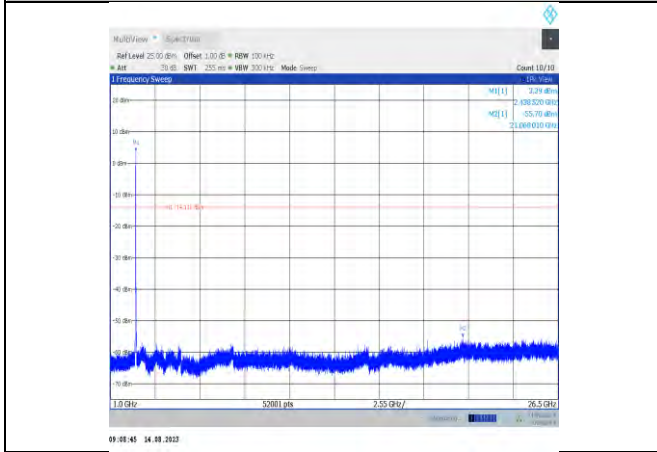

11n20MIMO-Ant10-2437-1000~26500

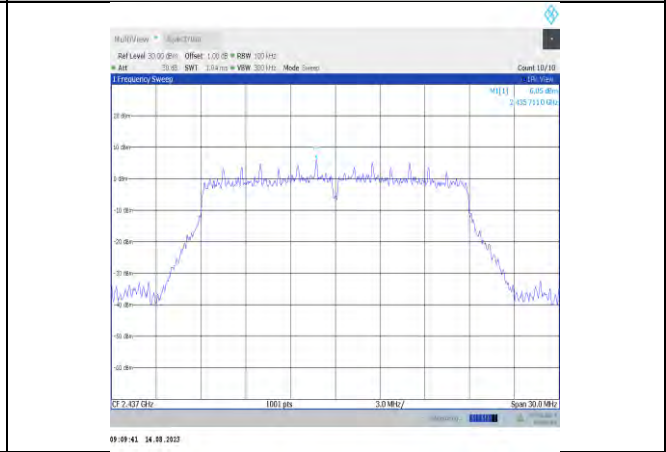

11n20MIMO-Ant8-2437-0~Reference

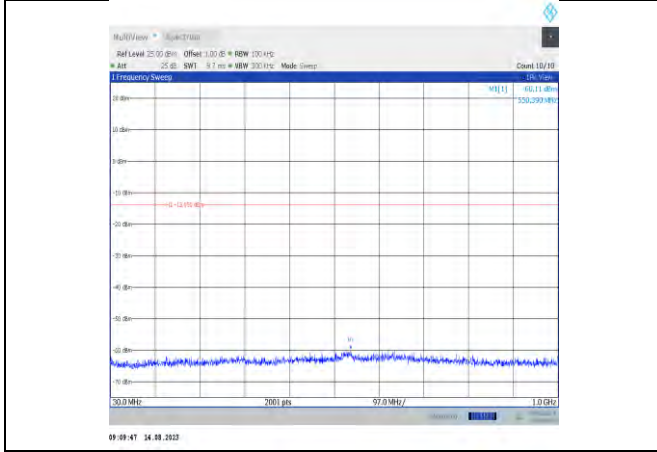

11n20MIMO-Ant8-2437-30~1000

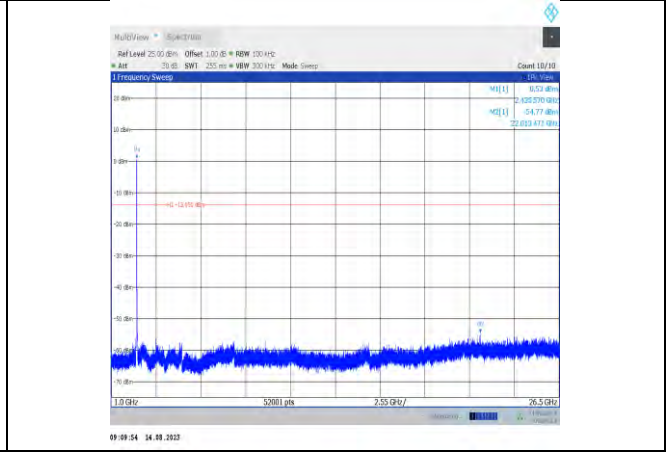

11n20MIMO-Ant8-2437-1000~26500



Unless otherwise agreed in writing, this document is issued by the Company subject to its General Conditions of Service printed overleaf, available on request or accessible at <http://www.sgs.com/en/Terms-and-Conditions.aspx> and, for electronic format documents, subject to Terms and Conditions for Electronic Documents at <http://www.sgs.com/en/Terms-and-Conditions/Terms-e-Documents.aspx>. Attention is drawn to the limitation of liability, indemnification and jurisdiction issues defined therein. Any holder of this document is advised that information contained hereon reflects the Company's findings at the time of its intervention only and within the limits of Client's instructions, if any. The Company's sole responsibility is to its Client and this document does not exonerate parties to a transaction from exercising all their rights and obligations under the transaction documents. This document cannot be reproduced except in full, without prior written approval of the Company. Any unauthorized alteration, forgery or falsification of the content or appearance of this document is unlawful and offenders may be prosecuted to the fullest extent of the law. Unless otherwise stated the results shown in this test report refer only to the sample(s) tested and such sample(s) are retained for 30 days only.

Attention: To check the authenticity of testing/inspection report & certificate, please contact us at telephone: (86-755) 8307 1443, or email: [CN.Doccheck@sgs.com](mailto:CN.Doccheck@sgs.com)  
 South of No. 6 Plant, No. 1, Runsheng Road, Suzhou Industrial Park, Suzhou Area, China (Jiangsu) Pilot Free Trade Zone 215000 t (86-512) 62992980 www.sgs.com.cn  
 中国·苏州·中国(江苏)自由贸易试验区苏州片区苏州工业园区润胜路1号的6号厂房南楼 邮编: 215000 t (86-512) 62992980 sgs.china@sgs.com

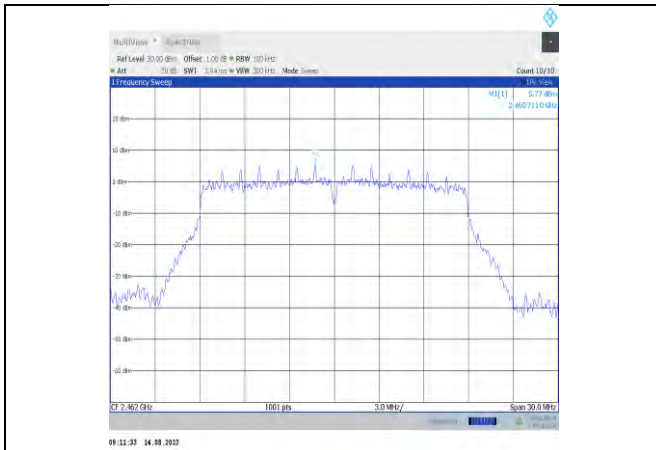

11n20MIMO-Ant10-2462-0~Reference

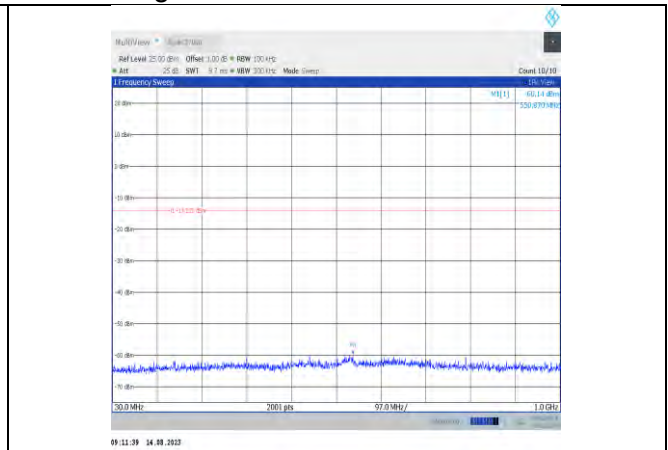

11n20MIMO-Ant10-2462-30~1000

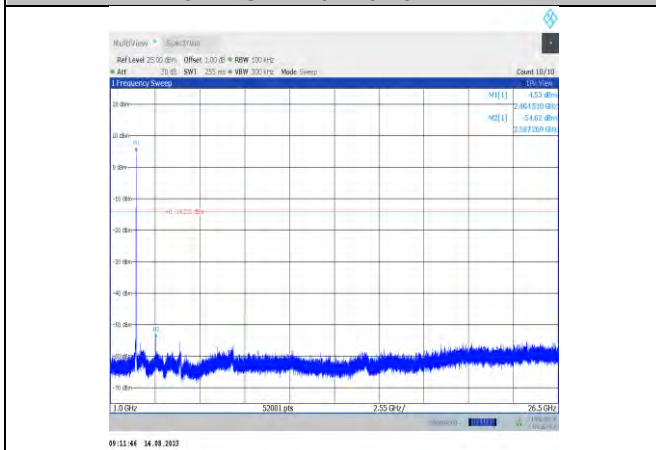

11n20MIMO-Ant10-2462-1000~26500

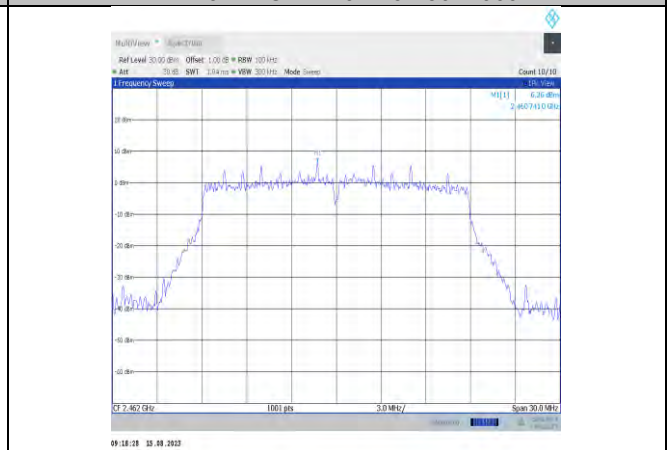

11n20MIMO-Ant8-2462-0~Reference

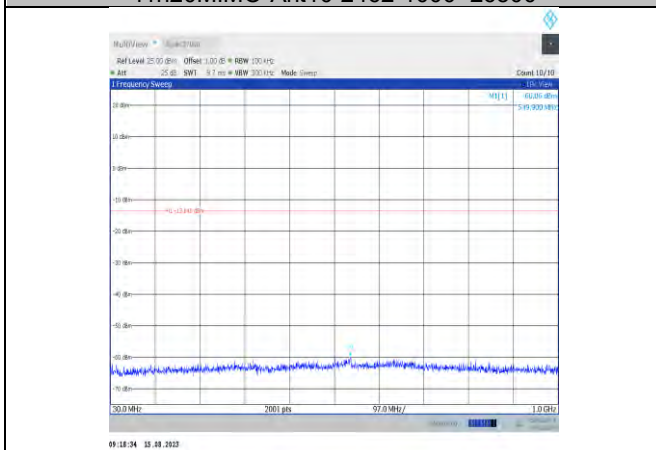

11n20MIMO-Ant8-2462-30~1000

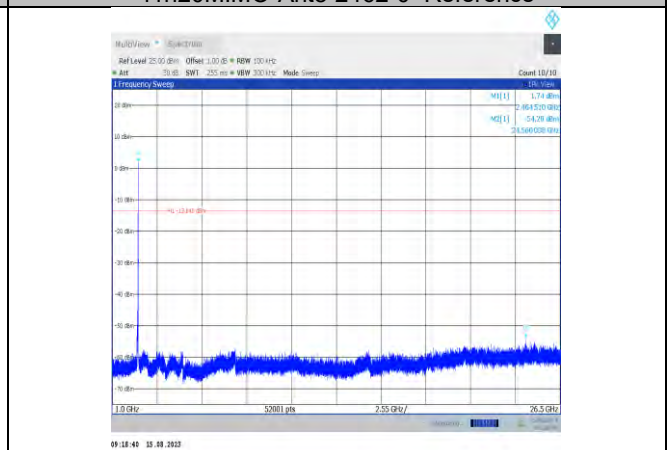

11n20MIMO-Ant8-2462-1000~26500



Unless otherwise agreed in writing, this document is issued by the Company subject to its General Conditions of Service printed overleaf, available on request or accessible at <http://www.sgs.com/en/Terms-and-Conditions.aspx> and, for electronic format documents, subject to Terms and Conditions for Electronic Documents at <http://www.sgs.com/en/Terms-and-Conditions/Terms-e-Documents.aspx>. Attention is drawn to the limitation of liability, indemnification and jurisdiction issues defined therein. Any holder of this document is advised that information contained hereon reflects the Company's findings at the time of its intervention only and within the limits of Client's instructions, if any. The Company's sole responsibility is to its Client and this document does not exonerate parties to a transaction from exercising all their rights and obligations under the transaction documents. This document cannot be reproduced except in full, without prior written approval of the Company. Any unauthorized alteration, forgery or falsification of the content or appearance of this document is unlawful and offenders may be prosecuted to the fullest extent of the law. Unless otherwise stated the results shown in this test report refer only to the sample(s) tested and such sample(s) are retained for 30 days only.

Attention: To check the authenticity of testing/inspection report & certificate, please contact us at telephone: (86-755) 8307 1443, or email: [CN.Doccheck@sgs.com](mailto:CN.Doccheck@sgs.com)  
 South of No. 6 Plant, No. 1, Runsheng Road, Suzhou Industrial Park, Suzhou Area, China (Jiangsu) Pilot Free Trade Zone 215000 t (86-512) 62992980 www.sgs.com.cn  
 中国·苏州·中国(江苏)自由贸易试验区苏州片区苏州工业园区润胜路1号的6号厂房南楼 邮编: 215000 t (86-512) 62992980 sgs.china@sgs.com

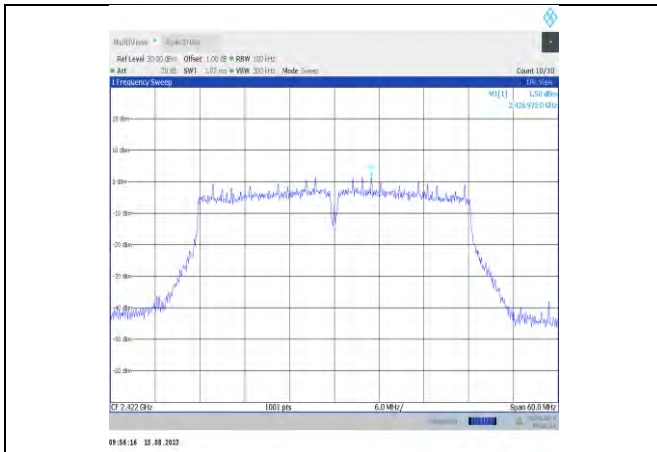

11n40MIMO-Ant10-2422-0~Reference

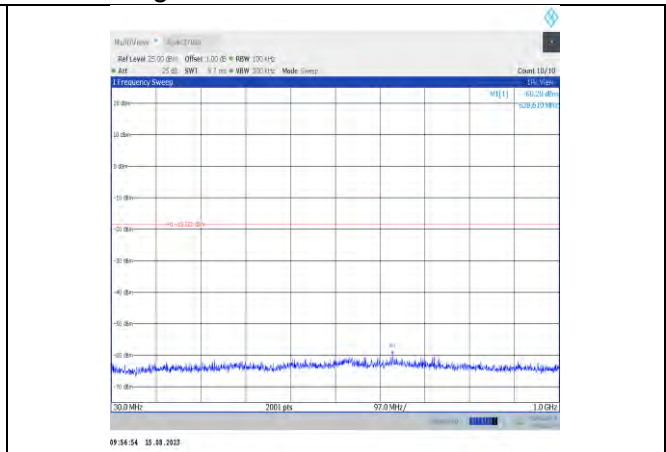

11n40MIMO-Ant10-2422-30~1000

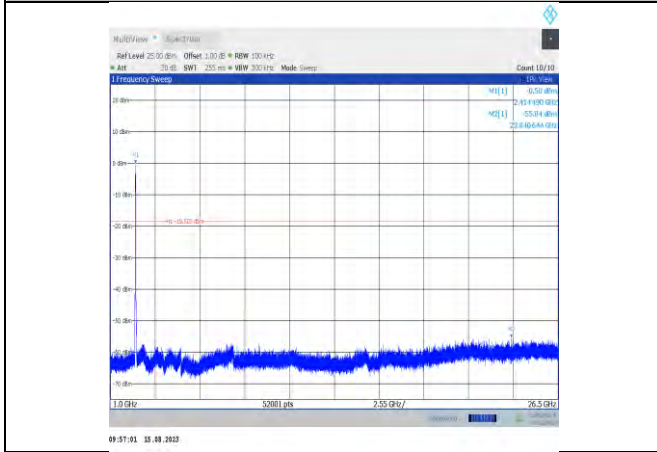

11n40MIMO-Ant10-2422-1000~26500

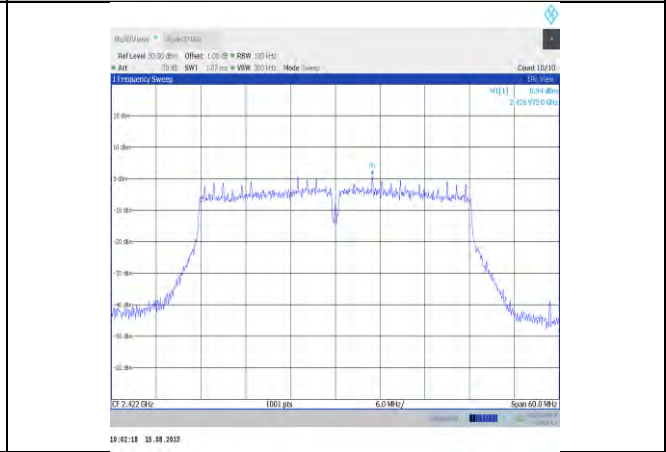

11n40MIMO-Ant8-2422-0~Reference

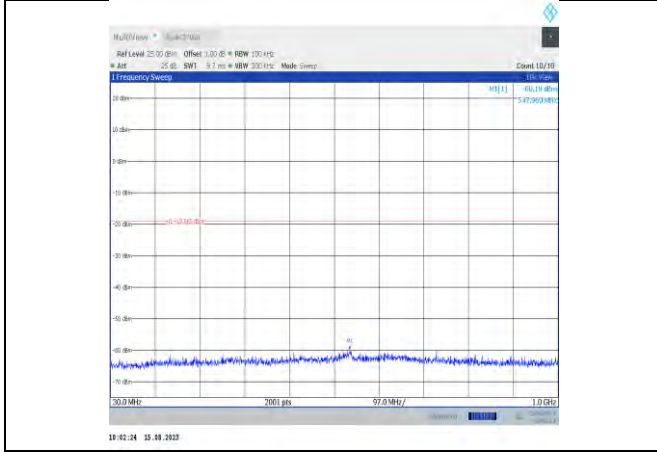

11n40MIMO-Ant8-2422-30~1000

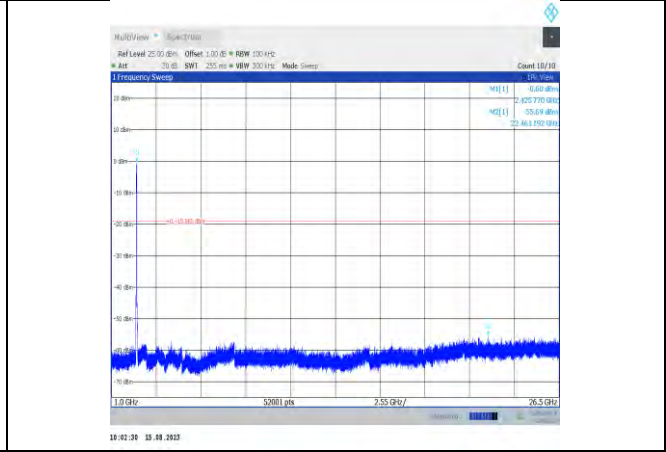

11n40MIMO-Ant8-2422-1000~26500



Unless otherwise agreed in writing, this document is issued by the Company subject to its General Conditions of Service printed overleaf, available on request or accessible at <http://www.sgs.com/en/Terms-and-Conditions.aspx> and, for electronic format documents, subject to Terms and Conditions for Electronic Documents at <http://www.sgs.com/en/Terms-and-Conditions/Terms-e-Documents.aspx>. Attention is drawn to the limitation of liability, indemnification and jurisdiction issues defined therein. Any holder of this document is advised that information contained hereon reflects the Company's findings at the time of its intervention only and within the limits of Client's instructions, if any. The Company's sole responsibility is to its Client and this document does not exonerate parties to a transaction from exercising all their rights and obligations under the transaction documents. This document cannot be reproduced except in full, without prior written approval of the Company. Any unauthorized alteration, forgery or falsification of the content or appearance of this document is unlawful and offenders may be prosecuted to the fullest extent of the law. Unless otherwise stated the results shown in this test report refer only to the sample(s) tested and such sample(s) are retained for 30 days only.

Attention: To check the authenticity of testing/inspection report & certificate, please contact us at telephone: (86-755) 8307 1443, or email: [CN.Doccheck@sgs.com](mailto:CN.Doccheck@sgs.com)  
 South of No. 6 Plant, No. 1, Runsheng Road, Suzhou Industrial Park, Suzhou Area, China (Jiangsu) Pilot Free Trade Zone 215000 t (86-512) 62992980 www.sgs.com.cn  
 中国·苏州·中国(江苏)自由贸易试验区苏州片区工业园区润胜路1号的6号厂房南座 邮编: 215000 t (86-512) 62992980 sgs.china@sgs.com

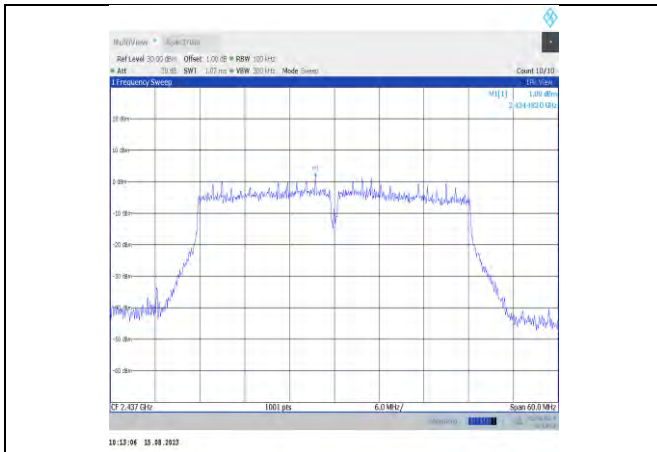

11n40MIMO-Ant10-2437-0~Reference

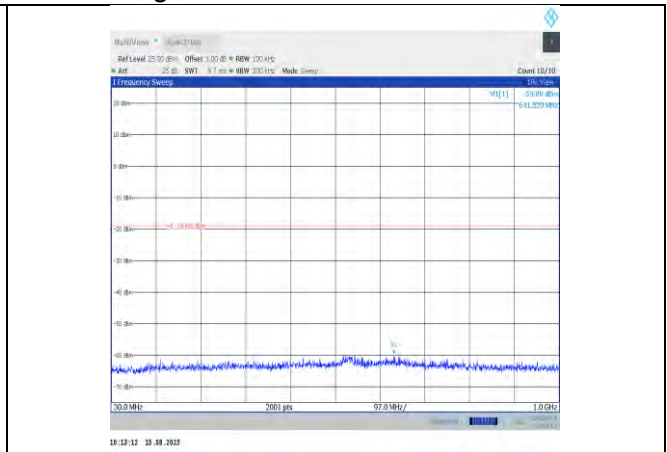

11n40MIMO-Ant10-2437-30~1000

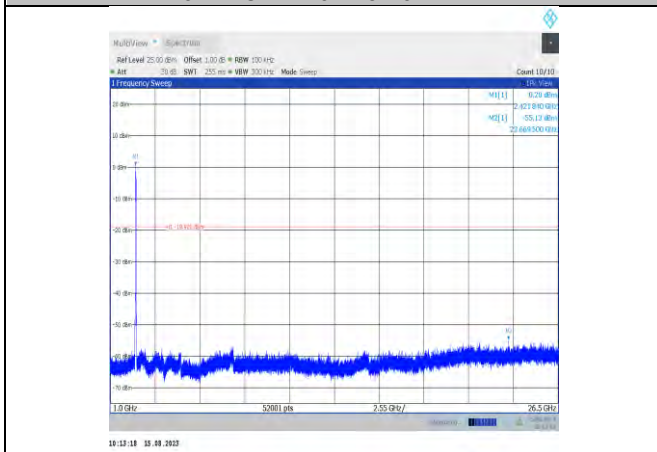

11n40MIMO-Ant10-2437-1000~26500

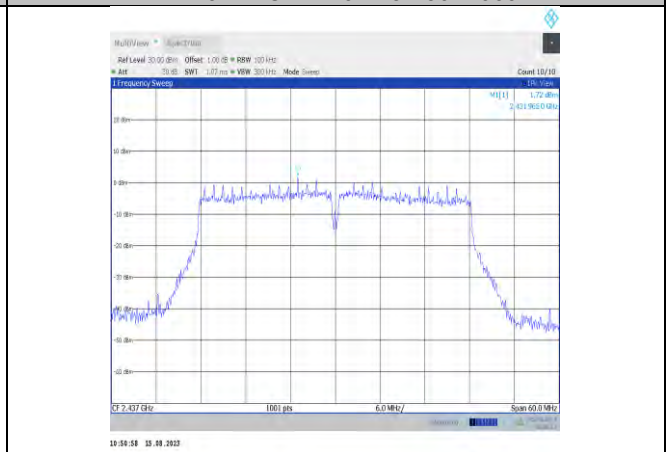

11n40MIMO-Ant8-2437-0~Reference

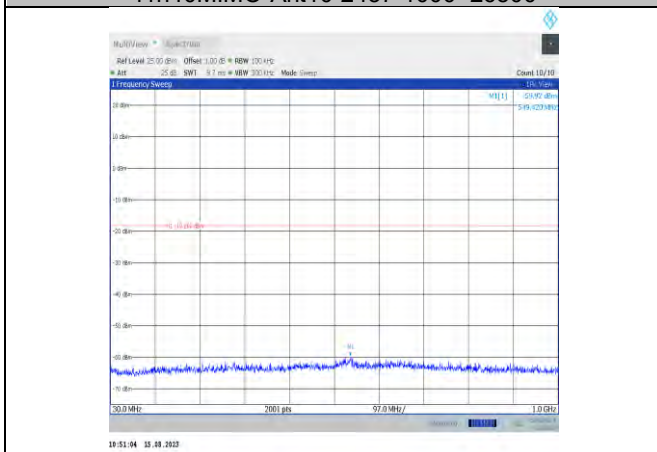

11n40MIMO-Ant8-2437-30~1000

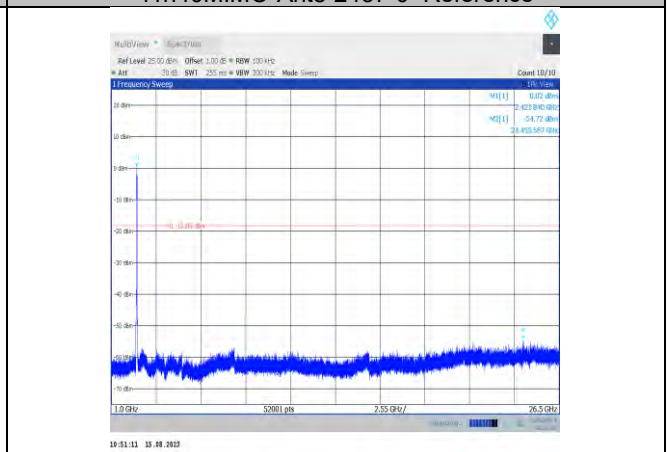

11n40MIMO-Ant8-2437-1000~26500



Unless otherwise agreed in writing, this document is issued by the Company subject to its General Conditions of Service printed overleaf, available on request or accessible at <http://www.sgs.com/en/Terms-and-Conditions.aspx> and, for electronic format documents, subject to Terms and Conditions for Electronic Documents at <http://www.sgs.com/en/Terms-and-Conditions/Terms-e-Documents.aspx>. Attention is drawn to the limitation of liability, indemnification and jurisdiction issues defined therein. Any holder of this document is advised that information contained hereon reflects the Company's findings at the time of its intervention only and within the limits of Client's instructions, if any. The Company's sole responsibility is to its Client and this document does not exonerate parties to a transaction from exercising all their rights and obligations under the transaction documents. This document cannot be reproduced except in full, without prior written approval of the Company. Any unauthorized alteration, forgery or falsification of the content or appearance of this document is unlawful and offenders may be prosecuted to the fullest extent of the law. Unless otherwise stated the results shown in this test report refer only to the sample(s) tested and such sample(s) are retained for 30 days only.

Attention: To check the authenticity of testing/inspection report & certificate, please contact us at telephone: (86-755) 8307 1443, or email: [CN.Doccheck@sgs.com](mailto:CN.Doccheck@sgs.com)  
 South of No. 6 Plant, No. 1, Runsheng Road, Suzhou Industrial Park, Suzhou Area, China (Jiangsu) Pilot Free Trade Zone 215000 t (86-512) 62992980 www.sgs.com.cn  
 中国·苏州·中国(江苏)自由贸易试验区苏州片区苏州工业园区润胜路1号的6号厂房南座 邮编: 215000 t (86-512) 62992980 sgs.china@sgs.com

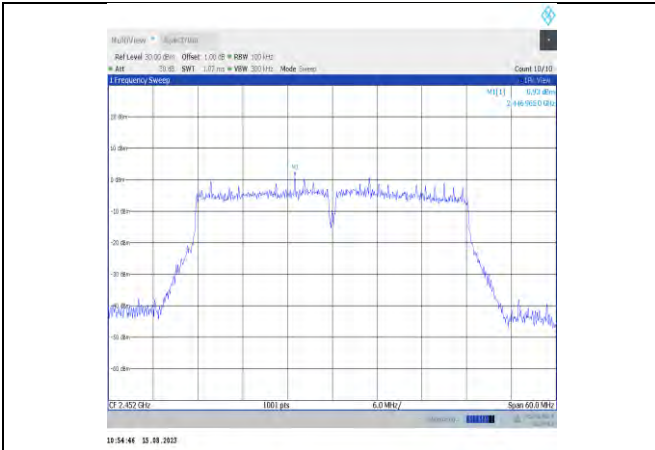

11n40MIMO-Ant10-2452-0~Reference

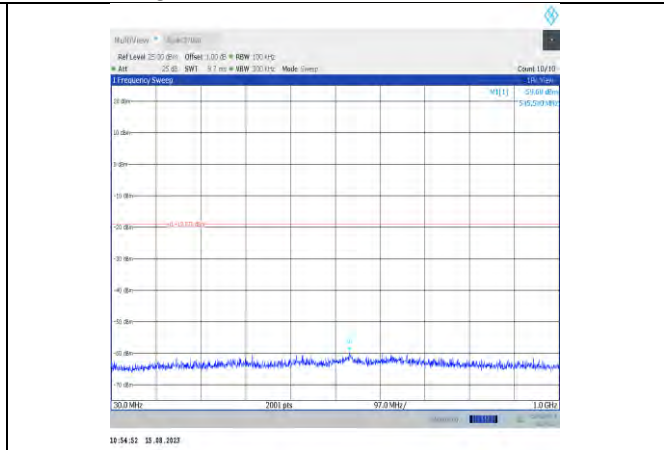

11n40MIMO-Ant10-2452-30~1000

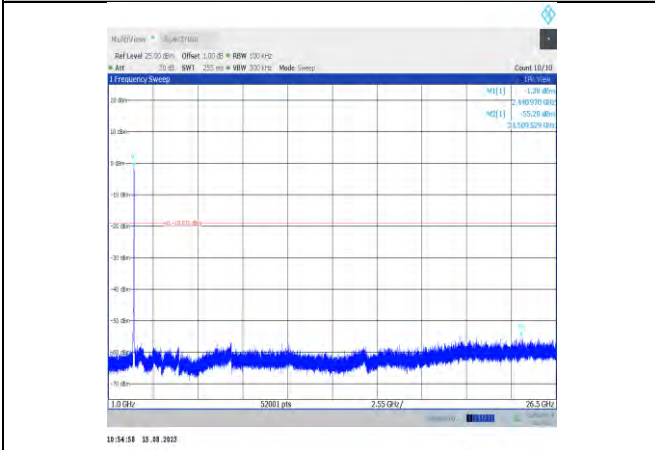

11n40MIMO-Ant10-2452-1000~26500

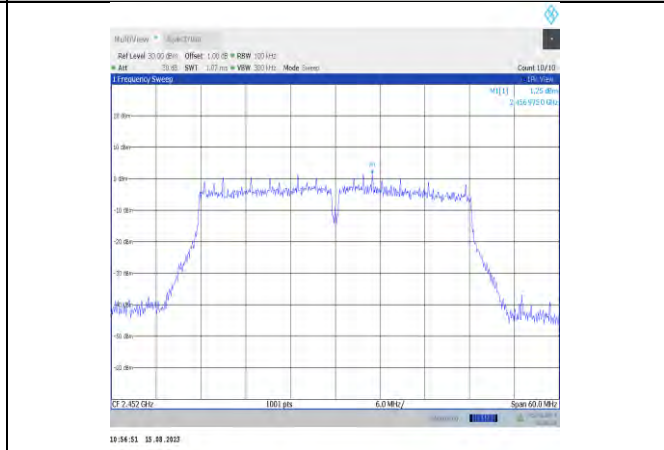

11n40MIMO-Ant8-2452-0~Reference

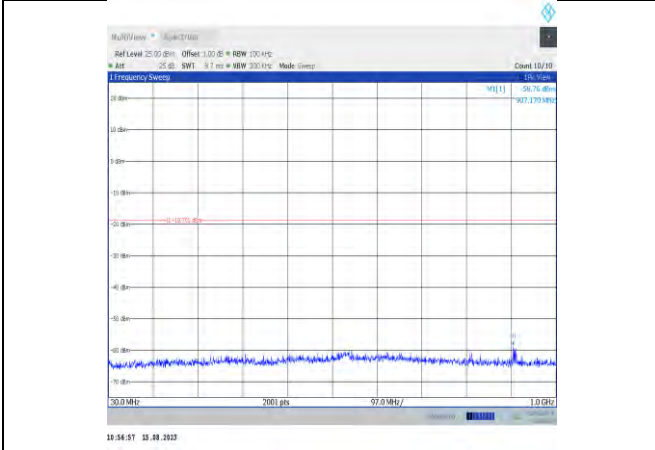

11n40MIMO-Ant8-2452-30~1000

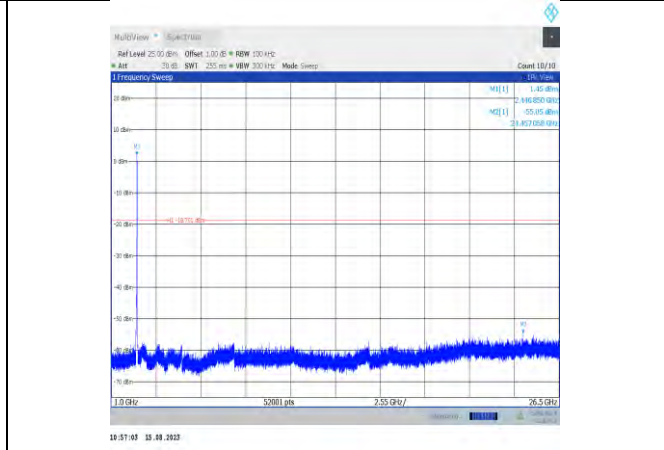

11n40MIMO-Ant8-2452-1000~26500



Unless otherwise agreed in writing, this document is issued by the Company subject to its General Conditions of Service printed overleaf, available on request or accessible at <http://www.sgs.com/en/Terms-and-Conditions.aspx> and, for electronic format documents, subject to Terms and Conditions for Electronic Documents at <http://www.sgs.com/en/Terms-and-Conditions/Terms-e-Documents.aspx>. Attention is drawn to the limitation of liability, indemnification and jurisdiction issues defined therein. Any holder of this document is advised that information contained hereon reflects the Company's findings at the time of its intervention only and within the limits of Client's instructions, if any. The Company's sole responsibility is to its Client and this document does not exonerate parties to a transaction from exercising all their rights and obligations under the transaction documents. This document cannot be reproduced except in full, without prior written approval of the Company. Any unauthorized alteration, forgery or falsification of the content or appearance of this document is unlawful and offenders may be prosecuted to the fullest extent of the law. Unless otherwise stated the results shown in this test report refer only to the sample(s) tested and such sample(s) are retained for 30 days only.

Attention: To check the authenticity of testing/inspection report & certificate, please contact us at telephone: (86-755) 8307 1443, or email: [CN.Doccheck@sgs.com](mailto:CN.Doccheck@sgs.com)

South of No. 6 Plant, No. 1, Runsheng Road, Suzhou Industrial Park, Suzhou Area, China (Jiangsu) Pilot Free Trade Zone 215000 t (86-512) 62992980 www.sgs.com.cn  
 中国·苏州·中国(江苏)自由贸易试验区苏州片区苏州工业园区润胜路1号的6号厂房南座 邮编: 215000 t (86-512) 62992980 sgs.china@sgs.com



### Duty Cycle Test Result

TestMode	Antenna	Frequency[MHz]	Transmission Duration [ms]	Transmission Period [ms]	Duty Cycle [%]	Factor
11b-CDD	Ant10	2412	12.44	12.60	98.73	0.06
11b-CDD	Ant8	2412	12.44	12.59	98.81	0.05
11g-CDD	Ant10	2412	2.07	2.11	98.10	0.08
11g-CDD	Ant8	2412	2.07	2.10	98.57	0.06
11n20MIMO	Ant10	2412	1.92	1.96	97.96	0.09
11n20MIMO	Ant8	2412	1.92	1.96	97.96	0.09
11n40MIMO	Ant10	2422	0.95	1.00	95.00	0.22
11n40MIMO	Ant8	2422	0.94	1.00	94.00	0.27

Note:

Radiated Emission Average VBW = 1 / T

TestMode	T[ms]	Period[ms]	Duty Cycle[%]	1/T[kHz]	VBW Setting
11b-CDD	12.44	12.59	98.81	0.08039	10Hz*
11g-CDD	2.07	2.10	98.57	0.48309	10Hz*
11n20MIMO	1.92	1.96	97.96	0.52083	0.56KHZ
11n40MIMO	0.95	1.00	95.00	1.05263	1.1KHZ

\*Duty cycle > 98% VBW setting=10Hz



Unless otherwise agreed in writing, this document is issued by the Company subject to its General Conditions of Service printed overleaf, available on request or accessible at <http://www.sgs.com/en/Terms-and-Conditions.aspx> and, for electronic format documents, subject to Terms and Conditions for Electronic Documents at <http://www.sgs.com/en/Terms-and-Conditions/Terms-e-Document.aspx>. Attention is drawn to the limitation of liability, indemnification and jurisdiction issues defined therein. Any holder of this document is advised that information contained hereon reflects the Company's findings at the time of its intervention only and within the limits of Client's instructions, if any. The Company's sole responsibility is to its Client and this document does not exonerate parties to a transaction from exercising all their rights and obligations under the transaction documents. This document cannot be reproduced except in full, without prior written approval of the Company. Any unauthorized alteration, forgery or falsification of the content or appearance of this document is unlawful and offenders may be prosecuted to the fullest extent of the law. Unless otherwise stated the results shown in this test report refer only to the sample(s) tested and such sample(s) are retained for 30 days only.

Attention: To check the authenticity of testing/inspection report & certificate, please contact us at telephone: (86-755) 8307 1443, or email: [CN.Doccheck@sgs.com](mailto:CN.Doccheck@sgs.com)

South of No. 6 Plant, No. 1, Runsheng Road, Suzhou Industrial Park, Suzhou Area, China (Jiangsu) Pilot Free Trade Zone 215000  
 中国·苏州·中国(江苏)自由贸易试验区苏州片区苏州工业园区润胜路1号的6号厂房南楼 邮编: 215000

t (86-512) 62992980 www.sgs.com.cn  
 t (86-512) 62992980 sgs.china@sgs.com

Test Graphs

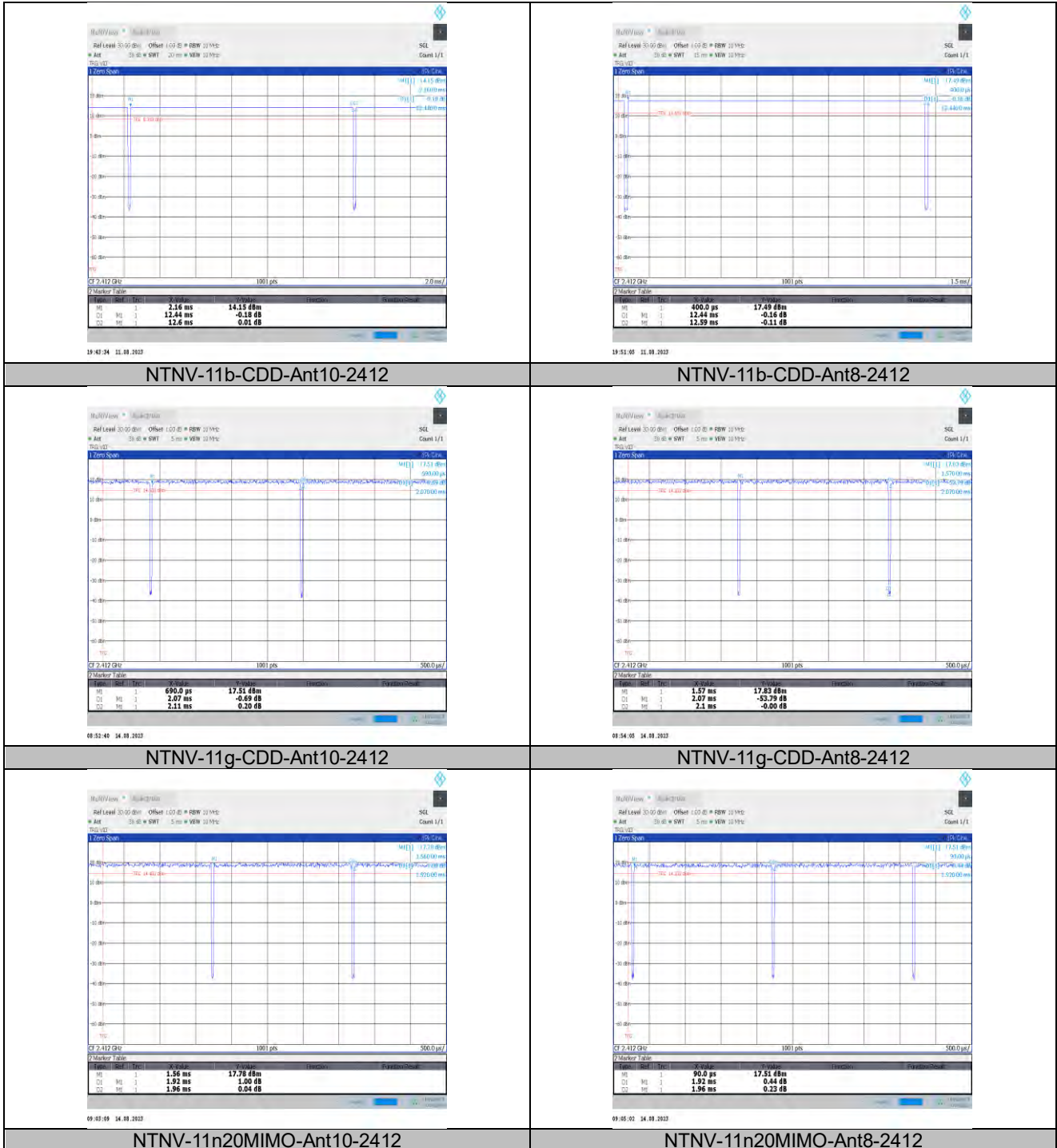

Unless otherwise agreed in writing, this document is issued by the Company subject to its General Conditions of Service printed overleaf, available on request or accessible at <http://www.sgs.com/en/Terms-and-Conditions.aspx> and, for electronic format documents, subject to Terms and Conditions for Electronic Documents at <http://www.sgs.com/en/Terms-and-Conditions/Terms-e-Documents.aspx>. Attention is drawn to the limitation of liability, indemnification and jurisdiction issues defined therein. Any holder of this document is advised that information contained hereon reflects the Company's findings at the time of its intervention only and within the limits of Client's instructions, if any. The Company's sole responsibility is to its Client and this document does not exonerate parties to a transaction from exercising all their rights and obligations under the transaction documents. This document cannot be reproduced except in full, without prior written approval of the Company. Any unauthorized alteration, forgery or falsification of the content or appearance of this document is unlawful and offenders may be prosecuted to the fullest extent of the law. Unless otherwise stated the results shown in this test report refer only to the sample(s) tested and such sample(s) are retained for 30 days only.

Attention: To check the authenticity of testing/inspection report & certificate, please contact us at telephone: (86-755) 8307 1443, or email: [CN.Doccheck@sgs.com](mailto:CN.Doccheck@sgs.com)  
 South of No. 6 Plant, No. 1, Runsheng Road, Suzhou Industrial Park, Suzhou Area, China (Jiangsu) Pilot Free Trade Zone 215000 t (86-512) 62992980 www.sgs.com.cn  
 中国·苏州·中国(江苏)自由贸易试验区苏州片区苏州工业园区润胜路1号的6号厂房南楼 邮编: 215000 t (86-512) 62992980 sgs.china@sgs.com

Report No.: SEWM2309000395RG05

Rev.: 01

Page: 67 of 131

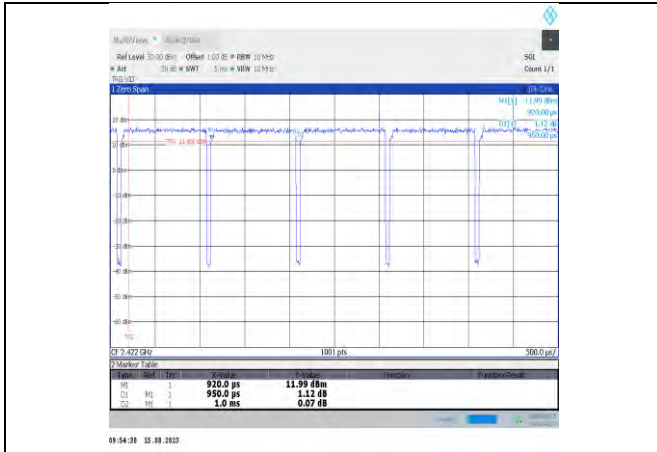

NTNV-11n40MIMO-Ant10-2422

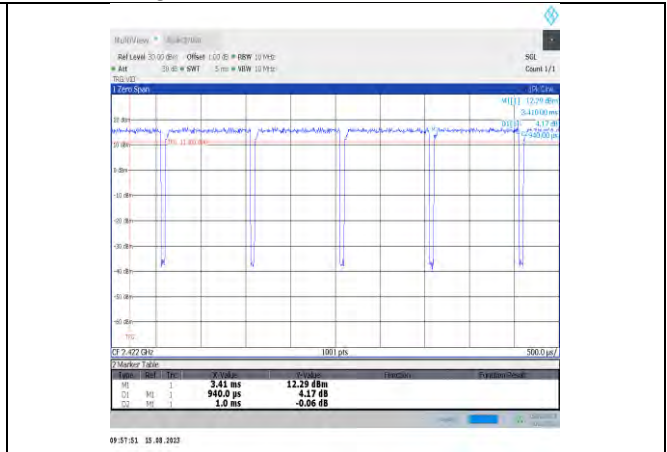

NTNV-11n40MIMO-Ant8-2422



Unless otherwise agreed in writing, this document is issued by the Company subject to its General Conditions of Service printed overleaf, available on request or accessible at <http://www.sgs.com/en/Terms-and-Conditions.aspx> and, for electronic format documents, subject to Terms and Conditions for Electronic Documents at <http://www.sgs.com/en/Terms-and-Conditions/Terms-e-Documents.aspx>. Attention is drawn to the limitation of liability, indemnification and jurisdiction issues defined therein. Any holder of this document is advised that information contained hereon reflects the Company's findings at the time of its intervention only and within the limits of Client's instructions, if any. The Company's sole responsibility is to its Client and this document does not exonerate parties to a transaction from exercising all their rights and obligations under the transaction documents. This document cannot be reproduced except in full, without prior written approval of the Company. Any unauthorized alteration, forgery or falsification of the content or appearance of this document is unlawful and offenders may be prosecuted to the fullest extent of the law. Unless otherwise stated the results shown in this test report refer only to the sample(s) tested and such sample(s) are retained for 30 days only.

Attention: To check the authenticity of testing/inspection report & certificate, please contact us at telephone: (86-755) 8307 1443, or email: [CN.Doccheck@sgs.com](mailto:CN.Doccheck@sgs.com)

South of No. 6 Plant, No. 1, Runsheng Road, Suzhou Industrial Park, Suzhou Area, China (Jiangsu) Pilot Free Trade Zone 215000 t (86-512) 62992980 www.sgsgroup.com.cn  
 中国·苏州·中国(江苏)自由贸易试验区苏州片区苏州工业园区润胜路1号的6号厂房南楼 邮编: 215000 t (86-512) 62992980 sgs.china@sgs.com

## Radiated Spurious Emissions

### Radiated emission below 1GHz

#### Worst case Mode: 802.11n40\_Channel 03

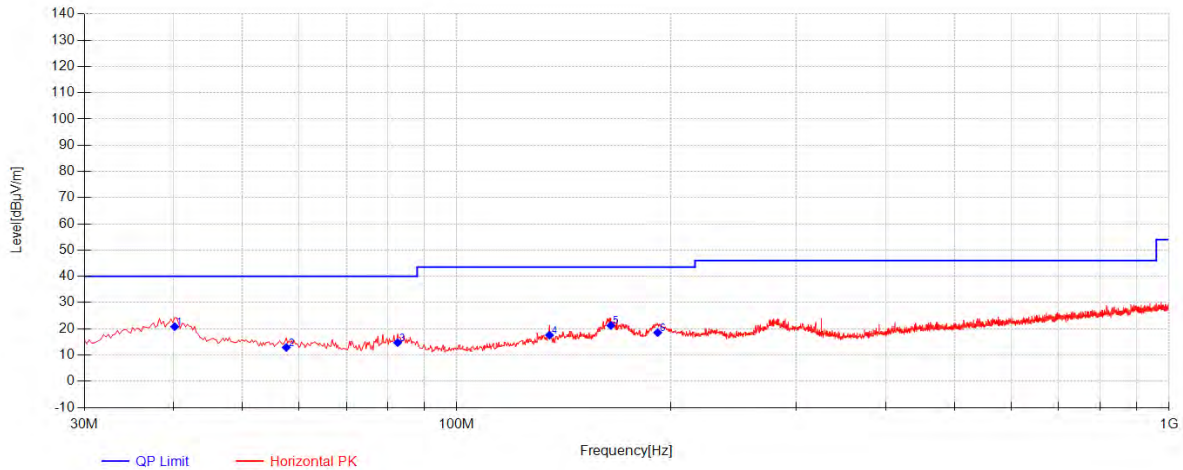

Data List										
NO.	Frequency [MHz]	Reading [dBμV]	Factor [dB]	AF [dB/m]	QP Value [dBμV/m]	QP Limit [dBμV/m]	QP Margin [dB]	Height [cm]	Angle [°]	Polarity
1	40.185	43.02	-36.27	14.05	20.81	40.00	19.19	211	161	Horizontal
2	57.645	36.29	-36.34	12.94	12.89	40.00	27.11	210	360	Horizontal
3	82.6225	41.22	-35.84	9.33	14.71	40.00	25.29	130	314	Horizontal
4	135.0025	40.03	-35.59	13.15	17.59	43.50	25.91	261	359	Horizontal
5	164.5875	42.19	-35.24	14.26	21.22	43.50	22.28	148	357	Horizontal
6	191.505	41.99	-35.38	11.93	18.54	43.50	24.96	196	231	Horizontal



Unless otherwise agreed in writing, this document is issued by the Company subject to its General Conditions of Service printed overleaf, available on request or accessible at <http://www.sgs.com/en/Terms-and-Conditions.aspx> and, for electronic format documents, subject to Terms and Conditions for Electronic Documents at <http://www.sgs.com/en/Terms-and-Conditions/Terms-e-Documents.aspx>. Attention is drawn to the limitation of liability, indemnification and jurisdiction issues defined therein. Any holder of this document is advised that information contained hereon reflects the Company's findings at the time of its intervention only and within the limits of Client's instructions, if any. The Company's sole responsibility is to its Client and this document does not exonerate parties to a transaction from exercising all their rights and obligations under the transaction documents. This document cannot be reproduced except in full, without prior written approval of the Company. Any unauthorized alteration, forgery or falsification of the content or appearance of this document is unlawful and offenders may be prosecuted to the fullest extent of the law. Unless otherwise stated the results shown in this test report refer only to the sample(s) tested and such sample(s) are retained for 30 days only.

Attention: To check the authenticity of testing/inspection report & certificate, please contact us at telephone: (86-755) 8307 1443, or email: [CN.Doccheck@sgs.com](mailto:CN.Doccheck@sgs.com)  
 South of No. 6 Plant, No. 1, Runsheng Road, Suzhou Industrial Park, Suzhou Area, China (Jiangsu) Pilot Free Trade Zone 215000 t (86-512) 62992980 www.sgsgroup.com.cn  
 中国·苏州·中国(江苏)自由贸易试验区苏州片区苏州工业园区润胜路1号的6号厂房南楼 邮编: 215000 t (86-512) 62992980 sgs.china@sgs.com

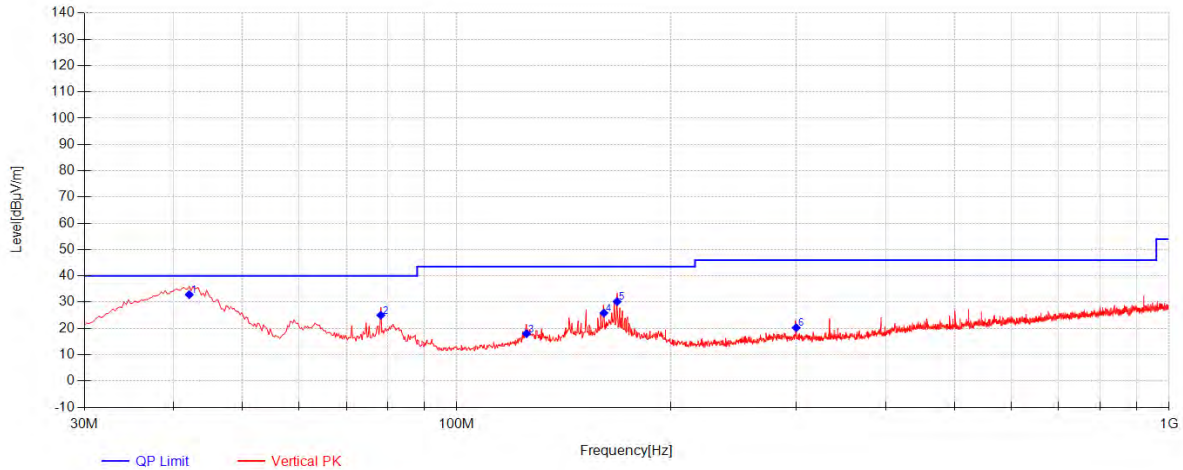

Data List										
NO.	Frequency [MHz]	Reading [dBµV]	Factor [dB]	AF [dB/m]	QP Value [dBµV/m]	QP Limit [dBµV/m]	QP Margin [dB]	Height [cm]	Angle [°]	Polarity
1	42.125	55.22	-36.24	13.89	32.87	40.00	7.13	153	188	Vertical
2	78.2575	51.26	-35.79	9.56	25.03	40.00	14.97	126	250	Vertical
3	125.3025	41.33	-35.88	12.53	17.98	43.50	25.52	231	96	Vertical
4	160.95	47.03	-35.30	14.17	25.89	43.50	17.61	166	127	Vertical
5	167.9825	51.03	-35.18	14.36	30.21	43.50	13.29	145	158	Vertical
6	299.66	41.82	-34.33	12.79	20.28	46.00	25.72	178	178	Vertical

Remark:

- The field strength is calculated by adding the Antenna Factor, Cable Factor & Pre-amplifier gain. The basic equation with a sample calculation is as follows:  
 Value = Reading(dBµV) + AF(dB/m) + Factor(dB):  
 AF = Antenna Factor(dB/m)  
 Factor = Cable Factor(dB) - Pre-amplifier gain(dB)  
 Margin = Limit(dBµV/m) – Value(dBµV/m)
- All channels have been tested, but only the worst case data displayed in this report.



Unless otherwise agreed in writing, this document is issued by the Company subject to its General Conditions of Service printed overleaf, available on request or accessible at <http://www.sgs.com/en/Terms-and-Conditions.aspx> and, for electronic format documents, subject to Terms and Conditions for Electronic Documents at <http://www.sgs.com/en/Terms-and-Conditions/Terms-e-Documents.aspx>. Attention is drawn to the limitation of liability, indemnification and jurisdiction issues defined therein. Any holder of this document is advised that information contained hereon reflects the Company's findings at the time of its intervention only and within the limits of Client's instructions, if any. The Company's sole responsibility is to its Client and this document does not exonerate parties to a transaction from exercising all their rights and obligations under the transaction documents. This document cannot be reproduced except in full, without prior written approval of the Company. Any unauthorized alteration, forgery or falsification of the content or appearance of this document is unlawful and offenders may be prosecuted to the fullest extent of the law. Unless otherwise stated the results shown in this test report refer only to the sample(s) tested and such sample(s) are retained for 30 days only.

Attention: To check the authenticity of testing/inspection report & certificate, please contact us at telephone: (86-755) 8307 1443, or email: [CN.Doccheck@sgs.com](mailto:CN.Doccheck@sgs.com)  
 South of No. 6 Plant, No. 1, Runsheng Road, Suzhou Industrial Park, Suzhou Area, China (Jiangsu) Pilot Free Trade Zone 215000 t (86-512) 62992980 www.sgs.com.cn  
 中国·苏州·中国(江苏)自由贸易试验区苏州片区苏州工业园区润胜路1号的6号厂房南楼 邮编: 215000 t (86-512) 62992980 sgs.china@sgs.com

### Transmitter emission Above 1GHz

#### 802.11b\_Channel 01

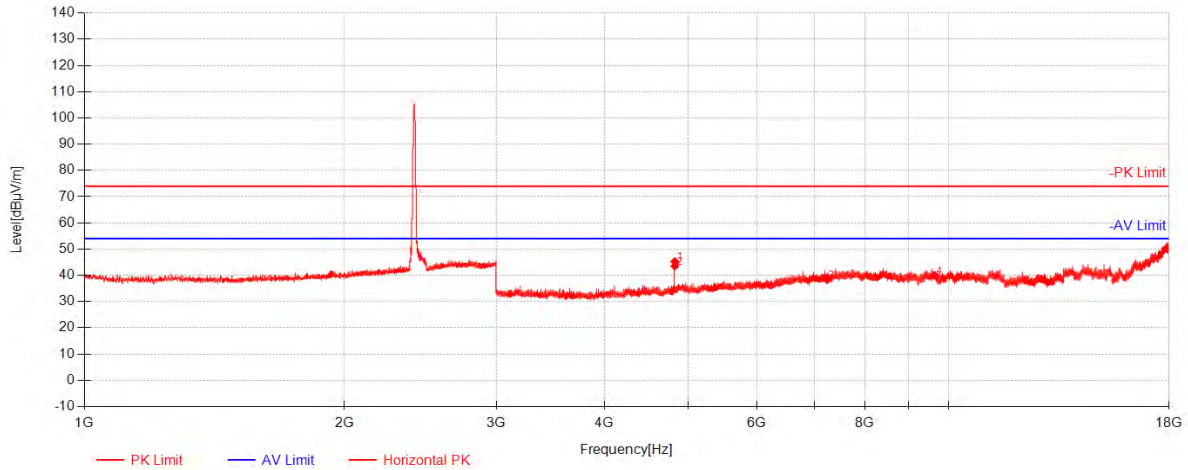

Data List										
NO.	Frequency [MHz]	Reading [dBµV]	AF [dB/m]	Factor [dB]	Level [dBµV/m]	Limit [dBµV/m]	Margin [dB]	Height [cm]	Angle [°]	Polarity
1	4824.0000	59.78	31.01	-45.54	45.26	74.00	28.74	245	6	Horizontal
2	4824.5	58.01	31.01	-45.54	43.49	54.00	10.51	136	23	Horizontal
3	7236.0000	45.99	35.86	-43.54	38.31	74.00	35.69	256	357	Horizontal
4	9648.0000	41.90	37.53	-39.56	39.87	74.00	34.13	169	0	Horizontal



Unless otherwise agreed in writing, this document is issued by the Company subject to its General Conditions of Service printed overleaf, available on request or accessible at <http://www.sgs.com/en/Terms-and-Conditions.aspx> and, for electronic format documents, subject to Terms and Conditions for Electronic Documents at <http://www.sgs.com/en/Terms-and-Conditions/Terms-e-Documents.aspx>. Attention is drawn to the limitation of liability, indemnification and jurisdiction issues defined therein. Any holder of this document is advised that information contained hereon reflects the Company's findings at the time of its intervention only and within the limits of Client's instructions, if any. The Company's sole responsibility is to its Client and this document does not exonerate parties to a transaction from exercising all their rights and obligations under the transaction documents. This document cannot be reproduced except in full, without prior written approval of the Company. Any unauthorized alteration, forgery or falsification of the content or appearance of this document is unlawful and offenders may be prosecuted to the fullest extent of the law. Unless otherwise stated the results shown in this test report refer only to the sample(s) tested and such sample(s) are retained for 30 days only.

Attention: To check the authenticity of testing/inspection report & certificate, please contact us at telephone: (86-755) 8307 1443, or email: [CN.Doccheck@sgs.com](mailto:CN.Doccheck@sgs.com)

South of No. 6 Plant, No. 1, Runsheng Road, Suzhou Industrial Park, Suzhou Area, China (Jiangsu) Pilot Free Trade Zone 215000 t (86-512) 62992980 www.sgsgroup.com.cn  
 中国·苏州·中国(江苏)自由贸易试验区苏州片区苏州工业园区润胜路1号的6号厂房南楼 邮编: 215000 t (86-512) 62992980 sgs.china@sgs.com

802.11b\_Channel 01

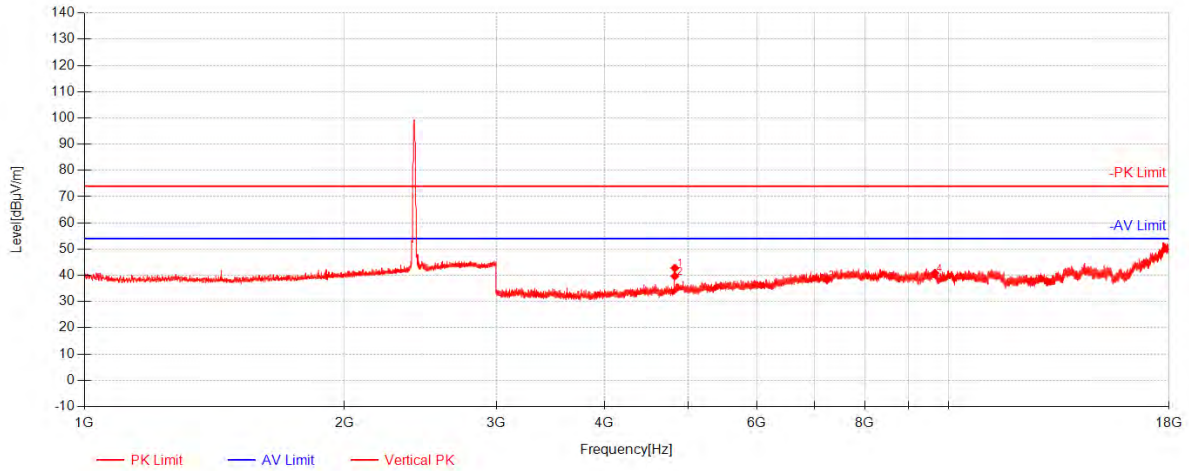

Data List										
NO.	Frequency [MHz]	Reading [dBµV]	AF [dB/m]	Factor [dB]	Level [dBµV/m]	Limit [dBµV/m]	Margin [dB]	Height [cm]	Angle [°]	Polarity
1	4824.0000	57.28	31.01	-45.54	42.76	74.00	31.24	244	190	Vertical
2	4824.5	54.21	31.01	-45.54	39.69	54.00	14.31	185	219	Vertical
3	7236.0000	45.93	35.86	-43.54	38.25	74.00	35.75	196	174	Vertical
4	9648.0000	42.90	37.53	-39.56	40.87	74.00	33.13	251	142	Vertical



Unless otherwise agreed in writing, this document is issued by the Company subject to its General Conditions of Service printed overleaf, available on request or accessible at <http://www.sgs.com/en/Terms-and-Conditions.aspx> and, for electronic format documents, subject to Terms and Conditions for Electronic Documents at <http://www.sgs.com/en/Terms-and-Conditions/Terms-e-Documents.aspx>. Attention is drawn to the limitation of liability, indemnification and jurisdiction issues defined therein. Any holder of this document is advised that information contained hereon reflects the Company's findings at the time of its intervention only and within the limits of Client's instructions, if any. The Company's sole responsibility is to its Client and this document does not exonerate parties to a transaction from exercising all their rights and obligations under the transaction documents. This document cannot be reproduced except in full, without prior written approval of the Company. Any unauthorized alteration, forgery or falsification of the content or appearance of this document is unlawful and offenders may be prosecuted to the fullest extent of the law. Unless otherwise stated the results shown in this test report refer only to the sample(s) tested and such sample(s) are retained for 30 days only.

Attention: To check the authenticity of testing/inspection report & certificate, please contact us at telephone: (86-755) 8307 1443, or email: [CN.Doccheck@sgs.com](mailto:CN.Doccheck@sgs.com)  
 South of No. 6 Plant, No. 1, Runsheng Road, Suzhou Industrial Park, Suzhou Area, China (Jiangsu) Pilot Free Trade Zone 215000 t (86-512) 62992980 www.sgsgroup.com.cn  
 中国·苏州·中国(江苏)自由贸易试验区苏州片区苏州工业园区润胜路1号的6号厂房南楼 邮编: 215000 t (86-512) 62992980 sgs.china@sgs.com

802.11b\_Channel 06

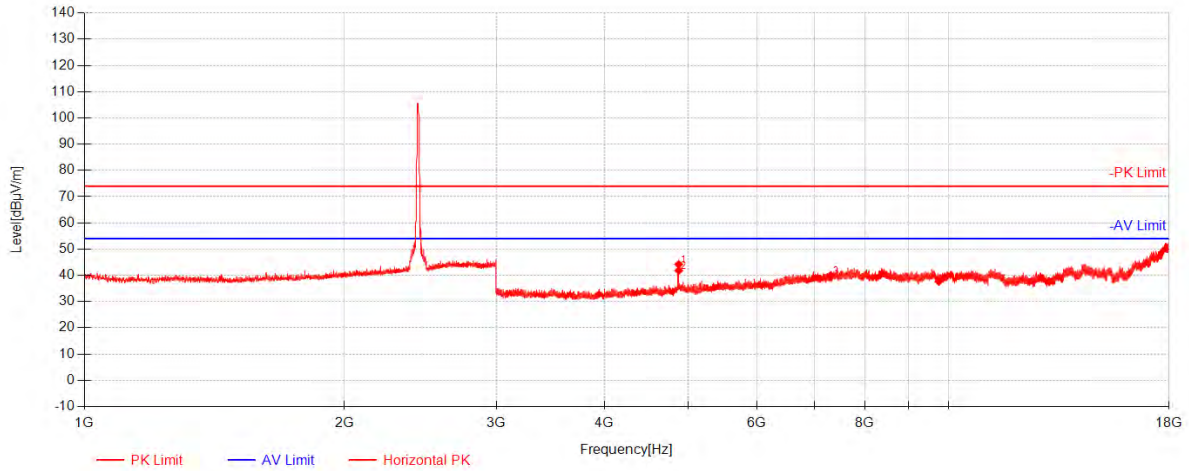

Data List										
NO.	Frequency [MHz]	Reading [dBµV]	AF [dB/m]	Factor [dB]	Level [dBµV/m]	Limit [dBµV/m]	Margin [dB]	Height [cm]	Angle [°]	Polarity
1	4874.0000	58.59	31.12	-45.53	44.18	74.00	29.82	236	22	Horizontal
2	4874.5	56.20	31.12	-45.53	41.79	54.00	12.21	142	22	Horizontal
3	7311.0000	47.60	36.07	-43.71	39.96	74.00	34.04	159	248	Horizontal
4	9748.0000	39.42	37.72	-39.46	37.68	74.00	36.32	186	50	Horizontal



Unless otherwise agreed in writing, this document is issued by the Company subject to its General Conditions of Service printed overleaf, available on request or accessible at <http://www.sgs.com/en/Terms-and-Conditions.aspx> and, for electronic format documents, subject to Terms and Conditions for Electronic Documents at <http://www.sgs.com/en/Terms-and-Conditions/Terms-e-Documents.aspx>. Attention is drawn to the limitation of liability, indemnification and jurisdiction issues defined therein. Any holder of this document is advised that information contained hereon reflects the Company's findings at the time of its intervention only and within the limits of Client's instructions, if any. The Company's sole responsibility is to its Client and this document does not exonerate parties to a transaction from exercising all their rights and obligations under the transaction documents. This document cannot be reproduced except in full, without prior written approval of the Company. Any unauthorized alteration, forgery or falsification of the content or appearance of this document is unlawful and offenders may be prosecuted to the fullest extent of the law. Unless otherwise stated the results shown in this test report refer only to the sample(s) tested and such sample(s) are retained for 30 days only.

Attention: To check the authenticity of testing/inspection report & certificate, please contact us at telephone: (86-755) 8307 1443, or email: [CN.Doccheck@sgs.com](mailto:CN.Doccheck@sgs.com)

South of No. 6 Plant, No. 1, Runsheng Road, Suzhou Industrial Park, Suzhou Area, China (Jiangsu) Pilot Free Trade Zone 215000 t (86-512) 62992980 www.sgs.com.cn  
 中国·苏州·中国(江苏)自由贸易试验区苏州片区苏州工业园区润胜路1号的6号厂房南楼 邮编: 215000 t (86-512) 62992980 sgs.china@sgs.com



802.11b\_Channel 06

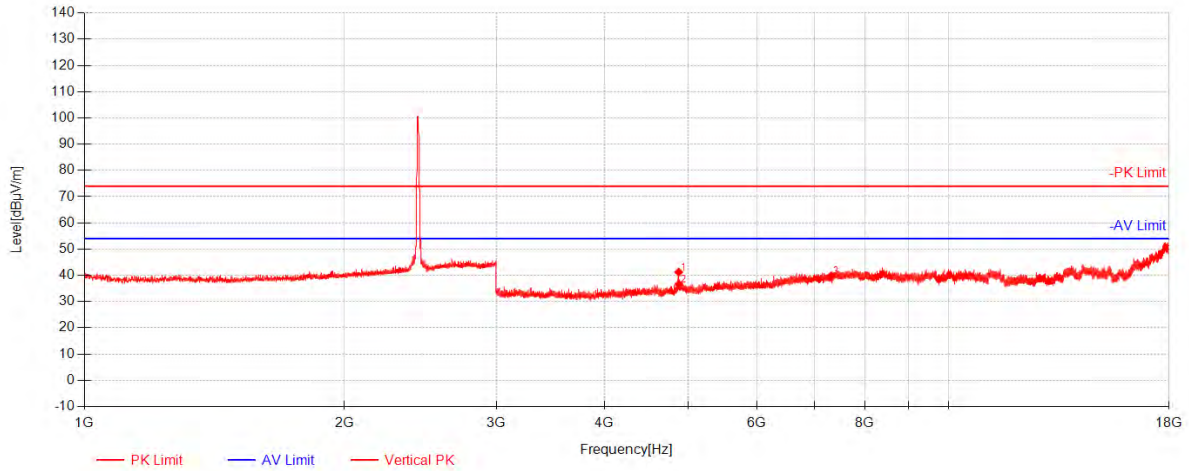

Data List										
NO.	Frequency [MHz]	Reading [dBµV]	AF [dB/m]	Factor [dB]	Level [dBµV/m]	Limit [dBµV/m]	Margin [dB]	Height [cm]	Angle [°]	Polarity
1	4874.0000	55.63	31.12	-45.53	41.22	74.00	32.78	244	219	Vertical
2	4874.5	51.05	31.12	-45.53	36.64	54.00	17.36	120	219	Vertical
3	7311.0000	47.38	36.07	-43.71	39.74	74.00	34.26	132	248	Vertical
4	9748.0000	40.38	37.72	-39.46	38.64	74.00	35.36	163	1	Vertical



Unless otherwise agreed in writing, this document is issued by the Company subject to its General Conditions of Service printed overleaf, available on request or accessible at <http://www.sgs.com/en/Terms-and-Conditions.aspx> and, for electronic format documents, subject to Terms and Conditions for Electronic Documents at <http://www.sgs.com/en/Terms-and-Conditions/Terms-e-Documents.aspx>. Attention is drawn to the limitation of liability, indemnification and jurisdiction issues defined therein. Any holder of this document is advised that information contained hereon reflects the Company's findings at the time of its intervention only and within the limits of Client's instructions, if any. The Company's sole responsibility is to its Client and this document does not exonerate parties to a transaction from exercising all their rights and obligations under the transaction documents. This document cannot be reproduced except in full, without prior written approval of the Company. Any unauthorized alteration, forgery or falsification of the content or appearance of this document is unlawful and offenders may be prosecuted to the fullest extent of the law. Unless otherwise stated the results shown in this test report refer only to the sample(s) tested and such sample(s) are retained for 30 days only.

Attention: To check the authenticity of testing/inspection report & certificate, please contact us at telephone: (86-755) 8307 1443, or email: [CN.Doccheck@sgs.com](mailto:CN.Doccheck@sgs.com)

South of No. 6 Plant, No. 1, Runsheng Road, Suzhou Industrial Park, Suzhou Area, China (Jiangsu) Pilot Free Trade Zone 215000 t (86-512) 62992980 www.sgs.com.cn  
 中国·苏州·中国(江苏)自由贸易试验区苏州片区苏州工业园区润胜路1号的6号厂房南座 邮编: 215000 t (86-512) 62992980 sgs.china@sgs.com

802.11b\_Channel 11

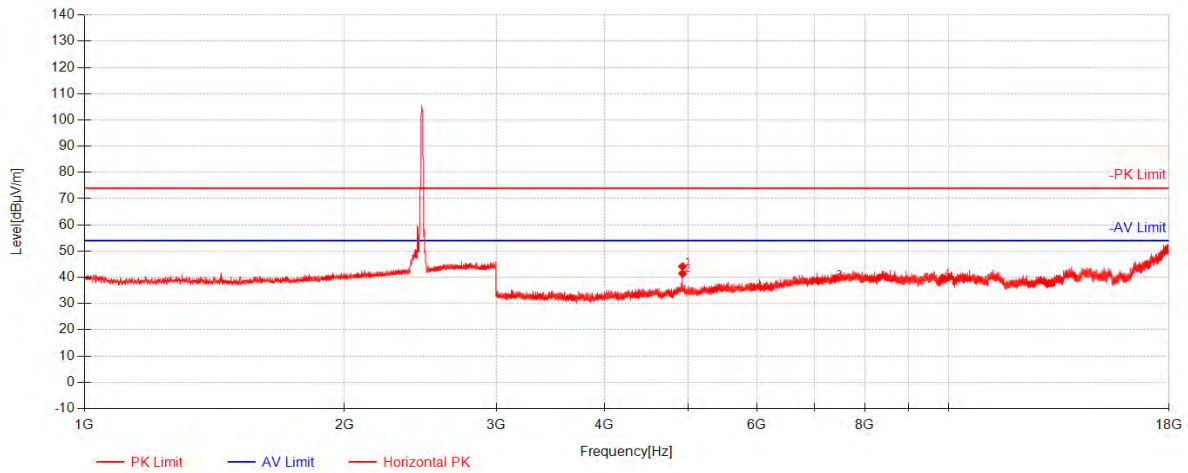

Data List										
NO.	Frequency [MHz]	Reading [dBµV]	AF [dB/m]	Factor [dB]	Level [dBµV/m]	Limit [dBµV/m]	Margin [dB]	Height [cm]	Angle [°]	Polarity
1	4924.0000	58.47	31.23	-45.56	44.15	74.00	29.85	248	0	Horizontal
2	4924.5	55.77	31.23	-45.56	41.45	54.00	12.55	175	1	Horizontal
3	7386.0000	46.54	36.28	-43.46	39.36	74.00	34.64	163	5	Horizontal
4	9848.0000	41.25	37.91	-39.41	39.75	74.00	34.25	256	6	Horizontal



Unless otherwise agreed in writing, this document is issued by the Company subject to its General Conditions of Service printed overleaf, available on request or accessible at <http://www.sgs.com/en/Terms-and-Conditions.aspx> and, for electronic format documents, subject to Terms and Conditions for Electronic Documents at <http://www.sgs.com/en/Terms-and-Conditions/Terms-e-Documents.aspx>. Attention is drawn to the limitation of liability, indemnification and jurisdiction issues defined therein. Any holder of this document is advised that information contained hereon reflects the Company's findings at the time of its intervention only and within the limits of Client's instructions, if any. The Company's sole responsibility is to its Client and this document does not exonerate parties to a transaction from exercising all their rights and obligations under the transaction documents. This document cannot be reproduced except in full, without prior written approval of the Company. Any unauthorized alteration, forgery or falsification of the content or appearance of this document is unlawful and offenders may be prosecuted to the fullest extent of the law. Unless otherwise stated the results shown in this test report refer only to the sample(s) tested and such sample(s) are retained for 30 days only.

Attention: To check the authenticity of testing/inspection report & certificate, please contact us at telephone: (86-755) 8307 1443, or email: [CN.Doccheck@sgs.com](mailto:CN.Doccheck@sgs.com)

South of No. 6 Plant, No. 1, Runsheng Road, Suzhou Industrial Park, Suzhou Area, China (Jiangsu) Pilot Free Trade Zone 215000 t (86-512) 62992980 www.sgsgroup.com.cn  
 中国·苏州·中国(江苏)自由贸易试验区苏州片区苏州工业园区润胜路1号的6号厂房南楼 邮编: 215000 t (86-512) 62992980 sgs.china@sgs.com

802.11b\_Channel 11

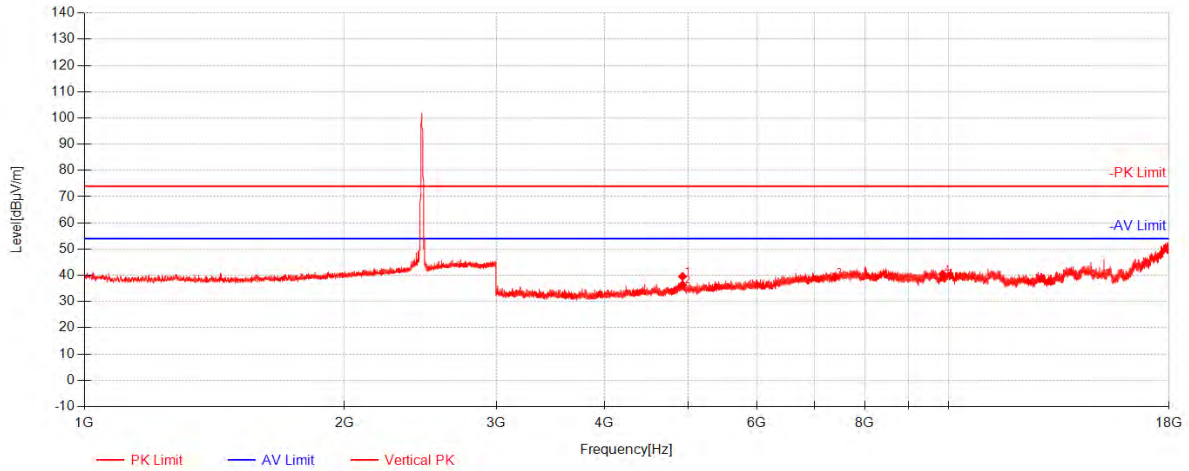

Data List										
NO.	Frequency [MHz]	Reading [dBµV]	AF [dB/m]	Factor [dB]	Level [dBµV/m]	Limit [dBµV/m]	Margin [dB]	Height [cm]	Angle [°]	Polarity
1	4924.0000	53.88	31.23	-45.56	39.56	74.00	34.44	284	194	Vertical
2	4924.5	50.68	31.23	-45.56	36.36	54.00	17.64	175	220	Vertical
3	7386.0000	46.31	36.28	-43.46	39.13	74.00	34.87	146	306	Vertical
4	9848.0000	41.98	37.91	-39.41	40.48	74.00	33.52	192	0	Vertical



Unless otherwise agreed in writing, this document is issued by the Company subject to its General Conditions of Service printed overleaf, available on request or accessible at <http://www.sgs.com/en/Terms-and-Conditions.aspx> and, for electronic format documents, subject to Terms and Conditions for Electronic Documents at <http://www.sgs.com/en/Terms-and-Conditions/Terms-e-Documents.aspx>. Attention is drawn to the limitation of liability, indemnification and jurisdiction issues defined therein. Any holder of this document is advised that information contained hereon reflects the Company's findings at the time of its intervention only and within the limits of Client's instructions, if any. The Company's sole responsibility is to its Client and this document does not exonerate parties to a transaction from exercising all their rights and obligations under the transaction documents. This document cannot be reproduced except in full, without prior written approval of the Company. Any unauthorized alteration, forgery or falsification of the content or appearance of this document is unlawful and offenders may be prosecuted to the fullest extent of the law. Unless otherwise stated the results shown in this test report refer only to the sample(s) tested and such sample(s) are retained for 30 days only.

Attention: To check the authenticity of testing/inspection report & certificate, please contact us at telephone: (86-755) 8307 1443, or email: [CN.Doccheck@sgs.com](mailto:CN.Doccheck@sgs.com)

South of No. 6 Plant, No. 1, Runsheng Road, Suzhou Industrial Park, Suzhou Area, China (Jiangsu) Pilot Free Trade Zone 215000 t (86-512) 62992980 www.sgs.com.cn  
 中国·苏州·中国(江苏)自由贸易试验区苏州片区苏州工业园区润胜路1号的6号厂房南座 邮编: 215000 t (86-512) 62992980 sgs.china@sgs.com

802.11g\_Channel 01

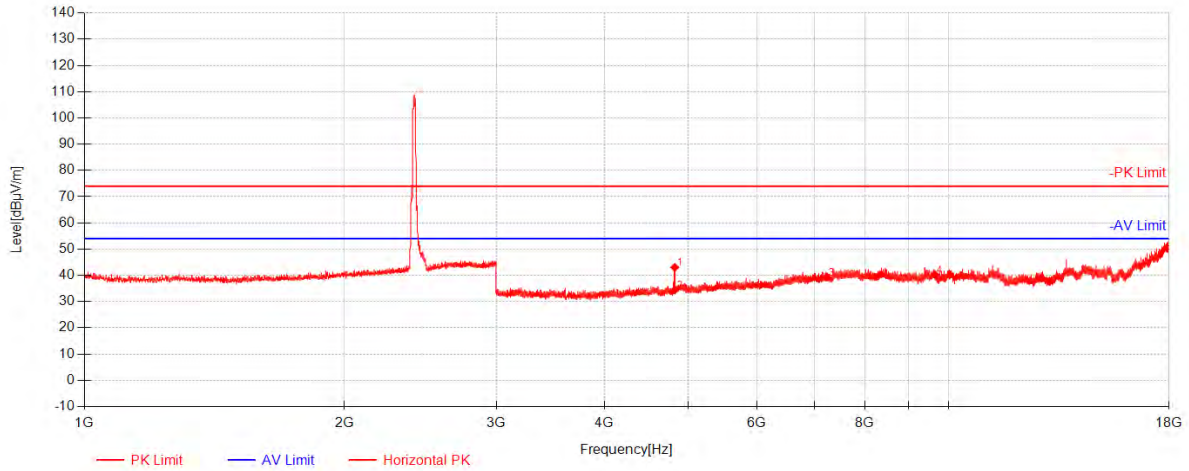

Data List										
NO.	Frequency [MHz]	Reading [dBµV]	AF [dB/m]	Factor [dB]	Level [dBµV/m]	Limit [dBµV/m]	Margin [dB]	Height [cm]	Angle [°]	Polarity
1	4823.5	57.55	31.01	-45.54	43.02	74.00	30.98	245	153	Horizontal
2	4824	48.96	31.01	-45.54	34.44	54.00	19.56	163	6	Horizontal
3	7236.0000	46.96	35.86	-43.54	39.28	74.00	34.72	251	138	Horizontal
4	9648.0000	42.32	37.53	-39.56	40.29	74.00	33.71	174	6	Horizontal



Unless otherwise agreed in writing, this document is issued by the Company subject to its General Conditions of Service printed overleaf, available on request or accessible at <http://www.sgs.com/en/Terms-and-Conditions.aspx> and, for electronic format documents, subject to Terms and Conditions for Electronic Documents at <http://www.sgs.com/en/Terms-and-Conditions/Terms-e-Documents.aspx>. Attention is drawn to the limitation of liability, indemnification and jurisdiction issues defined therein. Any holder of this document is advised that information contained hereon reflects the Company's findings at the time of its intervention only and within the limits of Client's instructions, if any. The Company's sole responsibility is to its Client and this document does not exonerate parties to a transaction from exercising all their rights and obligations under the transaction documents. This document cannot be reproduced except in full, without prior written approval of the Company. Any unauthorized alteration, forgery or falsification of the content or appearance of this document is unlawful and offenders may be prosecuted to the fullest extent of the law. Unless otherwise stated the results shown in this test report refer only to the sample(s) tested and such sample(s) are retained for 30 days only.

Attention: To check the authenticity of testing/inspection report & certificate, please contact us at telephone: (86-755) 8307 1443, or email: [CN.Doccheck@sgs.com](mailto:CN.Doccheck@sgs.com)

South of No. 6 Plant, No. 1, Runsheng Road, Suzhou Industrial Park, Suzhou Area, China (Jiangsu) Pilot Free Trade Zone 215000 t (86-512) 62992980 www.sgsgroup.com.cn  
 中国·苏州·中国(江苏)自由贸易试验区苏州片区苏州工业园区润胜路1号的6号厂房南楼 邮编: 215000 t (86-512) 62992980 sgs.china@sgs.com

802.11g\_Channel 01

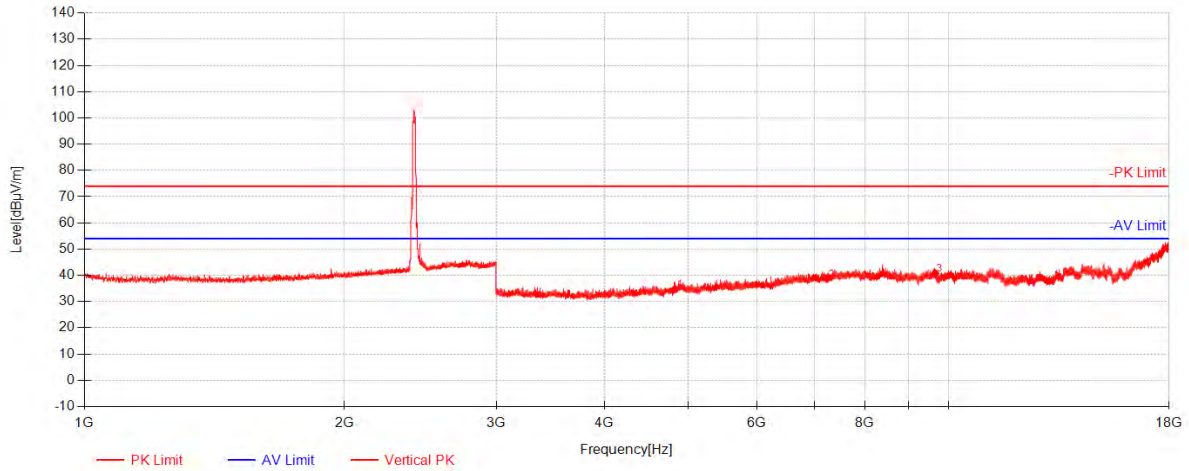

Data List										
NO.	Frequency [MHz]	Reading [dBµV]	AF [dB/m]	Factor [dB]	Level [dBµV/m]	Limit [dBµV/m]	Margin [dB]	Height [cm]	Angle [°]	Polarity
1	4824.0000	49.24	31.01	-45.54	34.72	74.00	39.28	246	190	Vertical
2	7236.0000	46.36	35.86	-43.54	38.68	74.00	35.32	126	334	Vertical
3	9648.0000	42.81	37.53	-39.56	40.78	74.00	33.22	231	0	Vertical



Unless otherwise agreed in writing, this document is issued by the Company subject to its General Conditions of Service printed overleaf, available on request or accessible at <http://www.sgs.com/en/Terms-and-Conditions.aspx> and, for electronic format documents, subject to Terms and Conditions for Electronic Documents at <http://www.sgs.com/en/Terms-and-Conditions/Terms-e-Documents.aspx>. Attention is drawn to the limitation of liability, indemnification and jurisdiction issues defined therein. Any holder of this document is advised that information contained hereon reflects the Company's findings at the time of its intervention only and within the limits of Client's instructions, if any. The Company's sole responsibility is to its Client and this document does not exonerate parties to a transaction from exercising all their rights and obligations under the transaction documents. This document cannot be reproduced except in full, without prior written approval of the Company. Any unauthorized alteration, forgery or falsification of the content or appearance of this document is unlawful and offenders may be prosecuted to the fullest extent of the law. Unless otherwise stated the results shown in this test report refer only to the sample(s) tested and such sample(s) are retained for 30 days only.

Attention: To check the authenticity of testing/inspection report & certificate, please contact us at telephone: (86-755) 8307 1443, or email: [CN.Doccheck@sgs.com](mailto:CN.Doccheck@sgs.com)

South of No. 6 Plant, No. 1, Runsheng Road, Suzhou Industrial Park, Suzhou Area, China (Jiangsu) Pilot Free Trade Zone 215000 t (86-512) 62992980 www.sgs.com.cn  
 中国·苏州·中国(江苏)自由贸易试验区苏州片区苏州工业园区润胜路1号的6号厂房南楼 邮编: 215000 t (86-512) 62992980 sgs.china@sgs.com

802.11g\_Channel 06

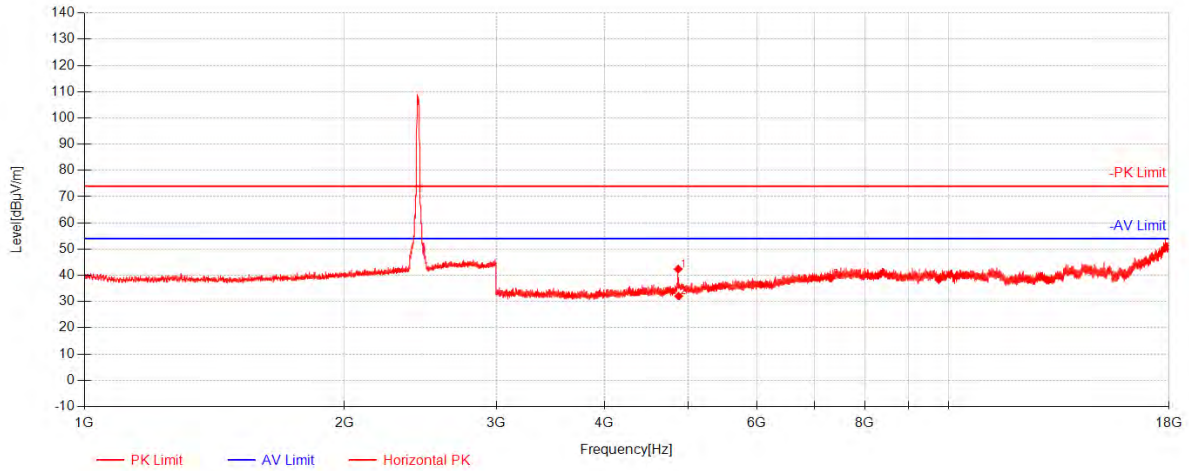

Data List										
NO.	Frequency [MHz]	Reading [dBµV]	AF [dB/m]	Factor [dB]	Level [dBµV/m]	Limit [dBµV/m]	Margin [dB]	Height [cm]	Angle [°]	Polarity
1	4868	56.81	31.11	-45.53	42.39	74.00	31.61	266	1	Horizontal
2	4874.5	46.46	31.12	-45.53	32.05	54.00	21.95	142	22	Horizontal
3	7311.0000	46.63	36.07	-43.71	38.99	74.00	35.01	136	219	Horizontal
4	9748.0000	40.16	37.72	-39.46	38.42	74.00	35.58	259	357	Horizontal



Unless otherwise agreed in writing, this document is issued by the Company subject to its General Conditions of Service printed overleaf, available on request or accessible at <http://www.sgs.com/en/Terms-and-Conditions.aspx> and, for electronic format documents, subject to Terms and Conditions for Electronic Documents at <http://www.sgs.com/en/Terms-and-Conditions/Terms-e-Documents.aspx>. Attention is drawn to the limitation of liability, indemnification and jurisdiction issues defined therein. Any holder of this document is advised that information contained hereon reflects the Company's findings at the time of its intervention only and within the limits of Client's instructions, if any. The Company's sole responsibility is to its Client and this document does not exonerate parties to a transaction from exercising all their rights and obligations under the transaction documents. This document cannot be reproduced except in full, without prior written approval of the Company. Any unauthorized alteration, forgery or falsification of the content or appearance of this document is unlawful and offenders may be prosecuted to the fullest extent of the law. Unless otherwise stated the results shown in this test report refer only to the sample(s) tested and such sample(s) are retained for 30 days only.

Attention: To check the authenticity of testing/inspection report & certificate, please contact us at telephone: (86-755) 8307 1443, or email: [CN.Doccheck@sgs.com](mailto:CN.Doccheck@sgs.com)  
 South of No. 6 Plant, No. 1, Runsheng Road, Suzhou Industrial Park, Suzhou Area, China (Jiangsu) Pilot Free Trade Zone 215000 t (86-512) 62992980 www.sgsgroup.com.cn  
 中国·苏州·中国(江苏)自由贸易试验区苏州片区苏州工业园区润胜路1号的6号厂房南楼 邮编: 215000 t (86-512) 62992980 sgs.china@sgs.com

802.11g\_Channel 06

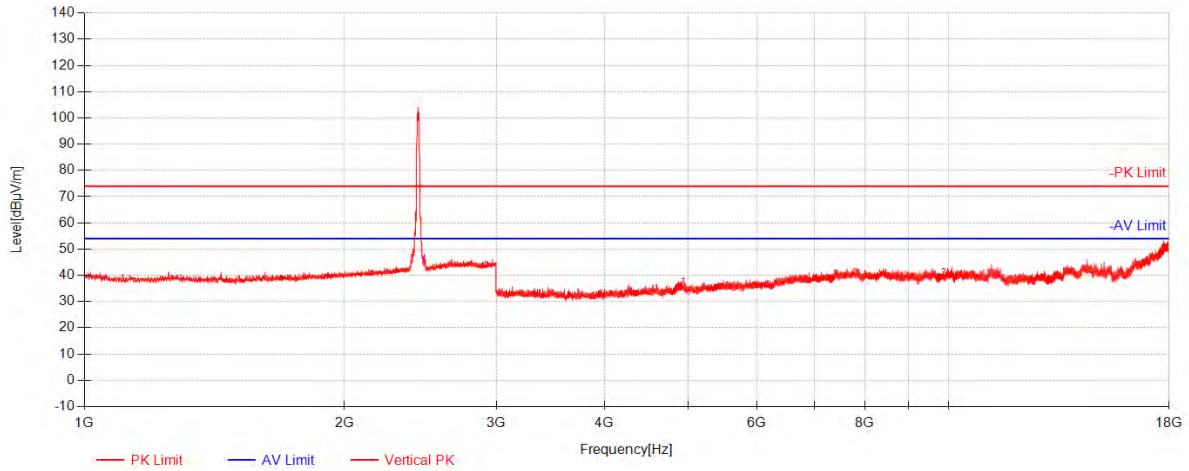

Data List										
NO.	Frequency [MHz]	Reading [dBµV]	AF [dB/m]	Factor [dB]	Level [dBµV/m]	Limit [dBµV/m]	Margin [dB]	Height [cm]	Angle [°]	Polarity
1	4874.0000	50.15	31.12	-45.53	35.74	74.00	38.26	162	276	Vertical
2	7311.0000	46.30	36.07	-43.71	38.66	74.00	35.34	211	276	Vertical
3	9748.0000	40.97	37.72	-39.46	39.23	74.00	34.77	142	305	Vertical



Unless otherwise agreed in writing, this document is issued by the Company subject to its General Conditions of Service printed overleaf, available on request or accessible at <http://www.sgs.com/en/Terms-and-Conditions.aspx> and, for electronic format documents, subject to Terms and Conditions for Electronic Documents at <http://www.sgs.com/en/Terms-and-Conditions/Terms-e-Documents.aspx>. Attention is drawn to the limitation of liability, indemnification and jurisdiction issues defined therein. Any holder of this document is advised that information contained hereon reflects the Company's findings at the time of its intervention only and within the limits of Client's instructions, if any. The Company's sole responsibility is to its Client and this document does not exonerate parties to a transaction from exercising all their rights and obligations under the transaction documents. This document cannot be reproduced except in full, without prior written approval of the Company. Any unauthorized alteration, forgery or falsification of the content or appearance of this document is unlawful and offenders may be prosecuted to the fullest extent of the law. Unless otherwise stated the results shown in this test report refer only to the sample(s) tested and such sample(s) are retained for 30 days only.

Attention: To check the authenticity of testing/inspection report & certificate, please contact us at telephone: (86-755) 8307 1443, or email: [CN.Doccheck@sgs.com](mailto:CN.Doccheck@sgs.com)  
 South of No. 6 Plant, No. 1, Runsheng Road, Suzhou Industrial Park, Suzhou Area, China (Jiangsu) Pilot Free Trade Zone 215000 t (86-512) 62992980 www.sgs.com.cn  
 中国·苏州·中国(江苏)自由贸易试验区苏州片区苏州工业园区润胜路1号的6号厂房南楼 邮编: 215000 t (86-512) 62992980 sgs.china@sgs.com

802.11g\_Channel 11

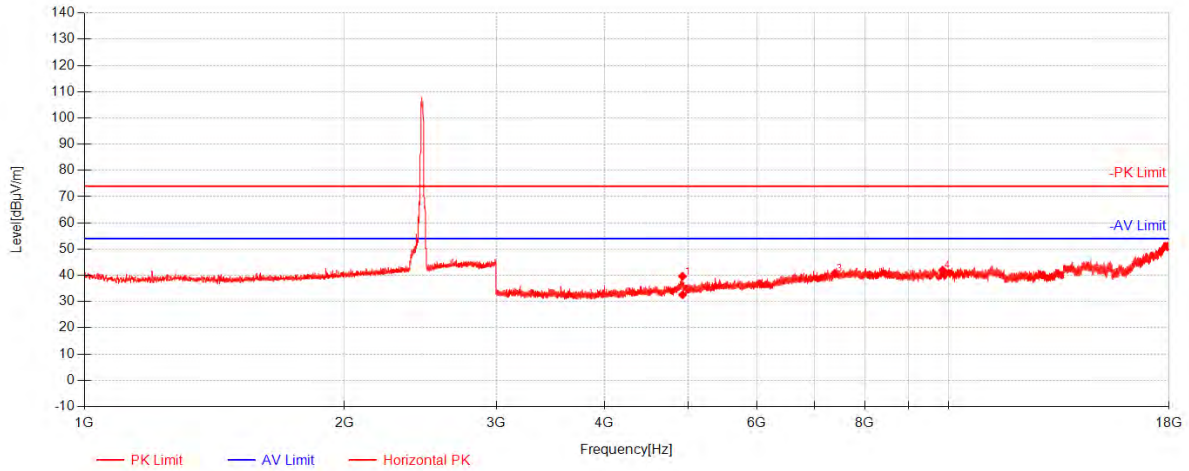

Data List										
NO.	Frequency [MHz]	Reading [dBµV]	AF [dB/m]	Factor [dB]	Level [dBµV/m]	Limit [dBµV/m]	Margin [dB]	Height [cm]	Angle [°]	Polarity
1	4924.0000	53.98	31.23	-45.56	39.66	74.00	34.34	241	6	Horizontal
2	4924.5	46.91	31.23	-45.56	32.59	54.00	21.41	168	23	Horizontal
3	7386.0000	47.92	36.28	-43.46	40.74	74.00	33.26	192	356	Horizontal
4	9848.0000	43.50	37.91	-39.41	42.00	74.00	32.00	135	1	Horizontal



Unless otherwise agreed in writing, this document is issued by the Company subject to its General Conditions of Service printed overleaf, available on request or accessible at <http://www.sgs.com/en/Terms-and-Conditions.aspx> and, for electronic format documents, subject to Terms and Conditions for Electronic Documents at <http://www.sgs.com/en/Terms-and-Conditions/Terms-e-Documents.aspx>. Attention is drawn to the limitation of liability, indemnification and jurisdiction issues defined therein. Any holder of this document is advised that information contained hereon reflects the Company's findings at the time of its intervention only and within the limits of Client's instructions, if any. The Company's sole responsibility is to its Client and this document does not exonerate parties to a transaction from exercising all their rights and obligations under the transaction documents. This document cannot be reproduced except in full, without prior written approval of the Company. Any unauthorized alteration, forgery or falsification of the content or appearance of this document is unlawful and offenders may be prosecuted to the fullest extent of the law. Unless otherwise stated the results shown in this test report refer only to the sample(s) tested and such sample(s) are retained for 30 days only.

Attention: To check the authenticity of testing/inspection report & certificate, please contact us at telephone: (86-755) 8307 1443, or email: [CN.Doccheck@sgs.com](mailto:CN.Doccheck@sgs.com)

South of No. 6 Plant, No. 1, Runsheng Road, Suzhou Industrial Park, Suzhou Area, China (Jiangsu) Pilot Free Trade Zone 215000 t (86-512) 62992980 www.sgsgroup.com.cn  
 中国·苏州·中国(江苏)自由贸易试验区苏州片区苏州工业园区润胜路1号的6号厂房南楼 邮编: 215000 t (86-512) 62992980 sgs.china@sgs.com



802.11g\_Channel 11

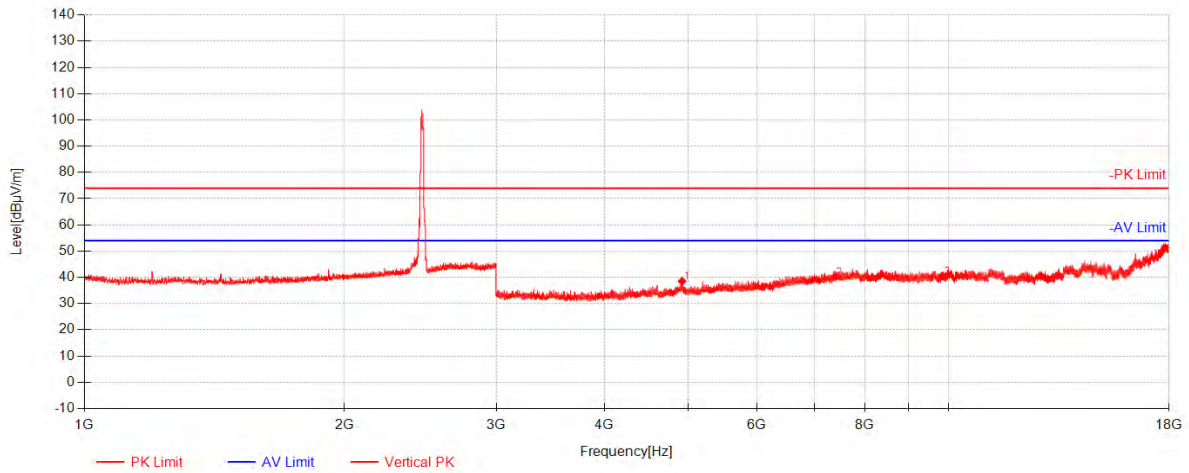

Data List										
NO.	Frequency [MHz]	Reading [dBµV]	AF [dB/m]	Factor [dB]	Level [dBµV/m]	Limit [dBµV/m]	Margin [dB]	Height [cm]	Angle [°]	Polarity
1	4918.5	52.84	31.22	-45.55	38.51	74.00	35.49	246	164	Vertical
2	7386.0000	47.40	36.28	-43.46	40.22	74.00	33.78	186	332	Vertical
3	9848.0000	41.94	37.91	-39.41	40.44	74.00	33.56	133	193	Vertical



Unless otherwise agreed in writing, this document is issued by the Company subject to its General Conditions of Service printed overleaf, available on request or accessible at <http://www.sgs.com/en/Terms-and-Conditions.aspx> and, for electronic format documents, subject to Terms and Conditions for Electronic Documents at <http://www.sgs.com/en/Terms-and-Conditions/Terms-e-Documents.aspx>. Attention is drawn to the limitation of liability, indemnification and jurisdiction issues defined therein. Any holder of this document is advised that information contained hereon reflects the Company's findings at the time of its intervention only and within the limits of Client's instructions, if any. The Company's sole responsibility is to its Client and this document does not exonerate parties to a transaction from exercising all their rights and obligations under the transaction documents. This document cannot be reproduced except in full, without prior written approval of the Company. Any unauthorized alteration, forgery or falsification of the content or appearance of this document is unlawful and offenders may be prosecuted to the fullest extent of the law. Unless otherwise stated the results shown in this test report refer only to the sample(s) tested and such sample(s) are retained for 30 days only.

Attention: To check the authenticity of testing/inspection report & certificate, please contact us at telephone: (86-755) 8307 1443, or email: [CN.Doccheck@sgs.com](mailto:CN.Doccheck@sgs.com)

South of No. 6 Plant, No. 1, Runsheng Road, Suzhou Industrial Park, Suzhou Area, China (Jiangsu) Pilot Free Trade Zone 215000 t (86-512) 62992980 www.sgsgroup.com.cn  
 中国·苏州·中国(江苏)自由贸易试验区苏州片区苏州工业园区润胜路1号的6号厂房南楼 邮编: 215000 t (86-512) 62992980 sgs.china@sgs.com

802.11n20\_Channel 01

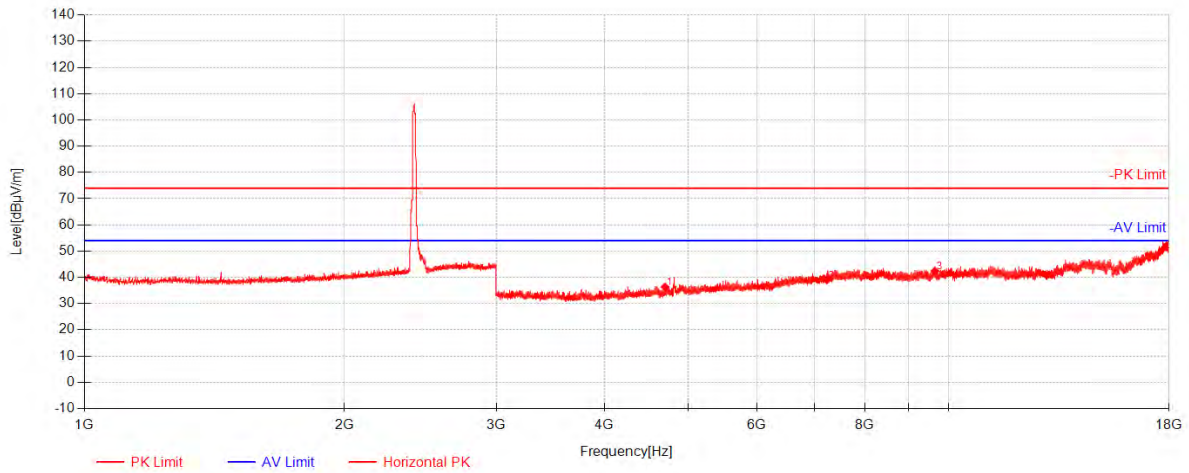

Data List										
NO.	Frequency [MHz]	Reading [dBµV]	AF [dB/m]	Factor [dB]	Level [dBµV/m]	Limit [dBµV/m]	Margin [dB]	Height [cm]	Angle [°]	Polarity
1	4699	51.19	30.74	-45.60	36.33	74.00	37.67	256	220	Horizontal
2	7236.0000	46.69	35.86	-43.54	39.01	74.00	34.99	142	221	Horizontal
3	9648.0000	44.44	37.53	-39.56	42.41	74.00	31.59	198	275	Horizontal



Unless otherwise agreed in writing, this document is issued by the Company subject to its General Conditions of Service printed overleaf, available on request or accessible at <http://www.sgs.com/en/Terms-and-Conditions.aspx> and, for electronic format documents, subject to Terms and Conditions for Electronic Documents at <http://www.sgs.com/en/Terms-and-Conditions/Terms-e-Documents.aspx>. Attention is drawn to the limitation of liability, indemnification and jurisdiction issues defined therein. Any holder of this document is advised that information contained hereon reflects the Company's findings at the time of its intervention only and within the limits of Client's instructions, if any. The Company's sole responsibility is to its Client and this document does not exonerate parties to a transaction from exercising all their rights and obligations under the transaction documents. This document cannot be reproduced except in full, without prior written approval of the Company. Any unauthorized alteration, forgery or falsification of the content or appearance of this document is unlawful and offenders may be prosecuted to the fullest extent of the law. Unless otherwise stated the results shown in this test report refer only to the sample(s) tested and such sample(s) are retained for 30 days only.

Attention: To check the authenticity of testing/inspection report & certificate, please contact us at telephone: (86-755) 8307 1443, or email: [CN.Doccheck@sgs.com](mailto:CN.Doccheck@sgs.com)

South of No. 6 Plant, No. 1, Runsheng Road, Suzhou Industrial Park, Suzhou Area, China (Jiangsu) Pilot Free Trade Zone 215000 t (86-512) 62992980 www.sgs.com.cn  
 中国·苏州·中国(江苏)自由贸易试验区苏州片区苏州工业园区润胜路1号的6号厂房南楼 邮编: 215000 t (86-512) 62992980 sgs.china@sgs.com

802.11n20\_Channel 01

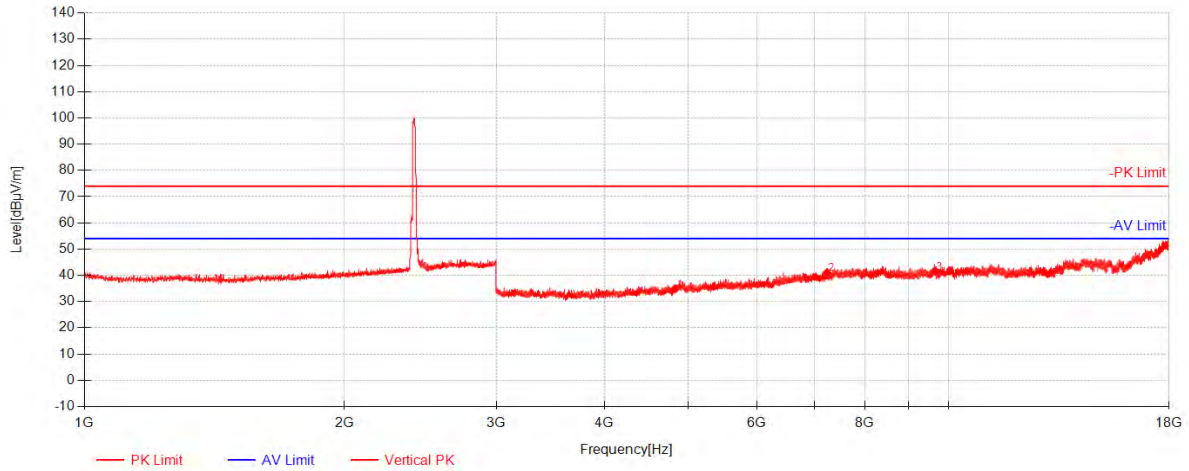

Data List										
NO.	Frequency [MHz]	Reading [dBµV]	AF [dB/m]	Factor [dB]	Level [dBµV/m]	Limit [dBµV/m]	Margin [dB]	Height [cm]	Angle [°]	Polarity
1	4824.0000	49.44	31.01	-45.54	34.92	74.00	39.08	213	221	Vertical
2	7236.0000	48.80	35.86	-43.54	41.12	74.00	32.88	261	248	Vertical
3	9648.0000	43.69	37.53	-39.56	41.66	74.00	32.34	148	135	Vertical



Unless otherwise agreed in writing, this document is issued by the Company subject to its General Conditions of Service printed overleaf, available on request or accessible at <http://www.sgs.com/en/Terms-and-Conditions.aspx> and, for electronic format documents, subject to Terms and Conditions for Electronic Documents at <http://www.sgs.com/en/Terms-and-Conditions/Terms-e-Documents.aspx>. Attention is drawn to the limitation of liability, indemnification and jurisdiction issues defined therein. Any holder of this document is advised that information contained hereon reflects the Company's findings at the time of its intervention only and within the limits of Client's instructions, if any. The Company's sole responsibility is to its Client and this document does not exonerate parties to a transaction from exercising all their rights and obligations under the transaction documents. This document cannot be reproduced except in full, without prior written approval of the Company. Any unauthorized alteration, forgery or falsification of the content or appearance of this document is unlawful and offenders may be prosecuted to the fullest extent of the law. Unless otherwise stated the results shown in this test report refer only to the sample(s) tested and such sample(s) are retained for 30 days only.

Attention: To check the authenticity of testing/inspection report & certificate, please contact us at telephone: (86-755) 8307 1443, or email: [CN.Doccheck@sgs.com](mailto:CN.Doccheck@sgs.com)

South of No. 6 Plant, No. 1, Runsheng Road, Suzhou Industrial Park, Suzhou Area, China (Jiangsu) Pilot Free Trade Zone 215000 t (86-512) 62992980 www.sgsgroup.com.cn  
 中国·苏州·中国(江苏)自由贸易试验区苏州片区苏州工业园区润胜路1号的6号厂房南楼 邮编: 215000 t (86-512) 62992980 sgs.china@sgs.com

802.11n20\_Channel 06

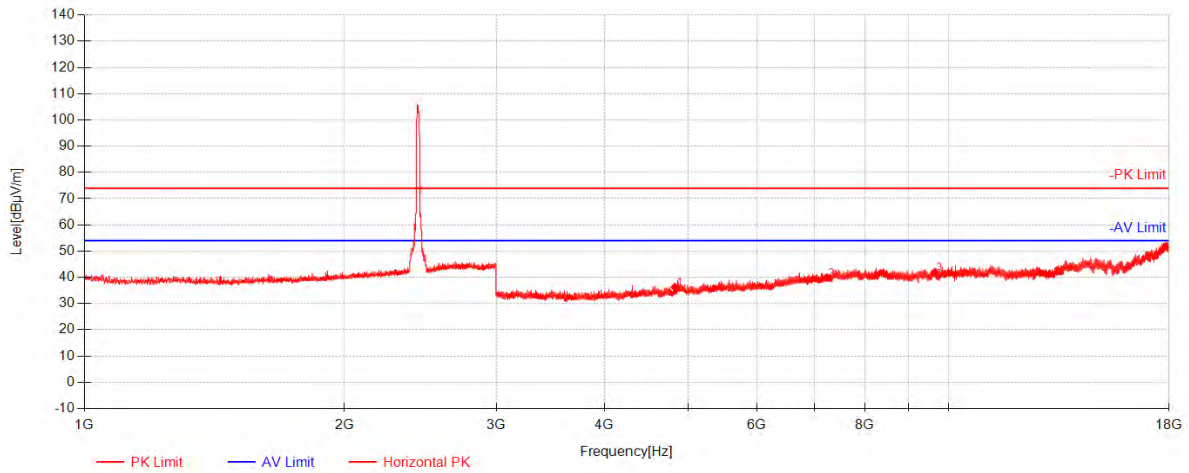

Data List										
NO.	Frequency [MHz]	Reading [dBµV]	AF [dB/m]	Factor [dB]	Level [dBµV/m]	Limit [dBµV/m]	Margin [dB]	Height [cm]	Angle [°]	Polarity
1	4824.0000	50.78	31.01	-45.54	36.26	74.00	37.74	211	280	Horizontal
2	7236.0000	47.52	35.86	-43.54	39.84	74.00	34.16	148	168	Horizontal
3	9648.0000	44.02	37.53	-39.56	41.99	74.00	32.01	175	0	Horizontal



Unless otherwise agreed in writing, this document is issued by the Company subject to its General Conditions of Service printed overleaf, available on request or accessible at <http://www.sgs.com/en/Terms-and-Conditions.aspx> and, for electronic format documents, subject to Terms and Conditions for Electronic Documents at <http://www.sgs.com/en/Terms-and-Conditions/Terms-e-Documents.aspx>. Attention is drawn to the limitation of liability, indemnification and jurisdiction issues defined therein. Any holder of this document is advised that information contained hereon reflects the Company's findings at the time of its intervention only and within the limits of Client's instructions, if any. The Company's sole responsibility is to its Client and this document does not exonerate parties to a transaction from exercising all their rights and obligations under the transaction documents. This document cannot be reproduced except in full, without prior written approval of the Company. Any unauthorized alteration, forgery or falsification of the content or appearance of this document is unlawful and offenders may be prosecuted to the fullest extent of the law. Unless otherwise stated the results shown in this test report refer only to the sample(s) tested and such sample(s) are retained for 30 days only.

Attention: To check the authenticity of testing/inspection report & certificate, please contact us at telephone: (86-755) 8307 1443, or email: [CN.Doccheck@sgs.com](mailto:CN.Doccheck@sgs.com)

South of No. 6 Plant, No. 1, Runsheng Road, Suzhou Industrial Park, Suzhou Area, China (Jiangsu) Pilot Free Trade Zone 215000 t (86-512) 62992980 www.sgs.com.cn  
 中国·苏州·中国(江苏)自由贸易试验区苏州片区苏州工业园区润胜路1号的6号厂房南楼 邮编: 215000 t (86-512) 62992980 sgs.china@sgs.com

802.11n20\_Channel 06

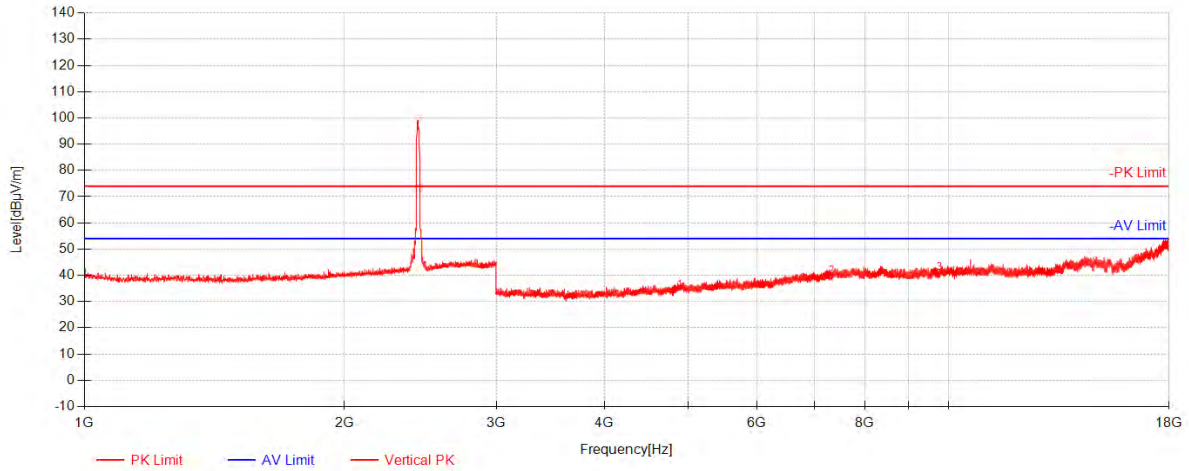

Data List										
NO.	Frequency [MHz]	Reading [dBµV]	AF [dB/m]	Factor [dB]	Level [dBµV/m]	Limit [dBµV/m]	Margin [dB]	Height [cm]	Angle [°]	Polarity
1	4824.0000	49.36	31.01	-45.54	34.84	74.00	39.16	231	52	Vertical
2	7236.0000	48.05	35.86	-43.54	40.37	74.00	33.63	166	18	Vertical
3	9648.0000	43.48	37.53	-39.56	41.45	74.00	32.55	102	80	Vertical



Unless otherwise agreed in writing, this document is issued by the Company subject to its General Conditions of Service printed overleaf, available on request or accessible at <http://www.sgs.com/en/Terms-and-Conditions.aspx> and, for electronic format documents, subject to Terms and Conditions for Electronic Documents at <http://www.sgs.com/en/Terms-and-Conditions/Terms-e-Documents.aspx>. Attention is drawn to the limitation of liability, indemnification and jurisdiction issues defined therein. Any holder of this document is advised that information contained hereon reflects the Company's findings at the time of its intervention only and within the limits of Client's instructions, if any. The Company's sole responsibility is to its Client and this document does not exonerate parties to a transaction from exercising all their rights and obligations under the transaction documents. This document cannot be reproduced except in full, without prior written approval of the Company. Any unauthorized alteration, forgery or falsification of the content or appearance of this document is unlawful and offenders may be prosecuted to the fullest extent of the law. Unless otherwise stated the results shown in this test report refer only to the sample(s) tested and such sample(s) are retained for 30 days only.

Attention: To check the authenticity of testing/inspection report & certificate, please contact us at telephone: (86-755) 8307 1443, or email: [CN.Doccheck@sgs.com](mailto:CN.Doccheck@sgs.com)

South of No. 6 Plant, No. 1, Runsheng Road, Suzhou Industrial Park, Suzhou Area, China (Jiangsu) Pilot Free Trade Zone 215000 t (86-512) 62992980 www.sgsgroup.com.cn  
 中国·苏州·中国(江苏)自由贸易试验区苏州片区苏州工业园区润胜路1号的6号厂房南楼 邮编: 215000 t (86-512) 62992980 sgs.china@sgs.com

802.11n20\_Channel 11

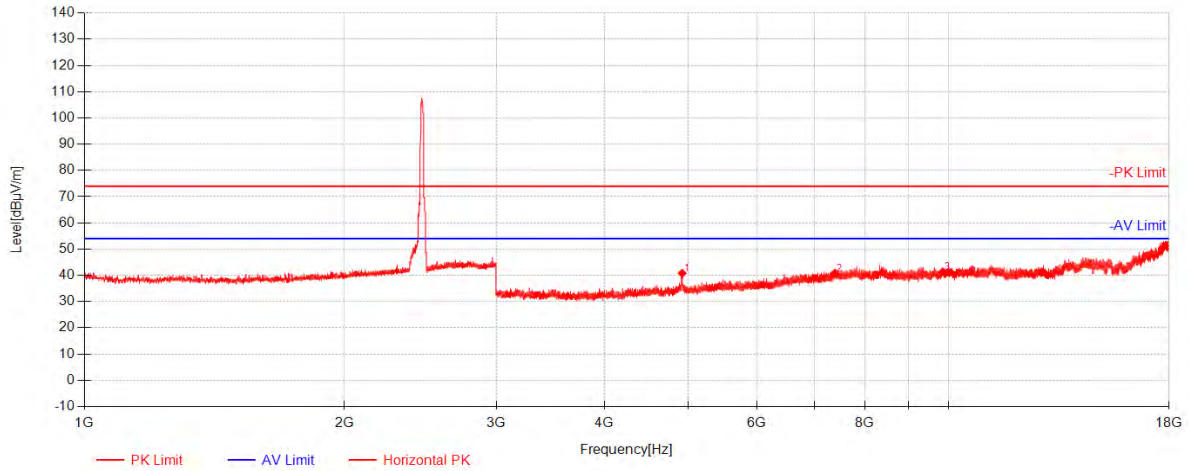

Data List										
NO.	Frequency [MHz]	Reading [dBµV]	AF [dB/m]	Factor [dB]	Level [dBµV/m]	Limit [dBµV/m]	Margin [dB]	Height [cm]	Angle [°]	Polarity
1	4919.5	55.12	31.22	-45.55	40.79	74.00	33.21	216	1	Horizontal
2	7386.0000	48.00	36.28	-43.46	40.82	74.00	33.18	135	52	Horizontal
3	9848.0000	42.85	37.91	-39.41	41.35	74.00	32.65	189	109	Horizontal



Unless otherwise agreed in writing, this document is issued by the Company subject to its General Conditions of Service printed overleaf, available on request or accessible at <http://www.sgs.com/en/Terms-and-Conditions.aspx> and, for electronic format documents, subject to Terms and Conditions for Electronic Documents at <http://www.sgs.com/en/Terms-and-Conditions/Terms-e-Documents.aspx>. Attention is drawn to the limitation of liability, indemnification and jurisdiction issues defined therein. Any holder of this document is advised that information contained hereon reflects the Company's findings at the time of its intervention only and within the limits of Client's instructions, if any. The Company's sole responsibility is to its Client and this document does not exonerate parties to a transaction from exercising all their rights and obligations under the transaction documents. This document cannot be reproduced except in full, without prior written approval of the Company. Any unauthorized alteration, forgery or falsification of the content or appearance of this document is unlawful and offenders may be prosecuted to the fullest extent of the law. Unless otherwise stated the results shown in this test report refer only to the sample(s) tested and such sample(s) are retained for 30 days only.

Attention: To check the authenticity of testing/inspection report & certificate, please contact us at telephone: (86-755) 8307 1443, or email: [CN.Doccheck@sgs.com](mailto:CN.Doccheck@sgs.com)

South of No. 6 Plant, No. 1, Runsheng Road, Suzhou Industrial Park, Suzhou Area, China (Jiangsu) Pilot Free Trade Zone 215000 t (86-512) 62992980 www.sgs.com.cn  
 中国·苏州·中国(江苏)自由贸易试验区苏州片区苏州工业园区润胜路1号的6号厂房南楼 邮编: 215000 t (86-512) 62992980 sgs.china@sgs.com

802.11n20\_Channel 11

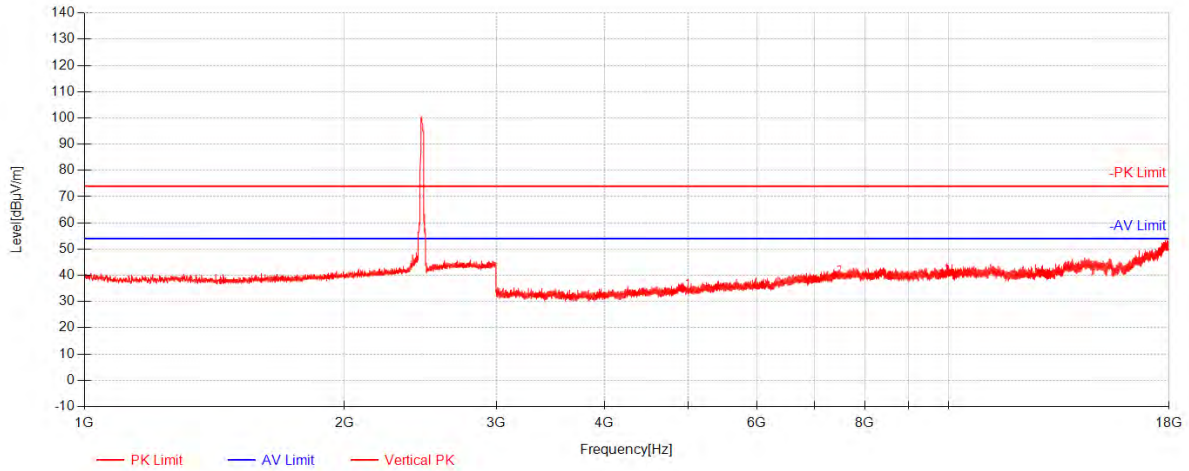

Data List										
NO.	Frequency [MHz]	Reading [dBµV]	AF [dB/m]	Factor [dB]	Level [dBµV/m]	Limit [dBµV/m]	Margin [dB]	Height [cm]	Angle [°]	Polarity
1	4924.0000	49.27	31.23	-45.56	34.95	74.00	39.05	258	77	Vertical
2	7386.0000	47.30	36.28	-43.46	40.12	74.00	33.88	174	135	Vertical
3	9848.0000	42.06	37.91	-39.41	40.56	74.00	33.44	186	219	Vertical



Unless otherwise agreed in writing, this document is issued by the Company subject to its General Conditions of Service printed overleaf, available on request or accessible at <http://www.sgs.com/en/Terms-and-Conditions.aspx> and, for electronic format documents, subject to Terms and Conditions for Electronic Documents at <http://www.sgs.com/en/Terms-and-Conditions/Terms-e-Documents.aspx>. Attention is drawn to the limitation of liability, indemnification and jurisdiction issues defined therein. Any holder of this document is advised that information contained hereon reflects the Company's findings at the time of its intervention only and within the limits of Client's instructions, if any. The Company's sole responsibility is to its Client and this document does not exonerate parties to a transaction from exercising all their rights and obligations under the transaction documents. This document cannot be reproduced except in full, without prior written approval of the Company. Any unauthorized alteration, forgery or falsification of the content or appearance of this document is unlawful and offenders may be prosecuted to the fullest extent of the law. Unless otherwise stated the results shown in this test report refer only to the sample(s) tested and such sample(s) are retained for 30 days only.

Attention: To check the authenticity of testing/inspection report & certificate, please contact us at telephone: (86-755) 8307 1443, or email: [CN.Doccheck@sgs.com](mailto:CN.Doccheck@sgs.com)

South of No. 6 Plant, No. 1, Runsheng Road, Suzhou Industrial Park, Suzhou Area, China (Jiangsu) Pilot Free Trade Zone 215000 t (86-512) 62992980 www.sgs.com.cn  
 中国·苏州·中国(江苏)自由贸易试验区苏州片区苏州工业园区润胜路1号的6号厂房南楼 邮编: 215000 t (86-512) 62992980 sgs.china@sgs.com

802.11n40\_Channel 03

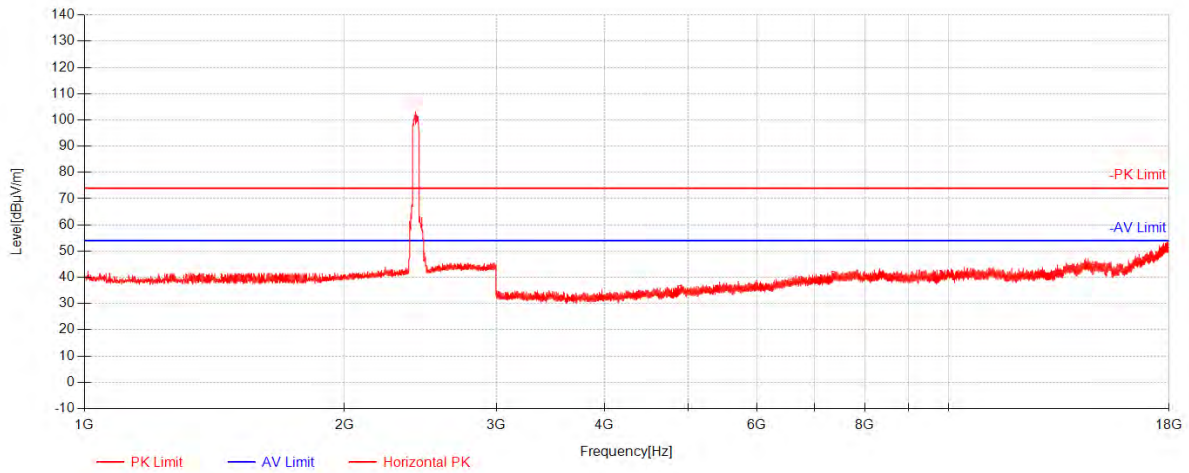

Data List										
NO.	Frequency [MHz]	Reading [dBµV]	AF [dB/m]	Factor [dB]	Level [dBµV/m]	Limit [dBµV/m]	Margin [dB]	Height [cm]	Angle [°]	Polarity
1	4844.0000	48.38	31.06	-45.54	33.90	74.00	40.10	214	359	Horizontal
2	7266.0000	46.49	35.94	-43.64	38.80	74.00	35.20	186	355	Horizontal
3	9688.0000	40.96	37.61	-39.47	39.10	74.00	34.90	265	84	Horizontal



Unless otherwise agreed in writing, this document is issued by the Company subject to its General Conditions of Service printed overleaf, available on request or accessible at <http://www.sgs.com/en/Terms-and-Conditions.aspx> and, for electronic format documents, subject to Terms and Conditions for Electronic Documents at <http://www.sgs.com/en/Terms-and-Conditions/Terms-e-Documents.aspx>. Attention is drawn to the limitation of liability, indemnification and jurisdiction issues defined therein. Any holder of this document is advised that information contained hereon reflects the Company's findings at the time of its intervention only and within the limits of Client's instructions, if any. The Company's sole responsibility is to its Client and this document does not exonerate parties to a transaction from exercising all their rights and obligations under the transaction documents. This document cannot be reproduced except in full, without prior written approval of the Company. Any unauthorized alteration, forgery or falsification of the content or appearance of this document is unlawful and offenders may be prosecuted to the fullest extent of the law. Unless otherwise stated the results shown in this test report refer only to the sample(s) tested and such sample(s) are retained for 30 days only.

Attention: To check the authenticity of testing/inspection report & certificate, please contact us at telephone: (86-755) 8307 1443, or email: [CN.Doccheck@sgs.com](mailto:CN.Doccheck@sgs.com)

South of No. 6 Plant, No. 1, Runsheng Road, Suzhou Industrial Park, Suzhou Area, China (Jiangsu) Pilot Free Trade Zone 215000 t (86-512) 62992980 www.sgsgroup.com.cn  
 中国·苏州·中国(江苏)自由贸易试验区苏州片区苏州工业园区润胜路1号的6号厂房南楼 邮编: 215000 t (86-512) 62992980 sgs.china@sgs.com



802.11n40\_Channel 03

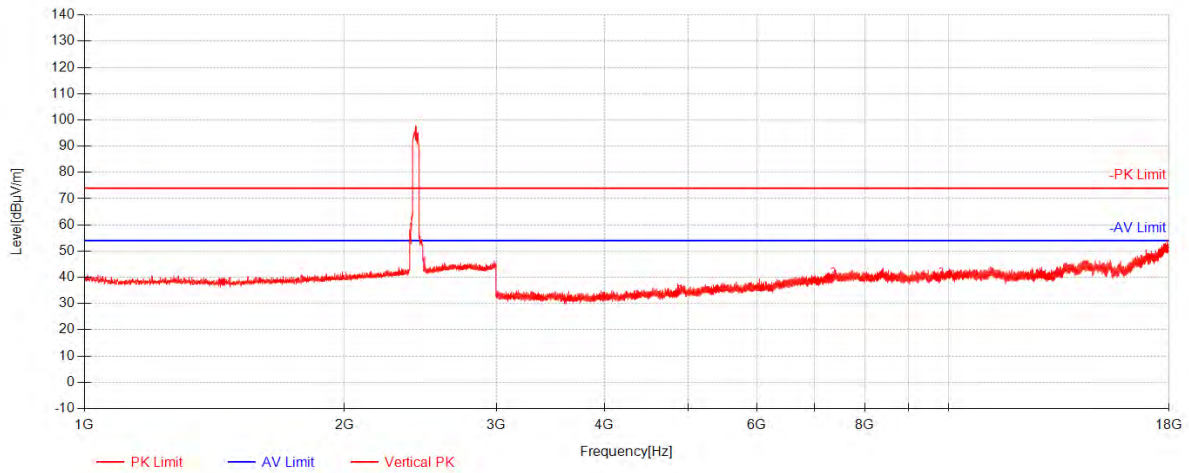

Data List										
NO.	Frequency [MHz]	Reading [dBµV]	AF [dB/m]	Factor [dB]	Level [dBµV/m]	Limit [dBµV/m]	Margin [dB]	Height [cm]	Angle [°]	Polarity
1	4844.0000	48.34	31.06	-45.54	33.86	74.00	40.14	148	360	Vertical
2	7266.0000	47.89	35.94	-43.64	40.20	74.00	33.80	175	4	Vertical
3	9688.0000	42.00	37.61	-39.47	40.14	74.00	33.86	129	227	Vertical



Unless otherwise agreed in writing, this document is issued by the Company subject to its General Conditions of Service printed overleaf, available on request or accessible at <http://www.sgs.com/en/Terms-and-Conditions.aspx> and, for electronic format documents, subject to Terms and Conditions for Electronic Documents at <http://www.sgs.com/en/Terms-and-Conditions/Terms-e-Documents.aspx>. Attention is drawn to the limitation of liability, indemnification and jurisdiction issues defined therein. Any holder of this document is advised that information contained hereon reflects the Company's findings at the time of its intervention only and within the limits of Client's instructions, if any. The Company's sole responsibility is to its Client and this document does not exonerate parties to a transaction from exercising all their rights and obligations under the transaction documents. This document cannot be reproduced except in full, without prior written approval of the Company. Any unauthorized alteration, forgery or falsification of the content or appearance of this document is unlawful and offenders may be prosecuted to the fullest extent of the law. Unless otherwise stated the results shown in this test report refer only to the sample(s) tested and such sample(s) are retained for 30 days only.

Attention: To check the authenticity of testing/inspection report & certificate, please contact us at telephone: (86-755) 8307 1443, or email: [CN.Doccheck@sgs.com](mailto:CN.Doccheck@sgs.com)

South of No. 6 Plant, No. 1, Runsheng Road, Suzhou Industrial Park, Suzhou Area, China (Jiangsu) Pilot Free Trade Zone 215000 t (86-512) 62992980 www.sgsgroup.com.cn  
 中国·苏州·中国(江苏)自由贸易试验区苏州片区苏州工业园区润胜路1号的6号厂房南楼 邮编: 215000 t (86-512) 62992980 sgs.china@sgs.com

802.11n40\_Channel 06

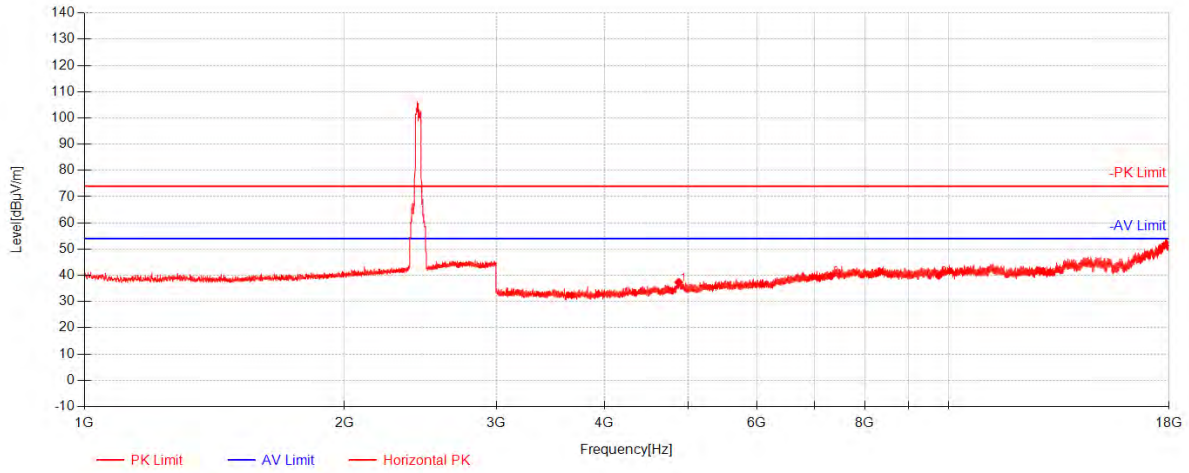

Data List										
NO.	Frequency [MHz]	Reading [dBµV]	AF [dB/m]	Factor [dB]	Level [dBµV/m]	Limit [dBµV/m]	Margin [dB]	Height [cm]	Angle [°]	Polarity
1	4874.0000	51.78	31.12	-45.53	37.37	74.00	36.63	256	359	Horizontal
2	7311.0000	47.42	36.07	-43.71	39.78	74.00	34.22	142	241	Horizontal
3	9748.0000	41.62	37.72	-39.46	39.88	74.00	34.12	130	133	Horizontal



Unless otherwise agreed in writing, this document is issued by the Company subject to its General Conditions of Service printed overleaf, available on request or accessible at <http://www.sgs.com/en/Terms-and-Conditions.aspx> and, for electronic format documents, subject to Terms and Conditions for Electronic Documents at <http://www.sgs.com/en/Terms-and-Conditions/Terms-e-Documents.aspx>. Attention is drawn to the limitation of liability, indemnification and jurisdiction issues defined therein. Any holder of this document is advised that information contained hereon reflects the Company's findings at the time of its intervention only and within the limits of Client's instructions, if any. The Company's sole responsibility is to its Client and this document does not exonerate parties to a transaction from exercising all their rights and obligations under the transaction documents. This document cannot be reproduced except in full, without prior written approval of the Company. Any unauthorized alteration, forgery or falsification of the content or appearance of this document is unlawful and offenders may be prosecuted to the fullest extent of the law. Unless otherwise stated the results shown in this test report refer only to the sample(s) tested and such sample(s) are retained for 30 days only.

Attention: To check the authenticity of testing/inspection report & certificate, please contact us at telephone: (86-755) 8307 1443, or email: [CN.Doccheck@sgs.com](mailto:CN.Doccheck@sgs.com)

South of No. 6 Plant, No. 1, Runsheng Road, Suzhou Industrial Park, Suzhou Area, China (Jiangsu) Pilot Free Trade Zone 215000 t (86-512) 62992980 www.sgsgroup.com.cn  
 中国·苏州·中国(江苏)自由贸易试验区苏州片区苏州工业园区润胜路1号的6号厂房南楼 邮编: 215000 t (86-512) 62992980 sgs.china@sgs.com

802.11n40\_Channel 06

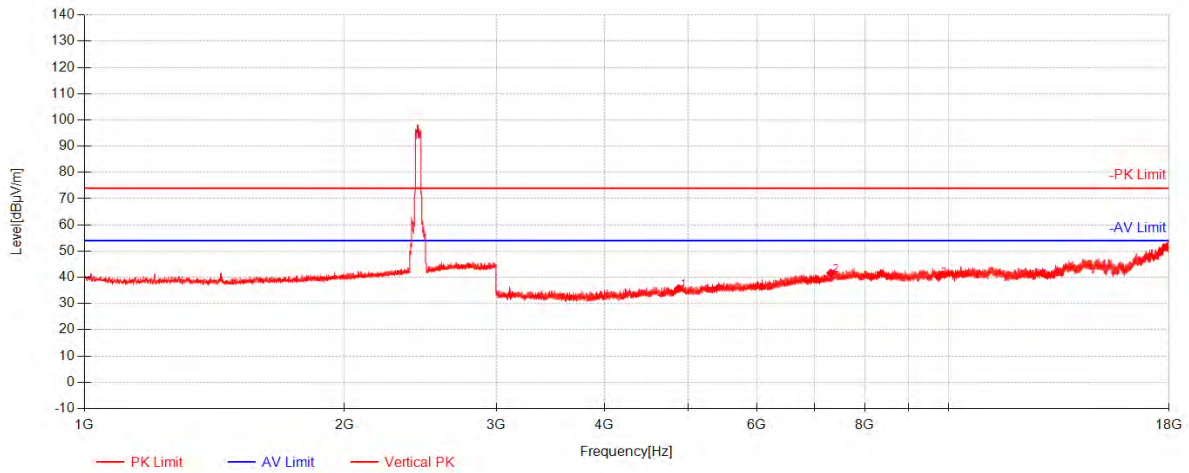

Data List										
NO.	Frequency [MHz]	Reading [dBµV]	AF [dB/m]	Factor [dB]	Level [dBµV/m]	Limit [dBµV/m]	Margin [dB]	Height [cm]	Angle [°]	Polarity
1	4874.0000	50.17	31.12	-45.53	35.76	74.00	38.24	266	3	Vertical
2	7311.0000	49.28	36.07	-43.71	41.64	74.00	32.36	158	354	Vertical
3	9748.0000	41.99	37.72	-39.46	40.25	74.00	33.75	192	252	Vertical



Unless otherwise agreed in writing, this document is issued by the Company subject to its General Conditions of Service printed overleaf, available on request or accessible at <http://www.sgs.com/en/Terms-and-Conditions.aspx> and, for electronic format documents, subject to Terms and Conditions for Electronic Documents at <http://www.sgs.com/en/Terms-and-Conditions/Terms-e-Documents.aspx>. Attention is drawn to the limitation of liability, indemnification and jurisdiction issues defined therein. Any holder of this document is advised that information contained hereon reflects the Company's findings at the time of its intervention only and within the limits of Client's instructions, if any. The Company's sole responsibility is to its Client and this document does not exonerate parties to a transaction from exercising all their rights and obligations under the transaction documents. This document cannot be reproduced except in full, without prior written approval of the Company. Any unauthorized alteration, forgery or falsification of the content or appearance of this document is unlawful and offenders may be prosecuted to the fullest extent of the law. Unless otherwise stated the results shown in this test report refer only to the sample(s) tested and such sample(s) are retained for 30 days only.

Attention: To check the authenticity of testing/inspection report & certificate, please contact us at telephone: (86-755) 8307 1443, or email: [CN.Doccheck@sgs.com](mailto:CN.Doccheck@sgs.com)

South of No. 6 Plant, No. 1, Runsheng Road, Suzhou Industrial Park, Suzhou Area, China (Jiangsu) Pilot Free Trade Zone 215000 t (86-512) 62992980 www.sgsgroup.com.cn  
 中国·苏州·中国(江苏)自由贸易试验区苏州片区苏州工业园区润胜路1号的6号厂房南楼 邮编: 215000 t (86-512) 62992980 sgs.china@sgs.com

802.11n0\_Channel 09

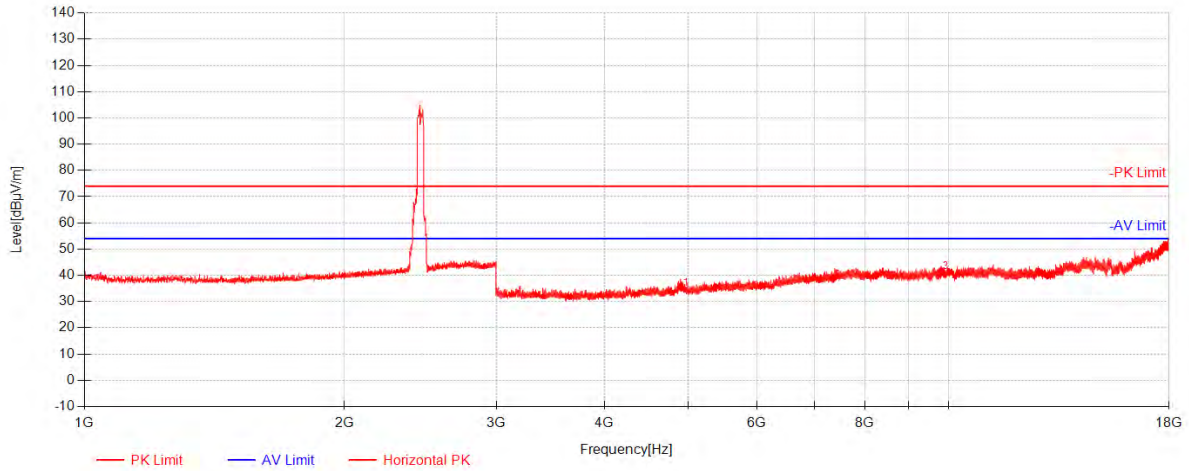

Data List										
NO.	Frequency [MHz]	Reading [dBµV]	AF [dB/m]	Factor [dB]	Level [dBµV/m]	Limit [dBµV/m]	Margin [dB]	Height [cm]	Angle [°]	Polarity
1	4904.0000	49.74	31.19	-45.53	35.39	74.00	38.61	244	360	Horizontal
2	7356.0000	46.11	36.20	-43.56	38.75	74.00	35.25	124	28	Horizontal
3	9808.0000	43.36	37.84	-39.47	41.73	74.00	32.27	198	359	Horizontal



Unless otherwise agreed in writing, this document is issued by the Company subject to its General Conditions of Service printed overleaf, available on request or accessible at <http://www.sgs.com/en/Terms-and-Conditions.aspx> and, for electronic format documents, subject to Terms and Conditions for Electronic Documents at <http://www.sgs.com/en/Terms-and-Conditions/Terms-e-Documents.aspx>. Attention is drawn to the limitation of liability, indemnification and jurisdiction issues defined therein. Any holder of this document is advised that information contained hereon reflects the Company's findings at the time of its intervention only and within the limits of Client's instructions, if any. The Company's sole responsibility is to its Client and this document does not exonerate parties to a transaction from exercising all their rights and obligations under the transaction documents. This document cannot be reproduced except in full, without prior written approval of the Company. Any unauthorized alteration, forgery or falsification of the content or appearance of this document is unlawful and offenders may be prosecuted to the fullest extent of the law. Unless otherwise stated the results shown in this test report refer only to the sample(s) tested and such sample(s) are retained for 30 days only.

Attention: To check the authenticity of testing/inspection report & certificate, please contact us at telephone: (86-755) 8307 1443, or email: [CN.Doccheck@sgs.com](mailto:CN.Doccheck@sgs.com)

South of No. 6 Plant, No. 1, Runsheng Road, Suzhou Industrial Park, Suzhou Area, China (Jiangsu) Pilot Free Trade Zone 215000 t (86-512) 62992980 www.sgsgroup.com.cn  
 中国·苏州·中国(江苏)自由贸易试验区苏州片区苏州工业园区润胜路1号的6号厂房南楼 邮编: 215000 t (86-512) 62992980 sgs.china@sgs.com

802.11n40\_Channel 09

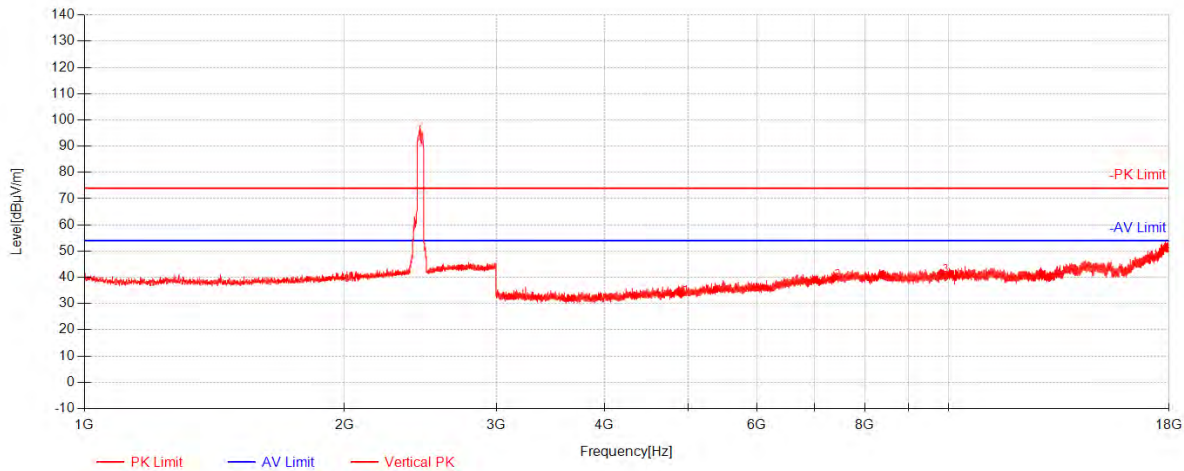

Data List										
NO.	Frequency [MHz]	Reading [dBµV]	AF [dB/m]	Factor [dB]	Level [dBµV/m]	Limit [dBµV/m]	Margin [dB]	Height [cm]	Angle [°]	Polarity
1	4904.0000	47.93	31.19	-45.53	33.58	74.00	40.42	245	264	Vertical
2	7356.0000	46.81	36.20	-43.56	39.45	74.00	34.55	186	3	Vertical
3	9808.0000	43.28	37.84	-39.47	41.65	74.00	32.35	126	153	Vertical

Remark:

- The field strength is calculated by adding the Antenna Factor, Cable Factor & Pre-amplifier gain. The basic equation with a sample calculation is as follows:  
 $Level = Reading(dB\mu V) + AF(dB/m) + Factor(dB)$   
 $AF = Antenna\ Factor(dB/m)$   
 $Factor = Cable\ Factor(dB) - Pre-amplifier\ gain(dB)$   
 $Margin = Limit(dB\mu V/m) - Level(dB\mu V/m)$
- All channels have been tested, but only the worst case data displayed in this report.
- Both peak and average measured complies with the limit line, so test result is "PASS"
- For WLAN SISO & CDD/MIMO mode for 802.11b/g/n mode, the whole testing has assessed only CDD/MIMO mode by referring to their higher output power.



Unless otherwise agreed in writing, this document is issued by the Company subject to its General Conditions of Service printed overleaf, available on request or accessible at <http://www.sgs.com/en/Terms-and-Conditions.aspx> and, for electronic format documents, subject to Terms and Conditions for Electronic Documents at <http://www.sgs.com/en/Terms-and-Conditions/Terms-e-Documents.aspx>. Attention is drawn to the limitation of liability, indemnification and jurisdiction issues defined therein. Any holder of this document is advised that information contained hereon reflects the Company's findings at the time of its intervention only and within the limits of Client's instructions, if any. The Company's sole responsibility is to its Client and this document does not exonerate parties to a transaction from exercising all their rights and obligations under the transaction documents. This document cannot be reproduced except in full, without prior written approval of the Company. Any unauthorized alteration, forgery or falsification of the content or appearance of this document is unlawful and offenders may be prosecuted to the fullest extent of the law. Unless otherwise stated the results shown in this test report refer only to the sample(s) tested and such sample(s) are retained for 30 days only.  
**Attention:** To check the authenticity of testing/inspection report & certificate, please contact us at telephone: (86-755) 8307 1443, or email: [CN.Doccheck@sgs.com](mailto:CN.Doccheck@sgs.com)

South of No. 6 Plant, No. 1, Runsheng Road, Suzhou Industrial Park, Suzhou Area, China (Jiangsu) Pilot Free Trade Zone 215000  
 中国·苏州·中国(江苏)自由贸易试验区苏州片区苏州工业园区润胜路1号的6号厂房南楼 邮编: 215000

t (86-512) 62992980 www.sgs.com.cn  
 t (86-512) 62992980 sgs.china@sgs.com

**Test on the worst case:**

**802.11n40\_Channel 03**

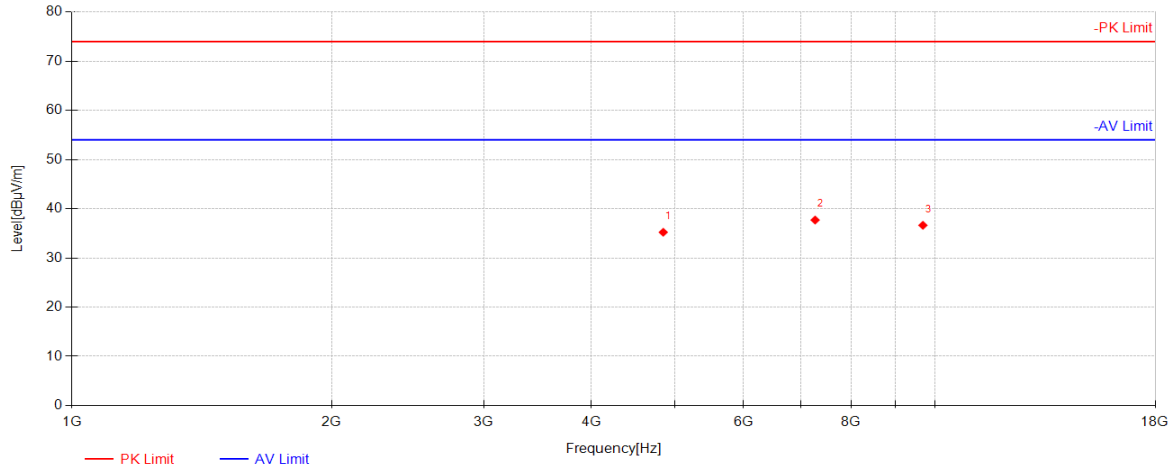

Data List								
NO.	Frequency [MHz]	Reading [dBµV]	AF [dB/m]	Factor [dB]	Level [dBµV/m]	Limit [dBµV/m]	Margin [dB]	Polarity
1	4844.0000	49.70	31.06	-45.54	35.22	74.00	38.78	Horizontal
2	7266.0000	45.40	35.94	-43.64	37.71	74.00	36.29	Horizontal
3	9688.0000	38.50	37.61	-39.47	36.64	74.00	37.36	Horizontal



Unless otherwise agreed in writing, this document is issued by the Company subject to its General Conditions of Service printed overleaf, available on request or accessible at <http://www.sgs.com/en/Terms-and-Conditions.aspx> and, for electronic format documents, subject to Terms and Conditions for Electronic Documents at <http://www.sgs.com/en/Terms-and-Conditions/Terms-e-Documents.aspx>. Attention is drawn to the limitation of liability, indemnification and jurisdiction issues defined therein. Any holder of this document is advised that information contained hereon reflects the Company's findings at the time of its intervention only and within the limits of Client's instructions, if any. The Company's sole responsibility is to its Client and this document does not exonerate parties to a transaction from exercising all their rights and obligations under the transaction documents. This document cannot be reproduced except in full, without prior written approval of the Company. Any unauthorized alteration, forgery or falsification of the content or appearance of this document is unlawful and offenders may be prosecuted to the fullest extent of the law. Unless otherwise stated the results shown in this test report refer only to the sample(s) tested and such sample(s) are retained for 30 days only.

Attention: To check the authenticity of testing/inspection report & certificate, please contact us at telephone: (86-755) 8307 1443, or email: [CN.Doccheck@sgs.com](mailto:CN.Doccheck@sgs.com)

South of No. 6 Plant, No. 1, Runsheng Road, Suzhou Industrial Park, Suzhou Area, China (Jiangsu) Pilot Free Trade Zone 215000 t (86-512) 62992980 www.sgs.com.cn  
 中国·苏州·中国(江苏)自由贸易试验区苏州片区苏州工业园区润胜路1号的6号厂房南楼 邮编: 215000 t (86-512) 62992980 sgs.china@sgs.com

802.11n40\_Channel 03

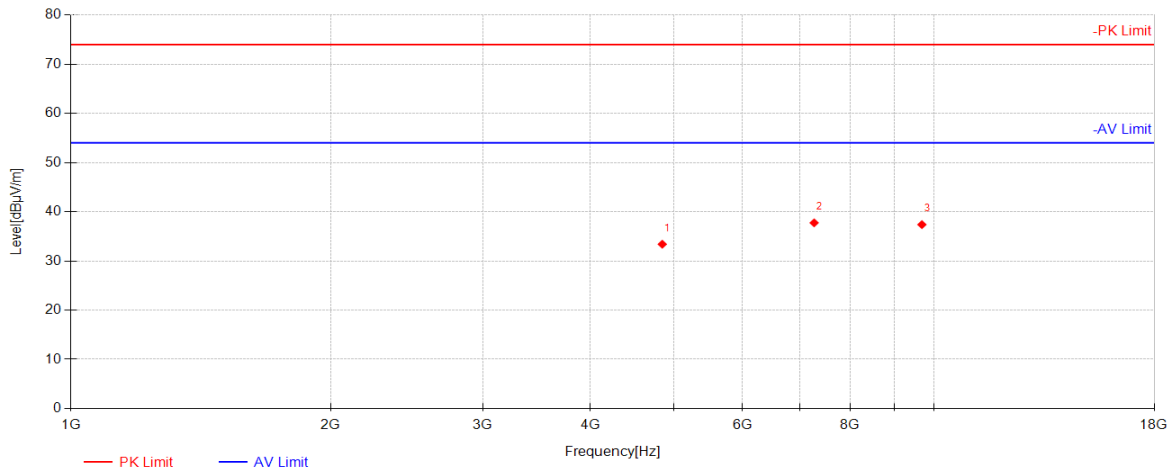

Data List								
NO.	Frequency [MHz]	Reading [dBµV]	AF [dB/m]	Factor [dB]	Level [dBµV/m]	Limit [dBµV/m]	Margin [dB]	Polarity
1	4844.0000	47.88	31.06	-45.54	33.40	74.00	40.60	Vertical
2	7266.0000	45.44	35.94	-43.64	37.75	74.00	36.25	Vertical
3	9688.0000	39.25	37.61	-39.47	37.39	74.00	36.61	Vertical

Remark:

- The field strength is calculated by adding the Antenna Factor, Cable Factor & Pre-amplifier gain. The basic equation with a sample calculation is as follows:  
 $Level = Reading(dB\mu V) + AF(dB/m) + Factor(dB)$   
 $AF = Antenna\ Factor(dB/m)$   
 $Factor = Cable\ Factor(dB) - Pre-amplifier\ gain(dB)$   
 $Margin = Limit(dB\mu V/m) - Level(dB\mu V/m)$
- Both peak and average measured complies with the limit line, so test result is "PASS"
- For WLAN SISO & CDD/MIMO mode for 802.11b/g/n mode, the whole testing has assessed only CDD/MIMO mode by referring to their higher output power.



Unless otherwise agreed in writing, this document is issued by the Company subject to its General Conditions of Service printed overleaf, available on request or accessible at <http://www.sgs.com/en/Terms-and-Conditions.aspx> and, for electronic format documents, subject to Terms and Conditions for Electronic Documents at <http://www.sgs.com/en/Terms-and-Conditions/Terms-e-Documents.aspx>. Attention is drawn to the limitation of liability, indemnification and jurisdiction issues defined therein. Any holder of this document is advised that information contained hereon reflects the Company's findings at the time of its intervention only and within the limits of Client's instructions, if any. The Company's sole responsibility is to its Client and this document does not exonerate parties to a transaction from exercising all their rights and obligations under the transaction documents. This document cannot be reproduced except in full, without prior written approval of the Company. Any unauthorized alteration, forgery or falsification of the content or appearance of this document is unlawful and offenders may be prosecuted to the fullest extent of the law. Unless otherwise stated the results shown in this test report refer only to the sample(s) tested and such sample(s) are retained for 30 days only.

Attention: To check the authenticity of testing/inspection report & certificate, please contact us at telephone: (86-755) 8307 1443, or email: [CN.Doccheck@sgs.com](mailto:CN.Doccheck@sgs.com)

South of No. 6 Plant, No. 1, Runsheng Road, Suzhou Industrial Park, Suzhou Area, China (Jiangsu) Pilot Free Trade Zone 215000 t (86-512) 62992980 www.sgsgroup.com.cn  
 中国·苏州·中国(江苏)自由贸易试验区苏州片区苏州工业园区润胜路1号的6号厂房南楼 邮编: 215000 t (86-512) 62992980 sgs.china@sgs.com

## Restricted bands around fundamental frequency

### 802.11b\_Channel 01

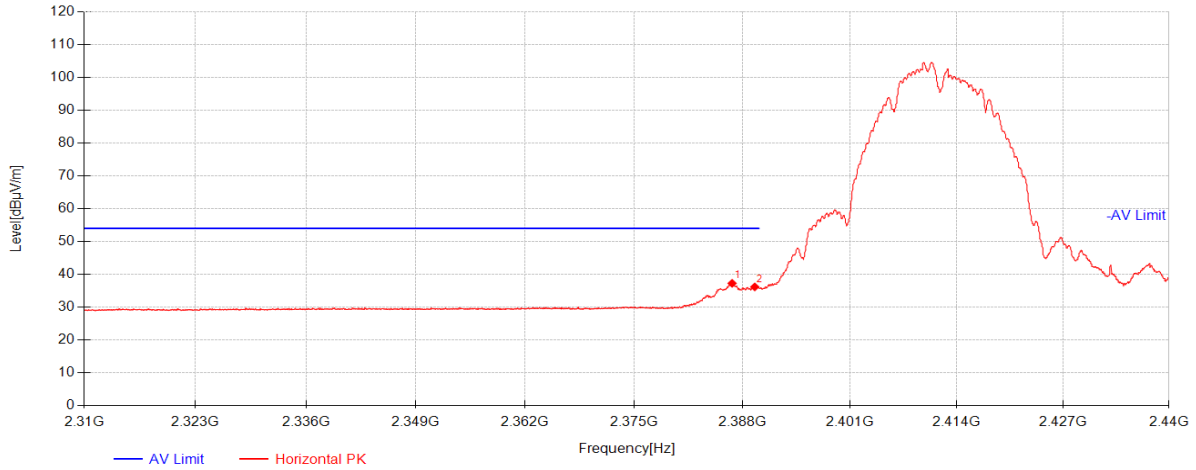

Data List										
NO.	Frequency [MHz]	Reading [dBµV]	AF [dB/m]	Factor [dB]	Level [dBµV/m]	Limit [dBµV/m]	Margin [dB]	Height [cm]	Angle [°]	Polarity
1	2386.7867	33.85	26.98	-23.57	37.26	54.00	16.74	162	285	Horizontal
2	2389.5167	32.75	26.99	-23.57	36.17	54.00	17.83	162	285	Horizontal



Unless otherwise agreed in writing, this document is issued by the Company subject to its General Conditions of Service printed overleaf, available on request or accessible at <http://www.sgs.com/en/Terms-and-Conditions.aspx> and, for electronic format documents, subject to Terms and Conditions for Electronic Documents at <http://www.sgs.com/en/Terms-and-Conditions/Terms-e-Documents.aspx>. Attention is drawn to the limitation of liability, indemnification and jurisdiction issues defined therein. Any holder of this document is advised that information contained hereon reflects the Company's findings at the time of its intervention only and within the limits of Client's instructions, if any. The Company's sole responsibility is to its Client and this document does not exonerate parties to a transaction from exercising all their rights and obligations under the transaction documents. This document cannot be reproduced except in full, without prior written approval of the Company. Any unauthorized alteration, forgery or falsification of the content or appearance of this document is unlawful and offenders may be prosecuted to the fullest extent of the law. Unless otherwise stated the results shown in this test report refer only to the sample(s) tested and such sample(s) are retained for 30 days only.

Attention: To check the authenticity of testing/inspection report & certificate, please contact us at telephone: (86-755) 8307 1443, or email: [CN.Doccheck@sgs.com](mailto:CN.Doccheck@sgs.com)

South of No. 6 Plant, No. 1, Runsheng Road, Suzhou Industrial Park, Suzhou Area, China (Jiangsu) Pilot Free Trade Zone 215000 t (86-512) 62992980 www.sgsgroup.com.cn  
 中国·苏州·中国(江苏)自由贸易试验区苏州片区苏州工业园区润胜路1号的6号厂房南楼 邮编: 215000 t (86-512) 62992980 sgs.china@sgs.com



802.11b\_Channel 01

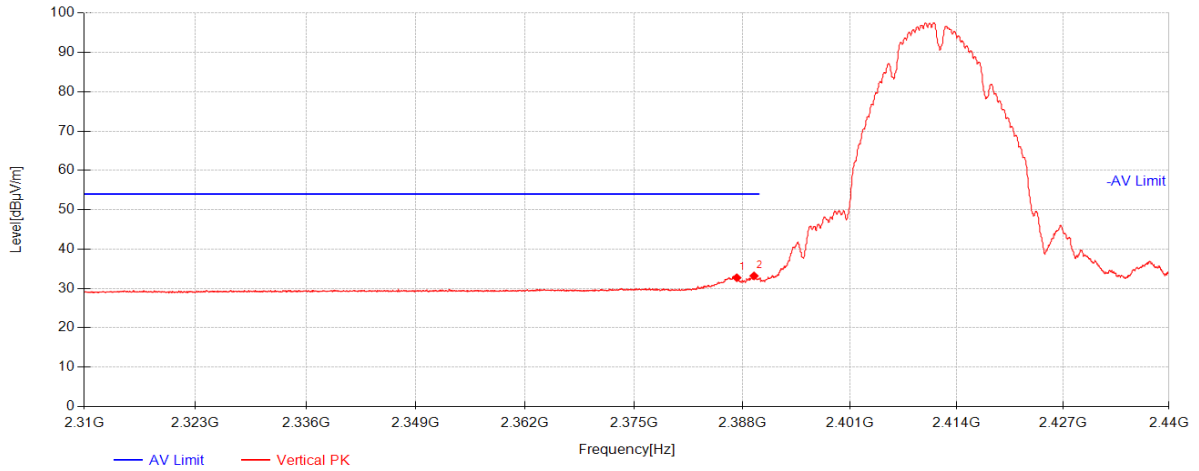

Data List										
NO.	Frequency [MHz]	Reading [dBµV]	AF [dB/m]	Factor [dB]	Level [dBµV/m]	Limit [dBµV/m]	Margin [dB]	Height [cm]	Angle [°]	Polarity
1	2387.35	29.31	26.98	-23.57	32.72	54.00	21.28	155	275	Vertical
2	2389.43	29.77	26.99	-23.57	33.19	54.00	20.81	155	275	Vertical



Unless otherwise agreed in writing, this document is issued by the Company subject to its General Conditions of Service printed overleaf, available on request or accessible at <http://www.sgs.com/en/Terms-and-Conditions.aspx> and, for electronic format documents, subject to Terms and Conditions for Electronic Documents at <http://www.sgs.com/en/Terms-and-Conditions/Terms-e-Documents.aspx>. Attention is drawn to the limitation of liability, indemnification and jurisdiction issues defined therein. Any holder of this document is advised that information contained hereon reflects the Company's findings at the time of its intervention only and within the limits of Client's instructions, if any. The Company's sole responsibility is to its Client and this document does not exonerate parties to a transaction from exercising all their rights and obligations under the transaction documents. This document cannot be reproduced except in full, without prior written approval of the Company. Any unauthorized alteration, forgery or falsification of the content or appearance of this document is unlawful and offenders may be prosecuted to the fullest extent of the law. Unless otherwise stated the results shown in this test report refer only to the sample(s) tested and such sample(s) are retained for 30 days only.

Attention: To check the authenticity of testing/inspection report & certificate, please contact us at telephone: (86-755) 8307 1443, or email: [CN.Doccheck@sgs.com](mailto:CN.Doccheck@sgs.com)

South of No. 6 Plant, No. 1, Runsheng Road, Suzhou Industrial Park, Suzhou Area, China (Jiangsu) Pilot Free Trade Zone 215000 t (86-512) 62992980 www.sgs.com.cn  
 中国·苏州·中国(江苏)自由贸易试验区苏州片区苏州工业园区润胜路1号的6号厂房南楼 邮编: 215000 t (86-512) 62992980 sgs.china@sgs.com

802.11b\_Channel 01

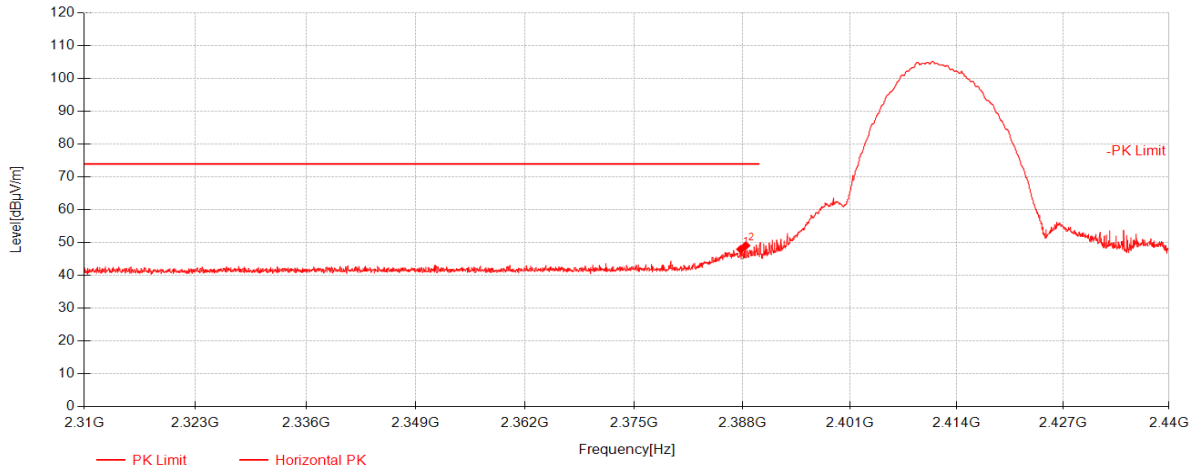

Data List										
NO.	Frequency [MHz]	Reading [dBµV]	AF [dB/m]	Factor [dB]	Level [dBµV/m]	Limit [dBµV/m]	Margin [dB]	Height [cm]	Angle [°]	Polarity
1	2387.8267	44.54	26.99	-23.57	47.95	74.00	26.05	162	285	Horizontal
2	2388.4333	45.64	26.99	-23.57	49.06	74.00	24.94	162	285	Horizontal



Unless otherwise agreed in writing, this document is issued by the Company subject to its General Conditions of Service printed overleaf, available on request or accessible at <http://www.sgs.com/en/Terms-and-Conditions.aspx> and, for electronic format documents, subject to Terms and Conditions for Electronic Documents at <http://www.sgs.com/en/Terms-and-Conditions/Terms-e-Documents.aspx>. Attention is drawn to the limitation of liability, indemnification and jurisdiction issues defined therein. Any holder of this document is advised that information contained hereon reflects the Company's findings at the time of its intervention only and within the limits of Client's instructions, if any. The Company's sole responsibility is to its Client and this document does not exonerate parties to a transaction from exercising all their rights and obligations under the transaction documents. This document cannot be reproduced except in full, without prior written approval of the Company. Any unauthorized alteration, forgery or falsification of the content or appearance of this document is unlawful and offenders may be prosecuted to the fullest extent of the law. Unless otherwise stated the results shown in this test report refer only to the sample(s) tested and such sample(s) are retained for 30 days only.

Attention: To check the authenticity of testing/inspection report & certificate, please contact us at telephone: (86-755) 8307 1443, or email: [CN.Doccheck@sgs.com](mailto:CN.Doccheck@sgs.com)

South of No. 6 Plant, No. 1, Runsheng Road, Suzhou Industrial Park, Suzhou Area, China (Jiangsu) Pilot Free Trade Zone 215000 t (86-512) 62992980 www.sgs.com.cn  
 中国·苏州·中国(江苏)自由贸易试验区苏州片区苏州工业园区润胜路1号的6号厂房南楼 邮编: 215000 t (86-512) 62992980 sgs.china@sgs.com

802.11b\_Channel 01

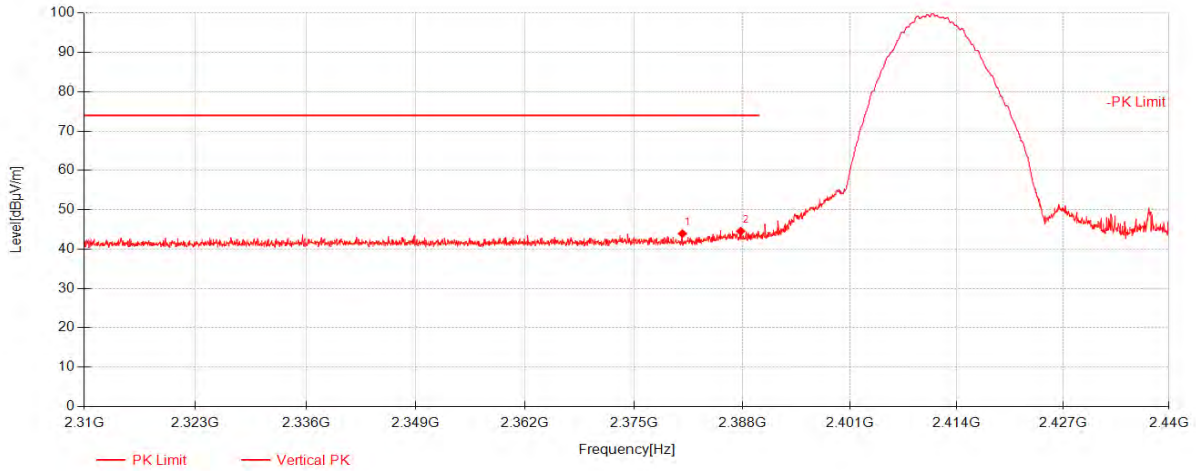

Data List										
NO.	Frequency [MHz]	Reading [dBµV]	AF [dB/m]	Factor [dB]	Level [dBµV/m]	Limit [dBµV/m]	Margin [dB]	Height [cm]	Angle [°]	Polarity
1	2380.8067	40.53	26.97	-23.57	43.92	74.00	30.08	155	275	Vertical
2	2387.8267	41.16	26.99	-23.57	44.57	74.00	29.43	155	275	Vertical



Unless otherwise agreed in writing, this document is issued by the Company subject to its General Conditions of Service printed overleaf, available on request or accessible at <http://www.sgs.com/en/Terms-and-Conditions.aspx> and, for electronic format documents, subject to Terms and Conditions for Electronic Documents at <http://www.sgs.com/en/Terms-and-Conditions/Terms-e-Documents.aspx>. Attention is drawn to the limitation of liability, indemnification and jurisdiction issues defined therein. Any holder of this document is advised that information contained hereon reflects the Company's findings at the time of its intervention only and within the limits of Client's instructions, if any. The Company's sole responsibility is to its Client and this document does not exonerate parties to a transaction from exercising all their rights and obligations under the transaction documents. This document cannot be reproduced except in full, without prior written approval of the Company. Any unauthorized alteration, forgery or falsification of the content or appearance of this document is unlawful and offenders may be prosecuted to the fullest extent of the law. Unless otherwise stated the results shown in this test report refer only to the sample(s) tested and such sample(s) are retained for 30 days only.

Attention: To check the authenticity of testing/inspection report & certificate, please contact us at telephone: (86-755) 8307 1443, or email: [CN.Doccheck@sgs.com](mailto:CN.Doccheck@sgs.com)

South of No. 6 Plant, No. 1, Runsheng Road, Suzhou Industrial Park, Suzhou Area, China (Jiangsu) Pilot Free Trade Zone 215000 t (86-512) 62992980 www.sgs.com.cn  
 中国·苏州·中国(江苏)自由贸易试验区苏州片区苏州工业园区润胜路1号的6号厂房南楼 邮编: 215000 t (86-512) 62992980 sgs.china@sgs.com

802.11b\_Channel 11

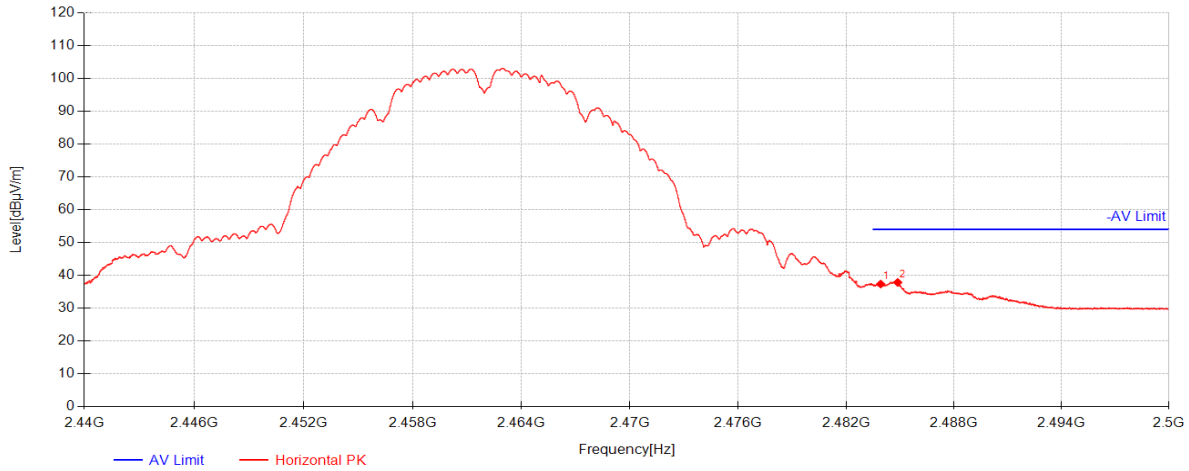

Data List										
NO.	Frequency [MHz]	Reading [dBµV]	AF [dB/m]	Factor [dB]	Level [dBµV/m]	Limit [dBµV/m]	Margin [dB]	Height [cm]	Angle [°]	Polarity
1	2483.9125	33.63	27.25	-23.54	37.34	54.00	16.66	114	12	Horizontal
2	2484.8575	34.13	27.26	-23.54	37.84	54.00	16.16	114	12	Horizontal



Unless otherwise agreed in writing, this document is issued by the Company subject to its General Conditions of Service printed overleaf, available on request or accessible at <http://www.sgs.com/en/Terms-and-Conditions.aspx> and, for electronic format documents, subject to Terms and Conditions for Electronic Documents at <http://www.sgs.com/en/Terms-and-Conditions/Terms-e-Documents.aspx>. Attention is drawn to the limitation of liability, indemnification and jurisdiction issues defined therein. Any holder of this document is advised that information contained hereon reflects the Company's findings at the time of its intervention only and within the limits of Client's instructions, if any. The Company's sole responsibility is to its Client and this document does not exonerate parties to a transaction from exercising all their rights and obligations under the transaction documents. This document cannot be reproduced except in full, without prior written approval of the Company. Any unauthorized alteration, forgery or falsification of the content or appearance of this document is unlawful and offenders may be prosecuted to the fullest extent of the law. Unless otherwise stated the results shown in this test report refer only to the sample(s) tested and such sample(s) are retained for 30 days only.

Attention: To check the authenticity of testing/inspection report & certificate, please contact us at telephone: (86-755) 8307 1443, or email: [CN.Doccheck@sgs.com](mailto:CN.Doccheck@sgs.com)

South of No. 6 Plant, No. 1, Runsheng Road, Suzhou Industrial Park, Suzhou Area, China (Jiangsu) Pilot Free Trade Zone 215000 t (86-512) 62992980 www.sgsgroup.com.cn  
 中国·苏州·中国(江苏)自由贸易试验区苏州片区苏州工业园区润胜路1号的6号厂房南楼 邮编: 215000 t (86-512) 62992980 sgs.china@sgs.com

802.11b\_Channel 11

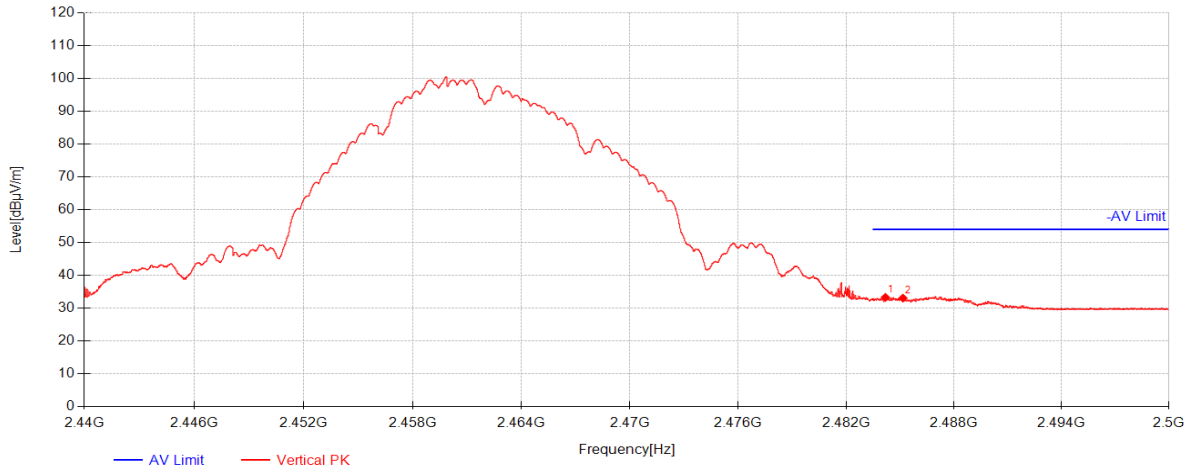

Data List										
NO.	Frequency [MHz]	Reading [dBμV]	AF [dB/m]	Factor [dB]	Level [dBμV/m]	Limit [dBμV/m]	Margin [dB]	Height [cm]	Angle [°]	Polarity
1	2484.175	29.58	27.26	-23.54	33.29	54.00	20.71	132	234	Vertical
2	2485.15	29.34	27.26	-23.54	33.05	54.00	20.95	132	234	Vertical



Unless otherwise agreed in writing, this document is issued by the Company subject to its General Conditions of Service printed overleaf, available on request or accessible at <http://www.sgs.com/en/Terms-and-Conditions.aspx> and, for electronic format documents, subject to Terms and Conditions for Electronic Documents at <http://www.sgs.com/en/Terms-and-Conditions/Terms-e-Documents.aspx>. Attention is drawn to the limitation of liability, indemnification and jurisdiction issues defined therein. Any holder of this document is advised that information contained hereon reflects the Company's findings at the time of its intervention only and within the limits of Client's instructions, if any. The Company's sole responsibility is to its Client and this document does not exonerate parties to a transaction from exercising all their rights and obligations under the transaction documents. This document cannot be reproduced except in full, without prior written approval of the Company. Any unauthorized alteration, forgery or falsification of the content or appearance of this document is unlawful and offenders may be prosecuted to the fullest extent of the law. Unless otherwise stated the results shown in this test report refer only to the sample(s) tested and such sample(s) are retained for 30 days only.

Attention: To check the authenticity of testing/inspection report & certificate, please contact us at telephone: (86-755) 8307 1443, or email: [CN.Doccheck@sgs.com](mailto:CN.Doccheck@sgs.com)

South of No. 6 Plant, No. 1, Runsheng Road, Suzhou Industrial Park, Suzhou Area, China (Jiangsu) Pilot Free Trade Zone 215000 t (86-512) 62992980 www.sgs.com.cn  
 中国·苏州·中国(江苏)自由贸易试验区苏州片区苏州工业园区润胜路1号的6号厂房南楼 邮编: 215000 t (86-512) 62992980 sgs.china@sgs.com

802.11b\_Channel 11

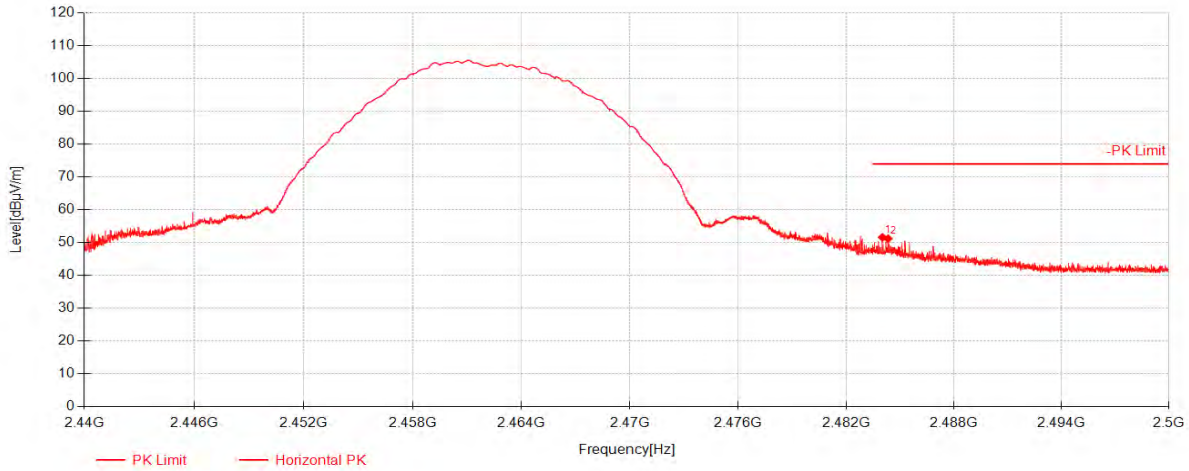

Data List										
NO.	Frequency [MHz]	Reading [dBμV]	AF [dB/m]	Factor [dB]	Level [dBμV/m]	Limit [dBμV/m]	Margin [dB]	Height [cm]	Angle [°]	Polarity
1	2484.01	47.89	27.26	-23.54	51.60	74.00	22.40	114	12	Horizontal
2	2484.3175	47.48	27.26	-23.54	51.19	74.00	22.81	114	12	Horizontal



Unless otherwise agreed in writing, this document is issued by the Company subject to its General Conditions of Service printed overleaf, available on request or accessible at <http://www.sgs.com/en/Terms-and-Conditions.aspx> and, for electronic format documents, subject to Terms and Conditions for Electronic Documents at <http://www.sgs.com/en/Terms-and-Conditions/Terms-e-Documents.aspx>. Attention is drawn to the limitation of liability, indemnification and jurisdiction issues defined therein. Any holder of this document is advised that information contained hereon reflects the Company's findings at the time of its intervention only and within the limits of Client's instructions, if any. The Company's sole responsibility is to its Client and this document does not exonerate parties to a transaction from exercising all their rights and obligations under the transaction documents. This document cannot be reproduced except in full, without prior written approval of the Company. Any unauthorized alteration, forgery or falsification of the content or appearance of this document is unlawful and offenders may be prosecuted to the fullest extent of the law. Unless otherwise stated the results shown in this test report refer only to the sample(s) tested and such sample(s) are retained for 30 days only.

Attention: To check the authenticity of testing/inspection report & certificate, please contact us at telephone: (86-755) 8307 1443, or email: [CN.Doccheck@sgs.com](mailto:CN.Doccheck@sgs.com)

South of No. 6 Plant, No. 1, Runsheng Road, Suzhou Industrial Park, Suzhou Area, China (Jiangsu) Pilot Free Trade Zone 215000 t (86-512) 62992980 www.sgsgroup.com.cn  
 中国·苏州·中国(江苏)自由贸易试验区苏州片区苏州工业园区润胜路1号的6号厂房南楼 邮编: 215000 t (86-512) 62992980 sgs.china@sgs.com

802.11b\_Channel 11

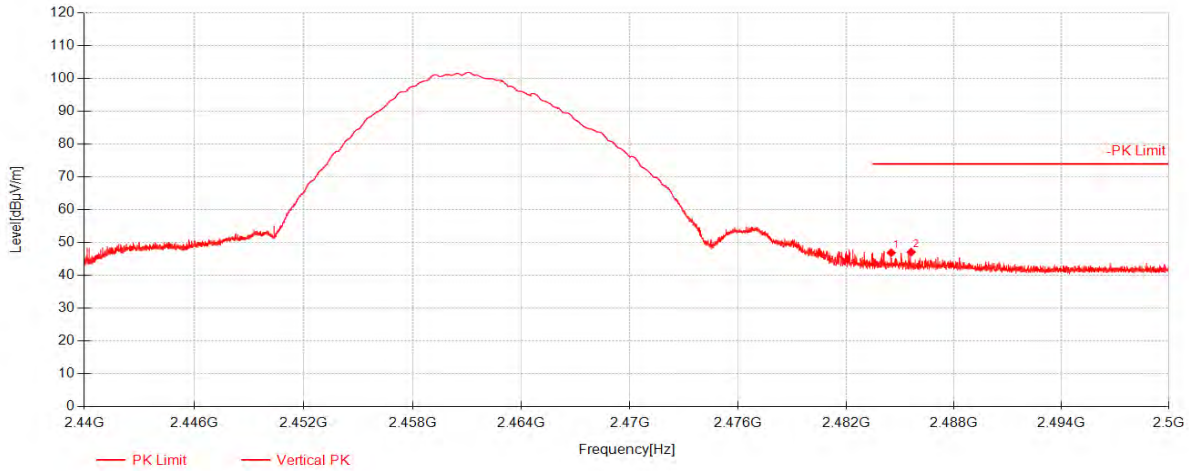

Data List										
NO.	Frequency [MHz]	Reading [dBµV]	AF [dB/m]	Factor [dB]	Level [dBµV/m]	Limit [dBµV/m]	Margin [dB]	Height [cm]	Angle [°]	Polarity
1	2484.4975	43.18	27.26	-23.54	46.89	74.00	27.11	132	234	Vertical
2	2485.6075	43.34	27.26	-23.54	47.06	74.00	26.94	132	234	Vertical



Unless otherwise agreed in writing, this document is issued by the Company subject to its General Conditions of Service printed overleaf, available on request or accessible at <http://www.sgs.com/en/Terms-and-Conditions.aspx> and, for electronic format documents, subject to Terms and Conditions for Electronic Documents at <http://www.sgs.com/en/Terms-and-Conditions/Terms-e-Documents.aspx>. Attention is drawn to the limitation of liability, indemnification and jurisdiction issues defined therein. Any holder of this document is advised that information contained hereon reflects the Company's findings at the time of its intervention only and within the limits of Client's instructions, if any. The Company's sole responsibility is to its Client and this document does not exonerate parties to a transaction from exercising all their rights and obligations under the transaction documents. This document cannot be reproduced except in full, without prior written approval of the Company. Any unauthorized alteration, forgery or falsification of the content or appearance of this document is unlawful and offenders may be prosecuted to the fullest extent of the law. Unless otherwise stated the results shown in this test report refer only to the sample(s) tested and such sample(s) are retained for 30 days only.

Attention: To check the authenticity of testing/inspection report & certificate, please contact us at telephone: (86-755) 8307 1443, or email: [CN.Doccheck@sgs.com](mailto:CN.Doccheck@sgs.com)

South of No. 6 Plant, No. 1, Runsheng Road, Suzhou Industrial Park, Suzhou Area, China (Jiangsu) Pilot Free Trade Zone 215000 t (86-512) 62992980 www.sgs.com.cn  
 中国·苏州·中国(江苏)自由贸易试验区苏州片区苏州工业园区润胜路1号的6号厂房南楼 邮编: 215000 t (86-512) 62992980 sgs.china@sgs.com

802.11g\_Channel 01

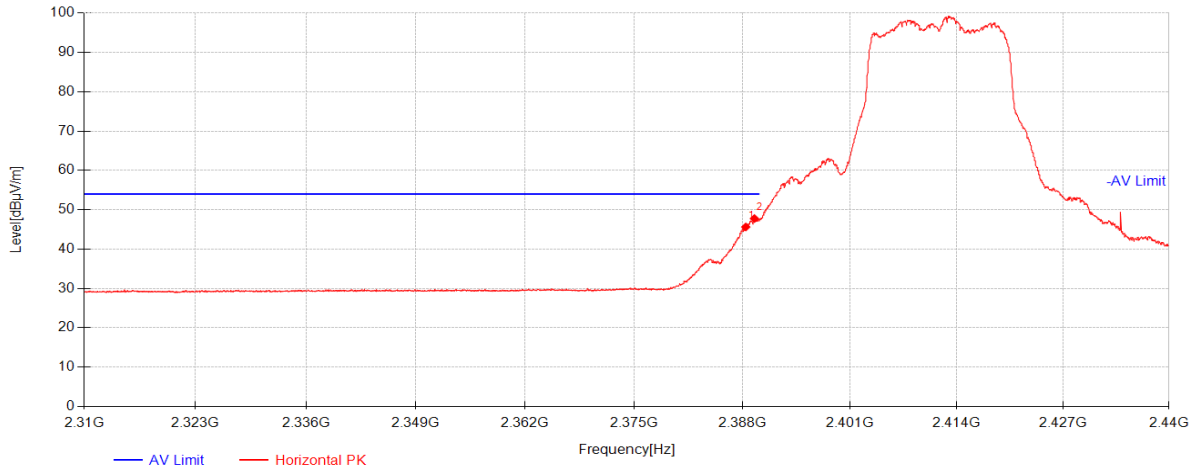

Data List										
NO.	Frequency [MHz]	Reading [dBµV]	AF [dB/m]	Factor [dB]	Level [dBµV/m]	Limit [dBµV/m]	Margin [dB]	Height [cm]	Angle [°]	Polarity
1	2388.4333	42.20	26.99	-23.57	45.62	54.00	8.38	133	286	Horizontal
2	2389.4733	44.35	26.99	-23.57	47.77	54.00	6.23	133	286	Horizontal



Unless otherwise agreed in writing, this document is issued by the Company subject to its General Conditions of Service printed overleaf, available on request or accessible at <http://www.sgs.com/en/Terms-and-Conditions.aspx> and, for electronic format documents, subject to Terms and Conditions for Electronic Documents at <http://www.sgs.com/en/Terms-and-Conditions/Terms-e-Documents.aspx>. Attention is drawn to the limitation of liability, indemnification and jurisdiction issues defined therein. Any holder of this document is advised that information contained hereon reflects the Company's findings at the time of its intervention only and within the limits of Client's instructions, if any. The Company's sole responsibility is to its Client and this document does not exonerate parties to a transaction from exercising all their rights and obligations under the transaction documents. This document cannot be reproduced except in full, without prior written approval of the Company. Any unauthorized alteration, forgery or falsification of the content or appearance of this document is unlawful and offenders may be prosecuted to the fullest extent of the law. Unless otherwise stated the results shown in this test report refer only to the sample(s) tested and such sample(s) are retained for 30 days only.

Attention: To check the authenticity of testing/inspection report & certificate, please contact us at telephone: (86-755) 8307 1443, or email: [CN.Doccheck@sgs.com](mailto:CN.Doccheck@sgs.com)

South of No. 6 Plant, No. 1, Runsheng Road, Suzhou Industrial Park, Suzhou Area, China (Jiangsu) Pilot Free Trade Zone 215000 t (86-512) 62992980 www.sgsgroup.com.cn  
 中国·苏州·中国(江苏)自由贸易试验区苏州片区苏州工业园区润胜路1号的6号厂房南楼 邮编: 215000 t (86-512) 62992980 sgs.china@sgs.com



802.11g\_Channel 01

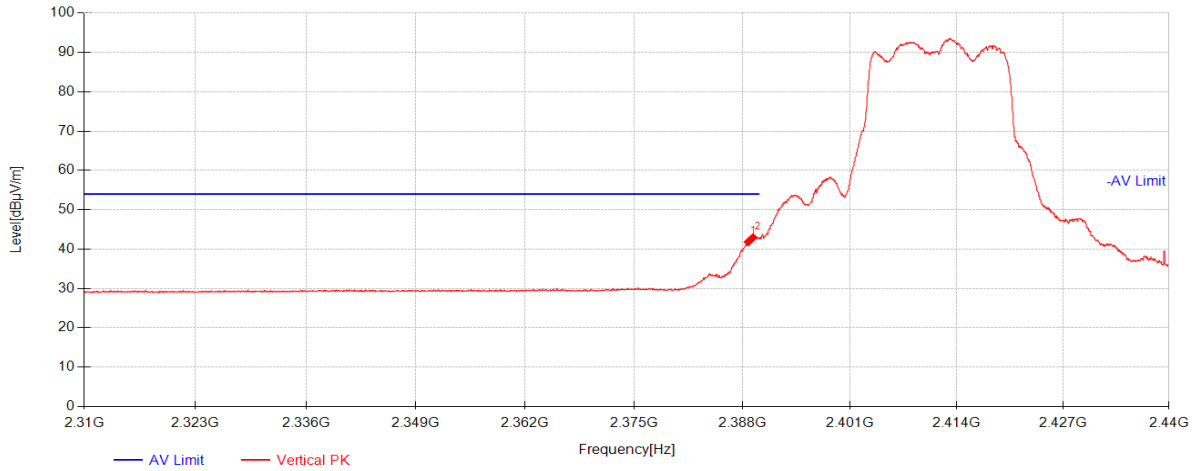

Data List										
NO.	Frequency [MHz]	Reading [dBµV]	AF [dB/m]	Factor [dB]	Level [dBµV/m]	Limit [dBµV/m]	Margin [dB]	Height [cm]	Angle [°]	Polarity
1	2388.7367	38.41	26.99	-23.57	41.83	54.00	12.17	259	233	Vertical
2	2389.3	39.53	26.99	-23.57	42.95	54.00	11.05	259	233	Vertical



Unless otherwise agreed in writing, this document is issued by the Company subject to its General Conditions of Service printed overleaf, available on request or accessible at <http://www.sgs.com/en/Terms-and-Conditions.aspx> and, for electronic format documents, subject to Terms and Conditions for Electronic Documents at <http://www.sgs.com/en/Terms-and-Conditions/Terms-e-Documents.aspx>. Attention is drawn to the limitation of liability, indemnification and jurisdiction issues defined therein. Any holder of this document is advised that information contained hereon reflects the Company's findings at the time of its intervention only and within the limits of Client's instructions, if any. The Company's sole responsibility is to its Client and this document does not exonerate parties to a transaction from exercising all their rights and obligations under the transaction documents. This document cannot be reproduced except in full, without prior written approval of the Company. Any unauthorized alteration, forgery or falsification of the content or appearance of this document is unlawful and offenders may be prosecuted to the fullest extent of the law. Unless otherwise stated the results shown in this test report refer only to the sample(s) tested and such sample(s) are retained for 30 days only.

Attention: To check the authenticity of testing/inspection report & certificate, please contact us at telephone: (86-755) 8307 1443, or email: [CN.Doccheck@sgs.com](mailto:CN.Doccheck@sgs.com)

South of No. 6 Plant, No. 1, Runsheng Road, Suzhou Industrial Park, Suzhou Area, China (Jiangsu) Pilot Free Trade Zone 215000 t (86-512) 62992980 www.sgs.com.cn  
 中国·苏州·中国(江苏)自由贸易试验区苏州片区苏州工业园区润胜路1号的6号厂房南楼 邮编: 215000 t (86-512) 62992980 sgs.china@sgs.com

802.11g\_Channel 01

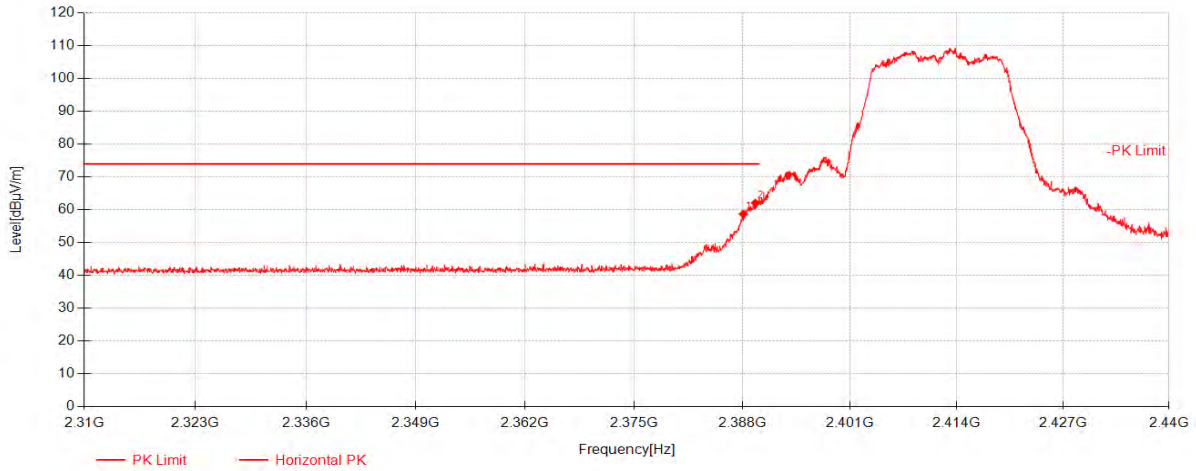

Data List										
NO.	Frequency [MHz]	Reading [dBµV]	AF [dB/m]	Factor [dB]	Level [dBµV/m]	Limit [dBµV/m]	Margin [dB]	Height [cm]	Angle [°]	Polarity
1	2388.13	55.28	26.99	-23.57	58.70	74.00	15.30	133	286	Horizontal
2	2389.6033	58.62	26.99	-23.57	62.04	74.00	11.96	133	286	Horizontal



Unless otherwise agreed in writing, this document is issued by the Company subject to its General Conditions of Service printed overleaf, available on request or accessible at <http://www.sgs.com/en/Terms-and-Conditions.aspx> and, for electronic format documents, subject to Terms and Conditions for Electronic Documents at <http://www.sgs.com/en/Terms-and-Conditions/Terms-e-Documents.aspx>. Attention is drawn to the limitation of liability, indemnification and jurisdiction issues defined therein. Any holder of this document is advised that information contained hereon reflects the Company's findings at the time of its intervention only and within the limits of Client's instructions, if any. The Company's sole responsibility is to its Client and this document does not exonerate parties to a transaction from exercising all their rights and obligations under the transaction documents. This document cannot be reproduced except in full, without prior written approval of the Company. Any unauthorized alteration, forgery or falsification of the content or appearance of this document is unlawful and offenders may be prosecuted to the fullest extent of the law. Unless otherwise stated the results shown in this test report refer only to the sample(s) tested and such sample(s) are retained for 30 days only.

Attention: To check the authenticity of testing/inspection report & certificate, please contact us at telephone: (86-755) 8307 1443, or email: [CN.Doccheck@sgs.com](mailto:CN.Doccheck@sgs.com)

South of No. 6 Plant, No. 1, Runsheng Road, Suzhou Industrial Park, Suzhou Area, China (Jiangsu) Pilot Free Trade Zone 215000 t (86-512) 62992980 www.sgsgroup.com.cn  
 中国·苏州·中国(江苏)自由贸易试验区苏州片区苏州工业园区润胜路1号的6号厂房南楼 邮编: 215000 t (86-512) 62992980 sgs.china@sgs.com

802.11g\_Channel 01

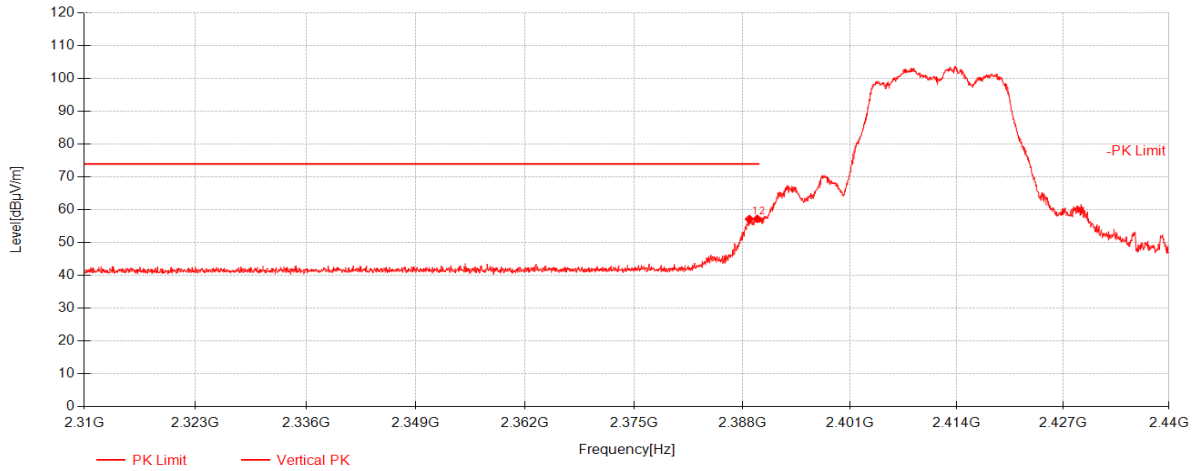

Data List										
NO.	Frequency [MHz]	Reading [dBµV]	AF [dB/m]	Factor [dB]	Level [dBµV/m]	Limit [dBµV/m]	Margin [dB]	Height [cm]	Angle [°]	Polarity
1	2388.8667	53.74	26.99	-23.57	57.16	74.00	16.84	259	233	Vertical
2	2389.82	53.82	26.99	-23.57	57.24	74.00	16.76	259	233	Vertical



Unless otherwise agreed in writing, this document is issued by the Company subject to its General Conditions of Service printed overleaf, available on request or accessible at <http://www.sgs.com/en/Terms-and-Conditions.aspx> and, for electronic format documents, subject to Terms and Conditions for Electronic Documents at <http://www.sgs.com/en/Terms-and-Conditions/Terms-e-Documents.aspx>. Attention is drawn to the limitation of liability, indemnification and jurisdiction issues defined therein. Any holder of this document is advised that information contained hereon reflects the Company's findings at the time of its intervention only and within the limits of Client's instructions, if any. The Company's sole responsibility is to its Client and this document does not exonerate parties to a transaction from exercising all their rights and obligations under the transaction documents. This document cannot be reproduced except in full, without prior written approval of the Company. Any unauthorized alteration, forgery or falsification of the content or appearance of this document is unlawful and offenders may be prosecuted to the fullest extent of the law. Unless otherwise stated the results shown in this test report refer only to the sample(s) tested and such sample(s) are retained for 30 days only.

Attention: To check the authenticity of testing/inspection report & certificate, please contact us at telephone: (86-755) 8307 1443, or email: [CN.Doccheck@sgs.com](mailto:CN.Doccheck@sgs.com)

South of No. 6 Plant, No. 1, Runsheng Road, Suzhou Industrial Park, Suzhou Area, China (Jiangsu) Pilot Free Trade Zone 215000 t (86-512) 62992980 www.sgsgroup.com.cn  
 中国·苏州·中国(江苏)自由贸易试验区苏州片区苏州工业园区润胜路1号的6号厂房南楼 邮编: 215000 t (86-512) 62992980 sgs.china@sgs.com

802.11b\_Channel 11

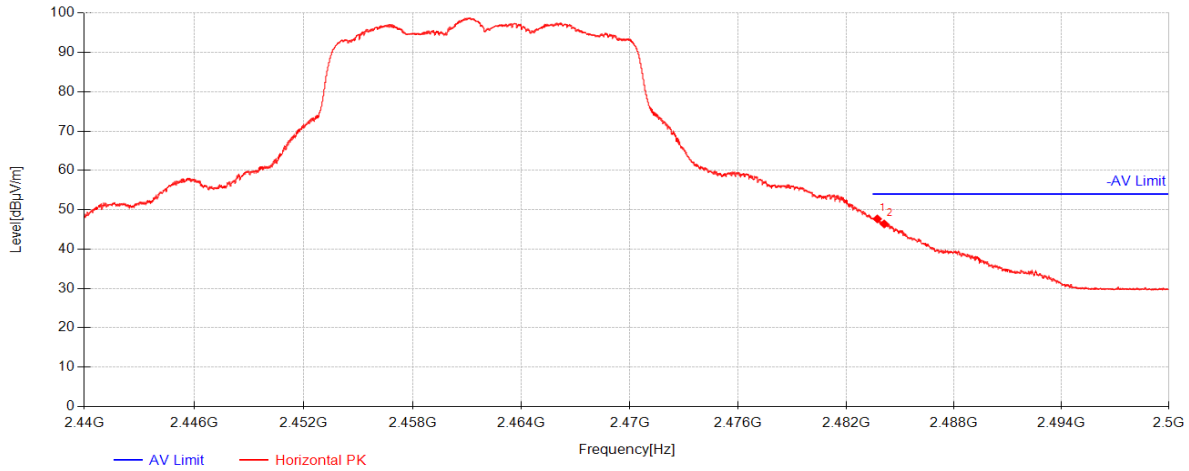

Data List										
NO.	Frequency [MHz]	Reading [dBµV]	AF [dB/m]	Factor [dB]	Level [dBµV/m]	Limit [dBµV/m]	Margin [dB]	Height [cm]	Angle [°]	Polarity
1	2483.725	43.97	27.25	-23.54	47.68	54.00	6.32	126	55	Horizontal
2	2484.1075	42.69	27.26	-23.54	46.40	54.00	7.60	126	55	Horizontal



Unless otherwise agreed in writing, this document is issued by the Company subject to its General Conditions of Service printed overleaf, available on request or accessible at <http://www.sgs.com/en/Terms-and-Conditions.aspx> and, for electronic format documents, subject to Terms and Conditions for Electronic Documents at <http://www.sgs.com/en/Terms-and-Conditions/Terms-e-Documents.aspx>. Attention is drawn to the limitation of liability, indemnification and jurisdiction issues defined therein. Any holder of this document is advised that information contained hereon reflects the Company's findings at the time of its intervention only and within the limits of Client's instructions, if any. The Company's sole responsibility is to its Client and this document does not exonerate parties to a transaction from exercising all their rights and obligations under the transaction documents. This document cannot be reproduced except in full, without prior written approval of the Company. Any unauthorized alteration, forgery or falsification of the content or appearance of this document is unlawful and offenders may be prosecuted to the fullest extent of the law. Unless otherwise stated the results shown in this test report refer only to the sample(s) tested and such sample(s) are retained for 30 days only.

Attention: To check the authenticity of testing/inspection report & certificate, please contact us at telephone: (86-755) 8307 1443, or email: [CN.Doccheck@sgs.com](mailto:CN.Doccheck@sgs.com)

South of No. 6 Plant, No. 1, Runsheng Road, Suzhou Industrial Park, Suzhou Area, China (Jiangsu) Pilot Free Trade Zone 215000 t (86-512) 62992980 www.sgsgroup.com.cn  
 中国·苏州·中国(江苏)自由贸易试验区苏州片区苏州工业园区润胜路1号的6号厂房南楼 邮编: 215000 t (86-512) 62992980 sgs.china@sgs.com

802.11g\_Channel 11

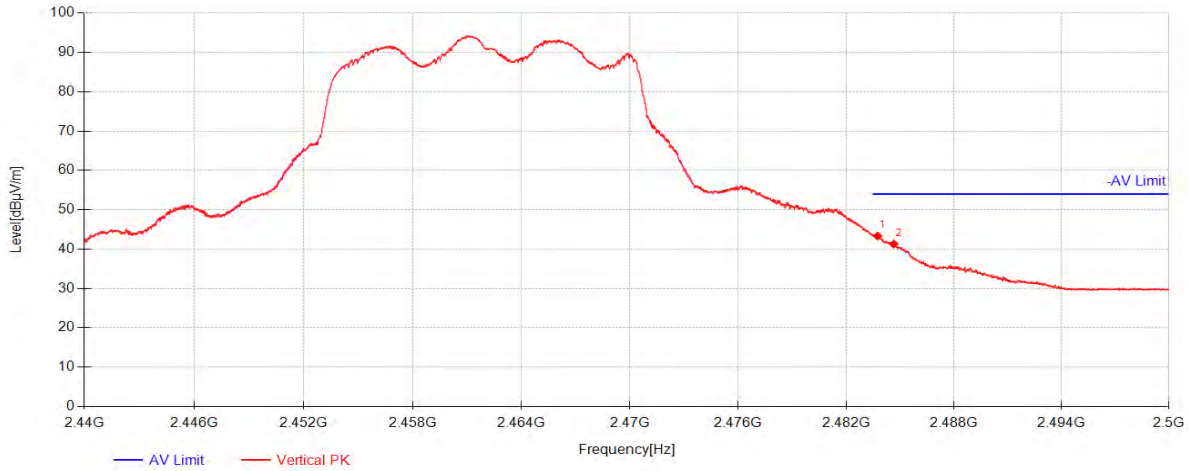

Data List										
NO.	Frequency [MHz]	Reading [dBμV]	AF [dB/m]	Factor [dB]	Level [dBμV/m]	Limit [dBμV/m]	Margin [dB]	Height [cm]	Angle [°]	Polarity
1	2483.74	39.62	27.25	-23.54	43.33	54.00	10.67	222	189	Vertical
2	2484.64	37.59	27.26	-23.54	41.30	54.00	12.70	222	189	Vertical



Unless otherwise agreed in writing, this document is issued by the Company subject to its General Conditions of Service printed overleaf, available on request or accessible at <http://www.sgs.com/en/Terms-and-Conditions.aspx> and, for electronic format documents, subject to Terms and Conditions for Electronic Documents at <http://www.sgs.com/en/Terms-and-Conditions/Terms-e-Documents.aspx>. Attention is drawn to the limitation of liability, indemnification and jurisdiction issues defined therein. Any holder of this document is advised that information contained hereon reflects the Company's findings at the time of its intervention only and within the limits of Client's instructions, if any. The Company's sole responsibility is to its Client and this document does not exonerate parties to a transaction from exercising all their rights and obligations under the transaction documents. This document cannot be reproduced except in full, without prior written approval of the Company. Any unauthorized alteration, forgery or falsification of the content or appearance of this document is unlawful and offenders may be prosecuted to the fullest extent of the law. Unless otherwise stated the results shown in this test report refer only to the sample(s) tested and such sample(s) are retained for 30 days only.

Attention: To check the authenticity of testing/inspection report & certificate, please contact us at telephone: (86-755) 8307 1443, or email: [CN.Doccheck@sgs.com](mailto:CN.Doccheck@sgs.com)

South of No. 6 Plant, No. 1, Runsheng Road, Suzhou Industrial Park, Suzhou Area, China (Jiangsu) Pilot Free Trade Zone 215000 t (86-512) 62992980 www.sgs.com.cn  
 中国·苏州·中国(江苏)自由贸易试验区苏州片区苏州工业园区润胜路1号的6号厂房南楼 邮编: 215000 t (86-512) 62992980 sgs.china@sgs.com

802.11g\_Channel 11

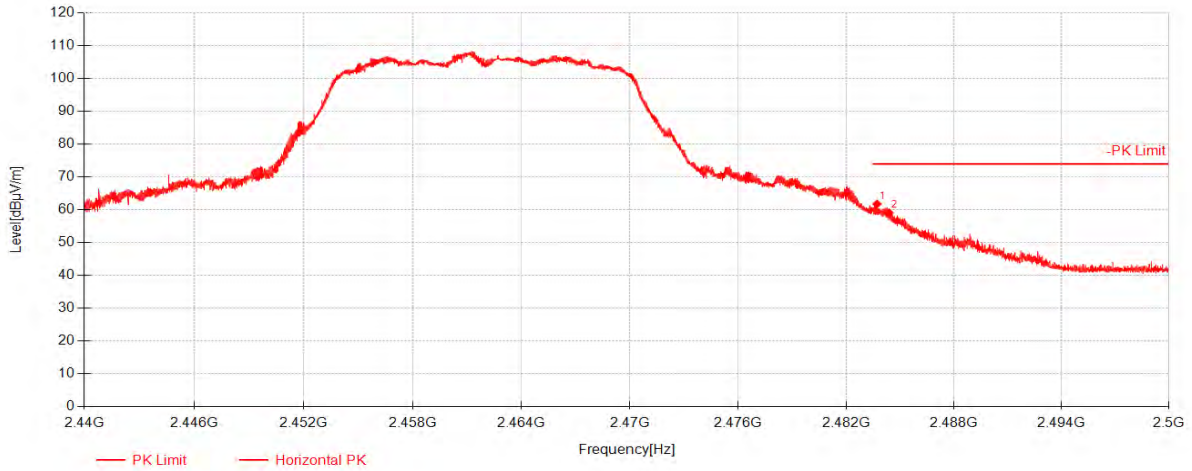

Data List										
NO.	Frequency [MHz]	Reading [dBµV]	AF [dB/m]	Factor [dB]	Level [dBµV/m]	Limit [dBµV/m]	Margin [dB]	Height [cm]	Angle [°]	Polarity
1	2483.71	58.06	27.25	-23.54	61.77	74.00	12.23	126	55	Horizontal
2	2484.3775	55.35	27.26	-23.54	59.06	74.00	14.94	126	55	Horizontal



Unless otherwise agreed in writing, this document is issued by the Company subject to its General Conditions of Service printed overleaf, available on request or accessible at <http://www.sgs.com/en/Terms-and-Conditions.aspx> and, for electronic format documents, subject to Terms and Conditions for Electronic Documents at <http://www.sgs.com/en/Terms-and-Conditions/Terms-e-Documents.aspx>. Attention is drawn to the limitation of liability, indemnification and jurisdiction issues defined therein. Any holder of this document is advised that information contained hereon reflects the Company's findings at the time of its intervention only and within the limits of Client's instructions, if any. The Company's sole responsibility is to its Client and this document does not exonerate parties to a transaction from exercising all their rights and obligations under the transaction documents. This document cannot be reproduced except in full, without prior written approval of the Company. Any unauthorized alteration, forgery or falsification of the content or appearance of this document is unlawful and offenders may be prosecuted to the fullest extent of the law. Unless otherwise stated the results shown in this test report refer only to the sample(s) tested and such sample(s) are retained for 30 days only.

Attention: To check the authenticity of testing/inspection report & certificate, please contact us at telephone: (86-755) 8307 1443, or email: [CN.Doccheck@sgs.com](mailto:CN.Doccheck@sgs.com)

South of No. 6 Plant, No. 1, Runsheng Road, Suzhou Industrial Park, Suzhou Area, China (Jiangsu) Pilot Free Trade Zone 215000 t (86-512) 62992980 www.sgs.com.cn  
 中国·苏州·中国(江苏)自由贸易试验区苏州片区苏州工业园区润胜路1号的6号厂房南楼 邮编: 215000 t (86-512) 62992980 sgs.china@sgs.com

802.11b\_Channel 11

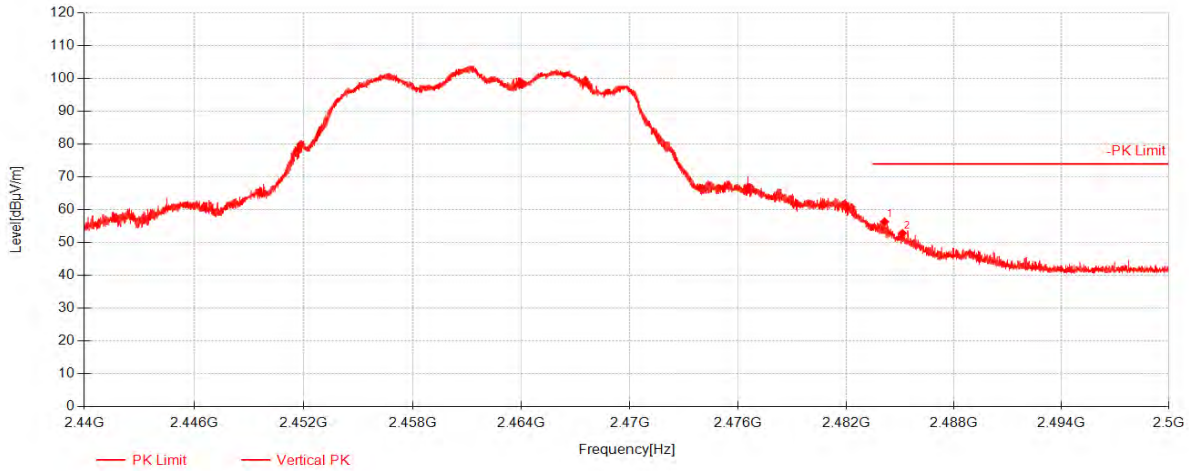

Data List										
NO.	Frequency [MHz]	Reading [dBμV]	AF [dB/m]	Factor [dB]	Level [dBμV/m]	Limit [dBμV/m]	Margin [dB]	Height [cm]	Angle [°]	Polarity
1	2484.1225	52.63	27.26	-23.54	56.34	74.00	17.66	222	189	Vertical
2	2485.1125	49.09	27.26	-23.54	52.80	74.00	21.20	222	189	Vertical



Unless otherwise agreed in writing, this document is issued by the Company subject to its General Conditions of Service printed overleaf, available on request or accessible at <http://www.sgs.com/en/Terms-and-Conditions.aspx> and, for electronic format documents, subject to Terms and Conditions for Electronic Documents at <http://www.sgs.com/en/Terms-and-Conditions/Terms-e-Documents.aspx>. Attention is drawn to the limitation of liability, indemnification and jurisdiction issues defined therein. Any holder of this document is advised that information contained hereon reflects the Company's findings at the time of its intervention only and within the limits of Client's instructions, if any. The Company's sole responsibility is to its Client and this document does not exonerate parties to a transaction from exercising all their rights and obligations under the transaction documents. This document cannot be reproduced except in full, without prior written approval of the Company. Any unauthorized alteration, forgery or falsification of the content or appearance of this document is unlawful and offenders may be prosecuted to the fullest extent of the law. Unless otherwise stated the results shown in this test report refer only to the sample(s) tested and such sample(s) are retained for 30 days only.

Attention: To check the authenticity of testing/inspection report & certificate, please contact us at telephone: (86-755) 8307 1443, or email: [CN.Doccheck@sgs.com](mailto:CN.Doccheck@sgs.com)

South of No. 6 Plant, No. 1, Runsheng Road, Suzhou Industrial Park, Suzhou Area, China (Jiangsu) Pilot Free Trade Zone 215000 t (86-512) 62992980 www.sgsgroup.com.cn  
 中国·苏州·中国(江苏)自由贸易试验区苏州片区苏州工业园区润胜路1号的6号厂房南楼 邮编: 215000 t (86-512) 62992980 sgs.china@sgs.com

802.11n20\_Channel 01

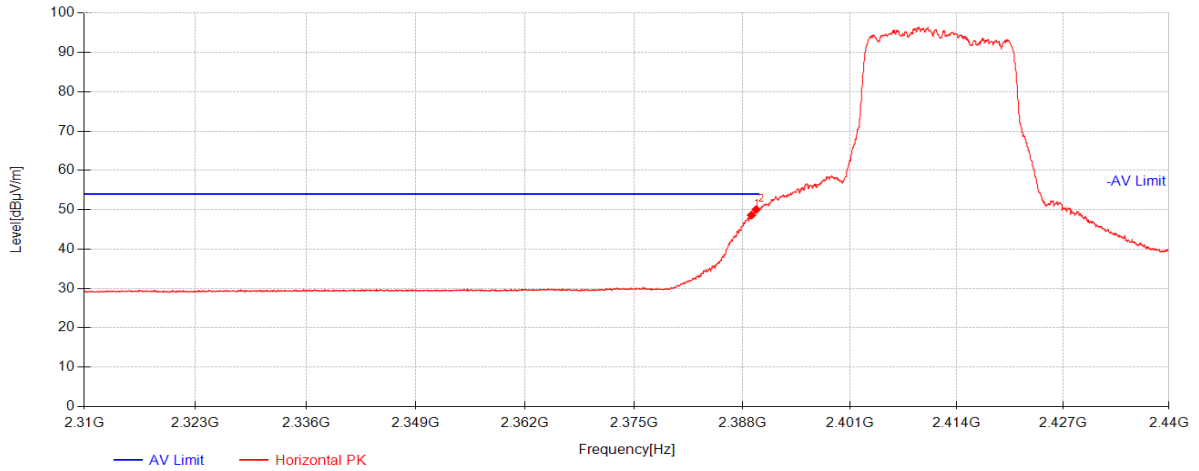

Data List										
NO.	Frequency [MHz]	Reading [dBµV]	AF [dB/m]	Factor [dB]	Level [dBµV/m]	Limit [dBµV/m]	Margin [dB]	Height [cm]	Angle [°]	Polarity
1	2389.1267	45.21	26.99	-23.57	48.63	54.00	5.37	203	276	Horizontal
2	2389.69	46.63	26.99	-23.57	50.05	54.00	3.95	203	276	Horizontal



Unless otherwise agreed in writing, this document is issued by the Company subject to its General Conditions of Service printed overleaf, available on request or accessible at <http://www.sgs.com/en/Terms-and-Conditions.aspx> and, for electronic format documents, subject to Terms and Conditions for Electronic Documents at <http://www.sgs.com/en/Terms-and-Conditions/Terms-e-Documents.aspx>. Attention is drawn to the limitation of liability, indemnification and jurisdiction issues defined therein. Any holder of this document is advised that information contained hereon reflects the Company's findings at the time of its intervention only and within the limits of Client's instructions, if any. The Company's sole responsibility is to its Client and this document does not exonerate parties to a transaction from exercising all their rights and obligations under the transaction documents. This document cannot be reproduced except in full, without prior written approval of the Company. Any unauthorized alteration, forgery or falsification of the content or appearance of this document is unlawful and offenders may be prosecuted to the fullest extent of the law. Unless otherwise stated the results shown in this test report refer only to the sample(s) tested and such sample(s) are retained for 30 days only.

Attention: To check the authenticity of testing/inspection report & certificate, please contact us at telephone: (86-755) 8307 1443, or email: [CN.Doccheck@sgs.com](mailto:CN.Doccheck@sgs.com)

South of No. 6 Plant, No. 1, Runsheng Road, Suzhou Industrial Park, Suzhou Area, China (Jiangsu) Pilot Free Trade Zone 215000 t (86-512) 62992980 www.sgsgroup.com.cn  
 中国·苏州·中国(江苏)自由贸易试验区苏州片区苏州工业园区润胜路1号的6号厂房南楼 邮编: 215000 t (86-512) 62992980 sgs.china@sgs.com



802.11n20\_Channel 01

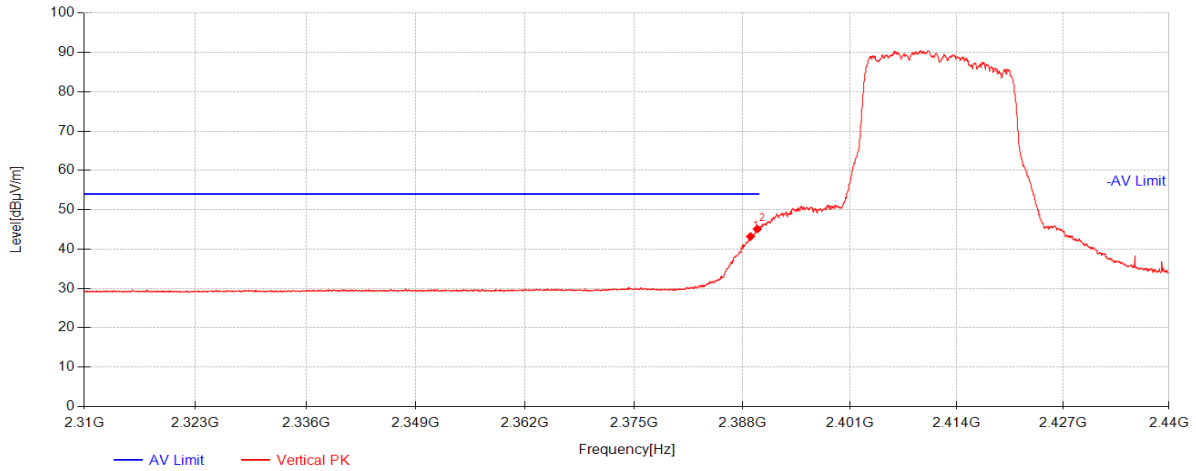

Data List										
NO.	Frequency [MHz]	Reading [dBµV]	AF [dB/m]	Factor [dB]	Level [dBµV/m]	Limit [dBµV/m]	Margin [dB]	Height [cm]	Angle [°]	Polarity
1	2388.9967	39.79	26.99	-23.57	43.21	54.00	10.79	146	232	Vertical
2	2389.82	41.69	26.99	-23.57	45.11	54.00	8.89	146	232	Vertical



Unless otherwise agreed in writing, this document is issued by the Company subject to its General Conditions of Service printed overleaf, available on request or accessible at <http://www.sgs.com/en/Terms-and-Conditions.aspx> and, for electronic format documents, subject to Terms and Conditions for Electronic Documents at <http://www.sgs.com/en/Terms-and-Conditions/Terms-e-Documents.aspx>. Attention is drawn to the limitation of liability, indemnification and jurisdiction issues defined therein. Any holder of this document is advised that information contained hereon reflects the Company's findings at the time of its intervention only and within the limits of Client's instructions, if any. The Company's sole responsibility is to its Client and this document does not exonerate parties to a transaction from exercising all their rights and obligations under the transaction documents. This document cannot be reproduced except in full, without prior written approval of the Company. Any unauthorized alteration, forgery or falsification of the content or appearance of this document is unlawful and offenders may be prosecuted to the fullest extent of the law. Unless otherwise stated the results shown in this test report refer only to the sample(s) tested and such sample(s) are retained for 30 days only.

Attention: To check the authenticity of testing/inspection report & certificate, please contact us at telephone: (86-755) 8307 1443, or email: [CN.Doccheck@sgs.com](mailto:CN.Doccheck@sgs.com)

South of No. 6 Plant, No. 1, Runsheng Road, Suzhou Industrial Park, Suzhou Area, China (Jiangsu) Pilot Free Trade Zone 215000 t (86-512) 62992980 www.sgsgroup.com.cn  
 中国·苏州·中国(江苏)自由贸易试验区苏州片区苏州工业园区润胜路1号的6号厂房南楼 邮编: 215000 t (86-512) 62992980 sgs.china@sgs.com

802.11n20\_Channel 01

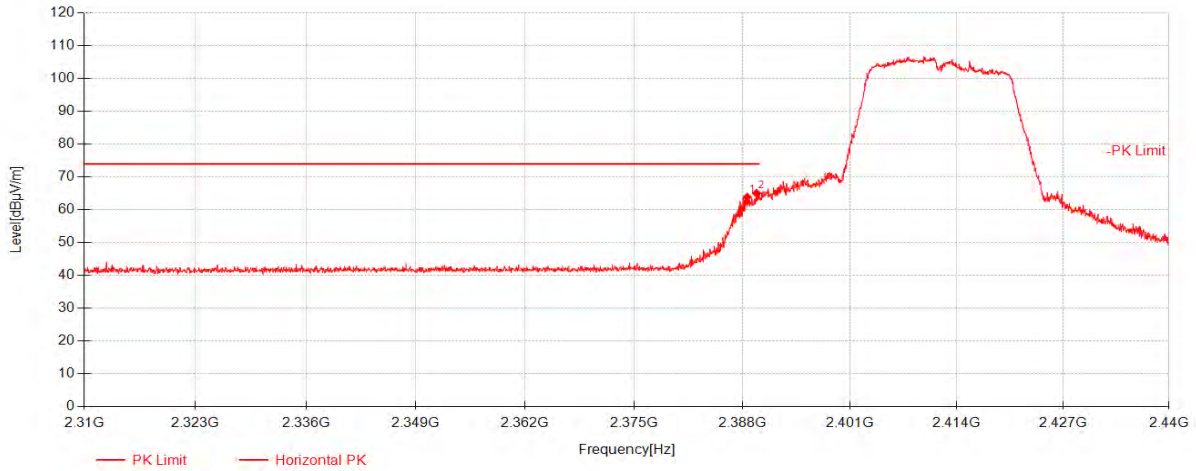

Data List										
NO.	Frequency [MHz]	Reading [dBµV]	AF [dB/m]	Factor [dB]	Level [dBµV/m]	Limit [dBµV/m]	Margin [dB]	Height [cm]	Angle [°]	Polarity
1	2388.6067	60.45	26.99	-23.57	63.87	74.00	10.13	203	276	Horizontal
2	2389.7333	61.62	26.99	-23.57	65.04	74.00	8.96	203	276	Horizontal



Unless otherwise agreed in writing, this document is issued by the Company subject to its General Conditions of Service printed overleaf, available on request or accessible at <http://www.sgs.com/en/Terms-and-Conditions.aspx> and, for electronic format documents, subject to Terms and Conditions for Electronic Documents at <http://www.sgs.com/en/Terms-and-Conditions/Terms-e-Documents.aspx>. Attention is drawn to the limitation of liability, indemnification and jurisdiction issues defined therein. Any holder of this document is advised that information contained hereon reflects the Company's findings at the time of its intervention only and within the limits of Client's instructions, if any. The Company's sole responsibility is to its Client and this document does not exonerate parties to a transaction from exercising all their rights and obligations under the transaction documents. This document cannot be reproduced except in full, without prior written approval of the Company. Any unauthorized alteration, forgery or falsification of the content or appearance of this document is unlawful and offenders may be prosecuted to the fullest extent of the law. Unless otherwise stated the results shown in this test report refer only to the sample(s) tested and such sample(s) are retained for 30 days only.

Attention: To check the authenticity of testing/inspection report & certificate, please contact us at telephone: (86-755) 8307 1443, or email: [CN.Doccheck@sgs.com](mailto:CN.Doccheck@sgs.com)

South of No. 6 Plant, No. 1, Runsheng Road, Suzhou Industrial Park, Suzhou Area, China (Jiangsu) Pilot Free Trade Zone 215000 t (86-512) 62992980 www.sgs.com.cn  
 中国·苏州·中国(江苏)自由贸易试验区苏州片区苏州工业园区润胜路1号的6号厂房南楼 邮编: 215000 t (86-512) 62992980 sgs.china@sgs.com

802.11n20\_Channel 01

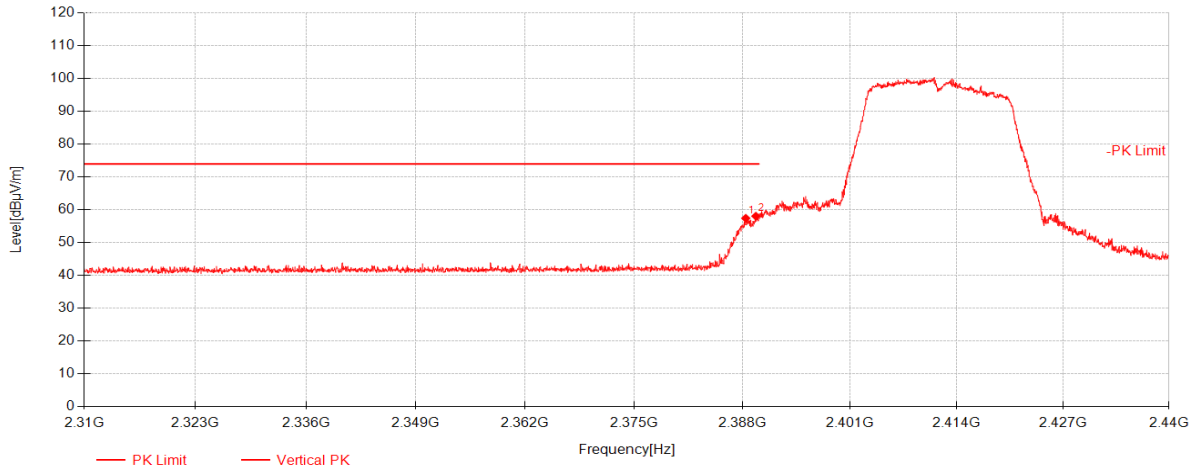

Data List										
NO.	Frequency [MHz]	Reading [dBµV]	AF [dB/m]	Factor [dB]	Level [dBµV/m]	Limit [dBµV/m]	Margin [dB]	Height [cm]	Angle [°]	Polarity
1	2388.4333	54.00	26.99	-23.57	57.42	74.00	16.58	146	232	Vertical
2	2389.6467	54.63	26.99	-23.57	58.05	74.00	15.95	146	232	Vertical



Unless otherwise agreed in writing, this document is issued by the Company subject to its General Conditions of Service printed overleaf, available on request or accessible at <http://www.sgs.com/en/Terms-and-Conditions.aspx> and, for electronic format documents, subject to Terms and Conditions for Electronic Documents at <http://www.sgs.com/en/Terms-and-Conditions/Terms-e-Documents.aspx>. Attention is drawn to the limitation of liability, indemnification and jurisdiction issues defined therein. Any holder of this document is advised that information contained hereon reflects the Company's findings at the time of its intervention only and within the limits of Client's instructions, if any. The Company's sole responsibility is to its Client and this document does not exonerate parties to a transaction from exercising all their rights and obligations under the transaction documents. This document cannot be reproduced except in full, without prior written approval of the Company. Any unauthorized alteration, forgery or falsification of the content or appearance of this document is unlawful and offenders may be prosecuted to the fullest extent of the law. Unless otherwise stated the results shown in this test report refer only to the sample(s) tested and such sample(s) are retained for 30 days only.

Attention: To check the authenticity of testing/inspection report & certificate, please contact us at telephone: (86-755) 8307 1443, or email: [CN.Doccheck@sgs.com](mailto:CN.Doccheck@sgs.com)

South of No. 6 Plant, No. 1, Runsheng Road, Suzhou Industrial Park, Suzhou Area, China (Jiangsu) Pilot Free Trade Zone 215000 t (86-512) 62992980 www.sgs.com.cn  
 中国·苏州·中国(江苏)自由贸易试验区苏州片区苏州工业园区润胜路1号的6号厂房南楼 邮编: 215000 t (86-512) 62992980 sgs.china@sgs.com

802.11n20\_Channel 11

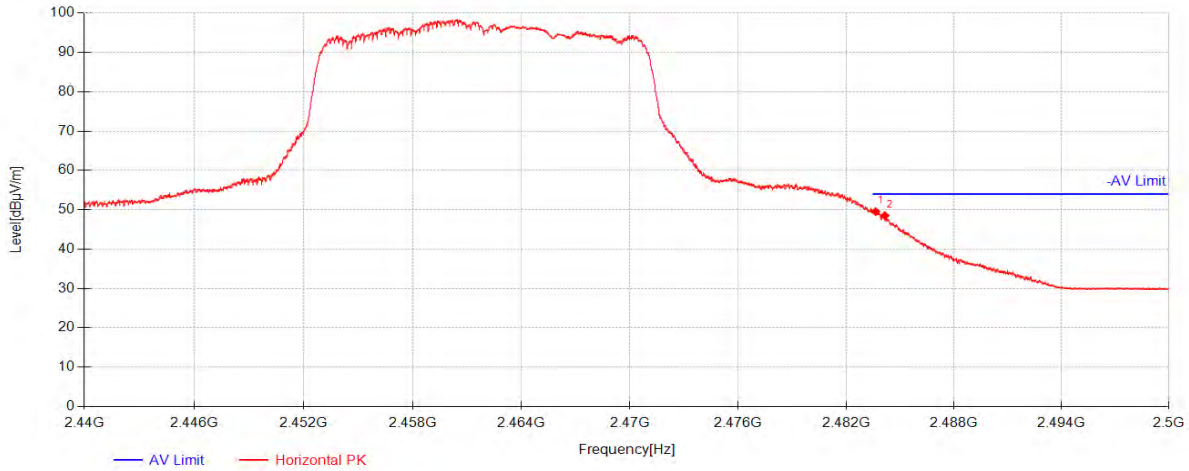

Data List										
NO.	Frequency [MHz]	Reading [dBμV]	AF [dB/m]	Factor [dB]	Level [dBμV/m]	Limit [dBμV/m]	Margin [dB]	Height [cm]	Angle [°]	Polarity
1	2483.635	45.82	27.25	-23.54	49.53	54.00	4.47	166	264	Horizontal
2	2484.145	44.82	27.26	-23.54	48.53	54.00	5.47	166	264	Horizontal



Unless otherwise agreed in writing, this document is issued by the Company subject to its General Conditions of Service printed overleaf, available on request or accessible at <http://www.sgs.com/en/Terms-and-Conditions.aspx> and, for electronic format documents, subject to Terms and Conditions for Electronic Documents at <http://www.sgs.com/en/Terms-and-Conditions/Terms-e-Documents.aspx>. Attention is drawn to the limitation of liability, indemnification and jurisdiction issues defined therein. Any holder of this document is advised that information contained hereon reflects the Company's findings at the time of its intervention only and within the limits of Client's instructions, if any. The Company's sole responsibility is to its Client and this document does not exonerate parties to a transaction from exercising all their rights and obligations under the transaction documents. This document cannot be reproduced except in full, without prior written approval of the Company. Any unauthorized alteration, forgery or falsification of the content or appearance of this document is unlawful and offenders may be prosecuted to the fullest extent of the law. Unless otherwise stated the results shown in this test report refer only to the sample(s) tested and such sample(s) are retained for 30 days only.

Attention: To check the authenticity of testing/inspection report & certificate, please contact us at telephone: (86-755) 8307 1443, or email: [CN.Doccheck@sgs.com](mailto:CN.Doccheck@sgs.com)

South of No. 6 Plant, No. 1, Runsheng Road, Suzhou Industrial Park, Suzhou Area, China (Jiangsu) Pilot Free Trade Zone 215000 t (86-512) 62992980 www.sgsgroup.com.cn  
 中国·苏州·中国(江苏)自由贸易试验区苏州片区苏州工业园区润胜路1号的6号厂房南楼 邮编: 215000 t (86-512) 62992980 sgs.china@sgs.com

802.11n20\_Channel 11

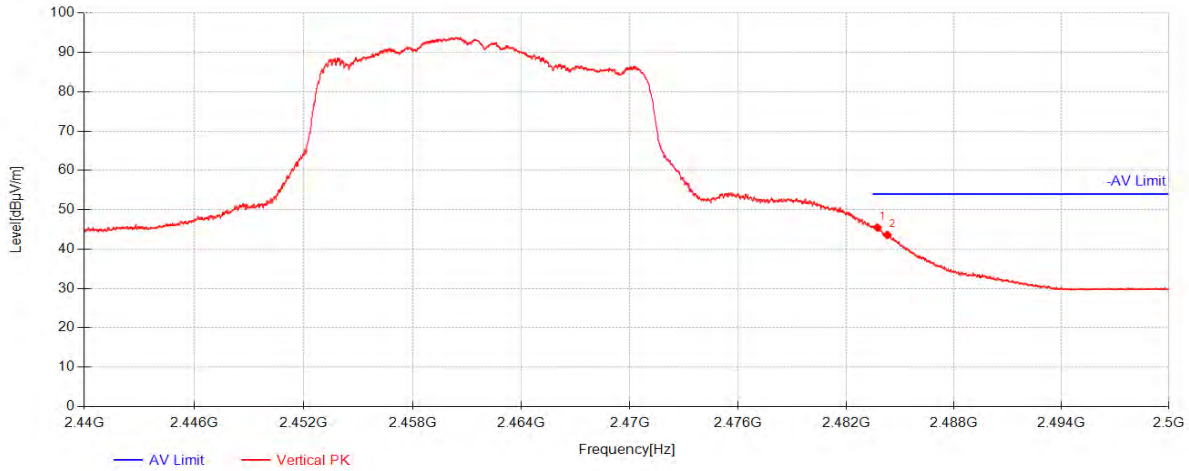

Data List										
NO.	Frequency [MHz]	Reading [dBµV]	AF [dB/m]	Factor [dB]	Level [dBµV/m]	Limit [dBµV/m]	Margin [dB]	Height [cm]	Angle [°]	Polarity
1	2483.725	41.79	27.25	-23.54	45.50	54.00	8.50	199	224	Vertical
2	2484.28	39.91	27.26	-23.54	43.62	54.00	10.38	199	224	Vertical



Unless otherwise agreed in writing, this document is issued by the Company subject to its General Conditions of Service printed overleaf, available on request or accessible at <http://www.sgs.com/en/Terms-and-Conditions.aspx> and, for electronic format documents, subject to Terms and Conditions for Electronic Documents at <http://www.sgs.com/en/Terms-and-Conditions/Terms-e-Documents.aspx>. Attention is drawn to the limitation of liability, indemnification and jurisdiction issues defined therein. Any holder of this document is advised that information contained hereon reflects the Company's findings at the time of its intervention only and within the limits of Client's instructions, if any. The Company's sole responsibility is to its Client and this document does not exonerate parties to a transaction from exercising all their rights and obligations under the transaction documents. This document cannot be reproduced except in full, without prior written approval of the Company. Any unauthorized alteration, forgery or falsification of the content or appearance of this document is unlawful and offenders may be prosecuted to the fullest extent of the law. Unless otherwise stated the results shown in this test report refer only to the sample(s) tested and such sample(s) are retained for 30 days only.

Attention: To check the authenticity of testing/inspection report & certificate, please contact us at telephone: (86-755) 8307 1443, or email: [CN.Doccheck@sgs.com](mailto:CN.Doccheck@sgs.com)

South of No. 6 Plant, No. 1, Runsheng Road, Suzhou Industrial Park, Suzhou Area, China (Jiangsu) Pilot Free Trade Zone 215000 t (86-512) 62992980 www.sgsgroup.com.cn  
 中国·苏州·中国(江苏)自由贸易试验区苏州片区苏州工业园区润胜路1号的6号厂房南楼 邮编: 215000 t (86-512) 62992980 sgs.china@sgs.com

802.11n20\_Channel 11

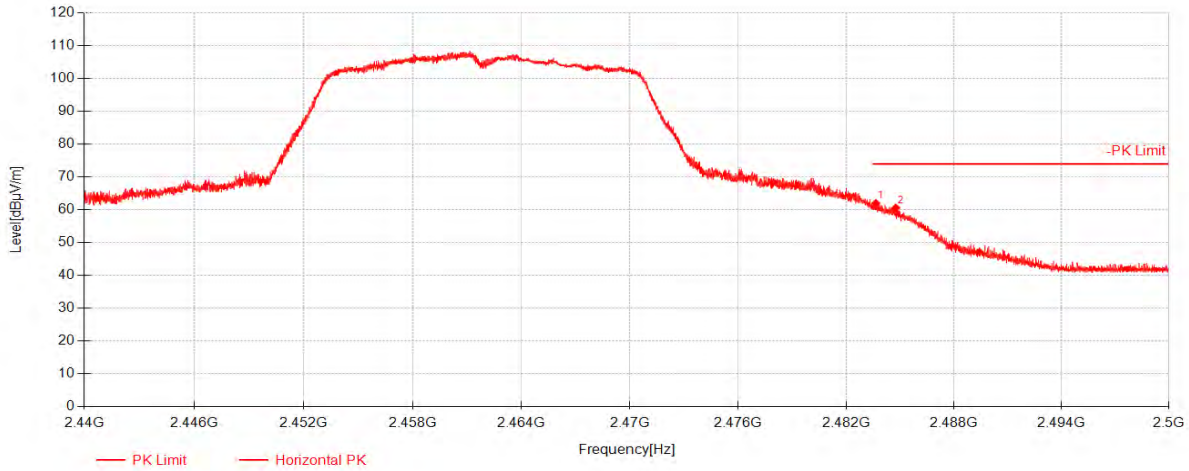

Data List										
NO.	Frequency [MHz]	Reading [dBµV]	AF [dB/m]	Factor [dB]	Level [dBµV/m]	Limit [dBµV/m]	Margin [dB]	Height [cm]	Angle [°]	Polarity
1	2483.6425	58.25	27.25	-23.54	61.96	74.00	12.04	166	264	Horizontal
2	2484.7525	56.83	27.26	-23.54	60.54	74.00	13.46	166	264	Horizontal



Unless otherwise agreed in writing, this document is issued by the Company subject to its General Conditions of Service printed overleaf, available on request or accessible at <http://www.sgs.com/en/Terms-and-Conditions.aspx> and, for electronic format documents, subject to Terms and Conditions for Electronic Documents at <http://www.sgs.com/en/Terms-and-Conditions/Terms-e-Documents.aspx>. Attention is drawn to the limitation of liability, indemnification and jurisdiction issues defined therein. Any holder of this document is advised that information contained hereon reflects the Company's findings at the time of its intervention only and within the limits of Client's instructions, if any. The Company's sole responsibility is to its Client and this document does not exonerate parties to a transaction from exercising all their rights and obligations under the transaction documents. This document cannot be reproduced except in full, without prior written approval of the Company. Any unauthorized alteration, forgery or falsification of the content or appearance of this document is unlawful and offenders may be prosecuted to the fullest extent of the law. Unless otherwise stated the results shown in this test report refer only to the sample(s) tested and such sample(s) are retained for 30 days only.

Attention: To check the authenticity of testing/inspection report & certificate, please contact us at telephone: (86-755) 8307 1443, or email: [CN.Doccheck@sgs.com](mailto:CN.Doccheck@sgs.com)

South of No. 6 Plant, No. 1, Runsheng Road, Suzhou Industrial Park, Suzhou Area, China (Jiangsu) Pilot Free Trade Zone 215000 t (86-512) 62992980 www.sgsgroup.com.cn  
 中国·苏州·中国(江苏)自由贸易试验区苏州片区苏州工业园区润胜路1号的6号厂房南楼 邮编: 215000 t (86-512) 62992980 sgs.china@sgs.com

802.11n20\_Channel 11

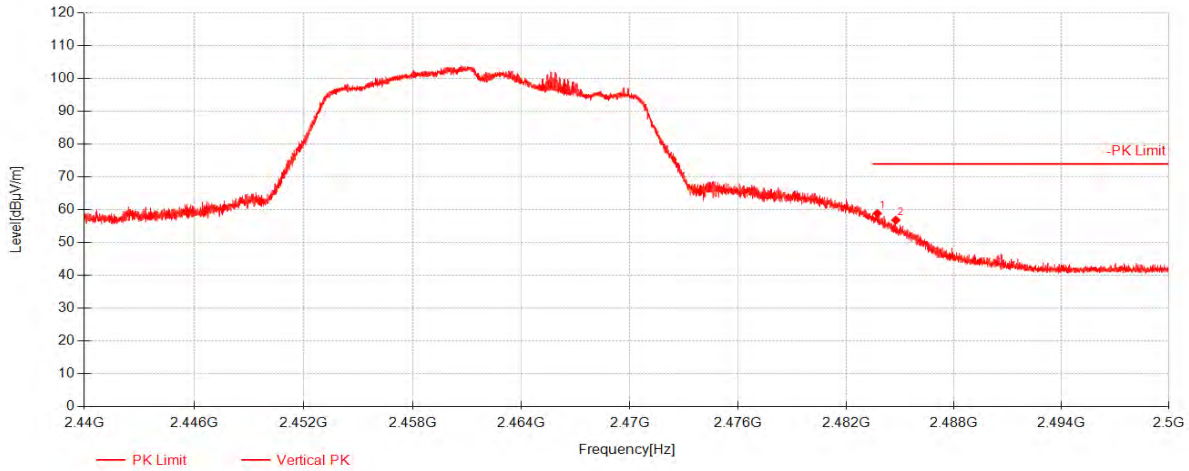

Data List										
NO.	Frequency [MHz]	Reading [dBμV]	AF [dB/m]	Factor [dB]	Level [dBμV/m]	Limit [dBμV/m]	Margin [dB]	Height [cm]	Angle [°]	Polarity
1	2483.725	55.17	27.25	-23.54	58.88	74.00	15.12	199	224	Vertical
2	2484.7525	53.12	27.26	-23.54	56.83	74.00	17.17	199	224	Vertical



Unless otherwise agreed in writing, this document is issued by the Company subject to its General Conditions of Service printed overleaf, available on request or accessible at <http://www.sgs.com/en/Terms-and-Conditions.aspx> and, for electronic format documents, subject to Terms and Conditions for Electronic Documents at <http://www.sgs.com/en/Terms-and-Conditions/Terms-e-Document.aspx>. Attention is drawn to the limitation of liability, indemnification and jurisdiction issues defined therein. Any holder of this document is advised that information contained hereon reflects the Company's findings at the time of its intervention only and within the limits of Client's instructions, if any. The Company's sole responsibility is to its Client and this document does not exonerate parties to a transaction from exercising all their rights and obligations under the transaction documents. This document cannot be reproduced except in full, without prior written approval of the Company. Any unauthorized alteration, forgery or falsification of the content or appearance of this document is unlawful and offenders may be prosecuted to the fullest extent of the law. Unless otherwise stated the results shown in this test report refer only to the sample(s) tested and such sample(s) are retained for 30 days only.

Attention: To check the authenticity of testing/inspection report & certificate, please contact us at telephone: (86-755) 8307 1443, or email: [CN.Doccheck@sgs.com](mailto:CN.Doccheck@sgs.com)

South of No. 6 Plant, No. 1, Runsheng Road, Suzhou Industrial Park, Suzhou Area, China (Jiangsu) Pilot Free Trade Zone 215000 t (86-512) 62992980 www.sgsgroup.com.cn  
 中国·苏州·中国(江苏)自由贸易试验区苏州片区苏州工业园区润胜路1号的6号厂房南楼 邮编: 215000 t (86-512) 62992980 sgs.china@sgs.com

802.11n40\_Channel 03

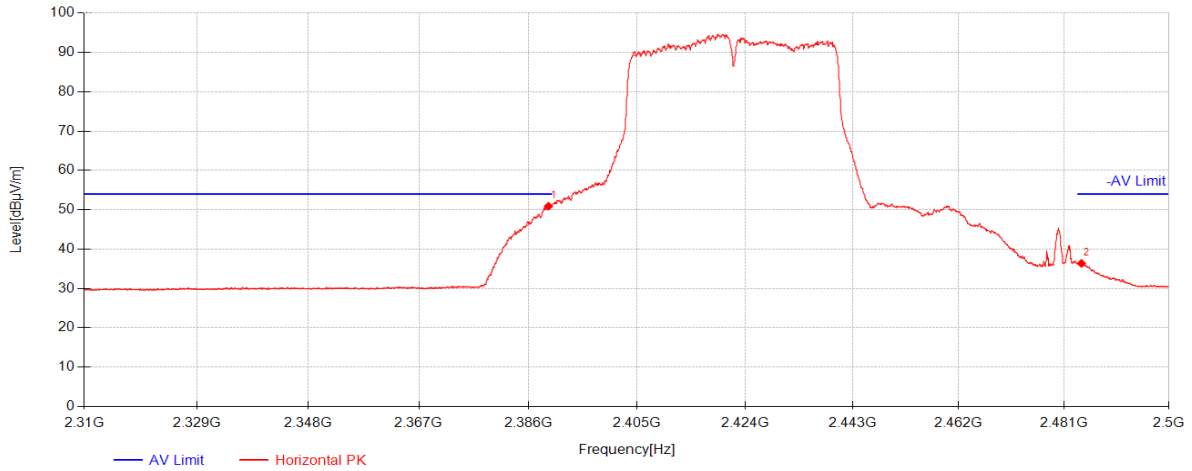

Data List										
NO.	Frequency [MHz]	Reading [dBµV]	AF [dB/m]	Factor [dB]	Level [dBµV/m]	Limit [dBµV/m]	Margin [dB]	Height [cm]	Angle [°]	Polarity
1	2389.4733	47.48	26.99	-23.57	50.90	54.00	3.10	251	269	Horizontal
2	2484.1	32.66	27.26	-23.54	36.37	54.00	17.63	251	269	Horizontal



Unless otherwise agreed in writing, this document is issued by the Company subject to its General Conditions of Service printed overleaf, available on request or accessible at <http://www.sgs.com/en/Terms-and-Conditions.aspx> and, for electronic format documents, subject to Terms and Conditions for Electronic Documents at <http://www.sgs.com/en/Terms-and-Conditions/Terms-e-Documents.aspx>. Attention is drawn to the limitation of liability, indemnification and jurisdiction issues defined therein. Any holder of this document is advised that information contained hereon reflects the Company's findings at the time of its intervention only and within the limits of Client's instructions, if any. The Company's sole responsibility is to its Client and this document does not exonerate parties to a transaction from exercising all their rights and obligations under the transaction documents. This document cannot be reproduced except in full, without prior written approval of the Company. Any unauthorized alteration, forgery or falsification of the content or appearance of this document is unlawful and offenders may be prosecuted to the fullest extent of the law. Unless otherwise stated the results shown in this test report refer only to the sample(s) tested and such sample(s) are retained for 30 days only.

Attention: To check the authenticity of testing/inspection report & certificate, please contact us at telephone: (86-755) 8307 1443, or email: [CN.Doccheck@sgs.com](mailto:CN.Doccheck@sgs.com)

South of No. 6 Plant, No. 1, Runsheng Road, Suzhou Industrial Park, Suzhou Area, China (Jiangsu) Pilot Free Trade Zone 215000 t (86-512) 62992980 www.sgsgroup.com.cn  
 中国·苏州·中国(江苏)自由贸易试验区苏州片区苏州工业园区润胜路1号的6号厂房南楼 邮编: 215000 t (86-512) 62992980 sgs.china@sgs.com



802.11n40\_Channel 03

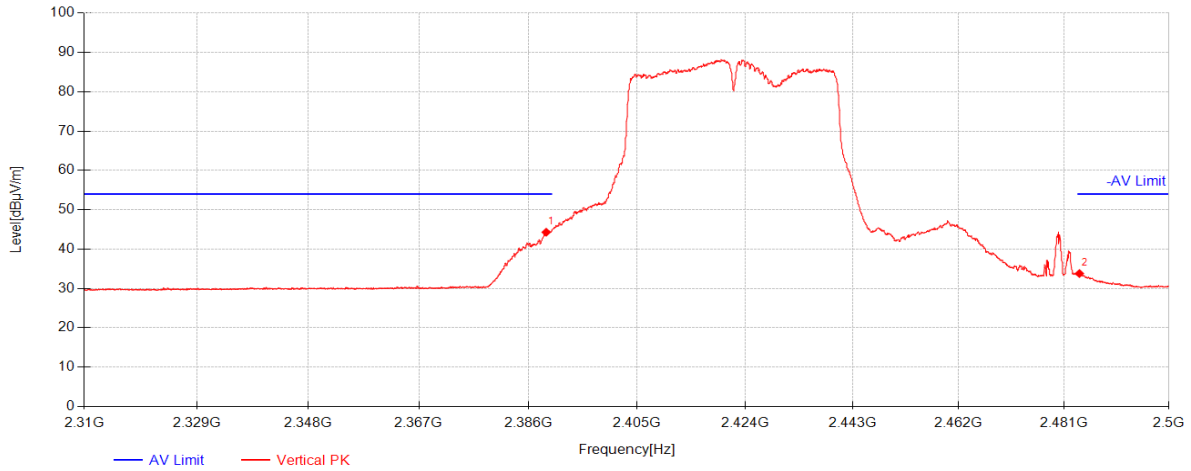

Data List										
NO.	Frequency [MHz]	Reading [dBµV]	AF [dB/m]	Factor [dB]	Level [dBµV/m]	Limit [dBµV/m]	Margin [dB]	Height [cm]	Angle [°]	Polarity
1	2389.0833	40.87	26.99	-23.57	44.29	54.00	9.71	132	232	Vertical
2	2483.74	30.08	27.25	-23.54	33.79	54.00	20.21	132	232	Vertical



Unless otherwise agreed in writing, this document is issued by the Company subject to its General Conditions of Service printed overleaf, available on request or accessible at <http://www.sgs.com/en/Terms-and-Conditions.aspx> and, for electronic format documents, subject to Terms and Conditions for Electronic Documents at <http://www.sgs.com/en/Terms-and-Conditions/Terms-e-Documents.aspx>. Attention is drawn to the limitation of liability, indemnification and jurisdiction issues defined therein. Any holder of this document is advised that information contained hereon reflects the Company's findings at the time of its intervention only and within the limits of Client's instructions, if any. The Company's sole responsibility is to its Client and this document does not exonerate parties to a transaction from exercising all their rights and obligations under the transaction documents. This document cannot be reproduced except in full, without prior written approval of the Company. Any unauthorized alteration, forgery or falsification of the content or appearance of this document is unlawful and offenders may be prosecuted to the fullest extent of the law. Unless otherwise stated the results shown in this test report refer only to the sample(s) tested and such sample(s) are retained for 30 days only.

Attention: To check the authenticity of testing/inspection report & certificate, please contact us at telephone: (86-755) 8307 1443, or email: [CN.Doccheck@sgs.com](mailto:CN.Doccheck@sgs.com)

South of No. 6 Plant, No. 1, Runsheng Road, Suzhou Industrial Park, Suzhou Area, China (Jiangsu) Pilot Free Trade Zone 215000 t (86-512) 62992980 www.sgs.com.cn  
 中国·苏州·中国(江苏)自由贸易试验区苏州片区苏州工业园区润胜路1号的6号厂房南楼 邮编: 215000 t (86-512) 62992980 sgs.china@sgs.com

802.11n40\_Channel 03

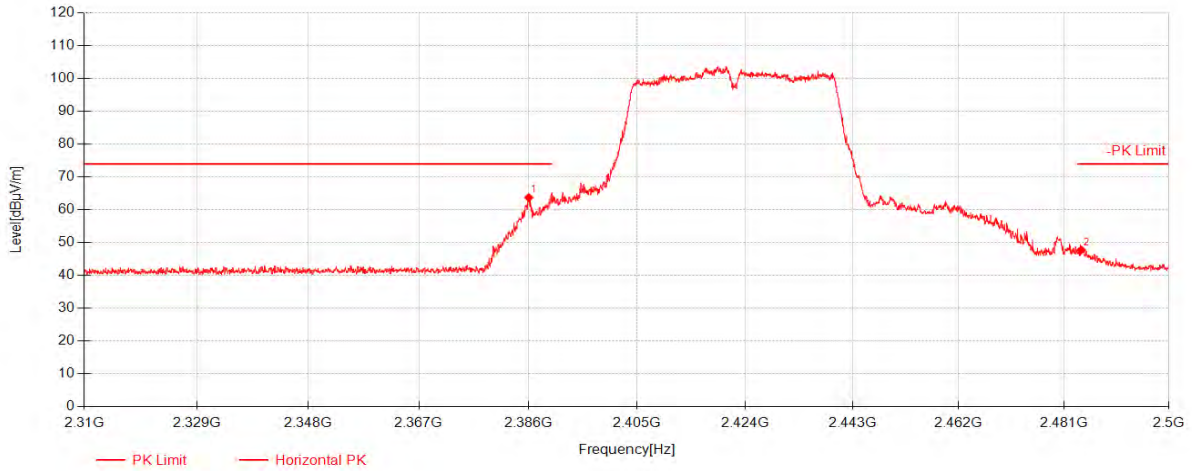

Data List										
NO.	Frequency [MHz]	Reading [dBµV]	AF [dB/m]	Factor [dB]	Level [dBµV/m]	Limit [dBµV/m]	Margin [dB]	Height [cm]	Angle [°]	Polarity
1	2386.05	60.32	26.98	-23.57	63.73	74.00	10.27	251	269	Horizontal
2	2484.1	44.05	27.26	-23.54	47.76	74.00	26.24	251	269	Horizontal



Unless otherwise agreed in writing, this document is issued by the Company subject to its General Conditions of Service printed overleaf, available on request or accessible at <http://www.sgs.com/en/Terms-and-Conditions.aspx> and, for electronic format documents, subject to Terms and Conditions for Electronic Documents at <http://www.sgs.com/en/Terms-and-Conditions/Terms-e-Documents.aspx>. Attention is drawn to the limitation of liability, indemnification and jurisdiction issues defined therein. Any holder of this document is advised that information contained hereon reflects the Company's findings at the time of its intervention only and within the limits of Client's instructions, if any. The Company's sole responsibility is to its Client and this document does not exonerate parties to a transaction from exercising all their rights and obligations under the transaction documents. This document cannot be reproduced except in full, without prior written approval of the Company. Any unauthorized alteration, forgery or falsification of the content or appearance of this document is unlawful and offenders may be prosecuted to the fullest extent of the law. Unless otherwise stated the results shown in this test report refer only to the sample(s) tested and such sample(s) are retained for 30 days only.

Attention: To check the authenticity of testing/inspection report & certificate, please contact us at telephone: (86-755) 8307 1443, or email: [CN.Doccheck@sgs.com](mailto:CN.Doccheck@sgs.com)

South of No. 6 Plant, No. 1, Runsheng Road, Suzhou Industrial Park, Suzhou Area, China (Jiangsu) Pilot Free Trade Zone 215000 t (86-512) 62992980 www.sgsgroup.com.cn  
 中国·苏州·中国(江苏)自由贸易试验区苏州片区苏州工业园区润胜路1号的6号厂房南楼 邮编: 215000 t (86-512) 62992980 sgs.china@sgs.com

802.11n40\_Channel 03

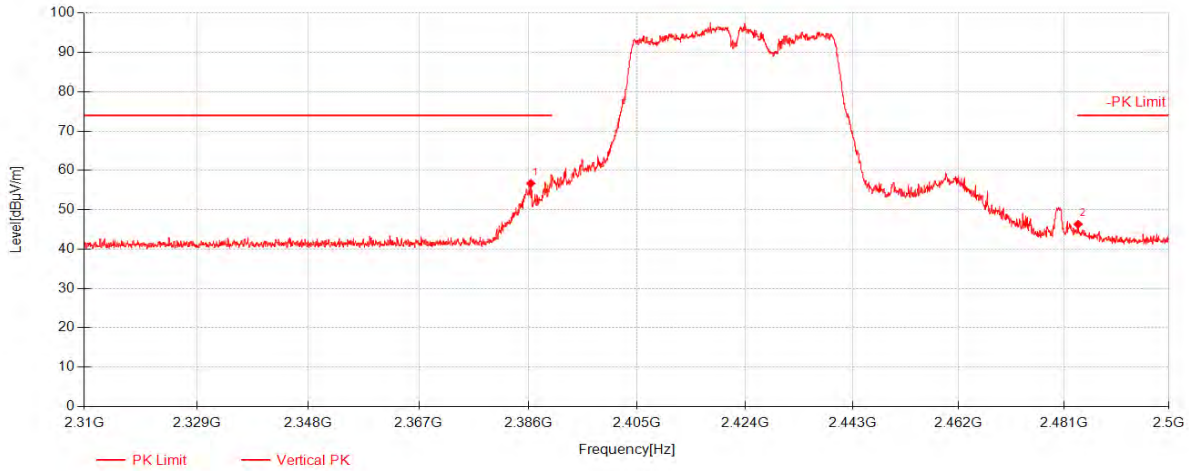

Data List										
NO.	Frequency [MHz]	Reading [dBµV]	AF [dB/m]	Factor [dB]	Level [dBµV/m]	Limit [dBµV/m]	Margin [dB]	Height [cm]	Angle [°]	Polarity
1	2386.3967	53.29	26.98	-23.57	56.70	74.00	17.30	132	232	Vertical
2	2483.5	42.61	27.25	-23.54	46.32	74.00	27.68	132	232	Vertical



Unless otherwise agreed in writing, this document is issued by the Company subject to its General Conditions of Service printed overleaf, available on request or accessible at <http://www.sgs.com/en/Terms-and-Conditions.aspx> and, for electronic format documents, subject to Terms and Conditions for Electronic Documents at <http://www.sgs.com/en/Terms-and-Conditions/Terms-e-Documents.aspx>. Attention is drawn to the limitation of liability, indemnification and jurisdiction issues defined therein. Any holder of this document is advised that information contained hereon reflects the Company's findings at the time of its intervention only and within the limits of Client's instructions, if any. The Company's sole responsibility is to its Client and this document does not exonerate parties to a transaction from exercising all their rights and obligations under the transaction documents. This document cannot be reproduced except in full, without prior written approval of the Company. Any unauthorized alteration, forgery or falsification of the content or appearance of this document is unlawful and offenders may be prosecuted to the fullest extent of the law. Unless otherwise stated the results shown in this test report refer only to the sample(s) tested and such sample(s) are retained for 30 days only.

Attention: To check the authenticity of testing/inspection report & certificate, please contact us at telephone: (86-755) 8307 1443, or email: [CN.Doccheck@sgs.com](mailto:CN.Doccheck@sgs.com)

South of No. 6 Plant, No. 1, Runsheng Road, Suzhou Industrial Park, Suzhou Area, China (Jiangsu) Pilot Free Trade Zone 215000 t (86-512) 62992980 www.sgs.com.cn  
 中国·苏州·中国(江苏)自由贸易试验区苏州片区苏州工业园区润胜路1号的6号厂房南楼 邮编: 215000 t (86-512) 62992980 sgs.china@sgs.com

802.11n40\_Channel 09

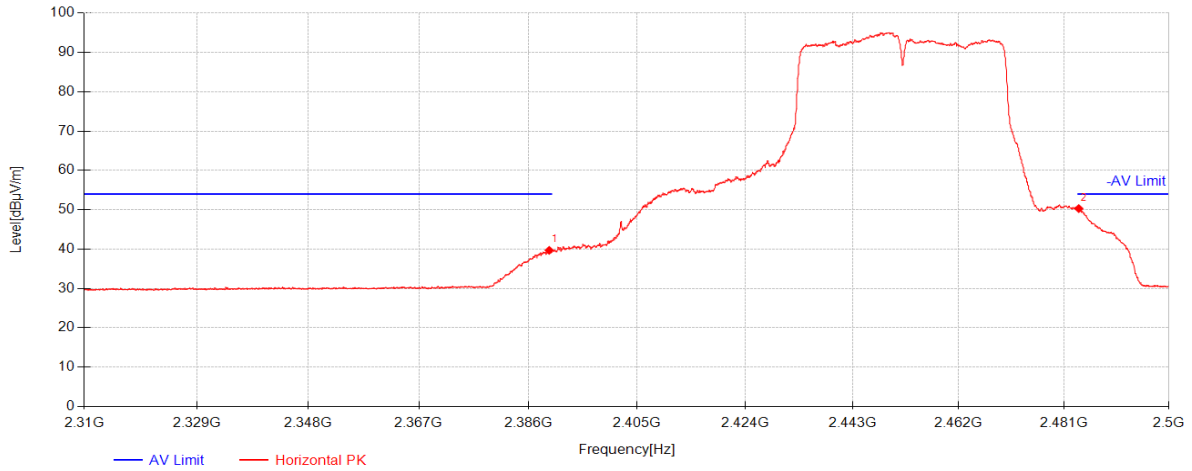

Data List										
NO.	Frequency [MHz]	Reading [dBµV]	AF [dB/m]	Factor [dB]	Level [dBµV/m]	Limit [dBµV/m]	Margin [dB]	Height [cm]	Angle [°]	Polarity
1	2389.6033	36.27	26.99	-23.57	39.69	54.00	14.31	200	261	Horizontal
2	2483.62	46.59	27.25	-23.54	50.30	54.00	3.70	200	261	Horizontal



Unless otherwise agreed in writing, this document is issued by the Company subject to its General Conditions of Service printed overleaf, available on request or accessible at <http://www.sgs.com/en/Terms-and-Conditions.aspx> and, for electronic format documents, subject to Terms and Conditions for Electronic Documents at <http://www.sgs.com/en/Terms-and-Conditions/Terms-e-Documents.aspx>. Attention is drawn to the limitation of liability, indemnification and jurisdiction issues defined therein. Any holder of this document is advised that information contained hereon reflects the Company's findings at the time of its intervention only and within the limits of Client's instructions, if any. The Company's sole responsibility is to its Client and this document does not exonerate parties to a transaction from exercising all their rights and obligations under the transaction documents. This document cannot be reproduced except in full, without prior written approval of the Company. Any unauthorized alteration, forgery or falsification of the content or appearance of this document is unlawful and offenders may be prosecuted to the fullest extent of the law. Unless otherwise stated the results shown in this test report refer only to the sample(s) tested and such sample(s) are retained for 30 days only.

Attention: To check the authenticity of testing/inspection report & certificate, please contact us at telephone: (86-755) 8307 1443, or email: [CN.Doccheck@sgs.com](mailto:CN.Doccheck@sgs.com)

South of No. 6 Plant, No. 1, Runsheng Road, Suzhou Industrial Park, Suzhou Area, China (Jiangsu) Pilot Free Trade Zone 215000 t (86-512) 62992980 www.sgsgroup.com.cn  
 中国·苏州·中国(江苏)自由贸易试验区苏州片区苏州工业园区润胜路1号的6号厂房南楼 邮编: 215000 t (86-512) 62992980 sgs.china@sgs.com

802.11n40\_Channel 09

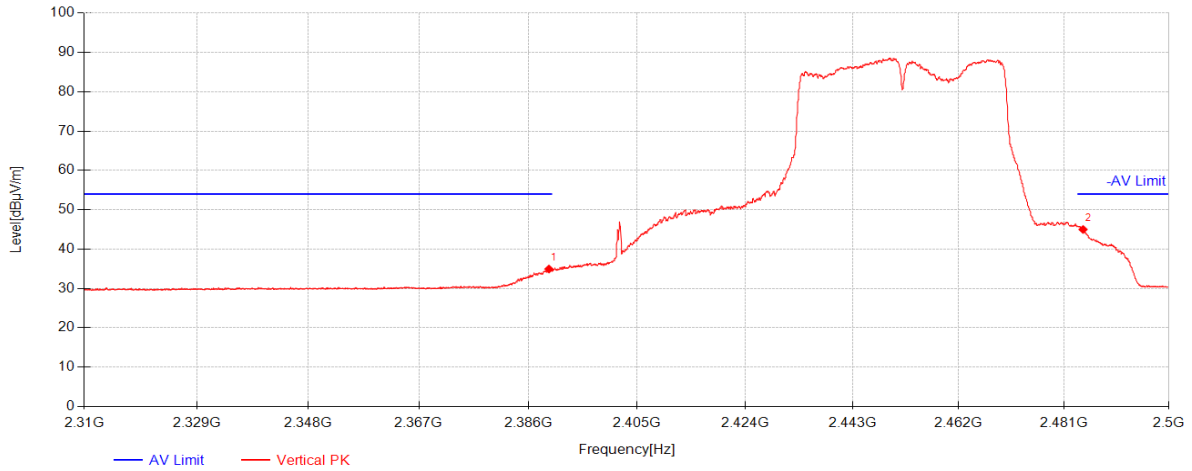

Data List										
NO.	Frequency [MHz]	Reading [dBµV]	AF [dB/m]	Factor [dB]	Level [dBµV/m]	Limit [dBµV/m]	Margin [dB]	Height [cm]	Angle [°]	Polarity
1	2389.56	31.52	26.99	-23.57	34.94	54.00	19.06	233	244	Vertical
2	2484.4	41.28	27.26	-23.54	44.99	54.00	9.01	233	244	Vertical



Unless otherwise agreed in writing, this document is issued by the Company subject to its General Conditions of Service printed overleaf, available on request or accessible at <http://www.sgs.com/en/Terms-and-Conditions.aspx> and, for electronic format documents, subject to Terms and Conditions for Electronic Documents at <http://www.sgs.com/en/Terms-and-Conditions/Terms-e-Documents.aspx>. Attention is drawn to the limitation of liability, indemnification and jurisdiction issues defined therein. Any holder of this document is advised that information contained hereon reflects the Company's findings at the time of its intervention only and within the limits of Client's instructions, if any. The Company's sole responsibility is to its Client and this document does not exonerate parties to a transaction from exercising all their rights and obligations under the transaction documents. This document cannot be reproduced except in full, without prior written approval of the Company. Any unauthorized alteration, forgery or falsification of the content or appearance of this document is unlawful and offenders may be prosecuted to the fullest extent of the law. Unless otherwise stated the results shown in this test report refer only to the sample(s) tested and such sample(s) are retained for 30 days only.

Attention: To check the authenticity of testing/inspection report & certificate, please contact us at telephone: (86-755) 8307 1443, or email: [CN.Doccheck@sgs.com](mailto:CN.Doccheck@sgs.com)

South of No. 6 Plant, No. 1, Runsheng Road, Suzhou Industrial Park, Suzhou Area, China (Jiangsu) Pilot Free Trade Zone 215000 t (86-512) 62992980 www.sgs.com.cn  
 中国·苏州·中国(江苏)自由贸易试验区苏州片区苏州工业园区润胜路1号的6号厂房南楼 邮编: 215000 t (86-512) 62992980 sgs.china@sgs.com

802.11n40\_Channel 09

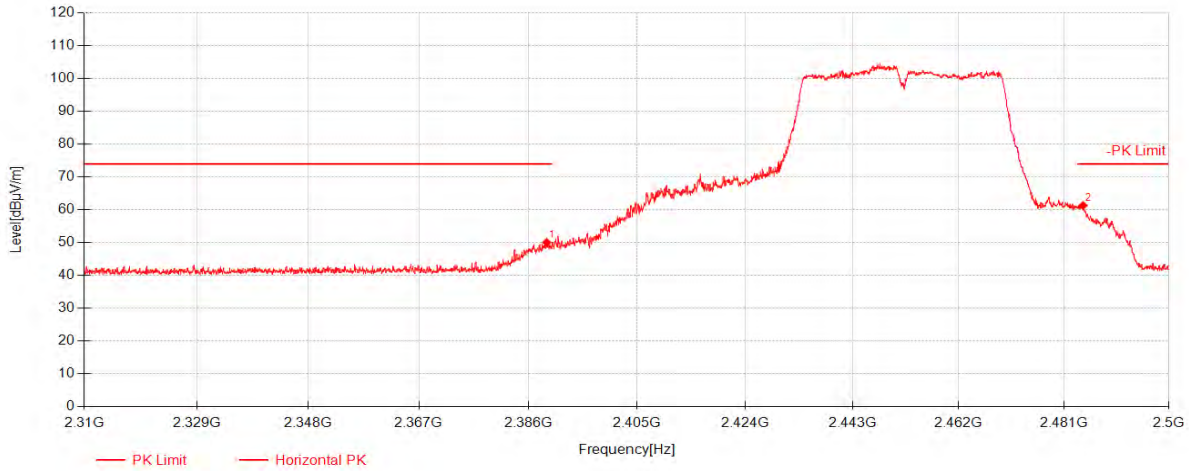

Data List										
NO.	Frequency [MHz]	Reading [dBμV]	AF [dB/m]	Factor [dB]	Level [dBμV/m]	Limit [dBμV/m]	Margin [dB]	Height [cm]	Angle [°]	Polarity
1	2389.17	46.64	26.99	-23.57	50.06	74.00	23.94	200	261	Horizontal
2	2484.4	57.59	27.26	-23.54	61.30	74.00	12.70	200	261	Horizontal



Unless otherwise agreed in writing, this document is issued by the Company subject to its General Conditions of Service printed overleaf, available on request or accessible at <http://www.sgs.com/en/Terms-and-Conditions.aspx> and, for electronic format documents, subject to Terms and Conditions for Electronic Documents at <http://www.sgs.com/en/Terms-and-Conditions/Terms-e-Documents.aspx>. Attention is drawn to the limitation of liability, indemnification and jurisdiction issues defined therein. Any holder of this document is advised that information contained hereon reflects the Company's findings at the time of its intervention only and within the limits of Client's instructions, if any. The Company's sole responsibility is to its Client and this document does not exonerate parties to a transaction from exercising all their rights and obligations under the transaction documents. This document cannot be reproduced except in full, without prior written approval of the Company. Any unauthorized alteration, forgery or falsification of the content or appearance of this document is unlawful and offenders may be prosecuted to the fullest extent of the law. Unless otherwise stated the results shown in this test report refer only to the sample(s) tested and such sample(s) are retained for 30 days only.

Attention: To check the authenticity of testing/inspection report & certificate, please contact us at telephone: (86-755) 8307 1443, or email: [CN.Doccheck@sgs.com](mailto:CN.Doccheck@sgs.com)

South of No. 6 Plant, No. 1, Runsheng Road, Suzhou Industrial Park, Suzhou Area, China (Jiangsu) Pilot Free Trade Zone 215000 t (86-512) 62992980 www.sgs.com.cn  
 中国·苏州·中国(江苏)自由贸易试验区苏州片区苏州工业园区润胜路1号的6号厂房南楼 邮编: 215000 t (86-512) 62992980 sgs.china@sgs.com

802.11n40\_Channel 09

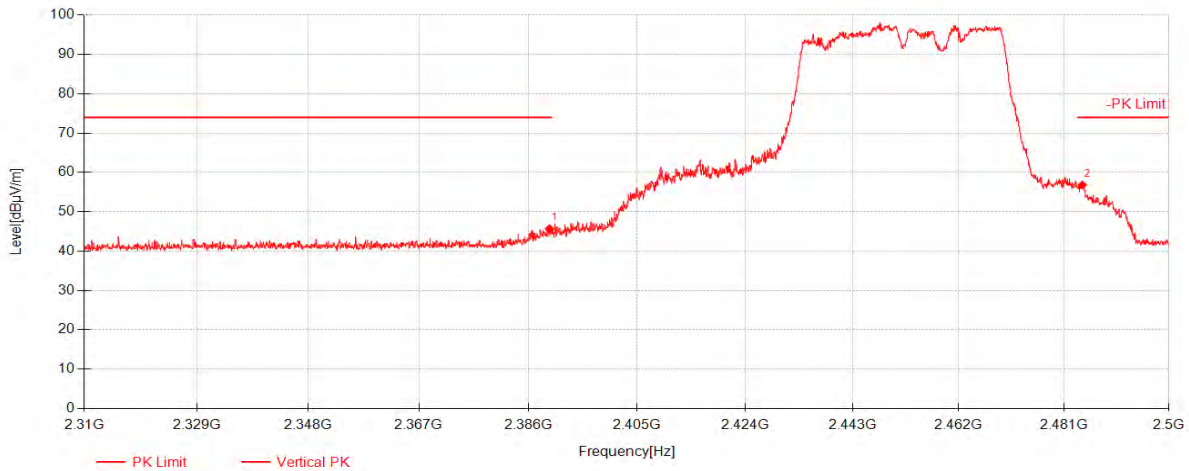

Data List										
NO.	Frequency [MHz]	Reading [dBµV]	AF [dB/m]	Factor [dB]	Level [dBµV/m]	Limit [dBµV/m]	Margin [dB]	Height [cm]	Angle [°]	Polarity
1	2389.6467	42.27	26.99	-23.57	45.69	74.00	28.31	233	244	Vertical
2	2484.28	53.10	27.26	-23.54	56.81	74.00	17.19	233	244	Vertical

Remark:

- The field strength is calculated by adding the Antenna Factor, Cable Factor & Preamplifier gain. The basic equation with a sample calculation is as follows:  
 $Level = Reading(dB\mu V) + AF(dB/m) + Factor(dB)$   
 $AF = Antenna\ Factor(dB/m)$   
 $Factor = Cable\ Factor(dB) - Preamplifier\ gain(dB)$   
 $Margin = Limit(dB\mu V/m) - Level(dB\mu V/m)$
- Both peak and average measured complies with the limit line, so test result is "PASS"
- For WLAN SISO & CDD/MIMO mode for 802.11b/g/n mode, the whole testing has assessed only CDD/MIMO mode by referring to their higher output power.



Unless otherwise agreed in writing, this document is issued by the Company subject to its General Conditions of Service printed overleaf, available on request or accessible at <http://www.sgs.com/en/Terms-and-Conditions.aspx> and, for electronic format documents, subject to Terms and Conditions for Electronic Documents at <http://www.sgs.com/en/Terms-and-Conditions/Terms-e-Documents.aspx>. Attention is drawn to the limitation of liability, indemnification and jurisdiction issues defined therein. Any holder of this document is advised that information contained hereon reflects the Company's findings at the time of its intervention only and within the limits of Client's instructions, if any. The Company's sole responsibility is to its Client and this document does not exonerate parties to a transaction from exercising all their rights and obligations under the transaction documents. This document cannot be reproduced except in full, without prior written approval of the Company. Any unauthorized alteration, forgery or falsification of the content or appearance of this document is unlawful and offenders may be prosecuted to the fullest extent of the law. Unless otherwise stated the results shown in this test report refer only to the sample(s) tested and such sample(s) are retained for 30 days only.  
 Attention: To check the authenticity of testing/inspection report & certificate, please contact us at telephone: (86-755) 8307 1443, or email: [CN.Doccheck@sgs.com](mailto:CN.Doccheck@sgs.com)

South of No. 6 Plant, No. 1, Runsheng Road, Suzhou Industrial Park, Suzhou Area, China (Jiangsu) Pilot Free Trade Zone 215000 t (86-512) 62992980 www.sgs.com.cn  
 中国·苏州·中国(江苏)自由贸易试验区苏州片区工业园区润胜路1号的6号厂房南楼 邮编: 215000 t (86-512) 62992980 sgs.china@sgs.com

**Test on the worst case:**

**802.11n40\_Channel 03**

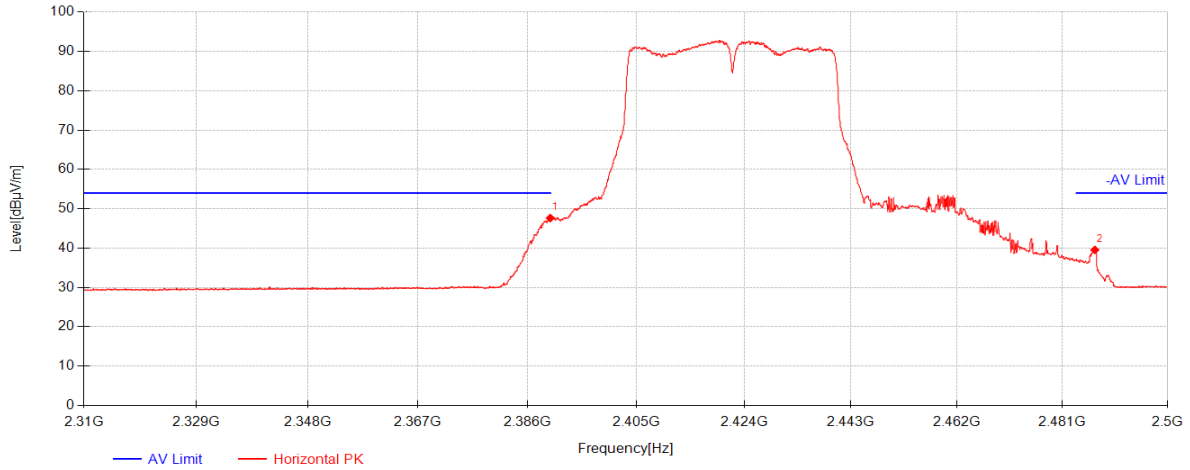

Data List								
NO.	Frequency [MHz]	Reading [dBµV]	AF [dB/m]	Factor [dB]	Level [dBµV/m]	Limit [dBµV/m]	Margin [dB]	Polarity
1	2389.95	44.23	26.99	-23.57	47.65	54.00	6.35	Horizontal
2	2486.86	35.82	27.26	-23.54	39.54	54.00	14.46	Horizontal



Unless otherwise agreed in writing, this document is issued by the Company subject to its General Conditions of Service printed overleaf, available on request or accessible at <http://www.sgs.com/en/Terms-and-Conditions.aspx> and, for electronic format documents, subject to Terms and Conditions for Electronic Documents at <http://www.sgs.com/en/Terms-and-Conditions/Terms-e-Documents.aspx>. Attention is drawn to the limitation of liability, indemnification and jurisdiction issues defined therein. Any holder of this document is advised that information contained hereon reflects the Company's findings at the time of its intervention only and within the limits of Client's instructions, if any. The Company's sole responsibility is to its Client and this document does not exonerate parties to a transaction from exercising all their rights and obligations under the transaction documents. This document cannot be reproduced except in full, without prior written approval of the Company. Any unauthorized alteration, forgery or falsification of the content or appearance of this document is unlawful and offenders may be prosecuted to the fullest extent of the law. Unless otherwise stated the results shown in this test report refer only to the sample(s) tested and such sample(s) are retained for 30 days only.

Attention: To check the authenticity of testing/inspection report & certificate, please contact us at telephone: (86-755) 8307 1443, or email: [CN.Doccheck@sgs.com](mailto:CN.Doccheck@sgs.com)

South of No. 6 Plant, No. 1, Runsheng Road, Suzhou Industrial Park, Suzhou Area, China (Jiangsu) Pilot Free Trade Zone 215000 t (86-512) 62992980 www.sgsgroup.com.cn  
 中国·苏州·中国(江苏)自由贸易试验区苏州片区苏州工业园区润胜路1号的6号厂房南楼 邮编: 215000 t (86-512) 62992980 sgs.china@sgs.com



802.11n40\_Channel 03

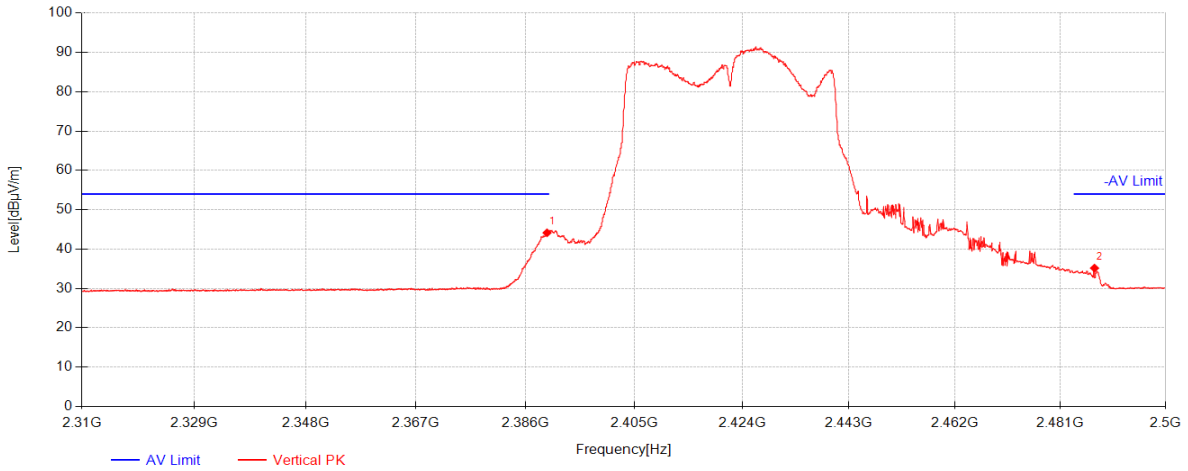

Data List								
NO.	Frequency [MHz]	Reading [dBµV]	AF [dB/m]	Factor [dB]	Level [dBµV/m]	Limit [dBµV/m]	Margin [dB]	Polarity
1	2389.7333	40.73	26.99	-23.57	44.15	54.00	9.85	Vertical
2	2487.16	31.45	27.26	-23.54	35.17	54.00	18.83	Vertical



Unless otherwise agreed in writing, this document is issued by the Company subject to its General Conditions of Service printed overleaf, available on request or accessible at <http://www.sgs.com/en/Terms-and-Conditions.aspx> and, for electronic format documents, subject to Terms and Conditions for Electronic Documents at <http://www.sgs.com/en/Terms-and-Conditions/Terms-e-Documents.aspx>. Attention is drawn to the limitation of liability, indemnification and jurisdiction issues defined therein. Any holder of this document is advised that information contained hereon reflects the Company's findings at the time of its intervention only and within the limits of Client's instructions, if any. The Company's sole responsibility is to its Client and this document does not exonerate parties to a transaction from exercising all their rights and obligations under the transaction documents. This document cannot be reproduced except in full, without prior written approval of the Company. Any unauthorized alteration, forgery or falsification of the content or appearance of this document is unlawful and offenders may be prosecuted to the fullest extent of the law. Unless otherwise stated the results shown in this test report refer only to the sample(s) tested and such sample(s) are retained for 30 days only.

Attention: To check the authenticity of testing/inspection report & certificate, please contact us at telephone: (86-755) 8307 1443, or email: [CN.Doccheck@sgs.com](mailto:CN.Doccheck@sgs.com)

South of No. 6 Plant, No. 1, Runsheng Road, Suzhou Industrial Park, Suzhou Area, China (Jiangsu) Pilot Free Trade Zone 215000 t (86-512) 62992980 www.sgs.com.cn  
 中国·苏州·中国(江苏)自由贸易试验区苏州片区苏州工业园区润胜路1号的6号厂房南楼 邮编: 215000 t (86-512) 62992980 sgs.china@sgs.com

802.11n40\_Channel 03

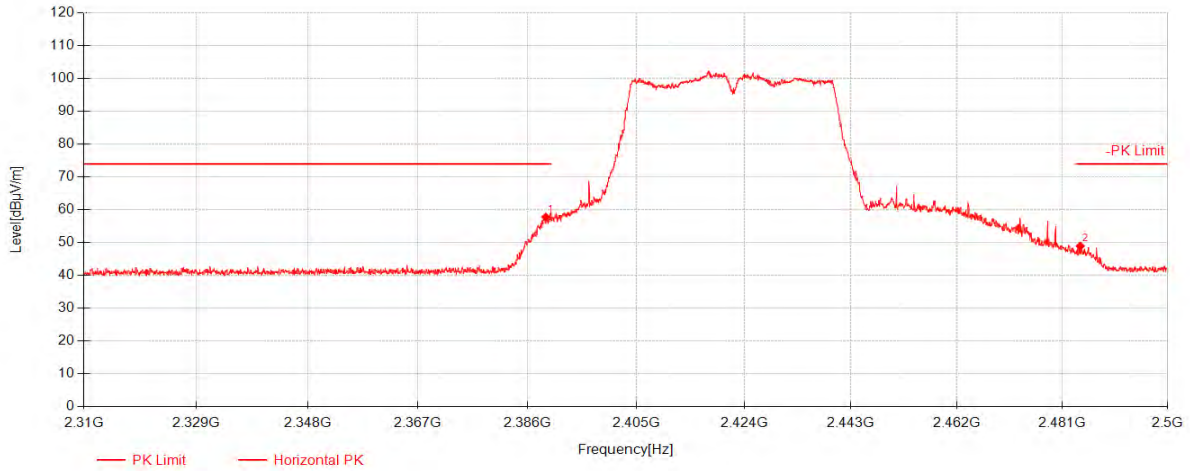

Data List								
NO.	Frequency [MHz]	Reading [dBµV]	AF [dB/m]	Factor [dB]	Level [dBµV/m]	Limit [dBµV/m]	Margin [dB]	Polarity
1	2389.17	54.35	26.99	-23.57	57.77	74.00	16.23	Horizontal
2	2484.22	45.22	27.26	-23.54	48.93	74.00	25.07	Horizontal



Unless otherwise agreed in writing, this document is issued by the Company subject to its General Conditions of Service printed overleaf, available on request or accessible at <http://www.sgs.com/en/Terms-and-Conditions.aspx> and, for electronic format documents, subject to Terms and Conditions for Electronic Documents at <http://www.sgs.com/en/Terms-and-Conditions/Terms-e-Documents.aspx>. Attention is drawn to the limitation of liability, indemnification and jurisdiction issues defined therein. Any holder of this document is advised that information contained hereon reflects the Company's findings at the time of its intervention only and within the limits of Client's instructions, if any. The Company's sole responsibility is to its Client and this document does not exonerate parties to a transaction from exercising all their rights and obligations under the transaction documents. This document cannot be reproduced except in full, without prior written approval of the Company. Any unauthorized alteration, forgery or falsification of the content or appearance of this document is unlawful and offenders may be prosecuted to the fullest extent of the law. Unless otherwise stated the results shown in this test report refer only to the sample(s) tested and such sample(s) are retained for 30 days only.

Attention: To check the authenticity of testing/inspection report & certificate, please contact us at telephone: (86-755) 8307 1443, or email: [CN.Doccheck@sgs.com](mailto:CN.Doccheck@sgs.com)

South of No. 6 Plant, No. 1, Runsheng Road, Suzhou Industrial Park, Suzhou Area, China (Jiangsu) Pilot Free Trade Zone 215000 t (86-512) 62992980 www.sgsgroup.com.cn  
 中国·苏州·中国(江苏)自由贸易试验区苏州片区苏州工业园区润胜路1号的6号厂房南楼 邮编: 215000 t (86-512) 62992980 sgs.china@sgs.com

802.11n40\_Channel 03

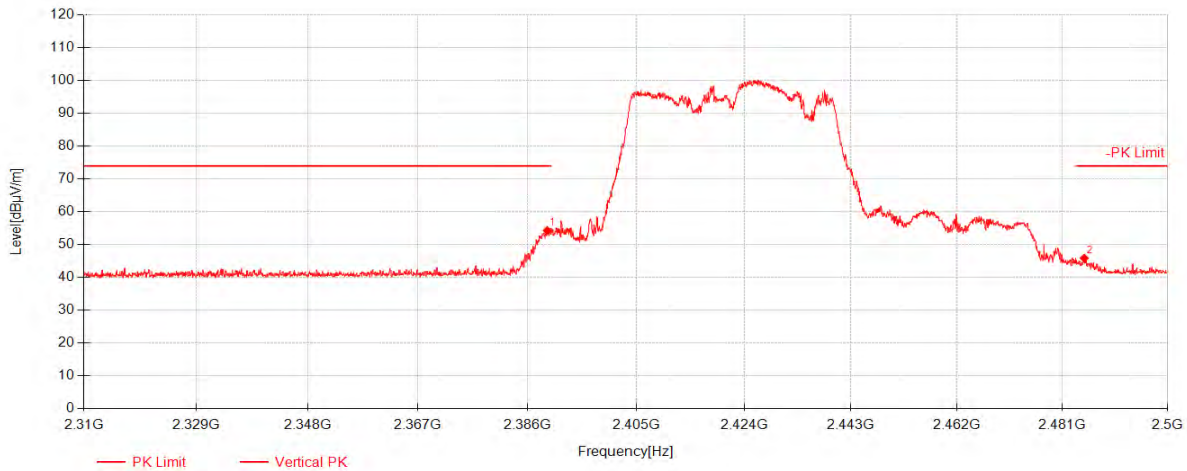

Data List								
NO.	Frequency [MHz]	Reading [dBµV]	AF [dB/m]	Factor [dB]	Level [dBµV/m]	Limit [dBµV/m]	Margin [dB]	Polarity
1	2389.43	50.88	26.99	-23.57	54.30	74.00	19.70	Vertical
2	2484.94	42.14	27.26	-23.54	45.85	74.00	28.15	Vertical

Remark:

- The field strength is calculated by adding the Antenna Factor, Cable Factor & Preamplifier gain. The basic equation with a sample calculation is as follows:  
 $Level = Reading(dB\mu V) + AF(dB/m) + Factor(dB)$   
 $AF = Antenna\ Factor(dB/m)$   
 $Factor = Cable\ Factor(dB) - Preamplifier\ gain(dB)$   
 $Margin = Limit(dB\mu V/m) - Level(dB\mu V/m)$
- Both peak and average measured complies with the limit line, so test result is "PASS"
- For WLAN SISO & CDD/MIMO mode for 802.11b/g/n mode, the whole testing has assessed only CDD/MIMO mode by referring to their higher output power.

---End of Report---

