

Antenna Performance Description

Applicant: Xiaomi Communications Co., Ltd

Product description: Mobile Phone

Model Name: 23122PCD1G

FCC ID: 2AFZZPCD1G

自静 2437

Antenna	Model Name	Antenna Pattern	Antenna Type	Manufacturer	Test party of Antenna gain
ANT10/11	AL HZH5.9	Metal Frame	IFA Antenna	<p>Huizhou Winone Precision Technology Co.,Ltd. (Address: xinwanda Industrial Park, Dongpo Avenue, Yuanzhou Town, BOLUO County)</p> <p>Guilin Lingyi Manufacturing Co., Ltd. Yangshiba Road, Yangtang Industrial (Address: Park, Guilin Economic Development Zone, Guilin City, Guangxi Zhuang Autonomous Region, China)</p>	<p>BeiJing Innowave Communication Technology Co.,Ltd</p> <p>Luxshare Precision Industry Co., Ltd</p>
ANT8/12	AL HZH5.9	Metal Frame	IFA Antenna	<p>Huizhou Winone Precision Technology Co.,Ltd. (Address: xinwanda Industrial Park, Dongpo Avenue, Yuanzhou Town, BOLUO County)</p> <p>Guilin Lingyi Manufacturing Co., Ltd. Yangshiba Road, Yangtang Industrial</p>	<p>BeiJing Innowave Communication Technology Co.,Ltd</p> <p>Luxshare Precision Industry Co., Ltd</p>

				(Address:Park,Guilin Economic Development Zone,Guilin City,Guangxi Zhuang Autonomous Region,China)	
NFC (38.5mm×24mm×0.2mm)	FPC antenna	N/A	Coil Antenna	Kunshan Innowave Communication Technology Co., Ltd. (Building H, Jintudi Manufacturing Park, No. 55 Shengchuang Road, Yushan Town, Kunshan City, Suzhou City, Jiangsu Province) Shanghai Deman Electronic Technology Co., Ltd. (Plant 3, No. 1259, Pingan Road, Zhuanqiao Town, Minhang District, Shanghai)	N/A

Test instrument:GTS2800

Software version

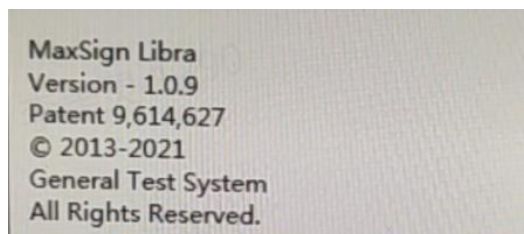

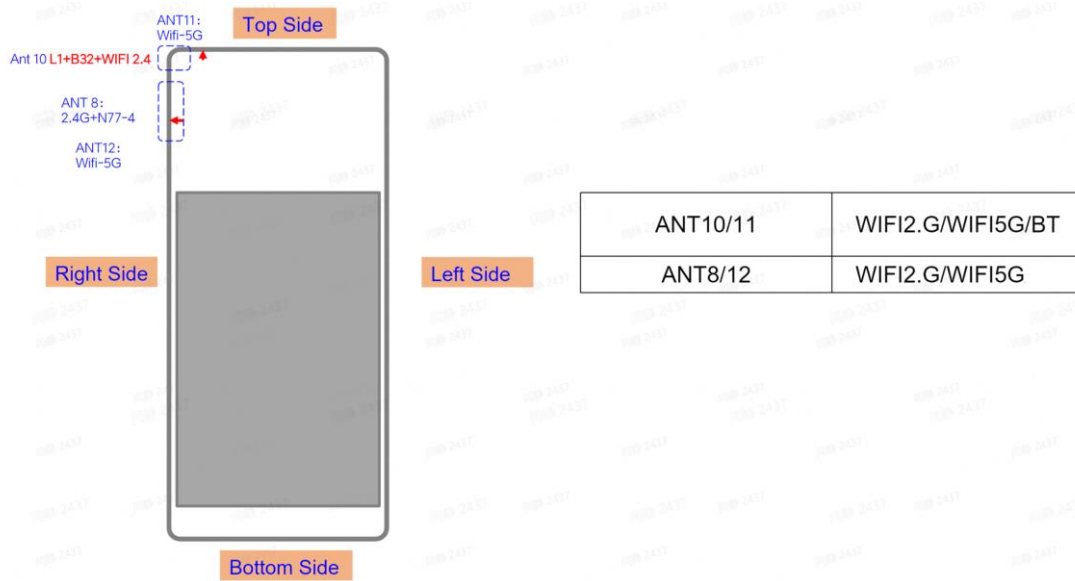

ANT10/11:

Band	ant10&ant11	
	Effi.(dBi)	peak gain(dBi)
2.4G	-6.6	-3.1
5G (5.15-5.25GHZ)	-5.8	-2
5G (5.25-5.35GHZ)	-5.7	-1.4
5G (5.47-5.725GHZ)	-5.5	-1.5
5G (5.725-5.85GHZ)	-5.8	-1.6

S11:

2.4G

E5071C Network Analyzer

1 Active Ch/Trace 2 Response 3 Stimulus 4 Mkr/Analysis 5 Instr State

Tr1 S11 Log Mag 5.000dB/ Ref 0.000dB [F2]
▶ Tr2 S11 Smith (R+jX) Scale 1.000U [F2 off]

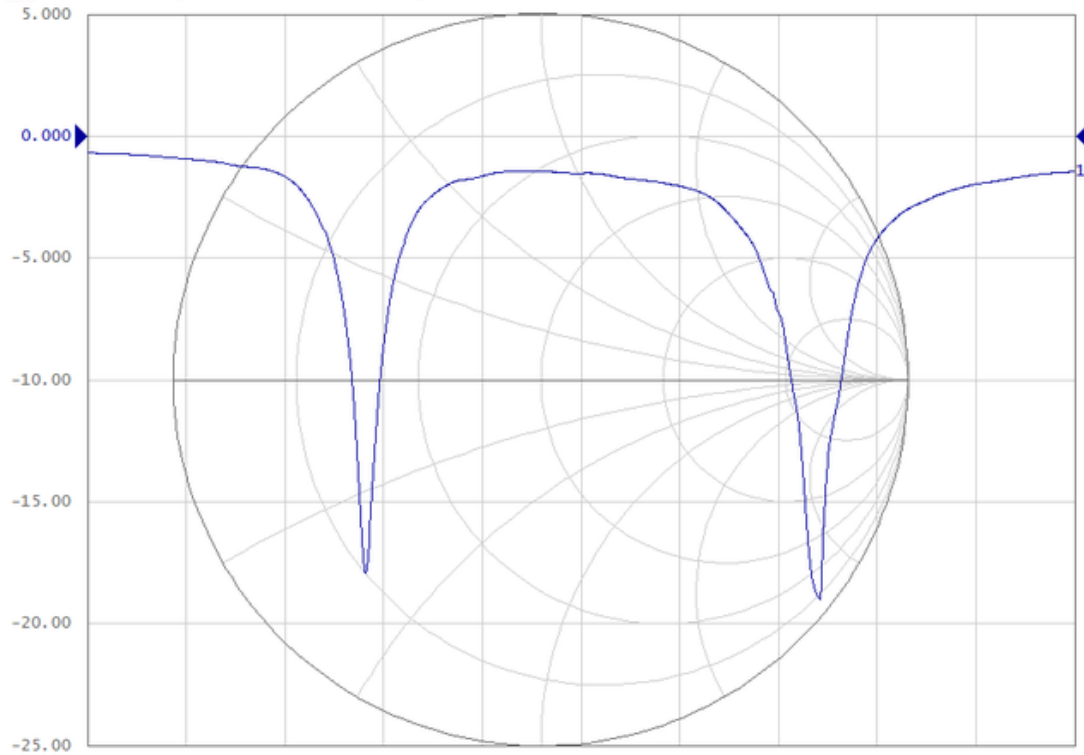

1 Start 1 GHz

IFBW 70 kHz

Stop 3 GHz PEExt C7 I

E5071C Network Analyzer

1 Active Ch/Trace 2 Response 3 Stimulus 4 Mkr/Analysis 5 Instr State

▶ Tr2 S11 Smith (R+jX) scale 1.000U [F2]

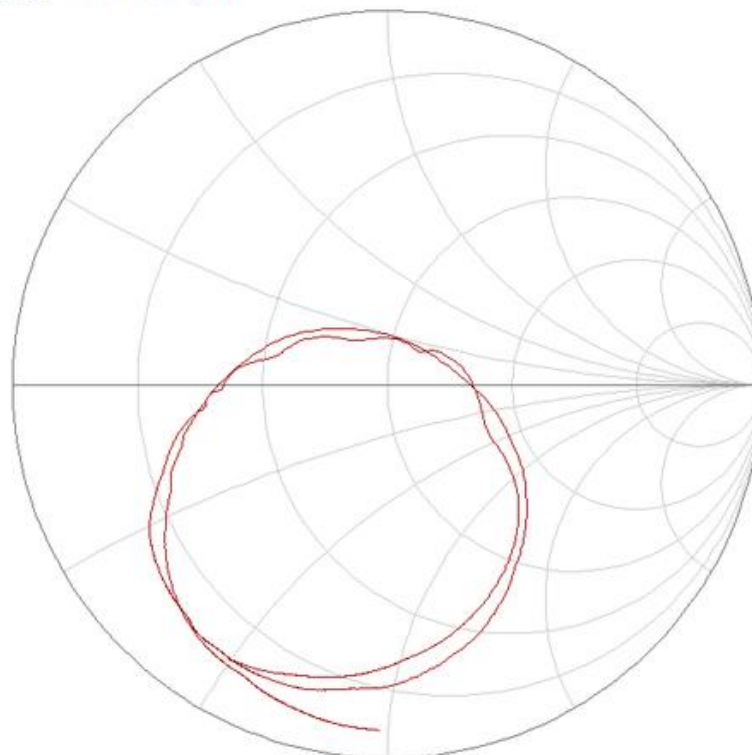

1 Start 1 GHz

IFBW 70 kHz

Stop 3 GHz PEExt C7 I

5G

E5071C Network Analyzer

1 Active Ch/Trace 2 Response 3 Stimulus 4 Mkr/Analysis 5 Instr State

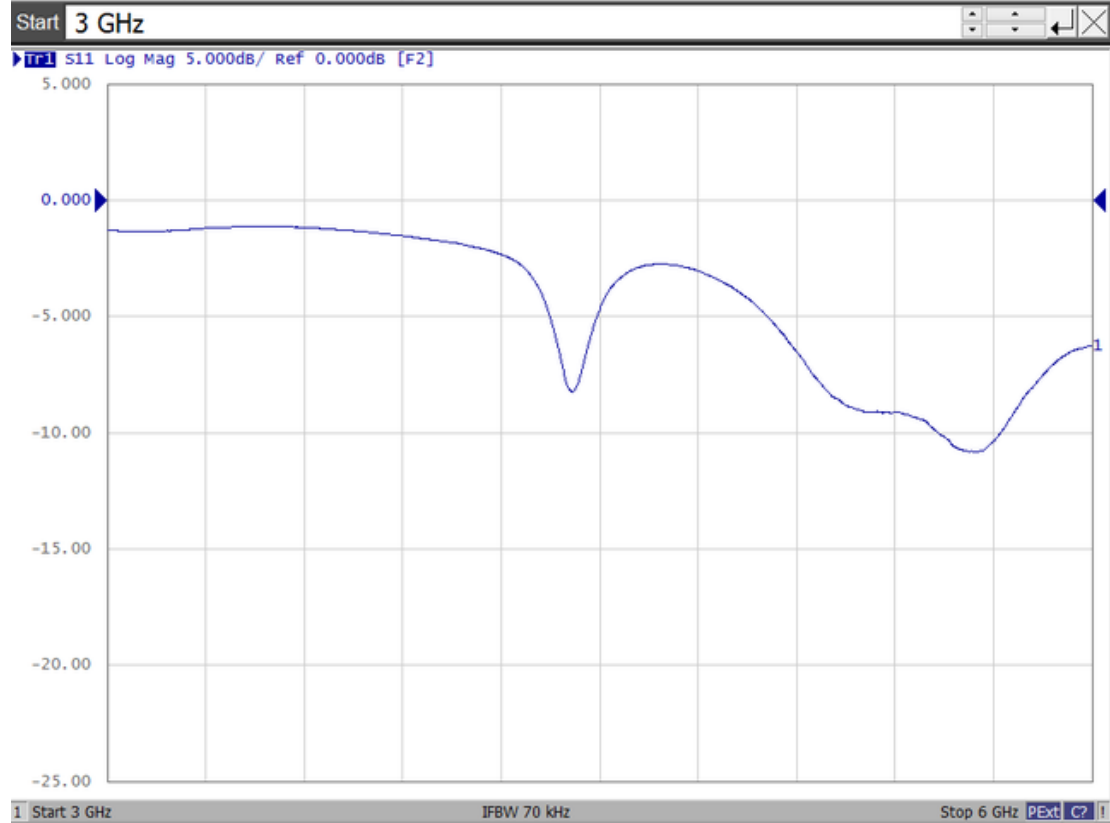

E5071C Network Analyzer

1 Active Ch/Trace 2 Response 3 Stimulus 4 Mkr/Analysis 5 Instr State

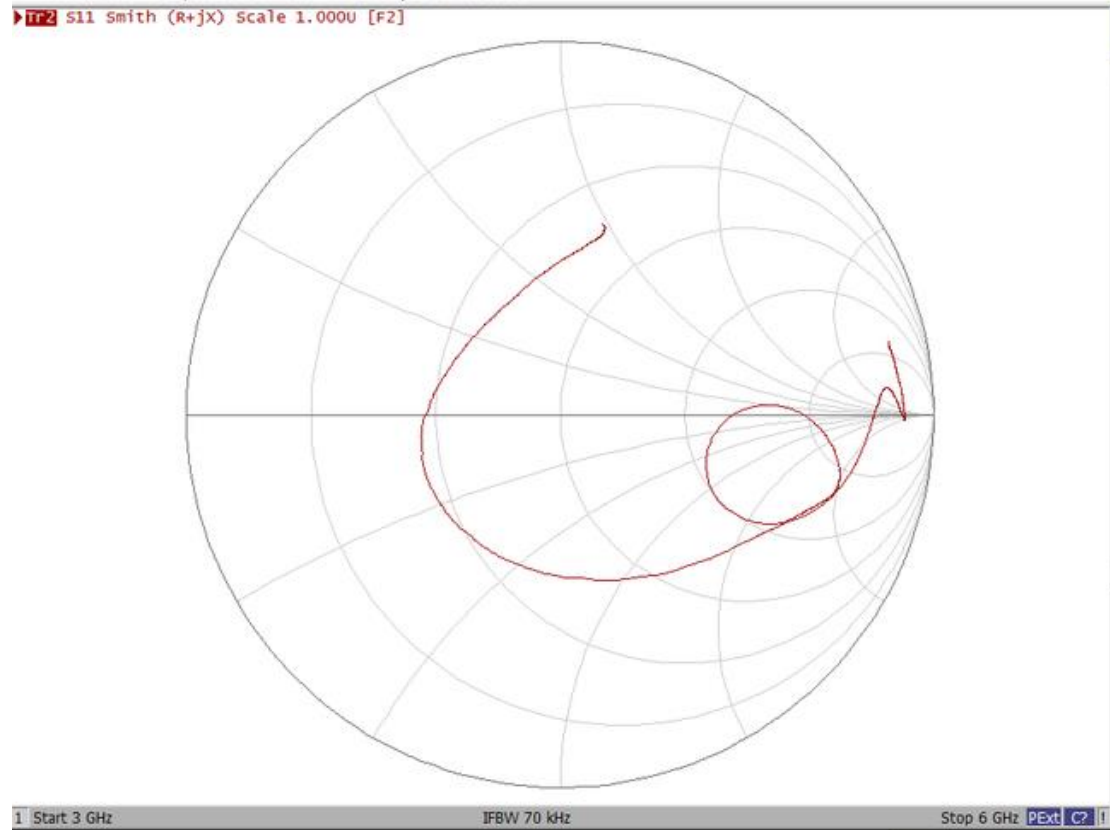

2460:

Theta

Azimuth:0
Elevation:0
Roll:0

Zoom Scale

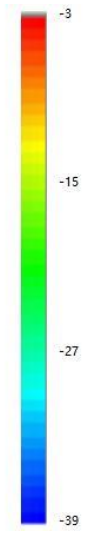
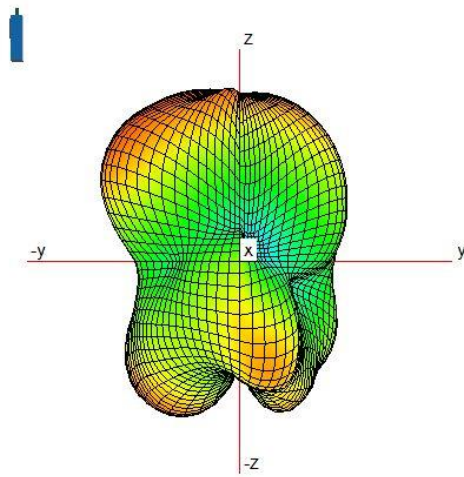
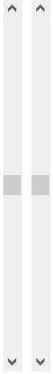

Phi

Azimuth:87
Elevation:5
Roll:1

Zoom Scale

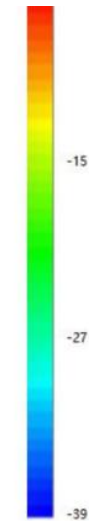
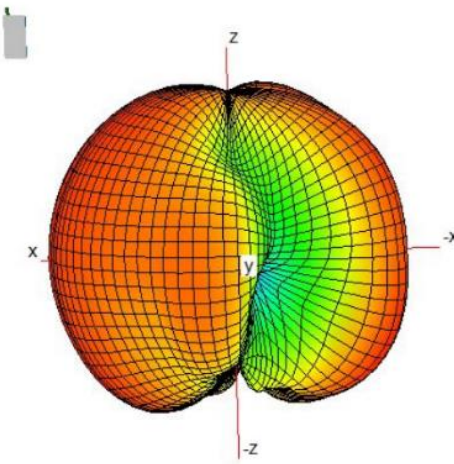

Total

Azimuth: 66
Elevation: 86
Roll: 156

Zoom Scale

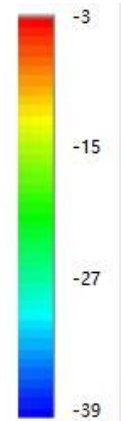
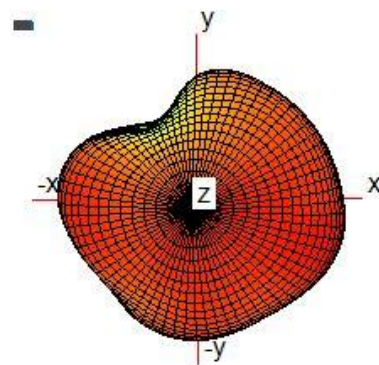

5240:

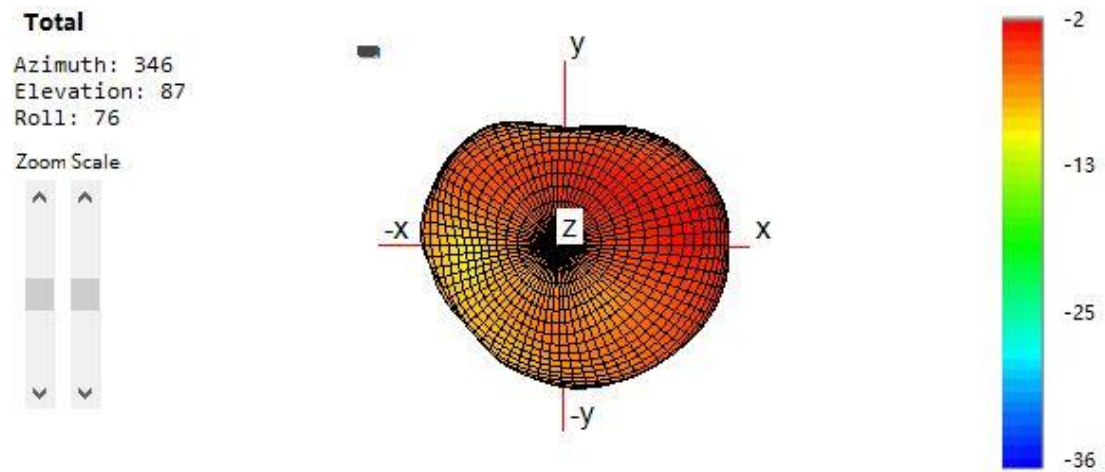
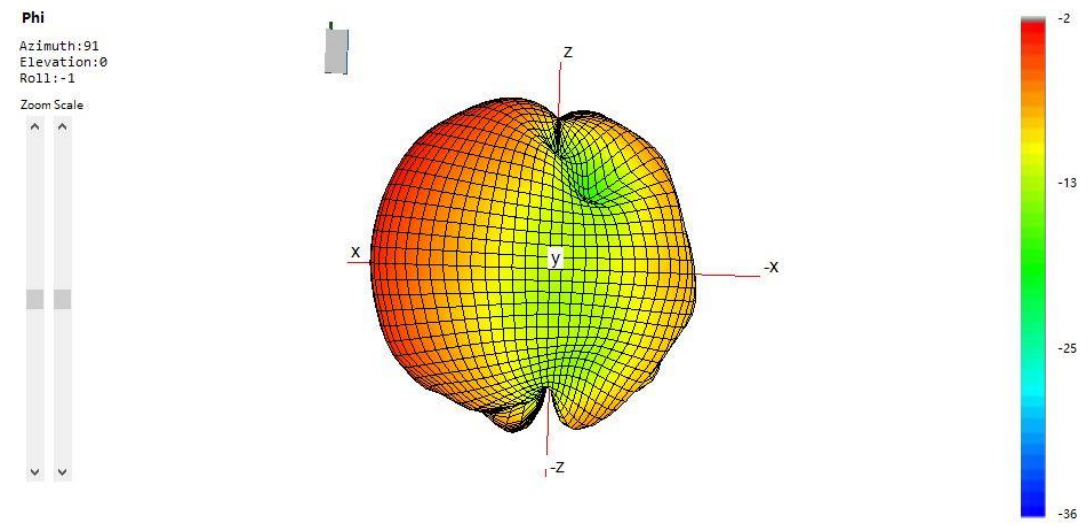
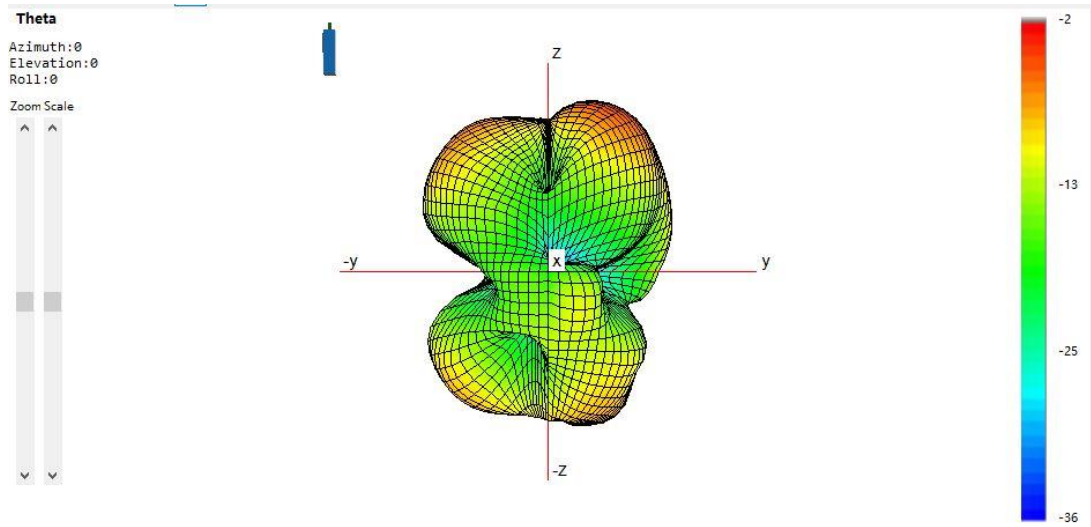

5340:

Theta

Azimuth: 0
Elevation: 0
Roll: 0

Zoom Scale

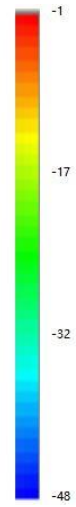
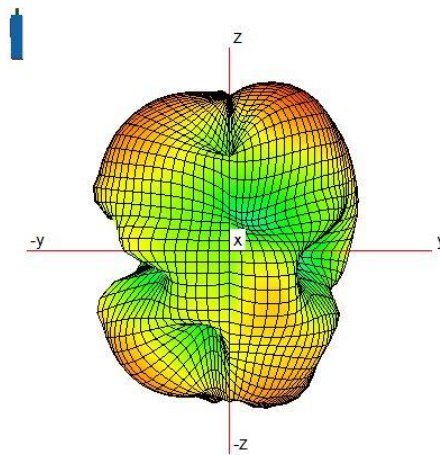

Phi

Azimuth: 91
Elevation: 0
Roll: -1

Zoom Scale

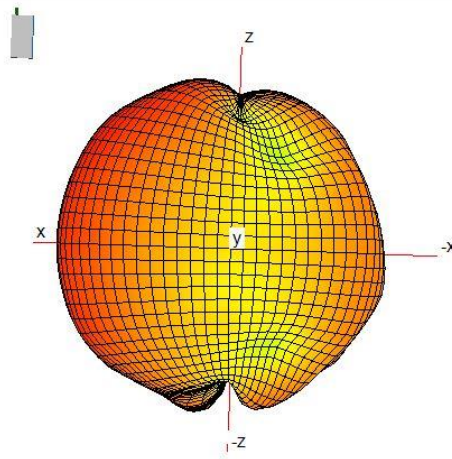

Total

Azimuth: 346
Elevation: 87
Roll: 76

Zoom Scale

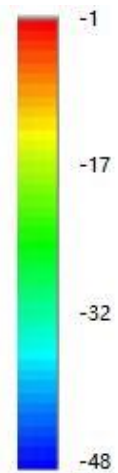
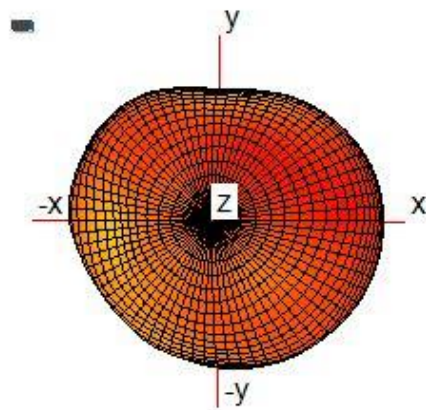

5580:

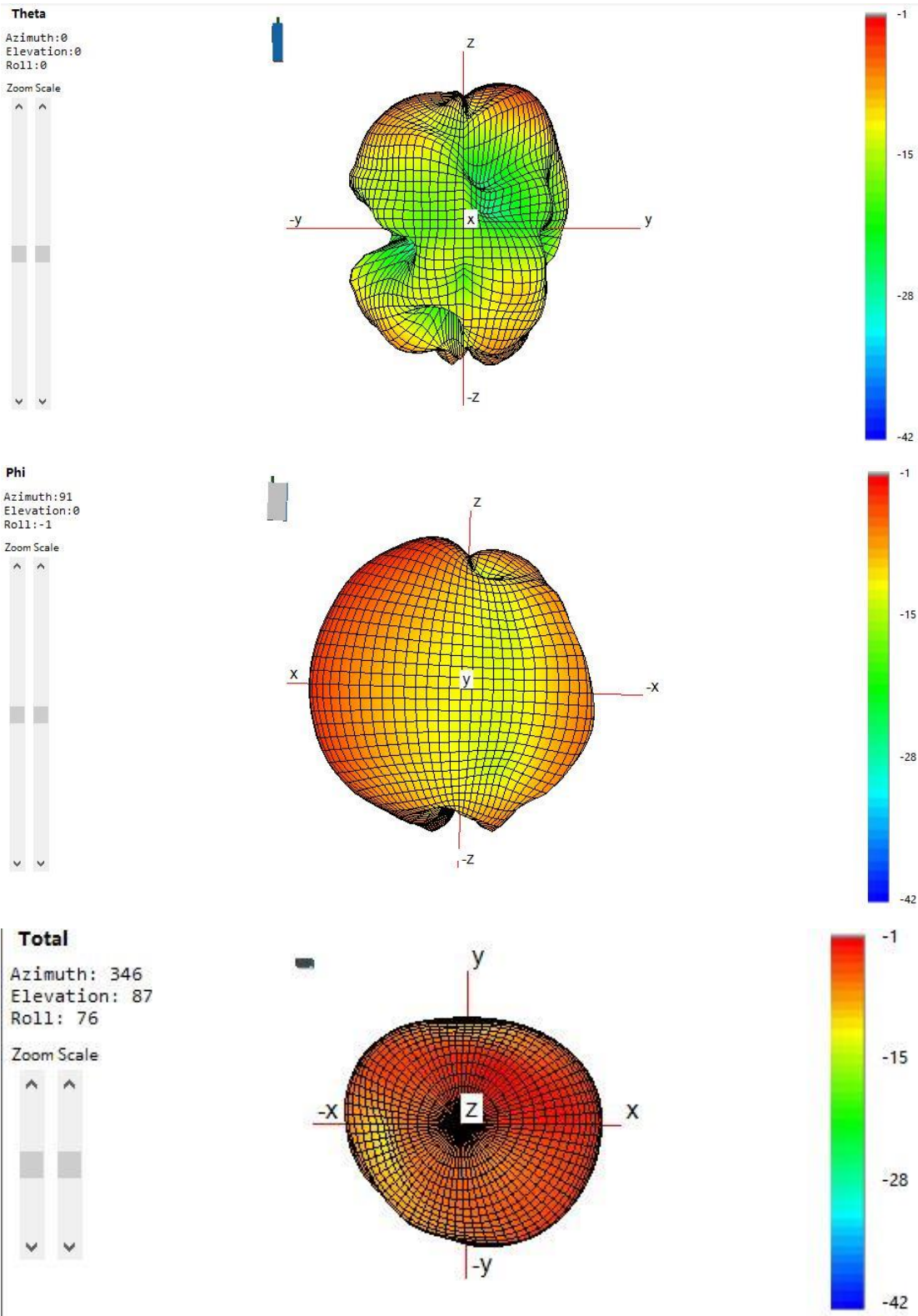

5840:

Theta

Azimuth: 0
Elevation: 0
Roll: 0

Zoom Scale

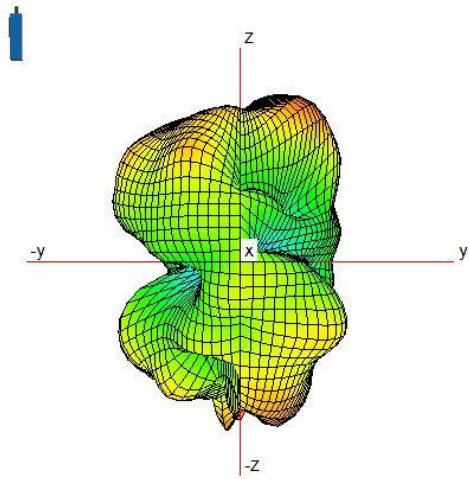

Phi

Azimuth: 91
Elevation: 0
Roll: -1

Zoom Scale

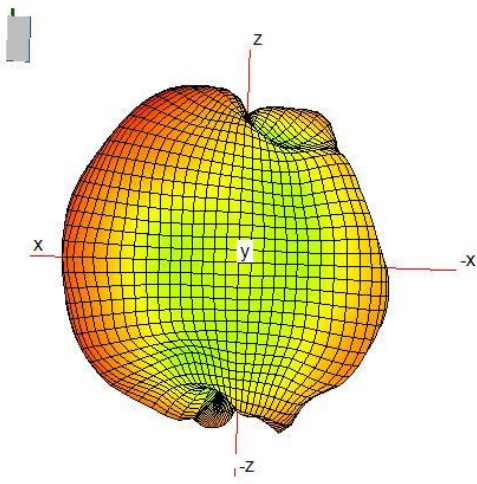

Total

Azimuth: 346
Elevation: 87
Roll: 76

Zoom Scale

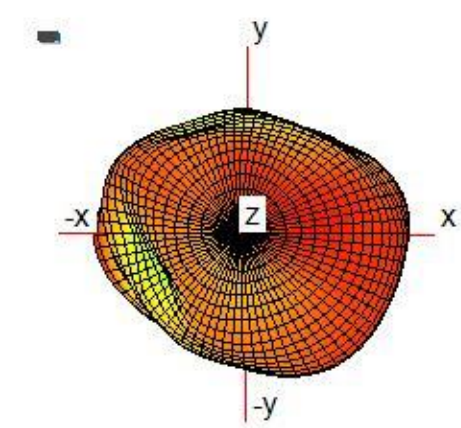

ANT8/12:

Band	ant 8/12	
	Effi.(dBi)	peak gain(dBi)
2.4G	-4	1.53
5G (5.15-5.25GHZ)	-6.5	-2.2
5G (5.25-5.35GHZ)	-6.4	-1.3
5G (5.47-5.725GHZ)	-5	-0.6
5G (5.725-5.85GHZ)	-5.6	-0.2

S11

2.4G

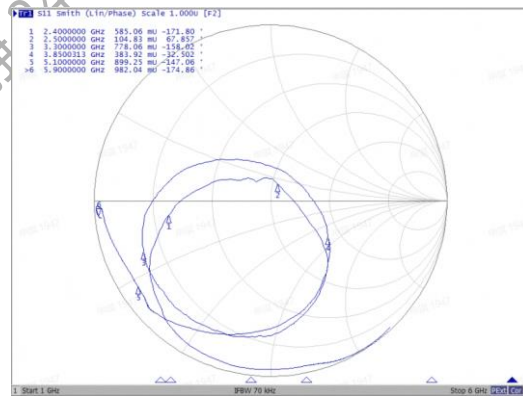

5G

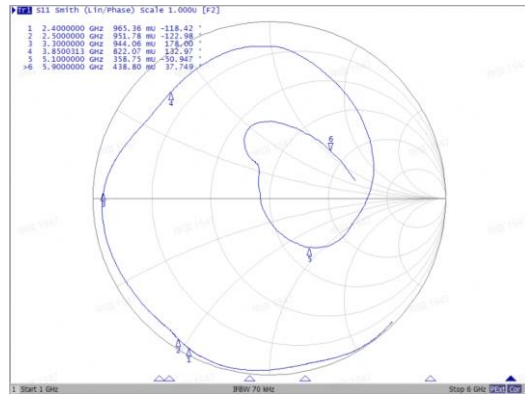

2460:

Theta

Azimuth:0
Elevation:0
Roll:0

Zoom Scale

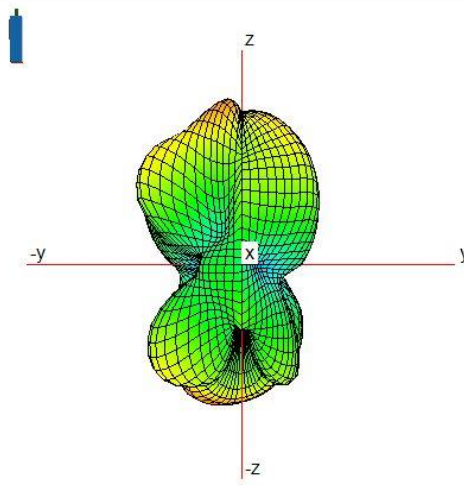

Phi

Azimuth:88
Elevation:0
Roll:0

Zoom Scale

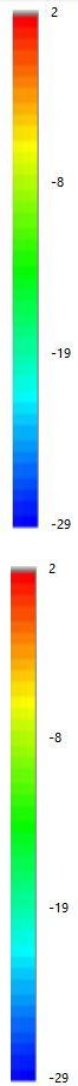
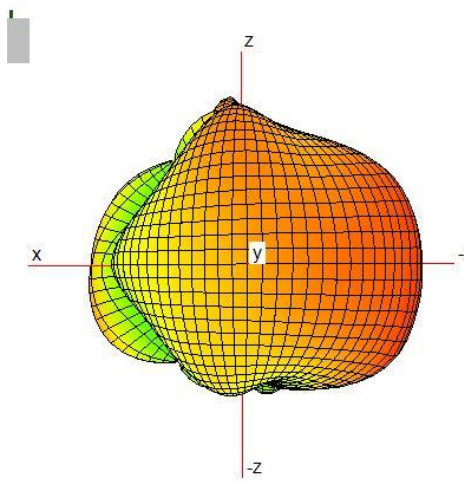

Total

Azimuth: 354
Elevation: 86
Roll: 83

Zoom Scale

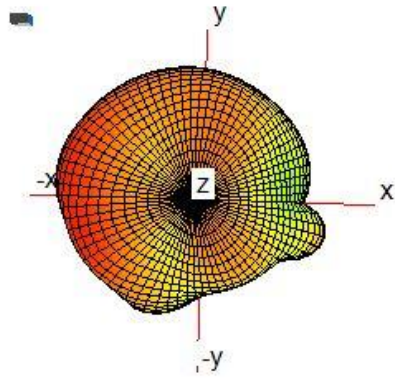

5200

Total

Azimuth: 0
Elevation: 0
Roll: 0

Zoom Scale

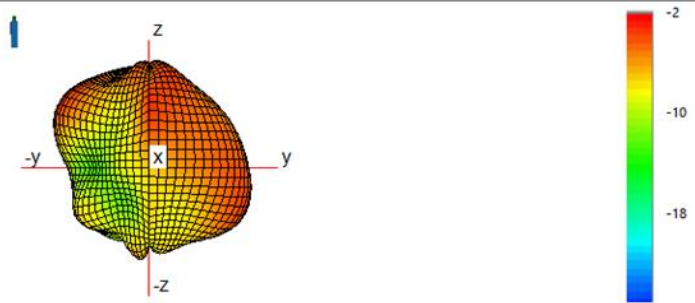

Total

Azimuth: 90
Elevation: 0
Roll: 0

Zoom Scale

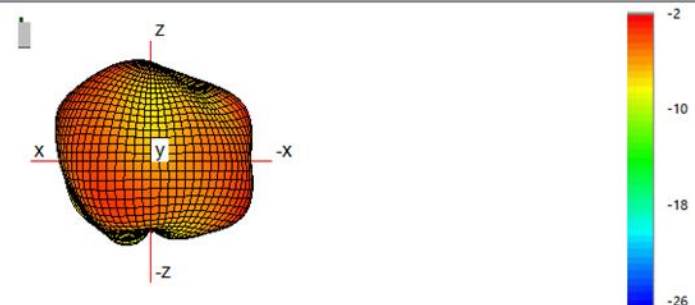

Total

Azimuth: 180
Elevation: 90
Roll: 90

Zoom Scale

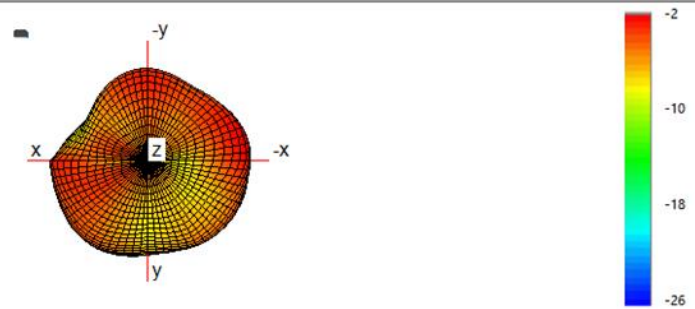
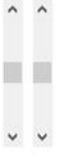

5340

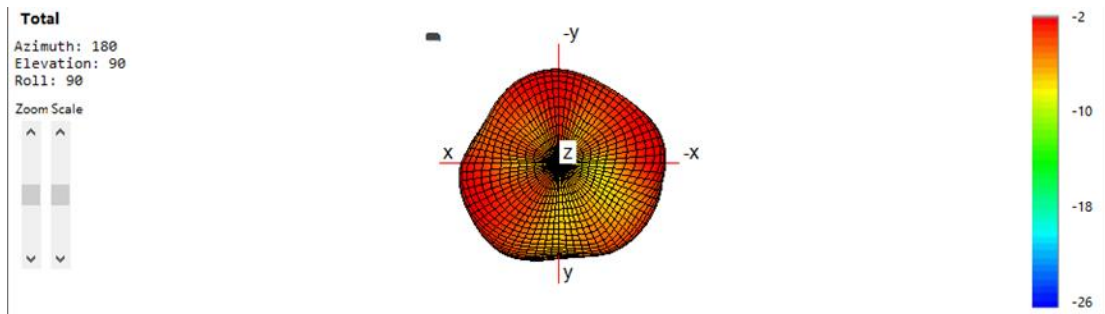
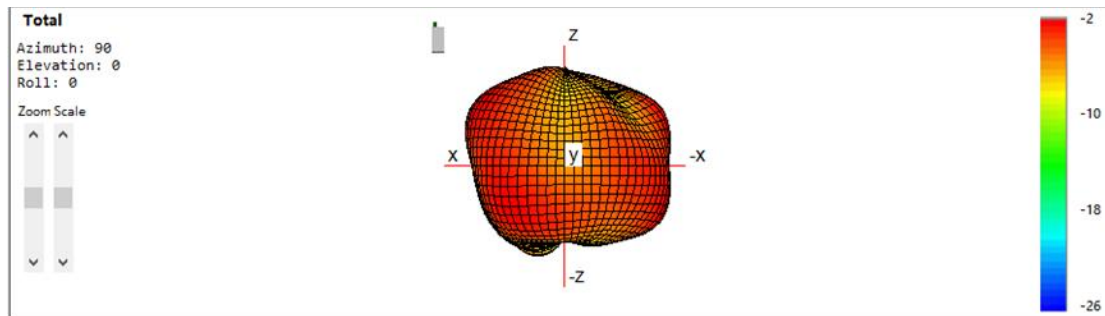
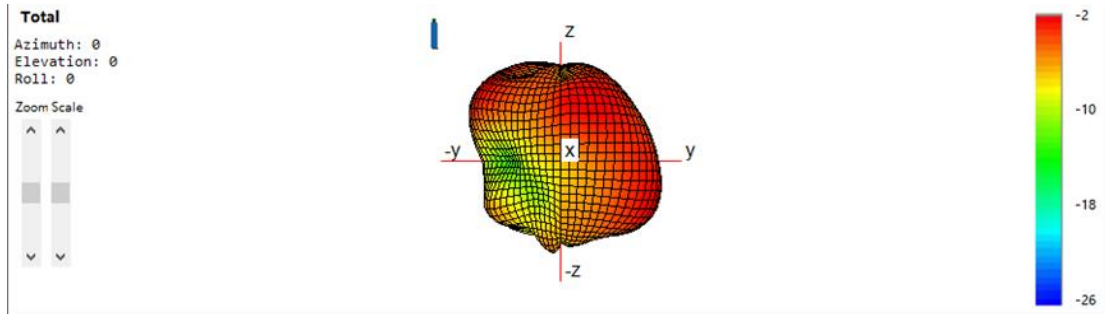

5600

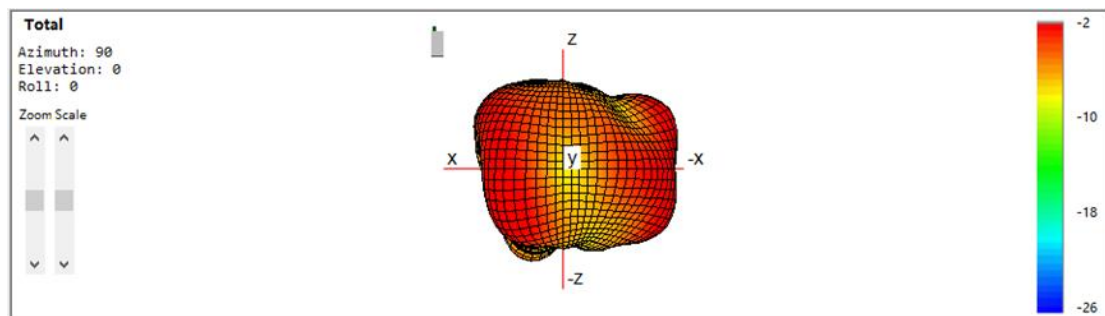
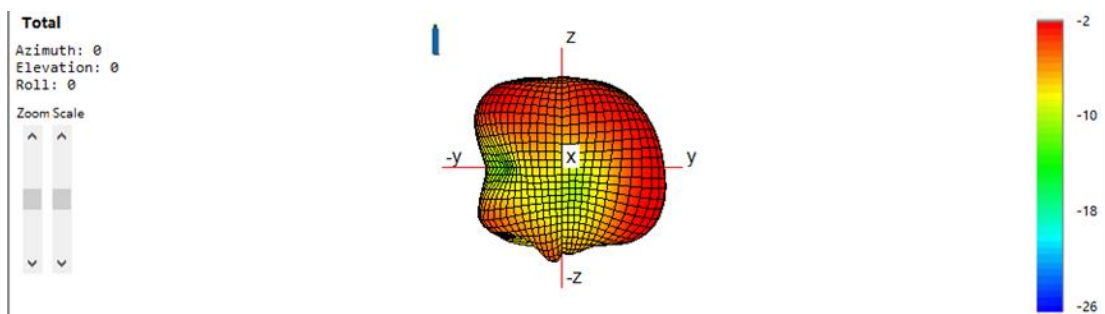

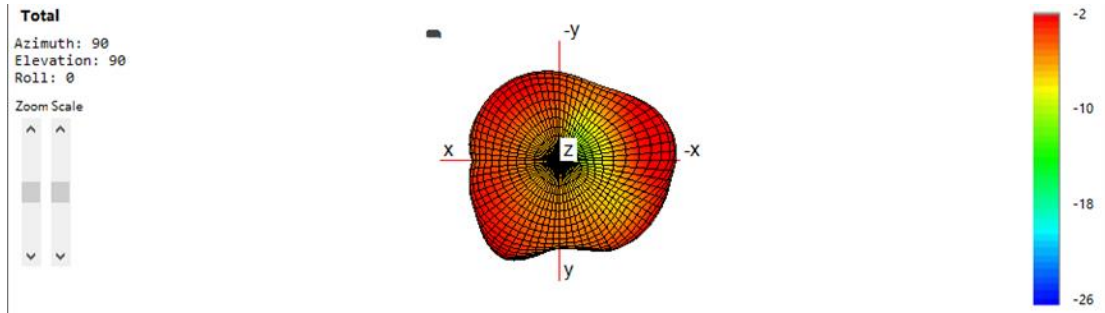

5740

