

Table of Contents

Release Control Record	3
1. Summary of Maximum SAR Value	4
2. Description of Equipment Under Test	5
3. SAR Measurement System	7
3.1 Definition of Specific Absorption Rate (SAR)	7
3.2 SPEAG DASY System	7
4.2.1 Robot.....	8
4.2.2 Probes.....	9
4.2.3 Data Acquisition Electronics (DAE)	10
4.2.4 Phantoms	10
4.2.5 Device Holder.....	11
4.2.6 System Validation Dipoles	11
4.2.7 Tissue Simulating Liquids.....	12
3.3 SAR System Verification	14
3.4 SAR Measurement Procedure	15
3.4.1 Area & Zoom Scan Procedure	15
3.4.2 Volume Scan Procedure.....	15
3.4.3 Power Drift Monitoring.....	16
3.4.4 Spatial Peak SAR Evaluation	16
3.4.5 SAR Averaged Methods	16
4. SAR Measurement Evaluation.....	17
4.1 EUT Configuration and Setting.....	17
4.2 EUT Testing Position	32
4.2.1 Head Exposure Conditions.....	32
4.2.2 Body-worn Accessory Exposure Conditions.....	34
4.2.3 Hotspot Mode Exposure Conditions	35
4.2.4 Extremity Exposure Conditions	36
4.2.5 Simultaneous Transmission Possibilities	36
4.2.6 SAR Text Exclusion Evaluations.....	37
4.3 Tissue Verification	38
4.4 System Verification.....	38
4.5 Maximum Output Power.....	39
4.5.1 Maximum Conducted Power	39
4.5.2 Measured Conducted Power Result.....	39
4.6 SAR Testing Results	39
4.6.1 SAR Test Reduction Considerations	39
4.6.2 SAR Results for Head Exposure Condition	41
4.6.3 SAR Results for Body-worn Exposure Condition (Separation Distance is 1.0 cm Gap).....	44
4.6.4 SAR Results for Hotspot Exposure Condition (Separation Distance is 1.0 cm Gap).....	46
4.6.5 SAR Results for Extremity Exposure Condition (Separation Distance is 0 cm Gap).....	51
4.6.6 SAR Measurement Variability.....	53
4.6.7 Simultaneous Multi-band Transmission Evaluation	53
5. Calibration of Test Equipment.....	64
6. Measurement Uncertainty	65
7. Information on the Testing Laboratories	67

Appendix A. SAR Plots of System Verification	
Appendix B. SAR Plots of SAR Measurement	
Appendix C. Calibration Certificate for Probe and Dipole	
Appendix D. Conducted RF Output Power Table	
Appendix E. Photographs of EUT and Setup	



1. Summary of Maximum SAR Value

Equipment Class	Mode	Highest Reported Head SAR _{1g} (W/kg)	Highest Reported Body-worn SAR _{1g} (1.0 cm Gap) (W/kg)	Highest Reported Hotspot SAR _{1g} (1.0 cm Gap) (W/kg)	Highest Reported Extremity SAR _{10g} (0 cm Gap) (W/kg)
PCE	GSM850	1.03	0.42	0.42	N/A
	GSM1900	0.89	0.82	0.82	1.59
	WCDMA II	0.99	1.06	1.06	2.37
	WCDMA IV	0.92	0.99	0.99	2.08
	WCDMA V	0.89	0.53	0.53	N/A
	LTE 2	0.63	1.08	1.08	2.54
	LTE 5	0.93	0.57	0.57	N/A
	LTE 7	0.73	1.08	1.08	2.12
	LTE 38	0.63	0.84	0.84	1.91
	LTE 41	0.79	0.97	0.97	1.83
	LTE 66 / 4	0.98	1.04	1.09	2.57
DTS	2.4G WLAN	0.44	0.20	0.20	N/A
NII	5.2G WLAN	N/A	N/A	0.20	N/A
	5.3G WLAN	0.42	0.30	N/A	0.27
	5.6G WLAN	0.15	0.29	N/A	0.17
	5.8G WLAN	0.11	0.09	0.09	N/A
DSS	Bluetooth	0.25	0.08	0.08	N/A
DXX	NFC	N/A	N/A	N/A	N/A
Highest Simultaneous Transmission SAR		Head (W/kg)	Body-worn (W/kg)	Hotspot (W/kg)	Extremity (W/kg)
		1.26	1.35	1.39	2.57

Note:

- The SAR limit (Head & Body: SAR_{1g} 1.6 W/kg, Extremity: SAR_{10g} 4.0 W/kg) for general population / uncontrolled exposure is specified in FCC 47 CFR part 2 (2.1093) and ANSI/IEEE C95.1-1992.

2. Description of Equipment Under Test

EUT Type	Mobile Phone
FCC ID	2AFZZPCC5G
Brand Name	POCO
Model Name	2410FPCC5G
Sample 1 IMEI Code	IMEI 1: 864624070035441 IMEI 2: 864624070035458
Sample 2 IMEI Code	IMEI 1: 864624070036746 IMEI 2: 864624070036753
Sample 3 IMEI Code	IMEI 1: 864624070021144 IMEI 2: 864624070021151
Sample 4 IMEI Code	IMEI 1: 864624070036969 IMEI 2: 864624070036977
HW Version	135100C3N
SW Version	Xiaomi HyperOS 1.0
Tx Frequency Bands (Unit: MHz)	GSM850 : 824 ~ 849 GSM1900 : 1850 ~ 1910 WCDMA Band II : 1850 ~ 1910 WCDMA Band IV : 1710 ~ 1755 WCDMA Band V : 824 ~ 849 LTE Band 2 : 1850 ~ 1910 LTE Band 4 : 1710 ~ 1755 LTE Band 5 : 824 ~ 849 LTE Band 7 : 2500 ~ 2570 LTE Band 38 : 2570 ~ 2620 LTE Band 41 : 2496 ~ 2690 LTE Band 66 : 1710 ~ 1780 WLAN : 2412 ~ 2462, 5180 ~ 5240, 5260 ~ 5320, 5500 ~ 5700, 5745 ~ 5825 Bluetooth : 2402 ~ 2480
Uplink Modulations	GSM & GPRS & EDGE : GMSK, 8PSK WCDMA : QPSK LTE : QPSK, 16QAM, 64QAM 802.11b : DSSS 802.11a/g/n/ac : OFDM Bluetooth : GFSK, $\pi/4$ -DQPSK, 8-DPSK NFC : ASK
Maximum Tune-up Conducted Power (Unit: dBm)	Please refer to section 4.5.1 of this report.
Antenna Type	WWAN: PIFA Antenna WLAN/BT: PIFA Antenna
EUT Stage	Identical Prototype

Note:

1. The above EUT information is declared by manufacturer and for more detailed features description please refers to the manufacturer's specifications or User's Manual.
2. This device supports both LTE Band 4 and LTE Band 66. Since the supported frequency span for LTE Band 4 falls completely within the LTE Band 66, they have the same target power, and share the same transmission path, therefore SAR was only assessed for LTE Band 66.
3. The difference between sample 1/2/3/4 is only the memory size and screen supplier, battery supplier, so sample 2/3/4 verifies the worst case of sample 1.
4. For WWAN Antenna, when the audio is actively routed through the earpiece receiver on head exposure condition, power reduction will be activated to limit the maximum power.
5. For WWAN Antenna, when the SAR sensor is detected close to the body sate, power reduction will be activated to limit the maximum power. Proximity sensor triggering distances please refer to section 4.1 of this report.

WWAN Ant 1(MAIN) scenarios:

Power State	SAR Test Scenarios	Receiver	SAR Sensor
Full Power	N/A	Off	Off
DSI-1	Head	On	Off
DSI-2	Body-Worn / Hotspot / Extremity	Off	Off
DSI-3/DSI-4	Body-Worn / Hotspot / Extremity	Off	On

WWAN Ant 4(DIV) scenarios:

Power State	SAR Test Scenarios	Receiver	SAR Sensor
Full Power	N/A	Off	Off
DSI-1	Head	On	Off
DSI-2	Body-Worn / Hotspot / Extremity	Off	Off
DSI-4	Body-Worn / Hotspot / Extremity	Off	On

WLAN Ant 2 scenarios:

Power State	SAR Test Scenarios	Receiver
Full Power	N/A	Off
DSI-1	Head	On
DSI-2	Body-Worn / Hotspot / Extremity	Off

3. SAR Measurement System

3.1 Definition of Specific Absorption Rate (SAR)

SAR is related to the rate at which energy is absorbed per unit mass in an object exposed to a radio field. The SAR distribution in a biological body is complicated and is usually carried out by experimental techniques or numerical modeling. The standard recommends limits for two tiers of groups, occupational/controlled and general population/uncontrolled, based on a person's awareness and ability to exercise control over his or her exposure. In general, occupational/controlled exposure limits are higher than the limits for general population/uncontrolled.

The SAR definition is the time derivative (rate) of the incremental energy (dW) absorbed by (dissipated in) an incremental mass (dm) contained in a volume element (dv) of a given density (ρ). The equation description is as below:

$$\text{SAR} = \frac{d}{dt} \left(\frac{dW}{dm} \right) = \frac{d}{dt} \left(\frac{dW}{\rho dv} \right)$$

SAR is expressed in units of Watts per kilogram (W/kg)

SAR measurement can be related to the electrical field in the tissue by

$$\text{SAR} = \frac{\sigma |E|^2}{\rho}$$

Where: σ is the conductivity of the tissue, ρ is the mass density of the tissue and E is the RMS electrical field strength.

3.2 SPEAG DASY System

DASY system consists of high precision robot, probe alignment sensor, phantom, robot controller, controlled measurement server and near-field probe. The robot includes six axes that can move to the precision position of the DASY5 software defined. The DASY software can define the area that is detected by the probe. The robot is connected to controlled box. Controlled measurement server is connected to the controlled robot box. The DAE includes amplifier, signal multiplexing, AD converter, offset measurement and surface detection. It is connected to the Electro-optical coupler (ECO). The ECO performs the conversion from the optical into digital electric signal of the DAE and transfers data to the PC.

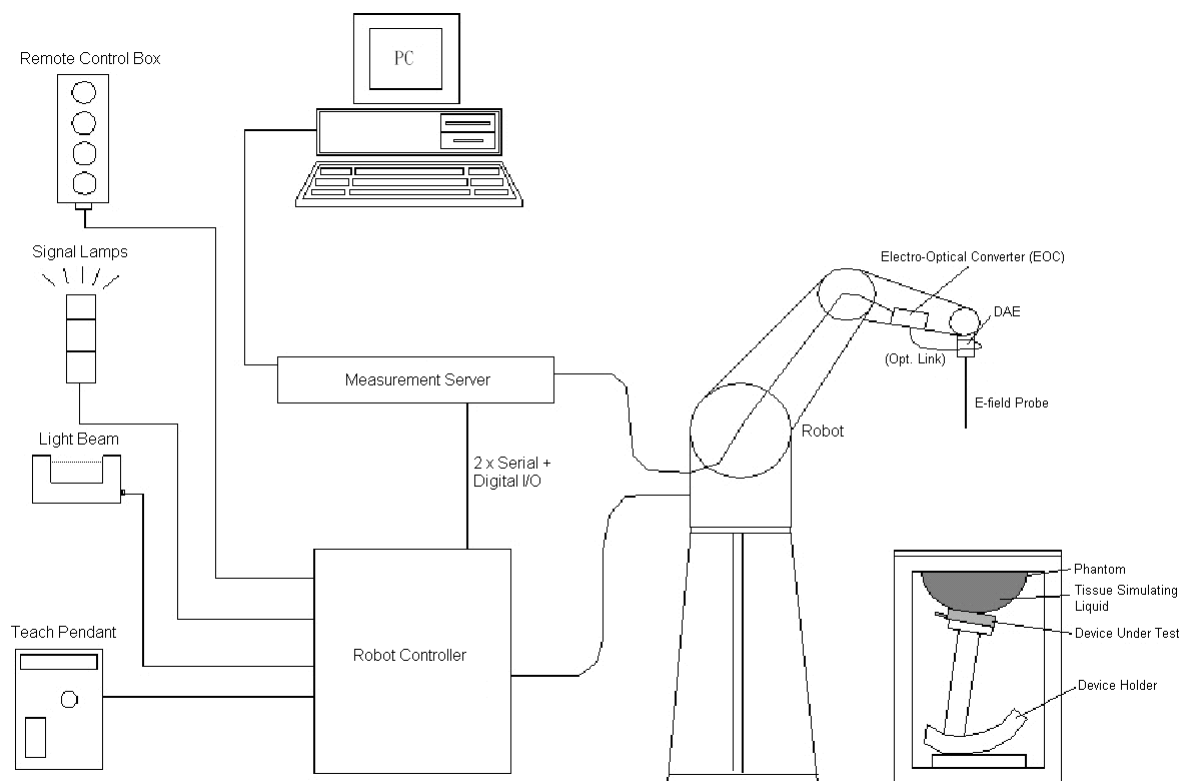

Fig-3.1 DASY System Setup

4.2.1 Robot

The DASY system uses the high precision robots from Stäubli SA (France). For the 6-axis controller system, the robot controller version (DASY5: CS8c) from Stäubli is used. The Stäubli robot series have many features that are important for our application:

- High precision (repeatability ± 0.035 mm)
- High reliability (industrial design)
- Jerk-free straight movements
- Low ELF interference (the closed metallic construction shields against motor control fields)



Fig-3.2 DASY6

4.2.2 Probes

The SAR measurement is conducted with the dosimetric probe. The probe is specially designed and calibrated for use in liquid with high permittivity. The dosimetric probe has special calibration in liquid at different frequency.

Model	EX3DV4	
Construction	Symmetrical design with triangular core. Built-in shielding against static charges. PEEK enclosure material (resistant to organic solvents, e.g., DGBE).	
Frequency	10 MHz to 6 GHz Linearity: ± 0.2 dB	
Directivity	± 0.3 dB in HSL (rotation around probe axis) ± 0.5 dB in tissue material (rotation normal to probe axis)	
Dynamic Range	10 μ W/g to 100 mW/g Linearity: ± 0.2 dB (noise: typically < 1 μ W/g)	
Dimensions	Overall length: 337 mm (Tip: 20 mm) Tip diameter: 2.5 mm (Body: 12 mm) Typical distance from probe tip to dipole centers: 1 mm	

Model	ES3DV3	
Construction	Symmetrical design with triangular core. Interleaved sensors. Built-in shielding against static charges. PEEK enclosure material (resistant to organic solvents, e.g., DGBE).	
Frequency	10 MHz to 4 GHz Linearity: ± 0.2 dB	
Directivity	± 0.2 dB in HSL (rotation around probe axis) ± 0.3 dB in tissue material (rotation normal to probe axis)	
Dynamic Range	5 μ W/g to 100 mW/g Linearity: ± 0.2 dB	
Dimensions	Overall length: 337 mm (Tip: 20 mm) Tip diameter: 3.9 mm (Body: 12 mm) Distance from probe tip to dipole centers: 2.0 mm	

4.2.3 Data Acquisition Electronics (DAE)

Model	DAE3, DAE4	
Construction	Signal amplifier, multiplexer, A/D converter and control logic. Serial optical link for communication with DASY embedded system (fully remote controlled). Two step probe touch detector for mechanical surface detection and emergency robot stop.	
Measurement Range	-100 to +300 mV (16 bit resolution and two range settings: 4mV, 400mV)	
Input Offset Voltage	< 5µV (with auto zero)	
Input Bias Current	< 50 fA	
Dimensions	60 x 60 x 68 mm	

4.2.4 Phantoms

Model	Twin SAM	
Construction	The shell corresponds to the specifications of the Specific Anthropomorphic Mannequin (SAM) phantom defined in IEEE 1528 and IEC 62209-1. It enables the dosimetric evaluation of left and right hand phone usage as well as body mounted usage at the flat phantom region. A cover prevents evaporation of the liquid. Reference markings on the phantom allow the complete setup of all predefined phantom positions and measurement grids by teaching three points with the robot.	
Material	Vinylester, glass fiber reinforced (VE-GF)	
Shell Thickness	2 ± 0.2 mm (6 ± 0.2 mm at ear point)	
Dimensions	Length: 1000 mm Width: 500 mm Height: adjustable feet	
Filling Volume	approx. 25 liters	

Model	ELI	
Construction	Phantom for compliance testing of handheld and body-mounted wireless devices in the frequency range of 30 MHz to 6 GHz. ELI is fully compatible with the IEC 62209-2 standard and all known tissue simulating liquids. ELI has been optimized regarding its performance and can be integrated into our standard phantom tables. A cover prevents evaporation of the liquid. Reference markings on the phantom allow installation of the complete setup, including all predefined phantom positions and measurement grids, by teaching three points. The phantom is compatible with all SPEAG dosimetric probes and dipoles.	
Material	Vinylester, glass fiber reinforced (VE-GF)	
Shell Thickness	2.0 ± 0.2 mm (bottom plate)	
Dimensions	Major axis: 600 mm Minor axis: 400 mm	
Filling Volume	approx. 30 liters	

4.2.5 Device Holder

Model	Mounting Device	
Construction	In combination with the Twin SAM Phantom or ELI4, the Mounting Device enables the rotation of the mounted transmitter device in spherical coordinates. Rotation point is the ear opening point. Transmitter devices can be easily and accurately positioned according to IEC, IEEE, FCC or other specifications. The device holder can be locked for positioning at different phantom sections (left head, right head, flat).	
Material	POM	

Model	Laptop Extensions Kit	
Construction	Simple but effective and easy-to-use extension for Mounting Device that facilitates the testing of larger devices according to IEC 62209-2 (e.g., laptops, cameras, etc.). It is lightweight and fits easily on the upper part of the Mounting Device in place of the phone positioner.	
Material	POM, Acrylic glass, Foam	

4.2.6 System Validation Dipoles

Model	D-Serial	
Construction	Symmetrical dipole with 1/4 balun. Enables measurement of feed point impedance with NWA. Matched for use near flat phantoms filled with tissue simulating solutions.	
Frequency	750 MHz to 5800 MHz	
Return Loss	> 20 dB	
Power Capability	> 100 W (f < 1GHz), > 40 W (f > 1GHz)	

4.2.7 Tissue Simulating Liquids

For SAR measurement of the field distribution inside the phantom, the phantom must be filled with homogeneous tissue simulating liquid to a depth of at least 15 cm. For head SAR testing, the liquid height from the ear reference point (ERP) of the phantom to the liquid top surface is larger than 15 cm. For body SAR testing, the liquid height from the center of the flat phantom to the liquid top surface is larger than 15 cm. The nominal dielectric values of the tissue simulating liquids in the phantom and the tolerance of 5% are listed in Table-3.1.

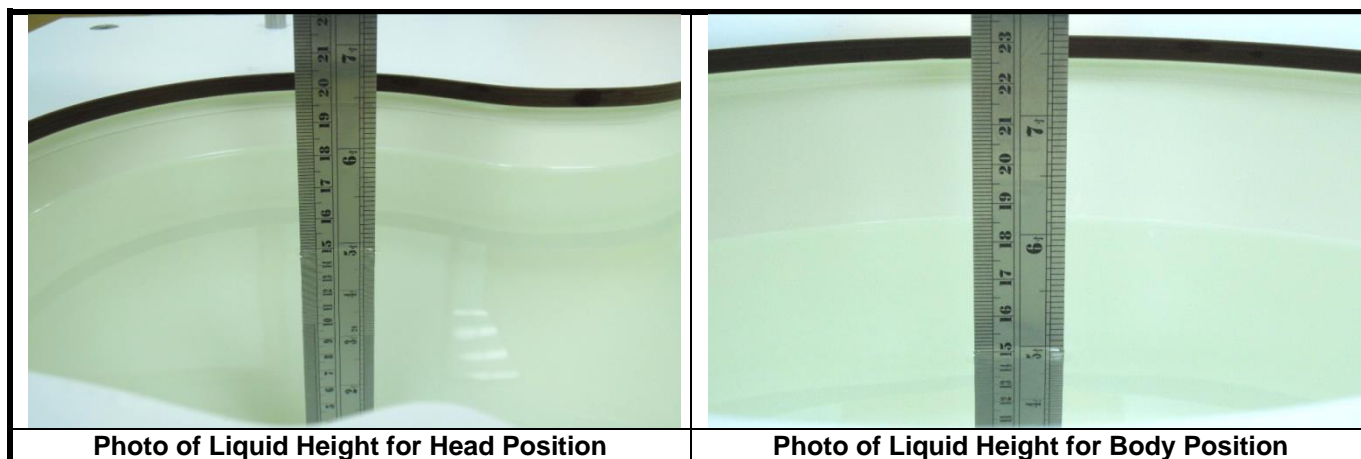

The dielectric properties of the head tissue simulating liquids are defined in IEEE 1528, and KDB 865664 D01 Appendix A. For the body tissue simulating liquids, the dielectric properties are defined in KDB 865664 D01 Appendix A. The dielectric properties of the tissue simulating liquids were verified prior to the SAR evaluation using a dielectric assessment kit and a network analyzer.

Table-3.1 Targets of Tissue Simulating Liquid

Frequency (MHz)	Target Permittivity	Range of $\pm 5\%$	Target Conductivity	Range of $\pm 5\%$
For Head				
750	41.9	39.8 ~ 44.0	0.89	0.85 ~ 0.93
835	41.5	39.4 ~ 43.6	0.90	0.86 ~ 0.95
900	41.5	39.4 ~ 43.6	0.97	0.92 ~ 1.02
1450	40.5	38.5 ~ 42.5	1.20	1.14 ~ 1.26
1640	40.3	38.3 ~ 42.3	1.29	1.23 ~ 1.35
1750	40.1	38.1 ~ 42.1	1.37	1.30 ~ 1.44
1800	40.0	38.0 ~ 42.0	1.40	1.33 ~ 1.47
1900	40.0	38.0 ~ 42.0	1.40	1.33 ~ 1.47
2000	40.0	38.0 ~ 42.0	1.40	1.33 ~ 1.47
2300	39.5	37.5 ~ 41.5	1.67	1.59 ~ 1.75
2450	39.2	37.2 ~ 41.2	1.80	1.71 ~ 1.89
2600	39.0	37.1 ~ 41.0	1.96	1.86 ~ 2.06
3500	37.9	36.0 ~ 39.8	2.91	2.76 ~ 3.06
5200	36.0	34.2 ~ 37.8	4.66	4.43 ~ 4.89
5300	35.9	34.1 ~ 37.7	4.76	4.52 ~ 5.00
5500	35.6	33.8 ~ 37.4	4.96	4.71 ~ 5.21
5600	35.5	33.7 ~ 37.3	5.07	4.82 ~ 5.32
5800	35.3	33.5 ~ 37.1	5.27	5.01 ~ 5.53



The following table gives the recipes for tissue simulating liquids.

Table-3.2 Recipes of Tissue Simulating Liquid

Tissue Type	Bactericide	DGBE	HEC	NaCl	Sucrose	Triton X-100	Water	Diethylene Glycol Mono-hexylether
H750	0.2	-	0.2	1.5	56.0	-	42.1	-
H835	0.2	-	0.2	1.5	57.0	-	41.1	-
H900	0.2	-	0.2	1.4	58.0	-	40.2	-
H1450	-	43.3	-	0.6	-	-	56.1	-
H1640	-	45.8	-	0.5	-	-	53.7	-
H1750	-	47.0	-	0.4	-	-	52.6	-
H1800	-	44.5	-	0.3	-	-	55.2	-
H1900	-	44.5	-	0.2	-	-	55.3	-
H2000	-	44.5	-	0.1	-	-	55.4	-
H2300	-	44.9	-	0.1	-	-	55.0	-
H2450	-	45.0	-	0.1	-	-	54.9	-
H2600	-	45.1	-	0.1	-	-	54.8	-
H3500	-	28.0	-	0.2	-	20.0	71.8	-
H5G	-	-	-	-	-	17.2	65.5	17.3

3.3 SAR System Verification

The system check verifies that the system operates within its specifications. It is performed daily or before every SAR measurement. The system check uses normal SAR measurements in the flat section of the phantom with a matched dipole at a specified distance. The system verification setup is shown as below.

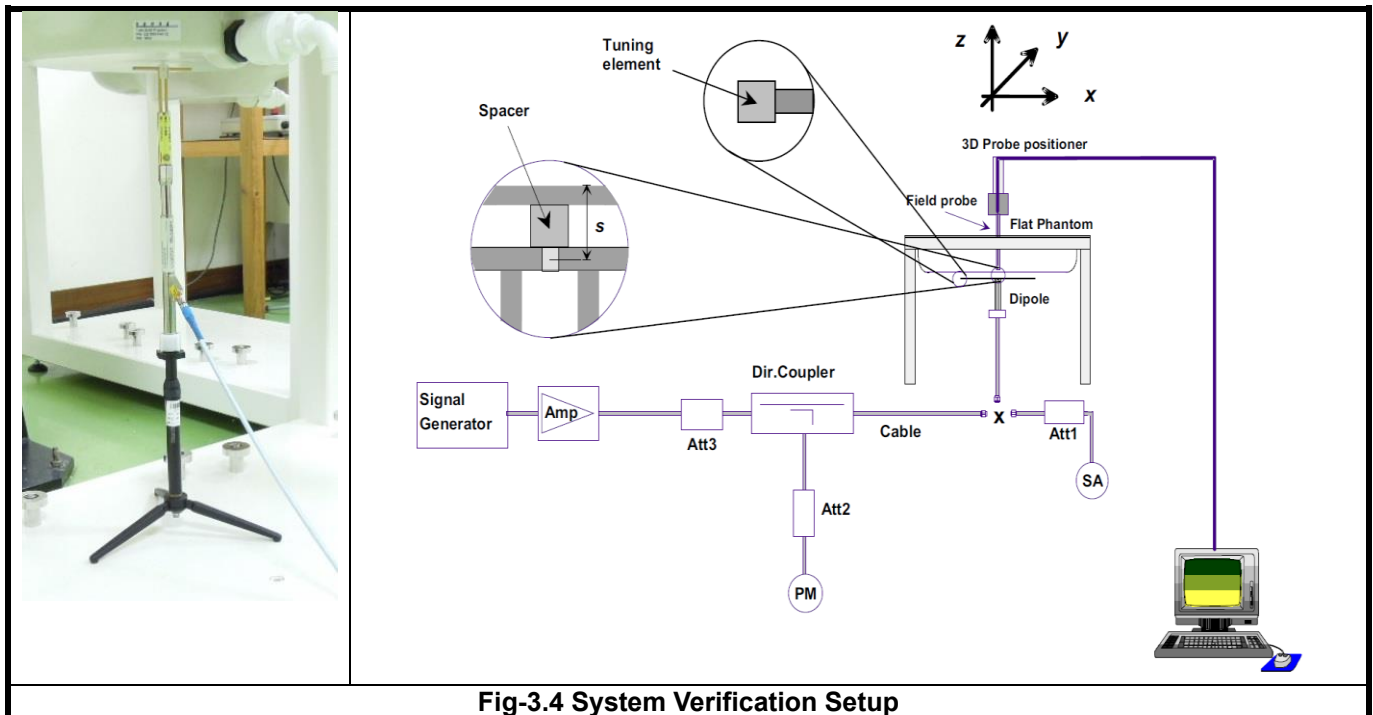

Fig-3.4 System Verification Setup

The validation dipole is placed beneath the flat phantom with the specific spacer in place. The distance spacer is touch the phantom surface with a light pressure at the reference marking and be oriented parallel to the long side of the phantom. The spectrum analyzer measures the forward power at the location of the system check dipole connector. The signal generator is adjusted for the desired forward power (250 mW is used for 700 MHz to 3 GHz, 100 mW is used for 3.5 GHz to 6 GHz) at the dipole connector and the power meter is read at that level. After connecting the cable to the dipole, the signal generator is readjusted for the same reading at power meter.

After system check testing, the SAR result will be normalized to 1W forward input power and compared with the reference SAR value derived from validation dipole certificate report. The deviation of system check should be within 10 %.

3.4 SAR Measurement Procedure

According to the SAR test standard, the recommended procedure for assessing the peak spatial-average SAR value consists of the following steps:

- (a) Power reference measurement
- (b) Area scan
- (c) Zoom scan
- (d) Power drift measurement

The SAR measurement procedures for each of test conditions are as follows:

- (a) Make EUT to transmit maximum output power
- (b) Measure conducted output power through RF cable
- (c) Place the EUT in the specific position of phantom
- (d) Perform SAR testing steps on the DASY system
- (e) Record the SAR value

3.4.1 Area & Zoom Scan Procedure

First Area Scan is used to locate the approximate location(s) of the local peak SAR value(s). The measurement grid within an Area Scan is defined by the grid extent, grid step size and grid offset. Next, in order to determine the EM field distribution in a three-dimensional spatial extension, Zoom Scan is required. The Zoom Scan is performed around the highest E-field value to determine the averaged SAR-distribution over 10 g. According to KDB 865664 D01, the resolution for Area and Zoom scan is specified in the table below.

Items	<= 2 GHz	2-3 GHz	3-4 GHz	4-5 GHz	5-6 GHz
Area Scan ($\Delta x, \Delta y$)	<= 15 mm	<= 12 mm	<= 12 mm	<= 10 mm	<= 10 mm
Zoom Scan ($\Delta x, \Delta y$)	<= 8 mm	<= 5 mm	<= 5 mm	<= 4 mm	<= 4 mm
Zoom Scan (Δz)	<= 5 mm	<= 5 mm	<= 4 mm	<= 3 mm	<= 2 mm
Zoom Scan Volume	>= 30 mm	>= 30 mm	>= 28 mm	>= 25 mm	>= 22 mm

Note:

When zoom scan is required and report SAR is <= 1.4 W/kg, the zoom scan resolution of $\Delta x / \Delta y$ (2-3GHz: <= 8 mm, 3-4GHz: <= 7 mm, 4-6GHz: <= 5 mm) may be applied.

3.4.2 Volume Scan Procedure

The volume scan is used for assess overlapping SAR distributions for antennas transmitting in different frequency bands. It is equivalent to an oversized zoom scan used in standalone measurements. The measurement volume will be used to enclose all the simultaneous transmitting antennas. For antennas transmitting simultaneously in different frequency bands, the volume scan is measured separately in each frequency band. In order to sum correctly to compute the 1g aggregate SAR, the EUT remain in the same test position for all measurements and all volume scan use the same spatial resolution and grid spacing. When all volume scan were completed, the software, SEMCAD postprocessor can combine and subsequently superpose these measurement data to calculating the multiband SAR.

3.4.3 Power Drift Monitoring

All SAR testing is under the EUT install full charged battery and transmit maximum output power. In DASY measurement software, the power reference measurement and power drift measurement procedures are used for monitoring the power drift of EUT during SAR test. Both these procedures measure the field at a specified reference position before and after the SAR testing. The software will calculate the field difference in dB. If the power drift more than 5%, the SAR will be retested.

3.4.4 Spatial Peak SAR Evaluation

The procedure for spatial peak SAR evaluation has been implemented according to the test standard. It can be conducted for 1g and 10g, as well as for user-specific masses. The DASY software includes all numerical procedures necessary to evaluate the spatial peak SAR value.

The base for the evaluation is a "cube" measurement. The measured volume must include the 1g and 10g cubes with the highest averaged SAR values. For that purpose, the center of the measured volume is aligned to the interpolated peak SAR value of a previously performed area scan.

The entire evaluation of the spatial peak values is performed within the post-processing engine (SEMCAD). The system always gives the maximum values for the 1g and 10g cubes. The algorithm to find the cube with highest averaged SAR is divided into the following stages:

- (a) Extraction of the measured data (grid and values) from the Zoom Scan
- (b) Calculation of the SAR value at every measurement point based on all stored data (A/D values and measurement parameters)
- (c) Generation of a high-resolution mesh within the measured volume
- (d) Interpolation of all measured values from the measurement grid to the high-resolution grid
- (e) Extrapolation of the entire 3-D field distribution to the phantom surface over the distance from sensor to surface
- (f) Calculation of the averaged SAR within masses of 1g and 10g

3.4.5 SAR Averaged Methods

In DASY, the interpolation and extrapolation are both based on the modified Quadratic Shepard's method. The interpolation scheme combines a least-square fitted function method and a weighted average method which are the two basic types of computational interpolation and approximation.

Extrapolation routines are used to obtain SAR values between the lowest measurement points and the inner phantom surface. The extrapolation distance is determined by the surface detection distance and the probe sensor offset. The uncertainty increases with the extrapolation distance. To keep the uncertainty within 1% for the 1 g and 10 g cubes, the extrapolation distance should not be larger than 5 mm.

4. SAR Measurement Evaluation

4.1 EUT Configuration and Setting

<Connections between EUT and System Simulator>

For WWAN SAR testing, the EUT was linked and controlled by base station emulator (Anritsu MT8821C is used for GSM/WCDMA/CDMA/LTE). Communication between the EUT and the emulator was established by air link. The distance between the EUT and the communicating antenna of the emulator is larger than 50 cm and the output power radiated from the emulator antenna is at least 30 dB smaller than the output power of EUT. The EUT was set from the emulator to radiate maximum output power during SAR testing.

< Proximity Sensor Triggering Distances >

The proximity sensor triggering distance was determined per KDB 616217 section 6.2, and EUT moving further away from the flat phantom and EUT moving toward the flat phantom were both assessed.

In the preliminary triggering distance testing, the tissue-equivalent medium for different frequency bands were used for verification; no other frequency bands tissue-equivalent medium was found to result in shortest triggering than that for 5700MHz, and the tissue-equivalent medium for 5700MHz was used for formal proximity sensor triggering testing.

Summary for power verification per distance was tabulated in the below table.

WWAN Ant-1

Output Power Verification in dBm for EUT Front Face (Moving toward phantom)											
Distance (mm)	8	9	10	11	12	13	14	15	16	17	18
WCDMA II Ch9538 (RMC 12.2K)	20.89	20.89	20.89	20.89	20.89	23.95	23.95	23.95	23.95	23.95	23.95
WCDMA IV Ch1413 (RMC 12.2K)	20.25	20.25	20.25	20.25	20.25	24.34	24.34	24.34	24.34	24.34	24.34
LTE 2 Ch18700 (QPSK20M_1RB_OS50)	20.58	20.58	20.58	20.58	20.58	23.5	23.5	23.5	23.5	23.5	23.5
LTE 7 Ch20850 (QPSK20M_1RB_OS50)	17.62	17.62	17.62	17.62	17.62	22.96	22.96	22.96	22.96	22.96	22.96
LTE 38 Ch38000 (QPSK20M_1RB_OS50)	18.87	18.87	18.87	18.87	18.87	24.03	24.03	24.03	24.03	24.03	24.03
LTE 41 Ch39750 (QPSK20M_1RB_OS50)	18.41	18.41	18.41	18.41	18.41	23.96	23.96	23.96	23.96	23.96	23.96
LTE 66 Ch132322 (QPSK20M_1RB_OS50)	21.18	21.18	21.18	21.18	21.18	24.26	24.26	24.26	24.26	24.26	24.26

Output Power Verification in dBm for EUT Front Face (Moving away phantom)											
Distance (mm)	8	9	10	11	12	13	14	15	16	17	18
WCDMA II Ch9538 (RMC 12.2K)	20.89	20.89	20.89	20.89	20.89	23.95	23.95	23.95	23.95	23.95	23.95
WCDMA IV Ch1413 (RMC 12.2K)	20.25	20.25	20.25	20.25	20.25	24.34	24.34	24.34	24.34	24.34	24.34
LTE 2 Ch18700 (QPSK20M_1RB_OS50)	20.58	20.58	20.58	20.58	20.58	23.5	23.5	23.5	23.5	23.5	23.5
LTE 7 Ch20850 (QPSK20M_1RB_OS50)	17.62	17.62	17.62	17.62	17.62	22.96	22.96	22.96	22.96	22.96	22.96
LTE 38 Ch38000 (QPSK20M_1RB_OS50)	18.87	18.87	18.87	18.87	18.87	24.03	24.03	24.03	24.03	24.03	24.03
LTE 41 Ch39750 (QPSK20M_1RB_OS50)	18.41	18.41	18.41	18.41	18.41	23.96	23.96	23.96	23.96	23.96	23.96
LTE 66 Ch132322 (QPSK20M_1RB_OS50)	21.18	21.18	21.18	21.18	21.18	24.26	24.26	24.26	24.26	24.26	24.26

Output Power Verification in dBm for EUT Rear Face (Moving toward phantom)											
Distance (mm)	14	15	16	17	18	19	20	21	22	23	24
WCDMA II Ch9538 (RMC 12.2K)	20.89	20.89	20.89	20.89	20.89	23.95	23.95	23.95	23.95	23.95	23.95
WCDMA IV Ch1413 (RMC 12.2K)	20.25	20.25	20.25	20.25	20.25	24.34	24.34	24.34	24.34	24.34	24.34
LTE 2 Ch18700 (QPSK20M_1RB_OS50)	20.58	20.58	20.58	20.58	20.58	23.5	23.5	23.5	23.5	23.5	23.5
LTE 7 Ch20850 (QPSK20M_1RB_OS50)	17.62	17.62	17.62	17.62	17.62	22.96	22.96	22.96	22.96	22.96	22.96
LTE 38 Ch38000 (QPSK20M_1RB_OS50)	18.87	18.87	18.87	18.87	18.87	24.03	24.03	24.03	24.03	24.03	24.03
LTE 41 Ch39750 (QPSK20M_1RB_OS50)	18.41	18.41	18.41	18.41	18.41	23.96	23.96	23.96	23.96	23.96	23.96
LTE 66 Ch132322 (QPSK20M_1RB_OS50)	21.18	21.18	21.18	21.18	21.18	24.26	24.26	24.26	24.26	24.26	24.26

Output Power Verification in dBm for EUT Rear Face (Moving away phantom)											
Distance (mm)	14	15	16	17	18	19	20	21	22	23	24
WCDMA II Ch9538 (RMC 12.2K)	20.89	20.89	20.89	20.89	20.89	23.95	23.95	23.95	23.95	23.95	23.95
WCDMA IV Ch1413 (RMC 12.2K)	20.25	20.25	20.25	20.25	20.25	24.34	24.34	24.34	24.34	24.34	24.34
LTE 2 Ch18700 (QPSK20M_1RB_OS50)	20.58	20.58	20.58	20.58	20.58	23.5	23.5	23.5	23.5	23.5	23.5
LTE 7 Ch20850 (QPSK20M_1RB_OS50)	17.62	17.62	17.62	17.62	17.62	22.96	22.96	22.96	22.96	22.96	22.96
LTE 38 Ch38000 (QPSK20M_1RB_OS50)	18.87	18.87	18.87	18.87	18.87	24.03	24.03	24.03	24.03	24.03	24.03
LTE 41 Ch39750 (QPSK20M_1RB_OS50)	18.41	18.41	18.41	18.41	18.41	23.96	23.96	23.96	23.96	23.96	23.96
LTE 66 Ch132322 (QPSK20M_1RB_OS50)	21.18	21.18	21.18	21.18	21.18	24.26	24.26	24.26	24.26	24.26	24.26



BUREAU
VERITAS

FCC SAR Test Report



Certificate #6613.01

Output Power Verification in dBm for EUT Bottom Side (Moving toward phantom)											
Distance (mm)	18	19	20	21	22	23	24	25	26	27	28
WCDMA II Ch9538 (RMC 12.2K)	20.89	20.89	20.89	20.89	20.89	23.95	23.95	23.95	23.95	23.95	23.95
WCDMA IV Ch1413 (RMC 12.2K)	20.25	20.25	20.25	20.25	20.25	24.34	24.34	24.34	24.34	24.34	24.34
LTE 2 Ch18700 (QPSK20M_1RB_OS50)	20.58	20.58	20.58	20.58	20.58	23.5	23.5	23.5	23.5	23.5	23.5
LTE 7 Ch20850 (QPSK20M_1RB_OS50)	17.62	17.62	17.62	17.62	17.62	22.96	22.96	22.96	22.96	22.96	22.96
LTE 38 Ch38000 (QPSK20M_1RB_OS50)	18.87	18.87	18.87	18.87	18.87	24.03	24.03	24.03	24.03	24.03	24.03
LTE 41 Ch39750 (QPSK20M_1RB_OS50)	18.41	18.41	18.41	18.41	18.41	23.96	23.96	23.96	23.96	23.96	23.96
LTE 66 Ch132322 (QPSK20M_1RB_OS50)	21.18	21.18	21.18	21.18	21.18	24.26	24.26	24.26	24.26	24.26	24.26

Output Power Verification in dBm for EUT Bottom Side (Moving away phantom)											
Distance (mm)	18	19	20	21	22	23	24	25	26	27	28
WCDMA II Ch9538 (RMC 12.2K)	20.89	20.89	20.89	20.89	20.89	23.95	23.95	23.95	23.95	23.95	23.95
WCDMA IV Ch1413 (RMC 12.2K)	20.25	20.25	20.25	20.25	20.25	24.34	24.34	24.34	24.34	24.34	24.34
LTE 2 Ch18700 (QPSK20M_1RB_OS50)	20.58	20.58	20.58	20.58	20.58	23.5	23.5	23.5	23.5	23.5	23.5
LTE 7 Ch20850 (QPSK20M_1RB_OS50)	17.62	17.62	17.62	17.62	17.62	22.96	22.96	22.96	22.96	22.96	22.96
LTE 38 Ch38000 (QPSK20M_1RB_OS50)	18.87	18.87	18.87	18.87	18.87	24.03	24.03	24.03	24.03	24.03	24.03
LTE 41 Ch39750 (QPSK20M_1RB_OS50)	18.41	18.41	18.41	18.41	18.41	23.96	23.96	23.96	23.96	23.96	23.96
LTE 66 Ch132322 (QPSK20M_1RB_OS50)	21.18	21.18	21.18	21.18	21.18	24.26	24.26	24.26	24.26	24.26	24.26

WWAN Ant-4

Output Power Verification in dBm for EUT Front Face (Moving toward phantom)											
Distance (mm)	8	9	10	11	12	13	14	15	16	17	18
GSM1900 Ch810 (GPRS 1Tx Slot)	26.05	26.05	26.05	26.05	26.05	29.41	29.41	29.41	29.41	29.41	29.41
WCDMA II Ch9538 (RMC 12.2K)	17.51	17.51	17.51	17.51	17.51	21.29	21.29	21.29	21.29	21.29	21.29
WCDMA IV Ch1312 (RMC 12.2K)	17.92	17.92	17.92	17.92	17.92	21.4	21.4	21.4	21.4	21.4	21.4
LTE 2 Ch18700 (QPSK20M_1RB_OS50)	17.35	17.35	17.35	17.35	17.35	21.11	21.11	21.11	21.11	21.11	21.11
LTE 7 Ch20850 (QPSK20M_1RB_OS50)	16.01	16.01	16.01	16.01	16.01	21.97	21.97	21.97	21.97	21.97	21.97
LTE 38 Ch38000 (QPSK20M_1RB_OS50)	18.53	18.53	18.53	18.53	18.53	23.48	23.48	23.48	23.48	23.48	23.48
LTE 41 Ch39750 (QPSK20M_1RB_OS50)	18.34	18.34	18.34	18.34	18.34	23.73	23.73	23.73	23.73	23.73	23.73
LTE 66 Ch132322 (QPSK20M_1RB_OS50)	18.18	18.18	18.18	18.18	18.18	21.14	21.14	21.14	21.14	21.14	21.14

Output Power Verification in dBm for EUT Front Face (Moving away phantom)											
Distance (mm)	8	9	10	11	12	13	14	15	16	17	18
GSM1900 Ch810 (GPRS 1Tx Slot)	26.05	26.05	26.05	26.05	26.05	29.41	29.41	29.41	29.41	29.41	29.41
WCDMA II Ch9538 (RMC 12.2K)	17.51	17.51	17.51	17.51	17.51	21.29	21.29	21.29	21.29	21.29	21.29
WCDMA IV Ch1312 (RMC 12.2K)	17.92	17.92	17.92	17.92	17.92	21.4	21.4	21.4	21.4	21.4	21.4
LTE 2 Ch18700 (QPSK20M_1RB_OS50)	17.35	17.35	17.35	17.35	17.35	21.11	21.11	21.11	21.11	21.11	21.11
LTE 7 Ch20850 (QPSK20M_1RB_OS50)	16.01	16.01	16.01	16.01	16.01	21.97	21.97	21.97	21.97	21.97	21.97
LTE 38 Ch38000 (QPSK20M_1RB_OS50)	18.53	18.53	18.53	18.53	18.53	23.48	23.48	23.48	23.48	23.48	23.48
LTE 41 Ch39750 (QPSK20M_1RB_OS50)	18.34	18.34	18.34	18.34	18.34	23.73	23.73	23.73	23.73	23.73	23.73
LTE 66 Ch132322 (QPSK20M_1RB_OS50)	18.18	18.18	18.18	18.18	18.18	21.14	21.14	21.14	21.14	21.14	21.14

Output Power Verification in dBm for EUT Rear Face (Moving toward phantom)											
Distance (mm)	14	15	16	17	18	19	20	21	22	23	24
GSM1900 Ch810 (GPRS 1Tx Slot)	26.05	26.05	26.05	26.05	26.05	29.41	29.41	29.41	29.41	29.41	29.41
WCDMA II Ch9538 (RMC 12.2K)	17.51	17.51	17.51	17.51	17.51	21.29	21.29	21.29	21.29	21.29	21.29
WCDMA IV Ch1312 (RMC 12.2K)	17.92	17.92	17.92	17.92	17.92	21.4	21.4	21.4	21.4	21.4	21.4
LTE 2 Ch18700 (QPSK20M_1RB_OS50)	17.35	17.35	17.35	17.35	17.35	21.11	21.11	21.11	21.11	21.11	21.11
LTE 7 Ch20850 (QPSK20M_1RB_OS50)	16.01	16.01	16.01	16.01	16.01	21.97	21.97	21.97	21.97	21.97	21.97
LTE 38 Ch38000 (QPSK20M_1RB_OS50)	18.53	18.53	18.53	18.53	18.53	23.48	23.48	23.48	23.48	23.48	23.48
LTE 41 Ch39750 (QPSK20M_1RB_OS50)	18.34	18.34	18.34	18.34	18.34	23.73	23.73	23.73	23.73	23.73	23.73
LTE 66 Ch132322 (QPSK20M_1RB_OS50)	18.18	18.18	18.18	18.18	18.18	21.14	21.14	21.14	21.14	21.14	21.14

Output Power Verification in dBm for EUT Rear Face (Moving away phantom)											
Distance (mm)	14	15	16	17	18	19	20	21	22	23	24
GSM1900 Ch810 (GPRS 1Tx Slot)	26.05	26.05	26.05	26.05	26.05	29.41	29.41	29.41	29.41	29.41	29.41
WCDMA II Ch9538 (RMC 12.2K)	17.51	17.51	17.51	17.51	17.51	21.29	21.29	21.29	21.29	21.29	21.29
WCDMA IV Ch1312 (RMC 12.2K)	17.92	17.92	17.92	17.92	17.92	21.4	21.4	21.4	21.4	21.4	21.4
LTE 2 Ch18700 (QPSK20M_1RB_OS50)	17.35	17.35	17.35	17.35	17.35	21.11	21.11	21.11	21.11	21.11	21.11
LTE 7 Ch20850 (QPSK20M_1RB_OS50)	16.01	16.01	16.01	16.01	16.01	21.97	21.97	21.97	21.97	21.97	21.97
LTE 38 Ch38000 (QPSK20M_1RB_OS50)	18.53	18.53	18.53	18.53	18.53	23.48	23.48	23.48	23.48	23.48	23.48
LTE 41 Ch39750 (QPSK20M_1RB_OS50)	18.34	18.34	18.34	18.34	18.34	23.73	23.73	23.73	23.73	23.73	23.73
LTE 66 Ch132322 (QPSK20M_1RB_OS50)	18.18	18.18	18.18	18.18	18.18	21.14	21.14	21.14	21.14	21.14	21.14

Output Power Verification in dBm for EUT Top Side (Moving toward phantom)											
Distance (mm)	18	19	20	21	22	23	24	25	26	27	28
GSM1900 Ch810 (GPRS 1Tx Slot)	26.05	26.05	26.05	26.05	26.05	29.41	29.41	29.41	29.41	29.41	29.41
WCDMA II Ch9538 (RMC 12.2K)	17.51	17.51	17.51	17.51	17.51	21.29	21.29	21.29	21.29	21.29	21.29
WCDMA IV Ch1312 (RMC 12.2K)	17.92	17.92	17.92	17.92	17.92	21.4	21.4	21.4	21.4	21.4	21.4
LTE 2 Ch18700 (QPSK20M_1RB_OS50)	17.35	17.35	17.35	17.35	17.35	21.11	21.11	21.11	21.11	21.11	21.11
LTE 7 Ch20850 (QPSK20M_1RB_OS50)	16.01	16.01	16.01	16.01	16.01	21.97	21.97	21.97	21.97	21.97	21.97
LTE 38 Ch38000 (QPSK20M_1RB_OS50)	18.53	18.53	18.53	18.53	18.53	23.48	23.48	23.48	23.48	23.48	23.48
LTE 41 Ch39750 (QPSK20M_1RB_OS50)	18.34	18.34	18.34	18.34	18.34	23.73	23.73	23.73	23.73	23.73	23.73
LTE 66 Ch132322 (QPSK20M_1RB_OS50)	18.18	18.18	18.18	18.18	18.18	21.14	21.14	21.14	21.14	21.14	21.14

Output Power Verification in dBm for EUT Top Side (Moving away phantom)											
Distance (mm)	18	19	20	21	22	23	24	25	26	27	28
GSM1900 Ch810 (GPRS 1Tx Slot)	26.05	26.05	26.05	26.05	26.05	29.41	29.41	29.41	29.41	29.41	29.41
WCDMA II Ch9538 (RMC 12.2K)	17.51	17.51	17.51	17.51	17.51	21.29	21.29	21.29	21.29	21.29	21.29
WCDMA IV Ch1312 (RMC 12.2K)	17.92	17.92	17.92	17.92	17.92	21.4	21.4	21.4	21.4	21.4	21.4
LTE 2 Ch18700 (QPSK20M_1RB_OS50)	17.35	17.35	17.35	17.35	17.35	21.11	21.11	21.11	21.11	21.11	21.11
LTE 7 Ch20850 (QPSK20M_1RB_OS50)	16.01	16.01	16.01	16.01	16.01	21.97	21.97	21.97	21.97	21.97	21.97
LTE 38 Ch38000 (QPSK20M_1RB_OS50)	18.53	18.53	18.53	18.53	18.53	23.48	23.48	23.48	23.48	23.48	23.48
LTE 41 Ch39750 (QPSK20M_1RB_OS50)	18.34	18.34	18.34	18.34	18.34	23.73	23.73	23.73	23.73	23.73	23.73
LTE 66 Ch132322 (QPSK20M_1RB_OS50)	18.18	18.18	18.18	18.18	18.18	21.14	21.14	21.14	21.14	21.14	21.14

< Proximity Sensor Coverage >

In KDB 616217 section 6.3, if a sensor is spatially offset from the antenna(s), it is necessary to verify sensor triggering for conditions where the antenna is next to the user, but the sensor is laterally further away to ensure sensor coverage is sufficient for reducing the power to maintain compliance. For p-sensor coverage testing, the device is moved and “along the direction of maximum antenna and sensor offset”.

However, this device uses a capacitive proximity sensor that is same metallic component as the transmitting antenna to facilitate triggering in any condition the user may use the device in proximity of the antenna in the device.

Therefore, no further sensor coverage assessments were required.

<Proximity Sensor Tilt Angle Influences>

The proximity sensor tilt angle influence was determined per KDB 616217 for applicable edge. Summary for proximity sensor tilt angle influence is shown in below.

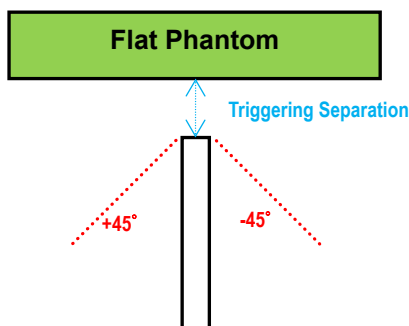

Orientation	Separation Distance (mm)	Tilt Angle										
		-45°	-40°	-30°	-20°	-10°	0°	10°	20°	30°	40°	45°
Top Side	22	On	On	On	On	On	On	On	On	On	On	On
Bottom Side	22	On	On	On	On	On	On	On	On	On	On	On

<Summary for Proximity Sensor Triggering Test>

According to the procedures noticed in KDB 616217 D04,

The power reduction is depends on the proximity sensor input. For a steady SAR test, the power reduction was enabled or disabled manually by engineering software during SAR testing.

WWAN Ant-1 Proximity Sensor Trigger Distance (mm)			
Position	Front Face	Rear Face	Bottom Side
Minimum	12	18	22

WWAN Ant-4 Proximity Sensor Trigger Distance (mm)			
Position	Front Face	Rear Face	Top Side
Minimum	12	18	22

The conservation triggering distances based on the separation distance for the sensor trigger / not triggered as EUT with power reduction at 0 mm, and EUT without power reduction is shown as below.

<Considerations Related to GSM / GPRS / EDGE for Setup and Testing>

The maximum multi-slot capability supported by this device is as below.

1. This EUT is class B device
2. This EUT supports GPRS multi-slot class 12 (max. uplink: 4, max. downlink: 4, total timeslots: 5)
3. This EUT supports EDGE multi-slot class 12 (max. uplink: 4, max. downlink: 4, total timeslots: 5)

For GSM850 frequency band, the power control level is set to 5 for GSM mode and GPRS (GMSK: CS1), and set to 8 for EDGE (GMSK: MCS1, 8PSK: MCS9). For GSM1900 frequency band, the power control level is set to 0 for GSM mode and GPRS (GMSK: CS1), and set to 2 for EDGE (GMSK: MCS1, 8PSK: MCS9).

SAR test reduction for GPRS and EDGE modes is determined by the source-based time-averaged output power specified for production units, including tune-up tolerance. The data mode with highest specified time-averaged output power should be tested for SAR compliance in the applicable exposure conditions. For modes with the same specified maximum output power and tolerance, the higher number time-slot configuration should be tested.

The frame-averaged power is linearly proportion to the slot number configured and it is linearly scaled the maximum burst-averaged power based on time slots. The calculated method is shown as below:

Frame-averaged power = $10 \times \log (\text{Burst-averaged power mW} \times \text{Slot used} / 8)$

<Considerations Related to WCDMA for Setup and Testing>

WCDMA Handsets Head SAR

SAR for next to the ear head exposure is measured using a 12.2 kbps RMC with TPC bits configured to all "1's". The 3G SAR test reduction procedure is applied to AMR configurations with 12.2 kbps RMC as the primary mode.

WCDMA Handsets Body-worn SAR

SAR for body-worn configurations is measured using a 12.2 kbps RMC with TPC bits configured to all "1's". The 3G SAR test reduction procedure is applied to other spreading codes and multiple DPDCH_n configurations supported by the handset with 12.2 kbps RMC as the primary mode.

Handsets with Release 5 HSDPA

The 3G SAR test reduction procedure is applied to HSDPA body-worn configurations with 12.2 kbps RMC as the primary mode. Otherwise, SAR is measured for HSDPA using the HSDPA body SAR procedures in the “Release 5 HSDPA Data Devices”, for the highest reported SAR body-worn exposure configuration in 12.2 kbps RMC. Handsets with both HSDPA and HSUPA are tested according to Release 6 HSPA test procedures.

Handsets with Release 6 HSUPA

The 3G SAR test reduction procedure is applied to HSPA (HSUPA/HSDPA with RMC) body-worn configurations with 12.2 kbps RMC as the primary mode. Otherwise, SAR is measured for HSPA using the HSPA body SAR procedures in the “Release 6 HSPA Data Devices”, for the highest reported body-worn exposure SAR configuration in 12.2 kbps RMC. When VOIP is applicable for next to the ear head exposure in HSPA, the 3G SAR test reduction procedure is applied to HSPA with 12.2 kbps RMC as the primary mode; otherwise, the same HSPA configuration used for body-worn measurements is tested for next to the ear head exposure.

Release 5 HSDPA Data Devices

The 3G SAR test reduction procedure is applied to body SAR with 12.2 kbps RMC as the primary mode. Otherwise, body SAR for HSDPA is measured using an FRC with H-Set 1 in Sub-test 1 and a 12.2 kbps RMC configured in Test Loop Mode 1, for the highest reported SAR configuration in 12.2 kbps RMC without HSDPA. HSDPA is configured according to the applicable UE category of a test device. The number of HS-DSCH / HS-PDSCHs, HARQ processes, minimum inter-TTI interval, transport block sizes and RV coding sequence are defined by the H-set. To maintain a consistent test configuration and stable transmission conditions, QPSK is used in the H-set for SAR testing. HS-DPCCH should be configured with a CQI feedback cycle of 4 ms and a CQI repetition factor of 2 to maintain a constant rate of active CQI slots. DPCCH and DPDCH gain factors (β_c , β_d), and HS-DPCCH power offset parameters (Δ_{ACK} , Δ_{NACK} , Δ_{CQI}) are set according to values indicated in below. The CQI value is determined by the UE category, transport block size, number of HS-PDSCHs and modulation used in the H-set.

Sub-test	β_c	β_d	β_d (SF)	β_c / β_d	$\beta_{hs}^{(1)}$	CM (dB) ⁽²⁾	MPR
1	2 / 15	15 / 15	64	2 / 15	4 / 15	0.0	0
2	12 / 15 ⁽³⁾	15 / 15 ⁽³⁾	64	12 / 15 ⁽³⁾	24 / 15	1.0	0
3	15 / 15	8 / 15	64	15 / 8	30 / 15	1.5	0.5
4	15 / 15	4 / 15	64	15 / 4	30 / 15	1.5	0.5

Note 1: Δ_{ACK} , Δ_{NACK} and $\Delta_{CQI} = 8 \Leftrightarrow A_{hs} = \beta_{hs} / \beta_c = 30 / 15 \Leftrightarrow \beta_{hs} = 30 / 15 * \beta_c$.
 Note 2: CM = 1 for $\beta_c / \beta_d = 12 / 15$, $\beta_{hs} / \beta_c = 24 / 15$.
 Note 3: For subtest 2 the β_c / β_d ratio of 12 / 15 for the TFC during the measurement period (TF1, TF0) is achieved by setting the signaled gain factors for the reference TFC (TF1, TF1) to $\beta_c = 11 / 15$ and $\beta_d = 15 / 15$.

Release 6 HSUPA Data Devices

The 3G SAR test reduction procedure is applied to body SAR with 12.2 kbps RMC as the primary mode. Otherwise, body SAR for HSPA is measured with E-DCH Sub-test 5, using H-Set 1 and QPSK for FRC and a 12.2 kbps RMC configured in Test Loop Mode 1 and power control algorithm 2, according to the highest reported body SAR configuration in 12.2 kbps RMC without HSPA. When VOIP applies to head exposure, the 3G SAR test reduction procedure is applied with 12.2 kbps RMC as the primary mode. Otherwise, the same HSPA configuration used for

body SAR measurements are applied to head exposure testing. Due to inner loop power control requirements in HSPA, a communication test set is required for output power and SAR tests. The 12.2 kbps RMC, FRC H-set 1 and E-DCH configurations for HSPA are configured according to the β values indicated in below.

Sub-test	β_c	β_d	β_d (SF)	β_c / β_d	$\beta_{hs}^{(1)}$	β_{ec}	β_{ed}	β_{ed} (SF)	β_{ed} (codes)	CM ⁽²⁾ (dB)	MPR (dB)	AG ⁽⁴⁾ Index	E-TFCI
1	11 / 15 ⁽³⁾	15 / 15 ⁽³⁾	64	11 / 15 ⁽³⁾	22 / 15	209 / 225	1039 / 225	4	1	1.0	0.0	20	75
2	6 / 15	15 / 15	64	6 / 15	12 / 15	12 / 15	94 / 75	4	1	3.0	2.0	12	67
3	15 / 15	9 / 15	64	15 / 9	30 / 15	30 / 15	β_{ed1} : 47/15 β_{ed2} : 47/15	4	2	2.0	1.0	15	92
4	2 / 15	15 / 15	64	2 / 15	4 / 15	2 / 15	56 / 75	4	1	3.0	2.0	17	71
5	15 / 15 ⁽⁴⁾	15 / 15 ⁽⁴⁾	64	15 / 15 ⁽⁴⁾	30 / 15	24 / 15	134 / 15	4	1	1.0	0.0	21	81

Note 1: $\Delta_{ACK}, \Delta_{NACK}$ and $\Delta_{CQI} = 8 \Leftrightarrow A_{hs} = \beta_{hs} / \beta_c = 30 / 15 \Leftrightarrow \beta_{hs} = 30 / 15 * \beta_c$
 Note 2: CM = 1 for $\beta_c / \beta_d = 12 / 15, \beta_{hs} / \beta_c = 24 / 15$. For all other combinations of DPDCH, DPCCH, HS-DPCCH, E-DPDCH and E-DPCCH the MPR is based on the relative CM difference.
 Note 3: For subtest 1 the β_c / β_d ratio of 11 / 15 for the TFC during the measurement period (TF1, TF0) is achieved by setting the signaled gain factors for the reference TFC (TF1, TF1) to $\beta_c = 10 / 15$ and $\beta_d = 15 / 15$.
 Note 4: For subtest 5 the β_c / β_d ratio of 15 / 15 for the TFC during the measurement period (TF1, TF0) is achieved by setting the signaled gain factors for the reference TFC (TF1, TF1) to $\beta_c = 14 / 15$ and $\beta_d = 15 / 15$.
 Note 5: Testing UE using E-DPDCH Physical Layer category 1 Sub-test 3 is not required according to TS 25.306 Table 5.1g.
 Note 6: β_{ed} cannot be set directly; it is set by Absolute Grant Value.

HSPA+ SAR Guidance

The 3G SAR test reduction procedure is applied to HSPA+ (uplink) with 12.2 kbps RMC as the primary mode. Otherwise, when SAR is required for Rel. 6 HSPA, SAR is required for Rel. 7 HSPA+. Power is measured for HSPA+ that supports uplink 16QAM according to configurations in Table C.11.1.4 of 3GPP TS 34.121-1 to determine SAR test reduction.

DC-HSDPA SAR Guidance

The 3G SAR test reduction procedure is applied to DC-HSDPA with 12.2 kbps RMC as the primary mode. Otherwise, when SAR is required for Rel. 5 HSDPA, SAR is required for Rel. 8 DC-HSDPA. Power is measured for DC-HSDPA according to the H-Set 12, FRC configuration in Table C.8.1.12 of 3GPP TS 34.121-1 to determine SAR test reduction. A primary and a secondary serving HS-DSCH Cell are required to perform the power measurement and for the results to be acceptable.

<Considerations Related to LTE for Setup and Testing>

This device contains LTE transmitter which follows 3GPP standards, supports QPSK, 16QAM and 64QAM modulations, and supported LTE band and channel bandwidth is listed in below. The output power was tested per 3GPP TS 36.521-1 maximum transmit procedures for both QPSK 16QAM and 64QAM modulation. The results please refer to section 4.6 of this report.

EUT Supported LTE Band and Channel Bandwidth						
LTE Band	BW 1.4 MHz	BW 3 MHz	BW 5 MHz	BW 10 MHz	BW 15 MHz	BW 20 MHz
2	V	V	V	V	V	V
4	V	V	V	V	V	V
5	V	V	V	V		
7			V	V	V	V
38			V	V	V	V
41			V	V	V	V
66	V	V	V	V	V	V

The LTE maximum power reduction (MPR) in accordance with 3GPP TS 36.101 is active all times during LTE operation. The allowed MPR for the maximum output power is specified in below.

Modulation	Channel Bandwidth / RB Configurations						LTE MPR Setting (dB)
	BW 1.4 MHz	BW 3 MHz	BW 5 MHz	BW 10 MHz	BW 15 MHz	BW 20 MHz	
QPSK	> 5	> 4	> 8	> 12	> 16	> 18	1
16QAM	<= 5	<= 4	<= 8	<= 12	<= 16	<= 18	1
16QAM	> 5	> 4	> 8	> 12	> 16	> 18	2
64QAM	<= 5	<= 4	<= 8	<= 12	<= 16	<= 18	2
64QAM	> 5	> 4	> 8	> 12	> 16	> 18	3

Note: MPR is according to the standard and implemented in the circuit (mandatory).

In addition, the device is compliant with additional maximum power reduction (A-MPR) requirements defined in 3GPP TS 36.101 section 6.2.4 that was disabled for all FCC compliance testing.

During LTE SAR testing, the related parameters of operating band, channel bandwidth, uplink channel number, modulation type, and RB was set in base station simulator. When the EUT has registered and communicated to base station simulator, the simulator set to make EUT transmitting the maximum radiated power.

TDD-LTE Setup Configurations

According to KDB 941225 D05, SAR testing for TDD-LTE device must be tested using a fixed periodic duty factor according to the highest transmission duty factor implemented for the device and supported by the defined 3GPP TDD-LTE configurations. The TDD-LTE of this device supports frame structure type 2 defined in 3GPP TS 36.211 section 4.2, and the frame structure configuration can be referred to below.

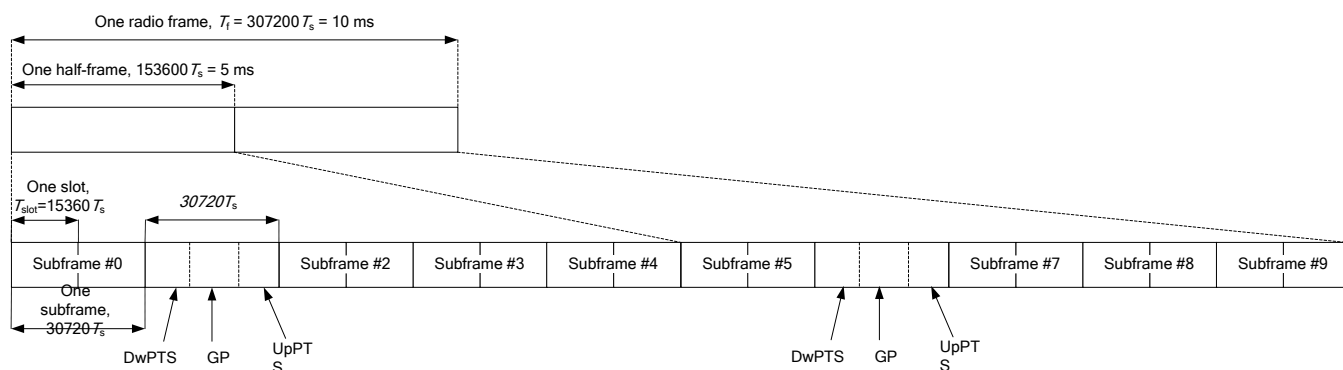

3GPP TS 36.211 Figure 4.2-1: Frame Structure Type 2

Special Subframe Configuration	Normal Cyclic Prefix in Downlink			Extended Cyclic Prefix in Downlink		
	DwPTS	UpPTS		DwPTS	UpPTS	
		Normal Cyclic Prefix in Uplink	Extended Cyclic Prefix in Uplink		Normal Cyclic Prefix in Uplink	Extended Cyclic Prefix in Uplink
0	6592 · Ts	2192 · Ts	2560 · Ts	7680 · Ts	2192 · Ts	2560 · Ts
1	19760 · Ts			20480 · Ts		
2	21952 · Ts			23040 · Ts		
3	24144 · Ts			25600 · Ts		
4	26336 · Ts			7680 · Ts		
5	6592 · Ts	4384 · Ts	5120 · Ts	20480 · Ts	4384 · Ts	5120 · Ts
6	19760 · Ts			23040 · Ts		
7	21952 · Ts			12800 · Ts		
8	24144 · Ts			-		
9	13168 · Ts	-	-	-	-	-

3GPP TS 36.211 Table 4.2-1: Configuration of Special Subframe

Uplink-Downlink Configuration	Downlink-to-Uplink Switch-Point Periodicity	Subframe Number										
		0	1	2	3	4	5	6	7	8	9	
0	5 ms	D	S	U	U	U	D	S	U	U	U	
1	5 ms	D	S	U	U	D	D	S	U	U	D	
2	5 ms	D	S	U	D	D	D	S	U	D	D	
3	10 ms	D	S	U	U	U	D	D	D	D	D	
4	10 ms	D	S	U	U	D	D	D	D	D	D	
5	10 ms	D	S	U	D	D	D	D	D	D	D	
6	5 ms	D	S	U	U	U	D	S	U	U	D	

3GPP TS 36.211 Table 4.2-2: Uplink-Downlink Configurations

The variety of different TD-LTE uplink-downlink configurations allows a network operator to allocate the network's capacity between uplink and downlink traffic to meet the needs of the network. The uplink duty cycle of these seven configurations can readily be computed and shown in below.

UL-DL Configuration	0	1	2	3	4	5	6
Highest Duty-Cycle	63.33%	43.33%	23.33%	31.67%	21.67%	11.67%	53.33%

Considering the highest transmission duty cycle, TDD-LTE was tested using Uplink-Downlink Configuration 0 with 6 uplink subframe and 2 special subframe. The special subframe was set to special subframe configuration 7 using extended cyclic prefix uplink. Therefore, SAR testing for TDD-LTE was performed at the maximum output power with highest transmission duty cycle of 63.33%.

<Considerations Related to WLAN for Setup and Testing>

In general, various vendor specific external test software and chipset based internal test modes are typically used for SAR measurement. These chipset based test mode utilities are generally hardware and manufacturer dependent, and often include substantial flexibility to reconfigure or reprogram a device. A Wi-Fi device must be configured to transmit continuously at the required data rate, channel bandwidth and signal modulation, using the highest transmission duty factor supported by the test mode tools for SAR measurement. The test frequencies established using test mode must correspond to the actual channel frequencies. When 802.11 frame gaps are accounted for in the transmission, a maximum transmission duty factor of 92 - 96% is typically achievable in most test mode configurations. A minimum transmission duty factor of 85% is required to avoid certain hardware and device implementation issues related to wide range SAR scaling. In addition, a periodic transmission duty factor is required for current generation SAR systems to measure SAR correctly. The reported SAR must be scaled to 100% transmission duty factor to determine compliance at the maximum tune-up tolerance limit.

According to KDB 248227 D01, this device has installed WLAN engineering testing software which can provide continuous transmitting RF signal. During WLAN SAR testing, this device was operated to transmit continuously at the maximum transmission duty with specified transmission mode, operating frequency, lowest data rate, and maximum output power.

Initial Test Configuration

An initial test configuration is determined for OFDM transmission modes in 2.4 GHz and 5 GHz bands according to the channel bandwidth, modulation and data rate combination(s) with the highest maximum output power specified for production units in each standalone and aggregated frequency band. When the same maximum power is specified for multiple transmission modes in a frequency band, the largest channel bandwidth, lowest order modulation, lowest data rate and lowest order 802.11a/g/n/ac mode is used for SAR measurement, on the highest measured output power channel in the initial test configuration, for each frequency band.

Subsequent Test Configuration

SAR measurement requirements for the remaining 802.11 transmission mode configurations that have not been tested in the initial test configuration are determined separately for each standalone and aggregated frequency band, in each exposure condition, according to the maximum output power specified for production units. Additional power measurements may be required to determine if SAR measurements are required for subsequent highest output power channels in a subsequent test configuration. When the highest reported SAR for the initial test configuration according to the initial test position or fixed exposure position requirements, is adjusted by the ratio of the subsequent test configuration to initial test configuration specified maximum output power and the adjusted SAR is ≤ 1.2 W/kg, SAR is not required for that subsequent test configuration.

SAR Test Configuration and Channel Selection

When multiple channel bandwidth configurations in a frequency band have the same specified maximum output power, the initial test configuration is using largest channel bandwidth, lowest order modulation, lowest data rate, and lowest order 802.11 mode (i.e., 802.11a is chosen over 802.11n then 802.11ac or 802.11g is chosen over 802.11n). After an initial test configuration is determined, if multiple test channels have the same measured maximum output power, the channel chosen for SAR measurement is determined according to the following.

- 1) The channel closest to mid-band frequency is selected for SAR measurement.
- 2) For channels with equal separation from mid-band frequency; for example, high and low channels or two mid-band channels, the higher frequency (number) channel is selected for SAR measurement.

Test Reduction for U-NII-1 (5.2 GHz) and U-NII-2A (5.3 GHz) Bands

For devices that operate in both U-NII bands using the same transmitter and antenna(s), SAR test reduction is determined according to the following.

- 1) When the same maximum output power is specified for both bands, begin SAR measurement in U-NII-2A band by applying the OFDM SAR requirements. If the highest reported SAR for a test configuration is ≤ 1.2 W/kg, SAR is not required for U-NII-1 band for that configuration (802.11 mode and exposure condition).
- 2) When different maximum output power is specified for the bands, begin SAR measurement in the band with higher specified maximum output power. The highest reported SAR for the tested configuration is adjusted by the ratio of lower to higher specified maximum output power for the two bands. When the adjusted SAR is ≤ 1.2 W/kg, SAR is not required for the band with lower maximum output power in that test configuration.

<Considerations Related to Bluetooth for Setup and Testing>

This device has installed Bluetooth engineering testing software which can provide continuous transmitting RF signal. During Bluetooth SAR testing, this device was operated to transmit continuously at the maximum transmission duty with specified transmission mode, operating frequency, lowest data rate, and maximum output power.

4.2 EUT Testing Position

According to KDB 648474 D04, handsets are tested for SAR compliance in head, body-worn accessory and other use configurations described in the following subsections.

4.2.1 Head Exposure Conditions

Head exposure is limited to next to the ear voice mode operations. Head SAR compliance is tested according to the test positions defined in IEEE Std 1528-2013 using the SAM phantom illustrated as below.

1. Define two imaginary lines on the handset
 - (a) The vertical centerline passes through two points on the front side of the handset - the midpoint of the width w_t of the handset at the level of the acoustic output, and the midpoint of the width w_b of the bottom of the handset.
 - (b) The horizontal line is perpendicular to the vertical centerline and passes through the center of the acoustic output. The horizontal line is also tangential to the face of the handset at point A.
 - (c) The two lines intersect at point A. Note that for many handsets, point A coincides with the center of the acoustic output; however, the acoustic output may be located elsewhere on the horizontal line. Also note that the vertical centerline is not necessarily parallel to the front face of the handset, especially for clamshell handsets, handsets with flip covers, and other irregularly shaped handsets.

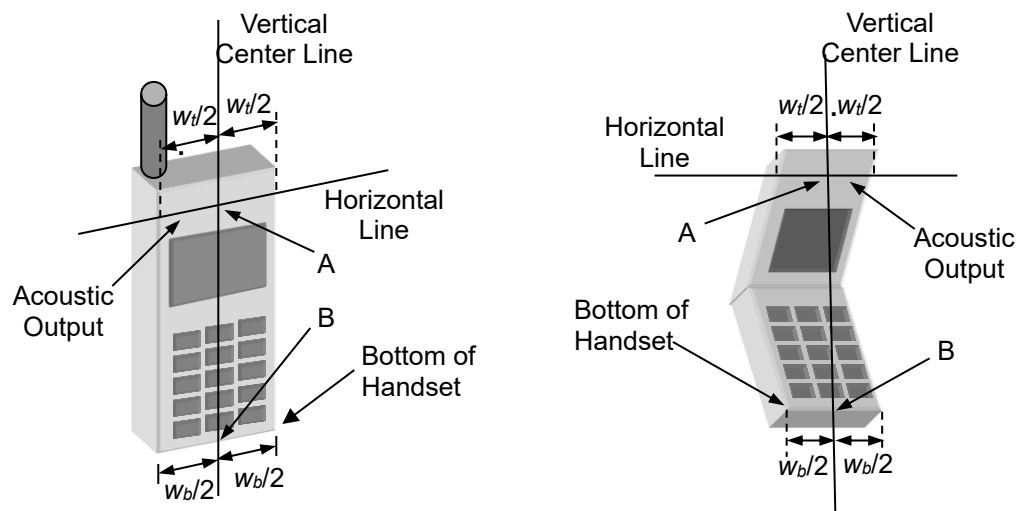

Fig-4.1 Illustration for Handset Vertical and Horizontal Reference Lines

2. Cheek Position

- (a) To position the device with the vertical center line of the body of the device and the horizontal line crossing the center piece in a plane parallel to the sagittal plane of the phantom. While maintaining the device in this plane, align the vertical center line with the reference plane containing the three ear and mouth reference point (M: Mouth, RE: Right Ear, and LE: Left Ear) and align the center of the ear piece with the line RE-LE.
- (b) To move the device towards the phantom with the ear piece aligned with the line LE-RE until the phone touched the ear. While maintaining the device in the reference plane and maintaining the phone contact with the ear, move the bottom of the phone until any point on the front side is in contact with the cheek of the phantom or until contact

with the ear is lost (see Fig-4.2).

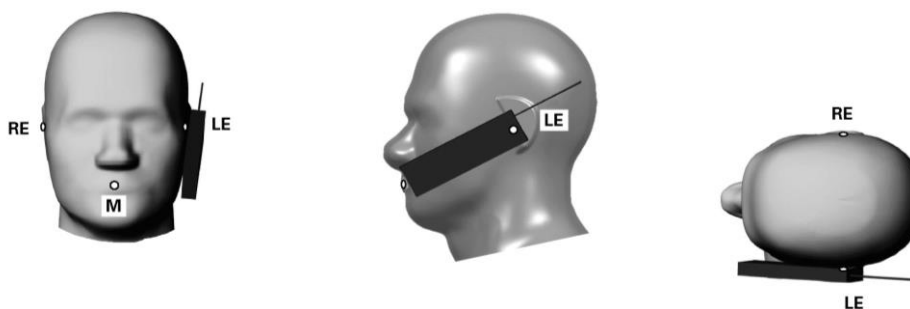

Fig-4.2 Illustration for Cheek Position

3. Tilted Position

(a) To position the device in the “cheek” position described above.

(b) While maintaining the device the reference plane described above and pivoting against the ear, moves it outward away from the mouth by an angle of 15 degrees or until contact with the ear is lost (see Fig-4.3).

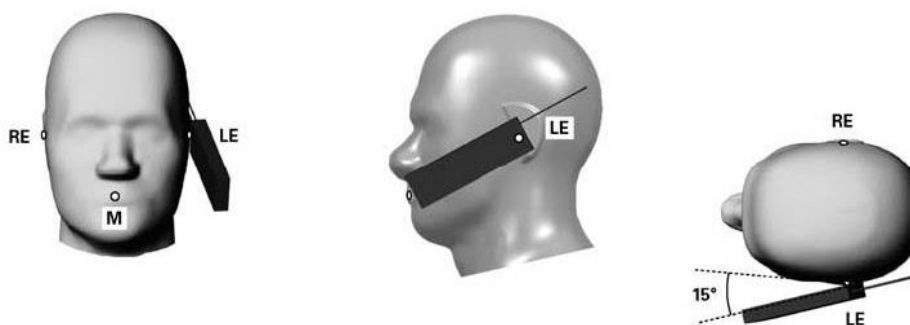

Fig-4.3 Illustration for Tilted Position

4.2.2 Body-worn Accessory Exposure Conditions

Body-worn accessory exposure is typically related to voice mode operations when handsets are carried in body-worn accessories. The body-worn accessory procedures in KDB 447498 D01 are used to test for body-worn accessory SAR compliance, without a headset connected to it. This enables the test results for such configuration to be compatible with that required for hotspot mode when the body-worn accessory test separation distance is greater than or equal to that required for hotspot mode. When the reported SAR for a body-worn accessory, measured without a headset connected to the handset, is > 1.2 W/kg, the highest reported SAR configuration for that wireless mode and frequency band should be repeated for that body-worn accessory with a headset attached to the handset.

Body-worn accessories that do not contain metallic or conductive components may be tested according to worst-case exposure configurations, typically according to the smallest test separation distance required for the group of body-worn accessories with similar operating and exposure characteristics. All body-worn accessories containing metallic components are tested in conjunction with the host device.

Body-worn accessory SAR compliance is based on a single minimum test separation distance for all wireless and operating modes applicable to each body-worn accessory used by the host, and according to the relevant voice and/or data mode transmissions and operations. If a body-worn accessory supports voice only operations in its normal and expected use conditions, testing of data mode for body-worn compliance is not required.

A conservative minimum test separation distance for supporting off-the-shelf body-worn accessories that may be acquired by users of consumer handsets is used to test for body-worn accessory SAR compliance. This distance is determined by the handset manufacturer, according to the requirements of Supplement C 01-01. Devices that are designed to operate on the body of users using lanyards and straps, or without requiring additional body-worn accessories, will be tested using a conservative minimum test separation distance ≤ 5 mm to support compliance.

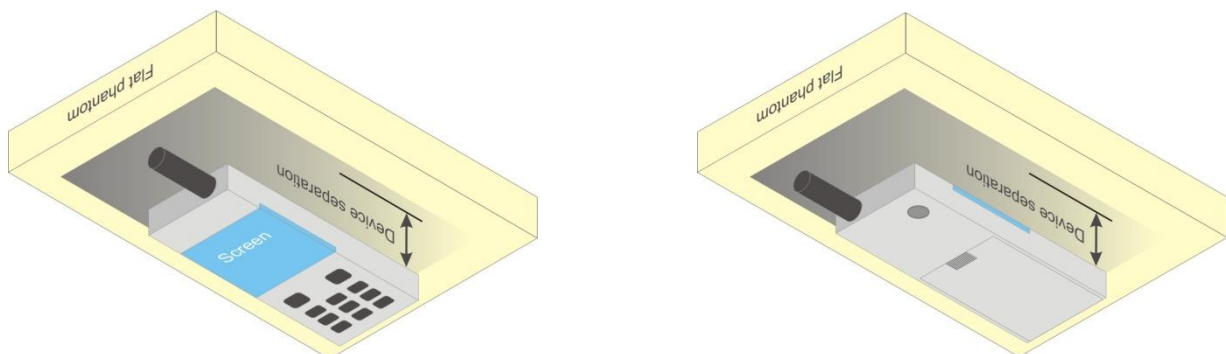
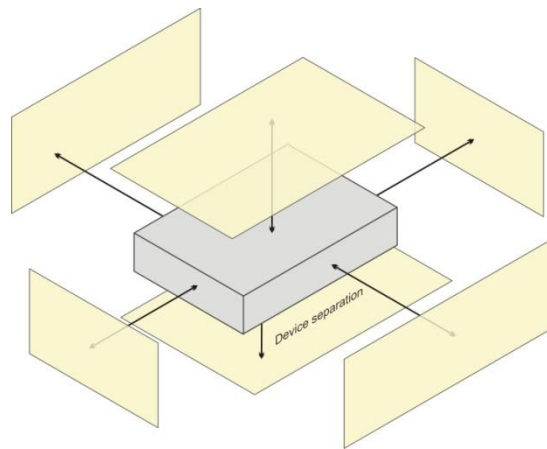

Fig-4.4 Illustration for Body Worn Position

4.2.3 Hotspot Mode Exposure Conditions

For handsets that support hotspot mode operations, with wireless router capabilities and various web browsing functions, the relevant hand and body exposure conditions are tested according to the hotspot SAR procedures in KDB 941225 D06. A test separation distance of 10 mm is required between the phantom and all surfaces and edges with a transmitting antenna located within 25 mm from that surface or edge. When the form factor of a handset is smaller than 9 cm x 5 cm, a test separation distance of 5 mm (instead of 10 mm) is required for testing hotspot mode. When the separation distance required for body-worn accessory testing is larger than or equal to that tested for hotspot mode, in the same wireless mode and for the same surface of the phone, the hotspot mode SAR data may be used to support body-worn accessory SAR compliance for that particular configuration (surface).



Based on the antenna location shown on appendix E of this report, the SAR testing required for hotspot mode is listed as below.

Antenna	Front Face	Rear Face	Left Side	Right Side	Top Side	Bottom Side
WWAN-Ant 1	V	V	V	V		V
WWAN-Ant 4	V	V	V		V	
WLAN / BT-Ant 2	V	V		V	V	

4.2.4 Extremity Exposure Conditions

For smart phones with a display diagonal dimension > 15 cm or an overall diagonal dimension > 16 cm that provide similar mobile web access and multimedia support found in mini-tablets or UMPC mini-tablets that support voice calls next to the ear, the following phablet procedures should be applied to evaluate SAR compliance for each applicable wireless modes and frequency band. Devices marketed as phablets, regardless of form factors and operating characteristics must be tested as a phablet to determine SAR compliance.

1. The normally required head and body-worn accessory SAR test procedures for handsets, including hotspot mode, must be applied.
2. The UMPC mini-tablet procedures must also be applied to test the SAR of all surfaces and edges with an antenna located at ≤ 25 mm from that surface or edge, in direct contact with a flat phantom, for 10-g extremity SAR according to the body-equivalent tissue dielectric parameters in KDB 865664 to address interactive hand use exposure conditions. The UMPC mini-tablet 1-g SAR at 5 mm is not required. When hotspot mode applies, 10-g extremity SAR is required only for the surfaces and edges with hotspot mode 1-g SAR > 1.2 W/kg. The normal tablet procedures in KDB 616217 are required when the over diagonal dimension of the device is > 20 cm. Hotspot mode SAR is not required when normal tablet procedures are applied. Extremity 10-g SAR is also not required for the front (top) surface of large form factor full size tablets. The more conservative tablet SAR results can be used to support the 10-g extremity SAR for phablet mode.
3. The simultaneous transmission operating configurations applicable to voice and data transmissions for both phone and mini-tablet modes must be taken into consideration separately for 1-g and 10-g SAR to determine the simultaneous transmission SAR test exclusion and measurement requirements for the relevant wireless modes and exposure conditions.

4.2.5 Simultaneous Transmission Possibilities

The simultaneous transmission possibilities for this device are listed as below.

Simultaneous TX Combination	Capable Transmit Configurations	Head	Body-worn	Hotspot	Extremity
1	WWAN + WLAN2.4G			Yes	
2	WWAN + WLAN5G			Yes	
3	WWAN + BT			Yes	
4	WWAN + WLAN5G + BT			Yes	

4.2.6 SAR Text Exclusion Evaluations

For NFC:

1. Maximum output power = 2000 mW
2. Duty Cycle = 99%
3. Length of each event = 0.5 second
4. Events per observation period = 2 times
5. Observation period = 360 seconds

Based on the above data, calculated the time-averaged power: $(2000 \times 0.99 \times 0.5 \times 2) / 360 = 5.5 \text{ mW}$.

According to KDB 447498 D04 and 2022 TCB workshop, the SAR test exclusion condition is based on source-based time-averaged maximum conducted output power, adjusted for tune-up tolerance, and the minimum test separation distance required for the exposure conditions. The SAR exclusion threshold is determined by the following.

Mode	Max. Tune-up Power (mW)	Ant. to Surface (mm)	Exemption limit (mW)	Require SAR Testing?
NFC (13.56MHz)	5.5	5	442	No

4.3 Tissue Verification

The measuring results for tissue simulating liquid are shown as below.

Test Date	Tissue Type	Frequency (MHz)	Liquid Temp. (°C)	Measured Conductivity (σ)	Measured Permittivity (ϵ_r)	Target Conductivity (σ)	Target Permittivity (ϵ_r)	Conductivity Deviation (%)	Permittivity Deviation (%)
Jul. 11, 2024	Head	835	22.4	0.916	43.010	0.90	41.50	1.78	3.64
Jul. 12, 2024	Head	1750	22.3	1.353	39.339	1.37	40.10	-1.24	-1.90
Jul. 13, 2024	Head	1750	22.6	1.375	40.868	1.37	40.10	0.36	1.92
Jul. 13, 2024	Head	1950	22.5	1.463	38.939	1.40	40.00	4.50	-2.65
Jul. 14, 2024	Head	1950	22.5	1.467	39.297	1.40	40.00	4.79	-1.76
Jul. 14, 2024	Head	2450	22.6	1.879	39.632	1.80	39.20	4.39	1.10
Jul. 15, 2024	Head	2550	22.7	1.940	39.474	1.91	39.07	1.57	1.03
Jul. 16, 2024	Head	2550	22.5	1.959	39.192	1.91	39.07	2.57	0.30
Jul. 17, 2024	Head	5250	22.6	4.561	35.211	4.71	35.93	-3.08	-2.00
Jul. 17, 2024	Head	5600	22.7	4.956	34.689	5.07	35.53	-2.15	-2.36
Jul. 17, 2024	Head	5750	22.5	5.149	34.383	5.17	35.41	-0.35	-2.91

Note:

The dielectric properties of the tissue simulating liquid must be measured within 24 hours before the SAR testing and within $\pm 5\%$ of the target values. Liquid temperature during the SAR testing must be within $\pm 2^\circ\text{C}$.

4.4 System Verification

The measuring result for system verification is tabulated as below.

<1g>

Test Date	Mode	Frequency (MHz)	1W Target SAR-1g (W/kg)	Measured SAR-1g (W/kg)	Normalized to 1W SAR-1g (W/kg)	Deviation (%)	Dipole S/N	Probe S/N	DAE S/N
Jul. 11, 2024	Head	835	9.60	2.51	10.04	4.58	4d265	7612	1633
Jul. 12, 2024	Head	1750	36.60	9.13	36.52	-0.22	1176	7612	1633
Jul. 13, 2024	Head	1750	36.60	9.20	36.80	0.55	1176	7612	1633
Jul. 13, 2024	Head	1950	40.30	10.50	42.00	4.22	1229	7612	1633
Jul. 14, 2024	Head	1950	40.30	9.87	39.48	-2.03	1229	7612	1633
Jul. 14, 2024	Head	2450	52.80	13.80	55.20	4.55	1048	7612	1633
Jul. 15, 2024	Head	2550	53.00	13.10	52.40	-1.13	1022	7612	1633
Jul. 16, 2024	Head	2550	53.00	12.90	51.60	-2.64	1022	7612	1633
Jul. 17, 2024	Head	5250	76.90	7.34	73.40	-4.55	1315	7612	1633
Jul. 17, 2024	Head	5600	81.90	8.34	83.40	1.83	1315	7612	1633
Jul. 17, 2024	Head	5750	76.10	7.74	77.40	1.71	1315	7612	1633

<10g>

Test Date	Mode	Frequency (MHz)	1W Target SAR-10g (W/kg)	Measured SAR-10g (W/kg)	Normalized to 1W SAR-10g (W/kg)	Deviation (%)	Dipole S/N	Probe S/N	DAE S/N
Jul. 11, 2024	Head	835	6.25	1.64	6.56	4.96	4d265	7612	1633
Jul. 12, 2024	Head	1750	19.20	4.88	19.52	1.67	1176	7612	1633
Jul. 13, 2024	Head	1750	19.20	4.86	19.44	1.25	1176	7612	1633
Jul. 13, 2024	Head	1950	20.30	5.30	21.20	4.43	1229	7612	1633
Jul. 14, 2024	Head	1950	20.30	5.00	20.00	-1.48	1229	7612	1633
Jul. 14, 2024	Head	2450	24.20	6.34	25.36	4.79	1048	7612	1633
Jul. 15, 2024	Head	2550	24.20	5.97	23.88	-1.32	1022	7612	1633
Jul. 16, 2024	Head	2550	24.20	5.87	23.48	-2.98	1022	7612	1633
Jul. 17, 2024	Head	5250	22.10	2.18	21.80	-1.36	1315	7612	1633
Jul. 17, 2024	Head	5600	23.50	2.34	23.40	-0.43	1315	7612	1633
Jul. 17, 2024	Head	5750	21.70	2.18	21.80	0.46	1315	7612	1633

Note:

Comparing to the reference SAR value provided by SPEAG, the validation data should be within its specification of 10 %. The result indicates the system check can meet the variation criterion and the plots can be referred to Appendix A of this report.

4.5 Maximum Output Power

4.5.1 Maximum Conducted Power

The maximum conducted average power (Unit: dBm) including tune-up tolerance please refer to Appendix D.

4.5.2 Measured Conducted Power Result

The measuring conducted average power (Unit: dBm) please refer to Appendix D.

4.6 SAR Testing Results

4.6.1 SAR Test Reduction Considerations

<KDB 447498 D04, General RF Exposure Guidance>

Testing of other required channels within the operating mode of a frequency band is not required when the reported SAR for the mid-band or highest output power channel is:

- (1) ≤ 0.8 W/kg or 2.0 W/kg, for 1-g or 10-g respectively, when the transmission band is ≤ 100 MHz
- (2) ≤ 0.6 W/kg or 1.5 W/kg, for 1-g or 10-g respectively, when the transmission band is between 100 MHz and 200 MHz
- (3) ≤ 0.4 W/kg or 1.0 W/kg, for 1-g or 10-g respectively, when the transmission band is ≥ 200 MHz

<KDB 941225 D01, 3G SAR Measurement Procedures>

The mode tested for SAR is referred to as the primary mode. The equivalent modes considered for SAR test reduction are denoted as secondary modes. Both primary and secondary modes must be in the same frequency band. When the maximum output power and tune-up tolerance specified for production units in a secondary mode is $\leq 1/4$ dB higher than the primary mode or when the highest reported SAR of the primary mode is scaled by the ratio of specified maximum output power and tune-up tolerance of secondary to primary mode and the adjusted SAR is ≤ 1.2 W/kg, SAR measurement is not required for the secondary mode.

<KDB 941225 D05, SAR Evaluation Considerations for LTE Devices>

(1) QPSK with 1 RB and 50% RB allocation

Start with the largest channel bandwidth and measure SAR, using the RB offset and required test channel combination with the highest maximum output power among RB offsets at the upper edge, middle and lower edge of each required test channel. When the reported SAR is ≤ 0.8 W/kg, testing of the remaining RB offset configurations and required test channels is not required; otherwise, SAR is required for the remaining required test channels and only for the RB offset configuration with the highest output power for that channel. When the reported SAR of a required test channel is > 1.45 W/kg, SAR is required for all three RB offset configurations for that required test channel.

(2) QPSK with 100% RB allocation

SAR is not required when the highest maximum output power for 100% RB allocation is less than the highest maximum output power in 50% and 1 RB allocations and the highest reported SAR for 1 RB and 50% RB allocation are ≤ 0.8 W/kg. Otherwise, SAR is measured for the highest output power channel; and if the reported SAR is > 1.45 W/kg, the remaining required test channels must also be tested.

(3) Higher order modulations

SAR is required only when the highest maximum output power for the configuration in the higher order modulation is $> 1/2$ dB higher than the same configuration in QPSK or when the reported SAR for the QPSK configuration is > 1.45 W/kg.

(4) Other channel bandwidth

SAR is required when the highest maximum output power of the smaller channel bandwidth is $> 1/2$ dB higher than the equivalent channel configurations in the largest channel bandwidth configuration or the reported SAR of a configuration for the largest channel bandwidth is > 1.45 W/kg.

<KDB 248227 D01, SAR Guidance for Wi-Fi Transmitters>

(1) For handsets operating next to ear, hotspot mode or mini-tablet configurations, the initial test position procedures were applied. The test position with the highest extrapolated peak SAR will be used as the initial test position. When the reported SAR of initial test position is ≤ 0.4 W/kg, SAR testing for remaining test positions is not required. Otherwise, SAR is evaluated at the subsequent highest peak SAR positions until the reported SAR result is ≤ 0.8 W/kg or all test positions are measured.

(2) For WLAN 2.4 GHz, the highest measured maximum output power channel for DSSS was selected for SAR measurement. When the reported SAR is ≤ 0.8 W/kg, no further SAR testing is required. Otherwise, SAR is evaluated at the next highest measured output power channel. When any reported SAR is > 1.2 W/kg, SAR is required for the third channel. For OFDM modes (802.11g/n), SAR is not required when the highest reported SAR for DSSS is adjusted by the ratio of OFDM to DSSS specified maximum output power and it is ≤ 1.2 W/kg.



BUREAU VERITAS

FCC SAR Test Report



Certificate #6613.01

- (3) For WLAN 5 GHz, the initial test configuration was selected according to the transmission mode with the highest maximum output power. When the reported SAR of initial test configuration is > 0.8 W/kg, SAR is required for the subsequent highest measured output power channel until the reported SAR result is <= 1.2 W/kg or all required channels are measured. For other transmission modes, SAR is not required when the highest reported SAR for initial test configuration is adjusted by the ratio of subsequent test configuration to initial test configuration specified maximum output power and it is <= 1.2 W/kg.
- (4) For WLAN MIMO mode, the power-based standalone SAR test exclusion or the sum of SAR provision in KDB 447498 to determine simultaneous transmission SAR test exclusion should be applied. Otherwise, SAR for MIMO mode will be measured with all applicable antennas transmitting simultaneously at the specified maximum output power of MIMO operation.

4.6.2 SAR Results for Head Exposure Condition

Plot No.	Band	Mode	Test Position	Ch.	RB#	RB Offset	Power State	Antenna	Sample	Duty Cycle %	Max. Tune-up Power (dBm)	Measured Conducted Power (dBm)	Power Drift (dB)	Measured SAR-1g (W/kg)	Duty Cycle Scaling Factor	Tune-up Scaling Factor	Scaled SAR-1g (W/kg)
	GSM850	GPRS 4Tx Slot	Right Cheek	251	-	-	DSI-1	Ant1	1	-	27.50	26.59	0.08	0.143	1.000	1.233	0.18
	GSM850	GPRS 4Tx Slot	Right Tilted	251	-	-	DSI-1	Ant1	1	-	27.50	26.59	0.10	0.088	1.000	1.233	0.11
	GSM850	GPRS 4Tx Slot	Left Cheek	251	-	-	DSI-1	Ant1	1	-	27.50	26.59	0.07	0.141	1.000	1.233	0.17
	GSM850	GPRS 4Tx Slot	Left Tilted	251	-	-	DSI-1	Ant1	1	-	27.50	26.59	0.06	0.083	1.000	1.233	0.10
1	GSM850	GPRS 4Tx Slot	Right Cheek	251	-	-	DSI1	Ant4	1	-	26.50	25.56	0.15	0.833	1.000	1.242	1.03
	GSM850	GPRS 4Tx Slot	Right Tilted	251	-	-	DSI1	Ant4	1	-	26.50	25.56	0.07	0.501	1.000	1.242	0.62
	GSM850	GPRS 4Tx Slot	Left Cheek	251	-	-	DSI1	Ant4	1	-	26.50	25.56	0.06	0.618	1.000	1.242	0.77
	GSM850	GPRS 4Tx Slot	Left Tilted	251	-	-	DSI1	Ant4	1	-	26.50	25.56	-0.02	0.521	1.000	1.242	0.65
	GSM850	GPRS 4Tx Slot	Right Cheek	128	-	-	DSI1	Ant4	1	-	26.50	25.28	0.07	0.504	1.000	1.324	0.67
	GSM850	GPRS 4Tx Slot	Right Cheek	189	-	-	DSI1	Ant4	1	-	26.50	25.39	0.12	0.538	1.000	1.291	0.69
	GSM850	GPRS 4Tx Slot	Right Cheek	251	-	-	DSI1	Ant4	2	-	26.50	25.56	-0.07	0.762	1.000	1.242	0.95
	GSM850	GPRS 4Tx Slot	Right Cheek	251	-	-	DSI1	Ant4	3	-	26.50	25.56	0.11	0.789	1.000	1.242	0.98
	GSM850	GPRS 4Tx Slot	Right Cheek	251	-	-	DSI1	Ant4	4	-	26.50	25.56	0.04	0.769	1.000	1.242	0.95
	GSM1900	GPRS 1Tx Slot	Right Cheek	661	-	-	DSI-1	Ant1	1	-	30.50	29.31	-0.13	0.066	1.000	1.315	0.09
	GSM1900	GPRS 1Tx Slot	Right Tilted	661	-	-	DSI-1	Ant1	1	-	30.50	29.31	0.11	0.044	1.000	1.315	0.06
	GSM1900	GPRS 1Tx Slot	Left Cheek	661	-	-	DSI-1	Ant1	1	-	30.50	29.31	0.04	0.064	1.000	1.315	0.08
	GSM1900	GPRS 1Tx Slot	Left Tilted	661	-	-	DSI-1	Ant1	1	-	30.50	29.31	0.03	0.046	1.000	1.315	0.06
	GSM1900	GPRS 1Tx Slot	Right Cheek	810	-	-	DSI-1	Ant4	1	-	24.50	23.57	-0.09	0.544	1.000	1.239	0.67
2	GSM1900	GPRS 1Tx Slot	Right Tilted	810	-	-	DSI-1	Ant4	1	-	24.50	23.57	0.13	0.715	1.000	1.239	0.89
	GSM1900	GPRS 1Tx Slot	Left Cheek	810	-	-	DSI-1	Ant4	1	-	24.50	23.57	0.08	0.369	1.000	1.239	0.46
	GSM1900	GPRS 1Tx Slot	Left Tilted	810	-	-	DSI-1	Ant4	1	-	24.50	23.57	0.07	0.431	1.000	1.239	0.53
	GSM1900	GPRS 1Tx Slot	Right Tilted	512	-	-	DSI-1	Ant4	1	-	24.50	23.45	0.02	0.566	1.000	1.274	0.72
	GSM1900	GPRS 1Tx Slot	Right Tilted	661	-	-	DSI-1	Ant4	1	-	24.50	23.53	-0.11	0.547	1.000	1.250	0.68
	WCDMA II	RMC12.2K	Right Cheek	9538	-	-	DSI-1	Ant1	1	-	25.50	24.46	0.13	0.245	1.000	1.271	0.31
	WCDMA II	RMC12.2K	Right Tilted	9538	-	-	DSI-1	Ant1	1	-	25.50	24.46	0.06	0.184	1.000	1.271	0.23
	WCDMA II	RMC12.2K	Left Cheek	9538	-	-	DSI-1	Ant1	1	-	25.50	24.46	0.08	0.309	1.000	1.271	0.39
	WCDMA II	RMC12.2K	Left Tilted	9538	-	-	DSI-1	Ant1	1	-	25.50	24.46	-0.07	0.243	1.000	1.271	0.31
	WCDMA II	RMC12.2K	Right Cheek	9538	-	-	DSI-1	Ant4	1	-	15.50	14.25	0.11	0.572	1.000	1.334	0.76
3	WCDMA II	RMC12.2K	Right Tilted	9538	-	-	DSI-1	Ant4	1	-	15.50	14.25	-0.02	0.739	1.000	1.334	0.99
	WCDMA II	RMC12.2K	Left Cheek	9538	-	-	DSI-1	Ant4	1	-	15.50	14.25	-0.17	0.372	1.000	1.334	0.50
	WCDMA II	RMC12.2K	Left Tilted	9538	-	-	DSI-1	Ant4	1	-	15.50	14.25	0.07	0.436	1.000	1.334	0.58
	WCDMA II	RMC12.2K	Right Tilted	9262	-	-	DSI-1	Ant4	1	-	15.50	14.19	0.05	0.457	1.000	1.352	0.62
	WCDMA II	RMC12.2K	Right Tilted	9400	-	-	DSI-1	Ant4	1	-	15.50	14.24	0.01	0.622	1.000	1.337	0.83
	WCDMA IV	RMC12.2K	Right Cheek	1413	-	-	DSI-1	Ant1	1	-	25.50	24.34	-0.06	0.135	1.000	1.306	0.18
	WCDMA IV	RMC12.2K	Right Tilted	1413	-	-	DSI-1	Ant1	1	-	25.50	24.34	0.02	0.086	1.000	1.306	0.11
	WCDMA IV	RMC12.2K	Left Cheek	1413	-	-	DSI-1	Ant1	1	-	25.50	24.34	0.17	0.107	1.000	1.306	0.14
	WCDMA IV	RMC12.2K	Left Tilted	1413	-	-	DSI-1	Ant1	1	-	25.50	24.34	0.02	0.092	1.000	1.306	0.12
	WCDMA IV	RMC12.2K	Right Cheek	1312	-	-	DSI1	Ant4	1	-	16.00	14.95	-0.03	0.589	1.000	1.274	0.75
	WCDMA IV	RMC12.2K	Right Tilted	1312	-	-	DSI1	Ant4	1	-	16.00	14.95	-0.05	0.648	1.000	1.274	0.83
	WCDMA IV	RMC12.2K	Left Cheek	1312	-	-	DSI1	Ant4	1	-	16.00	14.95	-0.04	0.397	1.000	1.274	0.51
	WCDMA IV	RMC12.2K	Left Tilted	1312	-	-	DSI1	Ant4	1	-	16.00	14.95	-0.02	0.446	1.000	1.274	0.57
4	WCDMA IV	RMC12.2K	Right Tilted	1413	-	-	DSI1	Ant4	1	-	16.00	14.93	-0.04	0.717	1.000	1.279	0.92
	WCDMA IV	RMC12.2K	Right Tilted	1513	-	-	DSI1	Ant4	1	-	16.00	14.88	0.18	0.630	1.000	1.294	0.82
	WCDMA V	RMC12.2K	Right Cheek	4233	-	-	DSI-1	Ant1	1	-	25.50	24.29	-0.06	0.168	1.000	1.321	0.22
	WCDMA V	RMC12.2K	Right Tilted	4233	-	-	DSI-1	Ant1	1	-	25.50	24.29	-0.09	0.086	1.000	1.321	0.11
	WCDMA V	RMC12.2K	Left Cheek	4233	-	-	DSI-1	Ant1	1	-	25.50	24.29	0.16	0.166	1.000	1.321	0.22
	WCDMA V	RMC12.2K	Left Tilted	4233	-	-	DSI-1	Ant1	1	-	25.50	24.29	-0.07	0.091	1.000	1.321	0.12
5	WCDMA V	RMC12.2K	Right Cheek	4233	-	-	DSI1	Ant4	1	-	23.00	21.68	-0.07	0.659	1.000	1.355	0.89
	WCDMA V	RMC12.2K	Right Tilted	4233	-	-	DSI1	Ant4	1	-	23.00	21.68	0.16	0.465	1.000	1.355	0.63
	WCDMA V	RMC12.2K	Left Cheek	4233	-	-	DSI1	Ant4	1	-	23.00	21.68	0.02	0.538	1.000	1.355	0.73
	WCDMA V	RMC12.2K	Left Tilted	4233	-	-	DSI1	Ant4	1	-	23.00	21.68	0.06	0.449	1.000	1.355	0.61
	WCDMA V	RMC12.2K	Right Cheek	4132	-	-	DSI1	Ant4	1	-	23.00	21.63	0.05	0.523	1.000	1.371	0.72



BUREAU VERITAS

FCC SAR Test Report



Certificate #6613.01

Plot No.	Band	Mode	Test Position	Ch.	RB#	RB Offset	Power State	Antenna	Sample	Duty Cycle %	Max. Tune-up Power (dBm)	Measured Conducted Power (dBm)	Power Drift (dB)	Measured SAR-1g (W/kg)	Duty Cycle Scaling Factor	Tune-up Scaling Factor	Scaled SAR-1g (W/kg)
	WCDMA V	RMC12.2K	Right Cheek	4182	-	-	DS11	Ant4	1	-	23.00	21.65	0.14	0.543	1.000	1.365	0.74
	LTE 2	QPSK20M	Right Cheek	18700	1	50	DS1-1	Ant1	1	-	25.50	24.11	-0.05	0.216	1.000	1.377	0.30
	LTE 2	QPSK20M	Right Tilted	18700	1	50	DS1-1	Ant1	1	-	25.50	24.11	-0.02	0.135	1.000	1.377	0.19
	LTE 2	QPSK20M	Left Cheek	18700	1	50	DS1-1	Ant1	1	-	25.50	24.11	0.00	0.200	1.000	1.377	0.28
	LTE 2	QPSK20M	Left Tilted	18700	1	50	DS1-1	Ant1	1	-	25.50	24.11	0.05	0.204	1.000	1.377	0.28
	LTE 2	QPSK20M	Right Cheek	18700	50	25	DS1-1	Ant1	1	-	24.50	23.05	0.16	0.175	1.000	1.396	0.24
	LTE 2	QPSK20M	Right Tilted	18700	50	25	DS1-1	Ant1	1	-	24.50	23.05	0.07	0.108	1.000	1.396	0.15
	LTE 2	QPSK20M	Left Cheek	18700	50	25	DS1-1	Ant1	1	-	24.50	23.05	0.08	0.157	1.000	1.396	0.22
	LTE 2	QPSK20M	Left Tilted	18700	50	25	DS1-1	Ant1	1	-	24.50	23.05	0.13	0.159	1.000	1.396	0.22
	LTE 2	QPSK20M	Right Cheek	18700	1	50	DS1-1	Ant4	1	-	15.50	14.30	0.05	0.333	1.000	1.318	0.44
	LTE 2	QPSK20M	Right Tilted	18700	1	50	DS1-1	Ant4	1	-	15.50	14.30	0.05	0.383	1.000	1.318	0.50
	LTE 2	QPSK20M	Left Cheek	18700	1	50	DS1-1	Ant4	1	-	15.50	14.30	0.09	0.219	1.000	1.318	0.29
	LTE 2	QPSK20M	Left Tilted	18700	1	50	DS1-1	Ant4	1	-	15.50	14.30	0.07	0.257	1.000	1.318	0.34
	LTE 2	QPSK20M	Right Cheek	18700	50	25	DS1-1	Ant4	1	-	15.50	13.93	0.19	0.330	1.000	1.435	0.47
6	LTE 2	QPSK20M	Right Tilted	18700	50	25	DS1-1	Ant4	1	-	15.50	13.93	0.06	0.440	1.000	1.435	0.63
	LTE 2	QPSK20M	Left Cheek	18700	50	25	DS1-1	Ant4	1	-	15.50	13.93	0.15	0.218	1.000	1.435	0.31
	LTE 2	QPSK20M	Left Tilted	18700	50	25	DS1-1	Ant4	1	-	15.50	13.93	0.07	0.255	1.000	1.435	0.37
	LTE 5	QPSK10M	Right Cheek	20600	1	24	DS1-1	Ant1	1	-	25.50	24.44	-0.02	0.179	1.000	1.276	0.23
	LTE 5	QPSK10M	Right Tilted	20600	1	24	DS1-1	Ant1	1	-	25.50	24.44	0.10	0.082	1.000	1.276	0.10
	LTE 5	QPSK10M	Left Cheek	20600	1	24	DS1-1	Ant1	1	-	25.50	24.44	-0.04	0.198	1.000	1.276	0.25
	LTE 5	QPSK10M	Left Tilted	20600	1	24	DS1-1	Ant1	1	-	25.50	24.44	0.07	0.087	1.000	1.276	0.11
	LTE 5	QPSK10M	Right Cheek	20600	25	12	DS1-1	Ant1	1	-	24.50	23.43	0.12	0.143	1.000	1.279	0.18
	LTE 5	QPSK10M	Right Tilted	20600	25	12	DS1-1	Ant1	1	-	24.50	23.43	0.13	0.067	1.000	1.279	0.09
	LTE 5	QPSK10M	Left Cheek	20600	25	12	DS1-1	Ant1	1	-	24.50	23.43	0.05	0.133	1.000	1.279	0.17
	LTE 5	QPSK10M	Left Tilted	20600	25	12	DS1-1	Ant1	1	-	24.50	23.43	0.02	0.069	1.000	1.279	0.09
	LTE 5	QPSK10M	Right Cheek	20600	1	24	DS1-1	Ant4	1	-	23.00	21.57	0.20	0.611	1.000	1.390	0.85
	LTE 5	QPSK10M	Right Tilted	20600	1	24	DS1-1	Ant4	1	-	23.00	21.57	-0.07	0.466	1.000	1.390	0.65
	LTE 5	QPSK10M	Left Cheek	20600	1	24	DS1-1	Ant4	1	-	23.00	21.57	0.03	0.534	1.000	1.390	0.74
	LTE 5	QPSK10M	Left Tilted	20600	1	24	DS1-1	Ant4	1	-	23.00	21.57	0.07	0.463	1.000	1.390	0.64
7	LTE 5	QPSK10M	Right Cheek	20600	25	12	DS1-1	Ant4	1	-	23.00	21.41	-0.03	0.648	1.000	1.442	0.93
	LTE 5	QPSK10M	Right Tilted	20600	25	12	DS1-1	Ant4	1	-	23.00	21.41	0.05	0.469	1.000	1.442	0.68
	LTE 5	QPSK10M	Left Cheek	20600	25	12	DS1-1	Ant4	1	-	23.00	21.41	-0.06	0.536	1.000	1.442	0.77
	LTE 5	QPSK10M	Left Tilted	20600	25	12	DS1-1	Ant4	1	-	23.00	21.41	0.05	0.465	1.000	1.442	0.67
	LTE 5	QPSK10M	Right Cheek	20450	1	24	DS1-1	Ant4	1	-	23.00	21.49	-0.03	0.517	1.000	1.416	0.73
	LTE 5	QPSK10M	Right Tilted	20525	1	24	DS1-1	Ant4	1	-	23.00	21.56	0.02	0.532	1.000	1.393	0.74
	LTE 5	QPSK10M	Right Cheek	20450	25	12	DS1-1	Ant4	1	-	23.00	21.37	0.02	0.522	1.000	1.455	0.76
	LTE 5	QPSK10M	Right Cheek	20525	25	12	DS1-1	Ant4	1	-	23.00	21.38	-0.04	0.531	1.000	1.452	0.77
	LTE 5	QPSK10M	Right Cheek	20600	50	0	DS1-1	Ant4	1	-	23.00	21.28	0.07	0.529	1.000	1.486	0.79
	LTE 7	QPSK20M	Right Cheek	20850	1	50	DS1-1	Ant1	1	-	25.00	24.18	-0.09	0.072	1.000	1.208	0.09
	LTE 7	QPSK20M	Right Tilted	20850	1	50	DS1-1	Ant1	1	-	25.00	24.18	0.00	0.000	1.000	1.208	0.00
	LTE 7	QPSK20M	Left Cheek	20850	1	50	DS1-1	Ant1	1	-	25.00	24.18	0.05	0.063	1.000	1.208	0.08
	LTE 7	QPSK20M	Left Tilted	20850	1	50	DS1-1	Ant1	1	-	25.00	24.18	0.00	0.000	1.000	1.208	0.00
	LTE 7	QPSK20M	Right Cheek	20850	50	25	DS1-1	Ant1	1	-	24.00	23.23	0.03	0.073	1.000	1.194	0.09
	LTE 7	QPSK20M	Right Tilted	20850	50	25	DS1-1	Ant1	1	-	24.00	23.23	0.00	0.000	1.000	1.194	0.00
	LTE 7	QPSK20M	Left Cheek	20850	50	25	DS1-1	Ant1	1	-	24.00	23.23	-0.04	0.048	1.000	1.194	0.06
	LTE 7	QPSK20M	Left Tilted	20850	50	25	DS1-1	Ant1	1	-	24.00	23.23	0.00	0.000	1.000	1.194	0.00
	LTE 7	QPSK20M	Right Cheek	20850	1	50	DS1-1	Ant4	1	-	16.00	14.45	0.15	0.362	1.000	1.429	0.52
8	LTE 7	QPSK20M	Right Tilted	20850	1	50	DS1-1	Ant4	1	-	16.00	14.45	-0.02	0.512	1.000	1.429	0.73
	LTE 7	QPSK20M	Left Cheek	20850	1	50	DS1-1	Ant4	1	-	16.00	14.45	0.06	0.318	1.000	1.429	0.45
	LTE 7	QPSK20M	Left Tilted	20850	1	50	DS1-1	Ant4	1	-	16.00	14.45	-0.04	0.352	1.000	1.429	0.50
	LTE 7	QPSK20M	Right Cheek	20850	50	50	DS1-1	Ant4	1	-	16.00	14.42	0.03	0.360	1.000	1.439	0.52
	LTE 7	QPSK20M	Right Tilted	20850	50	50	DS1-1	Ant4	1	-	16.00	14.42	-0.06	0.429	1.000	1.439	0.62
	LTE 7	QPSK20M	Left Cheek	20850	50	50	DS1-1	Ant4	1	-	16.00	14.42	0.11	0.315	1.000	1.439	0.45
	LTE 7	QPSK20M	Left Tilted	20850	50	50	DS1-1	Ant4	1	-	16.00	14.42	0.04	0.349	1.000	1.439	0.50
	LTE 38	QPSK20M	Right Cheek	38000	1	50	DS1-1	Ant1	1	62.90	25.50	24.03	0.10	0.040	1.006	1.403	0.06
	LTE 38	QPSK20M	Right Tilted	38000	1	50	DS1-1	Ant1	1	62.90	25.50	24.03	0.00	0.000	1.006	1.403	0.00
	LTE 38	QPSK20M	Left Cheek	38000	1	50	DS1-1	Ant1	1	62.90	25.50	24.03	0.14	0.038	1.006	1.403	0.05
	LTE 38	QPSK20M	Left Tilted	38000	1	50	DS1-1	Ant1	1	62.90	25.50	24.03	0.00	0.000	1.006	1.403	0.00
	LTE 38	QPSK20M	Right Cheek	38000	50	25	DS1-1	Ant1	1	62.90	24.50	22.96	-0.07	0.039	1.006	1.426	0.06
	LTE 38	QPSK20M	Right Tilted	38000	50	25	DS1-1	Ant1	1	62.90	24.50	22.96	0.00	0.000	1.006	1.426	0.00
	LTE 38	QPSK20M	Left Cheek	38000	50	25	DS1-1	Ant1	1	62.90	24.50	22.96	0.13	0.039	1.006	1.426	0.06
	LTE 38	QPSK20M	Left Tilted	38000	50	25	DS1-1	Ant1	1	62.90	24.50	22.96	0.00	0.000	1.006	1.426	0.00
	LTE 38	QPSK20M	Right Cheek	38000	1	50	DS1-1	Ant4	1	62.90	18.50	17.16	0.08	0.330	1.006	1.361	0.45
	LTE 38	QPSK20M	Right Tilted	38000	1	50	DS1-1	Ant4	1	62.90	18.50	17.16	0.13	0.383	1.006	1.361	0.52
	LTE 38	QPSK20M	Left Cheek	38000	1	50	DS1-1	Ant4	1	62.90	18.50	17.16	0.06	0.261	1.006	1.361	0.36
	LTE 38	QPSK20M	Left Tilted	38000	1	50	DS1-1	Ant4	1	62.90	18.50	17.16	-0.14	0.316	1.006	1.361	0.43
	LTE 38	QPSK20M	Right Cheek	38000	50	25	DS1-1	Ant4	1	62.90	18.50	17.08	0.05	0.330	1.006	1.387	0.46
9	LTE 38	QPSK20M	Right Tilted	38000	50	25	DS1-1	Ant4	1	62.90	18.50	17.08	-0.01	0.450	1.006	1.387	0.63
	LTE 38	QPSK20M	Left Cheek	38000	50	25	DS1-1	Ant4	1	62.90	18.50	17.08	-0.12	0.312	1.006	1.387	0.44
	LTE 38	QPSK20M	Left Tilted	38000	50	25	DS1-1	Ant4	1	62.90	18.50	17.08	0.04	0.259	1.006	1.387	0.36
	LTE 41	QPSK20M	Right Cheek	39750	1	50	DS1-1	Ant1	1	62.90	25.00	23.96	-0.09	0.036	1.006	1.271	0.05
	LTE 41	QPSK20M	Right Tilted	39750	1	50	DS1-1	Ant1	1	62.90	25.00	23.96	0.00	0.000	1.006	1.271	0.00
	LTE 41	QPSK20M	Left Cheek	39750	1	50	DS1-1	Ant1	1	62.90	25.00	23.96	0.13	0.034	1.006	1.271	0.04
	LTE 41	QPSK20M	Left Tilted	39750	1	50	DS1-1	Ant1	1	62.90	25.00	23.96	0.00	0.000	1.006	1.271	0.00
	LTE 41	QPSK20M	Right Cheek	39750	50	25	DS1-1	Ant1	1	62.90	24.00	22.86	-0.07	0.033	1.006	1.300	0.04



BUREAU VERITAS

FCC SAR Test Report



Certificate #6613.01

Plot No.	Band	Mode	Test Position	Ch.	RB#	RB Offset	Power State	Antenna	Sample	Duty Cycle %	Max. Tune-up Power (dBm)	Measured Conducted Power (dBm)	Power Drift (dB)	Measured SAR-1g (W/kg)	Duty Cycle Scaling Factor	Tune-up Scaling Factor	Scaled SAR-1g (W/kg)
	LTE 41	QPSK20M	Right Tilted	39750	50	25	DSI-1	Ant1	1	62.90	24.00	22.86	0.00	0.000	1.006	1.300	0.00
	LTE 41	QPSK20M	Left Cheek	39750	50	25	DSI-1	Ant1	1	62.90	24.00	22.86	0.00	0.000	1.006	1.300	0.00
	LTE 41	QPSK20M	Left Tilted	39750	50	25	DSI-1	Ant1	1	62.90	24.00	22.86	0.00	0.000	1.006	1.300	0.00
	LTE 41	QPSK20M	Right Cheek	39750	1	50	DSI-1	Ant4	1	62.90	18.50	17.21	0.05	0.387	1.006	1.346	0.52
	LTE 41	QPSK20M	Right Tilted	39750	1	50	DSI-1	Ant4	1	62.90	18.50	17.21	0.06	0.466	1.006	1.346	0.63
	LTE 41	QPSK20M	Left Cheek	39750	1	50	DSI-1	Ant4	1	62.90	18.50	17.21	0.03	0.323	1.006	1.346	0.44
	LTE 41	QPSK20M	Left Tilted	39750	1	50	DSI-1	Ant4	1	62.90	18.50	17.21	0.09	0.367	1.006	1.346	0.50
	LTE 41	QPSK20M	Right Cheek	39750	50	25	DSI-1	Ant4	1	62.90	18.50	16.95	0.08	0.383	1.006	1.429	0.55
	LTE 41	QPSK20M	Right Tilted	39750	50	25	DSI-1	Ant4	1	62.90	18.50	16.95	0.04	0.463	1.006	1.429	0.67
	LTE 41	QPSK20M	Left Cheek	39750	50	25	DSI-1	Ant4	1	62.90	18.50	16.95	0.02	0.321	1.006	1.429	0.46
	LTE 41	QPSK20M	Left Tilted	39750	50	25	DSI-1	Ant4	1	62.90	18.50	16.95	0.05	0.366	1.006	1.429	0.53
	LTE 41	QPSK20M	Right Tilted	40185	1	50	DSI-1	Ant4	1	62.90	18.50	17.17	0.09	0.435	1.006	1.358	0.59
	LTE 41	QPSK20M	Right Tilted	40620	1	50	DSI-1	Ant4	1	62.90	18.50	17.19	0.05	0.390	1.006	1.352	0.53
	LTE 41	QPSK20M	Right Tilted	41055	1	50	DSI-1	Ant4	1	62.90	18.50	17.08	0.12	0.337	1.006	1.387	0.47
	LTE 41	QPSK20M	Right Tilted	41490	1	50	DSI-1	Ant4	1	62.90	18.50	17.06	0.18	0.296	1.006	1.393	0.41
	LTE 41	QPSK20M	Right Tilted	40185	50	25	DSI-1	Ant4	1	62.90	18.50	16.83	-0.02	0.431	1.006	1.469	0.64
	LTE 41	QPSK20M	Right Tilted	40620	50	25	DSI-1	Ant4	1	62.90	18.50	16.94	-0.04	0.387	1.006	1.432	0.56
	LTE 41	QPSK20M	Right Tilted	41055	50	25	DSI-1	Ant4	1	62.90	18.50	16.82	-0.06	0.335	1.006	1.472	0.50
	LTE 41	QPSK20M	Right Tilted	41490	50	25	DSI-1	Ant4	1	62.90	18.50	16.88	0.01	0.290	1.006	1.452	0.42
10	LTE 41	QPSK20M	Right Tilted	39750	100	0	DSI-1	Ant4	1	62.90	18.50	17.05	-0.09	0.561	1.006	1.396	0.79
	LTE 66	QPSK20M	Right Cheek	132322	1	50	DSI-1	Ant1	1	-	25.50	24.26	-0.02	0.137	1.000	1.330	0.18
	LTE 66	QPSK20M	Right Tilted	132322	1	50	DSI-1	Ant1	1	-	25.50	24.26	0.15	0.084	1.000	1.330	0.11
	LTE 66	QPSK20M	Left Cheek	132322	1	50	DSI-1	Ant1	1	-	25.50	24.26	-0.04	0.108	1.000	1.330	0.14
	LTE 66	QPSK20M	Left Tilted	132322	1	50	DSI-1	Ant1	1	-	25.50	24.26	0.12	0.099	1.000	1.330	0.13
	LTE 66	QPSK20M	Right Cheek	132322	50	25	DSI-1	Ant1	1	-	24.50	23.29	0.13	0.125	1.000	1.321	0.17
	LTE 66	QPSK20M	Right Tilted	132322	50	25	DSI-1	Ant1	1	-	24.50	23.29	-0.16	0.069	1.000	1.321	0.09
	LTE 66	QPSK20M	Left Cheek	132322	50	25	DSI-1	Ant1	1	-	24.50	23.29	-0.04	0.085	1.000	1.321	0.11
	LTE 66	QPSK20M	Left Tilted	132322	50	25	DSI-1	Ant1	1	-	24.50	23.29	-0.07	0.080	1.000	1.321	0.11
	LTE 66	QPSK20M	Right Cheek	132322	1	50	DSI-1	Ant4	1	-	15.50	14.16	0.14	0.511	1.000	1.361	0.70
	LTE 66	QPSK20M	Right Tilted	132322	1	50	DSI-1	Ant4	1	-	15.50	14.16	0.01	0.594	1.000	1.361	0.81
	LTE 66	QPSK20M	Left Cheek	132322	1	50	DSI-1	Ant4	1	-	15.50	14.16	0.03	0.339	1.000	1.361	0.46
	LTE 66	QPSK20M	Left Tilted	132322	1	50	DSI-1	Ant4	1	-	15.50	14.16	0.02	0.375	1.000	1.361	0.51
	LTE 66	QPSK20M	Right Cheek	132322	50	25	DSI-1	Ant4	1	-	15.50	13.97	-0.08	0.510	1.000	1.422	0.73
	LTE 66	QPSK20M	Right Tilted	132322	50	25	DSI-1	Ant4	1	-	15.50	13.97	0.03	0.578	1.000	1.422	0.82
	LTE 66	QPSK20M	Left Cheek	132322	50	25	DSI-1	Ant4	1	-	15.50	13.97	0.16	0.338	1.000	1.422	0.48
	LTE 66	QPSK20M	Left Tilted	132322	50	25	DSI-1	Ant4	1	-	15.50	13.97	0.14	0.376	1.000	1.422	0.53
	LTE 66	QPSK20M	Right Tilted	132072	1	50	DSI-1	Ant4	1	-	15.50	14.12	0.07	0.511	1.000	1.374	0.70
	LTE 66	QPSK20M	Right Tilted	132572	1	50	DSI-1	Ant4	1	-	15.50	13.97	0.05	0.490	1.000	1.422	0.70
11	LTE 66	QPSK20M	Right Tilted	132072	50	25	DSI-1	Ant4	1	-	15.50	13.95	0.01	0.685	1.000	1.429	0.98
	LTE 66	QPSK20M	Right Tilted	132572	50	25	DSI-1	Ant4	1	-	15.50	13.93	-0.09	0.540	1.000	1.435	0.78
	LTE 66	QPSK20M	Right Tilted	132322	100	0	DSI-1	Ant4	1	-	15.50	13.99	0.11	0.574	1.000	1.416	0.81
	WLAN2.4G	802.11b	Right Cheek	11	-	-	DSI-1	Ant2	1	99.52	14.50	13.34	0.14	0.129	1.005	1.306	0.17
	WLAN2.4G	802.11b	Right Tilted	11	-	-	DSI-1	Ant2	1	99.52	14.50	13.34	-0.07	0.120	1.005	1.306	0.16
12	WLAN2.4G	802.11b	Left Cheek	11	-	-	DSI-1	Ant2	1	99.52	14.50	13.34	-0.08	0.335	1.005	1.306	0.44
	WLAN2.4G	802.11b	Left Tilted	11	-	-	DSI-1	Ant2	1	99.52	14.50	13.34	0.15	0.247	1.005	1.306	0.32
	WLAN2.4G	802.11b	Left Cheek	11	-	-	DSI-1	Ant2	2	99.52	14.50	13.34	-0.07	0.208	1.005	1.306	0.27
	WLAN2.4G	802.11b	Left Cheek	11	-	-	DSI-1	Ant2	3	99.52	14.50	13.34	0.11	0.233	1.005	1.306	0.31
	WLAN2.4G	802.11b	Left Cheek	11	-	-	DSI-1	Ant2	4	99.52	14.50	13.34	0.05	0.285	1.005	1.306	0.37
	WLAN5G	802.11n-HT20	Right Cheek	64	-	-	DSI-1	Ant2	1	93.00	9.50	8.46	0.11	0.106	1.075	1.271	0.14
	WLAN5G	802.11n-HT20	Right Tilted	64	-	-	DSI-1	Ant2	1	93.00	9.50	8.46	0.06	0.128	1.075	1.271	0.17
	WLAN5G	802.11n-HT20	Left Cheek	64	-	-	DSI-1	Ant2	1	93.00	9.50	8.46	0.13	0.178	1.075	1.271	0.24
13	WLAN5G	802.11n-HT20	Left Tilted	64	-	-	DSI-1	Ant2	1	93.00	9.50	8.46	0.11	0.311	1.075	1.271	0.42
	WLAN5G	802.11n-HT20	Right Cheek	140	-	-	DSI-1	Ant2	1	93.00	9.50	8.56	0.07	0.056	1.075	1.242	0.07
	WLAN5G	802.11n-HT20	Right Tilted	140	-	-	DSI-1	Ant2	1	93.00	9.50	8.56	0.14	0.063	1.075	1.242	0.08
	WLAN5G	802.11n-HT20	Left Cheek	140	-	-	DSI-1	Ant2	1	93.00	9.50	8.56	-0.05	0.078	1.075	1.242	0.10
14	WLAN5G	802.11n-HT20	Left Tilted	140	-	-	DSI-1	Ant2	1	93.00	9.50	8.56	0.04	0.114	1.075	1.242	0.15
	WLAN5G	802.11ac-VHT80	Right Cheek	155	-	-	DSI-1	Ant2	1	87.70	9.50	8.65	0.06	0.035	1.140	1.216	0.05
	WLAN5G	802.11ac-VHT80	Right Tilted	155	-	-	DSI-1	Ant2	1	87.70	9.50	8.65	0.13	0.046	1.140	1.216	0.06
	WLAN5G	802.11ac-VHT80	Left Cheek	155	-	-	DSI-1	Ant2	1	87.70	9.50	8.65	0.17	0.046	1.140	1.216	0.06
15	WLAN5G	802.11ac-VHT80	Left Tilted	155	-	-	DSI-1	Ant2	1	87.70	9.50	8.65	0.19	0.078	1.140	1.216	0.11
	BT	GFSK	Right Cheek	78	-	-	DSI-1	Ant2	1	76.70	11.00	9.98	0.03	0.052	1.304	1.265	0.09
	BT	GFSK	Right Tilted	78	-	-	DSI-1	Ant2	1	76.70	11.00	9.98	-0.02	0.052	1.304	1.265	0.09
16	BT	GFSK	Left Cheek	78	-	-	DSI-1	Ant2	1	76.70	11.00	9.98	0.08	0.149	1.304	1.265	0.25
	BT	GFSK	Left Tilted	78	-	-	DSI-1	Ant2	1	76.70	11.00	9.98	0.11	0.101	1.304	1.265	0.17



BUREAU VERITAS

FCC SAR Test Report



Certificate #6613.01

4.6.3 SAR Results for Body-worn Exposure Condition (Separation Distance is 1.0 cm Gap)

Plot No.	Band	Mode	Test Position	Separation Distance (cm)	Ch.	RB#	RB Offset	Power State	Antenna	Sample	Duty Cycle %	Max. Tune-up Power (dBm)	Measured Conducted Power (dBm)	Power Drift (dB)	Measured SAR-1g (W/kg)	Duty Cycle Scaling Factor	Tune-up Scaling Factor	Scaled SAR-1g (W/kg)
	GSM850	GPRS 4Tx Slot	Front Face	1	251	-	-	DSI-3/4	Ant1	1	-	27.50	26.59	0.07	0.192	1.000	1.233	0.24
	GSM850	GPRS 4Tx Slot	Rear Face	1	251	-	-	DSI-3/4	Ant1	1	-	27.50	26.59	0.03	0.287	1.000	1.233	0.35
	GSM850	GPRS 4Tx Slot	Front Face	1	251			DSI-4	Ant4	1	-	27.50	26.54	0.16	0.192	1.000	1.247	0.24
17	GSM850	GPRS 4Tx Slot	Rear Face	1	251			DSI-4	Ant4	1	-	27.50	26.54	0.07	0.335	1.000	1.247	0.42
	GSM1900	GPRS 1Tx Slot	Front Face	1	661	-	-	DSI-3/4	Ant1	1	-	30.50	29.31	0.11	0.273	1.000	1.315	0.36
	GSM1900	GPRS 1Tx Slot	Rear Face	1	661	-	-	DSI-3/4	Ant1	1	-	30.50	29.31	0.04	0.370	1.000	1.315	0.49
	GSM1900	GPRS 1Tx Slot	Front Face	1	810			DSI-4	Ant4	1	-	27.00	26.05	-0.09	0.280	1.000	1.245	0.35
18	GSM1900	GPRS 1Tx Slot	Rear Face	1	810			DSI-4	Ant4	1	-	27.00	26.05	0.02	0.662	1.000	1.245	0.82
	GSM1900	GPRS 1Tx Slot	Front Face	1.1	810			DSI-2	Ant4	1	-	30.50	29.41	-0.04	0.483	1.000	1.285	0.62
	GSM1900	GPRS 1Tx Slot	Rear Face	1.7	810			DSI-2	Ant4	1	-	30.50	29.41	0.01	0.524	1.000	1.285	0.67
	WCDMA II	RMC12.2K	Front Face	1	9538	-	-	DSI-3/4	Ant1	1	-	22.00	20.89	0.09	0.411	1.000	1.291	0.53
	WCDMA II	RMC12.2K	Rear Face	1	9538	-	-	DSI-3/4	Ant1	1	-	22.00	20.89	0.05	0.497	1.000	1.291	0.64
	WCDMA II	RMC12.2K	Front Face	1.1	9538	-	-	DSI-2	Ant1	1	-	25.00	23.95	0.06	0.796	1.000	1.274	1.01
	WCDMA II	RMC12.2K	Rear Face	1.7	9538	-	-	DSI-2	Ant1	1	-	25.00	23.95	0.04	0.522	1.000	1.274	0.66
	WCDMA II	RMC12.2K	Front Face	1.1	9262	-	-	DSI-2	Ant1	1	-	25.00	23.71	0.14	0.520	1.000	1.346	0.70
	WCDMA II	RMC12.2K	Front Face	1.1	9400	-	-	DSI-2	Ant1	1	-	25.00	23.82	0.19	0.634	1.000	1.312	0.83
	WCDMA II	RMC12.2K	Front Face	1	9538			DSI-4	Ant4	1	-	18.50	17.51	0.12	0.337	1.000	1.256	0.42
	WCDMA II	RMC12.2K	Rear Face	1	9538			DSI-4	Ant4	1	-	18.50	17.51	0.09	0.726	1.000	1.256	0.91
	WCDMA II	RMC12.2K	Rear Face	1	9262			DSI-4	Ant4	1	-	18.50	17.41	0.05	0.314	1.000	1.285	0.40
	WCDMA II	RMC12.2K	Rear Face	1	9400			DSI-4	Ant4	1	-	18.50	17.45	-0.01	0.479	1.000	1.274	0.61
19	WCDMA II	RMC12.2K	Front Face	1.1	9538			DSI-2	Ant4	1	-	22.50	21.29	0.04	0.801	1.000	1.321	1.06
	WCDMA II	RMC12.2K	Rear Face	1.7	9538			DSI-2	Ant4	1	-	22.50	21.29	0.13	0.624	1.000	1.321	0.82
	WCDMA II	RMC12.2K	Front Face	1.1	9262			DSI-2	Ant4	1	-	22.50	21.03	0.11	0.357	1.000	1.403	0.50
	WCDMA II	RMC12.2K	Front Face	1.1	9400			DSI-2	Ant4	1	-	22.50	21.15	-0.15	0.561	1.000	1.365	0.77
	WCDMA II	RMC12.2K	Rear Face	1.7	9262			DSI-2	Ant4	1	-	22.50	21.03	0.09	0.315	1.000	1.403	0.44
	WCDMA II	RMC12.2K	Rear Face	1.7	9400			DSI-2	Ant4	1	-	22.50	21.15	0.08	0.468	1.000	1.365	0.64
	WCDMA IV	RMC12.2K	Front Face	1	1413	-	-	DSI-3/4	Ant1	1	-	21.50	20.25	0.13	0.212	1.000	1.334	0.28
	WCDMA IV	RMC12.2K	Rear Face	1	1413	-	-	DSI-3/4	Ant1	1	-	21.50	20.25	0.04	0.337	1.000	1.334	0.45
	WCDMA IV	RMC12.2K	Front Face	1.1	1413	-	-	DSI-2	Ant1	1	-	25.50	24.34	-0.04	0.493	1.000	1.306	0.64
	WCDMA IV	RMC12.2K	Rear Face	1.7	1413	-	-	DSI-2	Ant1	1	-	25.50	24.34	0.07	0.389	1.000	1.306	0.51
	WCDMA IV	RMC12.2K	Front Face	1	1312			DSI-4	Ant4	1	-	19.00	17.92	0.15	0.326	1.000	1.282	0.42
	WCDMA IV	RMC12.2K	Rear Face	1	1312			DSI-4	Ant4	1	-	19.00	17.92	0.04	0.553	1.000	1.282	0.71
	WCDMA IV	RMC12.2K	Front Face	1.1	1312			DSI-2	Ant4	1	-	22.50	21.40	0.09	0.648	1.000	1.288	0.83
	WCDMA IV	RMC12.2K	Rear Face	1.7	1312			DSI-2	Ant4	1	-	22.50	21.40	-0.13	0.406	1.000	1.288	0.52
20	WCDMA IV	RMC12.2K	Front Face	1.1	1413			DSI-2	Ant4	1	-	22.50	21.34	-0.02	0.761	1.000	1.306	0.99
	WCDMA IV	RMC12.2K	Front Face	1.1	1513			DSI-2	Ant4	1	-	22.50	21.24	-0.05	0.619	1.000	1.337	0.83
	WCDMA V	RMC12.2K	Front Face	1	4233	-	-	DSI-3/4	Ant1	1	-	25.50	24.29	-0.09	0.170	1.000	1.321	0.22
	WCDMA V	RMC12.2K	Rear Face	1	4233	-	-	DSI-3/4	Ant1	1	-	25.50	24.29	0.07	0.235	1.000	1.321	0.31
	WCDMA V	RMC12.2K	Front Face	1	4233			DSI-4	Ant4	1	-	25.50	24.25	0.17	0.223	1.000	1.334	0.30
21	WCDMA V	RMC12.2K	Rear Face	1	4233			DSI-4	Ant4	1	-	25.50	24.25	0.09	0.401	1.000	1.334	0.53
	LTE 2	QPSK20M	Front Face	1	18700	1	50	DSI-3/4	Ant1	1	-	22.00	20.58	0.12	0.293	1.000	1.387	0.41
	LTE 2	QPSK20M	Rear Face	1	18700	1	50	DSI-3/4	Ant1	1	-	22.00	20.58	-0.06	0.458	1.000	1.387	0.64
	LTE 2	QPSK20M	Front Face	1	18700	50	25	DSI-3/4	Ant1	1	-	22.00	20.38	0.18	0.297	1.000	1.452	0.43
	LTE 2	QPSK20M	Rear Face	1	18700	50	25	DSI-3/4	Ant1	1	-	22.00	20.38	-0.09	0.397	1.000	1.452	0.58
	LTE 2	QPSK20M	Front Face	1.1	18700	1	50	DSI-2	Ant1	1	-	25.00	23.50	-0.02	0.647	1.000	1.413	0.91
	LTE 2	QPSK20M	Rear Face	1.7	18700	1	50	DSI-2	Ant1	1	-	25.00	23.50	-0.08	0.369	1.000	1.413	0.52
	LTE 2	QPSK20M	Front Face	1.1	18700	50	25	DSI-2	Ant1	1	-	24.50	22.89	0.09	0.456	1.000	1.449	0.66
	LTE 2	QPSK20M	Rear Face	1.7	18700	50	25	DSI-2	Ant1	1	-	24.50	22.89	0.13	0.325	1.000	1.449	0.47
	LTE 2	QPSK20M	Front Face	1.1	18900	1	50	DSI-2	Ant1	1	-	25.00	23.44	0.12	0.616	1.000	1.432	0.88
	LTE 2	QPSK20M	Front Face	1.1	19100	1	50	DSI-2	Ant1	1	-	25.00	23.43	-0.03	0.749	1.000	1.435	1.08
	LTE 2	QPSK20M	Front Face	1.1	18700	100	0	DSI-2	Ant1	1	-	25.00	22.91	0.05	0.460	1.000	1.618	0.74
	LTE 2	QPSK20M	Front Face	1	18700	1	50	DSI-4	Ant4	1	-	18.50	17.35	0.04	0.176	1.000	1.303	0.23
	LTE 2	QPSK20M	Rear Face	1	18700	1	50	DSI-4	Ant4	1	-	18.50	17.35	0.11	0.332	1.000	1.303	0.43
	LTE 2	QPSK20M	Front Face	1	18700	50	25	DSI-4	Ant4	1	-	18.50	17.01	-0.14	0.177	1.000	1.409	0.25
	LTE 2	QPSK20M	Rear Face	1	18700	50	25	DSI-4	Ant4	1	-	18.50	17.01	-0.03	0.331	1.000	1.409	0.47
	LTE 2	QPSK20M	Rear Face	1	18900	1	50	DSI-4	Ant4	1	-	18.50	17.20	0.07	0.462	1.000	1.349	0.62
	LTE 2	QPSK20M	Rear Face	1	19100	1	50	DSI-4	Ant4	1	-	18.50	17.33	0.04	0.700	1.000	1.309	0.92
	LTE 2	QPSK20M	Rear Face	1	18900	50	25	DSI-4	Ant4	1	-	18.50	16.90	0.13	0.459	1.000	1.445	0.66
	LTE 2	QPSK20M	Rear Face	1	19100	50	25	DSI-4	Ant4	1	-	18.50	16.84	-0.09	0.570	1.000	1.466	0.84
	LTE 2	QPSK20M	Rear Face	1	18700	100	0	DSI-4	Ant4	1	-	18.50	16.96	0.09	0.318	1.000	1.426	0.45
	LTE 2	QPSK20M	Front Face	1.1	18700	1	50	DSI-2	Ant4	1	-	22.50	21.11	0.18	0.384	1.000	1.377	0.53
	LTE 2	QPSK20M	Rear Face	1.7	18700	1	50	DSI-2	Ant4	1	-	22.50	21.11	0.00	0.327	1.000	1.377	0.45
	LTE 2	QPSK20M	Front Face	1.1	18700	50	25	DSI-2	Ant4	1	-	22.50	20.97	0.06	0.379	1.000	1.422	0.54
	LTE 2	QPSK20M	Rear Face	1.7	18700	50	25	DSI-2	Ant4	1	-	22.50	20.97	0.14	0.324	1.000	1.422	0.46
	LTE 2	QPSK20M	Front Face	1.1	18900	1	50	DSI-2	Ant4	1	-	22.50	21.07	0.02	0.544	1.000	1.390	0.76
22	LTE 2	QPSK20M	Front Face	1.1	19100	1	50	DSI-2	Ant4	1	-	22.50	21.03	0.09	0.772	1.000	1.403	1.08
	LTE 2	QPSK20M	Front Face	1.1	18700	100	0	DSI-2	Ant4	1	-	22.50	20.96	-0.13	0.368	1.000	1.426	0.52
	LTE 5	QPSK10M	Front Face	1	20600	1	24	DSI-3/4	Ant1	1	-	25.50	24.44	0.13	0.229	1.000	1.276	0.29
	LTE 5	QPSK10M	Rear Face	1	20600	1	24	DSI-3/4	Ant1	1	-	25.50	24.44	0.05	0.386	1.000	1.276	0.49
	LTE 5	QPSK10M	Front Face	1	20600	25	12	DSI-3/4	Ant1	1	-	24.50	23.43	-0.03	0.194	1.000	1.279	0.25
	LTE 5	QPSK10M	Rear Face	1	20600	25	12	DSI-3/4	Ant1	1	-	24.50	23.43	0.11	0.306	1.000	1.279	0.39



BUREAU VERITAS

FCC SAR Test Report



Certificate #6613.01

Plot No.	Band	Mode	Test Position	Separation Distance (cm)	Ch.	RB#	RB Offset	Power State	Antenna	Sample	Duty Cycle %	Max. Tune-up Power (dBm)	Measured Conducted Power (dBm)	Power Drift (dB)	Measured SAR-1g (W/kg)	Duty Cycle Scaling Factor	Tune-up Scaling Factor	Scaled SAR-1g (W/kg)		
23	LTE 5	QPSK10M	Front Face	1	20600	1	24	DSI-4	Ant4	1	-	25.50	24.21	0.09	0.258	1.000	1.346	0.35		
	LTE 5	QPSK10M	Rear Face	1	20600	1	24	DSI-4	Ant4	1	-	25.50	24.21	0.07	0.423	1.000	1.346	0.57		
	LTE 5	QPSK10M	Front Face	1	20600	25	12	DSI-4	Ant4	1	-	24.50	23.22	-0.04	0.208	1.000	1.343	0.28		
	LTE 5	QPSK10M	Rear Face	1	20600	25	12	DSI-4	Ant4	1	-	24.50	23.22	0.03	0.292	1.000	1.343	0.39		
	LTE 7	QPSK20M	Front Face	1	20850	1	50	DSI-3/4	Ant1	1	-	18.50	17.62	0.17	0.222	1.000	1.225	0.27		
	LTE 7	QPSK20M	Rear Face	1	20850	1	50	DSI-3/4	Ant1	1	-	18.50	17.62	-0.09	0.449	1.000	1.225	0.55		
	LTE 7	QPSK20M	Front Face	1	20850	50	25	DSI-3/4	Ant1	1	-	18.50	17.46	0.13	0.214	1.000	1.271	0.27		
	LTE 7	QPSK20M	Rear Face	1	20850	50	25	DSI-3/4	Ant1	1	-	18.50	17.46	0.09	0.372	1.000	1.271	0.47		
	LTE 7	QPSK20M	Front Face	1.1	20850	1	50	DSI-2	Ant1	1	-	24.00	22.96	0.02	0.675	1.000	1.271	0.86		
	LTE 7	QPSK20M	Rear Face	1.7	20850	1	50	DSI-2	Ant1	1	-	24.00	22.96	0.04	0.543	1.000	1.271	0.69		
	LTE 7	QPSK20M	Front Face	1.1	20850	50	25	DSI-2	Ant1	1	-	24.00	22.90	0.09	0.677	1.000	1.288	0.87		
	LTE 7	QPSK20M	Rear Face	1.7	20850	50	25	DSI-2	Ant1	1	-	24.00	22.90	0.05	0.545	1.000	1.288	0.70		
	LTE 7	QPSK20M	Front Face	1.1	21100	1	50	DSI-2	Ant1	1	-	24.00	22.88	-0.09	0.689	1.000	1.294	0.89		
	LTE 7	QPSK20M	Front Face	1.1	21350	1	50	DSI-2	Ant1	1	-	24.00	22.94	0.08	0.709	1.000	1.276	0.90		
	LTE 7	QPSK20M	Front Face	1.1	21100	50	25	DSI-2	Ant1	1	-	24.00	22.83	-0.18	0.697	1.000	1.309	0.91		
	24	LTE 7	QPSK20M	Front Face	1.1	21350	50	25	DSI-2	Ant1	1	-	24.00	22.84	-0.01	0.825	1.000	1.306	1.08	
		LTE 7	QPSK20M	Front Face	1.1	20850	100	0	DSI-2	Ant1	1	-	24.00	22.85	0.18	0.680	1.000	1.303	0.89	
		LTE 7	QPSK20M	Front Face	1.1	21350	50	25	DSI-2	Ant1	2	-	24.00	22.84	-0.07	0.755	1.000	1.306	0.99	
		LTE 7	QPSK20M	Front Face	1.1	21350	50	25	DSI-2	Ant1	3	-	24.00	22.84	0.04	0.784	1.000	1.306	1.02	
		LTE 7	QPSK20M	Front Face	1.1	21350	50	25	DSI-2	Ant1	4	-	24.00	22.84	0.12	0.767	1.000	1.306	1.00	
LTE 7		QPSK20M	Front Face	1	20850	1	50	DSI-4	Ant4	1	-	17.50	16.01	0.13	0.154	1.000	1.409	0.22		
LTE 7		QPSK20M	Rear Face	1	20850	1	50	DSI-4	Ant4	1	-	17.50	16.01	0.06	0.192	1.000	1.409	0.27		
LTE 7		QPSK20M	Front Face	1	20850	50	50	DSI-4	Ant4	1	-	17.50	15.94	-0.08	0.157	1.000	1.432	0.22		
LTE 7		QPSK20M	Rear Face	1	20850	50	50	DSI-4	Ant4	1	-	17.50	15.94	0.13	0.202	1.000	1.432	0.29		
LTE 7		QPSK20M	Front Face	1.1	20850	1	50	DSI-2	Ant4	1	-	23.50	21.97	-0.17	0.483	1.000	1.422	0.69		
LTE 7		QPSK20M	Rear Face	1.7	20850	1	50	DSI-2	Ant4	1	-	23.50	21.97	0.04	0.340	1.000	1.422	0.48		
LTE 7		QPSK20M	Front Face	1.1	20850	50	50	DSI-2	Ant4	1	-	23.50	21.89	0.09	0.490	1.000	1.449	0.71		
LTE 7		QPSK20M	Rear Face	1.7	20850	50	50	DSI-2	Ant4	1	-	23.50	21.89	0.12	0.333	1.000	1.449	0.48		
		LTE 38	QPSK20M	Front Face	1	38000	1	50	DSI-3/4	Ant1	1	62.90	20.00	18.87	0.06	0.216	1.006	1.297	0.28	
		LTE 38	QPSK20M	Rear Face	1	38000	1	50	DSI-3/4	Ant1	1	62.90	20.00	18.87	-0.07	0.334	1.006	1.297	0.44	
		LTE 38	QPSK20M	Front Face	1	38000	50	25	DSI-3/4	Ant1	1	62.90	20.00	18.79	-0.09	0.214	1.006	1.321	0.28	
	LTE 38	QPSK20M	Rear Face	1	38000	50	25	DSI-3/4	Ant1	1	62.90	20.00	18.79	0.09	0.445	1.006	1.321	0.59		
	25	LTE 38	QPSK20M	Front Face	1.1	38000	1	50	DSI-2	Ant1	1	62.90	25.00	24.03	0.19	0.666	1.006	1.250	0.84	
		LTE 38	QPSK20M	Rear Face	1.7	38000	1	50	DSI-2	Ant1	1	62.90	25.00	24.03	0.06	0.447	1.006	1.250	0.56	
		LTE 38	QPSK20M	Front Face	1.1	38000	50	25	DSI-2	Ant1	1	62.90	24.00	22.96	-0.03	0.484	1.006	1.271	0.62	
		LTE 38	QPSK20M	Rear Face	1.7	38000	50	25	DSI-2	Ant1	1	62.90	24.00	22.96	0.15	0.356	1.006	1.271	0.46	
		LTE 38	QPSK20M	Front Face	1	38000	1	50	DSI-4	Ant4	1	62.90	20.00	18.53	0.12	0.135	1.006	1.403	0.19	
		LTE 38	QPSK20M	Rear Face	1	38000	1	50	DSI-4	Ant4	1	62.90	20.00	18.53	-0.16	0.176	1.006	1.403	0.25	
		LTE 38	QPSK20M	Front Face	1	38000	50	25	DSI-4	Ant4	1	62.90	20.00	18.42	0.04	0.126	1.006	1.439	0.18	
		LTE 38	QPSK20M	Rear Face	1	38000	50	25	DSI-4	Ant4	1	62.90	20.00	18.42	0.06	0.176	1.006	1.439	0.25	
		LTE 38	QPSK20M	Front Face	1.1	38000	1	50	DSI-2	Ant4	1	62.90	25.00	23.48	-0.18	0.394	1.006	1.419	0.56	
		LTE 38	QPSK20M	Rear Face	1.7	38000	1	50	DSI-2	Ant4	1	62.90	25.00	23.48	-0.06	0.243	1.006	1.419	0.35	
		LTE 38	QPSK20M	Front Face	1.1	38000	50	25	DSI-2	Ant4	1	62.90	24.00	22.37	0.02	0.314	1.006	1.455	0.46	
		LTE 38	QPSK20M	Rear Face	1.7	38000	50	25	DSI-2	Ant4	1	62.90	24.00	22.37	-0.13	0.194	1.006	1.455	0.28	
		LTE 41	QPSK20M	Front Face	1	39750	1	50	DSI-3/4	Ant1	1	62.90	19.50	18.41	-0.05	0.166	1.006	1.285	0.21	
		LTE 41	QPSK20M	Rear Face	1	39750	1	50	DSI-3/4	Ant1	1	62.90	19.50	18.41	-0.12	0.297	1.006	1.285	0.38	
		LTE 41	QPSK20M	Front Face	1	39750	50	25	DSI-3/4	Ant1	1	62.90	19.50	18.35	0.06	0.164	1.006	1.303	0.22	
		LTE 41	QPSK20M	Rear Face	1	39750	50	25	DSI-3/4	Ant1	1	62.90	19.50	18.35	-0.07	0.376	1.006	1.303	0.49	
	26	LTE 41	QPSK20M	Front Face	1.1	39750	1	50	DSI-2	Ant1	1	62.90	25.00	23.96	-0.06	0.626	1.006	1.271	0.80	
		LTE 41	QPSK20M	Rear Face	1.7	39750	1	50	DSI-2	Ant1	1	62.90	25.00	23.96	0.03	0.419	1.006	1.271	0.54	
		LTE 41	QPSK20M	Front Face	1.1	39750	50	25	DSI-2	Ant1	1	62.90	24.00	22.86	-0.15	0.554	1.006	1.300	0.72	
		LTE 41	QPSK20M	Rear Face	1.7	39750	50	25	DSI-2	Ant1	1	62.90	24.00	22.86	0.17	0.334	1.006	1.300	0.44	
		LTE 41	QPSK20M	Front Face	1.1	40185	1	50	DSI-2	Ant1	1	62.90	25.00	23.80	0.08	0.653	1.006	1.318	0.87	
		LTE 41	QPSK20M	Front Face	1.1	40620	1	50	DSI-2	Ant1	1	62.90	25.00	23.94	0.04	0.656	1.006	1.276	0.84	
			LTE 41	QPSK20M	Front Face	1.1	41055	1	50	DSI-2	Ant1	1	62.90	25.00	23.91	-0.02	0.748	1.006	1.285	0.97
			LTE 41	QPSK20M	Front Face	1.1	41490	1	50	DSI-2	Ant1	1	62.90	25.00	23.49	0.11	0.598	1.006	1.416	0.85
			LTE 41	QPSK20M	Front Face	1.1	40185	50	25	DSI-2	Ant1	1	62.90	25.00	22.71	0.13	0.400	1.006	1.694	0.68
			LTE 41	QPSK20M	Front Face	1.1	40620	50	25	DSI-2	Ant1	1	62.90	25.00	22.81	0.03	0.432	1.006	1.656	0.72
			LTE 41	QPSK20M	Front Face	1.1	41055	50	25	DSI-2	Ant1	1	62.90	25.00	22.71	-0.13	0.477	1.006	1.694	0.81
			LTE 41	QPSK20M	Front Face	1.1	41490	50	25	DSI-2	Ant1	1	62.90	25.00	22.67	0.02	0.435	1.006	1.710	0.75
LTE 41			QPSK20M	Front Face	1.1	39750	100	0	DSI-2	Ant1	1	62.90	24.00	22.89	0.16	0.515	1.006	1.291	0.67	
LTE 41			QPSK20M	Front Face	1	39750	1	50	DSI-4	Ant4	1	62.90	19.50	18.34	0.13	0.146	1.006	1.306	0.19	
LTE 41			QPSK20M	Rear Face	1	39750	1	50	DSI-4	Ant4	1	62.90	19.50	18.34	0.02	0.185	1.006	1.306	0.24	
LTE 41			QPSK20M	Front Face	1	39750	50	25	DSI-4	Ant4	1	62.90	19.50	18.20	0.09	0.141	1.006	1.349	0.19	
LTE 41	QPSK20M		Rear Face	1	39750	50	25	DSI-4	Ant4	1	62.90	19.50	18.20	0.14	0.181	1.006	1.349	0.25		
LTE 41	QPSK20M		Front Face	1.1	39750	1	50	DSI-2	Ant4	1	62.90	25.00	23.73	0.17	0.647	1.006	1.340	0.87		
LTE 41	QPSK20M		Rear Face	1.7	39750	1	50	DSI-2	Ant4	1	62.90	25.00	23.73	-0.07	0.290	1.006	1.340	0.39		
LTE 41	QPSK20M		Front Face	1.1	39750	50	25	DSI-2	Ant4	1	62.90	24.00	22.62	0.05	0.382	1.006	1.374	0.53		
LTE 41	QPSK20M		Rear Face	1.7	39750	50	25	DSI-2	Ant4	1	62.90	24.00	22.62	-0.09	0.231	1.006	1.374	0.32		
LTE 41	QPSK20M		Front Face	1.1	40185	1	50	DSI-2	Ant4	1	62.90	25.00	23.58	0.02	0.406	1.006	1.387	0.57		
LTE 41	QPSK20M	Front Face	1.1	40620	1	50	DSI-2	Ant4	1	62.90	25.00	23.70	-0.05	0.383	1.006	1.349	0.52			
LTE 41	QPSK20M	Front Face	1.1	41055	1	50	DSI-2	Ant4	1	62.90	25.00	23.60	0.11	0.348	1.006	1.380	0.48			
LTE 41	QPSK20M	Front Face	1.1	41490	1	50	DSI-2	Ant4	1	62.90	25.00	23.62	-0.09	0.304	1.006	1.374	0.42			
LTE 41	QPSK20M	Front Face	1.1	39750	100	0	DSI-2	Ant4	1	62.90	24.00	22.66								



BUREAU VERITAS

FCC SAR Test Report



Certificate #6613.01

Plot No.	Band	Mode	Test Position	Separation Distance (cm)	Ch.	RB#	RB Offset	Power State	Antenna	Sample	Duty Cycle %	Max. Tune-up Power (dBm)	Measured Conducted Power (dBm)	Power Drift (dB)	Measured SAR-1g (W/kg)	Duty Cycle Scaling Factor	Tune-up Scaling Factor	Scaled SAR-1g (W/kg)
	LTE 66	QPSK20M	Rear Face	1	132322	1	50	DSI-3/4	Ant1	1	-	22.50	21.18	-0.07	0.388	1.000	1.355	0.53
	LTE 66	QPSK20M	Front Face	1	132322	50	25	DSI-3/4	Ant1	1	-	22.50	21.11	-0.06	0.255	1.000	1.377	0.35
	LTE 66	QPSK20M	Rear Face	1	132322	50	25	DSI-3/4	Ant1	1	-	22.50	21.11	0.11	0.392	1.000	1.377	0.54
	LTE 66	QPSK20M	Front Face	1.1	132322	1	50	DSI-2	Ant1	1	-	25.50	24.26	0.05	0.449	1.000	1.330	0.60
	LTE 66	QPSK20M	Rear Face	1.7	132322	1	50	DSI-2	Ant1	1	-	25.50	24.26	0.12	0.366	1.000	1.330	0.49
	LTE 66	QPSK20M	Front Face	1.1	132322	50	25	DSI-2	Ant1	1	-	24.50	23.29	0.11	0.362	1.000	1.321	0.48
	LTE 66	QPSK20M	Rear Face	1.7	132322	50	25	DSI-2	Ant1	1	-	24.50	23.29	0.08	0.288	1.000	1.321	0.38
	LTE 66	QPSK20M	Front Face	1	132322	1	50	DSI-4	Ant4	1	-	19.50	18.18	0.08	0.371	1.000	1.355	0.50
	LTE 66	QPSK20M	Rear Face	1	132322	1	50	DSI-4	Ant4	1	-	19.50	18.18	0.18	0.638	1.000	1.355	0.86
	LTE 66	QPSK20M	Front Face	1	132322	50	25	DSI-4	Ant4	1	-	19.50	17.96	-0.11	0.397	1.000	1.426	0.57
	LTE 66	QPSK20M	Rear Face	1	132322	50	25	DSI-4	Ant4	1	-	19.50	17.96	0.01	0.633	1.000	1.426	0.90
	LTE 66	QPSK20M	Rear Face	1	132072	1	50	DSI-4	Ant4	1	-	19.50	18.14	0.09	0.580	1.000	1.368	0.79
	LTE 66	QPSK20M	Rear Face	1	132572	1	50	DSI-4	Ant4	1	-	19.50	18.09	0.16	0.437	1.000	1.384	0.60
	LTE 66	QPSK20M	Rear Face	1	132072	50	25	DSI-4	Ant4	1	-	19.50	17.91	-0.03	0.578	1.000	1.442	0.83
	LTE 66	QPSK20M	Rear Face	1	132572	50	25	DSI-4	Ant4	1	-	19.50	17.93	0.04	0.444	1.000	1.435	0.64
	LTE 66	QPSK20M	Rear Face	1	132322	100	0	DSI-4	Ant4	1	-	19.50	17.99	-0.11	0.568	1.000	1.416	0.80
	LTE 66	QPSK20M	Front Face	1.1	132322	1	50	DSI-2	Ant4	1	-	22.50	21.14	0.14	0.677	1.000	1.368	0.93
	LTE 66	QPSK20M	Rear Face	1.7	132322	1	50	DSI-2	Ant4	1	-	22.50	21.14	0.07	0.403	1.000	1.368	0.55
	LTE 66	QPSK20M	Front Face	1.1	132322	50	25	DSI-2	Ant4	1	-	22.50	20.98	-0.09	0.670	1.000	1.419	0.95
	LTE 66	QPSK20M	Rear Face	1.7	132322	50	25	DSI-2	Ant4	1	-	22.50	20.98	0.03	0.403	1.000	1.419	0.57
	LTE 66	QPSK20M	Front Face	1.1	132072	1	50	DSI-2	Ant4	1	-	22.50	21.09	0.03	0.677	1.000	1.384	0.94
	LTE 66	QPSK20M	Front Face	1.1	132572	1	50	DSI-2	Ant4	1	-	22.50	21.12	0.07	0.534	1.000	1.374	0.73
27	LTE 66	QPSK20M	Front Face	1.1	132072	50	25	DSI-2	Ant4	1	-	22.50	20.86	0.03	0.710	1.000	1.459	1.04
	LTE 66	QPSK20M	Front Face	1.1	132572	50	25	DSI-2	Ant4	1	-	22.50	20.94	0.13	0.532	1.000	1.432	0.76
	LTE 66	QPSK20M	Front Face	1.1	132322	100	0	DSI-2	Ant4	1	-	22.50	20.95	-0.09	0.662	1.000	1.429	0.95
28	WLAN2.4G	802.11b	Front Face	1	11	-	-	DSI-2	Ant2	1	99.52	14.50	13.34	0.07	0.059	1.005	1.306	0.08
	WLAN2.4G	802.11b	Rear Face	1	11	-	-	DSI-2	Ant2	1	99.52	14.50	13.34	-0.11	0.155	1.005	1.306	0.20
29	WLAN5G	802.11n-HT20	Front Face	1	64	-	-	DSI-2	Ant2	1	93.00	10.50	9.41	0.00	0.000	1.075	1.285	0.00
	WLAN5G	802.11n-HT20	Rear Face	1	64	-	-	DSI-2	Ant2	1	93.00	10.50	9.41	0.02	0.234	1.075	1.285	0.32
	WLAN5G	802.11n-HT20	Rear Face	1	64	-	-	DSI-2	Ant2	2	93.00	10.50	9.41	0.04	0.179	1.075	1.285	0.25
	WLAN5G	802.11n-HT20	Rear Face	1	64	-	-	DSI-2	Ant2	3	93.00	10.50	9.41	0.09	0.206	1.075	1.285	0.28
	WLAN5G	802.11n-HT20	Rear Face	1	64	-	-	DSI-2	Ant2	4	93.00	10.50	9.41	-0.04	0.195	1.075	1.285	0.27
	WLAN5G	802.11n-HT20	Front Face	1	140	-	-	DSI-2	Ant2	1	93.00	10.50	9.38	0.00	0.000	1.075	1.294	0.00
30	WLAN5G	802.11n-HT20	Rear Face	1	140	-	-	DSI-2	Ant2	1	93.00	10.50	9.38	-0.09	0.225	1.075	1.294	0.31
	WLAN5G	802.11ac-VHT80	Front Face	1	155	-	-	DSI-2	Ant2	1	87.70	10.50	9.77	0.00	0.000	1.140	1.183	0.00
31	WLAN5G	802.11ac-VHT80	Rear Face	1	155	-	-	DSI-2	Ant2	1	87.70	10.50	9.77	0.05	0.078	1.140	1.183	0.11
	BT	GFSK	Front Face	1	78	-	-	DSI-2	Ant2	1	76.70	11.00	9.98	-0.08	0.055	1.304	1.265	0.09
32	BT	GFSK	Rear Face	1	78	-	-	DSI-2	Ant2	1	76.70	11.00	9.98	0.03	0.064	1.304	1.265	0.11

4.6.4 SAR Results for Hotspot Exposure Condition (Separation Distance is 1.0 cm Gap)

Plot No.	Band	Mode	Test Position	Separation Distance (cm)	Ch.	RB#	RB Offset	Power State	Antenna	Sample	Duty Cycle %	Max. Tune-up Power (dBm)	Measured Conducted Power (dBm)	Power Drift (dB)	Measured SAR-1g (W/kg)	Duty Cycle Scaling Factor	Tune-up Scaling Factor	Scaled SAR-1g (W/kg)
	GSM850	GPRS 4Tx Slot	Front Face	1	251	-	-	DSI-3/4	Ant1	1	-	27.50	26.59	0.07	0.192	1.000	1.233	0.24
	GSM850	GPRS 4Tx Slot	Rear Face	1	251	-	-	DSI-3/4	Ant1	1	-	27.50	26.59	0.03	0.287	1.000	1.233	0.35
	GSM850	GPRS 4Tx Slot	Left Side	1	251	-	-	DSI-2	Ant1	1	-	27.50	26.59	0.00	0.000	1.000	1.233	0.00
	GSM850	GPRS 4Tx Slot	Right Side	1	251	-	-	DSI-2	Ant1	1	-	27.50	26.59	-0.13	0.097	1.000	1.233	0.12
	GSM850	GPRS 4Tx Slot	Bottom Side	1	251	-	-	DSI-3/4	Ant1	1	-	27.50	26.59	0.05	0.139	1.000	1.233	0.17
	GSM850	GPRS 4Tx Slot	Front Face	1	251	-	-	DSI-4	Ant4	1	-	27.50	26.54	0.16	0.192	1.000	1.247	0.24
33	GSM850	GPRS 4Tx Slot	Rear Face	1	251	-	-	DSI-4	Ant4	1	-	27.50	26.54	0.07	0.335	1.000	1.247	0.42
	GSM850	GPRS 4Tx Slot	Left Side	1	251	-	-	DSI-2	Ant4	1	-	27.50	26.54	-0.04	0.064	1.000	1.247	0.08
	GSM850	GPRS 4Tx Slot	Right Side	1	251	-	-	DSI-2	Ant4	1	-	27.50	26.54	0.11	0.085	1.000	1.247	0.11
	GSM850	GPRS 4Tx Slot	Top Side	1	251	-	-	DSI-4	Ant4	1	-	27.50	26.54	-0.02	0.139	1.000	1.247	0.17
	GSM1900	GPRS 1Tx Slot	Front Face	1	661	-	-	DSI-3/4	Ant1	1	-	30.50	29.31	0.11	0.273	1.000	1.315	0.36
	GSM1900	GPRS 1Tx Slot	Rear Face	1	661	-	-	DSI-3/4	Ant1	1	-	30.50	29.31	0.04	0.370	1.000	1.315	0.49
	GSM1900	GPRS 1Tx Slot	Left Side	1	661	-	-	DSI-2	Ant1	1	-	30.50	29.31	-0.02	0.170	1.000	1.315	0.22
	GSM1900	GPRS 1Tx Slot	Right Side	1	661	-	-	DSI-2	Ant1	1	-	30.50	29.31	0.00	0.000	1.000	1.315	0.00
	GSM1900	GPRS 1Tx Slot	Bottom Side	1	661	-	-	DSI-3/4	Ant1	1	-	30.50	29.31	0.16	0.397	1.000	1.315	0.52
	GSM1900	GPRS 1Tx Slot	Front Face	1	810	-	-	DSI-4	Ant4	1	-	27.00	26.05	-0.09	0.280	1.000	1.245	0.35
34	GSM1900	GPRS 1Tx Slot	Rear Face	1	810	-	-	DSI-4	Ant4	1	-	27.00	26.05	0.02	0.662	1.000	1.245	0.82
	GSM1900	GPRS 1Tx Slot	Left Side	1	810	-	-	DSI-2	Ant4	1	-	30.50	29.41	0.11	0.099	1.000	1.285	0.13
	GSM1900	GPRS 1Tx Slot	Right Side	1	810	-	-	DSI-2	Ant4	1	-	30.50	29.41	0.00	0.000	1.000	1.285	0.00
	GSM1900	GPRS 1Tx Slot	Top Side	1	810	-	-	DSI-4	Ant4	1	-	27.00	26.05	0.03	0.551	1.000	1.245	0.69
	GSM1900	GPRS 1Tx Slot	Front Face	1.1	810	-	-	DSI-2	Ant4	1	-	30.50	29.41	-0.04	0.483	1.000	1.285	0.62
	GSM1900	GPRS 1Tx Slot	Rear Face	1.7	810	-	-	DSI-2	Ant4	1	-	30.50	29.41	0.01	0.524	1.000	1.285	0.67
	GSM1900	GPRS 1Tx Slot	Top Side	2.1	810	-	-	DSI-2	Ant4	1	-	30.50	29.41	0.06	0.330	1.000	1.285	0.42
	WCDMA II	RMC12.2K	Front Face	1	9538	-	-	DSI-3/4	Ant1	1	-	22.00	20.89	0.09	0.411	1.000	1.291	0.53



BUREAU VERITAS

FCC SAR Test Report



Certificate #6613.01

Plot No.	Band	Mode	Test Position	Separation Distance (cm)	Ch.	RB#	RB Offset	Power State	Antenna	Sample	Duty Cycle %	Max. Tune-up Power (dBm)	Measured Conducted Power (dBm)	Power Drift (dB)	Measured SAR-1g (W/kg)	Duty Cycle Scaling Factor	Tune-up Scaling Factor	Scaled SAR-1g (W/kg)
	WCDMA II	RMC12.2K	Rear Face	1	9538	-	-	DSI-3/4	Ant1	1	-	22.00	20.89	0.05	0.497	1.000	1.291	0.64
	WCDMA II	RMC12.2K	Left Side	1	9538	-	-	DSI-2	Ant1	1	-	25.00	23.95	-0.08	0.349	1.000	1.274	0.44
	WCDMA II	RMC12.2K	Right Side	1	9538	-	-	DSI-2	Ant1	1	-	25.00	23.95	0.12	0.149	1.000	1.274	0.19
	WCDMA II	RMC12.2K	Bottom Side	1	9538	-	-	DSI-3/4	Ant1	1	-	22.00	20.89	-0.05	0.684	1.000	1.291	0.88
	WCDMA II	RMC12.2K	Bottom Side	1	9262	-	-	DSI-3/4	Ant1	1	-	22.00	20.75	-0.10	0.622	1.000	1.334	0.83
	WCDMA II	RMC12.2K	Bottom Side	1	9400	-	-	DSI-3/4	Ant1	1	-	22.00	20.81	-0.01	0.715	1.000	1.315	0.94
	WCDMA II	RMC12.2K	Front Face	1.1	9538	-	-	DSI-2	Ant1	1	-	25.00	23.95	0.06	0.796	1.000	1.274	1.01
	WCDMA II	RMC12.2K	Rear Face	1.7	9538	-	-	DSI-2	Ant1	1	-	25.00	23.95	0.04	0.522	1.000	1.274	0.66
	WCDMA II	RMC12.2K	Bottom Side	2.1	9538	-	-	DSI-2	Ant1	1	-	25.00	23.95	0.09	0.428	1.000	1.274	0.55
	WCDMA II	RMC12.2K	Front Face	1.1	9262	-	-	DSI-2	Ant1	1	-	25.00	23.71	0.14	0.520	1.000	1.346	0.70
	WCDMA II	RMC12.2K	Front Face	1.1	9400	-	-	DSI-2	Ant1	1	-	25.00	23.82	0.19	0.634	1.000	1.312	0.83
	WCDMA II	RMC12.2K	Front Face	1	9538	-	-	DSI-4	Ant4	1	-	18.50	17.51	0.12	0.337	1.000	1.256	0.42
	WCDMA II	RMC12.2K	Rear Face	1	9538	-	-	DSI-4	Ant4	1	-	18.50	17.51	0.09	0.726	1.000	1.256	0.91
	WCDMA II	RMC12.2K	Left Side	1	9538	-	-	DSI-2	Ant4	1	-	22.50	21.29	-0.08	0.276	1.000	1.321	0.36
	WCDMA II	RMC12.2K	Right Side	1	9538	-	-	DSI-2	Ant4	1	-	22.50	21.29	0.13	0.122	1.000	1.321	0.16
	WCDMA II	RMC12.2K	Top Side	1	9538	-	-	DSI-4	Ant4	1	-	18.50	17.51	0.03	0.706	1.000	1.256	0.89
	WCDMA II	RMC12.2K	Rear Face	1	9262	-	-	DSI-4	Ant4	1	-	18.50	17.41	0.05	0.314	1.000	1.285	0.40
	WCDMA II	RMC12.2K	Rear Face	1	9400	-	-	DSI-4	Ant4	1	-	18.50	17.45	-0.01	0.479	1.000	1.274	0.61
	WCDMA II	RMC12.2K	Top Side	1	9262	-	-	DSI-4	Ant4	1	-	18.50	17.41	0.08	0.402	1.000	1.285	0.52
	WCDMA II	RMC12.2K	Top Side	1	9400	-	-	DSI-4	Ant4	1	-	18.50	17.45	-0.05	0.600	1.000	1.274	0.76
35	WCDMA II	RMC12.2K	Front Face	1.1	9538	-	-	DSI-2	Ant4	1	-	22.50	21.29	0.04	0.801	1.000	1.321	1.06
	WCDMA II	RMC12.2K	Rear Face	1.7	9538	-	-	DSI-2	Ant4	1	-	22.50	21.29	0.13	0.624	1.000	1.321	0.82
	WCDMA II	RMC12.2K	Top Side	2.1	9538	-	-	DSI-2	Ant4	1	-	22.50	21.29	-0.07	0.598	1.000	1.321	0.79
	WCDMA II	RMC12.2K	Front Face	1.1	9262	-	-	DSI-2	Ant4	1	-	22.50	21.03	0.11	0.357	1.000	1.403	0.50
	WCDMA II	RMC12.2K	Front Face	1.1	9400	-	-	DSI-2	Ant4	1	-	22.50	21.15	-0.15	0.561	1.000	1.365	0.77
	WCDMA II	RMC12.2K	Rear Face	1.7	9262	-	-	DSI-2	Ant4	1	-	22.50	21.03	0.09	0.315	1.000	1.403	0.44
	WCDMA II	RMC12.2K	Rear Face	1.7	9400	-	-	DSI-2	Ant4	1	-	22.50	21.15	0.08	0.468	1.000	1.365	0.64
	WCDMA IV	RMC12.2K	Front Face	1	1413	-	-	DSI-3/4	Ant1	1	-	21.50	20.25	0.13	0.212	1.000	1.334	0.28
	WCDMA IV	RMC12.2K	Rear Face	1	1413	-	-	DSI-3/4	Ant1	1	-	21.50	20.25	0.04	0.337	1.000	1.334	0.45
	WCDMA IV	RMC12.2K	Left Side	1	1413	-	-	DSI-2	Ant1	1	-	25.50	24.34	-0.12	0.266	1.000	1.306	0.35
	WCDMA IV	RMC12.2K	Right Side	1	1413	-	-	DSI-2	Ant1	1	-	25.50	24.34	0.08	0.105	1.000	1.306	0.14
	WCDMA IV	RMC12.2K	Bottom Side	1	1413	-	-	DSI-3/4	Ant1	1	-	21.50	20.25	0.06	0.586	1.000	1.334	0.78
	WCDMA IV	RMC12.2K	Front Face	1.1	1413	-	-	DSI-2	Ant1	1	-	25.50	24.34	-0.04	0.493	1.000	1.306	0.64
	WCDMA IV	RMC12.2K	Rear Face	1.7	1413	-	-	DSI-2	Ant1	1	-	25.50	24.34	0.07	0.389	1.000	1.306	0.51
	WCDMA IV	RMC12.2K	Bottom Side	2.1	1413	-	-	DSI-2	Ant1	1	-	25.50	24.34	0.13	0.408	1.000	1.306	0.53
	WCDMA IV	RMC12.2K	Front Face	1	1312	-	-	DSI-4	Ant4	1	-	19.00	17.92	0.15	0.326	1.000	1.282	0.42
	WCDMA IV	RMC12.2K	Rear Face	1	1312	-	-	DSI-4	Ant4	1	-	19.00	17.92	0.04	0.553	1.000	1.282	0.71
	WCDMA IV	RMC12.2K	Left Side	1	1312	-	-	DSI-2	Ant4	1	-	22.50	21.40	0.06	0.241	1.000	1.288	0.31
	WCDMA IV	RMC12.2K	Right Side	1	1312	-	-	DSI-2	Ant4	1	-	22.50	21.40	0.11	0.137	1.000	1.288	0.18
	WCDMA IV	RMC12.2K	Top Side	1	1312	-	-	DSI-4	Ant4	1	-	19.00	17.92	-0.08	0.646	1.000	1.282	0.83
	WCDMA IV	RMC12.2K	Top Side	1	1413	-	-	DSI-4	Ant4	1	-	19.00	17.87	0.15	0.722	1.000	1.297	0.94
	WCDMA IV	RMC12.2K	Top Side	1	1513	-	-	DSI-4	Ant4	1	-	19.00	17.83	0.13	0.648	1.000	1.309	0.85
	WCDMA IV	RMC12.2K	Front Face	1.1	1312	-	-	DSI-2	Ant4	1	-	22.50	21.40	0.09	0.648	1.000	1.288	0.83
	WCDMA IV	RMC12.2K	Rear Face	1.7	1312	-	-	DSI-2	Ant4	1	-	22.50	21.40	-0.13	0.406	1.000	1.288	0.52
	WCDMA IV	RMC12.2K	Top Side	2.1	1312	-	-	DSI-2	Ant4	1	-	22.50	21.40	0.06	0.310	1.000	1.288	0.40
36	WCDMA IV	RMC12.2K	Front Face	1.1	1413	-	-	DSI-2	Ant4	1	-	22.50	21.34	-0.02	0.761	1.000	1.306	0.99
	WCDMA IV	RMC12.2K	Front Face	1.1	1513	-	-	DSI-2	Ant4	1	-	22.50	21.24	-0.05	0.619	1.000	1.337	0.83
	WCDMA V	RMC12.2K	Front Face	1	4233	-	-	DSI-3/4	Ant1	1	-	25.50	24.29	-0.09	0.170	1.000	1.321	0.22
	WCDMA V	RMC12.2K	Rear Face	1	4233	-	-	DSI-3/4	Ant1	1	-	25.50	24.29	0.07	0.235	1.000	1.321	0.31
	WCDMA V	RMC12.2K	Left Side	1	4233	-	-	DSI-2	Ant1	1	-	25.50	24.29	0.14	0.073	1.000	1.321	0.10
	WCDMA V	RMC12.2K	Right Side	1	4233	-	-	DSI-2	Ant1	1	-	25.50	24.29	0.05	0.076	1.000	1.321	0.10
	WCDMA V	RMC12.2K	Bottom Side	1	4233	-	-	DSI-3/4	Ant1	1	-	25.50	24.29	0.17	0.132	1.000	1.321	0.17
	WCDMA V	RMC12.2K	Front Face	1	4233	-	-	DSI-4	Ant4	1	-	25.50	24.25	0.17	0.223	1.000	1.334	0.30
37	WCDMA V	RMC12.2K	Rear Face	1	4233	-	-	DSI-4	Ant4	1	-	25.50	24.25	0.09	0.401	1.000	1.334	0.53
	WCDMA V	RMC12.2K	Left Side	1	4233	-	-	DSI-2	Ant4	1	-	25.50	24.25	0.04	0.080	1.000	1.334	0.11
	WCDMA V	RMC12.2K	Right Side	1	4233	-	-	DSI-2	Ant4	1	-	25.50	24.25	-0.09	0.085	1.000	1.334	0.11
	WCDMA V	RMC12.2K	Top Side	1	4233	-	-	DSI-4	Ant4	1	-	25.50	24.25	0.13	0.135	1.000	1.334	0.18
	LTE 2	QPSK20M	Front Face	1	18700	1	50	DSI-3/4	Ant1	1	-	22.00	20.58	0.12	0.293	1.000	1.387	0.41
	LTE 2	QPSK20M	Rear Face	1	18700	1	50	DSI-3/4	Ant1	1	-	22.00	20.58	-0.06	0.458	1.000	1.387	0.64
	LTE 2	QPSK20M	Left Side	1	18700	1	50	DSI-2	Ant1	1	-	25.00	23.50	-0.08	0.370	1.000	1.413	0.52
	LTE 2	QPSK20M	Right Side	1	18700	1	50	DSI-2	Ant1	1	-	25.00	23.50	0.11	0.182	1.000	1.413	0.26
	LTE 2	QPSK20M	Bottom Side	1	18700	1	50	DSI-3/4	Ant1	1	-	22.00	20.58	0.05	0.603	1.000	1.387	0.84
	LTE 2	QPSK20M	Front Face	1	18700	50	25	DSI-3/4	Ant1	1	-	22.00	20.38	0.18	0.297	1.000	1.452	0.43
	LTE 2	QPSK20M	Rear Face	1	18700	50	25	DSI-3/4	Ant1	1	-	22.00	20.38	-0.09	0.397	1.000	1.452	0.58
	LTE 2	QPSK20M	Left Side	1	18700	50	25	DSI-2	Ant1	1	-	24.50	22.89	0.12	0.299	1.000	1.449	0.43
	LTE 2	QPSK20M	Right Side	1	18700	50	25	DSI-2	Ant1	1	-	24.50	22.89	0.05	0.146	1.000	1.449	0.21
	LTE 2	QPSK20M	Bottom Side	1	18700	50	25	DSI-3/4	Ant1	1	-	22.00	20.38	0.11	0.606	1.000	1.452	0.88
	LTE 2	QPSK20M	Bottom Side	1	18900	1	50	DSI-3/4	Ant1	1	-	22.00	20.54	0.02	0.686	1.000	1.400	0.96
	LTE 2	QPSK20M	Bottom Side	1	19100	1	50	DSI-3/4	Ant1	1	-	22.00	20.49	0.02	0.578	1.000	1.416	0.82
	LTE 2	QPSK20M	Bottom Side	1	18900	50	25	DSI-3/4	Ant1	1	-	22.00	20.30	0.04	0.542	1.000	1.479	0.80
	LTE 2	QPSK20M	Bottom Side	1	19100	50	25	DSI-3/4	Ant1	1	-	22.00	20.35	0.09	0.576	1.000	1.462	0.84
	LTE 2	QPSK20M	Bottom Side	1	18700	100	0	DSI-3/4	Ant1	1	-	22.00	20.43	0.13	0.615	1.000	1.435	0.88
	LTE 2	QPSK20M	Front Face	1.1	18700	1	50	DSI-2	Ant1	1	-	25.00	23.50	-0.02	0.647	1.000	1.413	0.91
	LTE 2	QPSK20M	Rear Face	1.7	18700	1	50	DSI-2	Ant1	1	-	25.00	23.50	-0.08	0.369	1.000	1.413	0.52
	LTE 2	QPSK20M	Bottom Side	2.1	18700	1	50	DSI-2	Ant1	1	-	25.00	23.50	0.12	0.373	1.000	1.413	0.53



BUREAU VERITAS

FCC SAR Test Report



Certificate #6613.01

Plot No.	Band	Mode	Test Position	Separation Distance (cm)	Ch.	RB#	RB Offset	Power State	Antenna	Sample	Duty Cycle %	Max. Tune-up Power (dBm)	Measured Conducted Power (dBm)	Power dB (dB)	Measured SAR-1g (W/kg)	Duty Cycle Scaling Factor	Tune-up Scaling Factor	Scaled SAR-1g (W/kg)
	LTE 2	QPSK20M	Front Face	1.1	18700	50	25	DSI-2	Ant1	1	-	24.50	22.89	0.09	0.456	1.000	1.449	0.66
	LTE 2	QPSK20M	Rear Face	1.7	18700	50	25	DSI-2	Ant1	1	-	24.50	22.89	0.13	0.325	1.000	1.449	0.47
	LTE 2	QPSK20M	Bottom Side	2.1	18700	50	25	DSI-2	Ant1	1	-	24.50	22.89	-0.04	0.329	1.000	1.449	0.48
	LTE 2	QPSK20M	Front Face	1.1	18900	1	50	DSI-2	Ant1	1	-	25.00	23.44	0.12	0.616	1.000	1.432	0.88
	LTE 2	QPSK20M	Front Face	1.1	19100	1	50	DSI-2	Ant1	1	-	25.00	23.43	-0.03	0.749	1.000	1.435	1.08
	LTE 2	QPSK20M	Front Face	1.1	18700	100	0	DSI-2	Ant1	1	-	25.00	22.91	0.05	0.460	1.000	1.618	0.74
	LTE 2	QPSK20M	Front Face	1	18700	1	50	DSI-4	Ant4	1	-	18.50	17.35	0.04	0.176	1.000	1.303	0.23
	LTE 2	QPSK20M	Rear Face	1	18700	1	50	DSI-4	Ant4	1	-	18.50	17.35	0.11	0.332	1.000	1.303	0.43
	LTE 2	QPSK20M	Left Side	1	18700	1	50	DSI-2	Ant4	1	-	22.50	21.11	0.12	0.075	1.000	1.377	0.10
	LTE 2	QPSK20M	Right Side	1	18700	1	50	DSI-2	Ant4	1	-	22.50	21.11	0.00	0.000	1.000	1.377	0.00
	LTE 2	QPSK20M	Top Side	1	18700	1	50	DSI-4	Ant4	1	-	18.50	17.35	0.08	0.419	1.000	1.303	0.55
	LTE 2	QPSK20M	Front Face	1	18700	50	25	DSI-4	Ant4	1	-	18.50	17.01	-0.14	0.177	1.000	1.409	0.25
	LTE 2	QPSK20M	Rear Face	1	18700	50	25	DSI-4	Ant4	1	-	18.50	17.01	-0.03	0.331	1.000	1.409	0.47
	LTE 2	QPSK20M	Left Side	1	18700	50	25	DSI-2	Ant4	1	-	22.50	20.97	-0.12	0.076	1.000	1.422	0.11
	LTE 2	QPSK20M	Right Side	1	18700	50	25	DSI-2	Ant4	1	-	22.50	20.97	0.00	0.000	1.000	1.422	0.00
	LTE 2	QPSK20M	Top Side	1	18700	50	25	DSI-4	Ant4	1	-	18.50	17.01	0.14	0.419	1.000	1.409	0.59
	LTE 2	QPSK20M	Rear Face	1	18900	1	50	DSI-4	Ant4	1	-	18.50	17.20	0.07	0.462	1.000	1.349	0.62
	LTE 2	QPSK20M	Rear Face	1	19100	1	50	DSI-4	Ant4	1	-	18.50	17.33	0.04	0.700	1.000	1.309	0.92
	LTE 2	QPSK20M	Top Side	1	18900	1	50	DSI-4	Ant4	1	-	18.50	17.20	0.09	0.578	1.000	1.349	0.78
	LTE 2	QPSK20M	Top Side	1	19100	1	50	DSI-4	Ant4	1	-	18.50	17.33	0.01	0.719	1.000	1.309	0.94
	LTE 2	QPSK20M	Rear Face	1	18900	50	25	DSI-4	Ant4	1	-	18.50	16.90	0.13	0.459	1.000	1.445	0.66
	LTE 2	QPSK20M	Rear Face	1	19100	50	25	DSI-4	Ant4	1	-	18.50	16.84	-0.09	0.570	1.000	1.466	0.84
	LTE 2	QPSK20M	Top Side	1	18900	50	25	DSI-4	Ant4	1	-	18.50	16.90	-0.04	0.577	1.000	1.445	0.83
	LTE 2	QPSK20M	Top Side	1	19100	50	25	DSI-4	Ant4	1	-	18.50	16.84	0.04	0.728	1.000	1.466	1.07
	LTE 2	QPSK20M	Rear Face	1	18700	100	0	DSI-4	Ant4	1	-	18.50	16.96	0.09	0.318	1.000	1.426	0.45
	LTE 2	QPSK20M	Top Side	1	18700	100	0	DSI-4	Ant4	1	-	18.50	16.96	0.05	0.407	1.000	1.426	0.58
	LTE 2	QPSK20M	Front Face	1.1	18700	1	50	DSI-2	Ant4	1	-	22.50	21.11	0.18	0.384	1.000	1.377	0.53
	LTE 2	QPSK20M	Rear Face	1.7	18700	1	50	DSI-2	Ant4	1	-	22.50	21.11	0.00	0.327	1.000	1.377	0.45
	LTE 2	QPSK20M	Top Side	2.1	18700	1	50	DSI-2	Ant4	1	-	22.50	21.11	0.09	0.307	1.000	1.377	0.42
	LTE 2	QPSK20M	Front Face	1.1	18700	50	25	DSI-2	Ant4	1	-	22.50	20.97	0.06	0.379	1.000	1.422	0.54
	LTE 2	QPSK20M	Rear Face	1.7	18700	50	25	DSI-2	Ant4	1	-	22.50	20.97	0.14	0.324	1.000	1.422	0.46
	LTE 2	QPSK20M	Top Side	2.1	18700	50	25	DSI-2	Ant4	1	-	22.50	20.97	0.01	0.309	1.000	1.422	0.44
	LTE 2	QPSK20M	Front Face	1.1	18900	1	50	DSI-2	Ant4	1	-	22.50	21.07	0.02	0.544	1.000	1.390	0.76
38	LTE 2	QPSK20M	Front Face	1.1	19100	1	50	DSI-2	Ant4	1	-	22.50	21.03	0.09	0.772	1.000	1.403	1.08
	LTE 2	QPSK20M	Front Face	1.1	18700	100	0	DSI-2	Ant4	1	-	22.50	20.96	-0.13	0.368	1.000	1.426	0.52
	LTE 5	QPSK10M	Front Face	1	20600	1	24	DSI-3/4	Ant1	1	-	25.50	24.44	0.13	0.229	1.000	1.276	0.29
	LTE 5	QPSK10M	Rear Face	1	20600	1	24	DSI-3/4	Ant1	1	-	25.50	24.44	0.05	0.386	1.000	1.276	0.49
	LTE 5	QPSK10M	Left Side	1	20600	1	24	DSI-2	Ant1	1	-	25.50	24.44	0.03	0.082	1.000	1.276	0.10
	LTE 5	QPSK10M	Right Side	1	20600	1	24	DSI-2	Ant1	1	-	25.50	24.44	0.01	0.051	1.000	1.276	0.07
	LTE 5	QPSK10M	Bottom Side	1	20600	1	24	DSI-3/4	Ant1	1	-	25.50	24.44	0.05	0.215	1.000	1.276	0.27
	LTE 5	QPSK10M	Front Face	1	20600	25	12	DSI-3/4	Ant1	1	-	24.50	23.43	-0.03	0.194	1.000	1.279	0.25
	LTE 5	QPSK10M	Rear Face	1	20600	25	12	DSI-3/4	Ant1	1	-	24.50	23.43	0.11	0.306	1.000	1.279	0.39
	LTE 5	QPSK10M	Left Side	1	20600	25	12	DSI-2	Ant1	1	-	24.50	23.43	0.03	0.056	1.000	1.279	0.07
	LTE 5	QPSK10M	Right Side	1	20600	25	12	DSI-2	Ant1	1	-	24.50	23.43	-0.19	0.044	1.000	1.279	0.06
	LTE 5	QPSK10M	Bottom Side	1	20600	25	12	DSI-3/4	Ant1	1	-	24.50	23.43	-0.14	0.200	1.000	1.279	0.26
	LTE 5	QPSK10M	Front Face	1	20600	1	24	DSI-4	Ant4	1	-	25.50	24.21	0.09	0.258	1.000	1.346	0.35
39	LTE 5	QPSK10M	Rear Face	1	20600	1	24	DSI-4	Ant4	1	-	25.50	24.21	0.07	0.423	1.000	1.346	0.57
	LTE 5	QPSK10M	Left Side	1	20600	1	24	DSI-2	Ant4	1	-	25.50	24.21	0.10	0.088	1.000	1.346	0.12
	LTE 5	QPSK10M	Right Side	1	20600	1	24	DSI-2	Ant4	1	-	25.50	24.21	0.01	0.096	1.000	1.346	0.13
	LTE 5	QPSK10M	Top Side	1	20600	1	24	DSI-4	Ant4	1	-	25.50	24.21	0.14	0.244	1.000	1.346	0.33
	LTE 5	QPSK10M	Front Face	1	20600	25	12	DSI-4	Ant4	1	-	24.50	23.22	-0.04	0.208	1.000	1.343	0.28
	LTE 5	QPSK10M	Rear Face	1	20600	25	12	DSI-4	Ant4	1	-	24.50	23.22	0.03	0.292	1.000	1.343	0.39
	LTE 5	QPSK10M	Left Side	1	20600	25	12	DSI-2	Ant4	1	-	24.50	23.22	0.06	0.070	1.000	1.343	0.09
	LTE 5	QPSK10M	Right Side	1	20600	25	12	DSI-2	Ant4	1	-	24.50	23.22	0.09	0.079	1.000	1.343	0.11
	LTE 5	QPSK10M	Top Side	1	20600	25	12	DSI-4	Ant4	1	-	24.50	23.22	-0.11	0.269	1.000	1.343	0.36
	LTE 7	QPSK20M	Front Face	1	20850	1	50	DSI-3/4	Ant1	1	-	18.50	17.62	0.17	0.222	1.000	1.225	0.27
	LTE 7	QPSK20M	Rear Face	1	20850	1	50	DSI-3/4	Ant1	1	-	18.50	17.62	-0.09	0.449	1.000	1.225	0.55
	LTE 7	QPSK20M	Left Side	1	20850	1	50	DSI-2	Ant1	1	-	24.00	22.96	0.05	0.046	1.000	1.271	0.06
	LTE 7	QPSK20M	Right Side	1	20850	1	50	DSI-2	Ant1	1	-	24.00	22.96	-0.04	0.085	1.000	1.271	0.11
	LTE 7	QPSK20M	Bottom Side	1	20850	1	50	DSI-3/4	Ant1	1	-	18.50	17.62	0.01	0.505	1.000	1.225	0.62
	LTE 7	QPSK20M	Front Face	1	20850	50	25	DSI-3/4	Ant1	1	-	18.50	17.46	0.13	0.214	1.000	1.271	0.27
	LTE 7	QPSK20M	Rear Face	1	20850	50	25	DSI-3/4	Ant1	1	-	18.50	17.46	0.09	0.372	1.000	1.271	0.47
	LTE 7	QPSK20M	Left Side	1	20850	50	25	DSI-2	Ant1	1	-	24.00	22.90	0.04	0.122	1.000	1.288	0.16
	LTE 7	QPSK20M	Right Side	1	20850	50	25	DSI-2	Ant1	1	-	24.00	22.90	-0.16	0.086	1.000	1.288	0.11
	LTE 7	QPSK20M	Bottom Side	1	20850	50	25	DSI-3/4	Ant1	1	-	18.50	17.46	0.07	0.506	1.000	1.271	0.64
	LTE 7	QPSK20M	Front Face	1.1	20850	1	50	DSI-2	Ant1	1	-	24.00	22.96	0.02	0.675	1.000	1.271	0.86
	LTE 7	QPSK20M	Rear Face	1.7	20850	1	50	DSI-2	Ant1	1	-	24.00	22.96	0.04	0.543	1.000	1.271	0.69
	LTE 7	QPSK20M	Bottom Side	2.1	20850	1	50	DSI-2	Ant1	1	-	24.00	22.96	0.05	0.501	1.000	1.271	0.64
	LTE 7	QPSK20M	Front Face	1.1	20850	50	25	DSI-2	Ant1	1	-	24.00	22.90	0.09	0.677	1.000	1.288	0.87
	LTE 7	QPSK20M	Rear Face	1.7	20850	50	25	DSI-2	Ant1	1	-	24.00	22.90	0.05	0.545	1.000	1.288	0.70
	LTE 7	QPSK20M	Bottom Side	2.1	20850	50	25	DSI-2	Ant1	1	-	24.00	22.90	-0.04	0.507	1.000	1.288	0.65
	LTE 7	QPSK20M	Front Face	1.1	21100	1	50	DSI-2	Ant1	1	-	24.00	22.88	-0.09	0.689	1.000	1.294	0.89
	LTE 7	QPSK20M	Front Face	1.1	21350	1	50	DSI-2	Ant1	1	-	24.00	22.94	0.08	0.709	1.000	1.276	0.90
	LTE 7	QPSK20M	Front Face	1.1	21100	50	25	DSI-2	Ant1	1	-	24.00	22.83	-0.18	0.697	1.000	1.309	0.91
40	LTE 7	QPSK20M	Front Face	1.1														



BUREAU VERITAS

FCC SAR Test Report



Certificate #6613.01

Plot No.	Band	Mode	Test Position	Separation Distance (cm)	Ch.	RB#	RB Offset	Power State	Antenna	Sample	Duty Cycle %	Max. Tune-up Power (dBm)	Measured Conducted Power (dBm)	Power Drift (dB)	Measured SAR-1g (W/kg)	Duty Cycle Scaling Factor	Tune-up Scaling Factor	Scaled SAR-1g (W/kg)
	LTE 7	QPSK20M	Front Face	1.1	20850	100	0	DSI-2	Ant1	1	-	24.00	22.85	0.18	0.680	1.000	1.303	0.89
	LTE 7	QPSK20M	Front Face	1	20850	1	50	DSI-4	Ant4	1	-	17.50	16.01	0.13	0.154	1.000	1.409	0.22
	LTE 7	QPSK20M	Rear Face	1	20850	1	50	DSI-4	Ant4	1	-	17.50	16.01	0.06	0.192	1.000	1.409	0.27
	LTE 7	QPSK20M	Left Side	1	20850	1	50	DSI-2	Ant4	1	-	23.50	21.97	0.11	0.369	1.000	1.422	0.52
	LTE 7	QPSK20M	Right Side	1	20850	1	50	DSI-2	Ant4	1	-	23.50	21.97	0.05	0.146	1.000	1.422	0.21
	LTE 7	QPSK20M	Top Side	1	20850	1	50	DSI-4	Ant4	1	-	17.50	16.01	0.14	0.273	1.000	1.409	0.38
	LTE 7	QPSK20M	Front Face	1	20850	50	50	DSI-4	Ant4	1	-	17.50	15.94	-0.08	0.157	1.000	1.432	0.22
	LTE 7	QPSK20M	Rear Face	1	20850	50	50	DSI-4	Ant4	1	-	17.50	15.94	0.13	0.202	1.000	1.432	0.29
	LTE 7	QPSK20M	Left Side	1	20850	50	50	DSI-2	Ant4	1	-	23.50	21.89	0.06	0.301	1.000	1.449	0.44
	LTE 7	QPSK20M	Right Side	1	20850	50	50	DSI-2	Ant4	1	-	23.50	21.89	-0.12	0.120	1.000	1.449	0.17
	LTE 7	QPSK20M	Top Side	1	20850	50	50	DSI-4	Ant4	1	-	17.50	15.94	-0.08	0.278	1.000	1.432	0.40
	LTE 7	QPSK20M	Front Face	1.1	20850	1	50	DSI-2	Ant4	1	-	23.50	21.97	-0.17	0.483	1.000	1.422	0.69
	LTE 7	QPSK20M	Rear Face	1.7	20850	1	50	DSI-2	Ant4	1	-	23.50	21.97	0.04	0.340	1.000	1.422	0.48
	LTE 7	QPSK20M	Top Side	2.1	20850	1	50	DSI-2	Ant4	1	-	23.50	21.97	0.13	0.261	1.000	1.422	0.37
	LTE 7	QPSK20M	Front Face	1.1	20850	50	50	DSI-2	Ant4	1	-	23.50	21.89	0.09	0.490	1.000	1.449	0.71
	LTE 7	QPSK20M	Rear Face	1.7	20850	50	50	DSI-2	Ant4	1	-	23.50	21.89	0.12	0.333	1.000	1.449	0.48
	LTE 7	QPSK20M	Top Side	2.1	20850	50	50	DSI-2	Ant4	1	-	23.50	21.89	-0.06	0.254	1.000	1.449	0.37
	LTE 38	QPSK20M	Front Face	1	38000	1	50	DSI-3/4	Ant1	1	62.90	20.00	18.87	0.06	0.216	1.006	1.297	0.28
	LTE 38	QPSK20M	Rear Face	1	38000	1	50	DSI-3/4	Ant1	1	62.90	20.00	18.87	-0.07	0.334	1.006	1.297	0.44
	LTE 38	QPSK20M	Left Side	1	38000	1	50	DSI-2	Ant1	1	62.90	25.00	24.03	0.03	0.023	1.006	1.250	0.03
	LTE 38	QPSK20M	Right Side	1	38000	1	50	DSI-2	Ant1	1	62.90	25.00	24.03	0.12	0.044	1.006	1.250	0.06
	LTE 38	QPSK20M	Bottom Side	1	38000	1	50	DSI-3/4	Ant1	1	62.90	20.00	18.87	-0.11	0.586	1.006	1.297	0.76
	LTE 38	QPSK20M	Front Face	1	38000	50	25	DSI-3/4	Ant1	1	62.90	20.00	18.79	-0.09	0.214	1.006	1.321	0.28
	LTE 38	QPSK20M	Rear Face	1	38000	50	25	DSI-3/4	Ant1	1	62.90	20.00	18.79	0.09	0.445	1.006	1.321	0.59
	LTE 38	QPSK20M	Left Side	1	38000	50	25	DSI-2	Ant1	1	62.90	24.00	22.96	-0.17	0.093	1.006	1.271	0.12
	LTE 38	QPSK20M	Right Side	1	38000	50	25	DSI-2	Ant1	1	62.90	24.00	22.96	0.11	0.079	1.006	1.271	0.10
	LTE 38	QPSK20M	Bottom Side	1	38000	50	25	DSI-3/4	Ant1	1	62.90	20.00	18.79	-0.07	0.526	1.006	1.321	0.70
41	LTE 38	QPSK20M	Front Face	1.1	38000	1	50	DSI-2	Ant1	1	62.90	25.00	24.03	0.19	0.666	1.006	1.250	0.84
	LTE 38	QPSK20M	Rear Face	1.7	38000	1	50	DSI-2	Ant1	1	62.90	25.00	24.03	0.06	0.447	1.006	1.250	0.56
	LTE 38	QPSK20M	Bottom Side	2.1	38000	1	50	DSI-2	Ant1	1	62.90	25.00	24.03	0.14	0.468	1.006	1.250	0.59
	LTE 38	QPSK20M	Front Face	1.1	38000	50	25	DSI-2	Ant1	1	62.90	24.00	22.96	-0.03	0.484	1.006	1.271	0.62
	LTE 38	QPSK20M	Rear Face	1.7	38000	50	25	DSI-2	Ant1	1	62.90	24.00	22.96	0.15	0.356	1.006	1.271	0.46
	LTE 38	QPSK20M	Bottom Side	2.1	38000	50	25	DSI-2	Ant1	1	62.90	24.00	22.96	-0.02	0.377	1.006	1.271	0.48
	LTE 38	QPSK20M	Front Face	1	38000	1	50	DSI-4	Ant4	1	62.90	20.00	18.53	0.12	0.135	1.006	1.403	0.19
	LTE 38	QPSK20M	Rear Face	1	38000	1	50	DSI-4	Ant4	1	62.90	20.00	18.53	-0.16	0.176	1.006	1.403	0.25
	LTE 38	QPSK20M	Left Side	1	38000	1	50	DSI-2	Ant4	1	62.90	25.00	23.48	0.09	0.217	1.006	1.419	0.31
	LTE 38	QPSK20M	Right Side	1	38000	1	50	DSI-2	Ant4	1	62.90	25.00	23.48	0.11	0.071	1.006	1.419	0.10
	LTE 38	QPSK20M	Top Side	1	38000	1	50	DSI-4	Ant4	1	62.90	20.00	18.53	-0.13	0.306	1.006	1.403	0.43
	LTE 38	QPSK20M	Front Face	1	38000	50	25	DSI-4	Ant4	1	62.90	20.00	18.42	0.04	0.126	1.006	1.439	0.18
	LTE 38	QPSK20M	Rear Face	1	38000	50	25	DSI-4	Ant4	1	62.90	20.00	18.42	0.06	0.176	1.006	1.439	0.25
	LTE 38	QPSK20M	Left Side	1	38000	50	25	DSI-2	Ant4	1	62.90	24.00	22.37	-0.15	0.181	1.006	1.455	0.27
	LTE 38	QPSK20M	Right Side	1	38000	50	25	DSI-2	Ant4	1	62.90	24.00	22.37	-0.09	0.053	1.006	1.455	0.08
	LTE 38	QPSK20M	Top Side	1	38000	50	25	DSI-4	Ant4	1	62.90	20.00	18.42	0.16	0.294	1.006	1.439	0.43
	LTE 38	QPSK20M	Front Face	1.1	38000	1	50	DSI-2	Ant4	1	62.90	25.00	23.48	-0.18	0.394	1.006	1.419	0.56
	LTE 38	QPSK20M	Rear Face	1.7	38000	1	50	DSI-2	Ant4	1	62.90	25.00	23.48	-0.06	0.243	1.006	1.419	0.35
	LTE 38	QPSK20M	Top Side	2.1	38000	1	50	DSI-2	Ant4	1	62.90	25.00	23.48	0.05	0.301	1.006	1.419	0.43
	LTE 38	QPSK20M	Front Face	1.1	38000	50	25	DSI-2	Ant4	1	62.90	24.00	22.37	0.02	0.314	1.006	1.455	0.46
	LTE 38	QPSK20M	Rear Face	1.7	38000	50	25	DSI-2	Ant4	1	62.90	24.00	22.37	-0.13	0.194	1.006	1.455	0.28
	LTE 38	QPSK20M	Top Side	2.1	38000	50	25	DSI-2	Ant4	1	62.90	24.00	22.37	0.04	0.244	1.006	1.455	0.36
	LTE 41	QPSK20M	Front Face	1	39750	1	50	DSI-3/4	Ant1	1	62.90	19.50	18.41	-0.05	0.166	1.006	1.285	0.21
	LTE 41	QPSK20M	Rear Face	1	39750	1	50	DSI-3/4	Ant1	1	62.90	19.50	18.41	-0.12	0.297	1.006	1.285	0.38
	LTE 41	QPSK20M	Left Side	1	39750	1	50	DSI-2	Ant1	1	62.90	25.00	23.96	0.15	0.053	1.006	1.271	0.07
	LTE 41	QPSK20M	Right Side	1	39750	1	50	DSI-2	Ant1	1	62.90	25.00	23.96	0.13	0.096	1.006	1.271	0.12
	LTE 41	QPSK20M	Bottom Side	1	39750	1	50	DSI-3/4	Ant1	1	62.90	19.50	18.41	0.11	0.420	1.006	1.285	0.54
	LTE 41	QPSK20M	Front Face	1	39750	50	25	DSI-3/4	Ant1	1	62.90	19.50	18.35	0.06	0.164	1.006	1.303	0.22
	LTE 41	QPSK20M	Rear Face	1	39750	50	25	DSI-3/4	Ant1	1	62.90	19.50	18.35	-0.07	0.376	1.006	1.303	0.49
	LTE 41	QPSK20M	Left Side	1	39750	50	25	DSI-2	Ant1	1	62.90	24.00	22.86	0.05	0.051	1.006	1.300	0.07
	LTE 41	QPSK20M	Right Side	1	39750	50	25	DSI-2	Ant1	1	62.90	24.00	22.86	-0.12	0.084	1.006	1.300	0.11
	LTE 41	QPSK20M	Bottom Side	1	39750	50	25	DSI-3/4	Ant1	1	62.90	19.50	18.35	-0.06	0.446	1.006	1.303	0.58
	LTE 41	QPSK20M	Front Face	1.1	39750	1	50	DSI-2	Ant1	1	62.90	25.00	23.96	-0.06	0.626	1.006	1.271	0.80
	LTE 41	QPSK20M	Rear Face	1.7	39750	1	50	DSI-2	Ant1	1	62.90	25.00	23.96	0.03	0.419	1.006	1.271	0.54
	LTE 41	QPSK20M	Bottom Side	2.1	39750	1	50	DSI-2	Ant1	1	62.90	25.00	23.96	0.07	0.415	1.006	1.271	0.53
	LTE 41	QPSK20M	Front Face	1.1	39750	50	25	DSI-2	Ant1	1	62.90	24.00	22.86	-0.15	0.554	1.006	1.300	0.72
	LTE 41	QPSK20M	Rear Face	1.7	39750	50	25	DSI-2	Ant1	1	62.90	24.00	22.86	0.17	0.334	1.006	1.300	0.44
	LTE 41	QPSK20M	Bottom Side	2.1	39750	50	25	DSI-2	Ant1	1	62.90	24.00	22.86	0.12	0.326	1.006	1.300	0.43
	LTE 41	QPSK20M	Front Face	1.1	40185	1	50	DSI-2	Ant1	1	62.90	25.00	23.80	0.08	0.653	1.006	1.318	0.87
	LTE 41	QPSK20M	Front Face	1.1	40620	1	50	DSI-2	Ant1	1	62.90	25.00	23.94	0.04	0.656	1.006	1.276	0.84
42	LTE 41	QPSK20M	Front Face	1.1	41055	1	50	DSI-2	Ant1	1	62.90	25.00	23.91	-0.02	0.748	1.006	1.285	0.97
	LTE 41	QPSK20M	Front Face	1.1	41490	1	50	DSI-2	Ant1	1	62.90	25.00	23.49	0.11	0.598	1.006	1.416	0.85
	LTE 41	QPSK20M	Front Face	1.1	40185	50	25	DSI-2	Ant1	1	62.90	25.00	22.71	0.13	0.400	1.006	1.694	0.68
	LTE 41	QPSK20M	Front Face	1.1	40620	50	25	DSI-2	Ant1	1	62.90	25.00	22.81	0.03	0.432	1.006	1.656	0.72
	LTE 41	QPSK20M	Front Face	1.1	41055	50	25	DSI-2	Ant1	1	62.90	25.00	22.71	-0.13	0.477	1.006	1.694	0.81
	LTE																	



BUREAU VERITAS

FCC SAR Test Report



Certificate #6613.01

Plot No.	Band	Mode	Test Position	Separation Distance (cm)	Ch.	RB#	RB Offset	Power State	Antenna	Sample	Duty Cycle %	Max. Tune-up Power (dBm)	Measured Conducted Power (dBm)	Power dB (dB)	Measured SAR-1g (W/kg)	Duty Cycle Scaling Factor	Tune-up Scaling Factor	Scaled SAR-1g (W/kg)
	LTE 41	QPSK20M	Rear Face	1	39750	1	50	DSI-4	Ant4	1	62.90	19.50	18.34	0.02	0.185	1.006	1.306	0.24
	LTE 41	QPSK20M	Left Side	1	39750	1	50	DSI-2	Ant4	1	62.90	25.00	23.73	0.11	0.247	1.006	1.340	0.33
	LTE 41	QPSK20M	Right Side	1	39750	1	50	DSI-2	Ant4	1	62.90	25.00	23.73	0.07	0.081	1.006	1.340	0.11
	LTE 41	QPSK20M	Top Side	1	39750	1	50	DSI-4	Ant4	1	62.90	19.50	18.34	-0.12	0.298	1.006	1.306	0.39
	LTE 41	QPSK20M	Front Face	1	39750	50	25	DSI-4	Ant4	1	62.90	19.50	18.20	0.09	0.141	1.006	1.349	0.19
	LTE 41	QPSK20M	Rear Face	1	39750	50	25	DSI-4	Ant4	1	62.90	19.50	18.20	0.14	0.181	1.006	1.349	0.25
	LTE 41	QPSK20M	Left Side	1	39750	50	25	DSI-2	Ant4	1	62.90	24.00	22.62	-0.09	0.184	1.006	1.374	0.25
	LTE 41	QPSK20M	Right Side	1	39750	50	25	DSI-2	Ant4	1	62.90	24.00	22.62	0.13	0.064	1.006	1.374	0.09
	LTE 41	QPSK20M	Top Side	1	39750	50	25	DSI-4	Ant4	1	62.90	19.50	18.20	0.05	0.294	1.006	1.349	0.40
	LTE 41	QPSK20M	Front Face	1.1	39750	1	50	DSI-2	Ant4	1	62.90	25.00	23.73	0.17	0.647	1.006	1.340	0.87
	LTE 41	QPSK20M	Rear Face	1.7	39750	1	50	DSI-2	Ant4	1	62.90	25.00	23.73	-0.07	0.290	1.006	1.340	0.39
	LTE 41	QPSK20M	Top Side	2.1	39750	1	50	DSI-2	Ant4	1	62.90	25.00	23.73	0.14	0.332	1.006	1.340	0.45
	LTE 41	QPSK20M	Front Face	1.1	39750	50	25	DSI-2	Ant4	1	62.90	24.00	22.62	0.05	0.382	1.006	1.374	0.53
	LTE 41	QPSK20M	Rear Face	1.7	39750	50	25	DSI-2	Ant4	1	62.90	24.00	22.62	-0.09	0.231	1.006	1.374	0.32
	LTE 41	QPSK20M	Top Side	2.1	39750	50	25	DSI-2	Ant4	1	62.90	24.00	22.62	0.13	0.258	1.006	1.374	0.36
	LTE 41	QPSK20M	Front Face	1.1	40185	1	50	DSI-2	Ant4	1	62.90	25.00	23.58	0.02	0.406	1.006	1.387	0.57
	LTE 41	QPSK20M	Front Face	1.1	40620	1	50	DSI-2	Ant4	1	62.90	25.00	23.70	-0.05	0.383	1.006	1.349	0.52
	LTE 41	QPSK20M	Front Face	1.1	41055	1	50	DSI-2	Ant4	1	62.90	25.00	23.60	0.11	0.348	1.006	1.380	0.48
	LTE 41	QPSK20M	Front Face	1.1	41490	1	50	DSI-2	Ant4	1	62.90	25.00	23.62	-0.09	0.304	1.006	1.374	0.42
	LTE 41	QPSK20M	Front Face	1.1	39750	100	0	DSI-2	Ant4	1	62.90	24.00	22.66	0.12	0.353	1.006	1.361	0.48
	LTE 66	QPSK20M	Front Face	1	132322	1	50	DSI-3/4	Ant1	1	-	22.50	21.18	0.13	0.246	1.000	1.355	0.33
	LTE 66	QPSK20M	Rear Face	1	132322	1	50	DSI-3/4	Ant1	1	-	22.50	21.18	-0.07	0.388	1.000	1.355	0.53
	LTE 66	QPSK20M	Left Side	1	132322	1	50	DSI-2	Ant1	1	-	25.50	24.26	0.12	0.263	1.000	1.330	0.35
	LTE 66	QPSK20M	Right Side	1	132322	1	50	DSI-2	Ant1	1	-	25.50	24.26	0.09	0.060	1.000	1.330	0.08
	LTE 66	QPSK20M	Bottom Side	1	132322	1	50	DSI-3/4	Ant1	1	-	22.50	21.18	0.13	0.669	1.000	1.355	0.91
	LTE 66	QPSK20M	Front Face	1	132322	50	25	DSI-3/4	Ant1	1	-	22.50	21.11	-0.06	0.255	1.000	1.377	0.35
	LTE 66	QPSK20M	Rear Face	1	132322	50	25	DSI-3/4	Ant1	1	-	22.50	21.11	0.11	0.392	1.000	1.377	0.54
	LTE 66	QPSK20M	Left Side	1	132322	50	25	DSI-2	Ant1	1	-	24.50	23.29	-0.05	0.178	1.000	1.321	0.24
	LTE 66	QPSK20M	Right Side	1	132322	50	25	DSI-2	Ant1	1	-	24.50	23.29	0.07	0.116	1.000	1.321	0.15
	LTE 66	QPSK20M	Bottom Side	1	132322	50	25	DSI-3/4	Ant1	1	-	22.50	21.11	0.13	0.666	1.000	1.377	0.92
	LTE 66	QPSK20M	Bottom Side	1	132072	1	50	DSI-3/4	Ant1	1	-	22.50	21.03	0.06	0.650	1.000	1.403	0.91
	LTE 66	QPSK20M	Bottom Side	1	132572	1	50	DSI-3/4	Ant1	1	-	22.50	21.15	0.18	0.605	1.000	1.365	0.83
	LTE 66	QPSK20M	Bottom Side	1	132072	50	25	DSI-3/4	Ant1	1	-	22.50	21.09	0.11	0.659	1.000	1.384	0.91
	LTE 66	QPSK20M	Bottom Side	1	132572	50	25	DSI-3/4	Ant1	1	-	22.50	21.06	-0.07	0.611	1.000	1.393	0.85
	LTE 66	QPSK20M	Bottom Side	1	132322	100	0	DSI-3/4	Ant1	1	-	22.50	20.98	0.12	0.643	1.000	1.419	0.91
	LTE 66	QPSK20M	Front Face	1.1	132322	1	50	DSI-2	Ant1	1	-	25.50	24.26	0.05	0.449	1.000	1.330	0.60
	LTE 66	QPSK20M	Rear Face	1.7	132322	1	50	DSI-2	Ant1	1	-	25.50	24.26	0.12	0.366	1.000	1.330	0.49
	LTE 66	QPSK20M	Bottom Side	2.1	132322	1	50	DSI-2	Ant1	1	-	25.50	24.26	-0.06	0.327	1.000	1.330	0.44
	LTE 66	QPSK20M	Front Face	1.1	132322	50	25	DSI-2	Ant1	1	-	24.50	23.29	0.11	0.362	1.000	1.321	0.48
	LTE 66	QPSK20M	Rear Face	1.7	132322	50	25	DSI-2	Ant1	1	-	24.50	23.29	0.08	0.288	1.000	1.321	0.38
	LTE 66	QPSK20M	Bottom Side	2.1	132322	50	25	DSI-2	Ant1	1	-	25.50	24.26	0.14	0.262	1.000	1.330	0.35
	LTE 66	QPSK20M	Front Face	1	132322	1	50	DSI-4	Ant4	1	-	19.50	18.18	0.08	0.371	1.000	1.355	0.50
	LTE 66	QPSK20M	Rear Face	1	132322	1	50	DSI-4	Ant4	1	-	19.50	18.18	0.18	0.638	1.000	1.355	0.86
	LTE 66	QPSK20M	Left Side	1	132322	1	50	DSI-2	Ant4	1	-	22.50	21.14	0.02	0.213	1.000	1.368	0.29
	LTE 66	QPSK20M	Right Side	1	132322	1	50	DSI-2	Ant4	1	-	22.50	21.14	0.08	0.113	1.000	1.368	0.15
	LTE 66	QPSK20M	Top Side	1	132322	1	50	DSI-4	Ant4	1	-	19.50	18.18	0.13	0.732	1.000	1.355	0.99
	LTE 66	QPSK20M	Front Face	1	132322	50	25	DSI-4	Ant4	1	-	19.50	17.96	-0.11	0.397	1.000	1.426	0.57
	LTE 66	QPSK20M	Rear Face	1	132322	50	25	DSI-4	Ant4	1	-	19.50	17.96	0.01	0.633	1.000	1.426	0.90
	LTE 66	QPSK20M	Left Side	1	132322	50	25	DSI-2	Ant4	1	-	22.50	20.98	0.03	0.171	1.000	1.419	0.24
	LTE 66	QPSK20M	Right Side	1	132322	50	25	DSI-2	Ant4	1	-	22.50	20.98	0.09	0.128	1.000	1.419	0.18
	LTE 66	QPSK20M	Top Side	1	132322	50	25	DSI-4	Ant4	1	-	19.50	17.96	0.05	0.748	1.000	1.426	1.07
	LTE 66	QPSK20M	Rear Face	1	132072	1	50	DSI-4	Ant4	1	-	19.50	18.14	0.09	0.580	1.000	1.368	0.79
	LTE 66	QPSK20M	Rear Face	1	132572	1	50	DSI-4	Ant4	1	-	19.50	18.09	0.16	0.437	1.000	1.384	0.60
	LTE 66	QPSK20M	Top Side	1	132072	1	50	DSI-4	Ant4	1	-	19.50	18.14	0.10	0.721	1.000	1.368	0.99
	LTE 66	QPSK20M	Top Side	1	132572	1	50	DSI-4	Ant4	1	-	19.50	18.09	0.04	0.640	1.000	1.384	0.89
	LTE 66	QPSK20M	Rear Face	1	132072	50	25	DSI-4	Ant4	1	-	19.50	17.91	-0.03	0.578	1.000	1.442	0.83
	LTE 66	QPSK20M	Rear Face	1	132572	50	25	DSI-4	Ant4	1	-	19.50	17.93	0.04	0.444	1.000	1.435	0.64
	LTE 66	QPSK20M	Top Side	1	132072	50	25	DSI-4	Ant4	1	-	19.50	17.91	-0.03	0.722	1.000	1.442	1.04
	LTE 66	QPSK20M	Top Side	1	132572	50	25	DSI-4	Ant4	1	-	19.50	17.93	-0.10	0.654	1.000	1.435	0.94
	LTE 66	QPSK20M	Rear Face	1	132322	100	0	DSI-4	Ant4	1	-	19.50	17.99	-0.11	0.568	1.000	1.416	0.80
43	LTE 66	QPSK20M	Top Side	1	132322	100	0	DSI-4	Ant4	1	-	19.50	17.99	0.05	0.772	1.000	1.416	1.09
	LTE 66	QPSK20M	Front Face	1.1	132322	1	50	DSI-2	Ant4	1	-	22.50	21.14	0.14	0.677	1.000	1.368	0.93
	LTE 66	QPSK20M	Rear Face	1.7	132322	1	50	DSI-2	Ant4	1	-	22.50	21.14	0.07	0.403	1.000	1.368	0.55
	LTE 66	QPSK20M	Top Side	2.1	132322	1	50	DSI-2	Ant4	1	-	22.50	21.14	0.03	0.243	1.000	1.368	0.33
	LTE 66	QPSK20M	Front Face	1.1	132322	50	25	DSI-2	Ant4	1	-	22.50	20.98	-0.09	0.670	1.000	1.419	0.95
	LTE 66	QPSK20M	Rear Face	1.7	132322	50	25	DSI-2	Ant4	1	-	22.50	20.98	0.03	0.403	1.000	1.419	0.57
	LTE 66	QPSK20M	Top Side	2.1	132322	50	25	DSI-2	Ant4	1	-	22.50	20.98	0.12	0.239	1.000	1.419	0.34
	LTE 66	QPSK20M	Front Face	1.1	132072	1	50	DSI-2	Ant4	1	-	22.50	21.09	0.03	0.677	1.000	1.384	0.94
	LTE 66	QPSK20M	Front Face	1.1	132572	1	50	DSI-2	Ant4	1	-	22.50	21.12	0.07	0.534	1.000	1.374	0.73
	LTE 66	QPSK20M	Front Face	1.1	132072	50	25	DSI-2	Ant4	1	-	22.50	20.86	0.03	0.710	1.000	1.459	1.04
	LTE 66	QPSK20M	Front Face	1.1	132572	50	25	DSI-2	Ant4	1	-	22.50	20.94	0.13	0.532	1.000	1.432	0.76
	LTE 66	QPSK20M	Front Face	1.1	132322	100	0	DSI-2	Ant4	1	-	22.50	20.95	-0.09	0.662	1.000	1.429	0.95
	LTE 66	QPSK20M	Top Side	1	132322	100	0	DSI-4	Ant4	2	-	19.50	17.99	0.04	0.708	1.000		



BUREAU VERITAS

FCC SAR Test Report



Certificate #6613.01

Plot No.	Band	Mode	Test Position	Separation Distance (cm)	Ch.	RB#	RB Offset	Power State	Antenna	Sample	Duty Cycle %	Max. Tune-up Power (dBm)	Measured Conducted Power (dBm)	Power Drift (dB)	Measured SAR-1g (W/kg)	Duty Cycle Scaling Factor	Tune-up Scaling Factor	Scaled SAR-1g (W/kg)
44	WLAN2.4G	802.11b	Front Face	1	11	-	-	DSI-2	Ant2	1	99.52	14.50	13.34	0.07	0.059	1.005	1.306	0.08
	WLAN2.4G	802.11b	Rear Face	1	11	-	-	DSI-2	Ant2	1	99.52	14.50	13.34	-0.11	0.155	1.005	1.306	0.20
	WLAN2.4G	802.11b	Left Side	1	11	-	-	DSI-2	Ant2	1	99.52	14.50	13.34	0.00	0.000	1.005	1.306	0.00
	WLAN2.4G	802.11b	Right Side	1	11	-	-	DSI-2	Ant2	1	99.52	14.50	13.34	-0.05	0.050	1.005	1.306	0.07
	WLAN2.4G	802.11b	Top Side	1	11	-	-	DSI-2	Ant2	1	99.52	14.50	13.34	0.12	0.081	1.005	1.306	0.11
	WLAN5G	802.11ac-VHT80	Front Face	1	42	-	-	DSI-2	Ant2	1	87.70	10.50	9.49	0.00	0.000	1.140	1.262	0.00
	WLAN5G	802.11ac-VHT80	Rear Face	1	42	-	-	DSI-2	Ant2	1	87.70	10.50	9.49	-0.09	0.141	1.140	1.262	0.20
	WLAN5G	802.11ac-VHT80	Left Side	1	42	-	-	DSI-2	Ant2	1	87.70	10.50	9.49	0.00	0.000	1.140	1.262	0.00
	WLAN5G	802.11ac-VHT80	Right Side	1	42	-	-	DSI-2	Ant2	1	87.70	10.50	9.49	0.00	0.000	1.140	1.262	0.00
45	WLAN5G	802.11ac-VHT80	Top Side	1	42	-	-	DSI-2	Ant2	1	87.70	10.50	9.49	-0.05	0.162	1.140	1.262	0.23
	WLAN5G	802.11ac-VHT80	Top Side	1	42	-	-	DSI-2	Ant2	2	87.70	10.50	9.49	-0.08	0.108	1.140	1.262	0.16
	WLAN5G	802.11ac-VHT80	Top Side	1	42	-	-	DSI-2	Ant2	3	87.70	10.50	9.49	0.03	0.112	1.140	1.262	0.16
	WLAN5G	802.11ac-VHT80	Top Side	1	42	-	-	DSI-2	Ant2	4	87.70	10.50	9.49	0.11	0.128	1.140	1.262	0.18
	WLAN5G	802.11ac-VHT80	Front Face	1	155	-	-	DSI-2	Ant2	1	87.70	10.50	9.77	0.00	0.000	1.140	1.183	0.00
	WLAN5G	802.11ac-VHT80	Rear Face	1	155	-	-	DSI-2	Ant2	1	87.70	10.50	9.77	0.05	0.078	1.140	1.183	0.11
	WLAN5G	802.11ac-VHT80	Left Side	1	155	-	-	DSI-2	Ant2	1	87.70	10.50	9.77	0.00	0.000	1.140	1.183	0.00
	WLAN5G	802.11ac-VHT80	Right Side	1	155	-	-	DSI-2	Ant2	1	87.70	10.50	9.77	0.00	0.000	1.140	1.183	0.00
46	WLAN5G	802.11ac-VHT80	Top Side	1	155	-	-	DSI-2	Ant2	1	87.70	10.50	9.77	-0.03	0.079	1.140	1.183	0.11
	BT	GFSK	Front Face	1	78	-	-	DSI-2	Ant2	1	76.70	11.00	9.98	-0.08	0.055	1.304	1.265	0.09
47	BT	GFSK	Rear Face	1	78	-	-	DSI-2	Ant2	1	76.70	11.00	9.98	0.03	0.064	1.304	1.265	0.11
	BT	GFSK	Left Side	1	78	-	-	DSI-2	Ant2	1	76.70	11.00	9.98	0.00	0.000	1.304	1.265	0.00
	BT	GFSK	Right Side	1	78	-	-	DSI-2	Ant2	1	76.70	11.00	9.98	0.14	0.036	1.304	1.265	0.06
	BT	GFSK	Top Side	1	78	-	-	DSI-2	Ant2	1	76.70	11.00	9.98	0.07	0.040	1.304	1.265	0.07

4.6.5 SAR Results for Extremity Exposure Condition (Separation Distance is 0 cm Gap)

Plot No.	Band	Mode	Test Position	Separation Distance (cm)	Ch.	RB#	RB Offset	Power State	Antenna	Sample	Duty Cycle %	Max. Tune-up Power (dBm)	Measured Conducted Power (dBm)	Power Drift (dB)	Measured SAR-10g (W/kg)	Duty Cycle Scaling Factor	Tune-up Scaling Factor	Scaled SAR-10g (W/kg)
48	GSM1900	GPRS 1Tx Slot	Rear Face	0	810	-	-	DSI-4	Ant4	1	-	27.00	26.05	0.17	0.843	1.000	1.245	1.05
	GSM1900	GPRS 1Tx Slot	Top Side	0	810	-	-	DSI-4	Ant4	1	-	27.00	26.05	0.01	1.280	1.000	1.245	1.59
	WCDMA II	RMC12.2K	Rear Face	0	9538	-	-	DSI-3/4	Ant1	1	-	22.00	20.89	0.09	1.470	1.000	1.291	1.90
	WCDMA II	RMC12.2K	Bottom Side	0	9538	-	-	DSI-3/4	Ant1	1	-	22.00	20.89	0.11	1.580	1.000	1.291	2.04
49	WCDMA II	RMC12.2K	Bottom Side	0	9262	-	-	DSI-3/4	Ant1	1	-	22.00	20.75	-0.05	1.450	1.000	1.334	1.93
	WCDMA II	RMC12.2K	Bottom Side	0	9400	-	-	DSI-3/4	Ant1	1	-	22.00	20.81	0.14	1.800	1.000	1.315	2.37
	WCDMA II	RMC12.2K	Front Face	0	9538	-	-	DSI-4	Ant4	1	-	18.50	17.51	0.14	0.890	1.000	1.256	1.12
	WCDMA II	RMC12.2K	Rear Face	0	9538	-	-	DSI-4	Ant4	1	-	18.50	17.51	0.07	1.030	1.000	1.256	1.29
	WCDMA II	RMC12.2K	Top Side	0	9538	-	-	DSI-4	Ant4	1	-	18.50	17.51	0.11	1.390	1.000	1.256	1.75
50	WCDMA IV	RMC12.2K	Bottom Side	0	1413	-	-	DSI-3/4	Ant1	1	-	21.50	20.25	0.05	1.560	1.000	1.334	2.08
	WCDMA IV	RMC12.2K	Bottom Side	0	1312	-	-	DSI-3/4	Ant1	1	-	21.50	20.22	0.06	1.350	1.000	1.343	1.81
	WCDMA IV	RMC12.2K	Bottom Side	0	1513	-	-	DSI-3/4	Ant1	1	-	21.50	20.17	0.15	1.290	1.000	1.358	1.75
	WCDMA IV	RMC12.2K	Front Face	0	1312	-	-	DSI-4	Ant4	1	-	19.00	17.92	0.07	0.909	1.000	1.282	1.17
	WCDMA IV	RMC12.2K	Rear Face	0	1312	-	-	DSI-4	Ant4	1	-	19.00	17.92	-0.12	0.848	1.000	1.282	1.09
	WCDMA IV	RMC12.2K	Top Side	0	1312	-	-	DSI-4	Ant4	1	-	19.00	17.92	0.02	1.170	1.000	1.282	1.50
	LTE 2	QPSK20M	Rear Face	0	18700	1	50	DSI-3/4	Ant1	1	-	22.00	20.58	0.13	1.360	1.000	1.387	1.89
	LTE 2	QPSK20M	Bottom Side	0	18700	1	50	DSI-3/4	Ant1	1	-	22.00	20.58	-0.06	1.450	1.000	1.387	2.01
	LTE 2	QPSK20M	Rear Face	0	18700	50	25	DSI-3/4	Ant1	1	-	22.00	20.38	0.12	1.350	1.000	1.452	1.96
	LTE 2	QPSK20M	Bottom Side	0	18700	50	25	DSI-3/4	Ant1	1	-	22.00	20.38	0.08	1.460	1.000	1.452	2.12
	LTE 2	QPSK20M	Bottom Side	0	18900	1	50	DSI-3/4	Ant1	1	-	22.00	20.54	0.12	1.570	1.000	1.400	2.20
51	LTE 2	QPSK20M	Bottom Side	0	19100	1	50	DSI-3/4	Ant1	1	-	22.00	20.49	0.11	1.550	1.000	1.416	2.19
	LTE 2	QPSK20M	Bottom Side	0	18900	50	25	DSI-3/4	Ant1	1	-	22.00	20.30	0.07	1.720	1.000	1.479	2.54
	LTE 2	QPSK20M	Bottom Side	0	19100	50	25	DSI-3/4	Ant1	1	-	22.00	20.35	-0.02	1.550	1.000	1.462	2.27
	LTE 2	QPSK20M	Bottom Side	0	18700	100	0	DSI-3/4	Ant1	1	-	22.00	20.43	0.11	1.450	1.000	1.435	2.08
	LTE 2	QPSK20M	Front Face	0	18700	1	50	DSI-4	Ant4	1	-	18.50	17.35	0.03	0.546	1.000	1.303	0.71
	LTE 2	QPSK20M	Rear Face	0	18700	1	50	DSI-4	Ant4	1	-	18.50	17.35	0.12	0.675	1.000	1.303	0.88
	LTE 2	QPSK20M	Top Side	0	18700	1	50	DSI-4	Ant4	1	-	18.50	17.35	-0.06	1.370	1.000	1.303	1.79
	LTE 2	QPSK20M	Front Face	0	18700	50	25	DSI-4	Ant4	1	-	18.50	17.01	0.05	0.560	1.000	1.409	0.79
	LTE 2	QPSK20M	Rear Face	0	18700	50	25	DSI-4	Ant4	1	-	18.50	17.01	0.13	0.616	1.000	1.409	0.87
	LTE 2	QPSK20M	Top Side	0	18700	50	25	DSI-4	Ant4	1	-	18.50	17.01	0.07	1.390	1.000	1.409	1.96
	LTE 7	QPSK20M	Front Face	0	20850	1	50	DSI-3/4	Ant1	1	-	18.50	17.62	0.14	0.717	1.000	1.225	0.88
	LTE 7	QPSK20M	Rear Face	0	20850	1	50	DSI-3/4	Ant1	1	-	18.50	17.62	0.05	1.260	1.000	1.225	1.54
	LTE 7	QPSK20M	Bottom Side	0	20850	1	50	DSI-3/4	Ant1	1	-	18.50	17.62	0.11	1.340	1.000	1.225	1.64
	LTE 7	QPSK20M	Front Face	0	20850	50	25	DSI-3/4	Ant1	1	-	18.50	17.46	-0.06	0.770	1.000	1.271	0.98
	LTE 7	QPSK20M	Rear Face	0	20850	50	25	DSI-3/4	Ant1	1	-	18.50	17.46	0.02	1.280	1.000	1.271	1.63
	LTE 7	QPSK20M	Bottom Side	0	20850	50	25	DSI-3/4	Ant1	1	-	18.50	17.46	0.13	1.340	1.000	1.271	1.70
	LTE 7	QPSK20M	Front Face	0	20850	1	50	DSI-4	Ant4	1	-	17.50	16.01	0.05	0.373	1.000	1.409	0.53
	LTE 7	QPSK20M	Rear Face	0	20850	1	50	DSI-4	Ant4	1	-	17.50	16.01	-0.07	0.541	1.000	1.409	0.76
	LTE 7	QPSK20M	Top Side	0	20850	1	50	DSI-4	Ant4	1	-	17.50	16.01	0.12	1.290	1.000	1.409	1.82
	LTE 7	QPSK20M	Front Face	0	20850	50	50	DSI-4	Ant4	1	-	17.50	15.94	0.09	0.424	1.000	1.432	0.61
	LTE 7	QPSK20M	Rear Face	0	20850	50	50	DSI-4	Ant4	1	-	17.50	15.94	0.11	0.553	1.000	1.432	0.79
52	LTE 7	QPSK20M	Top Side	0	20850	50	50	DSI-4	Ant4	1	-	17.50	15.94	0.06	1.480	1.000	1.432	2.12



BUREAU VERITAS

FCC SAR Test Report



Certificate #6613.01

Plot No.	Band	Mode	Test Position	Separation Distance (cm)	Ch.	RB#	RB Offset	Power State	Antenna	Sample	Duty Cycle %	Max. Tune-up Power (dBm)	Measured Conducted Power (dBm)	Power Drift (dB)	Measured SAR-10g (W/kg)	Duty Cycle Scaling Factor	Tune-up Scaling Factor	Scaled SAR-10g (W/kg)
	LTE 7	QPSK20M	Top Side	0	21100	50	50	DSI-4	Ant4	1	-	17.50	15.92	-0.04	1.220	1.000	1.439	1.76
	LTE 7	QPSK20M	Top Side	0	21350	50	50	DSI-4	Ant4	1	-	17.50	15.89	0.12	1.150	1.000	1.449	1.67
	LTE 7	QPSK20M	Top Side	0	20850	100	0	DSI-4	Ant4	1	-	17.50	15.92	0.07	1.320	1.000	1.439	1.90
	LTE 38	QPSK20M	Rear Face	0	38000	1	50	DSI-3/4	Ant1	1	62.90	20.00	18.87	0.11	1.160	1.006	1.297	1.51
	LTE 38	QPSK20M	Bottom Side	0	38000	1	50	DSI-3/4	Ant1	1	62.90	20.00	18.87	-0.04	0.984	1.006	1.297	1.28
	LTE 38	QPSK20M	Rear Face	0	38000	50	25	DSI-3/4	Ant1	1	62.90	20.00	18.79	0.02	1.090	1.006	1.321	1.45
	LTE 38	QPSK20M	Bottom Side	0	38000	50	25	DSI-3/4	Ant1	1	62.90	20.00	18.79	0.13	0.994	1.006	1.321	1.32
	LTE 38	QPSK20M	Top Side	0	38000	1	50	DSI-4	Ant4	1	62.90	20.00	18.53	0.09	1.150	1.006	1.403	1.62
53	LTE 38	QPSK20M	Top Side	0	38000	50	25	DSI-4	Ant4	1	62.90	20.00	18.42	0.06	1.320	1.006	1.439	1.91
	LTE 41	QPSK20M	Rear Face	0	39750	1	50	DSI-3/4	Ant1	1	62.90	19.50	18.41	0.05	0.931	1.006	1.285	1.20
	LTE 41	QPSK20M	Bottom Side	0	39750	1	50	DSI-3/4	Ant1	1	62.90	19.50	18.41	0.12	1.010	1.006	1.285	1.31
	LTE 41	QPSK20M	Rear Face	0	39750	50	25	DSI-3/4	Ant1	1	62.90	19.50	18.35	-0.03	0.932	1.006	1.303	1.22
	LTE 41	QPSK20M	Bottom Side	0	39750	50	25	DSI-3/4	Ant1	1	62.90	19.50	18.35	0.14	1.010	1.006	1.303	1.32
	LTE 41	QPSK20M	Top Side	0	39750	1	50	DSI-4	Ant4	1	62.90	19.50	18.34	0.05	1.260	1.006	1.306	1.66
54	LTE 41	QPSK20M	Top Side	0	39750	50	25	DSI-4	Ant4	1	62.90	19.50	18.20	0.07	1.350	1.006	1.349	1.83
	LTE 41	QPSK20M	Top Side	0	40185	1	50	DSI-4	Ant4	1	62.90	19.50	18.30	0.09	1.170	1.006	1.318	1.55
	LTE 41	QPSK20M	Top Side	0	40620	1	50	DSI-4	Ant4	1	62.90	19.50	18.24	-0.14	1.040	1.006	1.337	1.40
	LTE 41	QPSK20M	Top Side	0	41055	1	50	DSI-4	Ant4	1	62.90	19.50	18.08	0.07	0.945	1.006	1.387	1.32
	LTE 41	QPSK20M	Top Side	0	41490	1	50	DSI-4	Ant4	1	62.90	19.50	18.12	-0.12	0.864	1.006	1.374	1.19
	LTE 41	QPSK20M	Top Side	0	40185	50	25	DSI-4	Ant4	1	62.90	19.50	17.95	0.05	1.170	1.006	1.429	1.68
	LTE 41	QPSK20M	Top Side	0	40620	50	25	DSI-4	Ant4	1	62.90	19.50	18.13	0.16	1.050	1.006	1.371	1.45
	LTE 41	QPSK20M	Top Side	0	41055	50	25	DSI-4	Ant4	1	62.90	19.50	17.98	0.07	0.939	1.006	1.419	1.34
	LTE 41	QPSK20M	Top Side	0	41490	50	25	DSI-4	Ant4	1	62.90	19.50	17.95	-0.09	0.858	1.006	1.429	1.23
	LTE 41	QPSK20M	Top Side	0	39750	100	0	DSI-4	Ant4	1	62.90	19.50	18.12	0.11	1.270	1.006	1.374	1.76
	LTE 66	QPSK20M	Bottom Side	0	132322	1	50	DSI-3/4	Ant1	1	-	22.50	21.18	0.06	1.580	1.000	1.355	2.14
	LTE 66	QPSK20M	Bottom Side	0	132322	50	25	DSI-3/4	Ant1	1	-	22.50	21.11	-0.14	1.630	1.000	1.377	2.24
	LTE 66	QPSK20M	Bottom Side	0	132072	1	50	DSI-3/4	Ant1	1	-	22.50	21.03	0.07	1.610	1.000	1.403	2.26
	LTE 66	QPSK20M	Bottom Side	0	132572	1	50	DSI-3/4	Ant1	1	-	22.50	21.15	0.09	1.480	1.000	1.365	2.02
55	LTE 66	QPSK20M	Bottom Side	0	132072	50	25	DSI-3/4	Ant1	1	-	22.50	21.09	0.07	1.860	1.000	1.384	2.57
	LTE 66	QPSK20M	Bottom Side	0	132572	50	25	DSI-3/4	Ant1	1	-	22.50	21.06	0.11	1.520	1.000	1.393	2.12
	LTE 66	QPSK20M	Bottom Side	0	132322	100	0	DSI-3/4	Ant1	1	-	22.50	20.98	-0.05	1.590	1.000	1.419	2.26
	LTE 66	QPSK20M	Bottom Side	0	132072	50	25	DSI-3/4	Ant1	2	-	22.50	21.09	0.06	1.780	1.000	1.384	2.46
	LTE 66	QPSK20M	Bottom Side	0	132072	50	25	DSI-3/4	Ant1	3	-	22.50	21.09	-0.07	1.720	1.000	1.384	2.38
	LTE 66	QPSK20M	Bottom Side	0	132072	50	25	DSI-3/4	Ant1	4	-	22.50	21.09	0.18	1.820	1.000	1.384	2.52
	LTE 66	QPSK20M	Front Face	0	132322	1	50	DSI-4	Ant4	1	-	19.50	18.18	0.15	1.010	1.000	1.355	1.37
	LTE 66	QPSK20M	Rear Face	0	132322	1	50	DSI-4	Ant4	1	-	19.50	18.18	0.06	0.907	1.000	1.355	1.23
	LTE 66	QPSK20M	Top Side	0	132322	1	50	DSI-4	Ant4	1	-	19.50	18.18	-0.07	1.180	1.000	1.355	1.60
	LTE 66	QPSK20M	Front Face	0	132322	50	25	DSI-4	Ant4	1	-	19.50	17.96	0.18	1.030	1.000	1.426	1.47
	LTE 66	QPSK20M	Rear Face	0	132322	50	25	DSI-4	Ant4	1	-	19.50	17.96	0.02	0.976	1.000	1.426	1.39
	LTE 66	QPSK20M	Top Side	0	132322	50	25	DSI-4	Ant4	1	-	19.50	17.96	0.13	1.170	1.000	1.426	1.67
	WLAN5G	802.11n-HT20	Front Face	0	64	-	-	DSI-2	Ant2	1	93.00	10.50	9.41	0.11	0.140	1.075	1.285	0.19
56	WLAN5G	802.11n-HT20	Rear Face	0	64	-	-	DSI-2	Ant2	1	93.00	10.50	9.41	0.01	0.207	1.075	1.285	0.29
	WLAN5G	802.11n-HT20	Left Side	0	64	-	-	DSI-2	Ant2	1	93.00	10.50	9.41	0.00	0.000	1.075	1.285	0.00
	WLAN5G	802.11n-HT20	Right Side	0	64	-	-	DSI-2	Ant2	1	93.00	10.50	9.41	-0.09	0.074	1.075	1.285	0.10
	WLAN5G	802.11n-HT20	Top Side	0	64	-	-	DSI-2	Ant2	1	93.00	10.50	9.41	0.13	0.175	1.075	1.285	0.24
	WLAN5G	802.11n-HT20	Rear Face	0	64	-	-	DSI-2	Ant2	2	93.00	10.50	9.41	0.05	0.122	1.075	1.285	0.17
	WLAN5G	802.11n-HT20	Rear Face	0	64	-	-	DSI-2	Ant2	3	93.00	10.50	9.41	-0.02	0.145	1.075	1.285	0.20
	WLAN5G	802.11n-HT20	Rear Face	0	64	-	-	DSI-2	Ant2	4	93.00	10.50	9.41	0.15	0.166	1.075	1.285	0.23
	WLAN5G	802.11n-HT20	Front Face	0	140	-	-	DSI-2	Ant2	1	93.00	10.50	9.38	0.13	0.072	1.075	1.294	0.10
57	WLAN5G	802.11n-HT20	Rear Face	0	140	-	-	DSI-2	Ant2	1	93.00	10.50	9.38	0.02	0.128	1.075	1.294	0.18
	WLAN5G	802.11n-HT20	Left Side	0	140	-	-	DSI-2	Ant2	1	93.00	10.50	9.38	0.00	0.000	1.075	1.294	0.00
	WLAN5G	802.11n-HT20	Right Side	0	140	-	-	DSI-2	Ant2	1	93.00	10.50	9.38	0.08	0.051	1.075	1.294	0.07
	WLAN5G	802.11n-HT20	Top Side	0	140	-	-	DSI-2	Ant2	1	93.00	10.50	9.38	0.12	0.115	1.075	1.294	0.16

Note : When the hotspot SAR is adjusted for maximum tune-up tolerance and the result is <1.2W/kg, the extremity SAR is not required.

4.6.6 SAR Measurement Variability

According to KDB 865664 D01, SAR measurement variability was assessed for each frequency band, which is determined by the SAR probe calibration point and tissue-equivalent medium used for the device measurements. When both head and body tissue-equivalent media are required for SAR measurements in a frequency band, the variability measurement procedures should be applied to the tissue medium with the highest measured SAR, using the highest measured SAR configuration for that tissue-equivalent medium. Alternatively, if the highest measured SAR for both head and body tissue-equivalent media are ≤ 1.45 W/kg and the ratio of these highest SAR values, i.e., largest divided by smallest value, is ≤ 1.10 , the highest SAR configuration for either head or body tissue-equivalent medium may be used to perform the repeated measurement. These additional measurements are repeated after the completion of all measurements requiring the same head or body tissue-equivalent medium in a frequency band. The test device should be returned to ambient conditions (normal room temperature) with the battery fully charged before it is re-mounted on the device holder for the repeated measurement(s) to minimize any unexpected variations in the repeated results.

SAR repeated measurement procedure:

1. When the highest measured SAR is < 0.80 W/kg, repeated measurement is not required.
2. When the highest measured SAR is ≥ 0.80 W/kg, repeat that measurement once.
3. If the ratio of largest to smallest SAR for the original and first repeated measurements is > 1.20 , or when the original or repeated measurement is ≥ 1.45 W/kg, perform a second repeated measurement.
4. If the ratio of largest to smallest SAR for the original, first and second repeated measurements is > 1.20 , and the original, first or second repeated measurement is ≥ 1.5 W/kg, perform a third repeated measurement.

Band	Test Position	Ch.	Original Measured SAR-1g (W/kg)	1st Repeated SAR-1g (W/kg)	L/S Ratio	2nd Repeated SAR-1g (W/kg)	L/S Ratio	3rd Repeated SAR-1g (W/kg)	L/S Ratio
GSM850	Right Cheek	251	0.833	0.809	1.030	N/A	N/A	N/A	N/A
WCDMA II	Right Tilted	9538	0.739	0.712	1.038	N/A	N/A	N/A	N/A
LTE 66	Right Tilted	132072	0.685	0.624	1.098	N/A	N/A	N/A	N/A
LTE 2	Front Face at 11mm	19100	0.772	0.739	1.045	N/A	N/A	N/A	N/A
LTE 7	Front Face at 11mm	21350	0.825	0.809	1.020	N/A	N/A	N/A	N/A
LTE 66	Front Face at 11mm	132072	0.71	0.674	1.053	N/A	N/A	N/A	N/A
LTE 66	Top Side at 10mm	132322	0.772	0.744	1.038	N/A	N/A	N/A	N/A
LTE 2	Bottom Side at 0mm	18900	1.72	1.68	1.024	N/A	N/A	N/A	N/A
LTE 7	Top Side at 0mm	20850	1.48	1.41	1.050	N/A	N/A	N/A	N/A
LTE 66	Bottom Side at 0mm	132072	1.86	1.83	1.016	N/A	N/A	N/A	N/A

4.6.7 Simultaneous Multi-band Transmission Evaluation

<SAR Summation Analysis>

Simultaneous transmission SAR test exclusion is determined for each operating configuration and exposure condition according to the reported standalone SAR of each applicable simultaneous transmitting antenna. When the sum of SAR_{1g} of all simultaneously transmitting antennas in an operating mode and exposure condition combination is within the SAR limit (SAR_{1g} 1.6 W/kg), the simultaneous transmission SAR is not required. When the sum of SAR_{1g} is greater than the SAR limit (SAR_{1g} 1.6 W/kg), SAR test exclusion is determined by the SPLSR.



BUREAU VERITAS

FCC SAR Test Report



Certificate #6613.01

< Head Exposure Condition >

WWAN Band	Exposure Position	1	2	3	4	1+2 Summed 1g SAR (W/kg)	1+3 Summed 1g SAR (W/kg)	1+4 Summed 1g SAR (W/kg)	1+3+4 Summed 1g SAR (W/kg)
		WWAN	2.4GHz WLAN	5GHz WLAN	Bluetooth				
		1g SAR (W/kg)	1g SAR (W/kg)	1g SAR (W/kg)	1g SAR (W/kg)				
GSM850	Right Cheek at 0mm	1.034	0.169	0.145	0.086	1.20	1.18	1.12	1.26
	Right Tilted at 0mm	0.622	0.157	0.175	0.086	0.78	0.80	0.71	0.88
	Left Cheek at 0mm	0.767	0.440	0.243	0.246	1.21	1.01	1.01	1.26
	Left Tilted at 0mm	0.647	0.324	0.425	0.167	0.97	1.07	0.81	1.24
GSM1900	Right Cheek at 0mm	0.674	0.169	0.145	0.086	0.84	0.82	0.76	0.90
	Right Tilted at 0mm	0.886	0.157	0.175	0.086	1.04	1.06	0.97	1.15
	Left Cheek at 0mm	0.457	0.440	0.243	0.246	0.90	0.70	0.70	0.95
	Left Tilted at 0mm	0.534	0.324	0.425	0.167	0.86	0.96	0.70	1.13
WCDMA II	Right Cheek at 0mm	0.763	0.169	0.145	0.086	0.93	0.91	0.85	0.99
	Right Tilted at 0mm	0.985	0.157	0.175	0.086	1.14	1.16	1.07	1.25
	Left Cheek at 0mm	0.496	0.440	0.243	0.246	0.94	0.74	0.74	0.98
	Left Tilted at 0mm	0.581	0.324	0.425	0.167	0.91	1.01	0.75	1.17
WCDMA IV	Right Cheek at 0mm	0.750	0.169	0.145	0.086	0.92	0.89	0.84	0.98
	Right Tilted at 0mm	0.917	0.157	0.175	0.086	1.07	1.09	1.00	1.18
	Left Cheek at 0mm	0.506	0.440	0.243	0.246	0.95	0.75	0.75	0.99
	Left Tilted at 0mm	0.568	0.324	0.425	0.167	0.89	0.99	0.73	1.16
WCDMA V	Right Cheek at 0mm	0.893	0.169	0.145	0.086	1.06	1.04	0.98	1.12
	Right Tilted at 0mm	0.630	0.157	0.175	0.086	0.79	0.81	0.72	0.89
	Left Cheek at 0mm	0.729	0.440	0.243	0.246	1.17	0.97	0.97	1.22
	Left Tilted at 0mm	0.608	0.324	0.425	0.167	0.93	1.03	0.78	1.20
LTE Band 2	Right Cheek at 0mm	0.474	0.169	0.145	0.086	0.64	0.62	0.56	0.70
	Right Tilted at 0mm	0.632	0.157	0.175	0.086	0.79	0.81	0.72	0.89
	Left Cheek at 0mm	0.313	0.440	0.243	0.246	0.75	0.56	0.56	0.80
	Left Tilted at 0mm	0.366	0.324	0.425	0.167	0.69	0.79	0.53	0.96
LTE Band 5	Right Cheek at 0mm	0.934	0.169	0.145	0.086	1.10	1.08	1.02	1.17
	Right Tilted at 0mm	0.676	0.157	0.175	0.086	0.83	0.85	0.76	0.94
	Left Cheek at 0mm	0.773	0.440	0.243	0.246	1.21	1.02	1.02	1.26
	Left Tilted at 0mm	0.671	0.324	0.425	0.167	0.99	1.10	0.84	1.26
LTE Band 7	Right Cheek at 0mm	0.518	0.169	0.145	0.086	0.69	0.66	0.60	0.75
	Right Tilted at 0mm	0.732	0.157	0.175	0.086	0.89	0.91	0.82	0.99
	Left Cheek at 0mm	0.454	0.440	0.243	0.246	0.89	0.70	0.70	0.94
	Left Tilted at 0mm	0.503	0.324	0.425	0.167	0.83	0.93	0.67	1.09
LTE Band 38	Right Cheek at 0mm	0.461	0.169	0.145	0.086	0.63	0.61	0.55	0.69
	Right Tilted at 0mm	0.628	0.157	0.175	0.086	0.79	0.80	0.71	0.89
	Left Cheek at 0mm	0.435	0.440	0.243	0.246	0.88	0.68	0.68	0.92
	Left Tilted at 0mm	0.433	0.324	0.425	0.167	0.76	0.86	0.60	1.02



BUREAU
VERITAS

FCC SAR Test Report



Certificate #6613.01

WWAN Band	Exposure Position	1	2	3	4	1+2 Summed 1g SAR (W/kg)	1+3 Summed 1g SAR (W/kg)	1+4 Summed 1g SAR (W/kg)	1+3+4 Summed 1g SAR (W/kg)
		WWAN 1g SAR (W/kg)	2.4GHz WLAN 1g SAR (W/kg)	5GHz WLAN 1g SAR (W/kg)	Bluetooth 1g SAR (W/kg)				
LTE Band 41	Right Cheek at 0mm	0.551	0.169	0.145	0.086	0.72	0.70	0.64	0.78
	Right Tilted at 0mm	0.788	0.157	0.175	0.086	0.95	0.96	0.87	1.05
	Left Cheek at 0mm	0.462	0.440	0.243	0.246	0.90	0.70	0.71	0.95
	Left Tilted at 0mm	0.526	0.324	0.425	0.167	0.85	0.95	0.69	1.12
LTE Band 66	Right Cheek at 0mm	0.725	0.169	0.145	0.086	0.89	0.87	0.81	0.96
	Right Tilted at 0mm	0.979	0.157	0.175	0.086	1.14	1.15	1.06	1.24
	Left Cheek at 0mm	0.481	0.440	0.243	0.246	0.92	0.72	0.73	0.97
	Left Tilted at 0mm	0.535	0.324	0.425	0.167	0.86	0.96	0.70	1.13



BUREAU VERITAS

FCC SAR Test Report



Certificate #6613.01

< Body Worn Exposure Condition >

WWAN Band	Exposure Position	1	2	3	4	1+2 Summed 1g SAR (W/kg)	1+3 Summed 1g SAR (W/kg)	1+4 Summed 1g SAR (W/kg)	1+3+4 Summed 1g SAR (W/kg)
		WWAN 1g SAR (W/kg)	2.4GHz WLAN 1g SAR (W/kg)	5GHz WLAN 1g SAR (W/kg)	Bluetooth 1g SAR (W/kg)				
GSM850	Front at 10mm -	0.239	0.077	0.000	0.091	0.32	0.24	0.33	0.33
	Back at 10mm -	0.418	0.203	0.323	0.106	0.62	0.74	0.52	0.85
GSM1900	Front at 10mm -	0.359	0.077	0.000	0.091	0.44	0.36	0.45	0.45
	Back at 10mm -	0.824	0.203	0.323	0.106	1.03	1.15	0.93	1.25
	Front at 11mm -	0.621	0.077	0.000	0.091	0.70	0.62	0.71	0.71
	Back at 17mm -	0.673	0.203	0.323	0.106	0.88	1.00	0.78	1.10
WCDMA II	Front at 10mm -	0.531	0.077	0.000	0.091	0.61	0.53	0.62	0.62
	Back at 10mm -	0.912	0.203	0.323	0.106	1.12	1.24	1.02	1.34
	Front at 11mm -	1.058	0.077	0.000	0.091	1.14	1.06	1.15	1.15
	Back at 17mm -	0.824	0.203	0.323	0.106	1.03	1.15	0.93	1.25
WCDMA IV	Front at 10mm -	0.418	0.077	0.000	0.091	0.50	0.42	0.51	0.51
	Back at 10mm -	0.709	0.203	0.323	0.106	0.91	1.03	0.82	1.14
	Front at 11mm -	0.644	0.077	0.000	0.091	0.72	0.64	0.73	0.73
	Back at 17mm -	0.508	0.203	0.323	0.106	0.71	0.83	0.61	0.94
WCDMA V	Front at 10mm -	0.297	0.077	0.000	0.091	0.37	0.30	0.39	0.39
	Back at 10mm -	0.535	0.203	0.323	0.106	0.74	0.86	0.64	0.96
LTE Band 2	Front at 10mm -	0.431	0.077	0.000	0.091	0.51	0.43	0.52	0.52
	Back at 10mm -	0.916	0.203	0.323	0.106	1.12	1.24	1.02	1.35
	Front at 11mm -	1.083	0.077	0.000	0.091	1.16	1.08	1.17	1.17
	Back at 17mm -	0.521	0.203	0.323	0.106	0.72	0.84	0.63	0.95
LTE Band 5	Front at 10mm -	0.347	0.077	0.000	0.091	0.42	0.35	0.44	0.44
	Back at 10mm -	0.569	0.203	0.323	0.106	0.77	0.89	0.68	1.00
LTE Band 7	Front at 10mm -	0.272	0.077	0.000	0.091	0.35	0.27	0.36	0.36
	Back at 10mm -	0.550	0.203	0.323	0.106	0.75	0.87	0.66	0.98
	Front at 11mm -	1.078	0.077	0.000	0.091	1.16	1.08	1.17	1.17
	Back at 17mm -	0.702	0.203	0.323	0.106	0.91	1.03	0.81	1.13
LTE Band 38	Front at 10mm -	0.285	0.077	0.000	0.091	0.36	0.28	0.38	0.38
	Back at 10mm -	0.592	0.203	0.323	0.106	0.80	0.92	0.70	1.02
	Front at 11mm -	0.838	0.077	0.000	0.091	0.92	0.84	0.93	0.93
	Back at 17mm -	0.562	0.203	0.323	0.106	0.77	0.89	0.67	0.99
LTE Band 41	Front at 10mm -	0.215	0.077	0.000	0.091	0.29	0.22	0.31	0.31
	Back at 10mm -	0.493	0.203	0.323	0.106	0.70	0.82	0.60	0.92
	Front at 11mm -	0.968	0.077	0.000	0.091	1.04	0.97	1.06	1.06
	Back at 17mm -	0.536	0.203	0.323	0.106	0.74	0.86	0.64	0.97
LTE Band 66	Front at 10mm -	0.566	0.077	0.000	0.091	0.64	0.57	0.66	0.66
	Back at 10mm -	0.902	0.203	0.323	0.106	1.11	1.23	1.01	1.33



BUREAU
VERITAS

FCC SAR Test Report



Certificate #6613.01

WWAN Band	Exposure Position	1	2	3	4	1+2 Summed 1g SAR (W/kg)	1+3 Summed 1g SAR (W/kg)	1+4 Summed 1g SAR (W/kg)	1+3+4 Summed 1g SAR (W/kg)
		WWAN	2.4GHz WLAN	5GHz WLAN	Bluetooth				
		1g SAR (W/kg)	1g SAR (W/kg)	1g SAR (W/kg)	1g SAR (W/kg)				
	Front at 11mm -	1.036	0.077	0.000	0.091	1.11	1.04	1.13	1.13
	Back at 17mm -	0.572	0.203	0.323	0.106	0.78	0.90	0.68	1.00



BUREAU VERITAS

FCC SAR Test Report



Certificate #6613.01

< Hotspot Exposure Condition >

WWAN Band	Exposure Position	1	2	3	4	1+2 Summed 1g SAR (W/kg)	1+3 Summed 1g SAR (W/kg)	1+4 Summed 1g SAR (W/kg)	1+3+4 Summed 1g SAR (W/kg)
		WWAN	2.4GHz WLAN	5GHz WLAN	Bluetooth				
		1g SAR (W/kg)	1g SAR (W/kg)	1g SAR (W/kg)	1g SAR (W/kg)				
GSM850	Front at 10mm -	0.239	0.077	0.000	0.091	0.32	0.24	0.33	0.33
	Back at 10mm -	0.418	0.203	0.203	0.106	0.62	0.62	0.52	0.73
	Left side at 10mm -	0.080	0.000	0.000	0.000	0.08	0.08	0.08	0.08
	Right side at 10mm -	0.120	0.066	0.000	0.059	0.19	0.12	0.18	0.18
	Top side at 10mm -	0.173	0.106	0.233	0.066	0.28	0.41	0.24	0.47
	Bottom side at 10mm -	0.171				0.17	0.17	0.17	0.17
GSM1900	Front at 10mm -	0.359	0.077	0.000	0.091	0.44	0.36	0.45	0.45
	Back at 10mm -	0.824	0.203	0.203	0.106	1.03	1.03	0.93	1.13
	Left side at 10mm -	0.224	0.000	0.000	0.000	0.22	0.22	0.22	0.22
	Right side at 10mm -	0.000	0.066	0.000	0.059	0.07	0.00	0.06	0.06
	Top side at 10mm -	0.686	0.106	0.233	0.066	0.79	0.92	0.75	0.98
	Bottom side at 10mm -	0.522				0.52	0.52	0.52	0.52
	Front at 11mm -	0.621	0.077	0.000	0.091	0.70	0.62	0.71	0.71
	Back at 17mm -	0.673	0.203	0.203	0.106	0.88	0.88	0.78	0.98
	Top side at 21mm -	0.424	0.106	0.233	0.066	0.53	0.66	0.49	0.72
WCDMA II	Front at 10mm -	0.531	0.077	0.000	0.091	0.61	0.53	0.62	0.62
	Back at 10mm -	0.912	0.203	0.203	0.106	1.12	1.11	1.02	1.22
	Left side at 10mm -	0.444	0.000	0.000	0.000	0.44	0.44	0.44	0.44
	Right side at 10mm -	0.190	0.066	0.000	0.059	0.26	0.19	0.25	0.25
	Top side at 10mm -	0.887	0.106	0.233	0.066	0.99	1.12	0.95	1.19
	Bottom side at 10mm -	0.940				0.94	0.94	0.94	0.94
	Front at 11mm -	1.058	0.077	0.000	0.091	1.14	1.06	1.15	1.15
	Back at 17mm -	0.824	0.203	0.203	0.106	1.03	1.03	0.93	1.13
	Top side at 21mm -	0.790	0.106	0.233	0.066	0.90	1.02	0.86	1.09
	Bottom side at 21mm -	0.545				0.55	0.55	0.55	0.55
WCDMA IV	Front at 10mm -	0.418	0.077	0.000	0.091	0.50	0.42	0.51	0.51
	Back at 10mm -	0.709	0.203	0.203	0.106	0.91	0.91	0.82	1.02
	Left side at 10mm -	0.347	0.000	0.000	0.000	0.35	0.35	0.35	0.35
	Right side at 10mm -	0.176	0.066	0.000	0.059	0.24	0.18	0.24	0.24
	Top side at 10mm -	0.937	0.106	0.233	0.066	1.04	1.17	1.00	1.24
	Bottom side at 10mm -	0.781				0.78	0.78	0.78	0.78
	Front at 11mm -	0.644	0.077	0.000	0.091	0.72	0.64	0.73	0.73
	Back at 17mm -	0.508	0.203	0.203	0.106	0.71	0.71	0.61	0.82
	Top side at 21mm -	0.399	0.106	0.233	0.066	0.51	0.63	0.47	0.70
	Bottom side at 21mm -	0.533				0.53	0.53	0.53	0.53
WCDMA V	Front at 10mm -	0.297	0.077	0.000	0.091	0.37	0.30	0.39	0.39



BUREAU VERITAS

FCC SAR Test Report



Certificate #6613.01

WWAN Band	Exposure Position	1	2	3	4	1+2 Summed 1g SAR (W/kg)	1+3 Summed 1g SAR (W/kg)	1+4 Summed 1g SAR (W/kg)	1+3+4 Summed 1g SAR (W/kg)
		WWAN	2.4GHz WLAN	5GHz WLAN	Bluetooth				
		1g SAR (W/kg)	1g SAR (W/kg)	1g SAR (W/kg)	1g SAR (W/kg)				
	Back at 10mm -	0.535	0.203	0.203	0.106	0.74	0.74	0.64	0.84
	Left side at 10mm -	0.107	0.000	0.000	0.000	0.11	0.11	0.11	0.11
	Right side at 10mm -	0.113	0.066	0.000	0.059	0.18	0.11	0.17	0.17
	Top side at 10mm -	0.180	0.106	0.233	0.066	0.29	0.41	0.25	0.48
	Bottom side at 10mm -	0.174				0.17	0.17	0.17	0.17
LTE Band 2	Front at 10mm -	0.431	0.077	0.000	0.091	0.51	0.43	0.52	0.52
	Back at 10mm -	0.916	0.203	0.203	0.106	1.12	1.12	1.02	1.23
	Left side at 10mm -	0.523	0.000	0.000	0.000	0.52	0.52	0.52	0.52
	Right side at 10mm -	0.257	0.066	0.000	0.059	0.32	0.26	0.32	0.32
	Top side at 10mm -	1.067	0.106	0.233	0.066	1.17	1.30	1.13	1.37
	Bottom side at 10mm -	0.960				0.96	0.96	0.96	0.96
	Front at 11mm -	1.083	0.077	0.000	0.091	1.16	1.08	1.17	1.17
	Back at 17mm -	0.521	0.203	0.203	0.106	0.72	0.72	0.63	0.83
	Top side at 21mm -	0.439	0.106	0.233	0.066	0.55	0.67	0.51	0.74
	Bottom side at 21mm -	0.527				0.53	0.53	0.53	0.53
LTE Band 5	Front at 10mm -	0.347	0.077	0.000	0.091	0.42	0.35	0.44	0.44
	Back at 10mm -	0.569	0.203	0.203	0.106	0.77	0.77	0.68	0.88
	Left side at 10mm -	0.118	0.000	0.000	0.000	0.12	0.12	0.12	0.12
	Right side at 10mm -	0.129	0.066	0.000	0.059	0.19	0.13	0.19	0.19
	Top side at 10mm -	0.361	0.106	0.233	0.066	0.47	0.59	0.43	0.66
	Bottom side at 10mm -	0.274				0.27	0.27	0.27	0.27
LTE Band 7	Front at 10mm -	0.272	0.077	0.000	0.091	0.35	0.27	0.36	0.36
	Back at 10mm -	0.550	0.203	0.203	0.106	0.75	0.75	0.66	0.86
	Left side at 10mm -	0.525	0.000	0.000	0.000	0.52	0.52	0.52	0.52
	Right side at 10mm -	0.208	0.066	0.000	0.059	0.27	0.21	0.27	0.27
	Top side at 10mm -	0.398	0.106	0.233	0.066	0.50	0.63	0.46	0.70
	Bottom side at 10mm -	0.643				0.64	0.64	0.64	0.64
	Front at 11mm -	1.078	0.077	0.000	0.091	1.16	1.08	1.17	1.17
	Back at 17mm -	0.702	0.203	0.203	0.106	0.91	0.90	0.81	1.01
	Top side at 21mm -	0.371	0.106	0.233	0.066	0.48	0.60	0.44	0.67
	Bottom side at 21mm -	0.653				0.65	0.65	0.65	0.65
LTE Band 38	Front at 10mm -	0.285	0.077	0.000	0.091	0.36	0.28	0.38	0.38
	Back at 10mm -	0.592	0.203	0.203	0.106	0.80	0.79	0.70	0.90
	Left side at 10mm -	0.310	0.000	0.000	0.000	0.31	0.31	0.31	0.31
	Right side at 10mm -	0.101	0.066	0.000	0.059	0.17	0.10	0.16	0.16
	Top side at 10mm -	0.432	0.106	0.233	0.066	0.54	0.67	0.50	0.73
	Bottom side at 10mm -	0.765				0.76	0.76	0.76	0.76



BUREAU VERITAS

FCC SAR Test Report



Certificate #6613.01

WWAN Band	Exposure Position	1	2	3	4	1+2 Summed 1g SAR (W/kg)	1+3 Summed 1g SAR (W/kg)	1+4 Summed 1g SAR (W/kg)	1+3+4 Summed 1g SAR (W/kg)
		WWAN 1g SAR (W/kg)	2.4GHz WLAN 1g SAR (W/kg)	5GHz WLAN 1g SAR (W/kg)	Bluetooth 1g SAR (W/kg)				
WWAN Band	Front at 11mm -	0.838	0.077	0.000	0.091	0.92	0.84	0.93	0.93
	Back at 17mm -	0.562	0.203	0.203	0.106	0.77	0.77	0.67	0.87
	Top side at 21mm -	0.430	0.106	0.233	0.066	0.54	0.66	0.50	0.73
	Bottom side at 21mm -	0.589				0.59	0.59	0.59	0.59
LTE Band 41	Front at 10mm -	0.215	0.077	0.000	0.091	0.29	0.22	0.31	0.31
	Back at 10mm -	0.493	0.203	0.203	0.106	0.70	0.70	0.60	0.80
	Left side at 10mm -	0.333	0.000	0.000	0.000	0.33	0.33	0.33	0.33
	Right side at 10mm -	0.123	0.066	0.000	0.059	0.19	0.12	0.18	0.18
	Top side at 10mm -	0.399	0.106	0.233	0.066	0.51	0.63	0.47	0.70
	Bottom side at 10mm -	0.585				0.58	0.58	0.58	0.58
	Front at 11mm -	0.968	0.077	0.000	0.091	1.04	0.97	1.06	1.06
	Back at 17mm -	0.536	0.203	0.203	0.106	0.74	0.74	0.64	0.84
	Top side at 21mm -	0.448	0.106	0.233	0.066	0.55	0.68	0.51	0.75
	Bottom side at 21mm -	0.531				0.53	0.53	0.53	0.53
LTE Band 66	Front at 10mm -	0.566	0.077	0.000	0.091	0.64	0.57	0.66	0.66
	Back at 10mm -	0.902	0.203	0.203	0.106	1.11	1.11	1.01	1.21
	Left side at 10mm -	0.350	0.000	0.000	0.000	0.35	0.35	0.35	0.35
	Right side at 10mm -	0.182	0.066	0.000	0.059	0.25	0.18	0.24	0.24
	Top side at 10mm -	1.093	0.106	0.233	0.066	1.20	1.33	1.16	1.39
	Bottom side at 10mm -	0.917				0.92	0.92	0.92	0.92
	Front at 11mm -	1.036	0.077	0.000	0.091	1.11	1.04	1.13	1.13
	Back at 17mm -	0.572	0.203	0.203	0.106	0.78	0.77	0.68	0.88
	Top side at 21mm -	0.339	0.106	0.233	0.066	0.45	0.57	0.41	0.64
	Bottom side at 21mm -	0.435				0.44	0.44	0.44	0.44



BUREAU
VERITAS

FCC SAR Test Report



Certificate #6613.01

<Extremity Exposure Condition >



BUREAU VERITAS

FCC SAR Test Report



Certificate #6613.01

WWAN Band	Exposure Position	1	2	3	4	1+2 Summed 10g SAR (W/kg)	1+3 Summed 10g SAR (W/kg)	1+4 Summed 10g SAR (W/kg)	1+3+4 Summed 10g SAR (W/kg)
		WWAN	2.4GHz WLAN	5GHz WLAN	Bluetooth				
		10g SAR (W/kg)	10g SAR (W/kg)	10g SAR (W/kg)	10g SAR (W/kg)				
GSM1900	Front at 0mm -			0.193		0.00	0.19	0.00	0.19
	Back at 0mm -	1.049		0.286		1.05	1.34	1.05	1.34
	Left side at 0mm -			0.000		0.00	0.00	0.00	0.00
	Right side at 0mm -			0.102		0.00	0.10	0.00	0.10
	Top side at 0mm -	1.593		0.242		1.59	1.83	1.59	1.83
	Bottom side at 0mm -					0.00	0.00	0.00	0.00
WCDMA II	Front at 0mm -	1.118		0.193		1.12	1.31	1.12	1.31
	Back at 0mm -	1.898		0.286		1.90	2.18	1.90	2.18
	Left side at 0mm -			0.000		0.00	0.00	0.00	0.00
	Right side at 0mm -			0.102		0.00	0.10	0.00	0.10
	Top side at 0mm -	1.746		0.242		1.75	1.99	1.75	1.99
	Bottom side at 0mm -	2.367				2.37	2.37	2.37	2.37
WCDMA IV	Front at 0mm -	1.166		0.193		1.17	1.36	1.17	1.36
	Back at 0mm -	1.087		0.286		1.09	1.37	1.09	1.37
	Left side at 0mm -			0.000		0.00	0.00	0.00	0.00
	Right side at 0mm -			0.102		0.00	0.10	0.00	0.10
	Top side at 0mm -	1.500		0.242		1.50	1.74	1.50	1.74
	Bottom side at 0mm -	2.080				2.08	2.08	2.08	2.08
LTE Band 2	Front at 0mm -	0.789		0.193		0.79	0.98	0.79	0.98
	Back at 0mm -	1.960		0.286		1.96	2.25	1.96	2.25
	Left side at 0mm -			0.000		0.00	0.00	0.00	0.00
	Right side at 0mm -			0.102		0.00	0.10	0.00	0.10
	Top side at 0mm -	1.959		0.242		1.96	2.20	1.96	2.20
	Bottom side at 0mm -	2.544				2.54	2.54	2.54	2.54
LTE Band 7	Front at 0mm -	0.978		0.193		0.98	1.17	0.98	1.17
	Back at 0mm -	1.626		0.286		1.63	1.91	1.63	1.91
	Left side at 0mm -			0.000		0.00	0.00	0.00	0.00
	Right side at 0mm -			0.102		0.00	0.10	0.00	0.10
	Top side at 0mm -	2.120		0.242		2.12	2.36	2.12	2.36
	Bottom side at 0mm -	1.703				1.70	1.70	1.70	1.70
LTE Band 38	Front at 0mm -			0.193		0.00	0.19	0.00	0.19
	Back at 0mm -	1.514		0.286		1.51	1.80	1.51	1.80
	Left side at 0mm -			0.000		0.00	0.00	0.00	0.00
	Right side at 0mm -			0.102		0.00	0.10	0.00	0.10
	Top side at 0mm -	1.911		0.242		1.91	2.15	1.91	2.15
	Bottom side at 0mm -	1.322				1.32	1.32	1.32	1.32
LTE Band 41	Front at 0mm -			0.193		0.00	0.19	0.00	0.19



BUREAU
VERITAS

FCC SAR Test Report



Certificate #6613.01

	Back at 0mm -	1.222		0.286		1.22	1.51	1.22	1.51
	Left side at 0mm -			0.000		0.00	0.00	0.00	0.00
	Right side at 0mm -			0.102		0.00	0.10	0.00	0.10
	Top side at 0mm -	1.833		0.242		1.83	2.07	1.83	2.07
	Bottom side at 0mm -	1.325				1.32	1.32	1.32	1.32
LTE Band 66	Front at 0mm -	1.468		0.193		1.47	1.66	1.47	1.66
	Back at 0mm -	1.391		0.286		1.39	1.68	1.39	1.68
	Left side at 0mm -			0.000		0.00	0.00	0.00	0.00
	Right side at 0mm -			0.102		0.00	0.10	0.00	0.10
	Top side at 0mm -	1.668		0.242		1.67	1.91	1.67	1.91
	Bottom side at 0mm -	2.573				2.57	2.57	2.57	2.57

Note:

- The SAR summation of maximum SAR of WWAN and WLAN/BT for each position is under the SAR limitation (**Head & Body: SAR_{1g} 1.6 W/kg, Extremity: SAR_{10g} 4.0 W/kg**). Therefore, the simultaneous transmission condition is compliance with the SAR criterion.

Test Engineer : Zhiwei Zhang, and Renjie Liu

5. Calibration of Test Equipment

Equipment	Manufacturer	Model	SN	Cal. Date	Cal. Interval
System Validation Dipole	SPEAG	D835V2	4d265	Oct. 18, 2021	3 Years
System Validation Dipole	SPEAG	D1750V2	1176	Oct. 19, 2021	3 Years
System Validation Dipole	SPEAG	D1950V3	1229	Oct. 28, 2021	3 Years
System Validation Dipole	SPEAG	D2450V2	1048	Oct. 21, 2021	3 Years
System Validation Dipole	SPEAG	D2550V2	1022	Sep. 22, 2022	3 Years
System Validation Dipole	SPEAG	D5GHzV2	1315	Oct. 22, 2021	3 Years
Data Acquisition Electronics	SPEAG	DAE4	1633	Mar. 06, 2024	1 Year
Dosimetric E-Field Probe	SPEAG	EX3DV4	7612	Mar. 20, 2024	1 Year
Radio Communication Analyzer	ANRITSU	MT8821C	6272458679	Aug. 26, 2022	2 Years
Magnetic Field Probe	SPEAG	DAK-3.5	1119	Feb. 19, 2024	1 Year
ENA Series Network Analyzer	SPEAG	DAKS_VNA R140	0121219	Feb. 19, 2024	1 Year
Power Meter	Rohde&Schwarz	NRX	102380	Mar. 28, 2024	1 Year
Power Sensor	Rohde&Schwarz	NRP6A	102942	Mar. 20, 2024	1 Year
Power Sensor	Rohde&Schwarz	NRP6A	102943	Mar. 20, 2024	1 Year
ESG Analog Signal Generator	Rohde&Schwarz	SMB100B	102507	Mar. 28, 2024	1 Year
Coupler	Woken	0110A056020-10	COM27RW1A3	May. 09, 2024	1 Year
Temp.&Humi.Recorder	Deli	8813	SZ011	Sep. 06, 2022	2 Years

Note:

- Referring to KDB 865664 D01 v01r04, the dipole calibration interval can be extended to 3 years with justification. The dipole are also not physically damaged, or repaired during the interval. The dipole justification can be found in appendix C.
The return loss is $< -20\text{dB}$, within 20% of prior calibration, the impedance is with 5ohm of prior calibration.

6. Measurement Uncertainty

DASY6 Uncertainty Budget According to IEEE 1528-2013 and IEC 62209-1/2016 (0.3 - 3 GHz range)								
Error Description	Uncertainty Value (±%)	Probability	Divisor	(Ci) 1g	(Ci) 10g	Standard Uncertainty (1g) (±%)	Standard Uncertainty (10g) (±%)	(Vi) Veff
Measurement System								
Probe Calibration	6.05	N	1	1	1	6.1	6.1	∞
Axial Isotropy	4.7	R	1.732	0.7	0.7	1.9	1.9	∞
Hemispherical Isotropy	9.6	R	1.732	0.7	0.7	3.9	3.9	∞
Boundary Effects	2.0	R	1.732	1	1	1.2	1.2	∞
Linearity	4.7	R	1.732	1	1	2.7	2.7	∞
System Detection Limits	1.0	R	1.732	1	1	0.6	0.6	∞
Modulation Response	3.2	R	1.732	1	1	1.8	1.8	∞
Readout Electronics	0.3	N	1	1	1	0.3	0.3	∞
Response Time	0.0	R	1.732	1	1	0.0	0.0	∞
Integration Time	2.6	R	1.732	1	1	1.5	1.5	∞
RF Ambient Noise	3.0	R	1.732	1	1	1.7	1.7	∞
RF Ambient Reflections	3.0	R	1.732	1	1	1.7	1.7	∞
Probe Positioner	0.4	R	1.732	1	1	0.2	0.2	∞
Probe Positioning	6.7	R	1.732	1	1	3.9	3.9	∞
Max. SAR Eval.	4.0	R	1.732	1	1	2.3	2.3	∞
Test Sample Related								
Device Positioning	4.0	N	1	1	1	4.0	4.0	35
Device Holder	4.9	N	1	1	1	4.9	4.9	12
Power Drift	5.0	R	1.732	1	1	2.9	2.9	∞
Power Scaling	0.0	R	1.732	1	1	0.0	0.0	∞
Phantom and Setup								
Phantom Uncertainty	6.6	R	1.732	1	1	3.8	3.8	∞
SAR correction	0.0	R	1.732	1	0.84	0.0	0.0	∞
Liquid Conductivity Repeatability	0.14	N	1	0.78	0.71	0.1	0.1	5
Liquid Conductivity (target)	10.0	R	1.732	0.78	0.71	4.5	4.1	∞
Liquid Conductivity (mea.)	2.5	R	1.732	0.78	0.71	1.1	1.0	∞
Temp. unc. - Conductivity	2.61	R	1.732	0.78	0.71	1.2	1.1	∞
Liquid Permittivity Repeatability	0.03	N	1	0.23	0.26	0.0	0.0	5
Liquid Permittivity (target)	10.0	R	1.732	0.23	0.26	1.3	1.5	∞
Liquid Permittivity (mea.)	2.5	R	1.732	0.23	0.26	0.3	0.4	∞
Temp. unc. - Permittivity	1.78	R	1.732	0.23	0.26	0.2	0.3	∞
Combined Std. Uncertainty						13.6%	13.5%	578
Coverage Factor for 95 %						K=2	K=2	
Expanded STD Uncertainty						27.2%	26.9%	

Uncertainty budget for frequency range 300 MHz to 3 GHz



BUREAU
VERITAS

FCC SAR Test Report



Certificate #6613.01

DASY6 Uncertainty Budget According to IEC 62209-2/2010 (30 MHz - 6 GHz range)

Error Description	Uncertainty Value (±%)	Probability	Divisor	(Ci) 1g	(Ci) 10g	Standard Uncertainty (1g) (±%)	Standard Uncertainty (10g) (±%)	(Vi) Veff
Measurement System								
Probe Calibration	6.65	N	1	1	1	6.7	6.7	∞
Axial Isotropy	4.7	R	1.732	0.7	0.7	1.9	1.9	∞
Hemispherical Isotropy	9.6	R	1.732	0.7	0.7	3.9	3.9	∞
Boundary Effects	2.0	R	1.732	1	1	1.2	1.2	∞
Linearity	4.7	R	1.732	1	1	2.7	2.7	∞
System Detection Limits	1.0	R	1.732	1	1	0.6	0.6	∞
Modulation Response	3.2	R	1.732	1	1	1.8	1.8	∞
Readout Electronics	0.3	N	1	1	1	0.3	0.3	∞
Response Time	0.0	R	1.732	1	1	0.0	0.0	∞
Integration Time	2.6	R	1.732	1	1	1.5	1.5	∞
RF Ambient Noise	3.0	R	1.732	1	1	1.7	1.7	∞
RF Ambient Reflections	3.0	R	1.732	1	1	1.7	1.7	∞
Probe Positioner	0.4	R	1.732	1	1	0.2	0.2	∞
Probe Positioning	6.7	R	1.732	1	1	3.9	3.9	∞
Max. SAR Eval.	4.0	R	1.732	1	1	2.3	2.3	∞
Test Sample Related								
Device Positioning	4.3	N	1	1	1	4.3	4.3	35
Device Holder	4.9	N	1	1	1	4.9	4.9	12
Power Drift	5.0	R	1.732	1	1	2.9	2.9	∞
Power Scaling	0.0	R	1.732	1	1	0.0	0.0	∞
Phantom and Setup								
Phantom Uncertainty	6.6	R	1.732	1	1	3.8	3.8	∞
SAR correction	0.0	R	1.732	1	0.84	0.0	0.0	∞
Liquid Conductivity Repeatability	0.16	N	1	0.78	0.71	0.1	0.1	5
Liquid Conductivity (target)	10.0	R	1.732	0.78	0.71	4.5	4.1	∞
Liquid Conductivity (mea.)	2.5	R	1.732	0.78	0.71	1.1	1.0	∞
Temp. unc. - Conductivity	3.64	R	1.732	0.78	0.71	1.6	1.5	∞
Liquid Permittivity Repeatability	0.08	N	1	0.23	0.26	0.0	0.0	5
Liquid Permittivity (target)	10.0	R	1.732	0.23	0.26	1.3	1.5	∞
Liquid Permittivity (mea.)	2.5	R	1.732	0.23	0.26	0.3	0.4	∞
Temp. unc. - Permittivity	1.78	R	1.732	0.23	0.26	0.2	0.3	∞
Combined Std. Uncertainty						14.0%	13.9%	624
Coverage Factor for 95 %						K=2	K=2	
Expanded STD Uncertainty						28.0%	27.7%	

Uncertainty budget for frequency range 30 MHz to 6 GHz

7. Information on the Testing Laboratories

We, Huarui 7layers High Technology (Suzhou) Co., Ltd., were founded in 2020 to provide our best service in EMC, Radio, Telecom and Safety consultation.

If you have any comments, please feel free to contact us at the following:

Add: Tower N, Innovation Center, 88 Zuyi Road, High-tech District, Suzhou City, Anhui Province

[Tel: +86 \(0557\) 368 1008](tel:+86(0557)3681008)

The road map of all our labs can be found in our web site also

[Web: http://www.7Layers.com](http://www.7Layers.com)

---END---



BUREAU
VERITAS



Appendix A. SAR Plots of System Verification

The plots for system verification with largest deviation for each SAR system combination are shown as follows.

System Check_HSL835_240711

DUT: Dipole 835 MHz; Type: D835V2

Communication System: CW; Frequency: 835 MHz; Duty Cycle: 1:1

Medium: HSL835_0711 Medium parameters used: $f = 835$ MHz; $\sigma = 0.916$ S/m; $\epsilon_r = 43.01$; $\rho = 1000$ kg/m³

Ambient Temperature : 23.6°C; Liquid Temperature : 22.4°C

DASY5 Configuration:

- Probe: EX3DV4 - SN7612; ConvF(10.96, 10.96, 10.96) @ 835 MHz; Calibrated: 2024/03/20
- Sensor-Surface: 1.4mm (Mechanical Surface Detection)
- Electronics: DAE4 Sn1633; Calibrated: 2024/03/06
- Phantom: SAM Right ; Type: QD000P40CD; Serial: TP:1611
- Measurement SW: DASY52, Version 52.10 (4); SEMCAD X Version 14.6.14 (7501)

Pin=250mW/Area Scan (61x201x1): Interpolated grid: dx=1.000 mm, dy=1.000 mm

Maximum value of SAR (interpolated) = 3.49 W/kg

Pin=250mW/Zoom Scan (7x7x7)/Cube 0: Measurement grid: dx=5mm, dy=5mm, dz=5mm

Reference Value = 49.71 V/m; Power Drift = 0.09 dB

Peak SAR (extrapolated) = 4.04 W/kg

SAR(1 g) = 2.51 W/kg; SAR(10 g) = 1.64 W/kg

Smallest distance from peaks to all points 3 dB below = 16.5 mm

Ratio of SAR at M2 to SAR at M1 = 62.5%

Maximum value of SAR (measured) = 3.47 W/kg

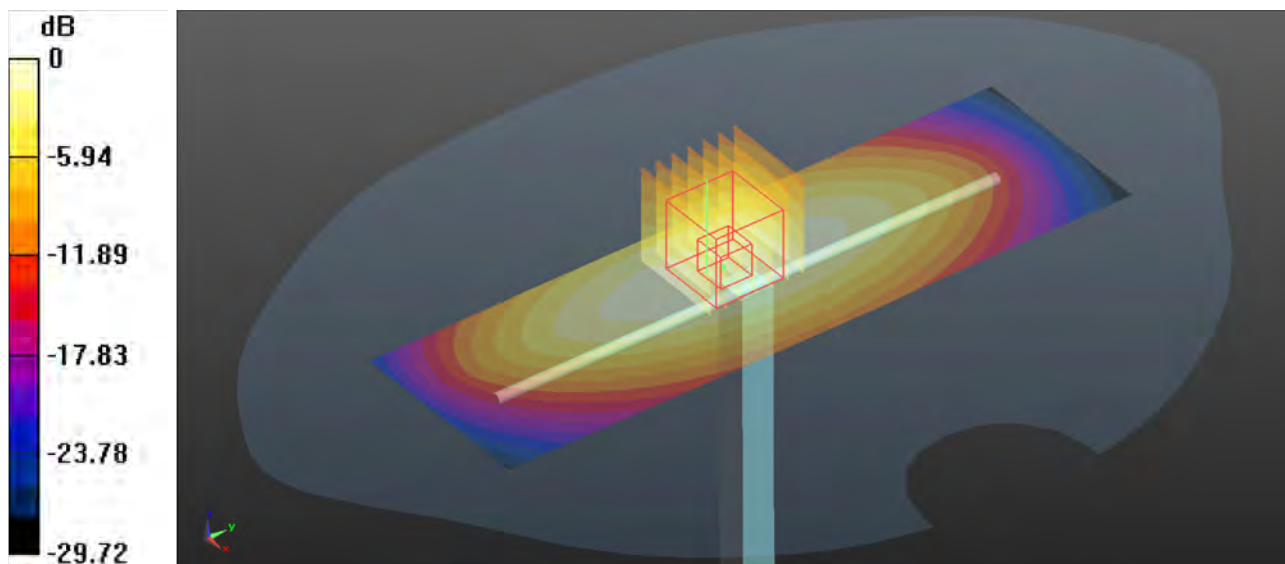

0 dB = 3.47 W/kg

System Check_HSL1750_240712

DUT: Dipole 1750 MHz; Type: D1750V2

Communication System: CW; Frequency: 1750 MHz; Duty Cycle: 1:1

Medium: HSL1750_0712 Medium parameters used: $f = 1750$ MHz; $\sigma = 1.353$ S/m; $\epsilon_r = 39.339$; $\rho = 1000$ kg/m³

Ambient Temperature : 23.7°C; Liquid Temperature : 22.3°C

DASY5 Configuration:

- Probe: EX3DV4 - SN7612; ConvF(9.2, 9.2, 9.2) @ 1750 MHz; Calibrated: 2024/03/20
- Sensor-Surface: 1.4mm (Mechanical Surface Detection)
- Electronics: DAE4 Sn1633; Calibrated: 2024/03/06
- Phantom: SAM Right ; Type: QD000P40CD; Serial: TP:1611
- Measurement SW: DASY52, Version 52.10 (4); SEMCAD X Version 14.6.14 (7501)

Pin=250mW/Area Scan (61x101x1): Interpolated grid: dx=1.500 mm, dy=1.500 mm
Maximum value of SAR (interpolated) = 14.1 W/kg

Pin=250mW/Zoom Scan (5x5x7)/Cube 0: Measurement grid: dx=8mm, dy=8mm, dz=5mm

Reference Value = 73.35 V/m; Power Drift = 0.14 dB

Peak SAR (extrapolated) = 16.7 W/kg

SAR(1 g) = 9.13 W/kg; SAR(10 g) = 4.88 W/kg

Smallest distance from peaks to all points 3 dB below = 11.2 mm

Ratio of SAR at M2 to SAR at M1 = 54.7%

Maximum value of SAR (measured) = 14.0 W/kg

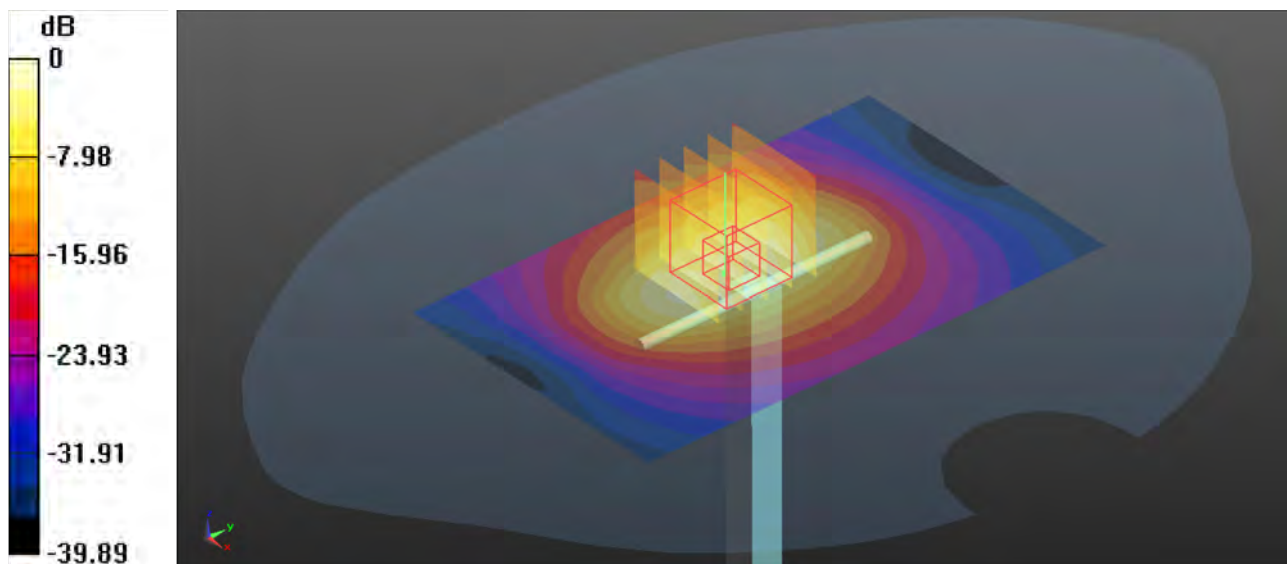

0 dB = 14.0 W/kg

System Check_HSL1750_240713

DUT: Dipole 1750 MHz; Type: D1750V2

Communication System: CW; Frequency: 1750 MHz; Duty Cycle: 1:1

Medium: HSL1750_0713 Medium parameters used: $f = 1750$ MHz; $\sigma = 1.375$ S/m; $\epsilon_r = 40.868$; $\rho = 1000$ kg/m³

Ambient Temperature : 23.8°C; Liquid Temperature : 22.6°C

DASY5 Configuration:

- Probe: EX3DV4 - SN7612; ConvF(9.2, 9.2, 9.2) @ 1750 MHz; Calibrated: 2024/03/20
- Sensor-Surface: 1.4mm (Mechanical Surface Detection)
- Electronics: DAE4 Sn1633; Calibrated: 2024/03/06
- Phantom: SAM Right ; Type: QD000P40CD; Serial: TP:1611
- Measurement SW: DASY52, Version 52.10 (4); SEMCAD X Version 14.6.14 (7501)

Pin=250mW/Area Scan (41x101x1): Interpolated grid: dx=1.000 mm, dy=1.000 mm
Maximum value of SAR (interpolated) = 14.3 W/kg

Pin=250mW/Zoom Scan (7x7x7)/Cube 0: Measurement grid: dx=5mm, dy=5mm, dz=5mm

Reference Value = 72.26 V/m; Power Drift = 0.02 dB

Peak SAR (extrapolated) = 17.4 W/kg

SAR(1 g) = 9.2 W/kg; SAR(10 g) = 4.86 W/kg

Smallest distance from peaks to all points 3 dB below = 10 mm

Ratio of SAR at M2 to SAR at M1 = 53.2%

Maximum value of SAR (measured) = 14.5 W/kg

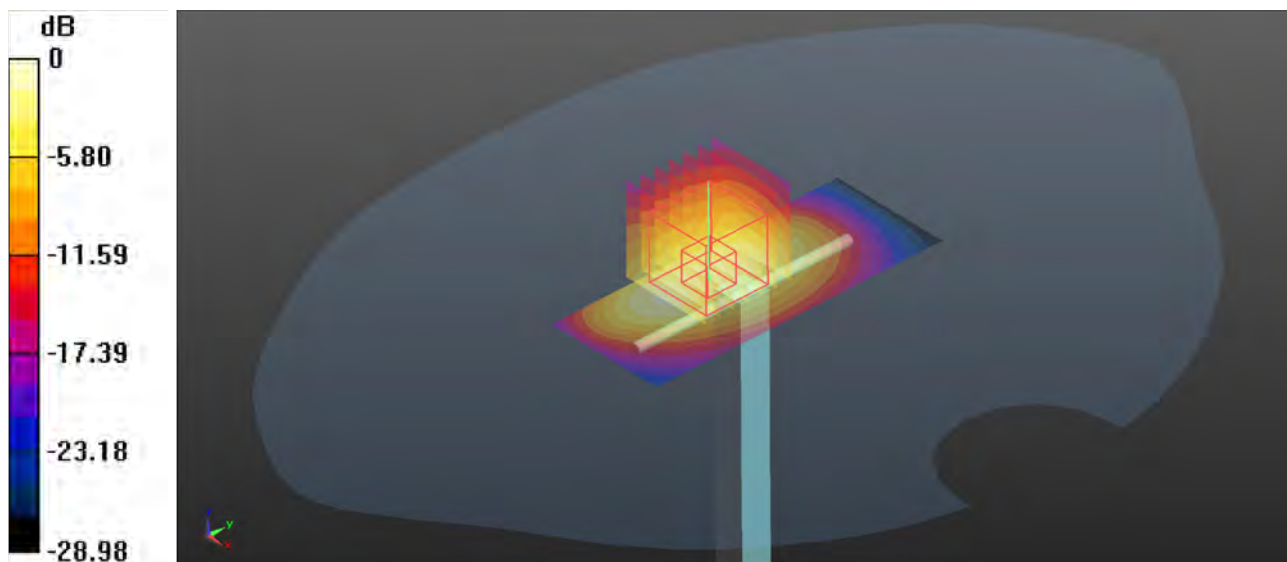

0 dB = 14.5 W/kg

System Check_HSL1950_240713

DUT: Dipole 1950 MHz; Type: D1950V3

Communication System: CW; Frequency: 1950 MHz; Duty Cycle: 1:1

Medium: HSL1950_0713 Medium parameters used: $f = 1950$ MHz; $\sigma = 1.463$ S/m; $\epsilon_r = 38.939$; $\rho = 1000$ kg/m³

Ambient Temperature : 23.7°C; Liquid Temperature : 22.5°C

DASY5 Configuration:

- Probe: EX3DV4 - SN7612; ConvF(8.83, 8.83, 8.83) @ 1950 MHz; Calibrated: 2024/03/20
- Sensor-Surface: 1.4mm (Mechanical Surface Detection)
- Electronics: DAE4 Sn1633; Calibrated: 2024/03/06
- Phantom: SAM Right ; Type: QD000P40CD; Serial: TP:1611
- Measurement SW: DASY52, Version 52.10 (4); SEMCAD X Version 14.6.14 (7501)

Pin=250mW/Area Scan (81x81x1): Interpolated grid: dx=1.500 mm, dy=1.500 mm

Maximum value of SAR (interpolated) = 11.9 W/kg

Pin=250mW/Zoom Scan (5x5x7)/Cube 0: Measurement grid: dx=8mm, dy=8mm, dz=5mm

Reference Value = 82.82 V/m; Power Drift = 0.15 dB

Peak SAR (extrapolated) = 19.5 W/kg

SAR(1 g) = 10.5 W/kg; SAR(10 g) = 5.3 W/kg

Smallest distance from peaks to all points 3 dB below = 10.7 mm

Ratio of SAR at M2 to SAR at M1 = 55.4%

Maximum value of SAR (measured) = 11.8 W/kg

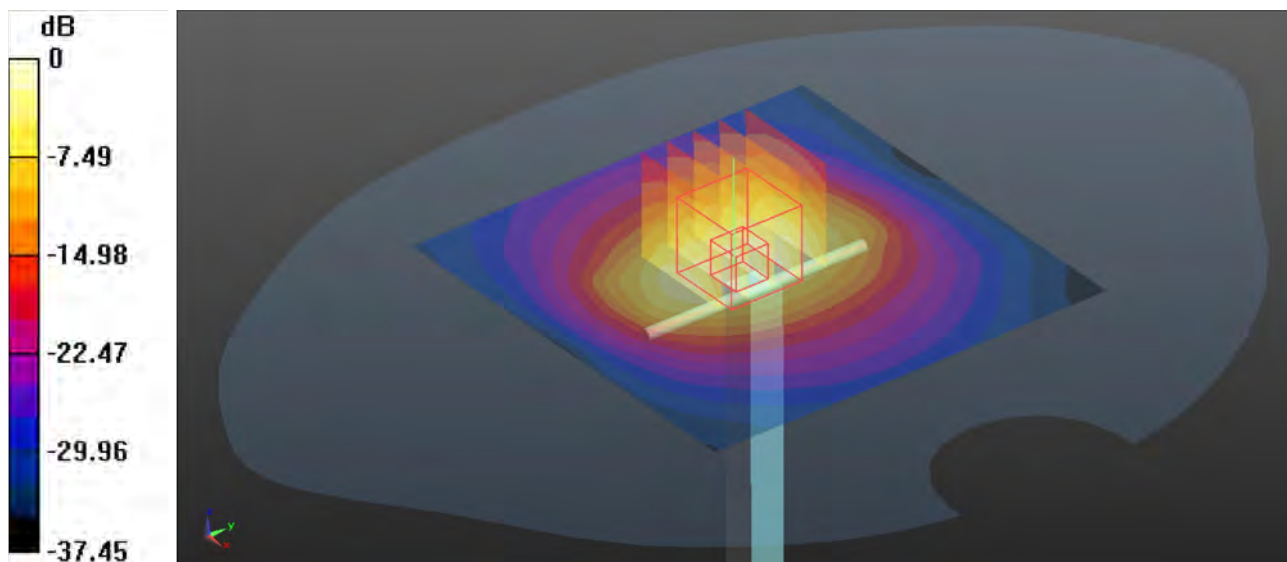

0 dB = 11.8 W/kg

System Check_HSL1950_240714

DUT: Dipole 1950 MHz; Type: D1950V3

Communication System: CW; Frequency: 1950 MHz; Duty Cycle: 1:1

Medium: HSL1950_0714 Medium parameters used: $f = 1950$ MHz; $\sigma = 1.467$ S/m; $\epsilon_r = 39.297$; $\rho = 1000$ kg/m³

Ambient Temperature : 23.6°C; Liquid Temperature : 22.5°C

DASY5 Configuration:

- Probe: EX3DV4 - SN7612; ConvF(8.83, 8.83, 8.83) @ 1950 MHz; Calibrated: 2024/03/20
- Sensor-Surface: 1.4mm (Mechanical Surface Detection)
- Electronics: DAE4 Sn1633; Calibrated: 2024/03/06
- Phantom: SAM Right ; Type: QD000P40CD; Serial: TP:1611
- Measurement SW: DASY52, Version 52.10 (4); SEMCAD X Version 14.6.14 (7501)

Pin=250mW/Area Scan (61x101x1): Interpolated grid: dx=1.500 mm, dy=1.500 mm
Maximum value of SAR (interpolated) = 15.8 W/kg

Pin=250mW/Zoom Scan (5x5x7)/Cube 0: Measurement grid: dx=8mm, dy=8mm, dz=5mm

Reference Value = 50.53 V/m; Power Drift = 0.15 dB

Peak SAR (extrapolated) = 19.4 W/kg

SAR(1 g) = 9.87 W/kg; SAR(10 g) = 5 W/kg

Smallest distance from peaks to all points 3 dB below = 9.6 mm

Ratio of SAR at M2 to SAR at M1 = 51.2%

Maximum value of SAR (measured) = 15.6 W/kg

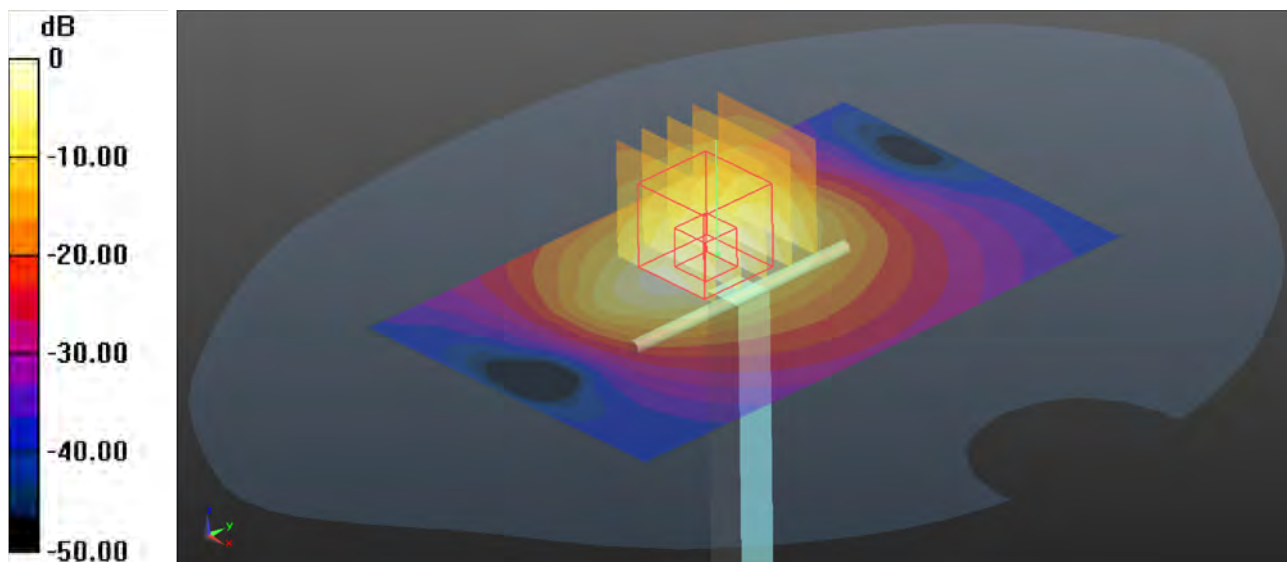

System Check_HSL2450_240714

DUT: Dipole 2450 MHz; Type: D2450V2

Communication System: CW; Frequency: 2450 MHz; Duty Cycle: 1:1

Medium: HSL2450_0714 Medium parameters used: $f = 2450$ MHz; $\sigma = 1.879$ S/m; $\epsilon_r = 39.632$; $\rho = 1000$ kg/m³

Ambient Temperature : 23.5°C; Liquid Temperature : 22.6°C

DASY5 Configuration:

- Probe: EX3DV4 - SN7612; ConvF(8.2, 8.2, 8.2) @ 2450 MHz; Calibrated: 2024/03/20
- Sensor-Surface: 1.4mm (Mechanical Surface Detection)
- Electronics: DAE4 Sn1633; Calibrated: 2024/03/06
- Phantom: SAM Right ; Type: QD000P40CD; Serial: TP:1611
- Measurement SW: DASY52, Version 52.10 (4); SEMCAD X Version 14.6.14 (7501)

Pin=250mW/Area Scan (71x121x1): Interpolated grid: dx=1.000 mm, dy=1.000 mm
Maximum value of SAR (interpolated) = 23.8 W/kg

Pin=250mW/Zoom Scan (7x7x7)/Cube 0: Measurement grid: dx=5mm, dy=5mm, dz=5mm

Reference Value = 72.15 V/m; Power Drift = 0.15 dB

Peak SAR (extrapolated) = 29.2 W/kg

SAR(1 g) = 13.8 W/kg; SAR(10 g) = 6.34 W/kg

Smallest distance from peaks to all points 3 dB below = 9 mm

Ratio of SAR at M2 to SAR at M1 = 47.2%

Maximum value of SAR (measured) = 23.5 W/kg

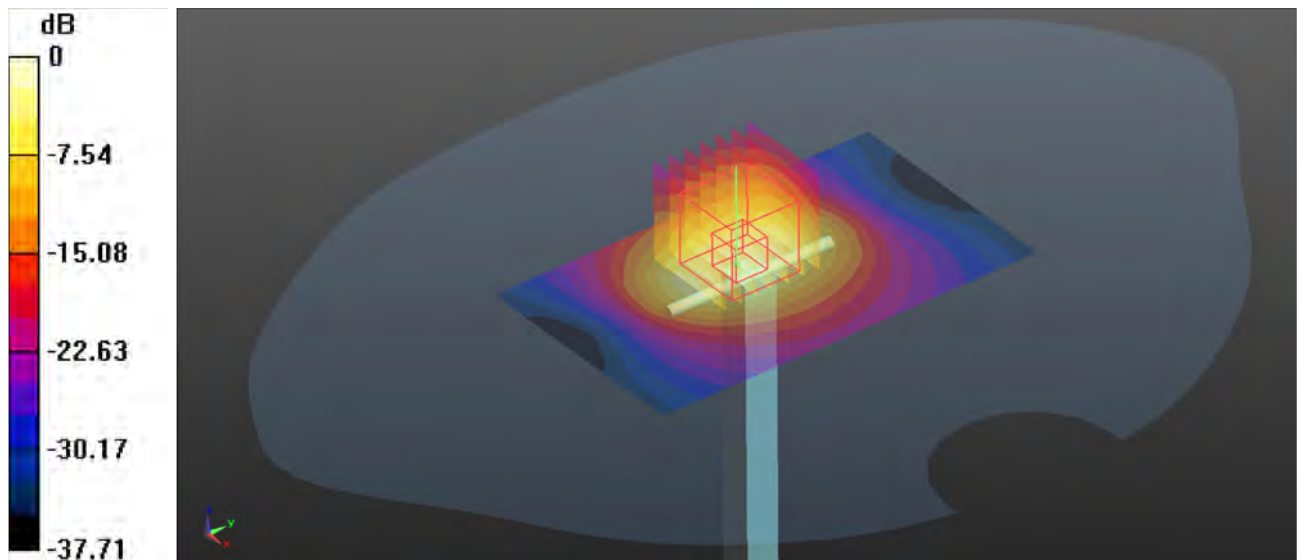

0 dB = 23.5 W/kg

System Check_HSL2550_240715

DUT: Dipole 2550 MHz; Type: D2550V2

Communication System: CW; Frequency: 2550 MHz; Duty Cycle: 1:1

Medium: HSL2550_0715 Medium parameters used: $f = 2550$ MHz; $\sigma = 1.94$ S/m; $\epsilon_r = 39.474$; $\rho = 1000$ kg/m³

Ambient Temperature : 23.8°C; Liquid Temperature : 22.7°C

DASY5 Configuration:

- Probe: EX3DV4 - SN7612; ConvF(8.01, 8.01, 8.01) @ 2550 MHz; Calibrated: 2024/03/20
- Sensor-Surface: 1.4mm (Mechanical Surface Detection)
- Electronics: DAE4 Sn1633; Calibrated: 2024/03/06
- Phantom: SAM Right ; Type: QD000P40CD; Serial: TP:1611
- Measurement SW: DASY52, Version 52.10 (4); SEMCAD X Version 14.6.14 (7501)

Pin=250mW/Area Scan (61x121x1): Interpolated grid: dx=1.200 mm, dy=1.200 mm
Maximum value of SAR (interpolated) = 22.8 W/kg

Pin=250mW/Zoom Scan (7x7x7)/Cube 0: Measurement grid: dx=5mm, dy=5mm, dz=5mm

Reference Value = 67.38 V/m; Power Drift = 0.19 dB

Peak SAR (extrapolated) = 27.7 W/kg

SAR(1 g) = 13.1 W/kg; SAR(10 g) = 5.97 W/kg

Smallest distance from peaks to all points 3 dB below = 9 mm

Ratio of SAR at M2 to SAR at M1 = 47.6%

Maximum value of SAR (measured) = 22.2 W/kg

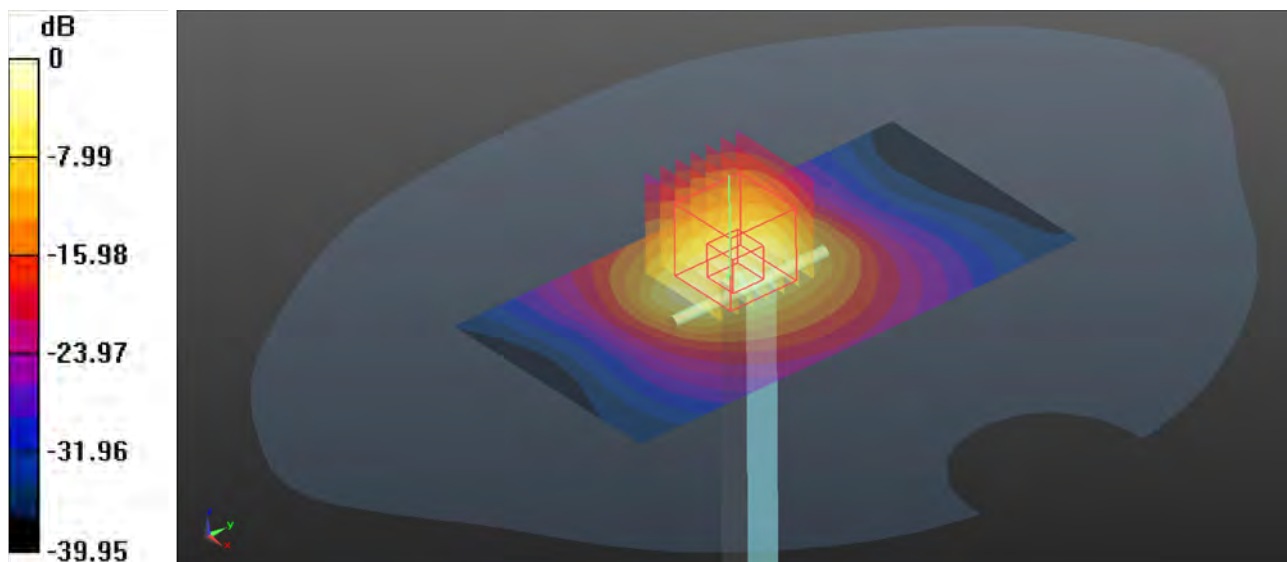

0 dB = 22.2 W/kg

System Check_HSL2550_240716

DUT: Dipole 2550 MHz; Type: D2550V2

Communication System: CW; Frequency: 2550 MHz; Duty Cycle: 1:1

Medium: HSL2550_0716 Medium parameters used: $f = 2550$ MHz; $\sigma = 1.959$ S/m; $\epsilon_r = 39.192$; $\rho = 1000$ kg/m³

Ambient Temperature : 23.7°C; Liquid Temperature : 22.5°C

DASY5 Configuration:

- Probe: EX3DV4 - SN7612; ConvF(8.01, 8.01, 8.01) @ 2550 MHz; Calibrated: 2024/03/20
- Sensor-Surface: 1.4mm (Mechanical Surface Detection)
- Electronics: DAE4 Sn1633; Calibrated: 2024/03/06
- Phantom: SAM Right ; Type: QD000P40CD; Serial: TP:1611
- Measurement SW: DASY52, Version 52.10 (4); SEMCAD X Version 14.6.14 (7501)

Pin=250mW/Area Scan (61x121x1): Interpolated grid: dx=1.200 mm, dy=1.200 mm
Maximum value of SAR (interpolated) = 22.5 W/kg

Pin=250mW/Zoom Scan (7x7x7)/Cube 0: Measurement grid: dx=5mm, dy=5mm, dz=5mm

Reference Value = 68.62 V/m; Power Drift = 0.03 dB

Peak SAR (extrapolated) = 27.4 W/kg

SAR(1 g) = 12.9 W/kg; SAR(10 g) = 5.87 W/kg

Smallest distance from peaks to all points 3 dB below = 9 mm

Ratio of SAR at M2 to SAR at M1 = 47.4%

Maximum value of SAR (measured) = 21.9 W/kg

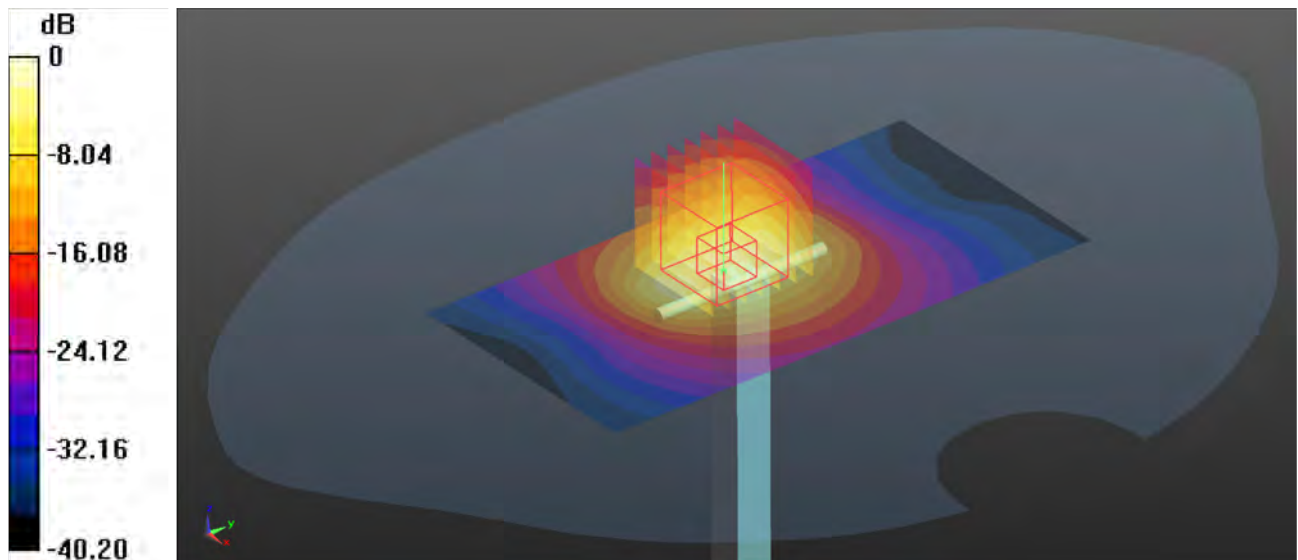

0 dB = 21.9 W/kg

System Check_HSL5250_240717

DUT: Dipole 5GHz; Type: D5GHzV2

Communication System: CW; Frequency: 5250 MHz; Duty Cycle: 1:1

Medium: HSL5G_0717 Medium parameters used: $f = 5250$ MHz; $\sigma = 4.561$ S/m; $\epsilon_r = 35.211$; $\rho = 1000$ kg/m³

Ambient Temperature : 23.7°C; Liquid Temperature : 22.6°C

DASY5 Configuration:

- Probe: EX3DV4 - SN7612; ConvF(5.75, 5.75, 5.75) @ 5250 MHz; Calibrated: 2024/03/20
- Sensor-Surface: 1.4mm (Mechanical Surface Detection)
- Electronics: DAE4 Sn1633; Calibrated: 2024/03/06
- Phantom: SAM Right ; Type: QD000P40CD; Serial: TP:1611
- Measurement SW: DASY52, Version 52.10 (4); SEMCAD X Version 14.6.14 (7501)

Pin=100mW/Area Scan (91x91x1): Interpolated grid: dx=1.000 mm, dy=1.000 mm

Maximum value of SAR (interpolated) = 18.0 W/kg

Pin=100mW/Zoom Scan (7x7x7)/Cube 0: Measurement grid: dx=4mm, dy=4mm, dz=2mm

Reference Value = 39.88 V/m; Power Drift = 0.02 dB

Peak SAR (extrapolated) = 32.1 W/kg

SAR(1 g) = 7.34 W/kg; SAR(10 g) = 2.18 W/kg

Smallest distance from peaks to all points 3 dB below = 7.4 mm

Ratio of SAR at M2 to SAR at M1 = 51.5%

Maximum value of SAR (measured) = 19.1 W/kg

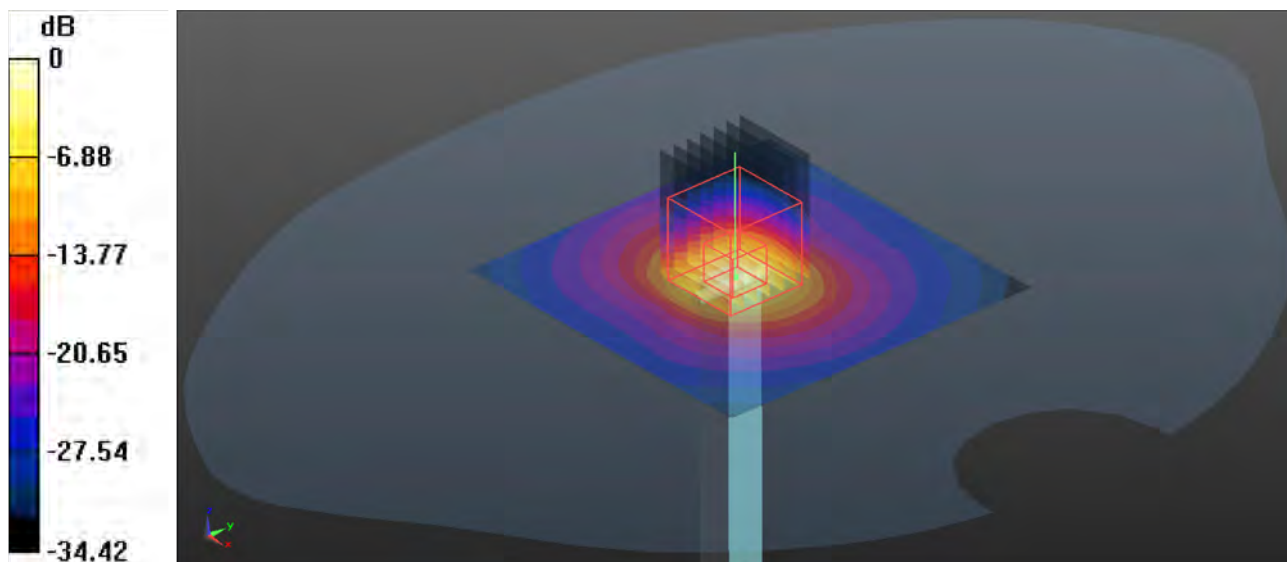

0 dB = 19.1 W/kg

System Check_HSL5600_240717

DUT: Dipole 5GHz; Type: D5GHzV2

Communication System: CW; Frequency: 5600 MHz; Duty Cycle: 1:1

Medium: HSL5G_0717 Medium parameters used: $f = 5600$ MHz; $\sigma = 4.956$ S/m; $\epsilon_r = 34.689$; $\rho = 1000$ kg/m³

Ambient Temperature : 23.7°C; Liquid Temperature : 22.7°C

DASY5 Configuration:

- Probe: EX3DV4 - SN7612; ConvF(5.06, 5.06, 5.06) @ 5600 MHz; Calibrated: 2024/03/20
- Sensor-Surface: 1.4mm (Mechanical Surface Detection)
- Electronics: DAE4 Sn1633; Calibrated: 2024/03/06
- Phantom: SAM Right ; Type: QD000P40CD; Serial: TP:1611
- Measurement SW: DASY52, Version 52.10 (4); SEMCAD X Version 14.6.14 (7501)

Pin=100mW/Area Scan (91x91x1): Interpolated grid: dx=1.000 mm, dy=1.000 mm

Maximum value of SAR (interpolated) = 20.8 W/kg

Pin=100mW/Zoom Scan (8x8x8)/Cube 0: Measurement grid: dx=4mm, dy=4mm, dz=1.4mm

Reference Value = 29.28 V/m; Power Drift = 0.06 dB

Peak SAR (extrapolated) = 37.5 W/kg

SAR(1 g) = 8.34 W/kg; SAR(10 g) = 2.34 W/kg

Smallest distance from peaks to all points 3 dB below = 7.2 mm

Ratio of SAR at M2 to SAR at M1 = 61.4%

Maximum value of SAR (measured) = 20.3 W/kg

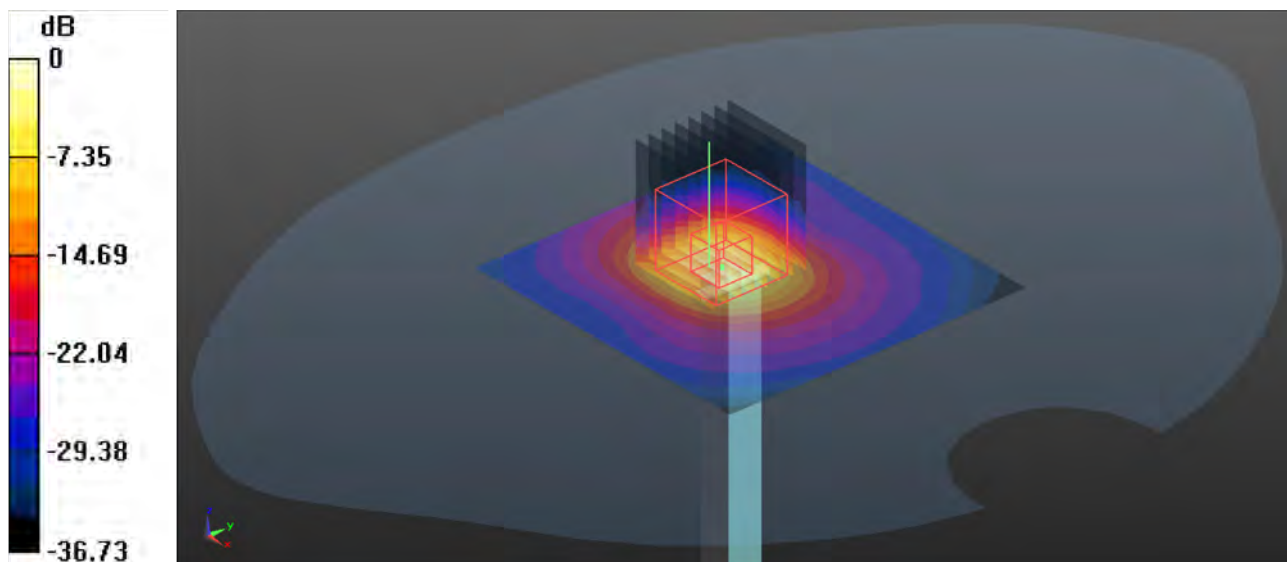

0 dB = 20.3 W/kg

System Check_HSL5750_240717

DUT: Dipole 5GHz; Type: D5GHzV2

Communication System: CW; Frequency: 5750 MHz; Duty Cycle: 1:1

Medium: HSL5G_0717 Medium parameters used: $f = 5750$ MHz; $\sigma = 5.149$ S/m; $\epsilon_r = 34.383$; $\rho = 1000$ kg/m³

Ambient Temperature : 23.6°C; Liquid Temperature : 22.5°C

DASY5 Configuration:

- Probe: EX3DV4 - SN7612; ConvF(5.2, 5.2, 5.2) @ 5750 MHz; Calibrated: 2024/03/20
- Sensor-Surface: 1.4mm (Mechanical Surface Detection)
- Electronics: DAE4 Sn1633; Calibrated: 2024/03/06
- Phantom: SAM Right ; Type: QD000P40CD; Serial: TP:1611
- Measurement SW: DASY52, Version 52.10 (4); SEMCAD X Version 14.6.14 (7501)

Pin=100mW/Area Scan (91x91x1): Interpolated grid: dx=1.000 mm, dy=1.000 mm

Maximum value of SAR (interpolated) = 19.2 W/kg

Pin=100mW/Zoom Scan (7x7x12)/Cube 0: Measurement grid: dx=4mm, dy=4mm, dz=2mm

Reference Value = 23.27 V/m; Power Drift = 0.09 dB

Peak SAR (extrapolated) = 36.3 W/kg

SAR(1 g) = 7.74 W/kg; SAR(10 g) = 2.18 W/kg

Smallest distance from peaks to all points 3 dB below = 7.2 mm

Ratio of SAR at M2 to SAR at M1 = 49.3%

Maximum value of SAR (measured) = 20.5 W/kg

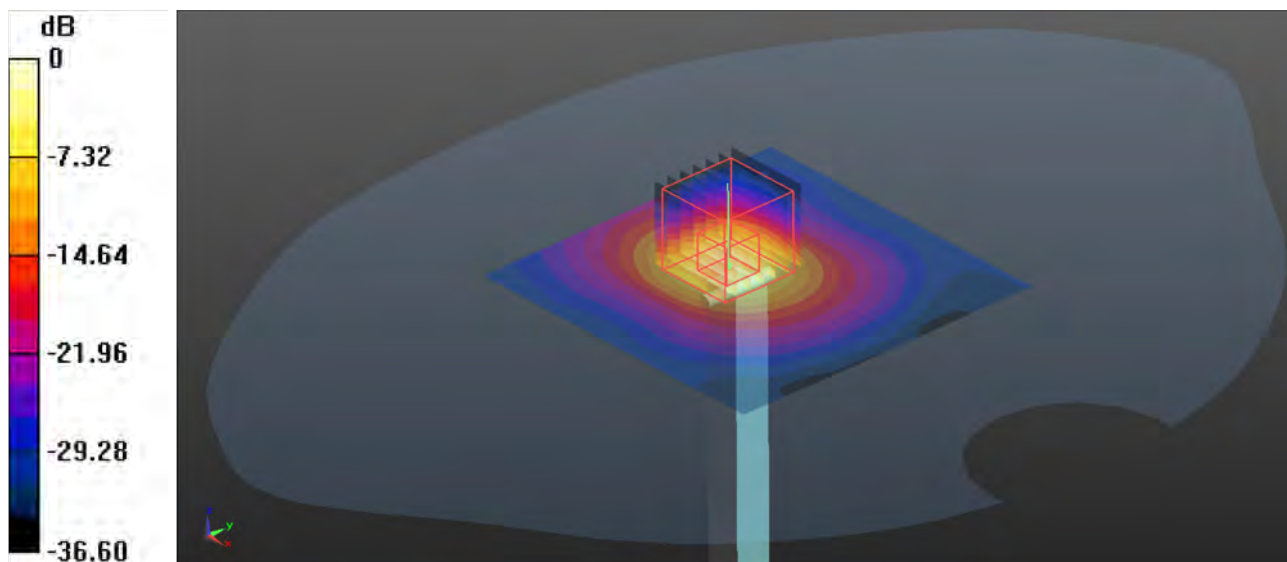

0 dB = 20.5 W/kg



BUREAU
VERITAS



Appendix B. SAR Plots of SAR Measurement

The SAR plots for highest measured SAR in each exposure configuration, wireless mode and frequency band combination, and measured SAR > 1.5 W/kg are shown as follows.

P01 GSM850_GPRS 4Tx Slot_Right Cheek_Ch251

Communication System: GPRS 4Tx Slot; Frequency: 848.8 MHz; Duty Cycle: 1:2.08
Medium: HSL835_0711 Medium parameters used: $f = 849$ MHz; $\sigma = 0.951$ S/m; $\epsilon_r = 42.966$; $\rho = 1000$ kg/m³
Ambient Temperature : 23.6°C; Liquid Temperature : 22.4°C

DASY5 Configuration:

- Probe: EX3DV4 - SN7612; ConvF(10.96, 10.96, 10.96) @ 848.8 MHz; Calibrated: 2024/03/20
- Sensor-Surface: 1.4mm (Mechanical Surface Detection)
- Electronics: DAE4 Sn1633; Calibrated: 2024/03/06
- Phantom: SAM Right ; Type: QD000P40CD; Serial: TP:1611
- Measurement SW: DASY52, Version 52.10 (4); SEMCAD X Version 14.6.14 (7501)

-Area Scan (71x71x1): Interpolated grid: dx=1.500 mm, dy=1.500 mm
Maximum value of SAR (interpolated) = 1.63 W/kg

-Zoom Scan (5x5x7)/Cube 0: Measurement grid: dx=8mm, dy=8mm, dz=5mm
Reference Value = 31.27 V/m; Power Drift = 0.15 dB
Peak SAR (extrapolated) = 1.88 W/kg
SAR(1 g) = 0.833 W/kg; SAR(10 g) = 0.481 W/kg
Smallest distance from peaks to all points 3 dB below = 11.5 mm
Ratio of SAR at M2 to SAR at M1 = 42.5%
Maximum value of SAR (measured) = 1.35 W/kg

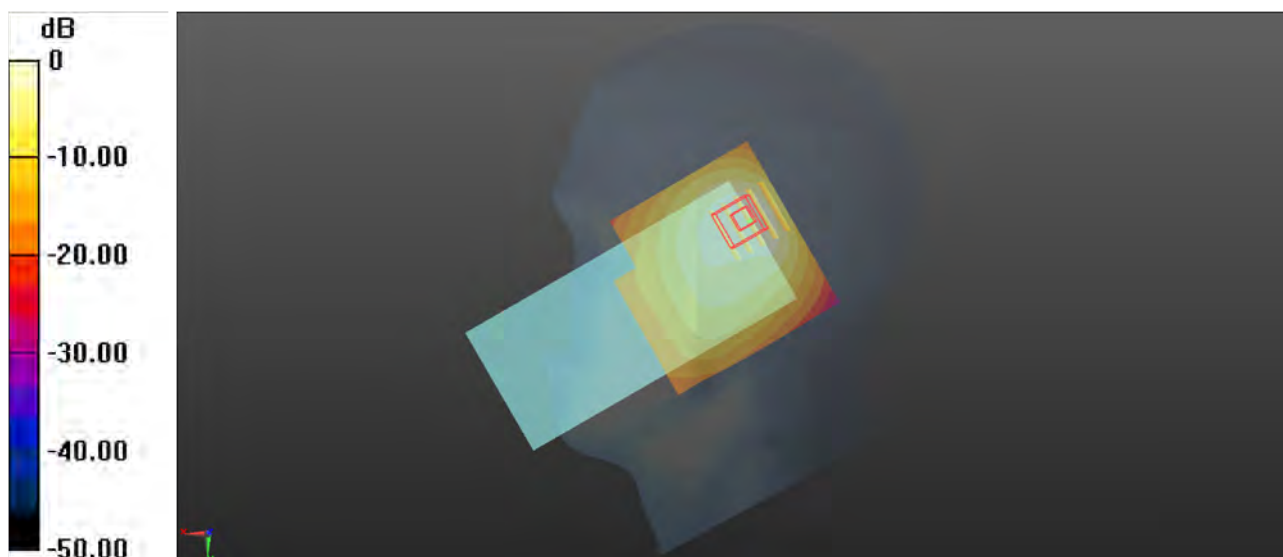

0 dB = 1.35 W/kg

P02 GSM1900_GPRS 1Tx Slot_Right Tilted_Ch810

Communication System: GPRS 1Tx Slot; Frequency: 1909.8 MHz; Duty Cycle: 1:8.3

Medium: HSL1950_0713 Medium parameters used: $f = 1910$ MHz; $\sigma = 1.444$ S/m; $\epsilon_r = 38.987$; $\rho = 1000$ kg/m³

Ambient Temperature : 23.7°C; Liquid Temperature : 22.5°C

DASY5 Configuration:

- Probe: EX3DV4 - SN7612; ConvF(8.83, 8.83, 8.83) @ 1909.8 MHz; Calibrated: 2024/03/20
- Sensor-Surface: 1.4mm (Mechanical Surface Detection)
- Electronics: DAE4 Sn1633; Calibrated: 2024/03/06
- Phantom: SAM Right ; Type: QD000P40CD; Serial: TP:1611
- Measurement SW: DASY52, Version 52.10 (4); SEMCAD X Version 14.6.14 (7501)

-Area Scan (71x71x1): Interpolated grid: dx=1.500 mm, dy=1.500 mm

Maximum value of SAR (interpolated) = 1.22 W/kg

-Zoom Scan (5x5x7)/Cube 0: Measurement grid: dx=8mm, dy=8mm, dz=5mm

Reference Value = 16.71 V/m; Power Drift = 0.13 dB

Peak SAR (extrapolated) = 1.40 W/kg

SAR(1 g) = 0.715 W/kg; SAR(10 g) = 0.341 W/kg

Smallest distance from peaks to all points 3 dB below = 8.6 mm

Ratio of SAR at M2 to SAR at M1 = 52.1%

Maximum value of SAR (measured) = 1.16 W/kg

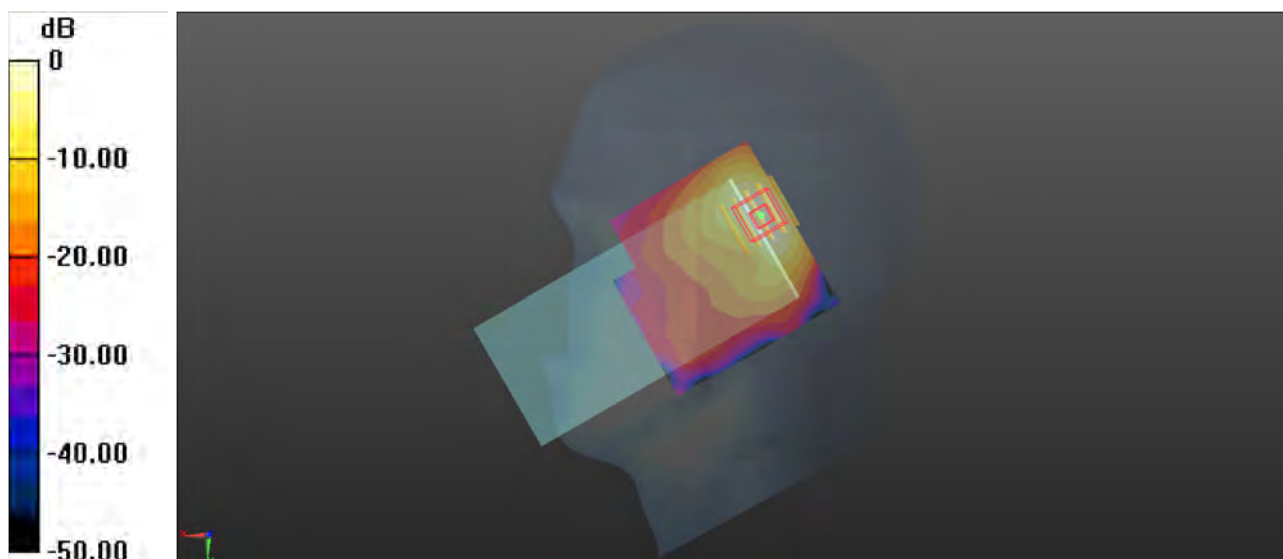

0 dB = 1.16 W/kg

P03 WCDMA II_RMC12.2K_Right Tilted_Ch9538

Communication System: WCDMA; Frequency: 1907.6 MHz; Duty Cycle: 1:1

Medium: HSL1950_0713 Medium parameters used: $f = 1908$ MHz; $\sigma = 1.443$ S/m; $\epsilon_r = 38.989$; $\rho = 1000$ kg/m³

Ambient Temperature : 23.7°C; Liquid Temperature : 22.5°C

DASY5 Configuration:

- Probe: EX3DV4 - SN7612; ConvF(8.83, 8.83, 8.83) @ 1907.6 MHz; Calibrated: 2024/03/20
- Sensor-Surface: 1.4mm (Mechanical Surface Detection)
- Electronics: DAE4 Sn1633; Calibrated: 2024/03/06
- Phantom: SAM Right ; Type: QD000P40CD; Serial: TP:1611
- Measurement SW: DASY52, Version 52.10 (4); SEMCAD X Version 14.6.14 (7501)

-Area Scan (71x71x1): Interpolated grid: dx=1.500 mm, dy=1.500 mm

Maximum value of SAR (interpolated) = 1.26 W/kg

-Zoom Scan (5x5x7)/Cube 0: Measurement grid: dx=8mm, dy=8mm, dz=5mm

Reference Value = 17.69 V/m; Power Drift = -0.02 dB

Peak SAR (extrapolated) = 1.46 W/kg

SAR(1 g) = 0.739 W/kg; SAR(10 g) = 0.352 W/kg

Smallest distance from peaks to all points 3 dB below = 8 mm

Ratio of SAR at M2 to SAR at M1 = 51.2%

Maximum value of SAR (measured) = 1.21 W/kg

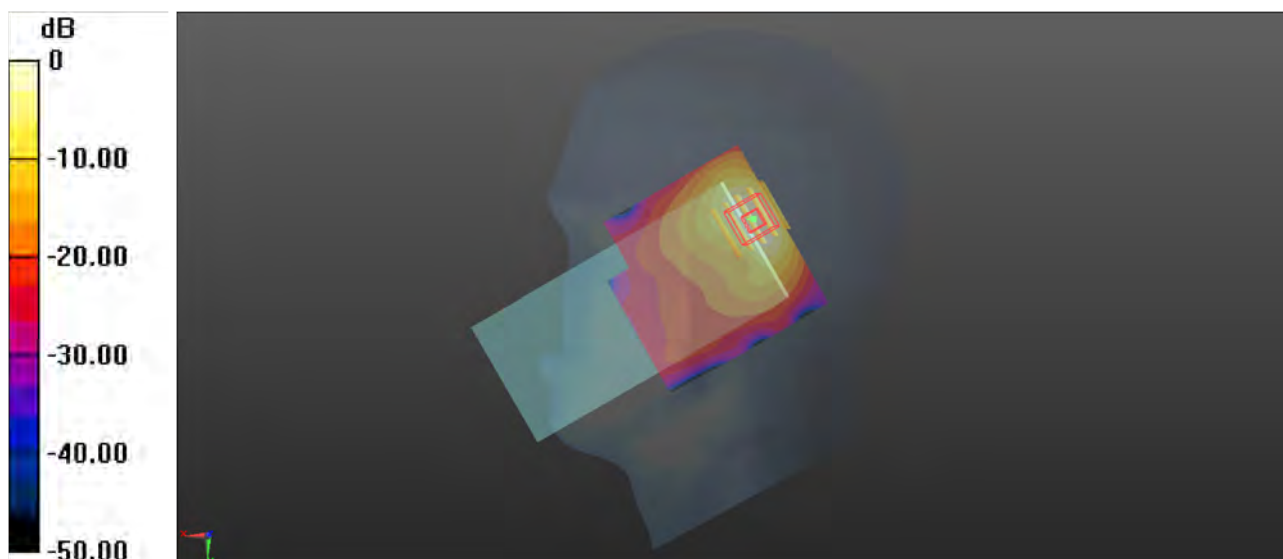

0 dB = 1.21 W/kg

P04 WCDMA IV_RMC12.2K_Right Tilted_Ch1413

Communication System: WCDMA; Frequency: 1732.6 MHz; Duty Cycle: 1:1

Medium: HSL1750_0713 Medium parameters used: $f = 1733$ MHz; $\sigma = 1.366$ S/m; $\epsilon_r = 40.897$; $\rho = 1000$ kg/m³

Ambient Temperature : 23.8°C; Liquid Temperature : 22.6°C

DASY5 Configuration:

- Probe: EX3DV4 - SN7612; ConvF(9.2, 9.2, 9.2) @ 1732.6 MHz; Calibrated: 2024/03/20
- Sensor-Surface: 1.4mm (Mechanical Surface Detection)
- Electronics: DAE4 Sn1633; Calibrated: 2024/03/06
- Phantom: SAM Right ; Type: QD000P40CD; Serial: TP:1611
- Measurement SW: DASY52, Version 52.10 (4); SEMCAD X Version 14.6.14 (7501)

-Area Scan (71x71x1): Interpolated grid: dx=1.500 mm, dy=1.500 mm

Maximum value of SAR (interpolated) = 1.22 W/kg

-Zoom Scan (5x5x7)/Cube 0: Measurement grid: dx=8mm, dy=8mm, dz=5mm

Reference Value = 18.37 V/m; Power Drift = -0.04 dB

Peak SAR (extrapolated) = 1.41 W/kg

SAR(1 g) = 0.717 W/kg; SAR(10 g) = 0.341 W/kg

Smallest distance from peaks to all points 3 dB below = 8 mm

Ratio of SAR at M2 to SAR at M1 = 51.9%

Maximum value of SAR (measured) = 1.17 W/kg

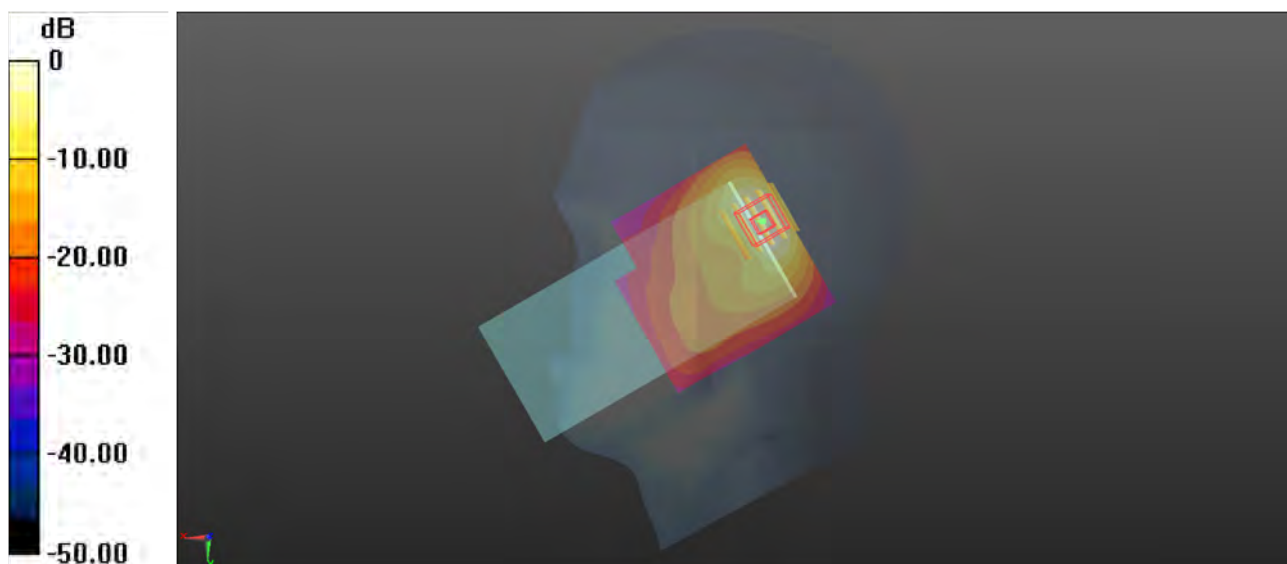

0 dB = 1.17 W/kg

P05 WCDMA V_RMC12.2K_Right Cheek_Ch4233

Communication System: WCDMA; Frequency: 846.6 MHz; Duty Cycle: 1:1

Medium: HSL835_0711 Medium parameters used: $f = 847$ MHz; $\sigma = 0.949$ S/m; $\epsilon_r = 42.954$; $\rho = 1000$ kg/m³

Ambient Temperature : 23.6°C; Liquid Temperature : 22.4°C

DASY5 Configuration:

- Probe: EX3DV4 - SN7612; ConvF(10.96, 10.96, 10.96) @ 846.6 MHz; Calibrated: 2024/03/20
- Sensor-Surface: 1.4mm (Mechanical Surface Detection)
- Electronics: DAE4 Sn1633; Calibrated: 2024/03/06
- Phantom: SAM Right ; Type: QD000P40CD; Serial: TP:1611
- Measurement SW: DASY52, Version 52.10 (4); SEMCAD X Version 14.6.14 (7501)

-Area Scan (71x71x1): Interpolated grid: dx=1.500 mm, dy=1.500 mm

Maximum value of SAR (interpolated) = 1.23 W/kg

-Zoom Scan (5x5x7)/Cube 0: Measurement grid: dx=8mm, dy=8mm, dz=5mm

Reference Value = 28.53 V/m; Power Drift = -0.07 dB

Peak SAR (extrapolated) = 1.37 W/kg

SAR(1 g) = 0.659 W/kg; SAR(10 g) = 0.397 W/kg

Smallest distance from peaks to all points 3 dB below = 11.3 mm

Ratio of SAR at M2 to SAR at M1 = 48.1%

Maximum value of SAR (measured) = 1.03 W/kg

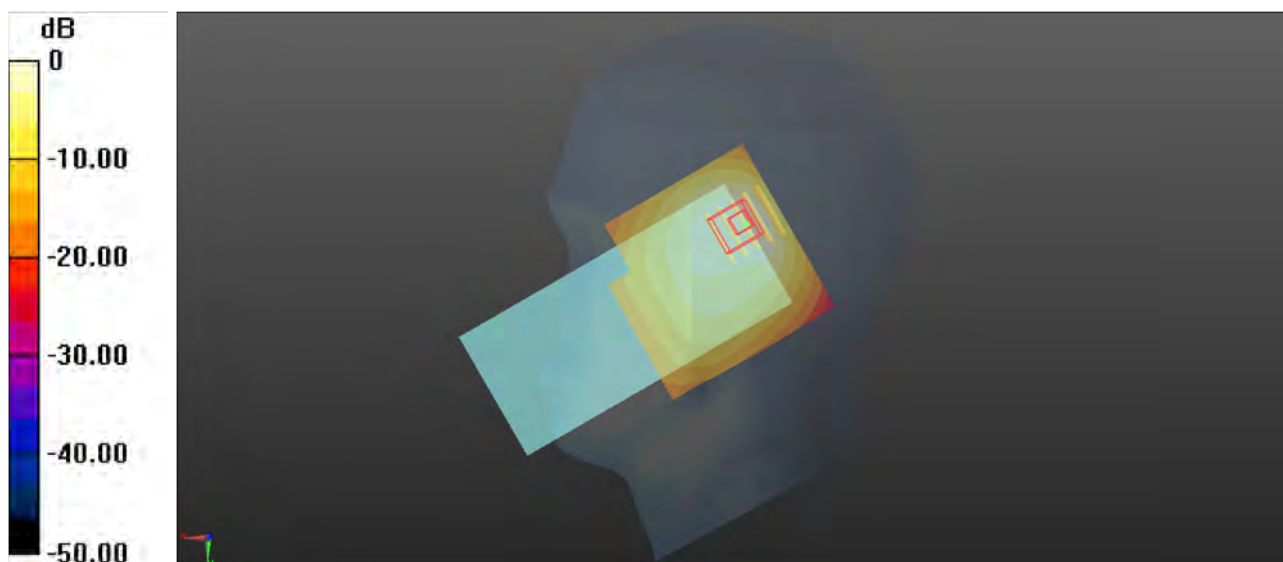

0 dB = 1.03 W/kg

P06 LTE 2_QPSK20M_Right Tilted_Ch18700_50RB_OS25

Communication System: LTE_FDD; Frequency: 1860 MHz; Duty Cycle: 1:1

Medium: HSL1950_0714 Medium parameters used: $f = 1860$ MHz; $\sigma = 1.414$ S/m; $\epsilon_r = 39.4$; $\rho = 1000$ kg/m³

Ambient Temperature : 23.6°C; Liquid Temperature : 22.5°C

DASY5 Configuration:

- Probe: EX3DV4 - SN7612; ConvF(8.83, 8.83, 8.83) @ 1860 MHz; Calibrated: 2024/03/20
- Sensor-Surface: 1.4mm (Mechanical Surface Detection)
- Electronics: DAE4 Sn1633; Calibrated: 2024/03/06
- Phantom: SAM Right ; Type: QD000P40CD; Serial: TP:1611
- Measurement SW: DASY52, Version 52.10 (4); SEMCAD X Version 14.6.14 (7501)

-Area Scan (71x71x1): Interpolated grid: dx=1.500 mm, dy=1.500 mm

Maximum value of SAR (interpolated) = 0.769 W/kg

-Zoom Scan (5x5x7)/Cube 0: Measurement grid: dx=8mm, dy=8mm, dz=5mm

Reference Value = 13.68 V/m; Power Drift = 0.06 dB

Peak SAR (extrapolated) = 0.893 W/kg

SAR(1 g) = 0.440 W/kg; SAR(10 g) = 0.209 W/kg

Smallest distance from peaks to all points 3 dB below = 8.6 mm

Ratio of SAR at M2 to SAR at M1 = 49.6%

Maximum value of SAR (measured) = 0.734 W/kg

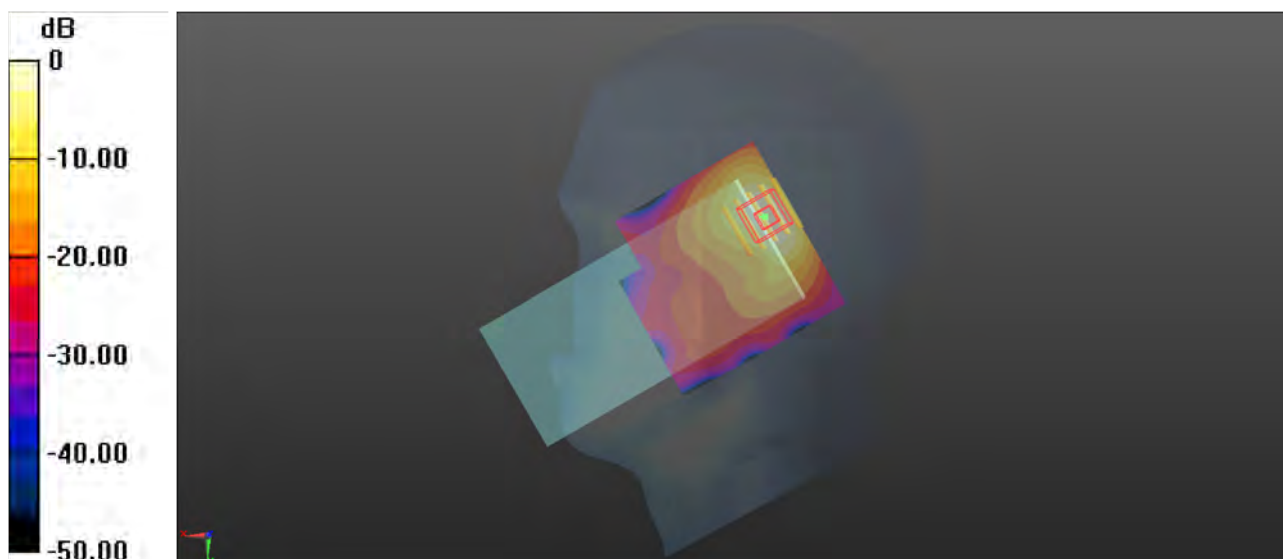

0 dB = 0.734 W/kg

P07 LTE 5_QPSK10M_Right Cheek_Ch20600_25RB_OS12

Communication System: LTE_FDD; Frequency: 844 MHz; Duty Cycle: 1:1
Medium: HSL835_0711 Medium parameters used: $f = 844$ MHz; $\sigma = 0.948$ S/m; $\epsilon_r = 42.96$; $\rho = 1000$ kg/m³
Ambient Temperature : 23.6°C; Liquid Temperature : 22.4°C

DASY5 Configuration:

- Probe: EX3DV4 - SN7612; ConvF(10.96, 10.96, 10.96) @ 844 MHz; Calibrated: 2024/03/20
- Sensor-Surface: 1.4mm (Mechanical Surface Detection)
- Electronics: DAE4 Sn1633; Calibrated: 2024/03/06
- Phantom: SAM Right ; Type: QD000P40CD; Serial: TP:1611
- Measurement SW: DASY52, Version 52.10 (4); SEMCAD X Version 14.6.14 (7501)

-Area Scan (71x71x1): Interpolated grid: dx=1.500 mm, dy=1.500 mm
Maximum value of SAR (interpolated) = 1.19 W/kg

-Zoom Scan (5x5x7)/Cube 0: Measurement grid: dx=8mm, dy=8mm, dz=5mm
Reference Value = 28.71 V/m; Power Drift = -0.03 dB
Peak SAR (extrapolated) = 1.33 W/kg
SAR(1 g) = 0.648 W/kg; SAR(10 g) = 0.391 W/kg
Smallest distance from peaks to all points 3 dB below = 12.8 mm
Ratio of SAR at M2 to SAR at M1 = 46.5%
Maximum value of SAR (measured) = 1.01 W/kg

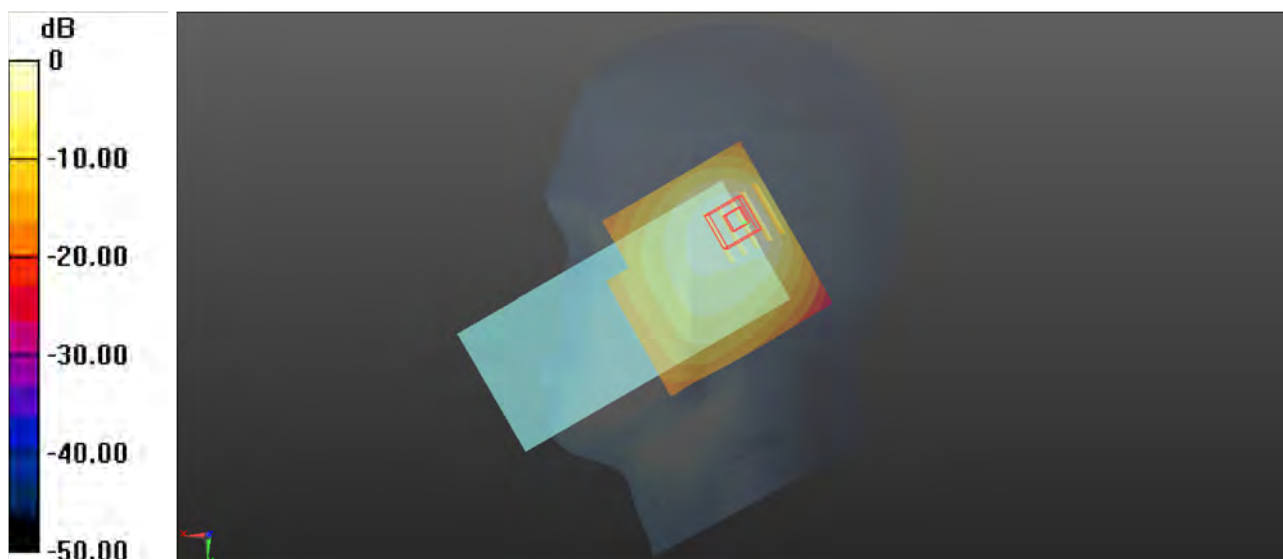

0 dB = 1.01 W/kg

P08 LTE 7_QPSK20M_Right Tilted_Ch20850_1RB_OS50

Communication System: LTE_FDD; Frequency: 2510 MHz; Duty Cycle: 1:1

Medium: HSL2550_0715 Medium parameters used: $f = 2510$ MHz; $\sigma = 1.864$ S/m; $\epsilon_r = 39.246$; $\rho = 1000$ kg/m³

Ambient Temperature : 23.8°C; Liquid Temperature : 22.7°C

DASY5 Configuration:

- Probe: EX3DV4 - SN7612; ConvF(8.01, 8.01, 8.01) @ 2510 MHz; Calibrated: 2024/03/20
- Sensor-Surface: 1.4mm (Mechanical Surface Detection)
- Electronics: DAE4 Sn1633; Calibrated: 2024/03/06
- Phantom: SAM Right ; Type: QD000P40CD; Serial: TP:1611
- Measurement SW: DASY52, Version 52.10 (4); SEMCAD X Version 14.6.14 (7501)

-Area Scan (91x91x1): Interpolated grid: dx=1.200 mm, dy=1.200 mm

Maximum value of SAR (interpolated) = 0.791 W/kg

-Zoom Scan (7x7x7)/Cube 0: Measurement grid: dx=5mm, dy=5mm, dz=5mm

Reference Value = 17.44 V/m; Power Drift = -0.02 dB

Peak SAR (extrapolated) = 1.09 W/kg

SAR(1 g) = 0.512 W/kg; SAR(10 g) = 0.226 W/kg

Smallest distance from peaks to all points 3 dB below = 6 mm

Ratio of SAR at M2 to SAR at M1 = 50%

Maximum value of SAR (measured) = 0.849 W/kg

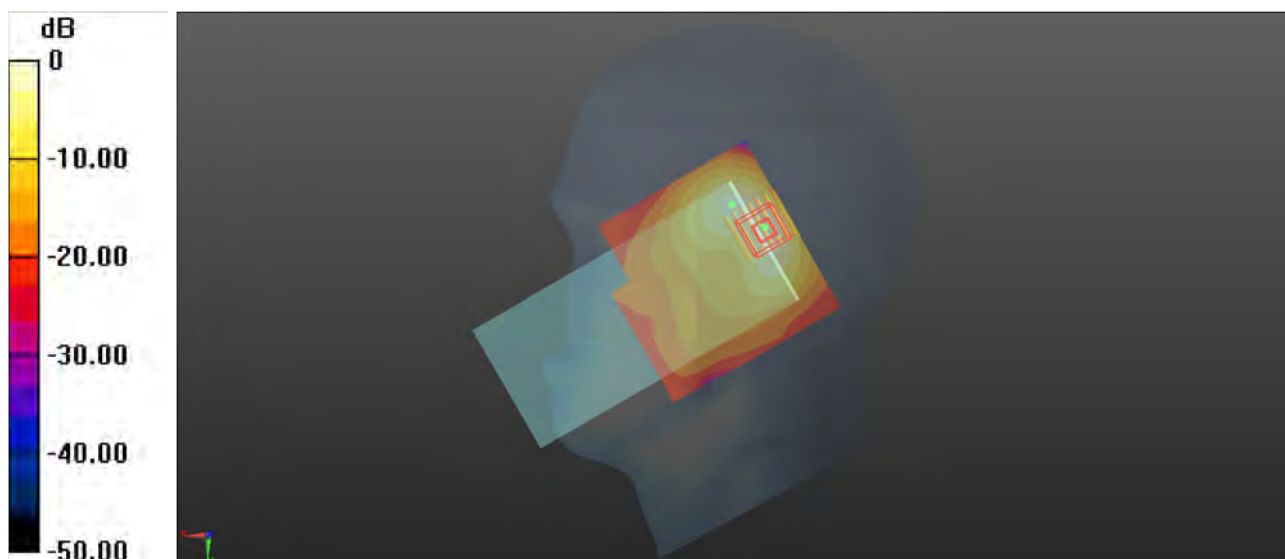

0 dB = 0.849 W/kg

P09 LTE 38_QPSK20M_Right Tilted_Ch38000_50RB_OS25

Communication System: LTE_TDD; Frequency: 2595 MHz; Duty Cycle: 1:1.59

Medium: HSL2550_0715 Medium parameters used: $f = 2595$ MHz; $\sigma = 1.981$ S/m; $\epsilon_r = 39.409$; $\rho = 1000$ kg/m³

Ambient Temperature : 23.8°C; Liquid Temperature : 22.7°C

DASY5 Configuration:

- Probe: EX3DV4 - SN7612; ConvF(8.01, 8.01, 8.01) @ 2595 MHz; Calibrated: 2024/03/20
- Sensor-Surface: 1.4mm (Mechanical Surface Detection)
- Electronics: DAE4 Sn1633; Calibrated: 2024/03/06
- Phantom: SAM Right ; Type: QD000P40CD; Serial: TP:1611
- Measurement SW: DASY52, Version 52.10 (4); SEMCAD X Version 14.6.14 (7501)

-Area Scan (91x91x1): Interpolated grid: dx=1.200 mm, dy=1.200 mm

Maximum value of SAR (interpolated) = 0.687 W/kg

-Zoom Scan (7x7x7)/Cube 0: Measurement grid: dx=5mm, dy=5mm, dz=5mm

Reference Value = 16.40 V/m; Power Drift = -0.01 dB

Peak SAR (extrapolated) = 0.960 W/kg

SAR(1 g) = 0.450 W/kg; SAR(10 g) = 0.199 W/kg

Smallest distance from peaks to all points 3 dB below = 7 mm

Ratio of SAR at M2 to SAR at M1 = 50.4%

Maximum value of SAR (measured) = 0.734 W/kg

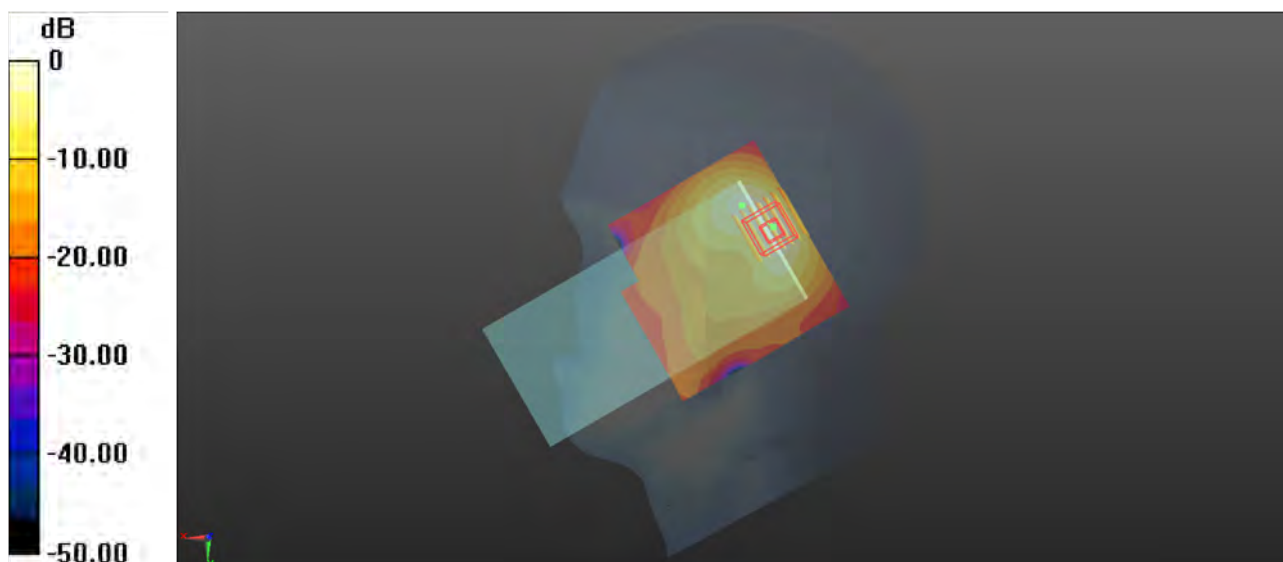

0 dB = 0.734 W/kg

P10 LTE 41_QPSK20M_Right Tilted_Ch39750_100RB_OS0

Communication System: LTE_TDD; Frequency: 2506 MHz; Duty Cycle: 1:1.59

Medium: HSL2550_0716 Medium parameters used: $f = 2506$ MHz; $\sigma = 1.861$ S/m; $\epsilon_r = 39.255$; $\rho = 1000$ kg/m³

Ambient Temperature : 23.7°C; Liquid Temperature : 22.5°C

DASY5 Configuration:

- Probe: EX3DV4 - SN7612; ConvF(8.01, 8.01, 8.01) @ 2506 MHz; Calibrated: 2024/03/20
- Sensor-Surface: 1.4mm (Mechanical Surface Detection)
- Electronics: DAE4 Sn1633; Calibrated: 2024/03/06
- Phantom: SAM Right ; Type: QD000P40CD; Serial: TP:1611
- Measurement SW: DASY52, Version 52.10 (4); SEMCAD X Version 14.6.14 (7501)

-Area Scan (91x91x1): Interpolated grid: dx=1.200 mm, dy=1.200 mm

Maximum value of SAR (interpolated) = 0.882 W/kg

-Zoom Scan (7x7x7)/Cube 0: Measurement grid: dx=5mm, dy=5mm, dz=5mm

Reference Value = 18.33 V/m; Power Drift = -0.09 dB

Peak SAR (extrapolated) = 1.20 W/kg

SAR(1 g) = 0.561 W/kg; SAR(10 g) = 0.247 W/kg

Smallest distance from peaks to all points 3 dB below = 7 mm

Ratio of SAR at M2 to SAR at M1 = 49.7%

Maximum value of SAR (measured) = 0.934 W/kg

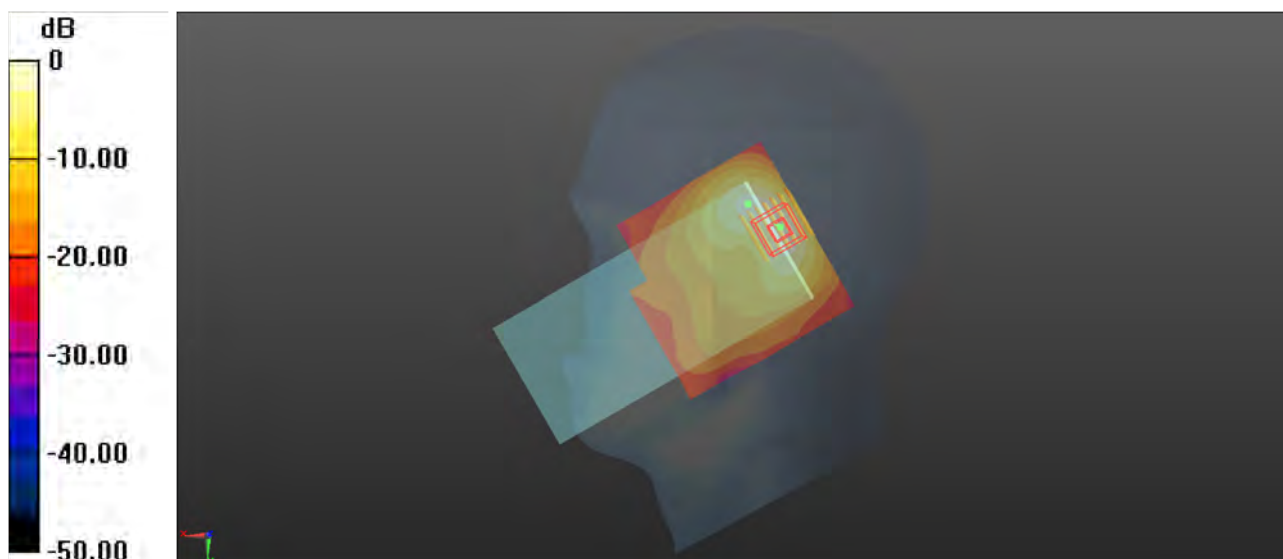

0 dB = 0.934 W/kg

P11 LTE 66_QPSK20M_Right Tilted_Ch132072_50RB_OS25

Communication System: LTE_FDD; Frequency: 1720 MHz; Duty Cycle: 1:1

Medium: HSL1750_0712 Medium parameters used: $f = 1720$ MHz; $\sigma = 1.338$ S/m; $\epsilon_r = 39.395$; $\rho = 1000$ kg/m³

Ambient Temperature : 23.7°C; Liquid Temperature : 22.3°C

DASY5 Configuration:

- Probe: EX3DV4 - SN7612; ConvF(9.2, 9.2, 9.2) @ 1720 MHz; Calibrated: 2024/03/20
- Sensor-Surface: 1.4mm (Mechanical Surface Detection)
- Electronics: DAE4 Sn1633; Calibrated: 2024/03/06
- Phantom: SAM Right ; Type: QD000P40CD; Serial: TP:1611
- Measurement SW: DASY52, Version 52.10 (4); SEMCAD X Version 14.6.14 (7501)

-Area Scan (71x71x1): Interpolated grid: dx=1.500 mm, dy=1.500 mm

Maximum value of SAR (interpolated) = 0.927 W/kg

-Zoom Scan (5x5x7)/Cube 0: Measurement grid: dx=8mm, dy=8mm, dz=5mm

Reference Value = 20.27 V/m; Power Drift = 0.01 dB

Peak SAR (extrapolated) = 1.41 W/kg

SAR(1 g) = 0.685 W/kg; SAR(10 g) = 0.319 W/kg

Smallest distance from peaks to all points 3 dB below = 8 mm

Ratio of SAR at M2 to SAR at M1 = 52.5%

Maximum value of SAR (measured) = 0.902 W/kg

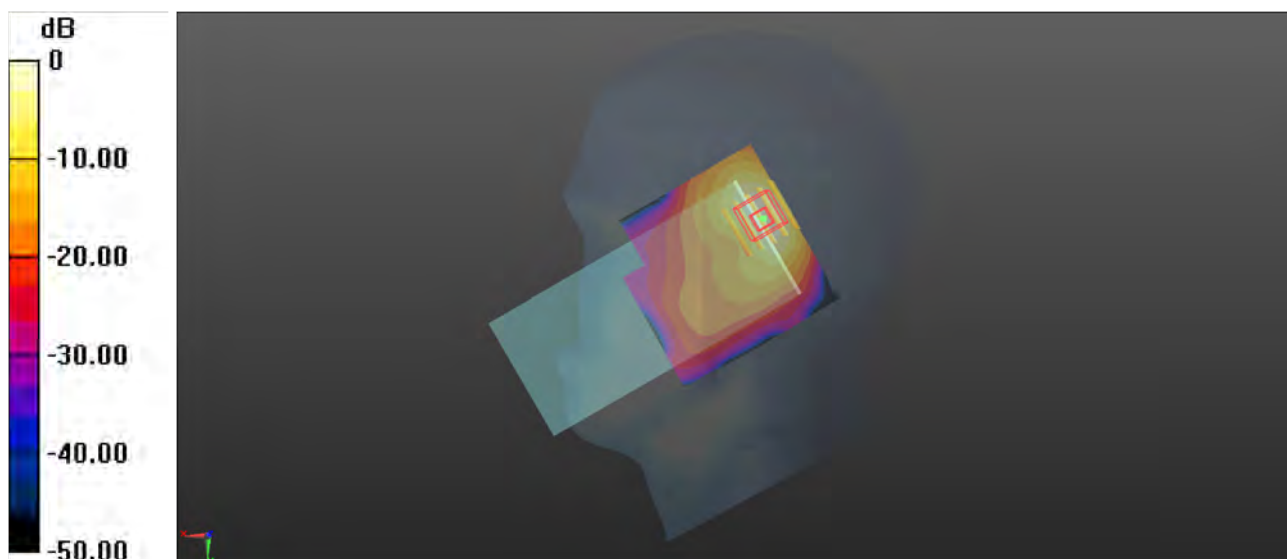

0 dB = 0.902 W/kg

P12 WLAN 2.4G_802.11b_Left Cheek_Ch11

Communication System: 802.11b; Frequency: 2462 MHz; Duty Cycle: 1:1.005

Medium: HSL2450_0714 Medium parameters used: $f = 2462$ MHz; $\sigma = 1.887$ S/m; $\epsilon_r = 39.607$; $\rho = 1000$ kg/m³

Ambient Temperature : 23.5°C; Liquid Temperature : 22.6°C

DASY5 Configuration:

- Probe: EX3DV4 - SN7612; ConvF(8.2, 8.2, 8.2) @ 2462 MHz; Calibrated: 2024/03/20
- Sensor-Surface: 1.4mm (Mechanical Surface Detection)
- Electronics: DAE4 Sn1633; Calibrated: 2024/03/06
- Phantom: SAM Right ; Type: QD000P40CD; Serial: TP:1611
- Measurement SW: DASY52, Version 52.10 (4); SEMCAD X Version 14.6.14 (7501)

-Area Scan (91x91x1): Interpolated grid: dx=1.200 mm, dy=1.200 mm

Maximum value of SAR (interpolated) = 0.614 W/kg

-Zoom Scan (7x7x7)/Cube 0: Measurement grid: dx=5mm, dy=5mm, dz=5mm

Reference Value = 9.340 V/m; Power Drift = -0.08 dB

Peak SAR (extrapolated) = 0.670 W/kg

SAR(1 g) = 0.335 W/kg; SAR(10 g) = 0.171 W/kg

Smallest distance from peaks to all points 3 dB below = 11.2 mm

Ratio of SAR at M2 to SAR at M1 = 49.8%

Maximum value of SAR (measured) = 0.535 W/kg

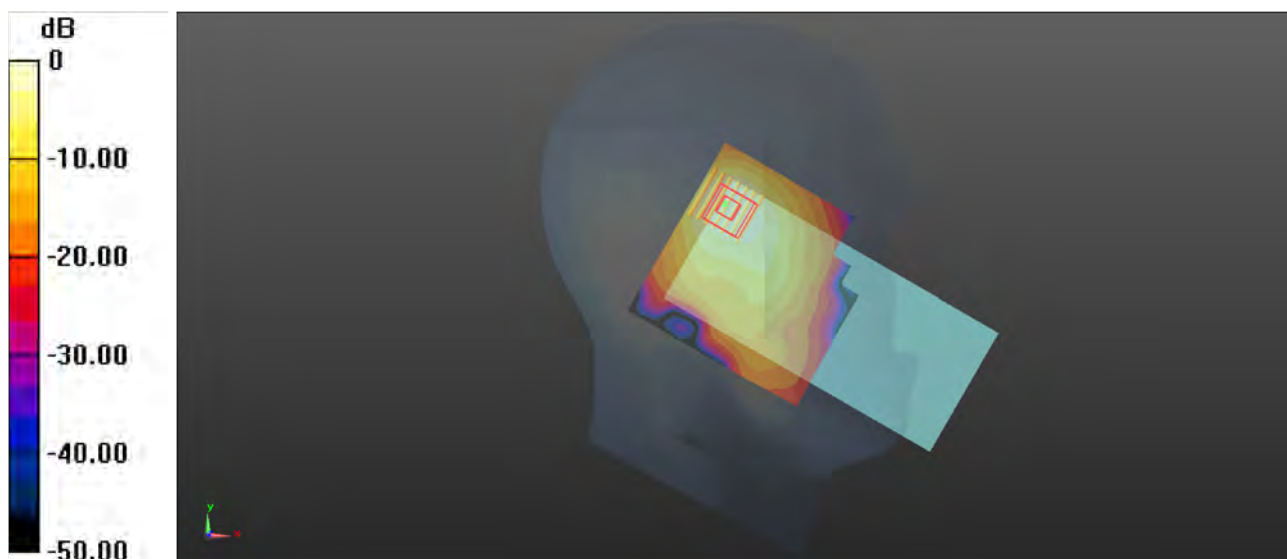

0 dB = 0.535 W/kg

P13 WLAN 5G_802.11n-HT20_Left Tilted_Ch64

Communication System: 802.11n-HT20; Frequency: 5320 MHz; Duty Cycle: 1:1.075
Medium: HSL5G_0717 Medium parameters used: $f = 5320$ MHz; $\sigma = 4.703$ S/m; $\epsilon_r = 35.04$; $\rho = 1000$ kg/m³
Ambient Temperature : 23.7°C; Liquid Temperature : 22.6°C

DASY5 Configuration:

- Probe: EX3DV4 - SN7612; ConvF(5.75, 5.75, 5.75) @ 5320 MHz; Calibrated: 2024/03/20
- Sensor-Surface: 1.4mm (Mechanical Surface Detection)
- Electronics: DAE4 Sn1633; Calibrated: 2024/03/06
- Phantom: SAM Right ; Type: QD000P40CD; Serial: TP:1611
- Measurement SW: DASY52, Version 52.10 (4); SEMCAD X Version 14.6.14 (7501)

-Area Scan (101x101x1): Interpolated grid: dx=1.000 mm, dy=1.000 mm
Maximum value of SAR (interpolated) = 0.792 W/kg

-Zoom Scan (7x7x12)/Cube 0: Measurement grid: dx=4mm, dy=4mm, dz=2mm
Reference Value = 4.300 V/m; Power Drift = 0.11 dB
Peak SAR (extrapolated) = 1.32 W/kg
SAR(1 g) = 0.311 W/kg; SAR(10 g) = 0.070 W/kg
Smallest distance from peaks to all points 3 dB below = 6.4 mm
Ratio of SAR at M2 to SAR at M1 = 51.8%
Maximum value of SAR (measured) = 0.888 W/kg

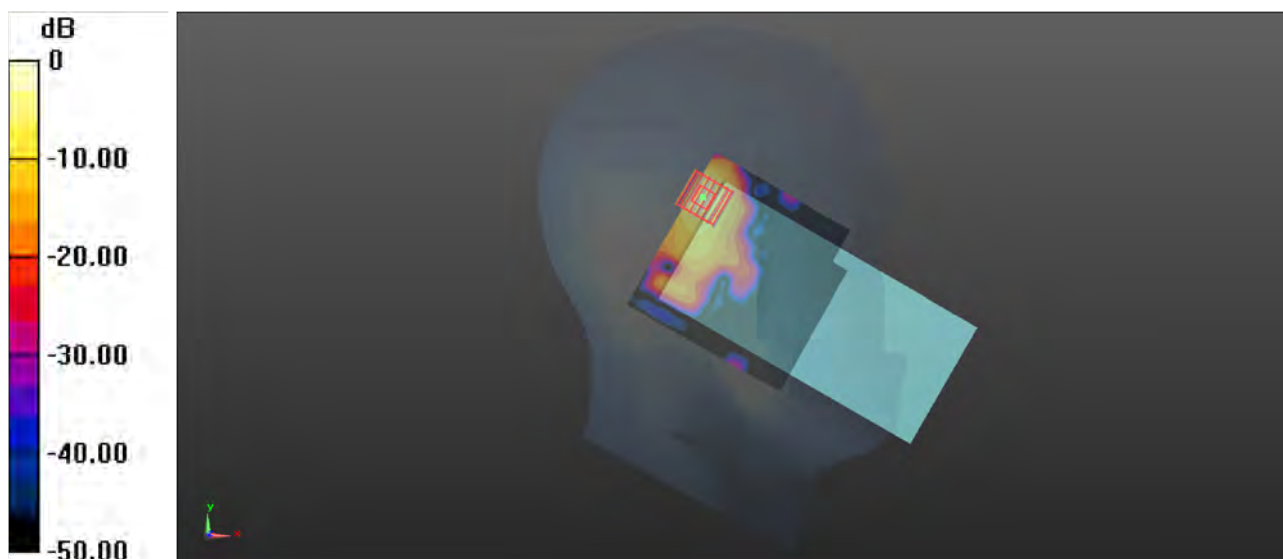

0 dB = 0.888 W/kg

P14 WLAN 5G_802.11n-HT20_Left Tilted_Ch140

Communication System: 802.11n-HT20; Frequency: 5700 MHz; Duty Cycle: 1:1.075
Medium: HSL5G_0717 Medium parameters used: $f = 5700$ MHz; $\sigma = 5.126$ S/m; $\epsilon_r = 34.376$; $\rho = 1000$ kg/m³
Ambient Temperature : 23.7°C; Liquid Temperature : 22.7°C

DASY5 Configuration:

- Probe: EX3DV4 - SN7612; ConvF(5.2, 5.2, 5.2) @ 5700 MHz; Calibrated: 2024/03/20
- Sensor-Surface: 1.4mm (Mechanical Surface Detection)
- Electronics: DAE4 Sn1633; Calibrated: 2024/03/06
- Phantom: SAM Right ; Type: QD000P40CD; Serial: TP:1611
- Measurement SW: DASY52, Version 52.10 (4); SEMCAD X Version 14.6.14 (7501)

-Area Scan (101x101x1): Interpolated grid: dx=1.000 mm, dy=1.000 mm
Maximum value of SAR (interpolated) = 0.395 W/kg

-Zoom Scan (7x7x12)/Cube 0: Measurement grid: dx=4mm, dy=4mm, dz=2mm
Reference Value = 2.910 V/m; Power Drift = 0.04 dB
Peak SAR (extrapolated) = 0.941 W/kg
SAR(1 g) = 0.114 W/kg; SAR(10 g) = 0.020 W/kg
Smallest distance from peaks to all points 3 dB below = 4.3 mm
Ratio of SAR at M2 to SAR at M1 = 47.4%
Maximum value of SAR (measured) = 0.417 W/kg

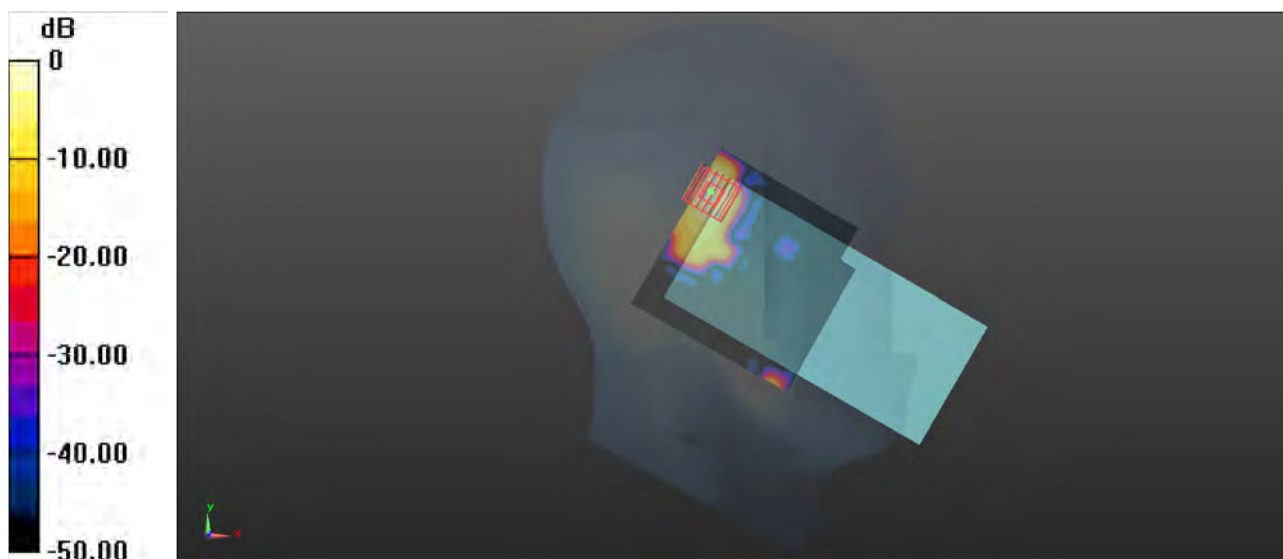

0 dB = 0.417 W/kg

P15 WLAN 5G_802.11ac-VHT80_Left Tilted_Ch155

Communication System: 802.11ac-VHT80; Frequency: 5775 MHz; Duty Cycle: 1:1.140
Medium: HSL5G_0717 Medium parameters used: $f = 5775$ MHz; $\sigma = 5.165$ S/m; $\epsilon_r = 34.413$; $\rho = 1000$ kg/m³
Ambient Temperature : 23.6°C; Liquid Temperature : 22.5°C

DASY5 Configuration:

- Probe: EX3DV4 - SN7612; ConvF(5.2, 5.2, 5.2) @ 5775 MHz; Calibrated: 2024/03/20
- Sensor-Surface: 1.4mm (Mechanical Surface Detection)
- Electronics: DAE4 Sn1633; Calibrated: 2024/03/06
- Phantom: SAM Right ; Type: QD000P40CD; Serial: TP:1611
- Measurement SW: DASY52, Version 52.10 (4); SEMCAD X Version 14.6.14 (7501)

-Area Scan (101x101x1): Interpolated grid: dx=1.000 mm, dy=1.000 mm
Maximum value of SAR (interpolated) = 0.301 W/kg

-Zoom Scan (7x7x12)/Cube 0: Measurement grid: dx=4mm, dy=4mm, dz=2mm
Reference Value = 2.233 V/m; Power Drift = 0.19 dB
Peak SAR (extrapolated) = 0.374 W/kg
SAR(1 g) = 0.078 W/kg; SAR(10 g) = 0.019 W/kg
Smallest distance from peaks to all points 3 dB below = 5.8 mm
Ratio of SAR at M2 to SAR at M1 = 49.3%
Maximum value of SAR (measured) = 0.219 W/kg

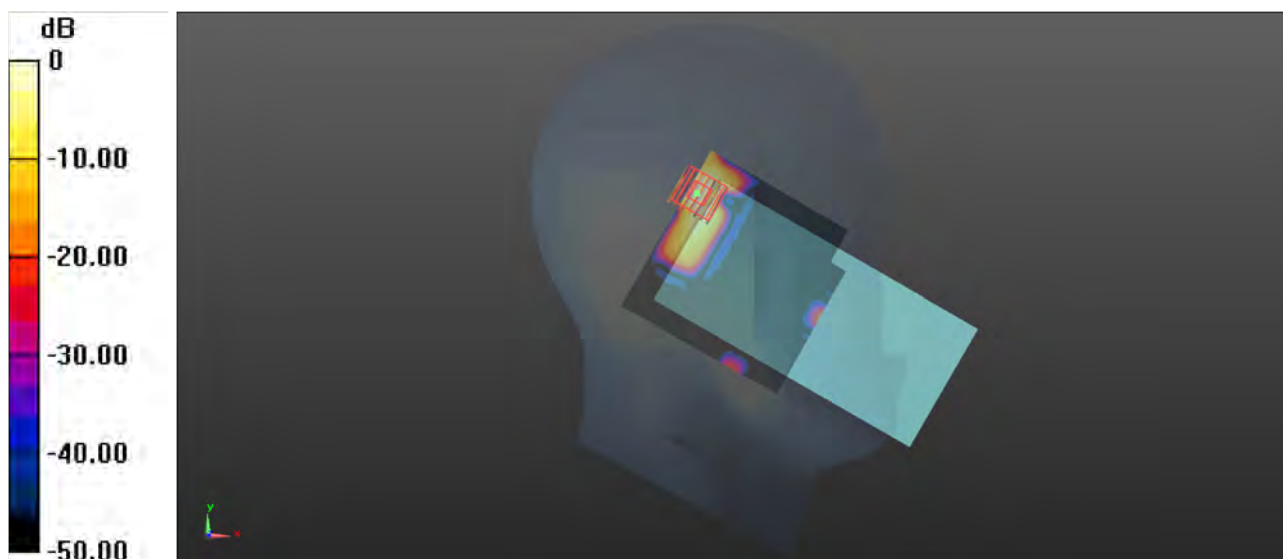

0 dB = 0.219 W/kg

P16 BT_GFSK_Left Cheek_Ch78

Communication System: BT; Frequency: 2480 MHz; Duty Cycle: 1:1.304

Medium: HSL2450_0714 Medium parameters used: $f = 2480$ MHz; $\sigma = 1.902$ S/m; $\epsilon_r = 39.572$; $\rho = 1000$ kg/m³

Ambient Temperature : 23.5°C; Liquid Temperature : 22.6°C

DASY5 Configuration:

- Probe: EX3DV4 - SN7612; ConvF(8.2, 8.2, 8.2) @ 2480 MHz; Calibrated: 2024/03/20
- Sensor-Surface: 1.4mm (Mechanical Surface Detection)
- Electronics: DAE4 Sn1633; Calibrated: 2024/03/06
- Phantom: SAM Right ; Type: QD000P40CD; Serial: TP:1611
- Measurement SW: DASY52, Version 52.10 (4); SEMCAD X Version 14.6.14 (7501)

-Area Scan (91x91x1): Interpolated grid: dx=1.200 mm, dy=1.200 mm

Maximum value of SAR (interpolated) = 0.249 W/kg

-Zoom Scan (7x7x7)/Cube 0: Measurement grid: dx=5mm, dy=5mm, dz=5mm

Reference Value = 5.785 V/m; Power Drift = 0.08 dB

Peak SAR (extrapolated) = 0.294 W/kg

SAR(1 g) = 0.149 W/kg; SAR(10 g) = 0.076 W/kg

Smallest distance from peaks to all points 3 dB below = 10.3 mm

Ratio of SAR at M2 to SAR at M1 = 49.7%

Maximum value of SAR (measured) = 0.237 W/kg

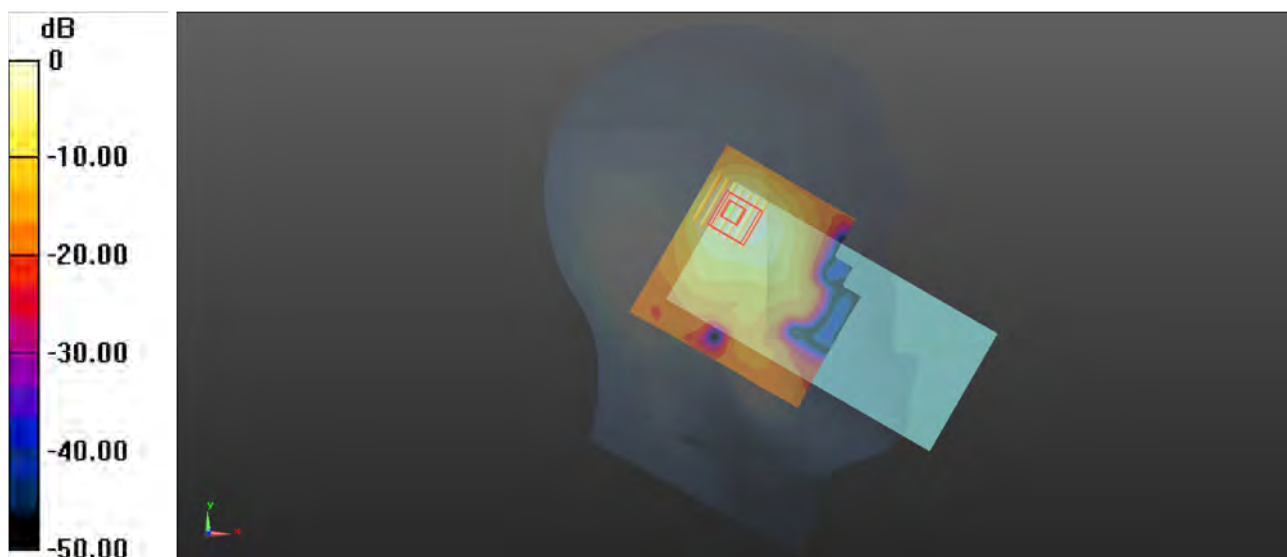

0 dB = 0.237 W/kg

P17 GSM 850_GPRS 4Tx Slot_Rear Face_1cm_Ch251

Communication System: GPRS 4Tx Slot; Frequency: 848.8 MHz; Duty Cycle: 1:2.08
Medium: HSL835_0711 Medium parameters used: $f = 849$ MHz; $\sigma = 0.951$ S/m; $\epsilon_r = 42.966$; $\rho = 1000$ kg/m³
Ambient Temperature : 23.6°C; Liquid Temperature : 22.4°C

DASY5 Configuration:

- Probe: EX3DV4 - SN7612; ConvF(10.96, 10.96, 10.96) @ 848.8 MHz; Calibrated: 2024/03/20
- Sensor-Surface: 1.4mm (Mechanical Surface Detection)
- Electronics: DAE4 Sn1633; Calibrated: 2024/03/06
- Phantom: SAM Right ; Type: QD000P40CD; Serial: TP:1611
- Measurement SW: DASY52, Version 52.10 (4); SEMCAD X Version 14.6.14 (7501)

-Area Scan (71x71x1): Interpolated grid: dx=1.500 mm, dy=1.500 mm
Maximum value of SAR (interpolated) = 0.419 W/kg

-Zoom Scan (5x5x7)/Cube 0: Measurement grid: dx=8mm, dy=8mm, dz=5mm
Reference Value = 11.94 V/m; Power Drift = 0.07 dB
Peak SAR (extrapolated) = 0.633 W/kg
SAR(1 g) = 0.335 W/kg; SAR(10 g) = 0.192 W/kg
Smallest distance from peaks to all points 3 dB below = 11.5 mm
Ratio of SAR at M2 to SAR at M1 = 53.4%
Maximum value of SAR (measured) = 0.417 W/kg

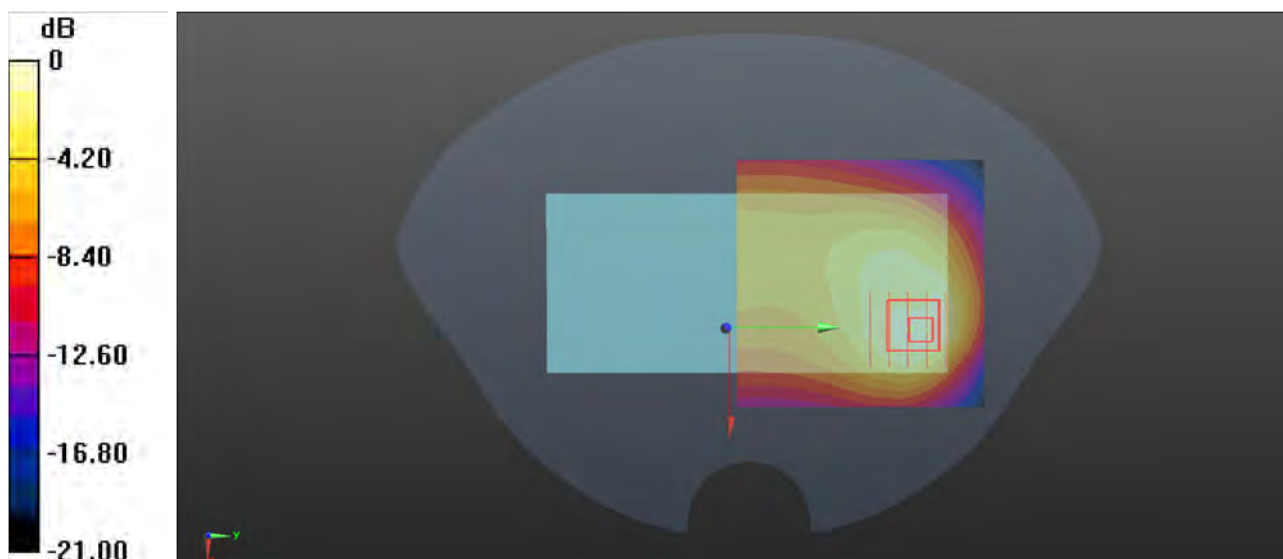

0 dB = 0.417 W/kg

P18 GSM1900_GPRS 1Tx Slot_Rear Face_1cm_Ch810

Communication System: GPRS 1Tx Slot; Frequency: 1909.8 MHz; Duty Cycle: 1:8.3
Medium: HSL1950_0713 Medium parameters used: $f = 1910$ MHz; $\sigma = 1.444$ S/m; $\epsilon_r = 38.987$; $\rho = 1000$ kg/m³
Ambient Temperature : 23.7°C; Liquid Temperature : 22.5°C

DASY5 Configuration:

- Probe: EX3DV4 - SN7612; ConvF(8.83, 8.83, 8.83) @ 1909.8 MHz; Calibrated: 2024/03/20
- Sensor-Surface: 1.4mm (Mechanical Surface Detection)
- Electronics: DAE4 Sn1633; Calibrated: 2023/03/06
- Phantom: SAM Right ; Type: QD000P40CD; Serial: TP:1611
- Measurement SW: DASY52, Version 52.10 (4); SEMCAD X Version 14.6.14 (7501)

- **Area Scan (71x71x1)**: Interpolated grid: dx=1.500 mm, dy=1.500 mm
Maximum value of SAR (interpolated) = 0.811 W/kg

- **Zoom Scan (5x5x7)/Cube 0**: Measurement grid: dx=8mm, dy=8mm, dz=5mm
Reference Value = 3.642 V/m; Power Drift = 0.02 dB
Peak SAR (extrapolated) = 1.25 W/kg
SAR(1 g) = 0.662 W/kg; SAR(10 g) = 0.330 W/kg
Smallest distance from peaks to all points 3 dB below = 9.6 mm
Ratio of SAR at M2 to SAR at M1 = 55.4%
Maximum value of SAR (measured) = 0.822 W/kg

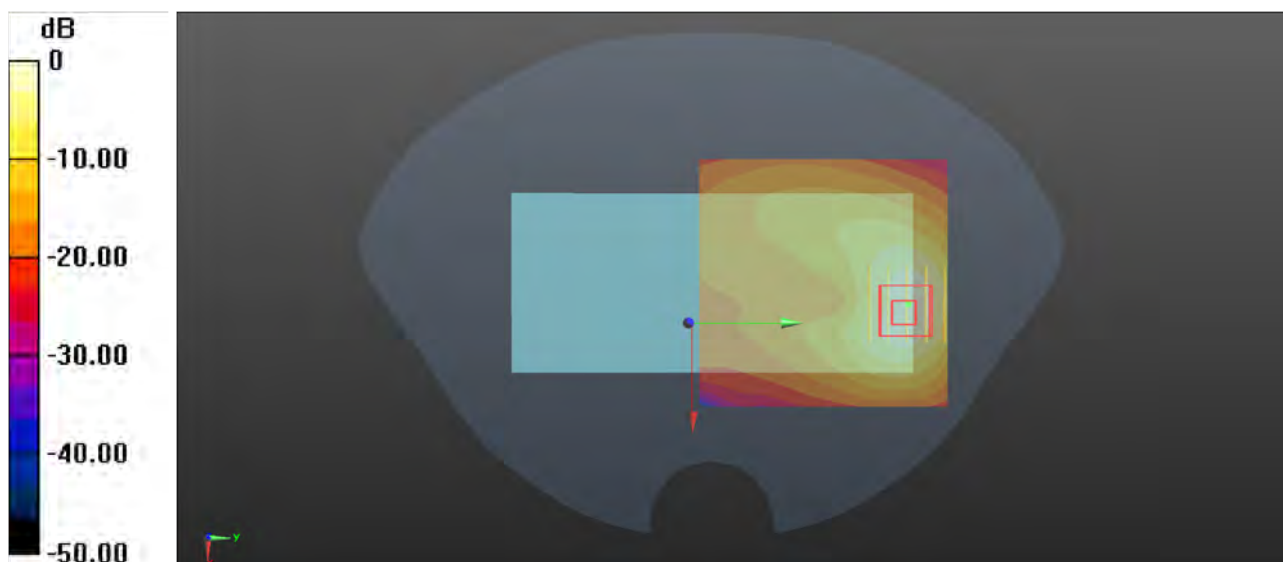

0 dB = 0.822 W/kg

P19 WCDMA II_RMC12.2K_Front Face_1.1cm_Ch9538

Communication System: WCDMA; Frequency: 1907.6 MHz; Duty Cycle: 1:1

Medium: HSL1950_0713 Medium parameters used: $f = 1908$ MHz; $\sigma = 1.443$ S/m; $\epsilon_r = 38.989$; $\rho = 1000$ kg/m³

Ambient Temperature : 23.7°C; Liquid Temperature : 22.5°C

DASY5 Configuration:

- Probe: EX3DV4 - SN7612; ConvF(8.83, 8.83, 8.83) @ 1907.6 MHz; Calibrated: 2024/03/20
- Sensor-Surface: 1.4mm (Mechanical Surface Detection)
- Electronics: DAE4 Sn1633; Calibrated: 2023/03/06
- Phantom: SAM Right ; Type: QD000P40CD; Serial: TP:1611
- Measurement SW: DASY52, Version 52.10 (4); SEMCAD X Version 14.6.14 (7501)

- **Area Scan (71x71x1):** Interpolated grid: dx=1.500 mm, dy=1.500 mm
Maximum value of SAR (interpolated) = 0.954 W/kg

- **Zoom Scan (5x5x7)/Cube 0:** Measurement grid: dx=8mm, dy=8mm, dz=5mm

Reference Value = 5.215 V/m; Power Drift = 0.04 dB

Peak SAR (extrapolated) = 1.40 W/kg

SAR(1 g) = 0.801 W/kg; SAR(10 g) = 0.431 W/kg

Smallest distance from peaks to all points 3 dB below = 11.3 mm

Ratio of SAR at M2 to SAR at M1 = 59.3%

Maximum value of SAR (measured) = 0.990 W/kg

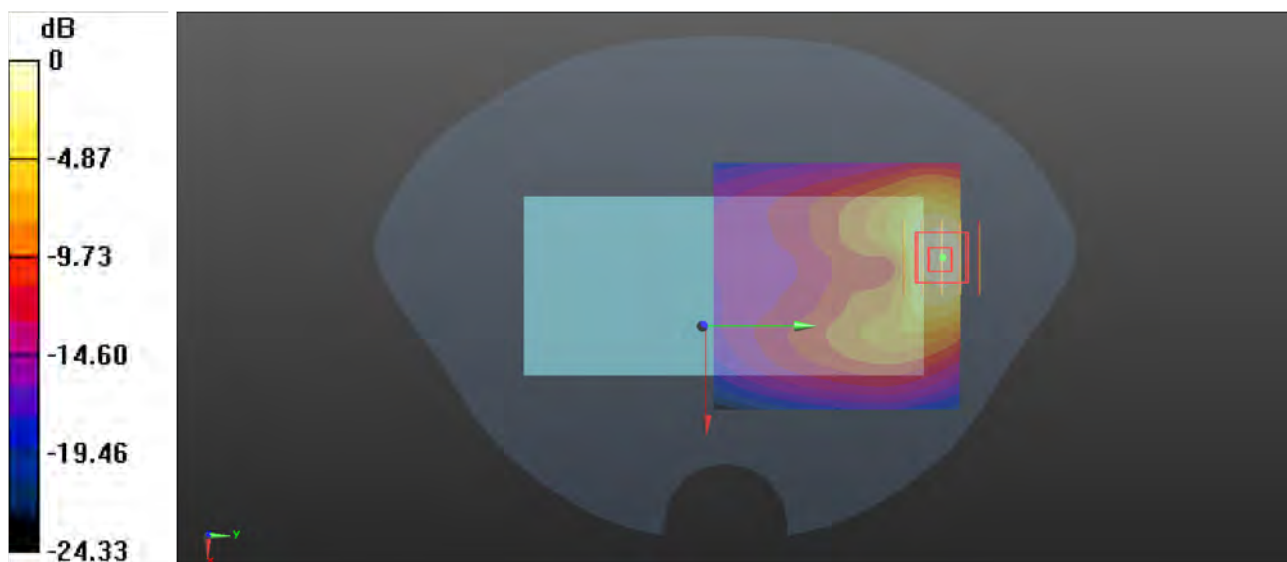

0 dB = 0.990 W/kg

P20 WCDMA IV_RMC12.2K_Front Face_1.1cm_Ch1413

Communication System: WCDMA; Frequency: 1732.6 MHz; Duty Cycle: 1:1

Medium: HSL1750_0713 Medium parameters used: $f = 1733$ MHz; $\sigma = 1.366$ S/m; $\epsilon_r = 40.897$; $\rho = 1000$ kg/m³

Ambient Temperature : 23.8°C; Liquid Temperature : 22.6°C

DASY5 Configuration:

- Probe: EX3DV4 - SN7612; ConvF(9.2, 9.2, 9.2) @ 1732.6 MHz; Calibrated: 2024/03/20
- Sensor-Surface: 1.4mm (Mechanical Surface Detection)
- Electronics: DAE4 Sn1633; Calibrated: 2024/03/06
- Phantom: SAM Right ; Type: QD000P40CD; Serial: TP:1611
- Measurement SW: DASY52, Version 52.10 (4); SEMCAD X Version 14.6.14 (7501)

-Area Scan (71x71x1): Interpolated grid: dx=1.500 mm, dy=1.500 mm

Maximum value of SAR (interpolated) = 0.887 W/kg

-Zoom Scan (5x5x7)/Cube 0: Measurement grid: dx=8mm, dy=8mm, dz=5mm

Reference Value = 5.873 V/m; Power Drift = -0.02 dB

Peak SAR (extrapolated) = 1.30 W/kg

SAR(1 g) = 0.761 W/kg; SAR(10 g) = 0.411 W/kg

Smallest distance from peaks to all points 3 dB below = 11.2 mm

Ratio of SAR at M2 to SAR at M1 = 61.2%

Maximum value of SAR (measured) = 0.923 W/kg

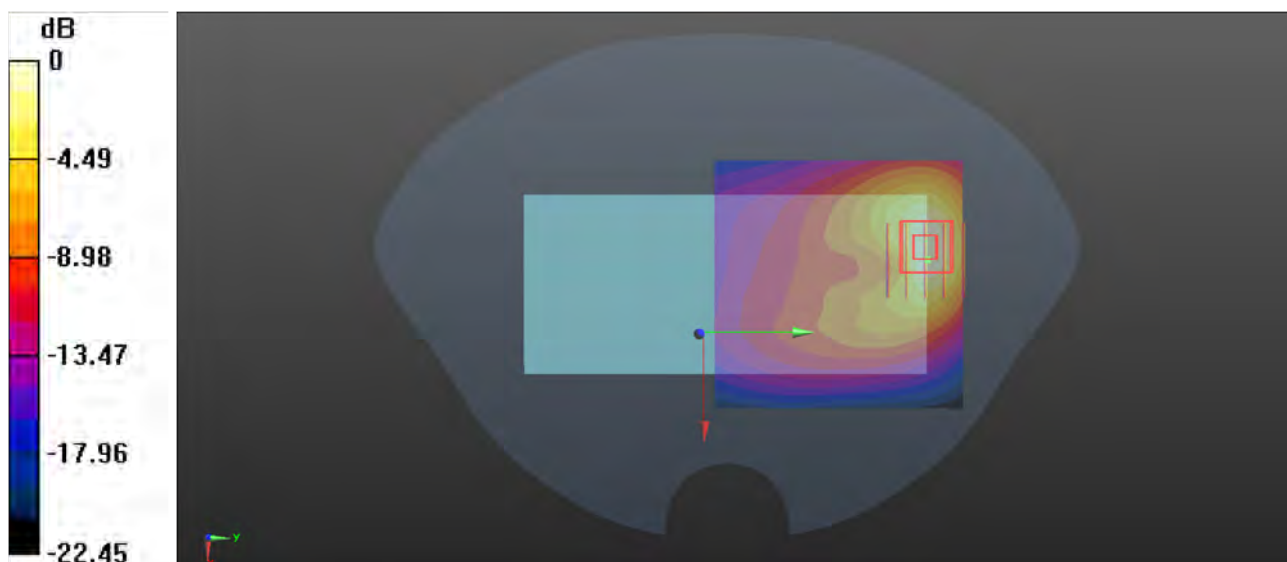

0 dB = 0.923 W/kg