



Test Report No.: W7L-P24050016RF03



# FCC TEST REPORT

## (Part 15, Subpart E)

Applicant:	Xiaomi Communications Co., Ltd.
Address:	#019, 9th Floor, Building 6, 33 Xi'erqi Middle Road, Haidian District, Beijing, China, 100085

Manufacturer or Supplier:	Xiaomi Communications Co., Ltd.
Address:	#019, 9th Floor, Building 6, 33 Xi'erqi Middle Road, Haidian District, Beijing, China, 100085
Product:	Mobile Phone
Brand Name:	POCO
Model Name:	2410FPCC5G
FCC ID:	2AFZZPCC5G
Date of tests:	May. 11, 2024 ~ Jul. 11, 2024

The tests have been carried out according to the requirements of the following standard:

**FCC Part 15, Subpart E, Section 15.407**

**CONCLUSION: The submitted sample was found to COMPLY with the test requirement**

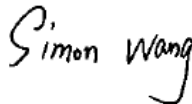
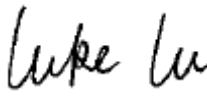
Prepared by Simon Wang Engineer / Mobile Department	Approved by Luke Lu Manager / Mobile Department
 Date: Jul. 11, 2024	 Date: Jul. 11, 2024

This report is governed by, and incorporates by reference, the Conditions of Testing as posted at the date of issuance of this report at <http://www.bureauveritas.com/home/about-us/our-business/cps/about-us/terms-conditions/> and is intended for your exclusive use. Any copying or replication of this report to or for any other person or entity, or use of our name or trademark, is permitted only with our prior written permission. This report sets forth our findings solely with respect to the test samples identified herein. The results set forth in this report are not indicative or representative of the quality or characteristics of the lot from which a test sample was taken or any similar or identical product unless specifically and expressly noted. Our report includes all of the tests requested by you and the results thereof based upon the information that you provided to us. Measurement uncertainty is only provided upon request for accredited tests. Statements of conformity are based on simple acceptance criteria without taking measurement uncertainty into account, unless otherwise requested in writing. You have 60 days from date of issuance of this report to notify us of any material error or omission caused by our negligence or if you require measurement uncertainty; provided, however, that such notice shall be in writing and shall specifically address the issue you wish to raise. A failure to raise such issue within the prescribed time shall constitute your unqualified acceptance of the completeness of this report, the tests conducted and the correctness of the report contents.



## TABLE OF CONTENTS

<b>RELEASE CONTROL RECORD .....</b>	<b>4</b>
1 SUMMARY OF TEST RESULTS .....	5
1.1 MEASUREMENT UNCERTAINTY .....	6
2 GENERAL INFORMATION.....	7
2.1 GENERAL DESCRIPTION OF EUT.....	7
2.2 DESCRIPTION OF TEST MODES.....	9
2.2.1 TEST MODE APPLICABILITY AND TESTED CHANNEL DETAIL.....	12
2.3 DUTY CYCLE OF TEST SIGNAL.....	17
2.4 DESCRIPTION OF SUPPORT UNITS.....	18
2.4.1 CONFIGURATION OF SYSTEM UNDER TEST.....	19
2.5 GENERAL DESCRIPTION OF APPLIED STANDARDS.....	20
<b>3 TEST TYPES AND RESULTS.....</b>	<b>21</b>
3.1 RADIATED EMISSION AND BANDEDGE MEASUREMENT .....	21
3.1.1 LIMITS OF RADIATED EMISSION AND BANDEDGE MEASUREMENT.....	21
3.1.2 LIMITS OF UNWANTED EMISSION.....	21
3.1.3 TEST INSTRUMENTS.....	22
3.1.4 TEST PROCEDURES .....	23
3.1.5 DEVIATION FROM TEST STANDARD .....	23
3.1.6 TEST SETUP .....	24
3.1.7 EUT OPERATING CONDITION .....	25
3.1.8 TEST RESULTS .....	26
3.2 CONDUCTED EMISSION MEASUREMENT.....	82
3.2.1 LIMITS OF CONDUCTED EMISSION MEASUREMENT .....	82
3.2.2 TEST INSTRUMENTS.....	82
3.2.3 TEST PROCEDURES .....	82
3.2.4 DEVIATION FROM TEST STANDARD .....	83
3.2.5 TEST SETUP .....	83
3.2.6 EUT OPERATING CONDITIONS .....	83
3.2.7 TEST RESULTS .....	84
3.3 MAXIMUM CONDUCTED OUTPUT POWER MEASUREMENT .....	86
3.3.1 LIMITS OF MAXIMUM CONDUCTED OUTPUT POWER MEASUREMENT .....	86
3.3.2 TEST SETUP .....	87
3.3.3 TEST INSTRUMENTS.....	87



3.3.4	TEST PROCEDURE .....	88
3.3.5	DEVIATION FROM TEST STANDARD .....	90
3.3.6	EUT OPERATING CONDITIONS .....	90
3.3.7	TEST RESULTS .....	91
3.4	MAXIMUM POWER SPECTRAL DENSITY MEASUREMENT .....	92
3.4.1	LIMITS OF MAXIMUM POWER SPECTRAL DENSITY MEASUREMENT .....	92
3.4.2	TEST SETUP .....	92
3.4.3	TEST INSTRUMENTS .....	92
3.4.4	TEST PROCEDURES .....	93
3.4.5	DEVIATION FROM TEST STANDARD .....	93
3.4.6	EUT OPERATING CONDITIONS .....	93
3.4.7	TEST RESULTS .....	94
3.5	AUTOMATICALLY DISCONTINUE TRANSMISSION .....	95
3.5.1	LIMIT OF AUTOMATICALLY DISCONTINUE TRANSMISSION .....	95
3.5.2	TEST INSTRUMENTS .....	95
3.5.3	TEST RESULT .....	95
3.6	ANTENNA REQUIREMENTS .....	96
3.6.1	STANDARD APPLICABLE .....	96
3.6.2	ANTENNA CONNECTED CONSTRUCTION .....	96
3.6.3	ANTENNA GAIN .....	96
<b>4</b>	<b>PHOTOGRAPHS OF THE TEST CONFIGURATION .....</b>	<b>96</b>
<b>5</b>	<b>MODIFICATIONS RECORDERS FOR ENGINEERING CHANGES TO THE EUT BY THE LAB97</b>	
<b>6</b>	<b>APPENDIX.....</b>	<b>98</b>



**BUREAU**  
**VERITAS**

Test Report No.: W7L-P24050016RF03

## RELEASE CONTROL RECORD

ISSUE NO.	REASON FOR CHANGE	DATE ISSUED
W7L-P24050016RF03	Original release	Jul. 11, 2024



# 1 SUMMARY OF TEST RESULTS

The EUT has been tested according to the following specifications:

APPLIED STANDARD: FCC PART 15, SUBPART E		
STANDARD SECTION	TEST TYPE AND LIMIT	RESULT
15.407(b)(9)	AC Power Conducted Emission	Compliance
15.407(b) (1/2/3/4/5)	Radiated Emission & Band Edge Measurement	Compliance
15.407(a/1/2/3)	Maximum conducted output Power	Compliance
15.407(a/1/2/3)	Peak Power Spectral Density	Compliance
15.407(a)(2)(12)	26 dB Bandwidth	Compliance
15.407(e)	6 dB Bandwidth	Compliance
15.203	Antenna Requirement	Compliance

**NOTE:**

1. Except the data of RSE and Band Edge Measurement, other data please refer to Appendix.
2. For 802.11n HT20/ ac VHT20 and 802.11n HT40 / ac VHT40 mode, the whole testing is assessed only 802.11n HT20/ HT40 by referring to their higher conducted power.



## 1.1 MEASUREMENT UNCERTAINTY

Where relevant, the following measurement uncertainty levels have been estimated for tests performed on the EUT as specified in CISPR 16-4-2:

MEASUREMENT	UNCERTAINTY
AC Power Conducted emissions	±2.70dB
Radiated emissions (9KHz~30MHz)	±2.68dB
Radiated emissions (30MHz~1GHz)	±4.98dB
Radiated emissions (1GHz ~6GHz)	±4.70dB
Radiated emissions (6GHz ~18GHz)	±4.60dB
Radiated emissions (18GHz ~40GHz)	±4.12dB
Conducted emissions	±4.01dB
Occupied Channel Bandwidth	±43.58KHz
Conducted Output power	±2.06dB
Power Spectral Density	±0.85 dB

This uncertainty represents an expanded uncertainty expressed at approximately the 95% confidence level using a coverage factor of  $k = 2$ .



## 2 GENERAL INFORMATION

### 2.1 GENERAL DESCRIPTION OF EUT

<b>PRODUCT</b>	Mobile Phone
<b>BRAND NAME</b>	POCO
<b>MODEL NAME</b>	2410FPCC5G
<b>NOMINAL VOLTAGE</b>	5/3.6~11Vdc(adapter or host equipment) 3.84Vdc (Li-ion, battery)
<b>MODULATION</b>	OFDM
<b>TRANSFER RATE</b>	802.11a: 54.0/ 48.0/ 36.0/ 24.0/ 18.0/ 12.0/ 9.0/ 6.0Mbps 802.11n: up to 150.0Mbps 802.11ac: up to 433.3Mbps
<b>OPERATING FREQUENCY</b>	5180 ~ 5240MHz, 5260 ~ 5320MHz, 5500 ~ 5700MHz, 5745 ~ 5825MHz
<b>NUMBER OF CHANNEL</b>	5180 ~ 5240MHz: 4 for 802.11a, 802.11n/ac/ax (20MHz) 2 for 802.11n/ac(40MHz) 1 for 802. 802.11ac (80MHz)/ 5260 ~ 5320MHz: 4 for 802.11a, 802.11n/ac/ax (20MHz) 2 for 802.11n/ac (40MHz) 1 for 802.11ac (80MHz) 5500 ~ 5700MHz: 11 for 802.11a, 802.11n/ac (20MHz)/ 5 for 802.11n/ac (40MHz) 2 for 802.11ac (80MHz) 5745 ~ 5825MHz: 5 for 802.11a, 802.11n/ac (20MHz) 2 for 802.11n/ac (40MHz) 1 for 802.11ac (80MHz)
<b>MAX. OUTPUT POWER</b>	22.59 mW for 5180 ~ 5240MHz 21.68 mW for 5260 ~ 5320MHz 22.34 mW for 5500 ~ 5700MHz 23.44 mW for 5745 ~ 5825MHz
<b>ANTENNA TYPE</b>	PIFA Antenna
<b>ANTENNA GAIN</b>	-0.9dBi for 5180 ~ 5240MHz -0.5dBi for 5260 ~ 5320MHz 0.2dBi for 5500 ~ 5700MHz -1dBi for 5745 ~ 5825MHz
<b>HW VERSION</b>	135100C3N
<b>SW VERSION</b>	Xiaomi HyperOS 1.0



<b>IMEI</b>	864624070035805
<b>I/O PORTS</b>	Refer to user's manual
<b>CABLE SUPPLIED</b>	USB cable1: non-shielded cable, with w/o ferrite core, 1.0 meter USB cable2: non-shielded cable, with w/o ferrite core, 1.0 meter USB cable3: non-shielded cable, with w/o ferrite core, 1.0 meter USB cable4: non-shielded cable, with w/o ferrite core, 1.0 meter USB cable5: non-shielded cable, with w/o ferrite core, 1.0 meter USB cable6: non-shielded cable, with w/o ferrite core, 1.0 meter USB cable7: non-shielded cable, with w/o ferrite core, 1.0 meter USB cable8: non-shielded cable, with w/o ferrite core, 1.0 meter

**NOTE:**

1. For a more detailed features description, please refer to the manufacturer's specifications or the user's manual.
2. The EUT incorporates a SISO function. Physically, the EUT provides one completed transmitter and one receiver.

<b>MODULATION MODE</b>	<b>TX FUNCTION</b>
<b>802.11a</b>	1TX /1RX
<b>802.11n/802.11ac (20MHz)</b>	1TX /1RX
<b>802.11n/802.11ac (40MHz)</b>	1TX /1RX
<b>802.11ac (80MHz)</b>	1TX /1RX

3. For the test results, the EUT had been tested with all conditions. But only the worst case was shown in the test report.
4. Antenna gain and EUT conducted cable loss are provided by the customer, and the laboratory will record the results based on these items that involve these two parameters.





## 2.2 DESCRIPTION OF TEST MODES

### FOR 5180 ~ 5240MHz

4 channels are provided for 802.11a, 802.11n, 802.11ac (20MHz)

CHANNEL	FREQUENCY	CHANNEL	FREQUENCY
36	5180 MHz	44	5220 MHz
40	5200 MHz	48	5240 MHz

2 channels are provided for 802.11n, 802.11ac (40MHz):

CHANNEL	FREQUENCY	CHANNEL	FREQUENCY
38	5190 MHz	46	5230 MHz

1 channel is provided for 802.11ac (80MHz):

CHANNEL	FREQUENCY	CHANNEL	FREQUENCY
42	5210 MHz		

### FOR 5260 ~ 5320MHz

4 channels are provided for 802.11a, 802.11n, 802.11ac (20MHz):

CHANNEL	FREQUENCY	CHANNEL	FREQUENCY
52	5260 MHz	60	5300 MHz
56	5280 MHz	64	5320 MHz

2 channels are provided for 802.11n, 802.11ac (40MHz):

CHANNEL	FREQUENCY	CHANNEL	FREQUENCY
54	5270 MHz	62	5310 MHz

1 channel is provided for 802.11ac (80MHz):

CHANNEL	FREQUENCY	CHANNEL	FREQUENCY
58	5290 MHz		



**FOR 5500 ~ 5700MHz**

11 channels are provided for 802.11a, 802.11n, 802.11ac (20MHz):

CHANNEL	FREQUENCY	CHANNEL	FREQUENCY
100	5500 MHz	124	5620MHz
104	5520 MHz	128	5640MHz
108	5540 MHz	132	5660 MHz
112	5560 MHz	136	5680 MHz
116	5580 MHz	140	5700 MHz
120	5600 MHz		

5 channels are provided for 802.11n, 802.11ac (40MHz):

CHANNEL	FREQUENCY	CHANNEL	FREQUENCY
102	5510 MHz	126	5630MHz
110	5550 MHz	134	5670 MHz
118	5590 MHz		

2 channel is provided for 802.11ac (80MHz):

CHANNEL	FREQUENCY	CHANNEL	FREQUENCY
106	5530 MHz	122	5610 MHz



**FOR 5745 ~ 5825MHz**

5 channels are provided for 802.11a, 802.11n, 802.11ac (20MHz):

CHANNEL	FREQUENCY	CHANNEL	FREQUENCY
149	5745 MHz	161	5805 MHz
153	5765 MHz	165	5825 MHz
157	5785 MHz		

2 channels are provided for 802.11n, 802.11ac (40MHz):

CHANNEL	FREQUENCY	CHANNEL	FREQUENCY
142	5710 MHz	159	5795 MHz
151	5755 MHz		

1 channel is provided for 802.11ac (80MHz):

CHANNEL	FREQUENCY
155	5775 MHz



### 2.2.1 TEST MODE APPLICABILITY AND TESTED CHANNEL DETAIL

EUT CONFIGURE MODE	APPLICABLE TO				DESCRIPTION
	RE≥1G	RE<1G	PLC	APCM	
A	√	√	√	-	Powered by Adapter with wifi(5G) link
B	-	-	-	√	Powered by Battery with wifi(5G) link
C	-	-	-	-	Powered by USB with wifi(5G) link

Where **RE≥1G**: Radiated Emission above 1GHz      **RE<1G**: Radiated Emission below 1GHz  
**PLC**: Power Line Conducted Emission      **APCM**: Antenna Port Conducted Measurement

**NOTE:**  
The EUT had been pre-tested on the positioned of each 3 axis. The worst case was found when positioned on **X-plane**.  
**NOTE:** “-” means no effect

#### RADIATED EMISSION TEST (BELOW 1GHz):

- Pre-Scan has been conducted to determine the worst-case mode from all possible combinations between available modulations, data rates and antenna ports (if EUT with antenna diversity architecture).
- The following channel(s) was (were) selected for the final test as listed below.

EUT CONFIGURE MODE	MODE	FREQ. BAND (MHz)	AVAILABLE CHANNEL	TESTED CHANNEL	MODULATION	DATA RATE (Mbps)
A	802.11ac (80MHz)	5260-5320	58	58	OFDM	MCS0



**RADIATED EMISSION TEST (ABOVE 1GHz):**

- Pre-Scan has been conducted to determine the worst-case mode from all possible combinations between available modulations, data rates and antenna ports (if EUT with antenna diversity architecture).
- The following channel(s) was (were) selected for the final test as listed below.

EUT CONFIGURE MODE	MODE	FREQ. BAND (MHz)	AVAILABLE CHANNEL	TESTED CHANNEL	MODULATION	DATA RATE (Mbps)
A	802.11a	5180-5240	36 to 48	36, 40, 48	OFDM	6.0
A	802.11n/ac (20MHz)		36 to 48	36, 40, 48	OFDM	MCS0
A	802.11n/ac (40MHz)		38 to 46	38, 46	OFDM	MCS0
A	802.11ac (80MHz)		42	42	OFDM	MCS0
A	802.11a	5260-5320	52 to 64	52, 60, 64	OFDM	6.0
A	802.11n/ac (20MHz)		52 to 64	52, 60, 64	OFDM	MCS0
A	802.11n/ac/ (40MHz)		54 to 62	54, 62	OFDM	MCS0
A	802.11ac (80MHz)		58	58	OFDM	MCS0
A	802.11a	5500-5700	100 to 140	100, 116, 140	OFDM	6.0
A	802.11n/ac (20MHz)		100 to 140	100, 116, 140	OFDM	MCS0
A	802.11n/ac (40MHz)		102 to 134	102, 110, 134	OFDM	MCS0
A	802.11ac (80MHz)		106 to 122	106, 122	OFDM	MCS0
A	802.11a	5745-5825	149 to 165	149, 157,165	OFDM	6.0
A	802.11n/ac (20MHz)		149 to 165	149, 157,165	OFDM	MCS0
A	802.11n/ac (40MHz)		151 to 159	151, 159	OFDM	MCS0
A	802.11ac (80MHz)		155	155	OFDM	MCS0



**POWER LINE CONDUCTED EMISSION TEST:**

- Pre-Scan has been conducted to determine the worst-case mode from all possible combinations between available modulations, data rates and antenna ports (if EUT with antenna diversity architecture).
- The following channel(s) was (were) selected for the final test as listed below.

EUT CONFIGURE MODE	MODE	FREQ. BAND (MHz)	AVAILABLE CHANNEL	TESTED CHANNEL	MODULATION	DATA RATE (Mbps)
A	802.11ac (80MHz)	5260-5320	58	58	OFDM	MCS0

**BANDEDGE MEASUREMENT:**

- Pre-Scan has been conducted to determine the worst-case mode from all possible combinations between available modulations, data rates and antenna ports (if EUT with antenna diversity architecture).
- The following channel(s) was (were) selected for the final test as listed below.

EUT CONFIGURE MODE	MODE	FREQ. BAND (MHz)	AVAILABLE CHANNEL	TESTED CHANNEL	MODULATION	DATA RATE (Mbps)
A	802.11a	5180-5240	36 to 48	36, 40, 48	OFDM	6.0
A	802.11n/ac (20MHz)		36 to 48	36, 40, 48	OFDM	MCS0
A	802.11n/ac (40MHz)		38 to 46	38, 46	OFDM	MCS0
A	802.11ac (80MHz)		42	42	OFDM	MCS0
A	802.11a	5260-5320	52 to 64	52, 60, 64	OFDM	6.0
A	802.11n/ac (20MHz)		52 to 64	52, 60, 64	OFDM	MCS0
A	802.11n/ac (40MHz)		54 to 62	54, 62	OFDM	MCS0
A	802.11ac (80MHz)		58	58	OFDM	MCS0
A	802.11a	5500-5700	100 to 140	100, 116, 140	OFDM	6.0
A	802.11n/ac (20MHz)		100 to 140	100, 116, 140	OFDM	MCS0
A	802.11n/ac (40MHz)		102 to 134	102, 110, 134	OFDM	MCS0
A	802.11ac (80MHz)		106 to 122	106, 122	OFDM	MCS0
A	802.11a	5745-5825	149 to 165	149, 157, 165	OFDM	6.0
A	802.11n/ac (20MHz)		149 to 165	149, 157, 165	OFDM	MCS0
A	802.11n/ac (40MHz)		151 to 159	151, 159	OFDM	MCS0
A	802.11ac (80MHz)		155	155	OFDM	MCS0



**ANTENNA PORT CONDUCTED MEASUREMENT:**

- This item includes all test values of each mode, but only includes spectrum plot of worst value of each mode.
- Pre-Scan has been conducted to determine the worst-case mode from all possible combinations between available modulations, data rates and antenna ports (if EUT with antenna diversity architecture).
- The following channel(s) was (were) selected for the final test as listed below.

EUT CONFIGURE MODE	MODE	FREQ. BAND (MHz)	AVAILABLE CHANNEL	TESTED CHANNEL	MODULATION	DATA RATE (Mbps)
A	802.11a	5180-5240	36 to 48	36, 40, 48	OFDM	6.0
A	802.11n/ac (20MHz)		36 to 48	36, 40, 48	OFDM	MCS0
A	802.11n/ac (40MHz)		38 to 46	38, 46	OFDM	MCS0
A	802.11ac (80MHz)		42	42	OFDM	MCS0
A	802.11a	5260-5320	52 to 64	52, 60, 64	OFDM	6.0
A	802.11n/ac (20MHz)		52 to 64	52, 60, 64	OFDM	MCS0
A	802.11n/ac (40MHz)		54 to 62	54, 62	OFDM	MCS0
A	802.11ac (80MHz)		58	58	OFDM	MCS0
A	802.11a	5500-5700	100 to 140	100, 116, 140	OFDM	6.0
A	802.11n/ac (20MHz)		100 to 140	100, 116, 140	OFDM	MCS0
A	802.11n/ac (40MHz)		102 to 134	102, 110, 134	OFDM	MCS0
A	802.11ac (80MHz)		106 to 122	106, 122	OFDM	MCS0
A	802.11a	5745-5825	149 to 165	149, 157,165	OFDM	6.0
A	802.11n/ac (20MHz)		149 to 165	149, 157,165	OFDM, OFDMA	MCS0
A	802.11n/ac (40MHz)		151 to 159	151, 159	OFDM	MCS0
A	802.11ac (80MHz)		155	155	OFDM	MCS0



Test Report No.: W7L-P24050016RF03

**TEST CONDITION:**

APPLICABLE TO	ENVIRONMENTAL CONDITIONS	INPUT POWER	TESTED BY
RE<1G	23deg. C, 70%RH	DC 5/3.6~11V By Adapter	Jace Hu
RE≥1G	23deg. C, 70%RH	DC 5/3.6~11V By Adapter	Jace Hu
PLC	25deg. C, 52%RH	DC 5/3.6~11V By Adapter	James Fu
APCM	25deg. C, 60%RH	DC 3.84V By DC Supply	James Fu





Test Report No.: W7L-P24050016RF03

## 2.3 DUTY CYCLE OF TEST SIGNAL

Please Refer to Appendix Of this test report.



## 2.4 DESCRIPTION OF SUPPORT UNITS

The EUT has been tested as an independent unit together with other necessary accessories or support units. The following support units or accessories were used to form a representative test configuration during the tests.

NO.	PRODUCT	BRAND	MODEL NO.	SERIAL NO.	FCC ID
1	Desktop	Lenovo	M73 SFF	PC04GRQV	N/A
2	Desktop	Lenovo	M73 SFF	PC06CS27	N/A
3	Laptop	Lenovo	ThinkpadL440	R90FTFKN	N/A
4	DC source	Kikusui/JP	PMX18-5A	0000001	N/A

NO.	SIGNAL CABLE DESCRIPTION OF THE ABOVE SUPPORT UNITS
1	AC Line: Unshielded, Detachable 1.5m
2	AC Line: Unshielded, Detachable 1.5m
3	AC Line: Unshielded, Detachable 1.5m
4	DC Line: Unshielded, Detachable 1.0m



### 2.4.1 CONFIGURATION OF SYSTEM UNDER TEST

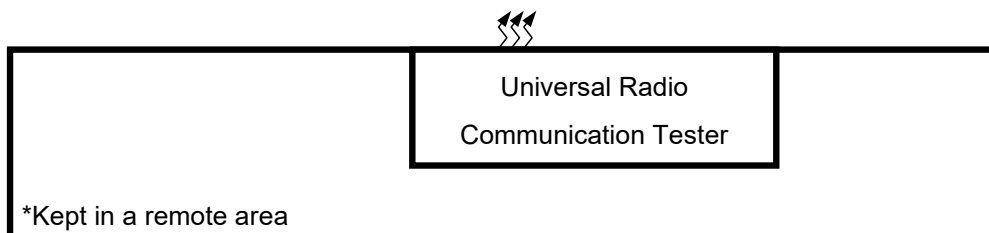
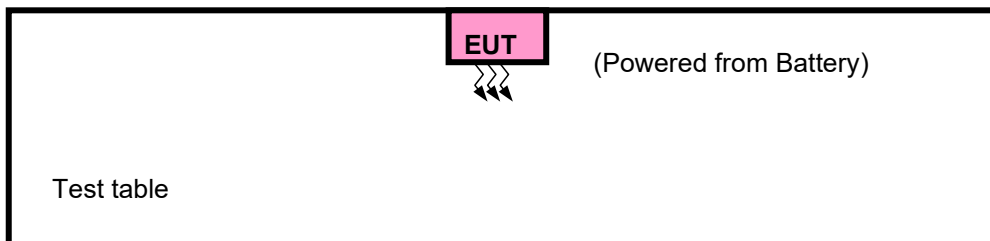
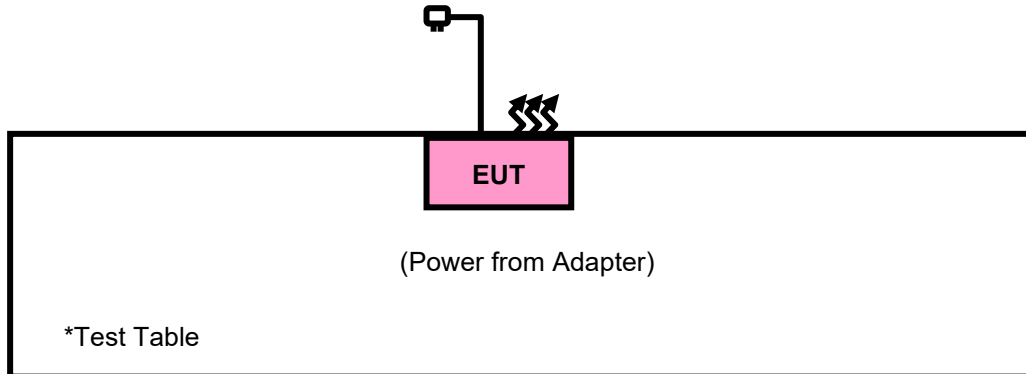



## 2.5 GENERAL DESCRIPTION OF APPLIED STANDARDS

The EUT is a RF Product. According to the specifications of the manufacturer, it must comply with the requirements of the following standards:

**FCC Part 15, Subpart E (15.407)**

**KDB 789033 D02 General U-NII Test Procedures New Rules v02r01**

**ANSI C63.10-2020**

All test items have been performed and recorded as per the above standards.

**NOTE:** The EUT is also considered as a kind of computer peripheral, because the connection to computer is necessary for typical use. It has been verified to comply with the requirements of FCC Part 15, Subpart B, Class B (Certification). The test report has been issued separately.



### 3 TEST TYPES AND RESULTS

#### 3.1 RADIATED EMISSION AND BANDEDGE MEASUREMENT

##### 3.1.1 LIMITS OF RADIATED EMISSION AND BANDEDGE MEASUREMENT

Radiated emissions which fall in the restricted bands must comply with the radiated emission limits specified as below table:

FREQUENCIES (MHz)	FIELD STRENGTH (microvolts/meter)	MEASUREMENT DISTANCE (meters)
0.009 ~ 0.490	2400/F(kHz)	300
0.490 ~ 1.705	24000/F(kHz)	30
1.705 ~ 30.0	30	30
30 ~ 88	100	3
88 ~ 216	150	3
216 ~ 960	200	3
Above 960	500	3

**NOTE:**

1. The lower limit shall apply at the transition frequencies.
2. Emission level (dBuV/m) = 20 log Emission level (uV/m).
3. For frequencies above 1000MHz, the field strength limits are based on average detector, however, the peak field strength of any emission shall not exceed the maximum permitted average limits, specified above by more than 20dB under any condition of modulation.

##### 3.1.2 LIMITS OF UNWANTED EMISSION

RESTRICTED BANDS	APPLICABLE TO	LIMIT	
	789033 D02 General UNII Test Procedures New Rules v02r01	FIELD STRENGTH AT 3m (dBµV/m)	
	PK : 74	AV : 54	
OUT OF THE RESTRICTED BANDS	APPLICABLE TO	EIRP LIMIT (dBm/MHz)	EQUIVALENT FIELD STRENGTH AT 3m (dBµV/m)
	15.407(b)(1)	PK : -27	PK : 68.2
	15.407(b)(2)		
	15.407(b)(3)		
15.407(b)(4)	See note 2 (FCC 16-24)		



**NOTE:** The following formula is used to convert the equipment isotropic radiated power (eirp) to field strength:

$$E = \frac{1000000 \sqrt{30P}}{3} \text{ } \mu\text{V/m, where P is the eirp (Watts).}$$

2. All emissions shall be limited to a level of -27 dBm/MHz at 75 MHz or more above or below the band edge increasing linearly to 10 dBm/MHz at 25 MHz above or below the band edge, and from 25 MHz above or below the band edge increasing linearly to a level of 15.6 dBm/MHz at 5 MHz above or below the band edge, and from 5 MHz above or below the band edge increasing linearly to a level of 27 dBm/MHz at the band edge.

### 3.1.3 TEST INSTRUMENTS

Equipment	Manufacturer	Model No.	Serial No.	Last Cal.	Next Cal.
3m Semi-anechoic Chamber	ETS-LINDGREN	9m*6m*6m	Euroshieldpn-CT0001143-1216	Nov. 14,23	Nov. 13,26
Bilog Antenna	ETS-LINDGREN	3143B	00161965	Feb. 18,24	Feb. 17,25
Horn Antenna	ETS-LINDGREN	3117	00168692	Feb. 18,24	Feb. 17,25
Horn Antenna (18GHz-40GHz)	N/A	QWH-SL-18-40-K-SG/QMS-00361	15433	Sep.04, 23	Sep.03, 24
Test Software	E3	V 9.160323	N/A	N/A	N/A
Test Software	JS1120-3	3.2.06	N/A	N/A	N/A
10dB Attenuator	JFW/USA	50HF-010-SMA	N/A	May. 06,24	May. 05,25
MXE EMI Receiver	KEYSIGHT	N9038A-544	MY54450026	Mar. 28,24	Mar. 27,25
Signal Pre-Amplifier	EMSI	EMC 9135	980249	May. 06,24	May. 05,25
Signal Pre-Amplifier	EMSI	EMC 012645B	980257	May.10,24	May.09,25
Signal Pre-Amplifier	EMSI	EMC 184045B	980259	Feb. 17,24	Feb. 16,25
DC Source	Kikusui/JP	PMX18-5A	0000001	Aug. 12,23	Aug. 11,24
Power Meter	Anritsu	ML2495A	1506002	Feb. 14,24	Feb. 13,25
Power Sensor	Anritsu	MA2411B	1339352	Feb. 14,24	Feb. 13,25
Loop Antenna	Schwarzbeck	FMZB 1519B	00173	Sep.03,23	Sep.02,24

- NOTE:**
1. The calibration interval of the above test instruments is 12 months or 36 months, and the calibrations are traceable to CEPREI/CHINA, GRGT/CHINA, and NIM/CHINA.
  2. The test was performed in the 3m Chamber.
  3. The FCC Site Registration No. is 525120; The Designation No. is CN1171.



### 3.1.4 TEST PROCEDURES

- a. The EUT was placed on the top of a rotating table 0.8 meters (for below 1GHz) / 1.5 meters (for above 1GHz) above the ground at 3-meter chamber room for test. The table was rotated 360 degrees to determine the position of the highest radiation.
- b. The EUT was set 3 meters away from the interference-receiving antenna, which was mounted on the top of a variable-height antenna tower.
- c. The antenna is a broadband antenna, and its height varies from one meter to four meters above the ground to determine the maximum value of the field strength. Both horizontal and vertical polarizations of the antenna are set to make the measurement.
- d. For each suspected emission, the EUT was arranged to its worst case and then the antenna was tuned to heights from 1 meter to 4 meters and the rotatable table was turned from 0 degrees to 360 degrees to find the maximum reading.
- e. The test-receiver system was set to Peak Detect Function and Specified Bandwidth with Maximum Hold Mode.
- f. If the emission level of the EUT in peak mode was 10dB lower than the limit specified, then testing could be stopped and the peak values of the EUT would be reported. Otherwise the emissions that did not have 10dB margin would be re-tested one by one using peak, quasi-peak or average method as specified and then reported in a data sheet.

#### **NOTE:**

1. The resolution bandwidth and video bandwidth of test receiver/spectrum analyzer is 120kHz for Peak detection (PK) and Quasi-peak detection (QP) at frequency below 1GHz.
2. The resolution bandwidth of test receiver/spectrum analyzer is 1MHz and video bandwidth is 3MHz for Peak detection at frequency above 1GHz.
3. The resolution bandwidth of test receiver/spectrum analyzer is 1MHz and the video bandwidth is 3MHz for RMS Average (Duty cycle < 98%) for Average detection (AV) at frequency above 1GHz, then the measurement results was added to a correction factor ( $10 \log(1/\text{duty cycle})$ ).
4. The resolution bandwidth of test receiver/spectrum analyzer is 1MHz and the video bandwidth is 10Hz (Duty cycle  $\geq 98\%$ ) for Average detection (AV) at frequency above 1GHz.
5. All modes of operation were investigated, and the worst-case emissions are reported.

### 3.1.5 DEVIATION FROM TEST STANDARD

No deviation.



### 3.1.6 TEST SETUP

#### <Frequency Range 9KHz~30MHz >

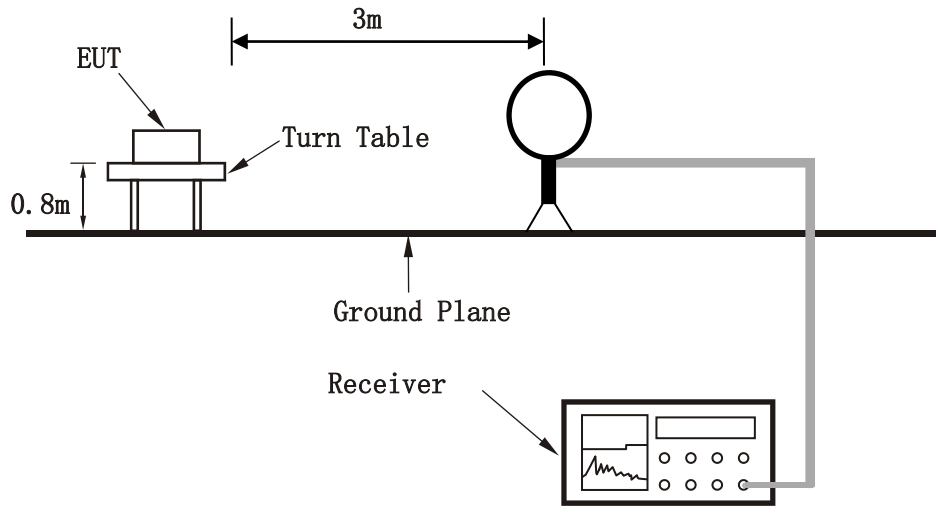

#### < Frequency Range 30MHz~1GHz >

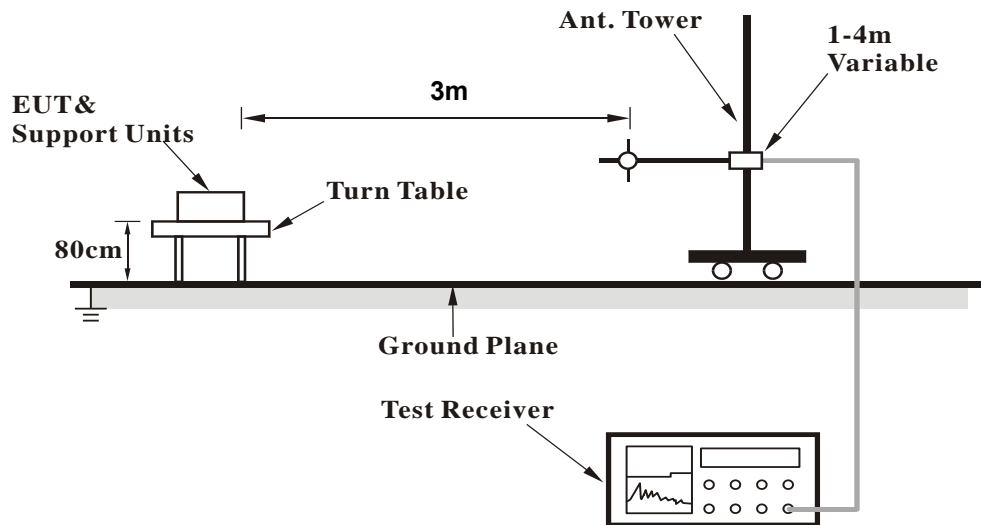



<Frequency Range above 1GHz>

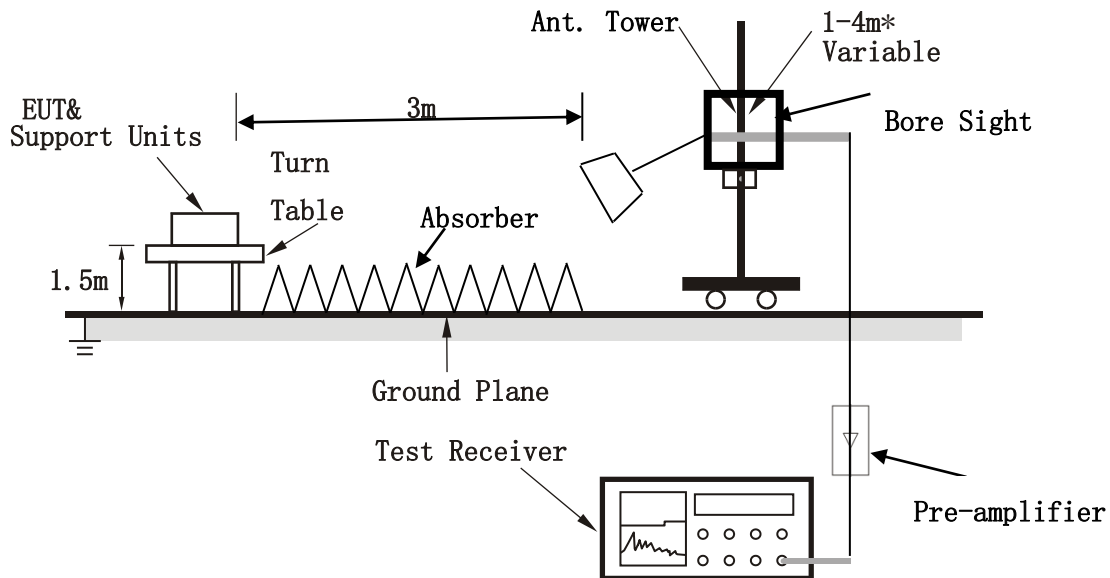

**Note:** Above 1G is a directional antenna

Depending on the EUT height and the antenna 3dB beamwidth both, refer to section 7.3 of CISPR 16-2-3.

For the actual test configuration, please refer to the attached file (Test Setup Photo).

### 3.1.7 EUT OPERATING CONDITION

- a. Set the EUT under full load condition and placed it on a testing table.
- b. Set the transmitter part of EUT under transmission condition continuously at specific channel frequency.
- c. The necessary accessories enable the EUT in full functions.



3.1.8 TEST RESULTS

NOTE : The 9K~30MHz amplitude of spurious emissions attenuated more than 20 dB below the permissible value is not required in the report.

30 MHz – 1GHz data:

Band 2

802.11ac (80MHz):

<b>CHANNEL</b>	TX Channel 58	<b>DETECTOR FUNCTION</b>	Quasi-Peak (QP)
<b>FREQUENCY RANGE</b>	30MHz ~ 1GHz		

ANTENNA POLARITY & TEST DISTANCE: HORIZONTAL AT 3 M										
FREQ. (MHz)	EMISSION LEVEL (dBuV/m)	READ LEVEL (dBuV)	LIMIT (dBuV/m)	MARGIN (dB)	ANTENNA FACTOR (dB /m)	CABLE LOSS (dB)	PREAMP FACTOR (dB)	ANTENNA HEIGHT (cm)	TABLE ANGLE (Degree)	REMARK
30.97	28.7	41.38	40	-11.3	24.61	0.14	37.43	100	360	Peak
90.14	25.6	49.16	43.5	-17.9	13	0.5	37.06	100	360	Peak
147.37	25.74	46.92	43.5	-17.76	14.77	0.78	36.73	100	360	Peak
207.51	26.46	45.4	43.5	-17.04	16.6	1.02	36.56	100	360	Peak
294.81	26.32	43.03	46	-19.68	18.59	1.3	36.6	100	360	Peak
809.88	30	35.61	46	-16	29.3	2.62	37.53	100	360	Peak

REMARKS:

1. Emission level (dBuV/m) = Read level (dBuV) + Correction Factor (dB/m).
2. Correction Factor (dB/m) = Antenna Factor (dB/m) + Cable Factor (dB).
3. The other emission levels were very low against the limit.
4. Margin value = Emission level – Limit value.

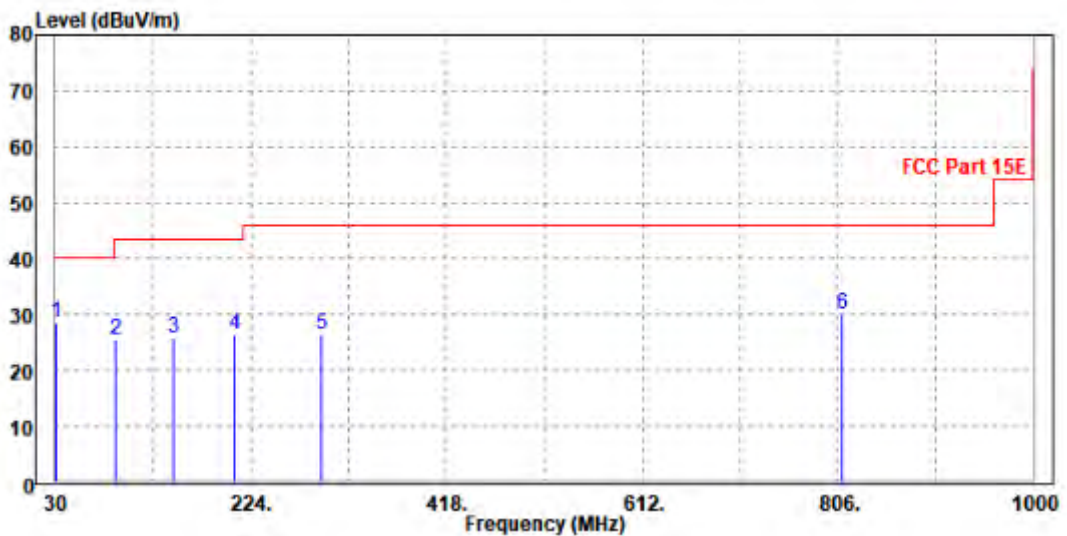



<b>CHANNEL</b>	Channel 58	<b>DETECTOR FUNCTION</b>	Quasi-Peak (QP)
<b>FREQUENCY RANGE</b>	30MHz ~ 1GHz		

<b>ANTENNA POLARITY &amp; TEST DISTANCE: VERTICAL AT 3 M</b>										
<b>FREQ. (MHz)</b>	<b>EMISSION LEVEL (dBuV/m)</b>	<b>READ LEVEL (dBuV)</b>	<b>LIMIT (dBuV/m)</b>	<b>MARGIN (dB)</b>	<b>ANTENNA FACTOR (dB /m)</b>	<b>CABLE LOSS (dB)</b>	<b>PREAMP FACTOR (dB)</b>	<b>ANTENNA HEIGHT (cm)</b>	<b>TABLE ANGLE (Degree)</b>	<b>REMARK</b>
30	31.1	43.41	40	-8.9	25	0.13	37.44	100	0	Peak
64.92	28.52	51.51	40	-11.48	14.02	0.34	37.35	100	0	Peak
90.14	31.88	55.44	43.5	-11.62	13	0.5	37.06	100	0	Peak
132.82	18.68	41.09	43.5	-24.82	13.68	0.69	36.78	100	0	Peak
361.74	21.31	34.65	46	-24.69	21.83	1.47	36.64	100	0	Peak
779.81	29.68	35.73	46	-16.32	28.9	2.56	37.51	100	0	Peak

**REMARKS:**

1. Emission level (dBuV/m) = Read level (dBuV) + Correction Factor (dB/m).
2. Correction Factor (dB/m) = Antenna Factor (dB/m) + Cable Factor (dB).
3. The other emission levels were very low against the limit.
4. Margin value = Emission level – Limit value.

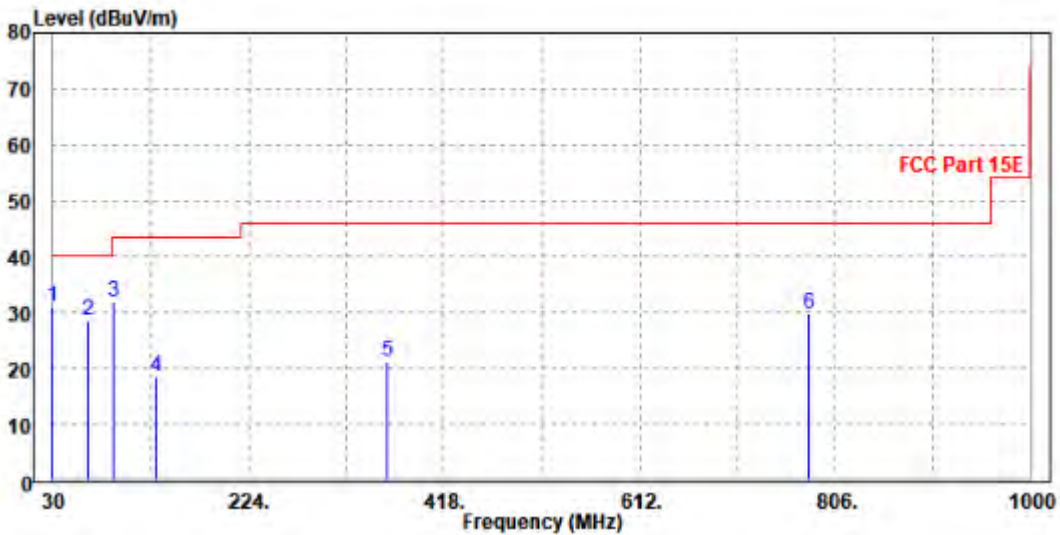



**ABOVE 1GHz WORST-CASE DATA:**

**Note:** For higher frequency, the emission is too low to be detected.

**Band 1**

**802.11a**

<b>CHANNEL</b>	TX Channel 36	<b>DETECTOR FUNCTION</b>	Peak (PK)
<b>FREQUENCY RANGE</b>	1GHz ~ 40GHz		Average (AV)

<b>ANTENNA POLARITY &amp; TEST DISTANCE: HORIZONTAL AT 3 M</b>										
FREQ. (MHz)	EMISSION LEVEL (dBuV/m)	READ LEVEL (dBuV)	LIMIT (dBuV/m)	MARGIN (dB)	ANTENNA FACTOR (dB /m)	CABLE LOSS (dB)	PREAMP FACTOR (dB)	ANTENNA HEIGHT (cm)	TABLE ANGLE (Degree)	REMARK
5150	52.46	53.68	74.00	-21.54	34.20	11.17	46.59	100	350	Peak
5150	46.34	47.56	54.00	-7.66	34.20	11.17	46.59	100	350	Average
5180	100.49	101.62	/	/	34.26	11.20	46.59	100	350	Peak
5180	92.36	93.49	/	/	34.26	11.20	46.59	100	350	Average
5350	52.22	53.07	74.00	-21.78	34.30	11.39	46.54	100	350	Peak
5350	45.90	46.75	54.00	-8.10	34.30	11.39	46.54	100	350	Average
<b>ANTENNA POLARITY &amp; TEST DISTANCE: VERTICAL AT 3 M</b>										
FREQ. (MHz)	EMISSION LEVEL (dBuV/m)	READ LEVEL (dBuV)	LIMIT (dBuV/m)	MARGIN (dB)	ANTENNA FACTOR (dB /m)	CABLE LOSS (dB)	PREAMP FACTOR (dB)	ANTENNA HEIGHT (cm)	TABLE ANGLE (Degree)	REMARK
5150	51.82	53.24	74.00	-22.18	34.00	11.17	46.59	100	265	Peak
5150	45.46	46.88	54.00	-8.54	34.00	11.17	46.59	100	265	Average
5180	92.06	93.51	/	/	33.94	11.20	46.59	100	265	Peak
5180	85.66	87.11	/	/	33.94	11.20	46.59	100	265	Average
5350	51.91	52.26	74.00	-22.09	34.80	11.39	46.54	100	265	Peak
5350	46.35	46.70	54.00	-7.65	34.80	11.39	46.54	100	265	Average

**REMARKS:**

1. Emission Level = Read Level+ Antenna Factor + Cable Loss- Preamp Factor  
Margin value = Emission level – Limit value.
2. 5180MHz: Fundamental frequency.



<b>CHANNEL</b>	TX Channel 40	<b>DETECTOR FUNCTION</b>	Peak (PK)
<b>FREQUENCY RANGE</b>	1GHz ~ 40GHz		Average (AV)

ANTENNA POLARITY & TEST DISTANCE: HORIZONTAL AT 3 M										
FREQ. (MHz)	EMISSION LEVEL (dBuV/m)	READ LEVEL (dBuV)	LIMIT (dBuV/m)	MARGIN (dB)	ANTENNA FACTOR (dB /m)	CABLE LOSS (dB)	PREAMP FACTOR (dB)	ANTENNA HEIGHT (cm)	TABLE ANGLE (Degree)	REMARK
5150	49.33	50.55	74.00	-24.67	34.20	11.17	46.59	100	350	Peak
5150	46.33	47.55	54.00	-7.67	34.20	11.17	46.59	100	350	Average
5200	100.19	101.25	/	/	34.30	11.22	46.58	100	350	Peak
5200	93.30	94.36	/	/	34.30	11.22	46.58	100	350	Average
5350	52.27	53.12	74.00	-21.73	34.30	11.39	46.54	100	350	Peak
5350	45.90	46.75	54.00	-8.10	34.30	11.39	46.54	100	350	Average
ANTENNA POLARITY & TEST DISTANCE: VERTICAL AT 3 M										
FREQ. (MHz)	EMISSION LEVEL (dBuV/m)	READ LEVEL (dBuV)	LIMIT (dBuV/m)	MARGIN (dB)	ANTENNA FACTOR (dB /m)	CABLE LOSS (dB)	PREAMP FACTOR (dB)	ANTENNA HEIGHT (cm)	TABLE ANGLE (Degree)	REMARK
5150	50.26	51.68	74.00	-23.74	34.00	11.17	46.59	100	260	Peak
5150	45.61	47.03	54.00	-8.39	34.00	11.17	46.59	100	260	Average
5200	93.15	94.61	/	/	33.90	11.22	46.58	100	260	Peak
5200	87.58	89.04	/	/	33.90	11.22	46.58	100	260	Average
5350	54.20	54.55	74.00	-19.80	34.80	11.39	46.54	100	260	Peak
5350	46.32	46.67	54.00	-7.68	34.80	11.39	46.54	100	260	Average

**REMARKS:**

1. Emission Level = Read Level+ Antenna Factor + Cable Loss- Preamp Factor  
Margin value = Emission level – Limit value.
2. 5200MHz: Fundamental frequency.



<b>CHANNEL</b>	TX Channel 48	<b>DETECTOR FUNCTION</b>	Peak (PK)
<b>FREQUENCY RANGE</b>	1GHz ~ 40GHz		Average (AV)

ANTENNA POLARITY & TEST DISTANCE: HORIZONTAL AT 3 M										
FREQ. (MHz)	EMISSION LEVEL (dBuV/m)	READ LEVEL (dBuV)	LIMIT (dBuV/m)	MARGIN (dB)	ANTENNA FACTOR (dB /m)	CABLE LOSS (dB)	PREAMP FACTOR (dB)	ANTENNA HEIGHT (cm)	TABLE ANGLE (Degree)	REMARK
5150	53.16	54.38	74.00	-20.84	34.20	11.17	46.59	100	350	Peak
5150	46.20	47.42	54.00	-7.80	34.20	11.17	46.59	100	350	Average
5240	100.74	101.58	/	/	34.46	11.27	46.57	100	350	Peak
5240	95.43	96.27	/	/	34.46	11.27	46.57	100	350	Average
5350	52.66	53.51	74.00	-21.34	34.30	11.39	46.54	100	350	Peak
5350	45.91	46.76	54.00	-8.09	34.30	11.39	46.54	100	350	Average
ANTENNA POLARITY & TEST DISTANCE: VERTICAL AT 3 M										
FREQ. (MHz)	EMISSION LEVEL (dBuV/m)	READ LEVEL (dBuV)	LIMIT (dBuV/m)	MARGIN (dB)	ANTENNA FACTOR (dB /m)	CABLE LOSS (dB)	PREAMP FACTOR (dB)	ANTENNA HEIGHT (cm)	TABLE ANGLE (Degree)	REMARK
5150	48.76	50.18	74.00	-25.24	34.00	11.17	46.59	100	255	Peak
5150	45.47	46.89	54.00	-8.53	34.00	11.17	46.59	100	255	Average
5240	94.67	95.99	/	/	33.98	11.27	46.57	100	255	Peak
5240	87.84	89.16	/	/	33.98	11.27	46.57	100	255	Average
5350	50.72	51.07	74.00	-23.28	34.80	11.39	46.54	100	255	Peak
5350	46.06	46.41	54.00	-7.94	34.80	11.39	46.54	100	255	Average

**REMARKS:**

1. Emission Level = Read Level+ Antenna Factor + Cable Loss- Preamp Factor  
Margin value = Emission level – Limit value.
2. 5240MHz: Fundamental frequency.



802.11n (20MHz)

<b>CHANNEL</b>	TX Channel 36	<b>DETECTOR FUNCTION</b>	Peak (PK)
<b>FREQUENCY RANGE</b>	1GHz ~ 40GHz		Average (AV)

ANTENNA POLARITY & TEST DISTANCE: HORIZONTAL AT 3 M										
FREQ. (MHz)	EMISSION LEVEL (dBuV/m)	READ LEVEL (dBuV)	LIMIT (dBuV/m)	MARGIN (dB)	ANTENNA FACTOR (dB /m)	CABLE LOSS (dB)	PREAMP FACTOR (dB)	ANTENNA HEIGHT (cm)	TABLE ANGLE (Degree)	REMARK
5150	50.10	51.32	74.00	-23.90	34.20	11.17	46.59	100	350	Peak
5150	46.38	47.60	54.00	-7.62	34.20	11.17	46.59	100	350	Average
5180	101.09	102.22	/	/	34.26	11.20	46.59	100	350	Peak
5180	92.57	93.70	/	/	34.26	11.20	46.59	100	350	Average
5350	52.51	53.36	74.00	-21.49	34.30	11.39	46.54	100	350	Peak
5350	45.96	46.81	54.00	-8.04	34.30	11.39	46.54	100	350	Average
ANTENNA POLARITY & TEST DISTANCE: VERTICAL AT 3 M										
FREQ. (MHz)	EMISSION LEVEL (dBuV/m)	READ LEVEL (dBuV)	LIMIT (dBuV/m)	MARGIN (dB)	ANTENNA FACTOR (dB /m)	CABLE LOSS (dB)	PREAMP FACTOR (dB)	ANTENNA HEIGHT (cm)	TABLE ANGLE (Degree)	REMARK
5150	50.66	52.08	74.00	-23.34	34.00	11.17	46.59	100	255	Peak
5150	45.46	46.88	54.00	-8.54	34.00	11.17	46.59	100	255	Average
5180	92.68	94.13	/	/	33.94	11.20	46.59	100	255	Peak
5180	86.15	87.60	/	/	33.94	11.20	46.59	100	255	Average
5350	51.58	51.93	74.00	-22.42	34.80	11.39	46.54	100	255	Peak
5350	46.27	46.62	54.00	-7.73	34.80	11.39	46.54	100	255	Average

REMARKS:

- Emission Level = Read Level+ Antenna Factor + Cable Loss- Preamp Factor  
Margin value = Emission level – Limit value.
- 5180MHz: Fundamental frequency.



<b>CHANNEL</b>	TX Channel 40	<b>DETECTOR FUNCTION</b>	Peak (PK)
<b>FREQUENCY RANGE</b>	1GHz ~ 40GHz		Average (AV)

**ANTENNA POLARITY & TEST DISTANCE: HORIZONTAL AT 3 M**

FREQ. (MHz)	EMISSION LEVEL (dBuV/m)	READ LEVEL (dBuV)	LIMIT (dBuV/m)	MARGIN (dB)	ANTENNA FACTOR (dB /m)	CABLE LOSS (dB)	PREAMP FACTOR (dB)	ANTENNA HEIGHT (cm)	TABLE ANGLE (Degree)	REMARK
5150	52.08	53.30	74.00	-21.92	34.20	11.17	46.59	100	350	Peak
5150	46.27	47.49	54.00	-7.73	34.20	11.17	46.59	100	350	Average
5200	101.56	102.62	/	/	34.30	11.22	46.58	100	350	Peak
5200	94.47	95.53	/	/	34.30	11.22	46.58	100	350	Average
5350	51.87	52.72	74.00	-22.13	34.30	11.39	46.54	100	350	Peak
5350	45.74	46.59	54.00	-8.26	34.30	11.39	46.54	100	350	Average

**ANTENNA POLARITY & TEST DISTANCE: VERTICAL AT 3 M**

FREQ. (MHz)	EMISSION LEVEL (dBuV/m)	READ LEVEL (dBuV)	LIMIT (dBuV/m)	MARGIN (dB)	ANTENNA FACTOR (dB /m)	CABLE LOSS (dB)	PREAMP FACTOR (dB)	ANTENNA HEIGHT (cm)	TABLE ANGLE (Degree)	REMARK
5150	53.17	54.59	74.00	-20.83	34.00	11.17	46.59	100	255	Peak
5150	45.60	47.02	54.00	-8.40	34.00	11.17	46.59	100	255	Average
5200	92.19	93.65	/	/	33.90	11.22	46.58	100	255	Peak
5200	86.41	87.87	/	/	33.90	11.22	46.58	100	255	Average
5350	51.50	51.85	74.00	-22.50	34.80	11.39	46.54	100	255	Peak
5350	46.27	46.62	54.00	-7.73	34.80	11.39	46.54	100	255	Average

**REMARKS:**

1. Emission Level = Read Level+ Antenna Factor + Cable Loss- Preamp Factor  
Margin value = Emission level – Limit value.
2. 5200MHz: Fundamental frequency.





<b>CHANNEL</b>	TX Channel 48	<b>DETECTOR FUNCTION</b>	Peak (PK)
<b>FREQUENCY RANGE</b>	1GHz ~ 40GHz		Average (AV)

ANTENNA POLARITY & TEST DISTANCE: HORIZONTAL AT 3 M										
FREQ. (MHz)	EMISSION LEVEL (dBuV/m)	READ LEVEL (dBuV)	LIMIT (dBuV/m)	MARGIN (dB)	ANTENNA FACTOR (dB /m)	CABLE LOSS (dB)	PREAMP FACTOR (dB)	ANTENNA HEIGHT (cm)	TABLE ANGLE (Degree)	REMARK
5150	49.87	51.09	74.00	-24.13	34.20	11.17	46.59	100	350	Peak
5150	45.81	47.03	54.00	-8.19	34.20	11.17	46.59	100	350	Average
5240	100.93	101.77	/	/	34.46	11.27	46.57	100	350	Peak
5240	94.55	95.39	/	/	34.46	11.27	46.57	100	350	Average
5350	52.68	53.53	74.00	-21.32	34.30	11.39	46.54	100	350	Peak
5350	45.93	46.78	54.00	-8.07	34.30	11.39	46.54	100	350	Average

ANTENNA POLARITY & TEST DISTANCE: VERTICAL AT 3 M										
FREQ. (MHz)	EMISSION LEVEL (dBuV/m)	READ LEVEL (dBuV)	LIMIT (dBuV/m)	MARGIN (dB)	ANTENNA FACTOR (dB /m)	CABLE LOSS (dB)	PREAMP FACTOR (dB)	ANTENNA HEIGHT (cm)	TABLE ANGLE (Degree)	REMARK
5150	51.58	53.00	74.00	-22.42	34.00	11.17	46.59	100	255	Peak
5150	45.66	47.08	54.00	-8.34	34.00	11.17	46.59	100	255	Average
5240	92.86	94.18	/	/	33.98	11.27	46.57	100	255	Peak
5240	85.90	87.22	/	/	33.98	11.27	46.57	100	255	Average
5350	52.15	52.50	74.00	-21.85	34.80	11.39	46.54	100	255	Peak
5350	46.26	46.61	54.00	-7.74	34.80	11.39	46.54	100	255	Average

**REMARKS:**

- Emission Level = Read Level+ Antenna Factor + Cable Loss- Preamp Factor  
Margin value = Emission level – Limit value.
- 5240MHz: Fundamental frequency.



802.11n (40MHz)

CHANNEL	TX Channel 38	DETECTOR FUNCTION	Peak (PK)
FREQUENCY RANGE	1GHz ~ 40GHz		Average (AV)

ANTENNA POLARITY & TEST DISTANCE: HORIZONTAL AT 3 M										
FREQ. (MHz)	EMISSION LEVEL (dBuV/m)	READ LEVEL (dBuV)	LIMIT (dBuV/m)	MARGIN (dB)	ANTENNA FACTOR (dB /m)	CABLE LOSS (dB)	PREAMP FACTOR (dB)	ANTENNA HEIGHT (cm)	TABLE ANGLE (Degree)	REMARK
5150	51.33	52.55	74.00	-22.67	34.20	11.17	46.59	100	350	Peak
5150	47.37	48.59	54.00	-6.63	34.20	11.17	46.59	100	350	Average
5190	97.92	99.01	/	/	34.28	11.21	46.58	100	350	Peak
5190	92.27	93.36	/	/	34.28	11.21	46.58	100	350	Average
5350	52.81	53.66	74.00	-21.19	34.30	11.39	46.54	100	350	Peak
5350	46.32	47.17	54.00	-7.68	34.30	11.39	46.54	100	350	Average

ANTENNA POLARITY & TEST DISTANCE: VERTICAL AT 3 M										
FREQ. (MHz)	EMISSION LEVEL (dBuV/m)	READ LEVEL (dBuV)	LIMIT (dBuV/m)	MARGIN (dB)	ANTENNA FACTOR (dB /m)	CABLE LOSS (dB)	PREAMP FACTOR (dB)	ANTENNA HEIGHT (cm)	TABLE ANGLE (Degree)	REMARK
5150	52.37	53.79	74.00	-21.63	34.00	11.17	46.59	100	255	Peak
5150	46.04	47.46	54.00	-7.96	34.00	11.17	46.59	100	255	Average
5190	90.37	91.82	/	/	33.92	11.21	46.58	100	255	Peak
5190	82.34	83.79	/	/	33.92	11.21	46.58	100	255	Average
5350	52.02	52.37	74.00	-21.98	34.80	11.39	46.54	100	255	Peak
5350	46.81	47.16	54.00	-7.19	34.80	11.39	46.54	100	255	Average

REMARKS:

- Emission Level = Read Level+ Antenna Factor + Cable Loss- Preamp Factor  
Margin value = Emission level – Limit value.
- 5190MHz: Fundamental frequency.



<b>CHANNEL</b>	TX Channel 46	<b>DETECTOR FUNCTION</b>	Peak (PK)
<b>FREQUENCY RANGE</b>	1GHz ~ 40GHz		Average (AV)

**ANTENNA POLARITY & TEST DISTANCE: HORIZONTAL AT 3 M**

FREQ. (MHz)	EMISSION LEVEL (dBuV/m)	READ LEVEL (dBuV)	LIMIT (dBuV/m)	MARGIN (dB)	ANTENNA FACTOR (dB /m)	CABLE LOSS (dB)	PREAMP FACTOR (dB)	ANTENNA HEIGHT (cm)	TABLE ANGLE (Degree)	REMARK
5150	52.20	53.42	74.00	-21.80	34.20	11.17	46.59	100	350	Peak
5150	46.51	47.73	54.00	-7.49	34.20	11.17	46.59	100	350	Average
5230	98.62	99.51	/	/	34.42	11.26	46.57	100	350	Peak
5230	92.15	93.04	/	/	34.42	11.26	46.57	100	350	Average
5350	49.93	50.78	74.00	-24.07	34.30	11.39	46.54	100	350	Peak
5350	46.54	47.39	54.00	-7.46	34.30	11.39	46.54	100	350	Average

**ANTENNA POLARITY & TEST DISTANCE: VERTICAL AT 3 M**

FREQ. (MHz)	EMISSION LEVEL (dBuV/m)	READ LEVEL (dBuV)	LIMIT (dBuV/m)	MARGIN (dB)	ANTENNA FACTOR (dB /m)	CABLE LOSS (dB)	PREAMP FACTOR (dB)	ANTENNA HEIGHT (cm)	TABLE ANGLE (Degree)	REMARK
5150	51.21	52.63	74.00	-22.79	34.00	11.17	46.59	100	255	Peak
5150	45.77	47.19	54.00	-8.23	34.00	11.17	46.59	100	255	Average
5230	90.59	91.94	/	/	33.96	11.26	46.57	100	255	Peak
5230	84.18	85.53	/	/	33.96	11.26	46.57	100	255	Average
5350	53.54	53.89	74.00	-20.46	34.80	11.39	46.54	100	255	Peak
5350	46.46	46.81	54.00	-7.54	34.80	11.39	46.54	100	255	Average

**REMARKS:**

- Emission Level = Read Level+ Antenna Factor + Cable Loss- Preamp Factor  
Margin value = Emission level – Limit value.
- 5230MHz: Fundamental frequency.



802.11ac (80MHz)

CHANNEL	TX Channel 42	DETECTOR FUNCTION	Peak (PK)
FREQUENCY RANGE	1GHz ~ 40GHz		Average (AV)

ANTENNA POLARITY & TEST DISTANCE: HORIZONTAL AT 3 M										
FREQ. (MHz)	EMISSION LEVEL (dBuV/m)	READ LEVEL (dBuV)	LIMIT (dBuV/m)	MARGIN (dB)	ANTENNA FACTOR (dB /m)	CABLE LOSS (dB)	PREAMP FACTOR (dB)	ANTENNA HEIGHT (cm)	TABLE ANGLE (Degree)	REMARK
5150	56.37	57.59	74.00	-17.63	34.20	11.17	46.59	100	350	Peak
5150	50.17	51.39	54.00	-3.83	34.20	11.17	46.59	100	350	Average
5210	94.74	95.74	/	/	34.34	11.24	46.58	100	350	Peak
5210	89.44	90.44	/	/	34.34	11.24	46.58	100	350	Average
5350	53.28	54.13	74.00	-20.72	34.30	11.39	46.54	100	350	Peak
5350	46.40	47.25	54.00	-7.60	34.30	11.39	46.54	100	350	Average

ANTENNA POLARITY & TEST DISTANCE: VERTICAL AT 3 M										
FREQ. (MHz)	EMISSION LEVEL (dBuV/m)	READ LEVEL (dBuV)	LIMIT (dBuV/m)	MARGIN (dB)	ANTENNA FACTOR (dB /m)	CABLE LOSS (dB)	PREAMP FACTOR (dB)	ANTENNA HEIGHT (cm)	TABLE ANGLE (Degree)	REMARK
5150	51.42	52.84	74.00	-22.58	34.00	11.17	46.59	100	255	Peak
5150	46.81	48.23	54.00	-7.19	34.00	11.17	46.59	100	255	Average
5210	85.86	87.28	/	/	33.92	11.24	46.58	100	255	Peak
5210	80.72	82.14	/	/	33.92	11.24	46.58	100	255	Average
5350	53.32	53.67	74.00	-20.68	34.80	11.39	46.54	100	255	Peak
5350	47.87	48.22	54.00	-6.13	34.80	11.39	46.54	100	255	Average

REMARKS:

- Emission Level = Read Level+ Antenna Factor + Cable Loss- Preamp Factor  
Margin value = Emission level – Limit value.
- 5210MHz: Fundamental frequency.



802.11ac (80MHz)

Worst case harmonic:

<b>CHANNEL</b>	TX Channel 42	<b>DETECTOR FUNCTION</b>	Peak (PK)
<b>FREQUENCY RANGE</b>	1GHz ~ 40GHz		Average (AV)

**ANTENNA POLARITY & TEST DISTANCE: HORIZONTAL AT 3 M**

	Freq	Level	Read Level	Limit	Over Limit	Factor	Remark	Pol/Phase
	MHz	dBuV/m	dBuV	dBuV/m	dB	dB/m		
1	10418.000	51.78	44.45	74.00	-22.22	7.33	Peak	Horizontal
2	10418.000	42.45	35.12	54.00	-11.55	7.33	Average	Horizontal
3	PK15630.000	60.90	40.99	74.00	-13.10	19.91	Peak	Horizontal
4	PP15630.000	50.79	30.88	54.00	-3.21	19.91	Average	Horizontal

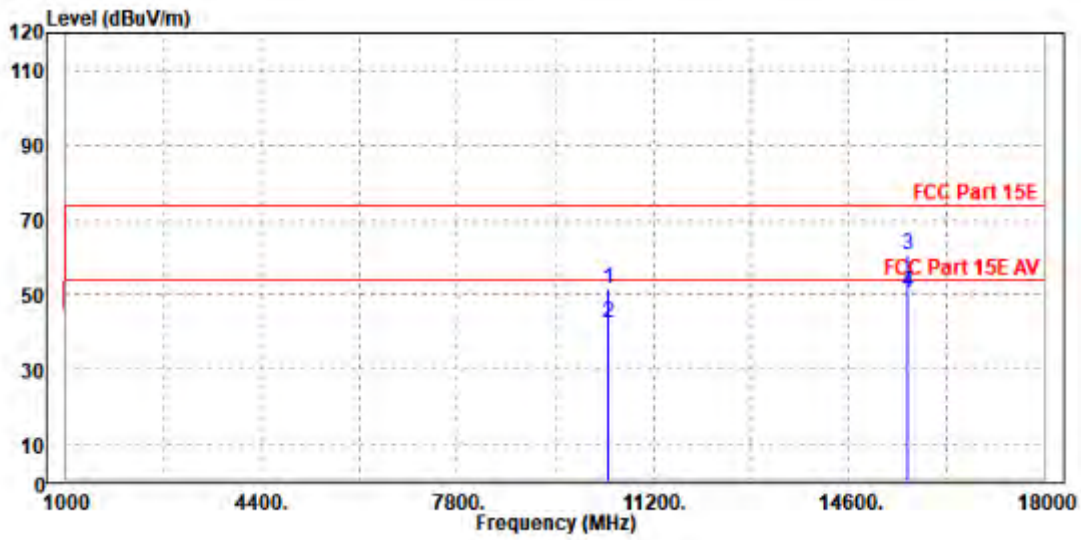



ANTENNA POLARITY & TEST DISTANCE: VERTICAL AT 3 M

	Freq	Level	Read Level	Limit Line	Over Limit	Factor	Remark	Pol/Phase
	MHz	dBuV/m	dBuV	dBuV/m	dB	dB/m		
1	10420.000	49.84	42.87	74.00	-24.16	6.97	Peak	Vertical
2	10420.000	40.64	33.67	54.00	-13.36	6.97	Average	Vertical
3	PK15637.000	57.89	38.33	74.00	-16.11	19.56	Peak	Vertical
4	PP15637.000	49.12	29.56	54.00	-4.88	19.56	Average	Vertical

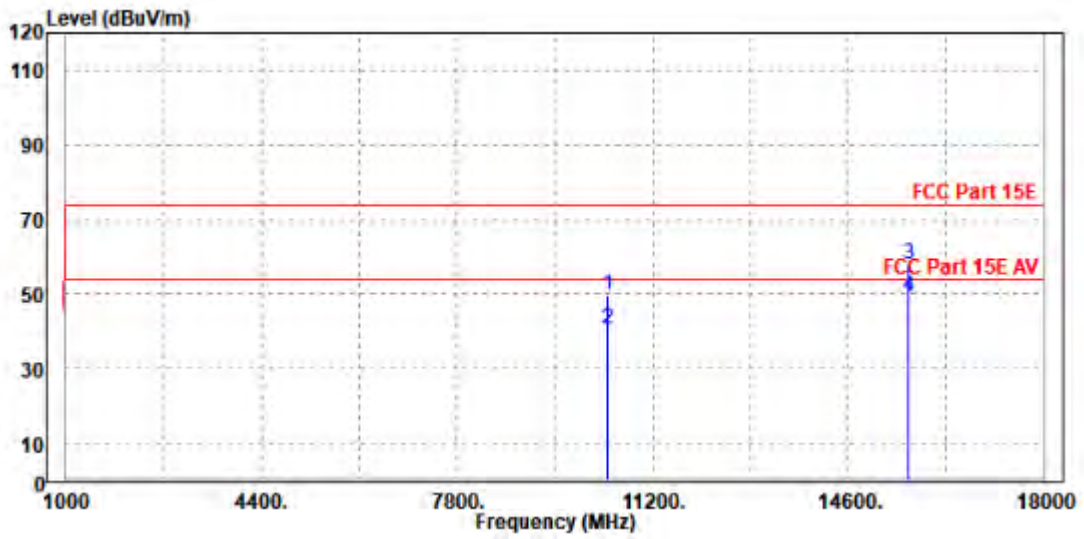

REMARKS:

1. Emission Level = Read Level+ Antenna Factor + Cable Loss- Preamp Factor  
Margin value = Emission level – Limit value.
2. 5210MHz: Fundamental frequency.
3. For frequency above 18GHz, the emission was tested 20db below the limit so the data not recorded in the sheet.



Band 2  
802.11a

CHANNEL	TX Channel 52	DETECTOR FUNCTION	Peak (PK)
FREQUENCY RANGE	1GHz ~ 40GHz		Average (AV)

ANTENNA POLARITY & TEST DISTANCE: HORIZONTAL AT 3 M

FREQ. (MHz)	EMISSION LEVEL (dBuV/m)	READ LEVEL (dBuV)	LIMIT (dBuV/m)	MARGIN (dB)	ANTENNA FACTOR (dB /m)	CABLE LOSS (dB)	PREAMP FACTOR (dB)	ANTENNA HEIGHT (cm)	TABLE ANGLE (Degree)	REMARK
5150	54.01	55.23	74.00	-19.99	34.20	11.17	46.59	100	355	Peak
5150	45.22	46.44	54.00	-8.78	34.20	11.17	46.59	100	355	Average
5260	103.72	104.54	/	/	34.46	11.29	46.57	100	355	Peak
5260	94.58	95.40	/	/	34.46	11.29	46.57	100	355	Average
5350	53.89	54.74	74.00	-20.11	34.30	11.39	46.54	100	355	Peak
5350	45.46	46.31	54.00	-8.54	34.30	11.39	46.54	100	355	Average

ANTENNA POLARITY & TEST DISTANCE: VERTICAL AT 3 M

FREQ. (MHz)	EMISSION LEVEL (dBuV/m)	READ LEVEL (dBuV)	LIMIT (dBuV/m)	MARGIN (dB)	ANTENNA FACTOR (dB /m)	CABLE LOSS (dB)	PREAMP FACTOR (dB)	ANTENNA HEIGHT (cm)	TABLE ANGLE (Degree)	REMARK
5150	50.97	52.39	74.00	-23.03	34.00	11.17	46.59	100	245	Peak
5150	44.84	46.26	54.00	-9.16	34.00	11.17	46.59	100	245	Average
5260	97.66	98.82	/	/	34.12	11.29	46.57	100	245	Peak
5260	89.38	90.54	/	/	34.12	11.29	46.57	100	245	Average
5350	54.26	54.61	74.00	-19.74	34.80	11.39	46.54	100	245	Peak
5350	45.96	46.31	54.00	-8.04	34.80	11.39	46.54	100	245	Average

REMARKS:

- Emission Level = Read Level+ Antenna Factor + Cable Loss- Preamp Factor  
Margin value = Emission level – Limit value.
- 5260MHz: Fundamental frequency.





<b>CHANNEL</b>	TX Channel 60	<b>DETECTOR FUNCTION</b>	Peak (PK)
<b>FREQUENCY RANGE</b>	1GHz ~ 40GHz		Average (AV)

**ANTENNA POLARITY & TEST DISTANCE: HORIZONTAL AT 3 M**

FREQ. (MHz)	EMISSION LEVEL (dBuV/m)	READ LEVEL (dBuV)	LIMIT (dBuV/m)	MARGIN (dB)	ANTENNA FACTOR (dB /m)	CABLE LOSS (dB)	PREAMP FACTOR (dB)	ANTENNA HEIGHT (cm)	TABLE ANGLE (Degree)	REMARK
5150	52.96	54.18	74.00	-21.04	34.20	11.17	46.59	100	355	Peak
5150	45.06	46.28	54.00	-8.94	34.20	11.17	46.59	100	355	Average
5300	103.44	104.36	/	/	34.30	11.34	46.56	100	355	Peak
5300	94.95	95.87	/	/	34.30	11.34	46.56	100	355	Average
5350	52.76	53.61	74.00	-21.24	34.30	11.39	46.54	100	355	Peak
5350	45.33	46.18	54.00	-8.67	34.30	11.39	46.54	100	355	Average

**ANTENNA POLARITY & TEST DISTANCE: VERTICAL AT 3 M**

FREQ. (MHz)	EMISSION LEVEL (dBuV/m)	READ LEVEL (dBuV)	LIMIT (dBuV/m)	MARGIN (dB)	ANTENNA FACTOR (dB /m)	CABLE LOSS (dB)	PREAMP FACTOR (dB)	ANTENNA HEIGHT (cm)	TABLE ANGLE (Degree)	REMARK
5150	53.74	55.16	74.00	-20.26	34.00	11.17	46.59	100	245	Peak
5150	44.77	46.19	54.00	-9.23	34.00	11.17	46.59	100	245	Average
5300	97.70	98.32	/	/	34.60	11.34	46.56	100	245	Peak
5300	89.66	90.28	/	/	34.60	11.34	46.56	100	245	Average
5350	52.29	52.64	74.00	-21.71	34.80	11.39	46.54	100	245	Peak
5350	45.86	46.21	54.00	-8.14	34.80	11.39	46.54	100	245	Average

**REMARKS:**

- Emission Level = Read Level+ Antenna Factor + Cable Loss- Preamp Factor  
Margin value = Emission level – Limit value.
- 5300MHz: Fundamental frequency.





<b>CHANNEL</b>	TX Channel 64	<b>DETECTOR FUNCTION</b>	Peak (PK)
<b>FREQUENCY RANGE</b>	1GHz ~ 40GHz		Average (AV)

**ANTENNA POLARITY & TEST DISTANCE: HORIZONTAL AT 3 M**

FREQ. (MHz)	EMISSION LEVEL (dBuV/m)	READ LEVEL (dBuV)	LIMIT (dBuV/m)	MARGIN (dB)	ANTENNA FACTOR (dB /m)	CABLE LOSS (dB)	PREAMP FACTOR (dB)	ANTENNA HEIGHT (cm)	TABLE ANGLE (Degree)	REMARK
5150	52.19	53.41	74.00	-21.81	34.20	11.17	46.59	100	355	Peak
5150	44.97	46.19	54.00	-9.03	34.20	11.17	46.59	100	355	Average
5320	103.45	104.34	/	/	34.30	11.36	46.55	100	355	Peak
5320	95.52	96.41	/	/	34.30	11.36	46.55	100	355	Average
5350	52.64	53.49	74.00	-21.36	34.30	11.39	46.54	100	355	Peak
5350	46.18	47.03	54.00	-7.82	34.30	11.39	46.54	100	355	Average

**ANTENNA POLARITY & TEST DISTANCE: VERTICAL AT 3 M**

FREQ. (MHz)	EMISSION LEVEL (dBuV/m)	READ LEVEL (dBuV)	LIMIT (dBuV/m)	MARGIN (dB)	ANTENNA FACTOR (dB /m)	CABLE LOSS (dB)	PREAMP FACTOR (dB)	ANTENNA HEIGHT (cm)	TABLE ANGLE (Degree)	REMARK
5150	52.01	53.43	74.00	-21.99	34.00	11.17	46.59	100	245	Peak
5150	44.70	46.12	54.00	-9.30	34.00	11.17	46.59	100	245	Average
5320	96.66	97.17	/	/	34.68	11.36	46.55	100	245	Peak
5320	89.66	90.17	/	/	34.68	11.36	46.55	100	245	Average
5350	52.78	53.13	74.00	-21.22	34.80	11.39	46.54	100	245	Peak
5350	45.93	46.28	54.00	-8.07	34.80	11.39	46.54	100	245	Average

**REMARKS:**

- Emission Level = Read Level+ Antenna Factor + Cable Loss- Preamp Factor  
Margin value = Emission level – Limit value.
- 5320MHz: Fundamental frequency.



802.11n (20MHz)

<b>CHANNEL</b>	TX Channel 52	<b>DETECTOR FUNCTION</b>	Peak (PK)
<b>FREQUENCY RANGE</b>	1GHz ~ 40GHz		Average (AV)

ANTENNA POLARITY & TEST DISTANCE: HORIZONTAL AT 3 M										
FREQ. (MHz)	EMISSION LEVEL (dBuV/m)	READ LEVEL (dBuV)	LIMIT (dBuV/m)	MARGIN (dB)	ANTENNA FACTOR (dB /m)	CABLE LOSS (dB)	PREAMP FACTOR (dB)	ANTENNA HEIGHT (cm)	TABLE ANGLE (Degree)	REMARK
5150	52.90	54.12	74.00	-21.10	34.20	11.17	46.59	100	355	Peak
5150	45.13	46.35	54.00	-8.87	34.20	11.17	46.59	100	355	Average
5260	101.92	102.74	/	/	34.46	11.29	46.57	100	355	Peak
5260	94.42	95.24	/	/	34.46	11.29	46.57	100	355	Average
5350	53.74	54.59	74.00	-20.26	34.30	11.39	46.54	100	355	Peak
5350	45.41	46.26	54.00	-8.59	34.30	11.39	46.54	100	355	Average

ANTENNA POLARITY & TEST DISTANCE: VERTICAL AT 3 M										
FREQ. (MHz)	EMISSION LEVEL (dBuV/m)	READ LEVEL (dBuV)	LIMIT (dBuV/m)	MARGIN (dB)	ANTENNA FACTOR (dB /m)	CABLE LOSS (dB)	PREAMP FACTOR (dB)	ANTENNA HEIGHT (cm)	TABLE ANGLE (Degree)	REMARK
5150	53.61	55.03	74.00	-20.39	34.00	11.17	46.59	100	245	Peak
5150	45.19	46.61	54.00	-8.81	34.00	11.17	46.59	100	245	Average
5260	96.95	98.11	/	/	34.12	11.29	46.57	100	245	Peak
5260	89.52	90.68	/	/	34.12	11.29	46.57	100	245	Average
5350	52.38	52.73	74.00	-21.62	34.80	11.39	46.54	100	245	Peak
5350	46.08	46.43	54.00	-7.92	34.80	11.39	46.54	100	245	Average

REMARKS:

- Emission Level = Read Level+ Antenna Factor + Cable Loss- Preamp Factor  
Margin value = Emission level – Limit value.
- 5260MHz: Fundamental frequency.



<b>CHANNEL</b>	TX Channel 60	<b>DETECTOR FUNCTION</b>	Peak (PK)
<b>FREQUENCY RANGE</b>	1GHz ~ 40GHz		Average (AV)

ANTENNA POLARITY & TEST DISTANCE: HORIZONTAL AT 3 M										
FREQ. (MHz)	EMISSION LEVEL (dBuV/m)	READ LEVEL (dBuV)	LIMIT (dBuV/m)	MARGIN (dB)	ANTENNA FACTOR (dB /m)	CABLE LOSS (dB)	PREAMP FACTOR (dB)	ANTENNA HEIGHT (cm)	TABLE ANGLE (Degree)	REMARK
5150	51.37	52.59	74.00	-22.63	34.20	11.17	46.59	100	355	Peak
5150	45.50	46.72	54.00	-8.50	34.20	11.17	46.59	100	355	Average
5300	102.20	103.12	/	/	34.30	11.34	46.56	100	355	Peak
5300	94.56	95.48	/	/	34.30	11.34	46.56	100	355	Average
5350	52.76	53.61	74.00	-21.24	34.30	11.39	46.54	100	355	Peak
5350	45.49	46.34	54.00	-8.51	34.30	11.39	46.54	100	355	Average

ANTENNA POLARITY & TEST DISTANCE: VERTICAL AT 3 M										
FREQ. (MHz)	EMISSION LEVEL (dBuV/m)	READ LEVEL (dBuV)	LIMIT (dBuV/m)	MARGIN (dB)	ANTENNA FACTOR (dB /m)	CABLE LOSS (dB)	PREAMP FACTOR (dB)	ANTENNA HEIGHT (cm)	TABLE ANGLE (Degree)	REMARK
5150	52.42	53.84	74.00	-21.58	34.00	11.17	46.59	100	245	Peak
5150	45.09	46.51	54.00	-8.91	34.00	11.17	46.59	100	245	Average
5300	97.21	97.83	/	/	34.60	11.34	46.56	100	245	Peak
5300	89.56	90.18	/	/	34.60	11.34	46.56	100	245	Average
5350	53.59	53.94	74.00	-20.41	34.80	11.39	46.54	100	245	Peak
5350	45.94	46.29	54.00	-8.06	34.80	11.39	46.54	100	245	Average

**REMARKS:**

- Emission Level = Read Level+ Antenna Factor + Cable Loss- Preamp Factor  
Margin value = Emission level – Limit value.
- 5300MHz: Fundamental frequency.



<b>CHANNEL</b>	TX Channel 64	<b>DETECTOR FUNCTION</b>	Peak (PK)
<b>FREQUENCY RANGE</b>	1GHz ~ 40GHz		Average (AV)

**ANTENNA POLARITY & TEST DISTANCE: HORIZONTAL AT 3 M**

FREQ. (MHz)	EMISSION LEVEL (dBuV/m)	READ LEVEL (dBuV)	LIMIT (dBuV/m)	MARGIN (dB)	ANTENNA FACTOR (dB /m)	CABLE LOSS (dB)	PREAMP FACTOR (dB)	ANTENNA HEIGHT (cm)	TABLE ANGLE (Degree)	REMARK
5150	52.39	53.61	74.00	-21.61	34.20	11.17	46.59	100	355	Peak
5150	45.05	46.27	54.00	-8.95	34.20	11.17	46.59	100	355	Average
5320	101.84	102.73	/	/	34.30	11.36	46.55	100	355	Peak
5320	94.74	95.63	/	/	34.30	11.36	46.55	100	355	Average
5350	53.02	53.87	74.00	-20.98	34.30	11.39	46.54	100	355	Peak
5350	45.58	46.43	54.00	-8.42	34.30	11.39	46.54	100	355	Average

**ANTENNA POLARITY & TEST DISTANCE: VERTICAL AT 3 M**

FREQ. (MHz)	EMISSION LEVEL (dBuV/m)	READ LEVEL (dBuV)	LIMIT (dBuV/m)	MARGIN (dB)	ANTENNA FACTOR (dB /m)	CABLE LOSS (dB)	PREAMP FACTOR (dB)	ANTENNA HEIGHT (cm)	TABLE ANGLE (Degree)	REMARK
5150	52.84	54.26	74.00	-21.16	34.00	11.17	46.59	100	245	Peak
5150	44.95	46.37	54.00	-9.05	34.00	11.17	46.59	100	245	Average
5320	97.21	97.72	/	/	34.68	11.36	46.55	100	245	Peak
5320	89.84	90.35	/	/	34.68	11.36	46.55	100	245	Average
5350	53.49	53.84	74.00	-20.51	34.80	11.39	46.54	100	245	Peak
5350	46.07	46.42	54.00	-7.93	34.80	11.39	46.54	100	245	Average

**REMARKS:**

- Emission Level = Read Level+ Antenna Factor + Cable Loss- Preamp Factor  
Margin value = Emission level – Limit value.
- 5320MHz: Fundamental frequency.



802.11n (40MHz)

CHANNEL	TX Channel 54	DETECTOR FUNCTION	Peak (PK)
FREQUENCY RANGE	1GHz ~ 40GHz		Average (AV)

ANTENNA POLARITY & TEST DISTANCE: HORIZONTAL AT 3 M										
FREQ. (MHz)	EMISSION LEVEL (dBuV/m)	READ LEVEL (dBuV)	LIMIT (dBuV/m)	MARGIN (dB)	ANTENNA FACTOR (dB /m)	CABLE LOSS (dB)	PREAMP FACTOR (dB)	ANTENNA HEIGHT (cm)	TABLE ANGLE (Degree)	REMARK
5150	51.11	52.33	74.00	-22.89	34.20	11.17	46.59	100	355	Peak
5150	45.15	46.37	54.00	-8.85	34.20	11.17	46.59	100	355	Average
5270	98.08	98.92	/	/	34.42	11.30	46.56	100	355	Peak
5270	92.33	93.17	/	/	34.42	11.30	46.56	100	355	Average
5350	51.96	52.81	74.00	-22.04	34.30	11.39	46.54	100	355	Peak
5350	46.84	47.69	54.00	-7.16	34.30	11.39	46.54	100	355	Average

ANTENNA POLARITY & TEST DISTANCE: VERTICAL AT 3 M										
FREQ. (MHz)	EMISSION LEVEL (dBuV/m)	READ LEVEL (dBuV)	LIMIT (dBuV/m)	MARGIN (dB)	ANTENNA FACTOR (dB /m)	CABLE LOSS (dB)	PREAMP FACTOR (dB)	ANTENNA HEIGHT (cm)	TABLE ANGLE (Degree)	REMARK
5150	50.72	52.14	74.00	-23.28	34.00	11.17	46.59	100	245	Peak
5150	44.54	45.96	54.00	-9.46	34.00	11.17	46.59	100	245	Average
5270	92.81	93.83	/	/	34.24	11.30	46.56	100	245	Peak
5270	86.89	87.91	/	/	34.24	11.30	46.56	100	245	Average
5350	52.78	53.13	74.00	-21.22	34.80	11.39	46.54	100	245	Peak
5350	46.06	46.41	54.00	-7.94	34.80	11.39	46.54	100	245	Average

REMARKS:

- Emission Level = Read Level+ Antenna Factor + Cable Loss- Preamp Factor  
Margin value = Emission level – Limit value.
- 5270MHz: Fundamental frequency.



<b>CHANNEL</b>	TX Channel 62	<b>DETECTOR FUNCTION</b>	Peak (PK)
<b>FREQUENCY RANGE</b>	1GHz ~ 40GHz		Average (AV)

**ANTENNA POLARITY & TEST DISTANCE: HORIZONTAL AT 3 M**

FREQ. (MHz)	EMISSION LEVEL (dBuV/m)	READ LEVEL (dBuV)	LIMIT (dBuV/m)	MARGIN (dB)	ANTENNA FACTOR (dB /m)	CABLE LOSS (dB)	PREAMP FACTOR (dB)	ANTENNA HEIGHT (cm)	TABLE ANGLE (Degree)	REMARK
5150	52.62	53.84	74.00	-21.38	34.20	11.17	46.59	100	355	Peak
5150	45.04	46.26	54.00	-8.96	34.20	11.17	46.59	100	355	Average
5310	96.77	97.67	/	/	34.30	11.35	46.55	100	355	Peak
5310	90.93	91.83	/	/	34.30	11.35	46.55	100	355	Average
5350	53.61	54.46	74.00	-20.39	34.30	11.39	46.54	100	355	Peak
5350	46.72	47.57	54.00	-7.28	34.30	11.39	46.54	100	355	Average

**ANTENNA POLARITY & TEST DISTANCE: VERTICAL AT 3 M**

FREQ. (MHz)	EMISSION LEVEL (dBuV/m)	READ LEVEL (dBuV)	LIMIT (dBuV/m)	MARGIN (dB)	ANTENNA FACTOR (dB /m)	CABLE LOSS (dB)	PREAMP FACTOR (dB)	ANTENNA HEIGHT (cm)	TABLE ANGLE (Degree)	REMARK
5150	52.15	53.57	74.00	-21.85	34.00	11.17	46.59	100	245	Peak
5150	44.76	46.18	54.00	-9.24	34.00	11.17	46.59	100	245	Average
5310	93.04	93.60	/	/	34.64	11.35	46.55	100	245	Peak
5310	87.07	87.63	/	/	34.64	11.35	46.55	100	245	Average
5350	54.23	54.58	74.00	-19.77	34.80	11.39	46.54	100	245	Peak
5350	47.29	47.64	54.00	-6.71	34.80	11.39	46.54	100	245	Average

**REMARKS:**

- Emission Level = Read Level+ Antenna Factor + Cable Loss- Preamp Factor  
Margin value = Emission level – Limit value.
- 5310MHz: Fundamental frequency.



**802.11ac (80MHz)**

<b>CHANNEL</b>	TX Channel 58	<b>DETECTOR FUNCTION</b>	Peak (PK)
<b>FREQUENCY RANGE</b>	1GHz ~ 40GHz		Average (AV)

ANTENNA POLARITY & TEST DISTANCE: HORIZONTAL AT 3 M										
FREQ. (MHz)	EMISSION LEVEL (dBuV/m)	READ LEVEL (dBuV)	LIMIT (dBuV/m)	MARGIN (dB)	ANTENNA FACTOR (dB /m)	CABLE LOSS (dB)	PREAMP FACTOR (dB)	ANTENNA HEIGHT (cm)	TABLE ANGLE (Degree)	REMARK
5150	50.29	51.51	74	-23.71	34.2	11.17	46.59	100	0	Peak
5150	47.28	48.5	54	-6.72	34.2	11.17	46.59	100	0	Average
5290	96.29	97.19	/	/	34.34	11.32	46.56	100	0	Peak
5290	90.54	91.44	/	/	34.34	11.32	46.56	100	0	Average
5350	54.81	55.66	74	-19.19	34.3	11.39	46.54	100	0	Peak
5350	50.79	51.64	54	-3.21	34.3	11.39	46.54	100	0	Average

ANTENNA POLARITY & TEST DISTANCE: VERTICAL AT 3 M										
FREQ. (MHz)	EMISSION LEVEL (dBuV/m)	READ LEVEL (dBuV)	LIMIT (dBuV/m)	MARGIN (dB)	ANTENNA FACTOR (dB /m)	CABLE LOSS (dB)	PREAMP FACTOR (dB)	ANTENNA HEIGHT (cm)	TABLE ANGLE (Degree)	REMARK
5150	47.83	49.25	74	-26.17	34	11.17	46.59	100	185	Peak
5150	46.86	48.28	54	-7.14	34	11.17	46.59	100	185	Average
5290	87.82	88.58	/	/	34.48	11.32	46.56	100	185	Peak
5290	82.4	83.16	/	/	34.48	11.32	46.56	100	185	Average
5350	55.87	56.22	74	-18.13	34.8	11.39	46.54	100	185	Peak
5350	48	48.35	54	-6	34.8	11.39	46.54	100	185	Average

**REMARKS:**

- Emission Level = Read Level+ Antenna Factor + Cable Loss- Preamp Factor  
Margin value = Emission level – Limit value.
- 5290MHz: Fundamental frequency.



**802.11ac (80MHz)**

**Worst case harmonic:**

<b>CHANNEL</b>	TX Channel 58	<b>DETECTOR FUNCTION</b>	Peak (PK)
<b>FREQUENCY RANGE</b>	1GHz ~ 40GHz		Average (AV)

**ANTENNA POLARITY & TEST DISTANCE: HORIZONTAL AT 3 M**

	Freq	Level	Read Level	Limit Line	Over Limit	Factor	Remark	Pol/Phase
	MHz	dBuV/m	dBuV	dBuV/m	dB	dB/m		
1	10588.000	53.17	45.91	74.00	-20.83	7.26	Peak	Horizontal
2	10588.000	44.37	37.11	54.00	-9.63	7.26	Average	Horizontal
3	PK15870.000	59.65	40.36	74.00	-14.35	19.29	Peak	Horizontal
4	PP15870.000	50.51	31.22	54.00	-3.49	19.29	Average	Horizontal

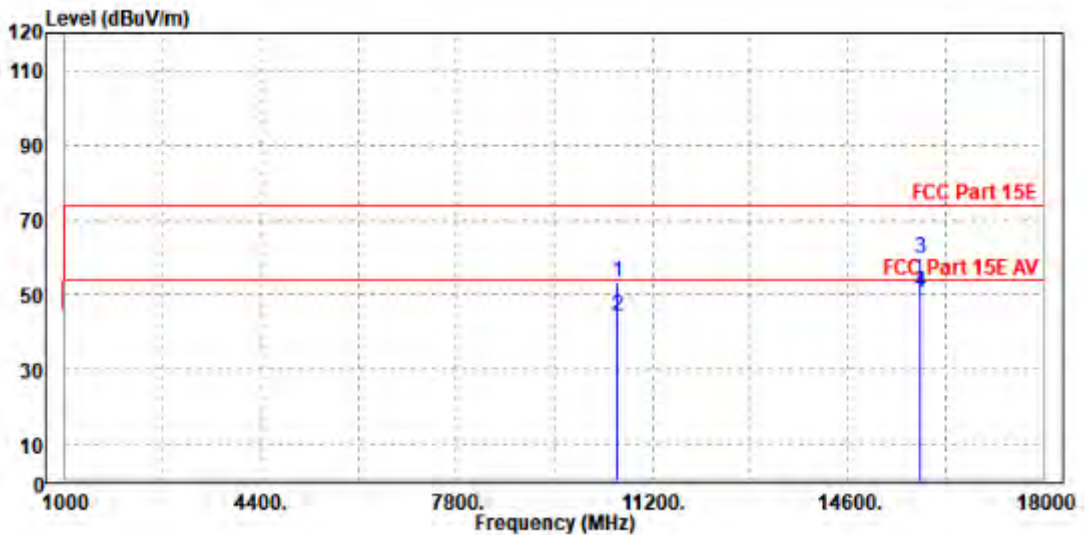





ANTENNA POLARITY & TEST DISTANCE: VERTICAL AT 3 M

	Freq	Level	Read Level	Limit Line	Over Limit	Factor	Remark	Pol/Phase
	MHz	dBuV/m	dBuV	dBuV/m	dB	dB/m		
1	10580.000	52.83	45.62	74.00	-21.17	7.21	Peak	Vertical
2	10580.000	44.27	37.06	54.00	-9.73	7.21	Average	Vertical
3	PK15875.000	59.04	39.78	74.00	-14.96	19.26	Peak	Vertical
4	PP15875.000	49.92	30.66	54.00	-4.08	19.26	Average	Vertical

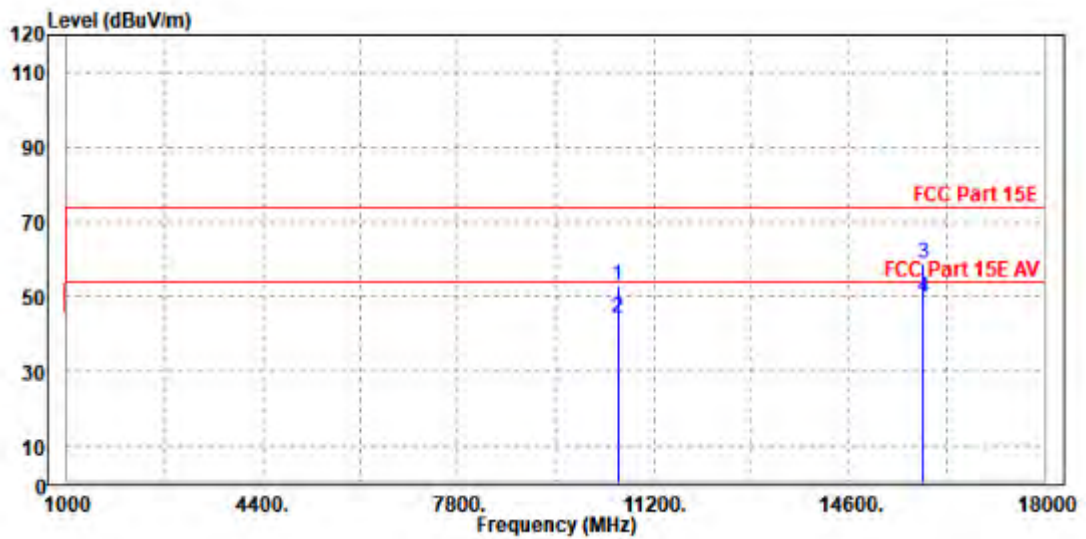

REMARKS:

1. Emission Level = Read Level+ Antenna Factor + Cable Loss- Preamp Factor  
Margin value = Emission level – Limit value.
2. 5290MHz: Fundamental frequency.
3. For frequency above 18GHz, the emission was tested 20db below the limit so the data not recorded in the sheet.



Band 3

802.11a

CHANNEL	TX Channel 100	DETECTOR FUNCTION	Peak (PK)
FREQUENCY RANGE	1GHz ~ 40GHz		Average (AV)

ANTENNA POLARITY & TEST DISTANCE: HORIZONTAL AT 3 M

FREQ. (MHz)	EMISSION LEVEL (dBuV/m)	READ LEVEL (dBuV)	LIMIT (dBuV/m)	MARGIN (dB)	ANTENNA FACTOR (dB /m)	CABLE LOSS (dB)	PREAMP FACTOR (dB)	ANTENNA HEIGHT (cm)	TABLE ANGLE (Degree)	REMARK
5460	52.19	52.6	74	-21.81	34.58	11.52	46.51	100	355	Peak
5460	46.3	46.71	54	-7.7	34.58	11.52	46.51	100	355	Average
5470	53.93	54.35	68.2	-14.27	34.56	11.53	46.51	100	355	Peak
5500	102	102.45	/	/	34.5	11.56	46.51	100	355	Peak
5500	94.11	94.56	/	/	34.5	11.56	46.51	100	355	Average

ANTENNA POLARITY & TEST DISTANCE: VERTICAL AT 3 M

FREQ. (MHz)	EMISSION LEVEL (dBuV/m)	READ LEVEL (dBuV)	LIMIT (dBuV/m)	MARGIN (dB)	ANTENNA FACTOR (dB /m)	CABLE LOSS (dB)	PREAMP FACTOR (dB)	ANTENNA HEIGHT (cm)	TABLE ANGLE (Degree)	REMARK
5460	52.52	53.23	74	-21.48	34.28	11.52	46.51	100	245	Peak
5460	45.79	46.5	54	-8.21	34.28	11.52	46.51	100	245	Average
5470	53.23	53.95	68.2	-14.97	34.26	11.53	46.51	100	245	Peak
5500	95.82	96.57	/	/	34.2	11.56	46.51	100	245	Peak
5500	88.21	88.96	/	/	34.2	11.56	46.51	100	245	Average

REMARKS:

- Emission Level = Read Level+ Antenna Factor + Cable Loss- Preamp Factor  
Margin value = Emission level – Limit value.
- 5500MHz: Fundamental frequency.
- #: Out of restricted band.



<b>CHANNEL</b>	TX Channel 116	<b>DETECTOR FUNCTION</b>	Peak (PK)
<b>FREQUENCY RANGE</b>	1GHz ~ 40GHz		Average (AV)

ANTENNA POLARITY & TEST DISTANCE: HORIZONTAL AT 3 M										
FREQ. (MHz)	EMISSION LEVEL (dBuV/m)	READ LEVEL (dBuV)	LIMIT (dBuV/m)	MARGIN (dB)	ANTENNA FACTOR (dB /m)	CABLE LOSS (dB)	PREAMP FACTOR (dB)	ANTENNA HEIGHT (cm)	TABLE ANGLE (Degree)	REMARK
5460	53.19	53.6	74	-20.81	34.58	11.52	46.51	100	355	Peak
5460	45.94	46.35	54	-8.06	34.58	11.52	46.51	100	355	Average
5470	53.73	54.15	68.2	-14.47	34.56	11.53	46.51	100	355	Peak
5580	102.15	102.75	/	/	34.3	11.59	46.49	100	355	Peak
5580	87.87	88.47	/	/	34.3	11.59	46.49	100	355	Average

ANTENNA POLARITY & TEST DISTANCE: VERTICAL AT 3 M										
FREQ. (MHz)	EMISSION LEVEL (dBuV/m)	READ LEVEL (dBuV)	LIMIT (dBuV/m)	MARGIN (dB)	ANTENNA FACTOR (dB /m)	CABLE LOSS (dB)	PREAMP FACTOR (dB)	ANTENNA HEIGHT (cm)	TABLE ANGLE (Degree)	REMARK
5460	52.06	52.77	74	-21.94	34.28	11.52	46.51	100	245	Peak
5460	45.57	46.28	54	-8.43	34.28	11.52	46.51	100	245	Average
5470	53.18	53.9	68.2	-15.02	34.26	11.53	46.51	100	245	Peak
5580	95.91	95.87	/	/	34.94	11.59	46.49	100	245	Peak
5580	88.12	88.08	/	/	34.94	11.59	46.49	100	245	Average

**REMARKS:**

- Emission Level = Read Level+ Antenna Factor + Cable Loss- Preamp Factor  
Margin value = Emission level – Limit value.
- 5580MHz: Fundamental frequency.
- #: Out of restricted band.



<b>CHANNEL</b>	TX Channel 140	<b>DETECTOR FUNCTION</b>	Peak (PK)
<b>FREQUENCY RANGE</b>	1GHz ~ 40GHz		Average (AV)

**ANTENNA POLARITY & TEST DISTANCE: HORIZONTAL AT 3 M**

FREQ. (MHz)	EMISSION LEVEL (dBuV/m)	READ LEVEL (dBuV)	LIMIT (dBuV/m)	MARGIN (dB)	ANTENNA FACTOR (dB /m)	CABLE LOSS (dB)	PREAMP FACTOR (dB)	ANTENNA HEIGHT (cm)	TABLE ANGLE (Degree)	REMARK
5700	101.97	102.19	/	/	34.6	11.64	46.46	100	355	Peak
5700	93.65	93.87	/	/	34.6	11.64	46.46	100	355	Average
5725	53.04	53.29	68.2	-15.16	34.55	11.65	46.45	100	355	Peak

**ANTENNA POLARITY & TEST DISTANCE: VERTICAL AT 3 M**

FREQ. (MHz)	EMISSION LEVEL (dBuV/m)	READ LEVEL (dBuV)	LIMIT (dBuV/m)	MARGIN (dB)	ANTENNA FACTOR (dB /m)	CABLE LOSS (dB)	PREAMP FACTOR (dB)	ANTENNA HEIGHT (cm)	TABLE ANGLE (Degree)	REMARK
5700	94.66	95.18	/	/	34.3	11.64	46.46	100	245	Peak
5700	87.44	87.96	/	/	34.3	11.64	46.46	100	245	Average
5725	53.14	53.59	68.2	-15.06	34.35	11.65	46.45	100	245	Peak

**REMARKS:**

- Emission Level = Read Level+ Antenna Factor + Cable Loss- Preamp Factor  
Margin value = Emission level – Limit value.
- 5700MHz: Fundamental frequency.
- #: Out of restricted band.



**802.11n (20MHz)**

<b>CHANNEL</b>	TX Channel 100	<b>DETECTOR FUNCTION</b>	Peak (PK)
<b>FREQUENCY RANGE</b>	1GHz ~ 40GHz		Average (AV)

ANTENNA POLARITY & TEST DISTANCE: HORIZONTAL AT 3 M										
FREQ. (MHz)	EMISSION LEVEL (dBuV/m)	READ LEVEL (dBuV)	LIMIT (dBuV/m)	MARGIN (dB)	ANTENNA FACTOR (dB /m)	CABLE LOSS (dB)	PREAMP FACTOR (dB)	ANTENNA HEIGHT (cm)	TABLE ANGLE (Degree)	REMARK
5460	53.21	53.62	74	-20.79	34.58	11.52	46.51	100	355	Peak
5460	45.86	46.27	54	-8.14	34.58	11.52	46.51	100	355	Average
5470	52.73	53.15	68.2	-15.47	34.56	11.53	46.51	100	355	Peak
5500	101.68	102.13	/	/	34.5	11.56	46.51	100	355	Peak
5500	87.24	87.69	/	/	34.5	11.56	46.51	100	355	Average

ANTENNA POLARITY & TEST DISTANCE: VERTICAL AT 3 M										
FREQ. (MHz)	EMISSION LEVEL (dBuV/m)	READ LEVEL (dBuV)	LIMIT (dBuV/m)	MARGIN (dB)	ANTENNA FACTOR (dB /m)	CABLE LOSS (dB)	PREAMP FACTOR (dB)	ANTENNA HEIGHT (cm)	TABLE ANGLE (Degree)	REMARK
5460	52.15	52.86	74	-21.85	34.28	11.52	46.51	100	245	Peak
5460	45.42	46.13	54	-8.58	34.28	11.52	46.51	100	245	Average
5470	52.87	53.59	68.2	-15.33	34.26	11.53	46.51	100	245	Peak
5500	94.79	95.54	/	/	34.2	11.56	46.51	100	245	Peak
5500	87.5	88.25	/	/	34.2	11.56	46.51	100	245	Average

**REMARKS:**

- Emission Level = Read Level+ Antenna Factor + Cable Loss- Preamp Factor  
Margin value = Emission level – Limit value.
- 5500MHz: Fundamental frequency.
- #: Out of restricted band.



<b>CHANNEL</b>	TX Channel 116	<b>DETECTOR FUNCTION</b>	Peak (PK)
<b>FREQUENCY RANGE</b>	1GHz ~ 40GHz		Average (AV)

**ANTENNA POLARITY & TEST DISTANCE: HORIZONTAL AT 3 M**

FREQ. (MHz)	EMISSION LEVEL (dBuV/m)	READ LEVEL (dBuV)	LIMIT (dBuV/m)	MARGIN (dB)	ANTENNA FACTOR (dB /m)	CABLE LOSS (dB)	PREAMP FACTOR (dB)	ANTENNA HEIGHT (cm)	TABLE ANGLE (Degree)	REMARK
5460	52.06	52.47	74	-21.94	34.58	11.52	46.51	100	355	Peak
5460	46.17	46.58	54	-7.83	34.58	11.52	46.51	100	355	Average
5470	53.18	53.6	68.2	-15.02	34.56	11.53	46.51	100	355	Peak
5580	101.33	101.93	/	/	34.3	11.59	46.49	100	355	Peak
5580	87.05	87.65	/	/	34.3	11.59	46.49	100	355	Average

**ANTENNA POLARITY & TEST DISTANCE: VERTICAL AT 3 M**

FREQ. (MHz)	EMISSION LEVEL (dBuV/m)	READ LEVEL (dBuV)	LIMIT (dBuV/m)	MARGIN (dB)	ANTENNA FACTOR (dB /m)	CABLE LOSS (dB)	PREAMP FACTOR (dB)	ANTENNA HEIGHT (cm)	TABLE ANGLE (Degree)	REMARK
5460	52.9	53.61	74	-21.1	34.28	11.52	46.51	100	245	Peak
5460	45.55	46.26	54	-8.45	34.28	11.52	46.51	100	245	Average
5470	52.13	52.85	68.2	-16.07	34.26	11.53	46.51	100	245	Peak
5580	95.84	95.8	/	/	34.94	11.59	46.49	100	245	Peak
5580	87.54	87.5	/	/	34.94	11.59	46.49	100	245	Average

**REMARKS:**

- Emission Level = Read Level+ Antenna Factor + Cable Loss- Preamp Factor  
Margin value = Emission level – Limit value.
- 5580MHz: Fundamental frequency.
- #: Out of restricted band.



<b>CHANNEL</b>	TX Channel 140	<b>DETECTOR FUNCTION</b>	Peak (PK)
<b>FREQUENCY RANGE</b>	1GHz ~ 40GHz		Average (AV)

ANTENNA POLARITY & TEST DISTANCE: HORIZONTAL AT 3 M										
FREQ. (MHz)	EMISSION LEVEL (dBuV/m)	READ LEVEL (dBuV)	LIMIT (dBuV/m)	MARGIN (dB)	ANTENNA FACTOR (dB /m)	CABLE LOSS (dB)	PREAMP FACTOR (dB)	ANTENNA HEIGHT (cm)	TABLE ANGLE (Degree)	REMARK
5700	101.35	101.57	/	/	34.6	11.64	46.46	100	355	Peak
5700	93.54	93.76	/	/	34.6	11.64	46.46	100	355	Average
5725	53.42	53.67	68.2	-14.78	34.55	11.65	46.45	100	355	Peak
ANTENNA POLARITY & TEST DISTANCE: VERTICAL AT 3 M										
FREQ. (MHz)	EMISSION LEVEL (dBuV/m)	READ LEVEL (dBuV)	LIMIT (dBuV/m)	MARGIN (dB)	ANTENNA FACTOR (dB /m)	CABLE LOSS (dB)	PREAMP FACTOR (dB)	ANTENNA HEIGHT (cm)	TABLE ANGLE (Degree)	REMARK
5700	94.15	94.67	/	/	34.3	11.64	46.46	100	245	Peak
5700	86.43	86.95	/	/	34.3	11.64	46.46	100	245	Average
5725	53.17	53.62	68.2	-15.03	34.35	11.65	46.45	100	245	Peak

**REMARKS:**

1. Emission Level = Read Level+ Antenna Factor + Cable Loss- Preamp Factor  
Margin value = Emission level – Limit value.
2. 5700MHz: Fundamental frequency.
3. #: Out of restricted band.



802.11n (40MHz)

CHANNEL	TX Channel 102	DETECTOR FUNCTION	Peak (PK)
FREQUENCY RANGE	1GHz ~ 40GHz		Average (AV)

ANTENNA POLARITY & TEST DISTANCE: HORIZONTAL AT 3 M

FREQ. (MHz)	EMISSION LEVEL (dBuV/m)	READ LEVEL (dBuV)	LIMIT (dBuV/m)	MARGIN (dB)	ANTENNA FACTOR (dB /m)	CABLE LOSS (dB)	PREAMP FACTOR (dB)	ANTENNA HEIGHT (cm)	TABLE ANGLE (Degree)	REMARK
5460	52.89	53.3	74	-21.11	34.58	11.52	46.51	100	355	Peak
5460	45.97	46.38	54	-8.03	34.58	11.52	46.51	100	355	Average
5470	51.9	52.32	68.2	-16.3	34.56	11.53	46.51	100	355	Peak
5510	96.87	97.35	/	/	34.46	11.56	46.5	100	355	Peak
5510	91.15	91.63	/	/	34.46	11.56	46.5	100	355	Average

ANTENNA POLARITY & TEST DISTANCE: VERTICAL AT 3 M

FREQ. (MHz)	EMISSION LEVEL (dBuV/m)	READ LEVEL (dBuV)	LIMIT (dBuV/m)	MARGIN (dB)	ANTENNA FACTOR (dB /m)	CABLE LOSS (dB)	PREAMP FACTOR (dB)	ANTENNA HEIGHT (cm)	TABLE ANGLE (Degree)	REMARK
5460	52.14	52.85	74	-21.86	34.28	11.52	46.51	100	245	Peak
5460	45.45	46.16	54	-8.55	34.28	11.52	46.51	100	245	Average
5470	52.98	53.7	68.2	-15.22	34.26	11.53	46.51	100	245	Peak
5510	92.79	93.43	/	/	34.3	11.56	46.5	100	245	Peak
5510	85.2	85.84	/	/	34.3	11.56	46.5	100	245	Average

REMARKS:

- Emission Level = Read Level+ Antenna Factor + Cable Loss- Preamp Factor  
Margin value = Emission level – Limit value.
- 5510MHz: Fundamental frequency.
- #: Out of restricted band.





<b>CHANNEL</b>	TX Channel 110	<b>DETECTOR FUNCTION</b>	Peak (PK)
<b>FREQUENCY RANGE</b>	1GHz ~ 40GHz		Average (AV)

ANTENNA POLARITY & TEST DISTANCE: HORIZONTAL AT 3 M										
FREQ. (MHz)	EMISSION LEVEL (dBuV/m)	READ LEVEL (dBuV)	LIMIT (dBuV/m)	MARGIN (dB)	ANTENNA FACTOR (dB /m)	CABLE LOSS (dB)	PREAMP FACTOR (dB)	ANTENNA HEIGHT (cm)	TABLE ANGLE (Degree)	REMARK
5460	52.39	52.8	74	-21.61	34.58	11.52	46.51	100	355	Peak
5460	45.73	46.14	54	-8.27	34.58	11.52	46.51	100	355	Average
5470	52.43	52.85	68.2	-15.77	34.56	11.53	46.51	100	355	Peak
5550	100.84	101.45	/	/	34.3	11.58	46.49	100	355	Peak
5550	93.96	94.57	/	/	34.3	11.58	46.49	100	355	Average
ANTENNA POLARITY & TEST DISTANCE: VERTICAL AT 3 M										
FREQ. (MHz)	EMISSION LEVEL (dBuV/m)	READ LEVEL (dBuV)	LIMIT (dBuV/m)	MARGIN (dB)	ANTENNA FACTOR (dB /m)	CABLE LOSS (dB)	PREAMP FACTOR (dB)	ANTENNA HEIGHT (cm)	TABLE ANGLE (Degree)	REMARK
5460	51.95	52.66	74	-22.05	34.28	11.52	46.51	100	245	Peak
5460	45.65	46.36	54	-8.35	34.28	11.52	46.51	100	245	Average
5470	52.55	53.27	68.2	-15.65	34.26	11.53	46.51	100	245	Peak
5550	92.97	93.18	/	/	34.7	11.58	46.49	100	245	Peak
5550	85.88	86.09	/	/	34.7	11.58	46.49	100	245	Average

**REMARKS:**

- Emission Level = Read Level+ Antenna Factor + Cable Loss- Preamp Factor  
Margin value = Emission level – Limit value.
- 5500MHz: Fundamental frequency.
- #: Out of restricted band.



<b>CHANNEL</b>	TX Channel 134	<b>DETECTOR FUNCTION</b>	Peak (PK)
<b>FREQUENCY RANGE</b>	1GHz ~ 40GHz		Average (AV)

**ANTENNA POLARITY & TEST DISTANCE: HORIZONTAL AT 3 M**

FREQ. (MHz)	EMISSION LEVEL (dBuV/m)	READ LEVEL (dBuV)	LIMIT (dBuV/m)	MARGIN (dB)	ANTENNA FACTOR (dB /m)	CABLE LOSS (dB)	PREAMP FACTOR (dB)	ANTENNA HEIGHT (cm)	TABLE ANGLE (Degree)	REMARK
5670	100.57	100.81	/	/	34.6	11.62	46.46	100	355	Peak
5670	92.59	92.83	/	/	34.6	11.62	46.46	100	355	Average
5725	54.4	54.65	68.2	-13.8	34.55	11.65	46.45	100	355	Peak

**ANTENNA POLARITY & TEST DISTANCE: VERTICAL AT 3 M**

FREQ. (MHz)	EMISSION LEVEL (dBuV/m)	READ LEVEL (dBuV)	LIMIT (dBuV/m)	MARGIN (dB)	ANTENNA FACTOR (dB /m)	CABLE LOSS (dB)	PREAMP FACTOR (dB)	ANTENNA HEIGHT (cm)	TABLE ANGLE (Degree)	REMARK
5670	92.16	92.58	/	/	34.42	11.62	46.46	100	355	Peak
5670	85.34	85.76	/	/	34.42	11.62	46.46	100	355	Average
5725	52.04	52.49	68.2	-16.16	34.35	11.65	46.45	100	355	Peak

**REMARKS:**

- Emission Level = Read Level+ Antenna Factor + Cable Loss- Preamp Factor  
Margin value = Emission level – Limit value.
- 5670MHz: Fundamental frequency.
- #: Out of restricted band.



802.11ac (80MHz)

CHANNEL	TX Channel 106	DETECTOR FUNCTION	Peak (PK)
FREQUENCY RANGE	1GHz ~ 40GHz		Average (AV)

ANTENNA POLARITY & TEST DISTANCE: HORIZONTAL AT 3 M										
FREQ. (MHz)	EMISSION LEVEL (dBuV/m)	READ LEVEL (dBuV)	LIMIT (dBuV/m)	MARGIN (dB)	ANTENNA FACTOR (dB /m)	CABLE LOSS (dB)	PREAMP FACTOR (dB)	ANTENNA HEIGHT (cm)	TABLE ANGLE (Degree)	REMARK
5460	52.29	52.7	74	-21.71	34.58	11.52	46.51	100	355	Peak
5460	45.87	46.28	54	-8.13	34.58	11.52	46.51	100	355	Average
5470	53.19	53.61	68.2	-15.01	34.56	11.53	46.51	100	355	Peak
5530	93.19	93.74	/	/	34.38	11.57	46.5	100	355	Peak
5530	87.86	88.41	/	/	34.38	11.57	46.5	100	355	Average
ANTENNA POLARITY & TEST DISTANCE: VERTICAL AT 3 M										
FREQ. (MHz)	EMISSION LEVEL (dBuV/m)	READ LEVEL (dBuV)	LIMIT (dBuV/m)	MARGIN (dB)	ANTENNA FACTOR (dB /m)	CABLE LOSS (dB)	PREAMP FACTOR (dB)	ANTENNA HEIGHT (cm)	TABLE ANGLE (Degree)	REMARK
5460	52.07	52.78	74	-21.93	34.28	11.52	46.51	100	245	Peak
5460	45.65	46.36	54	-8.35	34.28	11.52	46.51	100	245	Average
5470	52.88	53.6	68.2	-15.32	34.26	11.53	46.51	100	245	Peak
5530	88.83	89.26	/	/	34.5	11.57	46.5	100	245	Peak
5530	83.81	84.24	/	/	34.5	11.57	46.5	100	245	Average

REMARKS:

1. Emission Level = Read Level+ Antenna Factor + Cable Loss- Preamp Factor  
Margin value = Emission level – Limit value.
2. 5530MHz: Fundamental frequency.
3. #: Out of restricted band.



802.11a

Worst case harmonic:

<b>CHANNEL</b>	TX Channel 100	<b>DETECTOR FUNCTION</b>	Peak (PK)
<b>FREQUENCY RANGE</b>	1GHz ~ 40GHz		Average (AV)

**ANTENNA POLARITY & TEST DISTANCE: HORIZONTAL AT 3 M**

	Freq	Level	Read Level	Limit Line	Over Limit	Factor	Remark	Pol/Phase
	MHz	dBuV/m	dBuV	dBuV/m	dB	dB/m		
1	10996.000	49.28	42.41	74.00	-24.72	6.87	Peak	Horizontal
2	10996.000	40.75	33.88	54.00	-13.25	6.87	Average	Horizontal
3	PK16500.000	56.82	38.86	74.00	-17.18	17.96	Peak	Horizontal
4	PP16500.000	47.52	29.56	54.00	-6.48	17.96	Average	Horizontal

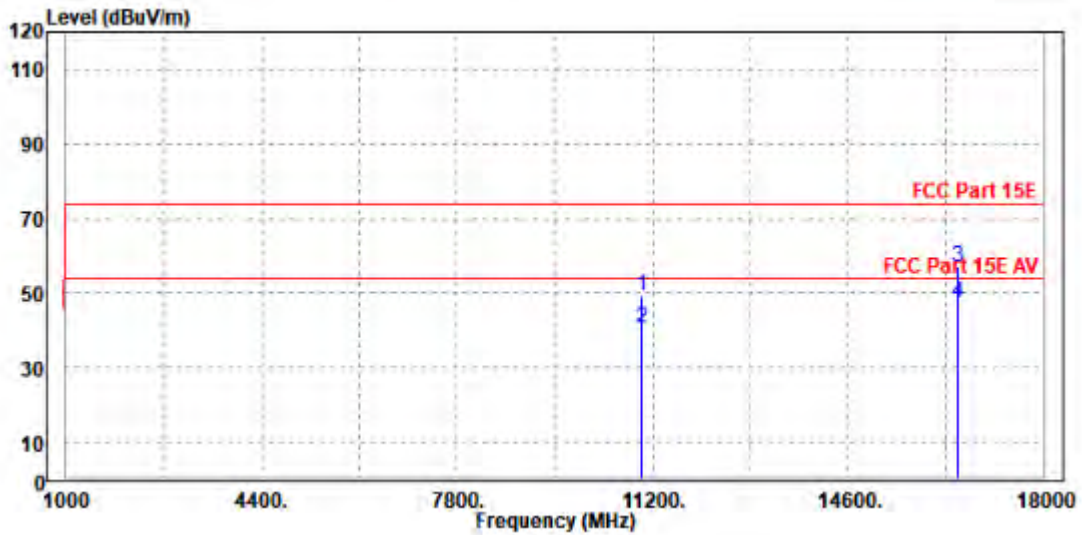



ANTENNA POLARITY & TEST DISTANCE: VERTICAL AT 3 M

	Freq	Level	Read Level	Limit Line	Over Limit	Factor	Remark	Pol/Phase
	MHz	dBuV/m	dBuV	dBuV/m	dB	dB/m		
1	11000.000	50.70	43.43	74.00	-23.30	7.27	Peak	Vertical
2	11000.000	41.93	34.66	54.00	-12.07	7.27	Average	Vertical
3	PK16504.000	59.64	41.88	74.00	-14.36	17.76	Peak	Vertical
4	PP16504.000	50.32	32.56	54.00	-3.68	17.76	Average	Vertical

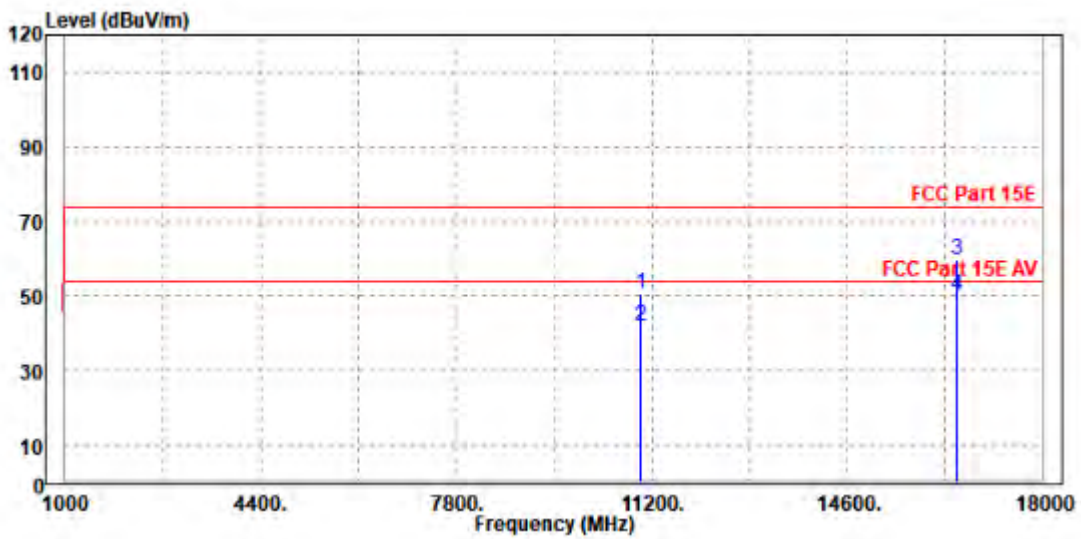

REMARKS:

1. Emission Level = Read Level+ Antenna Factor + Cable Loss- Preamp Factor  
Margin value = Emission level – Limit value.
2. 5500MHz: Fundamental frequency.
3. For frequency above 18GHz, the emission was tested 20db below the limit so the data not recorded in the sheet.



Band 4:

802.11a

CHANNEL	TX Channel 149	DETECTOR FUNCTION	Peak (PK)
FREQUENCY RANGE	1GHz ~ 40GHz		Average (AV)

ANTENNA POLARITY & TEST DISTANCE: HORIZONTAL AT 3 M										
FREQ. (MHz)	EMISSION LEVEL (dBuV/m)	READ LEVEL (dBuV)	LIMIT (dBuV/m)	MARGIN (dB)	ANTENNA FACTOR (dB /m)	CABLE LOSS (dB)	PREAMP FACTOR (dB)	ANTENNA HEIGHT (cm)	TABLE ANGLE (Degree)	REMARK
5745	99.24	99.52	/	/	34.51	11.65	46.44	100	305	Peak
5745	92.37	92.65	/	/	34.51	11.65	46.44	100	305	Average
ANTENNA POLARITY & TEST DISTANCE: VERTICAL AT 3 M										
FREQ. (MHz)	EMISSION LEVEL (dBuV/m)	READ LEVEL (dBuV)	LIMIT (dBuV/m)	MARGIN (dB)	ANTENNA FACTOR (dB /m)	CABLE LOSS (dB)	PREAMP FACTOR (dB)	ANTENNA HEIGHT (cm)	TABLE ANGLE (Degree)	REMARK
5745	94.78	95.18	/	/	34.39	11.65	46.44	100	190	Peak
5745	88.14	88.54	/	/	34.39	11.65	46.44	100	190	Average

REMARKS:

- Emission Level = Read Level+ Antenna Factor + Cable Loss- Preamp Factor  
Margin value = Emission level – Limit value.
- 5745MHz: Fundamental frequency.



**Oobe Data**

802.11a

ANTENNA POLARITY & TEST DISTANCE: HORIZONTAL AT 3 M										
FREQ. (MHz)	EMISSION LEVEL (dBuV/m)	READ LEVEL (dBuV)	LIMIT (dBuV/m)	MARGIN (dB)	ANTENNA FACTOR (dB /m)	CABLE LOSS (dB)	PREAMP FACTOR (dB)	ANTENNA HEIGHT (cm)	TABLE ANGLE (Degree)	REMARK
5551.9	57.05	57.66	68.2	-11.15	34.3	11.58	46.49	100	360	Peak
5946.15	58.55	58.12	68.2	-9.65	35.09	11.73	46.39	100	360	Peak
ANTENNA POLARITY & TEST DISTANCE: VERTICAL AT 3 M										
FREQ. (MHz)	EMISSION LEVEL (dBuV/m)	READ LEVEL (dBuV)	LIMIT (dBuV/m)	MARGIN (dB)	ANTENNA FACTOR (dB /m)	CABLE LOSS (dB)	PREAMP FACTOR (dB)	ANTENNA HEIGHT (cm)	TABLE ANGLE (Degree)	REMARK
5554.75	57.92	58.09	68.2	-10.28	34.74	11.58	46.49	100	0	Peak
5978.45	57.86	57.55	68.2	-10.34	34.96	11.74	46.39	100	0	Peak

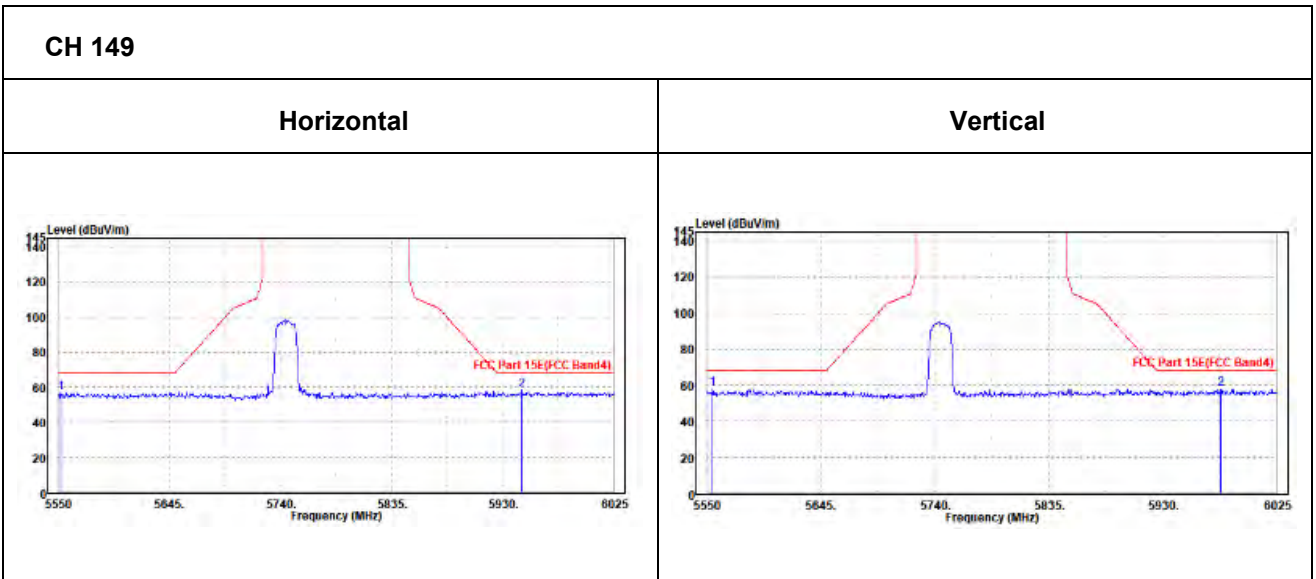



<b>CHANNEL</b>	TX Channel 157	<b>DETECTOR FUNCTION</b>	Peak (PK)
<b>FREQUENCY RANGE</b>	1GHz ~ 40GHz		Average (AV)

**ANTENNA POLARITY & TEST DISTANCE: HORIZONTAL AT 3 M**

FREQ. (MHz)	EMISSION LEVEL (dBuV/m)	READ LEVEL (dBuV)	LIMIT (dBuV/m)	MARGIN (dB)	ANTENNA FACTOR (dB /m)	CABLE LOSS (dB)	PREAMP FACTOR (dB)	ANTENNA HEIGHT (cm)	TABLE ANGLE (Degree)	REMARK
5785	99.48	99.6	/	/	34.64	11.67	46.43	100	305	Peak
5785	93.02	93.14	/	/	34.64	11.67	46.43	100	305	Average

**ANTENNA POLARITY & TEST DISTANCE: VERTICAL AT 3 M**

FREQ. (MHz)	EMISSION LEVEL (dBuV/m)	READ LEVEL (dBuV)	LIMIT (dBuV/m)	MARGIN (dB)	ANTENNA FACTOR (dB /m)	CABLE LOSS (dB)	PREAMP FACTOR (dB)	ANTENNA HEIGHT (cm)	TABLE ANGLE (Degree)	REMARK
5785	94.41	94.42	/	/	34.75	11.67	46.43	100	190	Peak
5785	87.61	87.62	/	/	34.75	11.67	46.43	100	190	Average

**REMARKS:**

- Emission Level = Read Level+ Antenna Factor + Cable Loss- Preamp Factor  
Margin value = Emission level – Limit value.
- 5785MHz: Fundamental frequency.