



3.2 FREQUENCY STABILITY MEASUREMENT

3.2.1 LIMITS OF FREQUENCY STABILITY MEASUREMENT

The frequency stability shall be sufficient to ensure that the fundamental emission stays within the authorized frequency block.

3.2.2 TEST PROCEDURE

- The device is placed in the oven room. The oven room could control the temperatures and humidity. Power warms up is at least 15 min and power applied should perform before recording frequency error.
- EUT is connected the external power supply to control the DC input power. The test voltage range is from minimum to maximum working voltage. Each step shall be recording the frequency error rate.
- The temperature range step is 10 degrees in this test items. All temperature levels shall be holding $\pm 0.5^{\circ}\text{C}$ during the measurement testing. Each temperature step shall be at least 0.5 hours, consider the EUT could be test under the stability condition.

NOTE: The frequency error was recorded frequency error from the communication simulator.

3.2.3 TEST SETUP

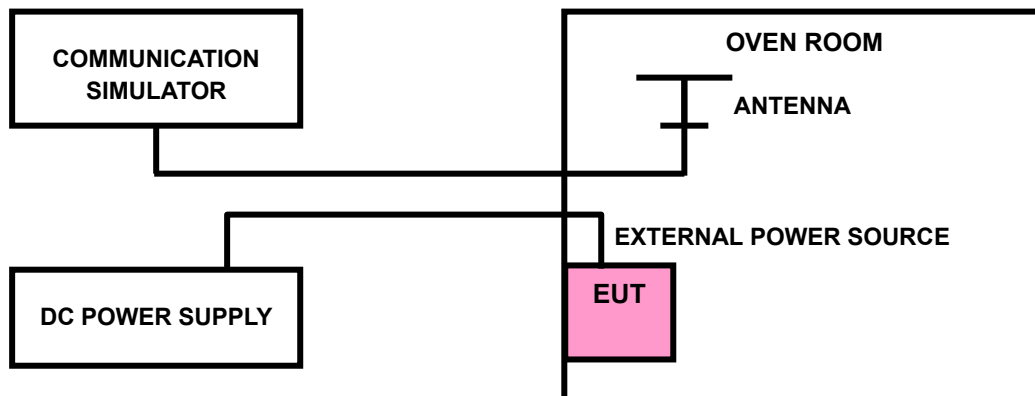



**BUREAU
VERITAS**

Test Report No.: W7L-240618W002RF06

3.2.4 TEST RESULTS

Please Refer to Appendix Of this test report.

Note: LV = Low voltage (3.7V); NV = Normal voltage (3.91V); HV= High voltage (4.3V).
NT = Normal temperature (25°C)



3.3 OCCUPIED BANDWIDTH MEASUREMENT

3.3.1 LIMITS OF OCCUPIED BANDWIDTH MEASUREMENT

The width of a frequency band is such that, below the lower and above the upper frequency limits, the mean powers emitted are each equal to a specified percentage. 0.5 % of the total mean power of a given emission.

3.3.2 TEST SETUP

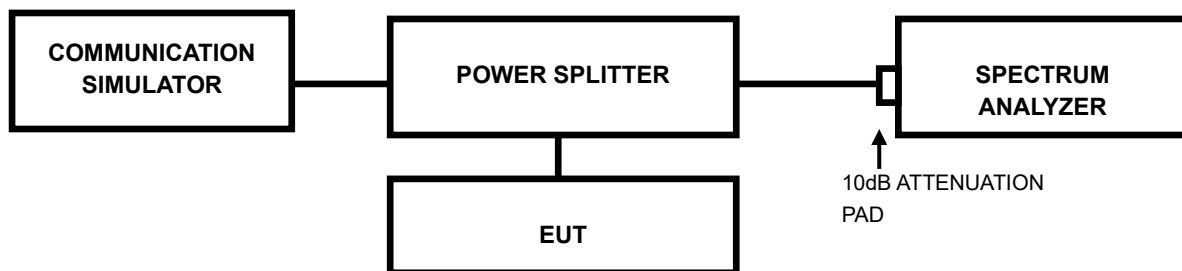

3.3.3 TEST PROCEDURES

- The conducted occupied bandwidth used the power splitter via EUT RF power connector between simulation base station and spectrum analyzer.
- Use OBW measurement function of Spectrum analyzer to measure 99 % occupied bandwidth.



**BUREAU
VERITAS**

Test Report No.: W7L-240618W002RF06

3.3.4 TEST RESULTS

Please Refer to Appendix Of this test report.



3.4 BAND EDGE MEASUREMENTC

3.4.1 LIMITS OF BAND EDGE MEASUREMENT

Power of any emission outside of the authorized operating frequency ranges must be attenuated below the transmitting power (P) by a factor of at least $43 + 10 \log(P)$ dB. In the 1 MHz bands immediately outside and adjacent to the frequency block a resolution bandwidth of at least one percent of the emission bandwidth of the fundamental emission of the transmitter may be employed.

3.4.2 TEST SETUP

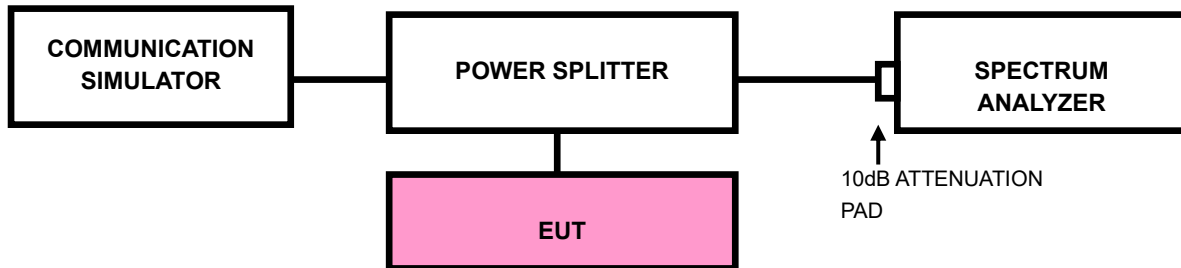



3.4.3 TEST PROCEDURES

- a) All measurements were done at low and high operational frequency range.
- b) Connect the transmitter to the spectrum analyzer via coaxial cable while ensuring proper impedance matching.
- c) Tune the analyzer to the nominal center frequency of the emission bandwidth (EBW)
- d) Set the resolution bandwidth (RBW) $\geq 1\%$ EBW in the 1MHz band immediately outside and adjacent to the band edge.
- e) Beyond the 1MHz band from the band edge, RBW=1MHz was used.
- f) Set the video bandwidth (VBW) to $\geq 3 \times$ RBW.
- g) Select the average power (RMS) display detector.
- h) Set the number of measurement points to ≥ 1001 .
- i) Use auto-coupled sweep time.
- j) Perform the measurement over an interval of time when the transmission is continuous and at its maximum power level.
- k) The RF fundamental frequency should be excluded against the limit line in the operating frequency band and use RBW is 10KHz or 100KHz.
- l) Record the max trace plot into the test report.



**BUREAU
VERITAS**

Test Report No.: W7L-240618W002RF06

3.4.4. TEST RESULTS

Please Refer to Appendix Of this test report.



3.5 CONDUCTED SPURIOUS EMISSIONS

3.5.1 LIMITS OF CONDUCTED SPURIOUS EMISSIONS MEASUREMENT

The power of any emission outside of the authorized operating frequency ranges must be attenuated below the transmitting power (P) by a factor of at least $43 + 10 \log(P)$ dB. The emission limit is equal to -13dBm .

3.5.2 TEST PROCEDURE

- a. The EUT makes a phone call to the communication simulator. All measurements were done at low, middle, and high operational frequency range.
- b. Measuring frequency range is from 30MHz up to a frequency including its 10th harmonic. 10dB attenuation pad is connected with spectrum. RBW=1MHz and VBW=3MHz is used for conducted emission measurement.

3.5.3 TEST SETUP

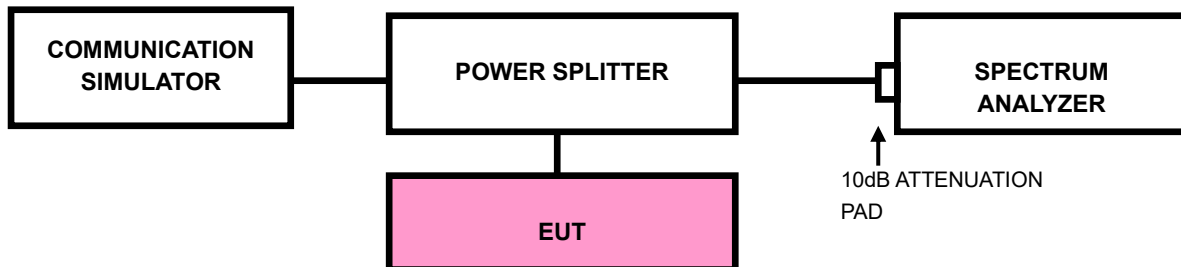



**BUREAU
VERITAS**

Test Report No.: W7L-240618W002RF06

3.5.4 TEST RESULTS

NOTE : The 9K~30MHz amplitude of spurious emissions attenuated more than 20 dB below the permissible value is not required in the report.

Please Refer to Appendix Of this test report.



3.6 RADIATED EMISSION MEASUREMENT

3.6.1 LIMITS OF RADIATED EMISSION MEASUREMENT

The power of any emission outside of the authorized operating frequency ranges must be attenuated below the transmitting power (P) by a factor of at least $43 + 10 \log(P)$ dB. The emission limit is equal to -13dBm .

3.6.2 TEST PROCEDURES

- a. The substitute method is used for E.I.R.P measurement. In the semi-anechoic chamber, EUT placed on the 0.8m height of Turn Table, rotated the table around 360 degrees to search the maximum radiation power and receiver antenna shall be rotated vertical and horizontal polarization and moved height from 1m to 4m to find the maximum polar radiated power. The “Read Value” is the spectrum reading the maximum power value.
- b. The substitution horn antenna is substituted for EUT at the same position and signals generator exports the CW signal to the substitution antenna via a TX cable. Rotated the Turn Table and moved the receiving antenna to find the maximum radiation power. Adjust output power level of S.G to get a Value of spectrum reading equal to “Read Value “ of step a. Record the power level of S.G
- c. $\text{EIRP} = \text{Output power level of S.G} - \text{TX cable loss} + \text{Antenna gain of substitution horn}$.

NOTE: The resolution bandwidth and video bandwidth of test receiver/spectrum analyzer is 1MHz/3MHz.

3.6.3 DEVIATION FROM TEST STANDARD

No deviation



3.6.4 TEST SETUP

< Frequency Range below 30MHz >

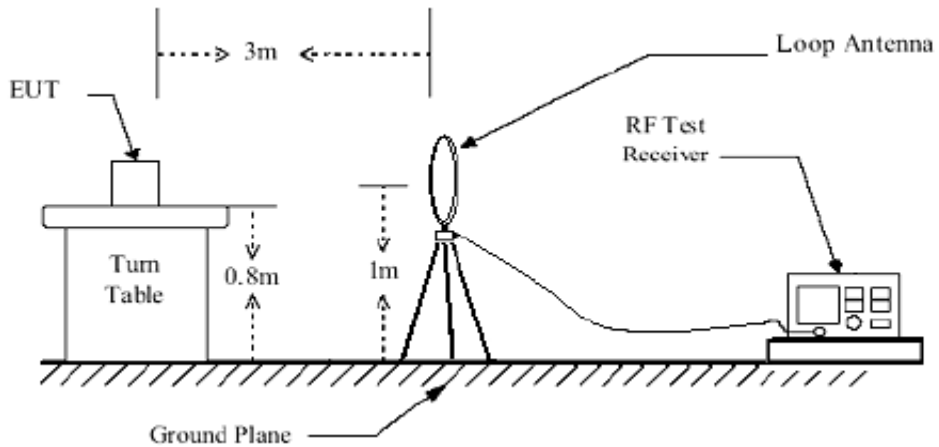

< Frequency Range 30MHz~1GHz >

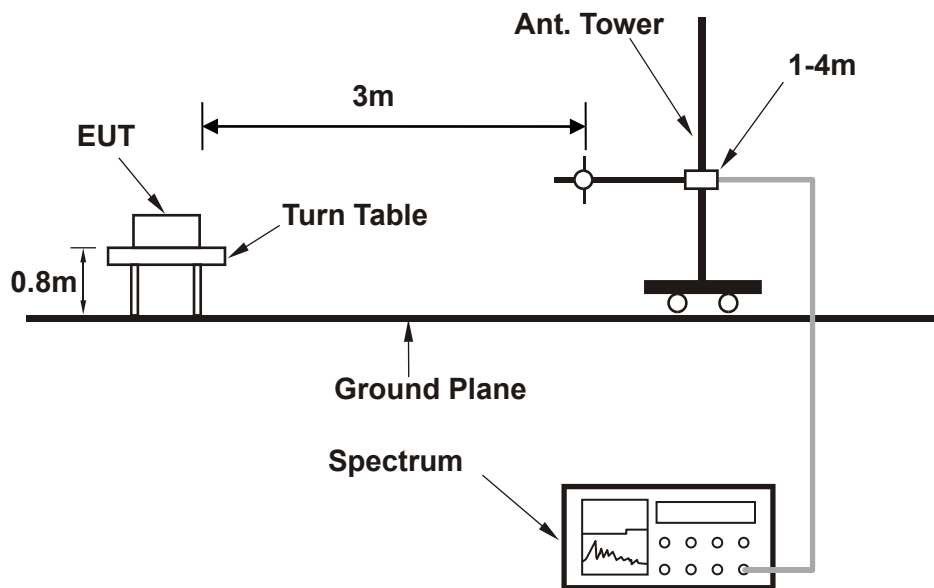



<Frequency Range above 1GHz>

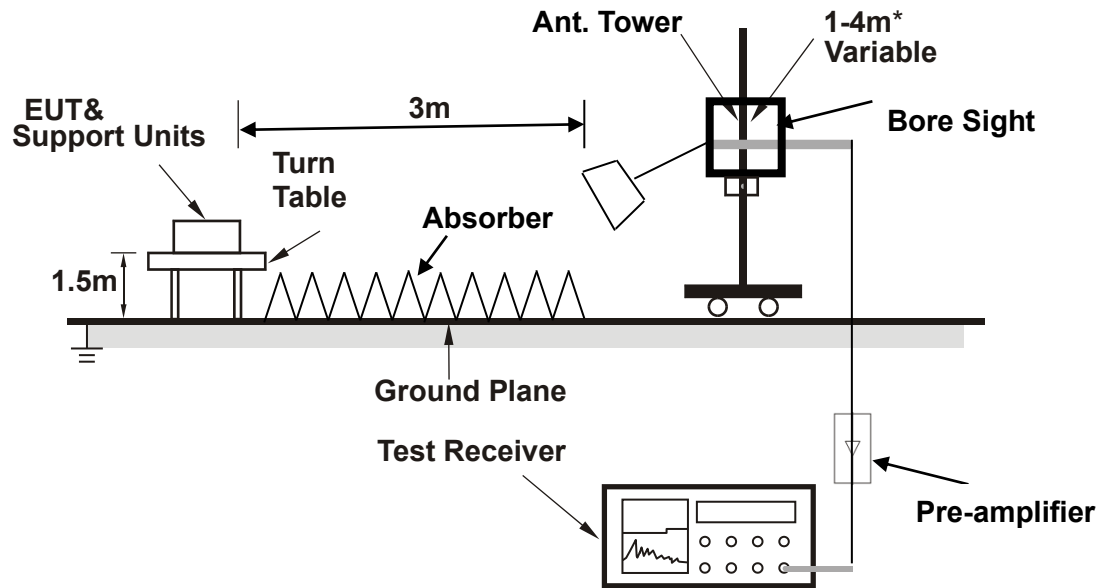

Note: Above 1G is a directional antenna

Depending on the EUT height and the antenna 3dB beamwidth both, refer to section 7.3 of CISPR 16-2-3.

For the actual test configuration, please refer to the attached file (Test Setup Photo).



3.6.5 TEST RESULTS

NOTE : The 9K~30MHz amplitude of spurious emissions attenuated more than 20 dB below the permissible value is not required in the report.

BELOW 1GHz WORST-CASE DATA

30 MHz – 1GHz data:

GSM1900(Ant4) (UP):

CHANNEL BANDWIDTH: 512 ~ 810

MODE	TX channel 661	FREQUENCY RANGE	Below 1000MHz
ENVIRONMENTAL CONDITIONS	23deg. C, 70%RH	INPUT POWER	AC 120V/60HZ
TESTED BY	Jace Hu		
ANTENNA POLARITY & TEST DISTANCE: HORIZONTAL AT 3 M			

	Freq	Level	Read Level	Limit Line	Over Limit	Factor	Remark	Pol/Phase
	MHz	dBm/m	dBm	dBm/m	dB	dB/m		
1	30.000	-58.51	-56.53	-13.00	-45.51	-1.98	Peak	Horizontal
2	88.200	-64.89	-52.16	-13.00	-51.89	-12.73	Peak	Horizontal
3	145.430	-65.45	-50.83	-13.00	-52.45	-14.62	Peak	Horizontal
4	180.350	-67.63	-51.29	-13.00	-54.63	-16.34	Peak	Horizontal
5	332.640	-68.79	-60.60	-13.00	-55.79	-8.19	Peak	Horizontal
6	803.090	-58.71	-63.80	-13.00	-45.71	5.09	Peak	Horizontal

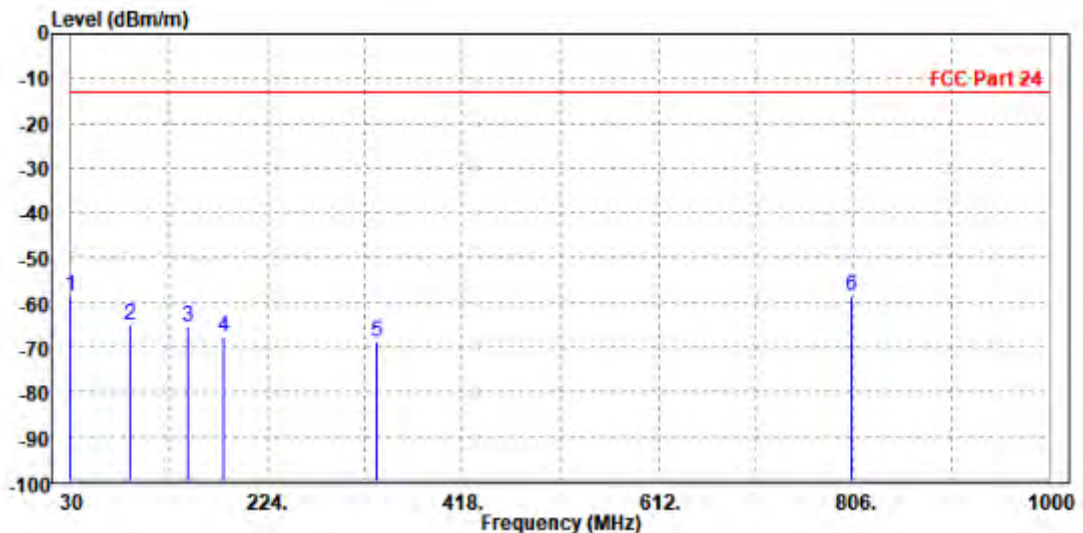



**BUREAU
VERITAS**

Test Report No.: W7L-240618W002RF06

MODE	TX channel 661	FREQUENCY RANGE	Below 1000MHz
ENVIRONMENTAL CONDITIONS	23deg. C, 70%RH	INPUT POWER	AC 120V/60HZ
TESTED BY	Jace Hu		
ANTENNA POLARITY & TEST DISTANCE: VERTICAL AT 3 M			

	Freq	Level	Read Level	Limit Line	Over Limit	Factor	Remark	Pol/Phase
	MHz	dBm/m	dBm	dBm/m	dB	dB/m		
1	44.550	-70.41	-50.06	-13.00	-57.41	-20.35	Peak	Vertical
2	84.320	-63.21	-44.93	-13.00	-50.21	-18.28	Peak	Vertical
3	136.700	-66.59	-51.08	-13.00	-53.59	-15.51	Peak	Vertical
4	167.740	-65.90	-55.02	-13.00	-52.90	-10.88	Peak	Vertical
5	302.570	-67.09	-63.66	-13.00	-54.09	-3.43	Peak	Vertical
6 PP	892.330	-51.56	-63.14	-13.00	-38.56	11.58	Peak	Vertical

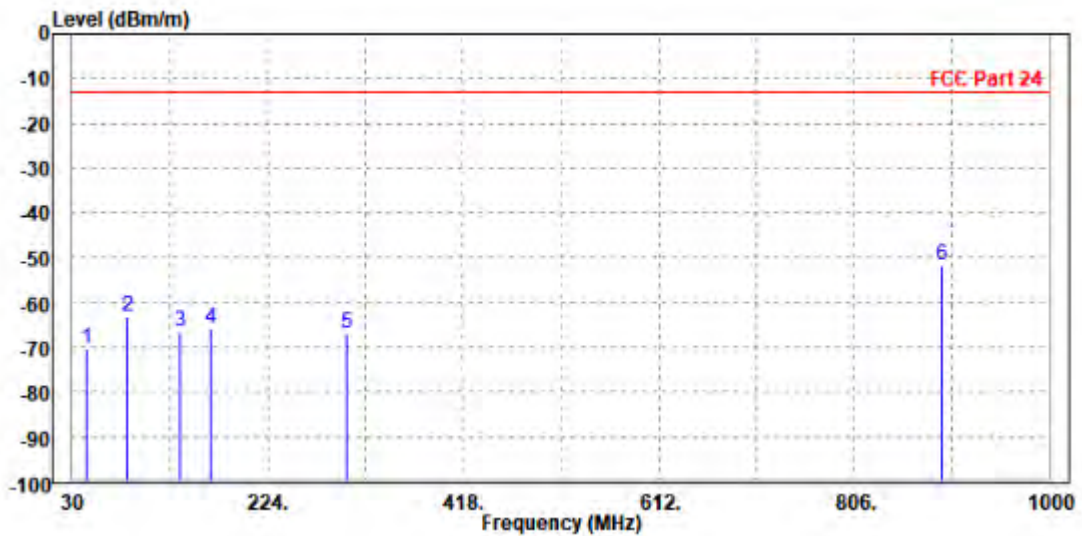



**BUREAU
VERITAS**

Test Report No.: W7L-240618W002RF06

ABOVE 1GHz DATA

Note: For higher frequency, the emission is too low to be detected.

WORST-CASE DATA

GSM 1900(Ant4) (UP):

CH 512

MODE	TX channel 512	FREQUENCY RANGE	Above 1000MHz
ENVIRONMENTAL CONDITIONS	23deg. C, 70%RH	INPUT POWER	AC 120V/60HZ
TESTED BY	Jace Hu		
ANTENNA POLARITY & TEST DISTANCE: HORIZONTAL AT 3 M			

	Freq	Level	Read Level	Limit Line	Over Limit	Factor	Remark	Pol/Phase
	MHz	dBm/m	dBm	dBm/m	dB	dB/m		
1	3700.000	-51.40	-59.80	-13.00	-38.40	8.40	Peak	Horizontal
2 PP	5551.000	-50.71	-62.51	-13.00	-37.71	11.80	Peak	Horizontal

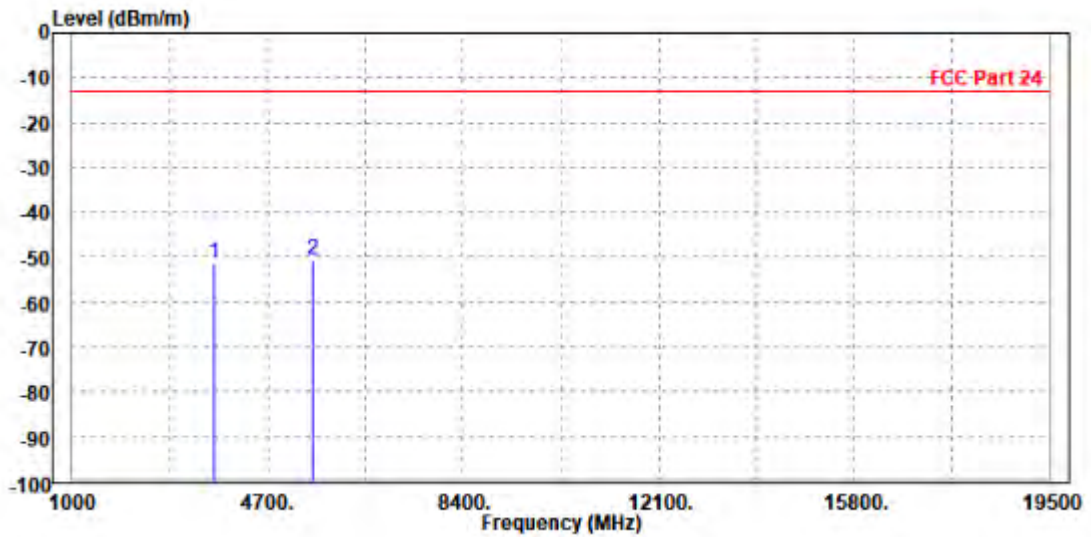



**BUREAU
VERITAS**

Test Report No.: W7L-240618W002RF06

MODE	TX channel 512	FREQUENCY RANGE	Above 1000MHz
ENVIRONMENTAL CONDITIONS	23deg. C, 70%RH	INPUT POWER	AC 120V/60HZ
TESTED BY	Jace Hu		
ANTENNA POLARITY & TEST DISTANCE: VERTICAL AT 3 M			

	Freq	Level	Read Level	Limit Line	Over Limit	Factor	Remark	Pol/Phase
	MHz	dBm/m	dBm	dBm/m	dB	dB/m		
1	3701.000	-50.87	-59.50	-13.00	-37.87	8.63	Peak	Vertical
2 PP	5550.000	-49.75	-62.08	-13.00	-36.75	12.33	Peak	Vertical

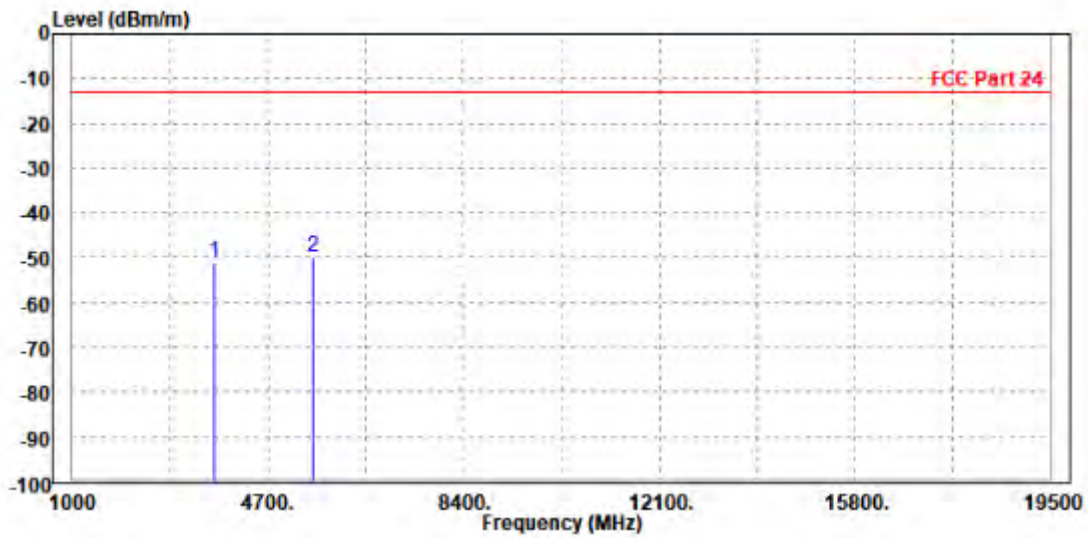



**BUREAU
VERITAS**

Test Report No.: W7L-240618W002RF06

CH 661

MODE	TX channel 661	FREQUENCY RANGE	Above 1000MHz
ENVIRONMENTAL CONDITIONS	23deg. C, 70%RH	INPUT POWER	AC 120V/60HZ
TESTED BY	Jace Hu		
ANTENNA POLARITY & TEST DISTANCE: HORIZONTAL AT 3 M			

	Freq	Level	Read Level	Limit Line	Over Limit	Factor	Remark	Pol/Phase
	MHz	dBm/m	dBm	dBm/m	dB	dB/m		
1 PP	3756.500	-43.34	-51.69	-13.00	-30.34	8.35	Peak	Horizontal
2	5640.000	-49.79	-61.60	-13.00	-36.79	11.81	Peak	Horizontal

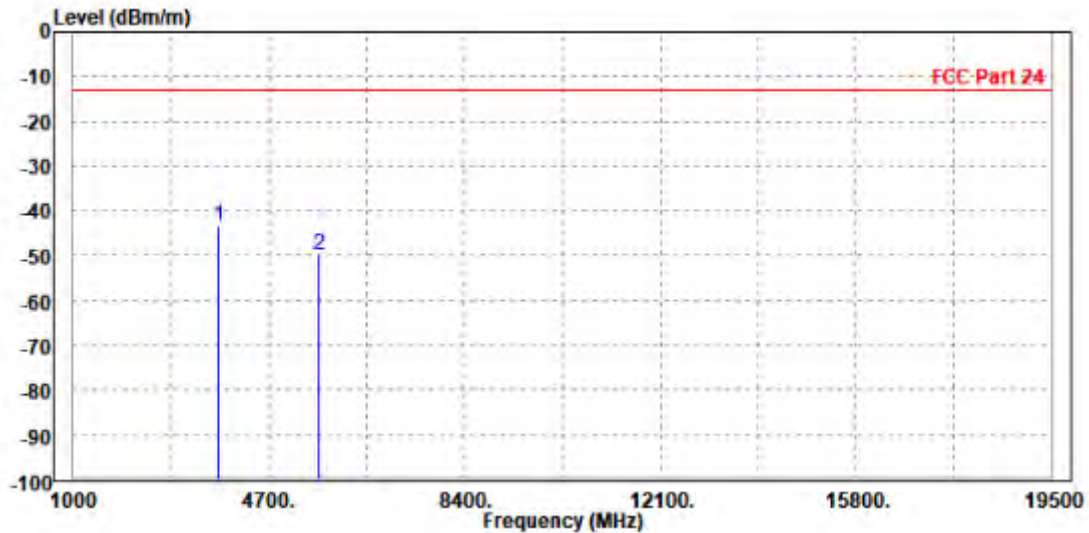



**BUREAU
VERITAS**

Test Report No.: W7L-240618W002RF06

MODE	TX channel 661	FREQUENCY RANGE	Above 1000MHz
ENVIRONMENTAL CONDITIONS	23deg. C, 70%RH	INPUT POWER	AC 120V/60HZ
TESTED BY	Jace Hu		
ANTENNA POLARITY & TEST DISTANCE: VERTICAL AT 3 M			

	Freq	Level	Read Level	Limit Line	Over Limit	Factor	Remark	Pol/Phase
	MHz	dBm/m	dBm	dBm/m	dB	dB/m		
1	3760.000	-51.15	-59.78	-13.00	-38.15	8.63	Peak	Vertical
2	PP 5643.500	-45.72	-58.04	-13.00	-32.72	12.32	Peak	Vertical

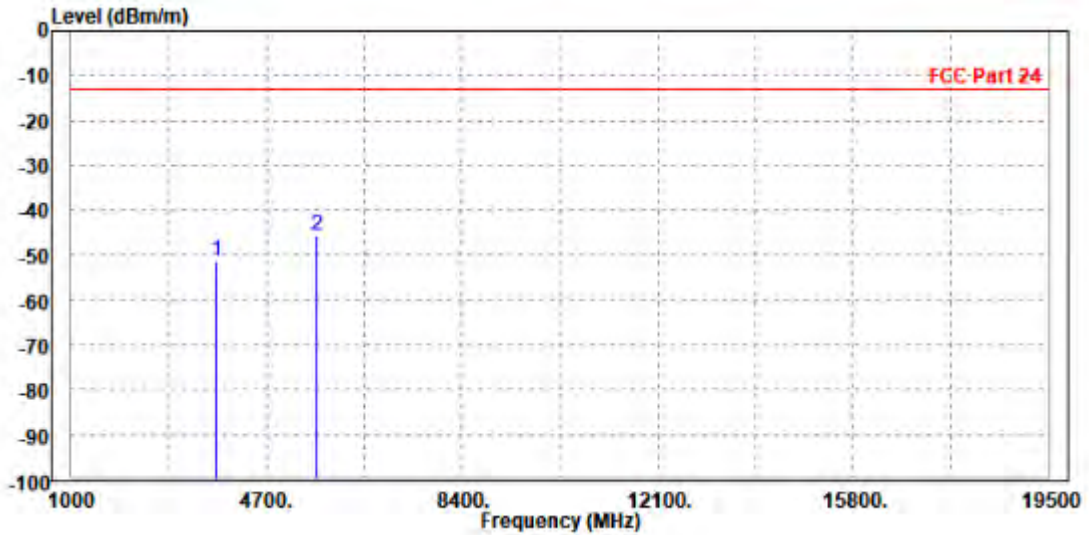



**BUREAU
VERITAS**

Test Report No.: W7L-240618W002RF06

CH 810

MODE	TX channel 810	FREQUENCY RANGE	Above 1000MHz
ENVIRONMENTAL CONDITIONS	23deg. C, 70%RH	INPUT POWER	AC 120V/60HZ
TESTED BY	Jace Hu		
ANTENNA POLARITY & TEST DISTANCE: HORIZONTAL AT 3 M			

	Freq	Level	Read Level	Limit Line	Over Limit	Factor	Remark	Pol/Phase
	MHz	dBm/m	dBm	dBm/m	dB	dB/m		
1 PP	3812.000	-44.65	-52.96	-13.00	-31.65	8.31	Peak	Horizontal
2	5727.000	-47.52	-59.34	-13.00	-34.52	11.82	Peak	Horizontal

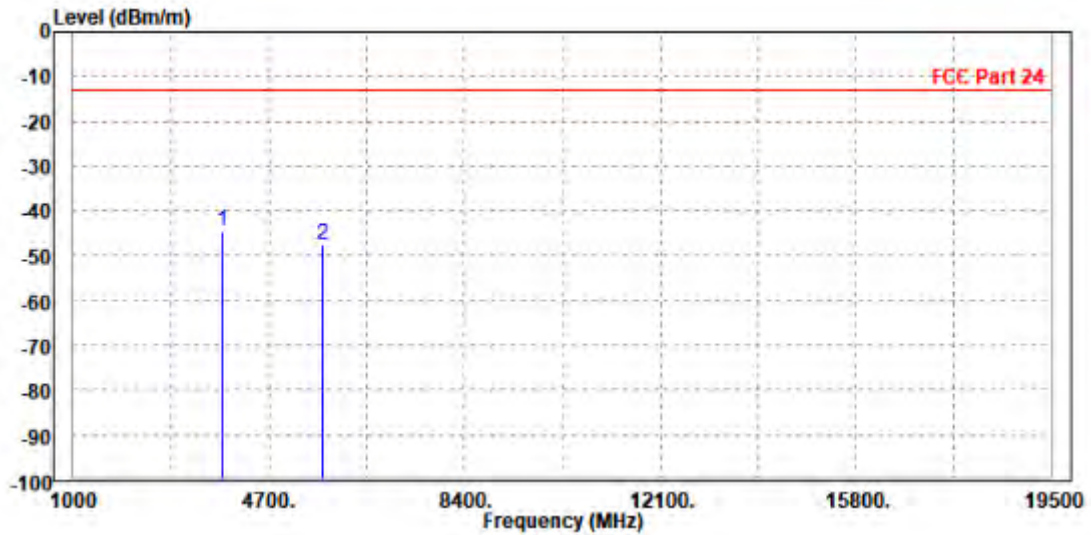



**BUREAU
VERITAS**

Test Report No.: W7L-240618W002RF06

MODE	TX channel 810	FREQUENCY RANGE	Above 1000MHz
ENVIRONMENTAL CONDITIONS	23deg. C, 70%RH	INPUT POWER	AC 120V/60HZ
TESTED BY	Jace Hu		
ANTENNA POLARITY & TEST DISTANCE: VERTICAL AT 3 M			

	Freq	Level	Read Level	Limit Line	Over Limit	Factor	Remark	Pol/Phase
	MHz	dBm/m	dBm	dBm/m	dB	dB/m		
1	3818.000	-49.49	-58.12	-13.00	-36.49	8.63	Peak	Vertical
2	PP 5736.000	-42.76	-55.07	-13.00	-29.76	12.31	Peak	Vertical

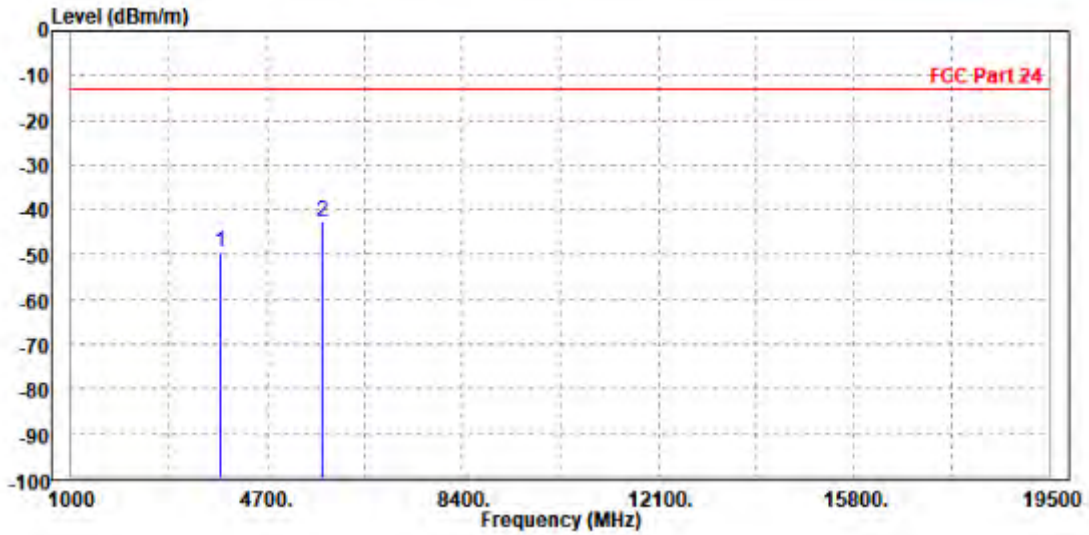



BUREAU VERITAS

Test Report No.: W7L-240618W002RF06

EDGE 1900(Ant1) (DOWN):

CH 512

MODE	TX channel 512	FREQUENCY RANGE	Above 1000MHz
ENVIRONMENTAL CONDITIONS	23deg. C, 70%RH	INPUT POWER	AC 120V/60HZ
TESTED BY	Jace Hu		
ANTENNA POLARITY & TEST DISTANCE: HORIZONTAL AT 3 M			

	Freq	Level	Read Level	Limit Line	Over Limit	Factor	Remark	Pol/Phase
	MHz	dBm/m	dBm	dBm/m	dB	dB/m		
1	PP 3701.000	-41.65	-50.05	-13.00	-28.65	8.40	Peak	Horizontal
2	5550.000	-48.36	-60.16	-13.00	-35.36	11.80	Peak	Horizontal

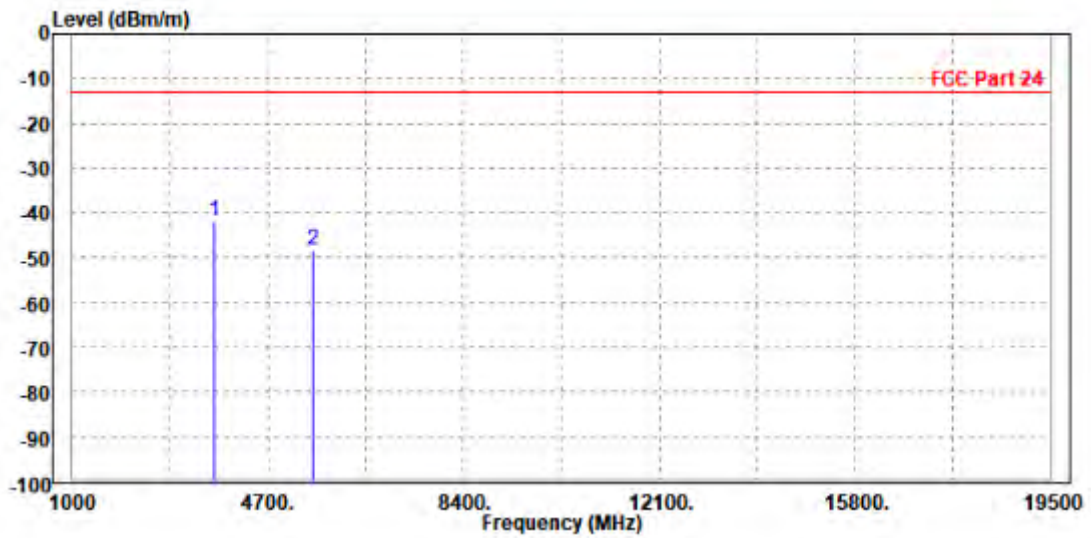



**BUREAU
VERITAS**

Test Report No.: W7L-240618W002RF06

MODE	TX channel 512	FREQUENCY RANGE	Above 1000MHz
ENVIRONMENTAL CONDITIONS	23deg. C, 70%RH	INPUT POWER	AC 120V/60HZ
TESTED BY	Jace Hu		
ANTENNA POLARITY & TEST DISTANCE: VERTICAL AT 3 M			

	Freq	Level	Read Level	Limit Line	Over Limit	Factor	Remark	Pol/Phase
	MHz	dBm/m	dBm	dBm/m	dB	dB/m		
1	3700.000	-48.36	-56.99	-13.00	-35.36	8.63	Peak	Vertical
2 PP	5551.000	-43.92	-56.25	-13.00	-30.92	12.33	Peak	Vertical

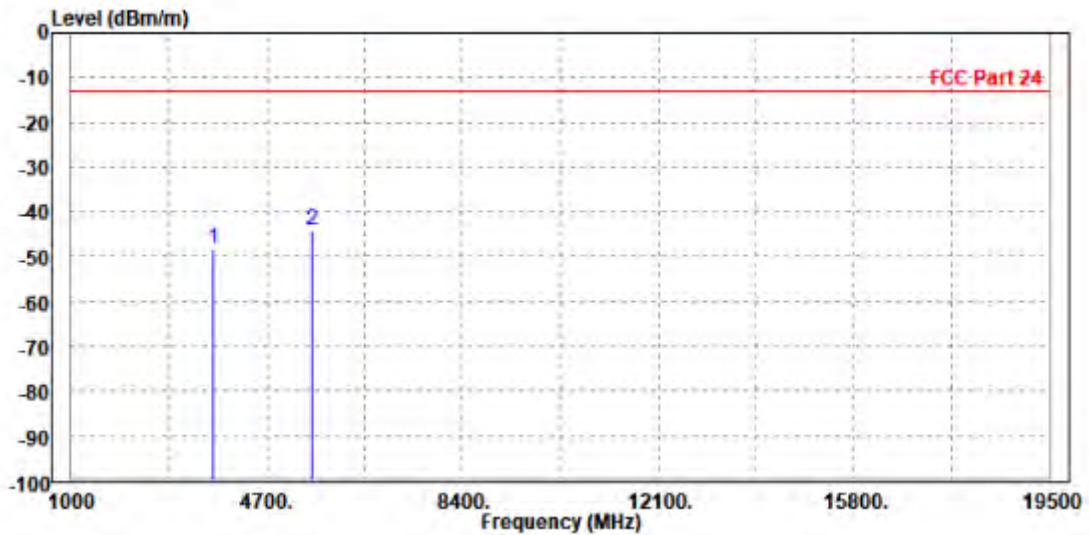



**BUREAU
VERITAS**

Test Report No.: W7L-240618W002RF06

CH 661

MODE	TX channel 661	FREQUENCY RANGE	Above 1000MHz
ENVIRONMENTAL CONDITIONS	23deg. C, 70%RH	INPUT POWER	AC 120V/60HZ
TESTED BY	Jace Hu		
ANTENNA POLARITY & TEST DISTANCE: HORIZONTAL AT 3 M			

	Freq	Level	Read Level	Limit Line	Over Limit	Factor	Remark	Pol/Phase
	MHz	dBm/m	dBm	dBm/m	dB	dB/m		
1	PP 3756.500	-44.09	-52.44	-13.00	-31.09	8.35	Peak	Horizontal
2	5640.000	-49.52	-61.33	-13.00	-36.52	11.81	Peak	Horizontal

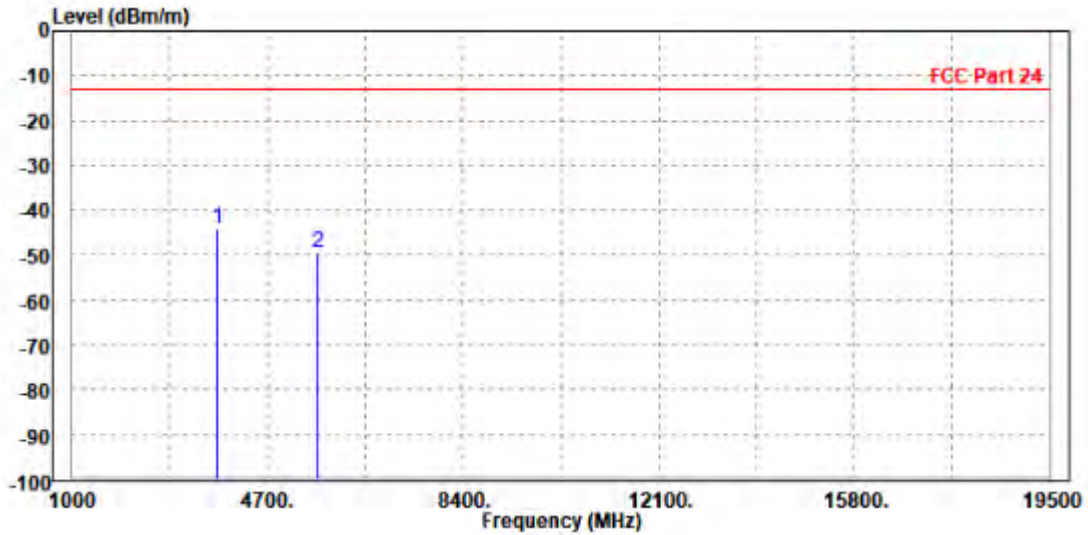



**BUREAU
VERITAS**

Test Report No.: W7L-240618W002RF06

MODE	TX channel 661	FREQUENCY RANGE	Above 1000MHz
ENVIRONMENTAL CONDITIONS	23deg. C, 70%RH	INPUT POWER	AC 120V/60HZ
TESTED BY	Jace Hu		
ANTENNA POLARITY & TEST DISTANCE: VERTICAL AT 3 M			

	Freq	Level	Read Level	Limit Line	Over Limit	Factor	Remark	Pol/Phase
	MHz	dBm/m	dBm	dBm/m	dB	dB/m		
1	3760.000	-50.10	-58.73	-13.00	-37.10	8.63	Peak	Vertical
2 PP	5643.500	-46.46	-58.78	-13.00	-33.46	12.32	Peak	Vertical

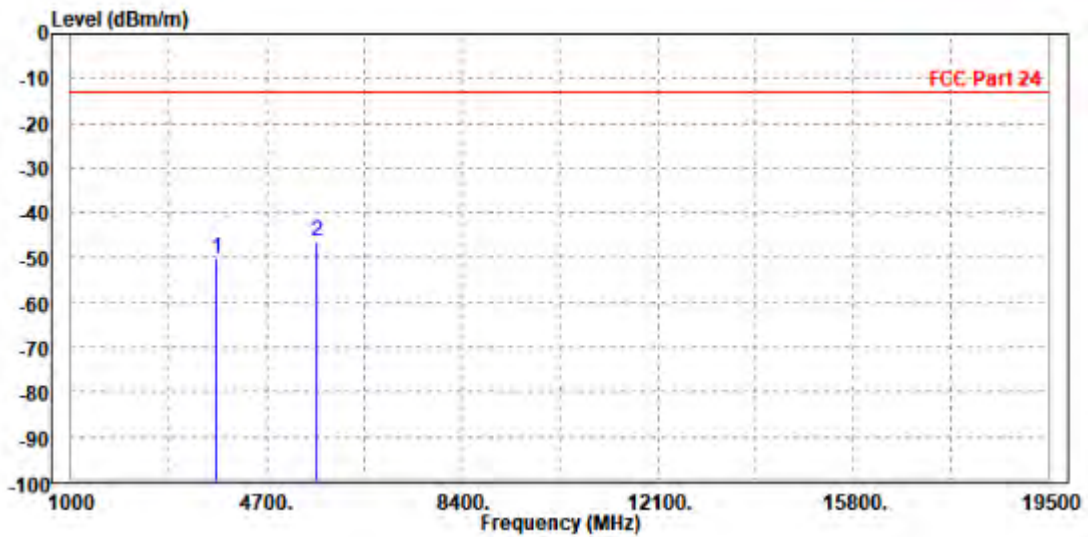



**BUREAU
VERITAS**

Test Report No.: W7L-240618W002RF06

CH 810

MODE	TX channel 810	FREQUENCY RANGE	Above 1000MHz
ENVIRONMENTAL CONDITIONS	23deg. C, 70%RH	INPUT POWER	AC 120V/60HZ
TESTED BY	Jace Hu		
ANTENNA POLARITY & TEST DISTANCE: HORIZONTAL AT 3 M			

	Freq	Level	Read Level	Limit Line	Over Limit	Factor	Remark	Pol/Phase
	MHz	dBm/m	dBm	dBm/m	dB	dB/m		
1 PP	3818.000	-43.80	-52.11	-13.00	-30.80	8.31	Peak	Horizontal
2	5736.000	-48.12	-59.94	-13.00	-35.12	11.82	Peak	Horizontal

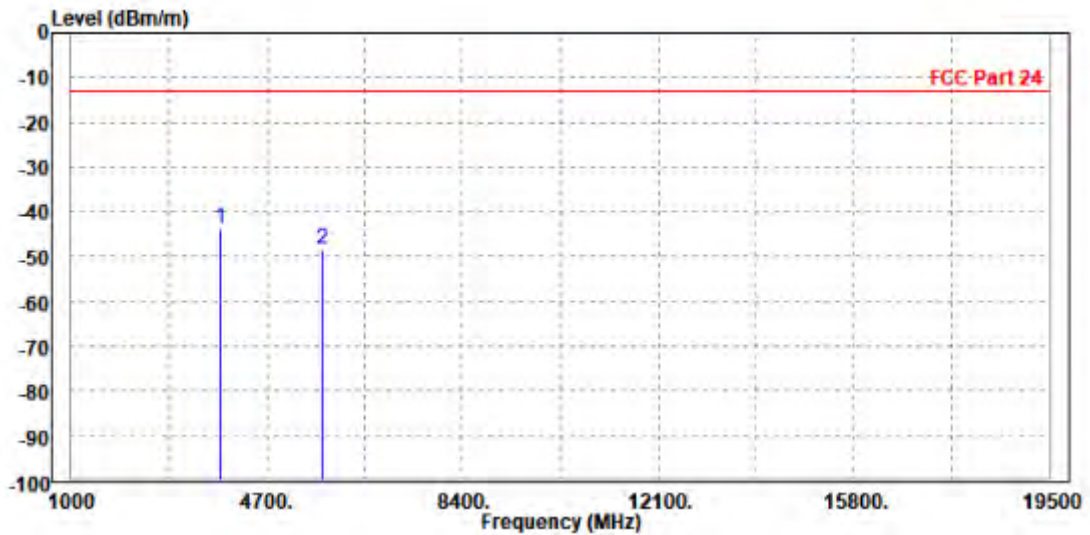



**BUREAU
VERITAS**

Test Report No.: W7L-240618W002RF06

MODE	TX channel 810	FREQUENCY RANGE	Above 1000MHz
ENVIRONMENTAL CONDITIONS	23deg. C, 70%RH	INPUT POWER	AC 120V/60HZ
TESTED BY	Jace Hu		
ANTENNA POLARITY & TEST DISTANCE: VERTICAL AT 3 M			

	Freq	Level	Read Level	Limit Line	Over Limit	Factor	Remark	Pol/Phase
	MHz	dBm/m	dBm	dBm/m	dB	dB/m		
1	3812.000	-47.88	-56.51	-13.00	-34.88	8.63	Peak	Vertical
2 PP	5727.000	-47.16	-59.47	-13.00	-34.16	12.31	Peak	Vertical

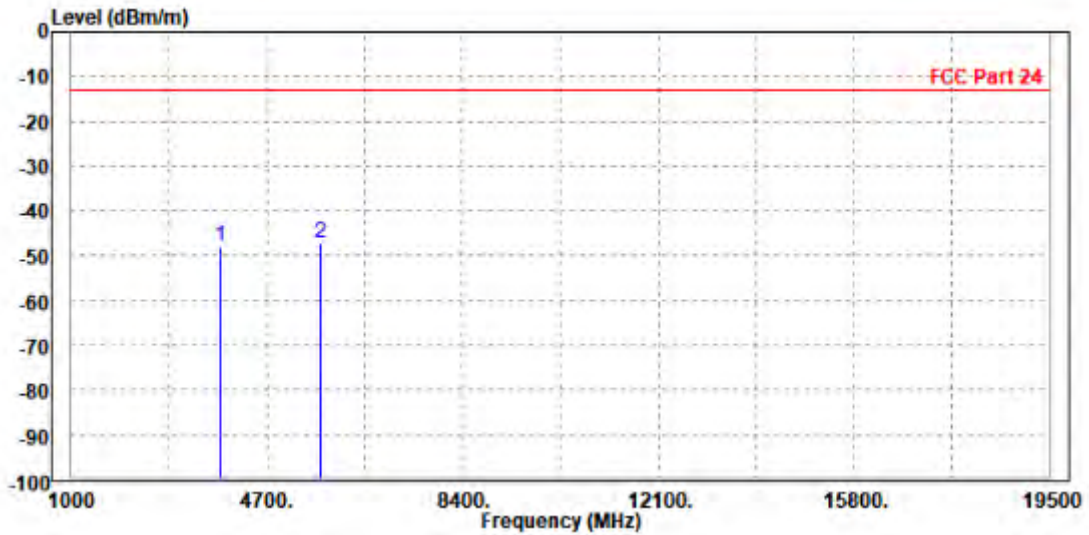



**BUREAU
VERITAS**

Test Report No.: W7L-240618W002RF06

WCDMA Band II(Ant1) (DOWN):

CH 9262

MODE	TX channel 9262	FREQUENCY RANGE	Above 1000MHz
ENVIRONMENTAL CONDITIONS	23deg. C, 70%RH	INPUT POWER	AC 120V/60HZ
TESTED BY	Jace Hu		
ANTENNA POLARITY & TEST DISTANCE: HORIZONTAL AT 3 M			

	Freq	Level	Read Level	Limit Line	Over Limit	Factor	Remark	Pol/Phase
	MHz	dBm/m	dBm	dBm/m	dB	dB/m		
1	3701.000	-51.76	-60.16	-13.00	-38.76	8.40	Peak	Horizontal
2 PP	5557.200	-49.61	-61.41	-13.00	-36.61	11.80	Peak	Horizontal

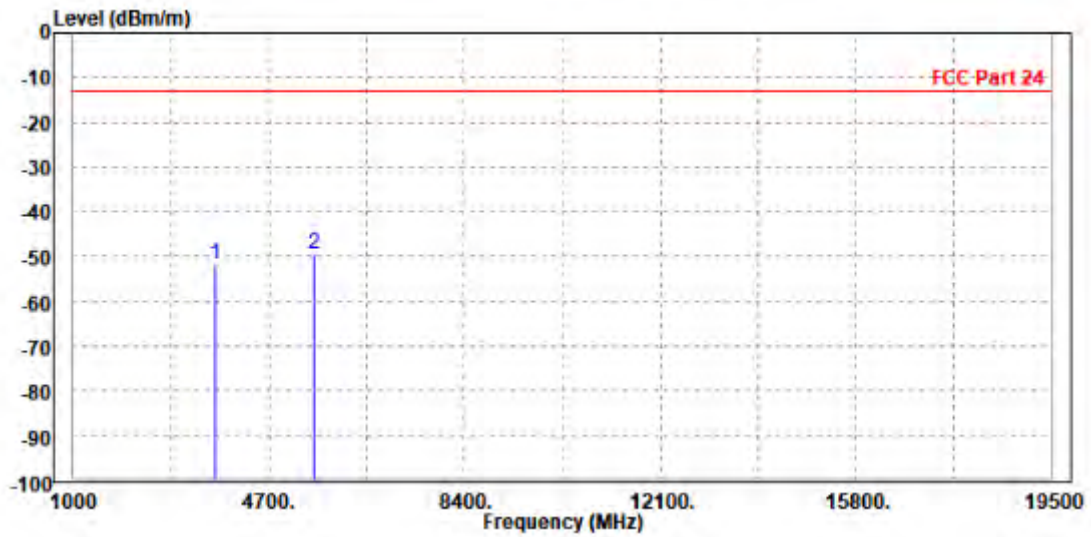



**BUREAU
VERITAS**

Test Report No.: W7L-240618W002RF06

MODE	TX channel 9262	FREQUENCY RANGE	Above 1000MHz
ENVIRONMENTAL CONDITIONS	23deg. C, 70%RH	INPUT POWER	AC 120V/60HZ
TESTED BY	Jace Hu		
ANTENNA POLARITY & TEST DISTANCE: VERTICAL AT 3 M			

	Freq	Level	Read Level	Limit Line	Over Limit	Factor	Remark	Pol/Phase
	MHz	dBm/m	dBm	dBm/m	dB	dB/m		
1	3704.800	-51.67	-60.30	-13.00	-38.67	8.63	Peak	Vertical
2 PP	5551.000	-49.52	-61.85	-13.00	-36.52	12.33	Peak	Vertical

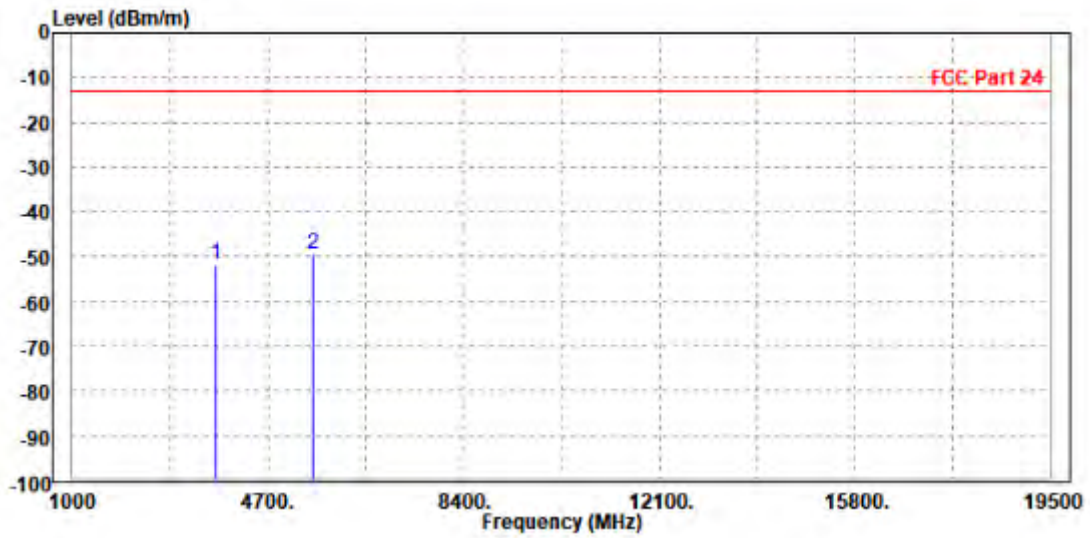



**BUREAU
VERITAS**

Test Report No.: W7L-240618W002RF06

CH 9400

MODE	TX channel 9400	FREQUENCY RANGE	Above 1000MHz
ENVIRONMENTAL CONDITIONS	23deg. C, 70%RH	INPUT POWER	AC 120V/60HZ
TESTED BY	Jace Hu		
ANTENNA POLARITY & TEST DISTANCE: HORIZONTAL AT 3 M			

	Freq	Level	Read Level	Limit Line	Over Limit	Factor	Remark	Pol/Phase
	MHz	dBm/m	dBm	dBm/m	dB	dB/m		
1	3760.000	-50.40	-58.75	-13.00	-37.40	8.35	Peak	Horizontal
2 PP	5643.500	-49.89	-61.70	-13.00	-36.89	11.81	Peak	Horizontal

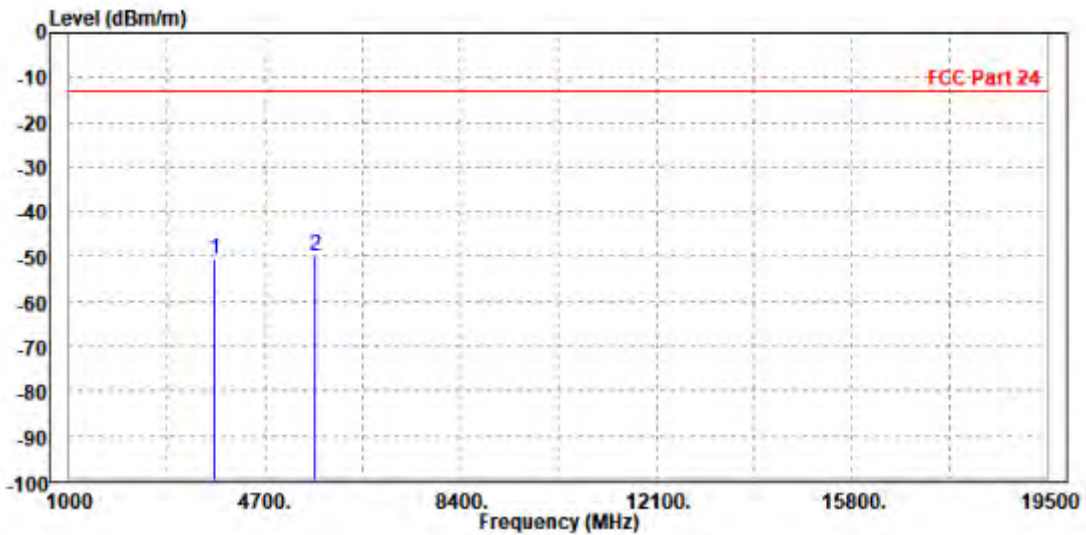



**BUREAU
VERITAS**

Test Report No.: W7L-240618W002RF06

MODE	TX channel 9400	FREQUENCY RANGE	Above 1000MHz
ENVIRONMENTAL CONDITIONS	23deg. C, 70%RH	INPUT POWER	AC 120V/60HZ
TESTED BY	Jace Hu		
ANTENNA POLARITY & TEST DISTANCE: VERTICAL AT 3 M			

	Freq	Level	Read Level	Limit Line	Over Limit	Factor	Remark	Pol/Phase
	MHz	dBm/m	dBm	dBm/m	dB	dB/m		
1	3756.500	-49.32	-57.95	-13.00	-36.32	8.63	Peak	Vertical
2 PP	5640.000	-48.12	-60.44	-13.00	-35.12	12.32	Peak	Vertical

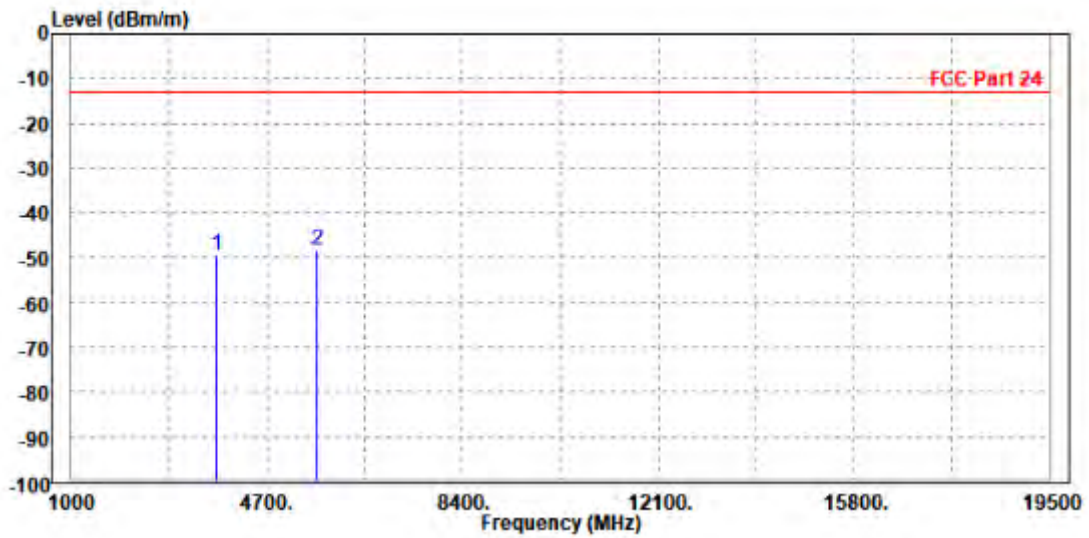



BUREAU VERITAS

Test Report No.: W7L-240618W002RF06

CH 9538

MODE	TX channel 9538	FREQUENCY RANGE	Above 1000MHz
ENVIRONMENTAL CONDITIONS	23deg. C, 70%RH	INPUT POWER	AC 120V/60HZ
TESTED BY	Jace Hu		
ANTENNA POLARITY & TEST DISTANCE: HORIZONTAL AT 3 M			

	Freq	Level	Read Level	Limit Line	Over Limit	Factor	Remark	Pol/Phase
	MHz	dBm/m	dBm	dBm/m	dB	dB/m		
1	3815.200	-50.36	-58.67	-13.00	-37.36	8.31	Peak	Horizontal
2 PP	5717.500	-49.98	-61.80	-13.00	-36.98	11.82	Peak	Horizontal

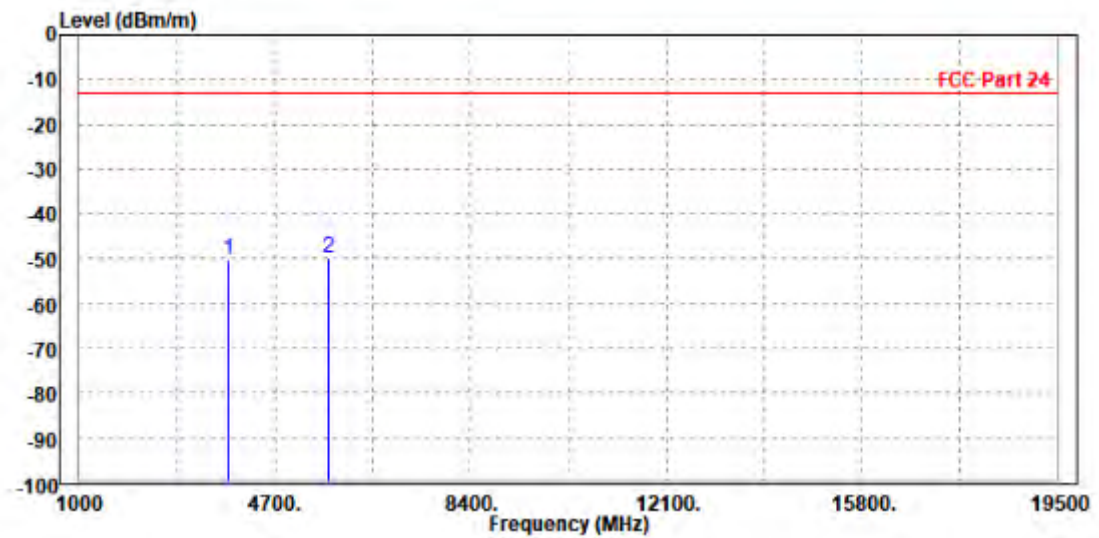



**BUREAU
VERITAS**

Test Report No.: W7L-240618W002RF06

MODE	TX channel 9538	FREQUENCY RANGE	Above 1000MHz
ENVIRONMENTAL CONDITIONS	23deg. C, 70%RH	INPUT POWER	AC 120V/60HZ
TESTED BY	Jace Hu		
ANTENNA POLARITY & TEST DISTANCE: VERTICAL AT 3 M			

	Freq	Level	Read Level	Limit Line	Over Limit	Factor	Remark	Pol/Phase
	MHz	dBm/m	dBm	dBm/m	dB	dB/m		
1	3812.000	-51.58	-60.21	-13.00	-38.58	8.63	Peak	Vertical
2 PP	5722.800	-50.21	-62.52	-13.00	-37.21	12.31	Peak	Vertical

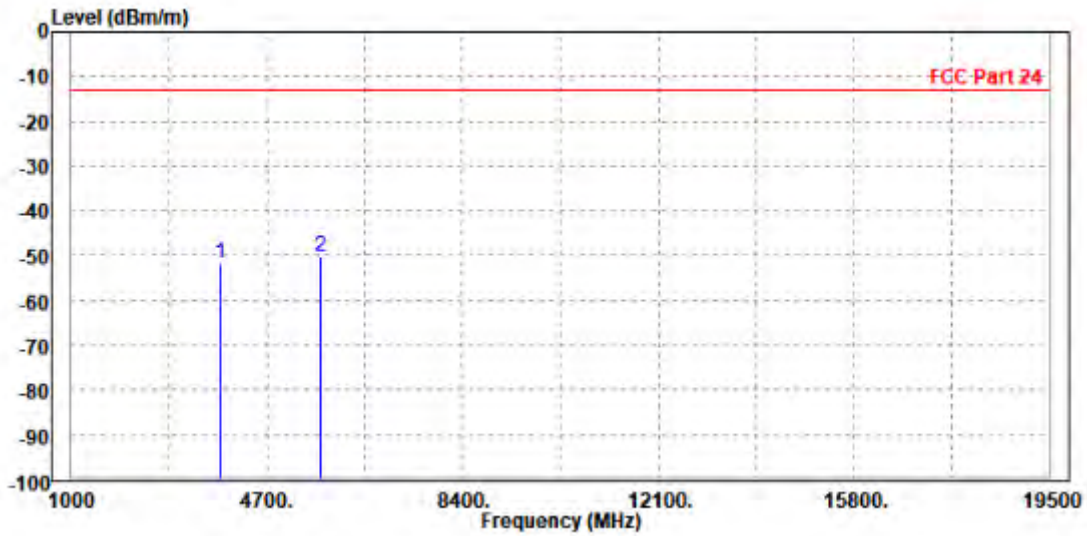



**BUREAU
VERITAS**

Test Report No.: W7L-240618W002RF06

LTE Band 2(Ant1) (DOWN):

CHANNEL BANDWIDTH: 1.4MHz / QPSK

MODE	TX channel 18900	FREQUENCY RANGE	Above 1000MHz
ENVIRONMENTAL CONDITIONS	23deg. C, 70%RH	INPUT POWER	AC 120V/60Hz
TESTED BY	Jace Hu		
ANTENNA POLARITY & TEST DISTANCE: HORIZONTAL AT 3 M			

	Freq	Level	Read Level	Limit Line	Over Limit	Factor	Remark	Pol/Phase
	MHz	dBm/m	dBm	dBm/m	dB	dB/m		
1	3756.500	-51.19	-59.54	-13.00	-38.19	8.35	Peak	Horizontal
2 PP	5640.000	-50.58	-62.39	-13.00	-37.58	11.81	Peak	Horizontal

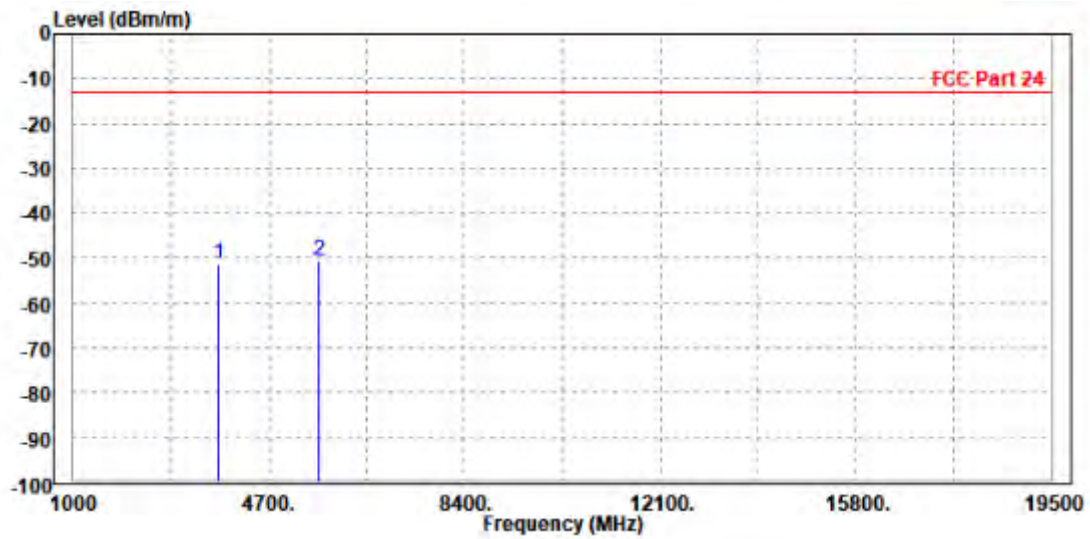



**BUREAU
VERITAS**

Test Report No.: W7L-240618W002RF06

MODE	TX channel 18900	FREQUENCY RANGE	Above 1000MHz
ENVIRONMENTAL CONDITIONS	23deg. C, 70%RH	INPUT POWER	AC 120V/60Hz
TESTED BY	Jace Hu		
ANTENNA POLARITY & TEST DISTANCE: VERTICAL AT 3 M			

	Freq	Level	Read Level	Limit Line	Over Limit	Factor	Remark	Pol/Phase
	MHz	dBm/m	dBm	dBm/m	dB	dB/m		
1	3760.000	-51.47	-60.10	-13.00	-38.47	8.63	Peak	Vertical
2 PP	5643.500	-50.53	-62.85	-13.00	-37.53	12.32	Peak	Vertical

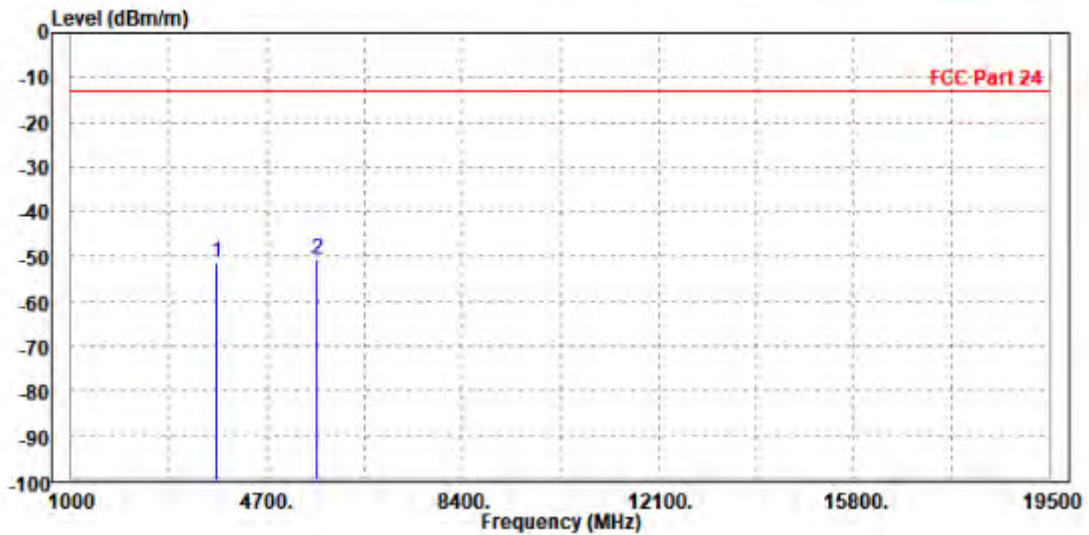



**BUREAU
VERITAS**

Test Report No.: W7L-240618W002RF06

CHANNEL BANDWIDTH: 3MHz / QPSK

MODE	TX channel 18900	FREQUENCY RANGE	Above 1000MHz
ENVIRONMENTAL CONDITIONS	23deg. C, 70%RH	INPUT POWER	AC 120V/60Hz
TESTED BY	Jace Hu		
ANTENNA POLARITY & TEST DISTANCE: HORIZONTAL AT 3 M			

	Freq	Level	Read Level	Limit Line	Over Limit	Factor	Remark	Pol/Phase
	MHz	dBm/m	dBm	dBm/m	dB	dB/m		
1	3756.500	-50.20	-58.55	-13.00	-37.20	8.35	Peak	Horizontal
2 PP	5640.000	-49.40	-61.21	-13.00	-36.40	11.81	Peak	Horizontal

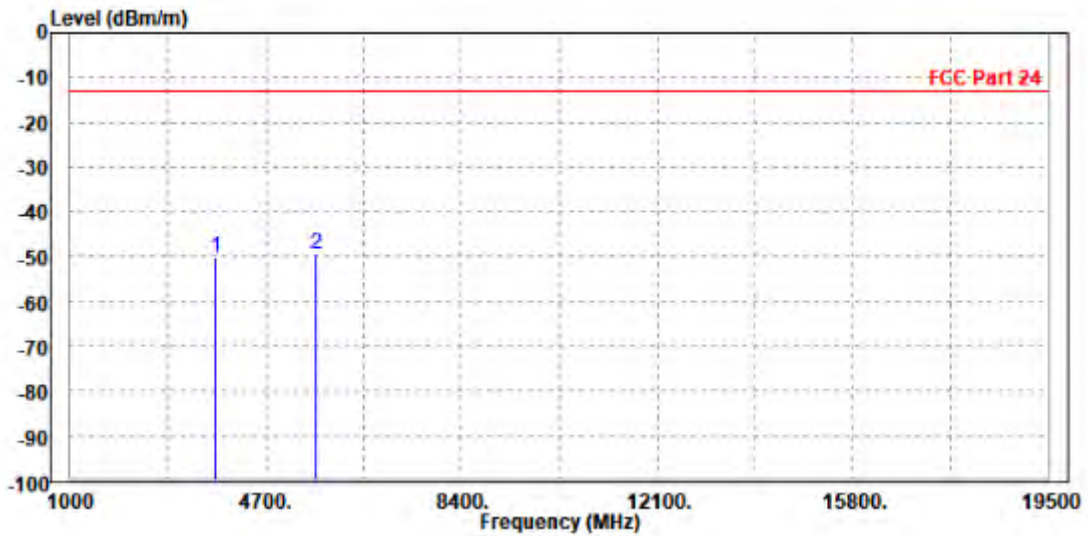



**BUREAU
VERITAS**

Test Report No.: W7L-240618W002RF06

MODE	TX channel 18900	FREQUENCY RANGE	Above 1000MHz
ENVIRONMENTAL CONDITIONS	23deg. C, 70%RH	INPUT POWER	AC 120V/60Hz
TESTED BY	Jace Hu		
ANTENNA POLARITY & TEST DISTANCE: VERTICAL AT 3 M			

	Freq	Level	Read Level	Limit Line	Over Limit	Factor	Remark	PoI/Phase
	MHz	dBm/m	dBm	dBm/m	dB	dB/m		
1	3760.000	-51.31	-59.94	-13.00	-38.31	8.63	Peak	Vertical
2	PP 5643.500	-49.95	-62.27	-13.00	-36.95	12.32	Peak	Vertical

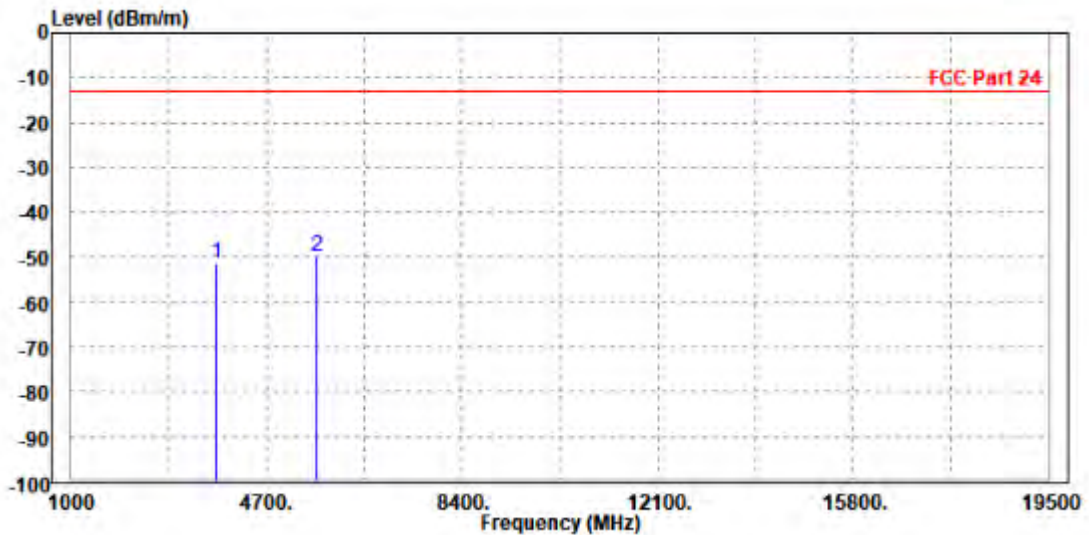



**BUREAU
VERITAS**

Test Report No.: W7L-240618W002RF06

CHANNEL BANDWIDTH: 5MHz / QPSK

MODE	TX channel 18900	FREQUENCY RANGE	Above 1000MHz
ENVIRONMENTAL CONDITIONS	23deg. C, 70%RH	INPUT POWER	AC 120V/60Hz
TESTED BY	Jace Hu		
ANTENNA POLARITY & TEST DISTANCE: HORIZONTAL AT 3 M			

	Freq	Level	Read Level	Limit Line	Over Limit	Factor	Remark	Pol/Phase
	MHz	dBm/m	dBm	dBm/m	dB	dB/m		
1	3760.000	-51.99	-60.34	-13.00	-38.99	8.35	Peak	Horizontal
2 PP	5643.500	-50.48	-62.29	-13.00	-37.48	11.81	Peak	Horizontal

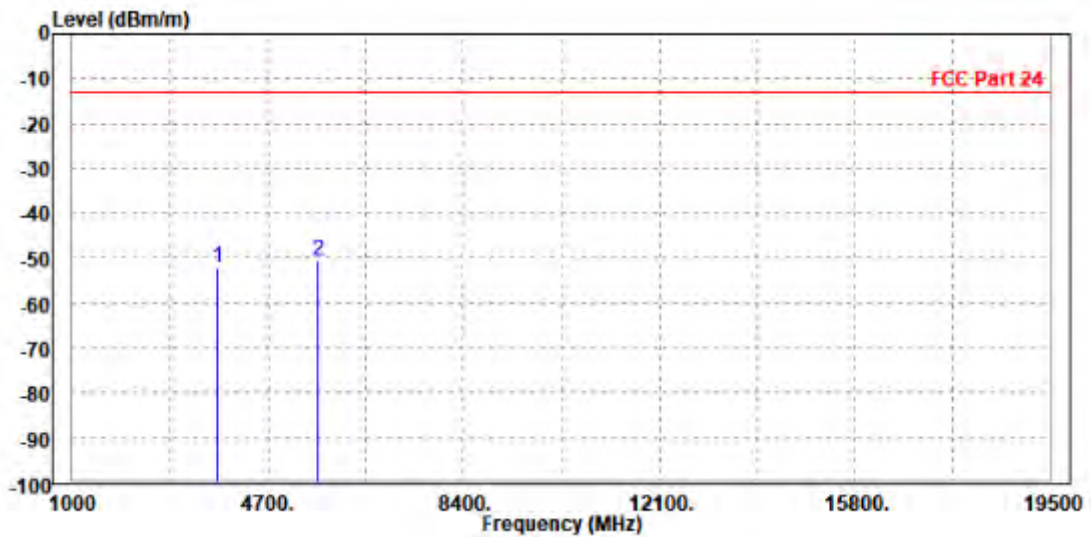



**BUREAU
VERITAS**

Test Report No.: W7L-240618W002RF06

MODE	TX channel 18900	FREQUENCY RANGE	Above 1000MHz
ENVIRONMENTAL CONDITIONS	23deg. C, 70%RH	INPUT POWER	AC 120V/60Hz
TESTED BY	Jace Hu		
ANTENNA POLARITY & TEST DISTANCE: VERTICAL AT 3 M			

	Freq	Level	Read Level	Limit Line	Over Limit	Factor	Remark	Pol/Phase
	MHz	dBm/m	dBm	dBm/m	dB	dB/m		
1	3756.500	-52.67	-61.30	-13.00	-39.67	8.63	Peak	Vertical
2 PP	5640.000	-49.47	-61.79	-13.00	-36.47	12.32	Peak	Vertical

