

RF TEST REPORT

Applicant	Xiaomi Communications Co., Ltd.
FCC ID	2AFZZPCA6G
Product	Mobile Phone
Brand	POCO
Model	2312FPCA6G
Report No.	R2309A0988-R4
Issue Date	October 26, 2023

TA Technology (Shanghai) Co., Ltd. tested the above equipment in accordance with the requirements in **FCC CFR47 Part 2 (2022)/ FCC CFR 47 Part 90S (2022)**. The test results show that the equipment tested is capable of demonstrating compliance with the requirements as documented in this report.

Prepared by: Xu Ying

Approved by: Xu Kai

TA Technology (Shanghai) Co., Ltd.

Building 3, No.145, Jintang Rd, Pudong Shanghai, P.R.China

TEL: +86-021-50791141/2/3

FAX: +86-021-50791141/2/3-8000

TABLE OF CONTENT

1. Test Laboratory	4
1.1. Notes of the Test Report	4
1.2. Test Facility	4
1.3. Testing Location	4
2. General Description of Equipment Under Test	5
2.1. Applicant and Manufacturer Information	5
2.2. General Information	5
3. Applied Standards	6
4. Test Configuration	7
5. Test Case	8
5.1. RF Power Output and Effective Radiated Power	8
5.2. Occupied Bandwidth	9
5.3. Emission Mask	10
5.4. Peak-to-Average Power Ratio (PAPR)	11
5.5. Frequency Stability	12
5.6. Spurious Emissions at Antenna Terminals	14
5.7. Radiated Spurious Emission	16
6. Test Results	19
6.1. RF Power Output and Effective Radiated Power	19
6.2. Occupied Bandwidth	30
6.3. Emission Mask	37
6.4. Peak-to-Average Power Ratio (PAPR)	45
6.5. Frequency Stability	46
6.6. Spurious Emissions at Antenna Terminals	48
6.7. Radiated Spurious Emission	51
7. Main Test Instruments	55
ANNEX A: The EUT Appearance	56
ANNEX B: Test Setup Photos	57
ANNEX C: Product Change Description	58

Summary of Measurement Results

No.	Test Case	Clause in FCC rules	Verdict
1	RF Power Output and Effective Radiated Power	2.1046/90.635(b)	PASS
2	Occupied Bandwidth	2.1049/ 90.209	PASS
3	Emission Masks	2.1051 / 90.691	PASS
4	Peak-to-Average Power Ratio	KDB 971168 D01(5.7)	PASS
5	Frequency Stability	2.1055 / 90.213	PASS
6	Spurious Emissions at Antenna Terminals	2.1051 / 90.691	PASS
7	Radiated Spurious Emission	2.1053 /90.691	PASS

Date of Testing: September 23, 2023 ~ October 12, 2023

Date of Sample Received: September 20, 2023

Note: PASS: The EUT complies with the essential requirements in the standard.

FAIL: The EUT does not comply with the essential requirements in the standard.

All indications of Pass/Fail in this report are opinions expressed by TA Technology (Shanghai) Co., Ltd. based on interpretations and/or observations of test results. Measurement Uncertainties were not taken into account and are published for informational purposes only.

2312FPCA6G (Report No.: R2309A0988-R4) is a variant model of 23117RA68G (Report No.: R2309A0986-R4).

The difference between the two models is shown in the table below:

Item	Original	Variant
Brand	Redmi	POCO
Model	23117RA68G	2312FPCA6G
Camera(back) Spec	200M+OIS+8M uw	64M+OIS+8M uw
Battery cover material (the thickness are same)	Glass (thickness: 0.68mm)	PC+PMMA (thickness: 0.71mm)
Others	The same	

There is no test for variant in this report. Test values all duplicated from original report.

The detailed product change description please refers to the *Difference Declaration Letter*.

1. Test Laboratory

1.1. Notes of the Test Report

This report shall not be reproduced in full or partial, without the written approval of **TA Technology (Shanghai) Co., Ltd.** The results documented in this report apply only to the tested sample, under the conditions and modes of operation as described herein .Measurement Uncertainties were not taken into account and are published for informational purposes only. This report is written to support regulatory compliance of the applicable standards stated above.

1.2. Test Facility

FCC (Designation number: CN1179, Test Firm Registration Number: 446626)

TA Technology (Shanghai) Co., Ltd. has been listed on the US Federal Communications Commission list of test facilities recognized to perform electromagnetic emissions measurements.

A2LA (Certificate Number: 3857.01)

TA Technology (Shanghai) Co., Ltd. has been listed by American Association for Laboratory Accreditation to perform electromagnetic emission measurement.

1.3. Testing Location

Company: TA Technology (Shanghai) Co., Ltd.
 Address: Building 3, No.145, Jintang Rd, Pudong Shanghai, P.R.China
 City: Shanghai
 Post code: 201201
 Country: P. R. China
 Contact: Xu Kai
 Telephone: +86-021-50791141/2/3
 Fax: +86-021-50791141/2/3-8000
 Website: <http://www.ta-shanghai.com>
 E-mail: xukai@ta-shanghai.com

2. General Description of Equipment Under Test

2.1. Applicant and Manufacturer Information

Applicant	Xiaomi Communications Co., Ltd.
Applicant address	#019, 9th Floor, Building 6, 33 Xi'erqi Middle Road, Haidian District, Beijing, China, 100085
Manufacturer	Xiaomi Communications Co., Ltd.
Manufacturer address	#019, 9th Floor, Building 6, 33 Xi'erqi Middle Road, Haidian District, Beijing, China, 100085

2.2. General Information

EUT Description			
Model	2312FPCA6G		
IMEI	Original	Conducted	IMEI 1: 863357060106127 IMEI 2: 863357060106135
		Radiated	IMEI 1: 863357060105624 IMEI 2: 863357060105632
	Variant	Radiated	IMEI 1: 867584060055626 IMEI 2: 867584060055634
Hardware Version	135100N6M0A01		
Software Version	MIUI 14		
Antenna Type	PIFA Antenna		
Antenna Gain	Low Antenna	-5.60 dBi	
	Upper Antenna	-8.29 dBi	
Test Mode(s)	LTE Band 26;		
Test Modulation	QPSK, 16QAM, 64QAM;		
LTE Category	13		
Maximum E.R.P.	LTE Band 26	17.42 dBm	
Rated Power Supply Voltage	3.89V		
Operating Voltage	Minimum: 3.60V Maximum: 4.48V		
Operating Temperature	Lowest: 0°C Highest: +40°C		
Testing Temperature	Lowest: -30°C Highest: +50°C		
Operating Frequency Range(s)	Band	Tx (MHz)	Rx (MHz)
	LTE Band 26	814 ~ 824	859 ~ 869
Note: 1. The EUT is sent from the applicant to TA and the information of the EUT is declared by the applicant.			

3. Applied Standards

According to the specifications of the manufacturer, it must comply with the requirements of the following standards:

Test standards:

FCC CFR 47 Part 90S (2022)

FCC CFR47 Part 2 (2022)

Reference standard:

ANSI C63.26-2015

KDB 971168 D01 Power Meas License Digital Systems v03r01

4. Test Configuration

There is more than one SIM card slot, each one should be applied throughout the compliance test respectively, and however, only the worst case (SIM 1) will be recorded in this report.

Radiated measurements are performed by rotating the EUT in three different orthogonal test planes. EUT stand-up position (Z axis), lie-down position (X, Y axis). Receiver antenna polarization (horizontal and vertical), the worst emission was found in position (Low Antenna: Y axis, horizontal polarization; Upper Antenna: X axis, vertical polarization) and the worst case was recorded.

All mode and data rates and positions were investigated.

The following testing in LTE is set based on the maximum RF Output Power.

Test modes are chosen as the worst case configuration below for LTE Band 26

Test items	Bandwidth (MHz)				Modulation		RB			Test Channel		
	1.4	3	5	10	QPSK	16QAM/ 64QAM	1	50%	100%	L	M	H
RF Power Output and Effective Radiated Power	O	O	O	O	O	O	O	O	O	O	O	O
Occupied Bandwidth	O	O	O	O	O	O	-	-	O	O	O	O
Emission Mask	O	O	O	O	O	O	O	-	O	O	-	O
Peak-to-Average Power Ratio	O	O	O	O	O	O	-	-	O	O	O	O
Frequency Stability	O	O	O	O	O	O	O	-	-	-	O	-
Spurious Emissions at Antenna Terminals	O	O	O	O	O	-	O	-	-	O	O	O
Radiated Spurious Emission	O	-	O	O	O	-	O	-	-	-	O	-
Note	1. The mark "O" means that this configuration is chosen for testing. 2. The mark "-" means that this configuration is not testing.											

5. Test Case

5.1. RF Power Output and Effective Radiated Power

Ambient Condition

Temperature	Relative humidity
21°C ~25°C	40%~60%

Methods of Measurement

During the process of the testing, The EUT was connected to the Base Station Simulator with a known loss. The EUT is controlled by the Base Station Simulator test set to ensure max power transmission with proper modulation.

ERP can then be calculated as follows:

$$\text{EIRP (dBm)} = \text{Output Power (dBm)} + \text{Antenna Gain (dBi)}$$

$$\text{EIRP (dBm)} = \text{ERP (dBm)} + 2.15 \text{ (dB.)}$$

Test Setup

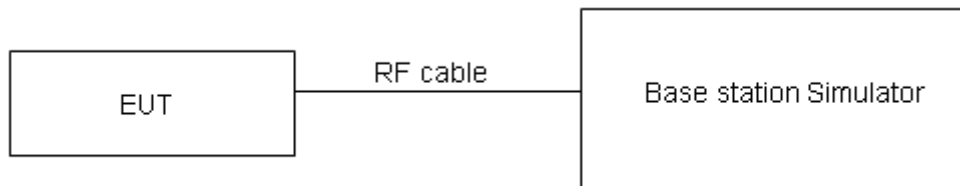

Limits

Part 90.635 (b) the maximum output power of the transmitter for mobile stations is 100 watts.

Rule Part 90.635(b) specifies that “The maximum output power of the transmitter for mobile stations is 100 watts”.

Limit	≤ 100 W (50 dBm)

Measurement Uncertainty

The assessed measurement uncertainty to ensure 95% confidence level for the normal distribution is with the coverage factor $k = 2$, $U = 0.4 \text{ dB}$ for RF power output, $k = 2$, $U = 1.19 \text{ dB}$ for ERP.

Test Results

Refer to the section 6.1 of this report for test data.

5.2. Occupied Bandwidth

Ambient Condition

Temperature	Relative humidity
21°C ~25°C	40%~60%

Method of Measurement

The EUT was connected to Spectrum Analyzer and Base Station Simulator via power Splitter. The occupied bandwidth is measured using spectrum analyzer.

RBW is set to $\geq 1\%EBW$, VBW is set to 3x RBW.

99% power and -26dBc occupied bandwidths are recorded. Spectrum analyzer plots are included on the following pages.

Test Setup

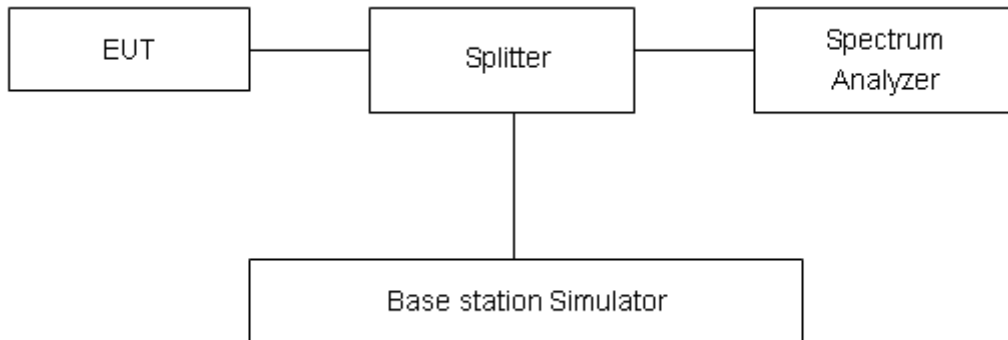

Limits

No specific occupied bandwidth requirements in part 2.1049.

Part 90.209 (a) Each authorization issued to a station licensed under this part will show an emission designator representing the class of emission authorized. The designator will be prefixed by a specified necessary bandwidth. This number does not necessarily indicate the bandwidth occupied by the emission at any instant. In those cases where part 2.202 of this chapter does not provide a formula for the computation of necessary bandwidth, the occupied bandwidth, as defined in part 2 of this chapter, may be used in lieu of the necessary bandwidth.

Measurement Uncertainty

The assessed measurement uncertainty to ensure 95% confidence level for the normal distribution is with the coverage factor $k = 2$, $U = 624\text{Hz}$.

Test Results

Refer to the section 6.2 of this report for test data.

5.3. Emission Mask

Ambient Condition

Temperature	Relative humidity
21°C ~25°C	40%~60%

Method of Measurement

The EUT was connected to Spectrum Analyzer and Base Station Simulator via power Splitter. The band edge of the lowest and highest channels were measured. The average detector is used. For Section 90.691(a) compliance testing, use RBW = 300 Hz for offsets less than 37.5 kHz from a channel edge; RBW = 100 kHz for offsets greater than 37.5 kHz is allowed.

Spectrum analyzer plots are included on the following pages.

Test Setup

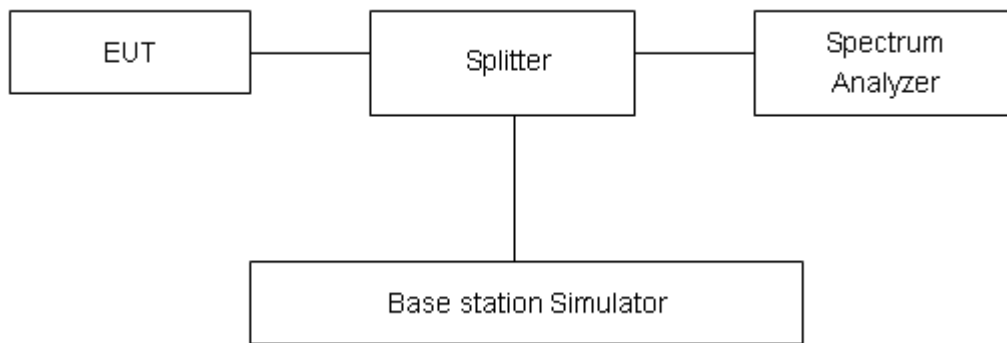

Limits

Rule Part 90.691(a) specifies that “ For any frequency removed from the EA licensee's frequency block by up to and including 37.5 kHz, the power of any emission shall be attenuated below the transmitter power (P) in watts by at least $116 \text{ Log}_{10}(f/6.1)$ decibels or $50 + 10 \text{ Log}_{10}(P)$ decibels or 80 decibels, whichever is the lesser attenuation, where f is the frequency removed from the center of the outer channel in the block in kilohertz and where f is greater than 12.5 kHz.”

Measurement Uncertainty

The assessed measurement uncertainty to ensure 95% confidence level for the normal distribution is with the coverage factor $k = 1.96$, $U=0.684\text{dB}$.

Test Results

Refer to the section 6.3 of this report for test data.

5.4. Peak-to-Average Power Ratio (PAPR)

Ambient Condition

Temperature	Relative humidity
21°C ~25°C	40%~60%

Methods of Measurement

Measure the total peak power and record as PPk. And measure the total average power and record as PAvg. Both the peak and average power levels must be expressed in the same logarithmic units (e.g., dBm). Determine the PAPR from:

$$PAPR (dB) = PPk (dBm) - PAvg (dBm).$$

Test Setup

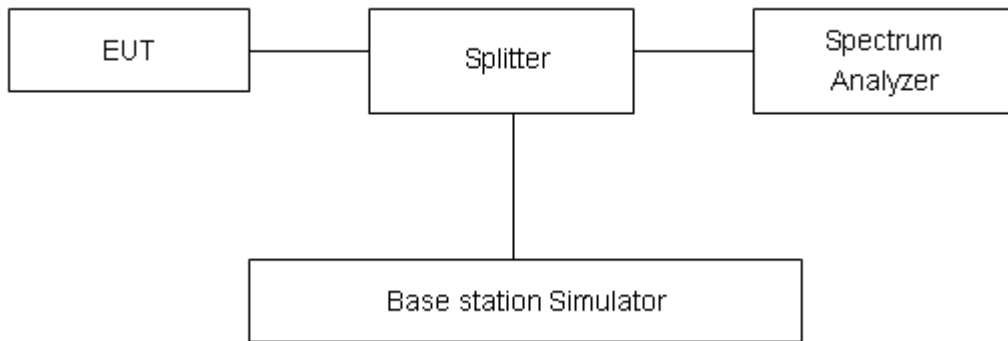

Limits

In measuring transmissions in this band using an average power technique, the peak-to-average ratio (PAR) of the transmission may not exceed 13 dB in 24.232(d).

Measurement Uncertainty

The assessed measurement uncertainty to ensure 95% confidence level for the normal distribution is with the coverage factor k = 2, U= 0.4 dB.

Test Results

Refer to the section 6.4 of this report for test data.

5.5. Frequency Stability

Ambient Condition

Temperature	Relative humidity
21°C ~25°C	40%~60%

Method of Measurement

1. Frequency Stability (Temperature Variation)

The temperature inside the climate chamber is varied from -30°C to +50°C in 10°C step size,

(1) With all power removed, the temperature was decreased to 0°C and permitted to stabilize for three hours.

(2) Measure the carrier frequency with the test equipment in a “call mode”. These measurements should be made within 1 minute of powering up the mobile station, to prevent significant self warming.

(3) Repeat the above measurements at 10°C increments from -30°C to +50°C. Allow at least 1.5 hours at each temperature, un-powered, before making measurements.

2. Frequency Stability (Voltage Variation)

The frequency stability shall be measured with variation of primary supply voltage as follows:

Primary Supply Voltage: The primary supply voltage is varied from 85% to 115% of the nominal value for non hand-carried battery and AC powered equipment. For hand-carried, battery-powered equipment, primary supply voltage is reduced to the battery operating end point which shall be specified by the manufacturer.

This transceiver is specified to operate with an input voltage of between 3.60 V and 4.48 V, with a nominal voltage of 3.89V.

Test Setup

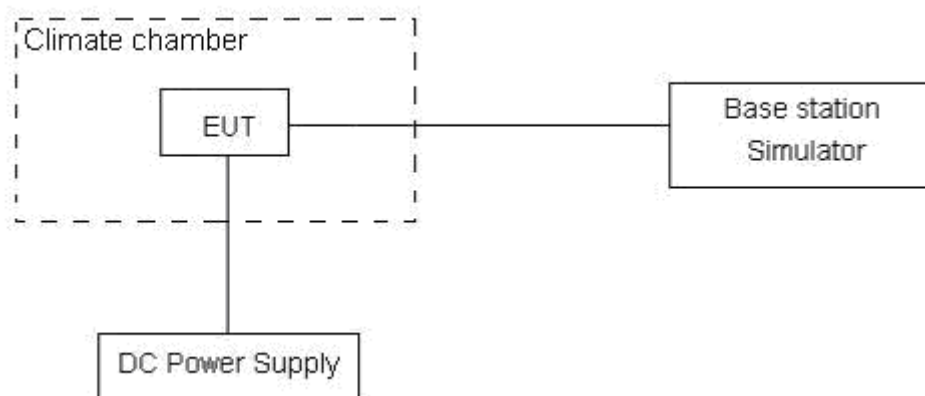

Limits

According to the Sec. 90.213.(a) Unless noted elsewhere, transmitters used in the services governed by this part must have a minimum frequency stability as specified in the following table.

Minimum Frequency Stability

[Parts per million (ppm)]

Frequency range (MHz)	Fixed and base stations	Mobile stations	
		Over 2 watts output power	2 watts or less output power
814 ~ 824	1.5	2.5	2.5

Measurement Uncertainty

The assessed measurement uncertainty to ensure 99.75% confidence level for the normal distribution is with the coverage factor $k = 3$, $U = 0.01\text{ppm}$.

Test Results

Refer to the section 6.5 of this report for test data.

5.6. Spurious Emissions at Antenna Terminals

Ambient Condition

Temperature	Relative humidity
21°C ~25°C	40%~60%

Method of Measurement

The EUT was connected to Spectrum Analyzer and Base Station Simulator via power Splitter. The measurement is carried out using a spectrum analyzer. The spectrum analyzer scans from 30MHz to the 10th harmonic of the carrier. The peak detector is used.

RBW is set to 1 kHz (0.009MHz~ 0.15 MHz),

RBW is set to 10 kHz (0.15 MHz~ 30 MHz)

RBW is set to 100 kHz (30MHz~1000 MHz)

RBW is set to 1000 kHz (above 1000MHz)

Sweep is set to AUTO.

Test Setup

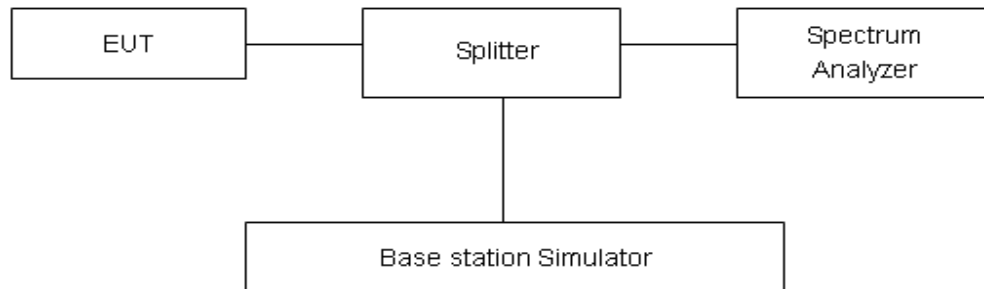

Limits

Rule Part 90.691 specifies that “The power of any emission outside of the authorized operating frequency ranges must be attenuated below the transmitting power (P) by a factor of at least 43 + 10 log (P) dB.”

Limit	-13 dBm
-------	---------

Measurement Uncertainty

The assessed measurement uncertainty to ensure 99.75% confidence level for the normal distribution is with the coverage factor $k = 1.96$.

Frequency	Uncertainty
9kHz-1GHz	0.684 dB
1GHz-12.75GHz	1.407 dB

Test Results

Refer to the section 6.6 of this report for test data.

5.7. Radiated Spurious Emission

Ambient Condition

Temperature	Relative humidity
21°C ~25°C	40%~60%

Method of Measurement

1. The testing follows FCC KDB 971168 v03r01 Section 5.8 and ANSI C63.26-2015.
2. Below 1GHz: The EUT is placed on a turntable 0.8 meters above the ground in the chamber, 3 meter away from the antenna. The maximal emission value is acquired by adjusting the antenna height, polarisation and turntable azimuth. Normally, the height range of antenna is 1 m to 4 m, the azimuth range of turntable is 0° to 360°, and the receive antenna has two polarizations Vertical (V) and Horizontal (H). Above 1GHz: (Note: the FCC's permission to use 1.5m as an alternative per TCBC Conf call of Dec. 2, 2014.) The EUT is placed on a turntable 1.5 meters above the ground in the chamber, 3 meter away from the antenna. The maximal emission value is acquired by adjusting the antenna height, polarisation and turntable azimuth. Normally, the height range of antenna is 1 m to 4 m, the azimuth range of turntable is 0° to 360°, and the receive antenna has two polarizations Vertical (V) and Horizontal (H).
3. A loop antenna, A log-periodic antenna or horn antenna shall be substituted in place of the EUT. The log-periodic antenna will be driven by a signal generator and the level will be adjusted till the same power value on the spectrum analyzer or receiver. The level of the spurious emissions can be calculated through the level of the signal generator, cable loss, the gain of the substitution antenna and the reading of the spectrum analyzer or receiver.
4. The EUT is then put into continuously transmitting mode at its maximum power level during the test. Set Test Receiver or Spectrum RBW=100kHz, VBW=300kHz, and the maximum value of the receiver should be recorded as (Pr).
5. The EUT shall be replaced by a substitution antenna. In the chamber, an substitution antenna for the frequency band of interest is placed at the reference point of the chamber. An RF Signal source for the frequency band of interest is connected to the substitution antenna with a cable that has been constructed to not interfere with the radiation pattern of the antenna. A power (PMea) is applied to the input of the substitution antenna, and adjust the level of the signal generator output until the value of the receiver reach the previously recorded (Pr). The power of signal source (PMea) is recorded. The test should be performed by rotating the test item and adjusting the receiving antenna polarization.
6. A amplifier should be connected to the Signal Source output port. And the cable should be connect between the Amplifier and the Substitution Antenna. The cable loss (Pcl) ,the Substitution Antenna Gain (Ga) and the Amplifier Gain (PAg) should be recorded after test.
7. The measurement results are obtained as described below:

$$\text{Power(EIRP)} = \text{PMea} - \text{PAg} - \text{Pcl} + \text{Ga}$$
 The measurement results are amend as described below:

$$\text{Power(EIRP)} = \text{PMea} - \text{Pcl} + \text{Ga}$$
8. This value is EIRP since the measurement is calibrated using an antenna of known gain (2.15 dBi) and known input power. ERP can be calculated from EIRP by subtracting the gain of the dipole, ERP

= EIRP-2.15dBi.

The modulation mode and RB allocation refer to section 5.1, using the maximum output power configuration.

Test Setup

9KHz~ 30MHz

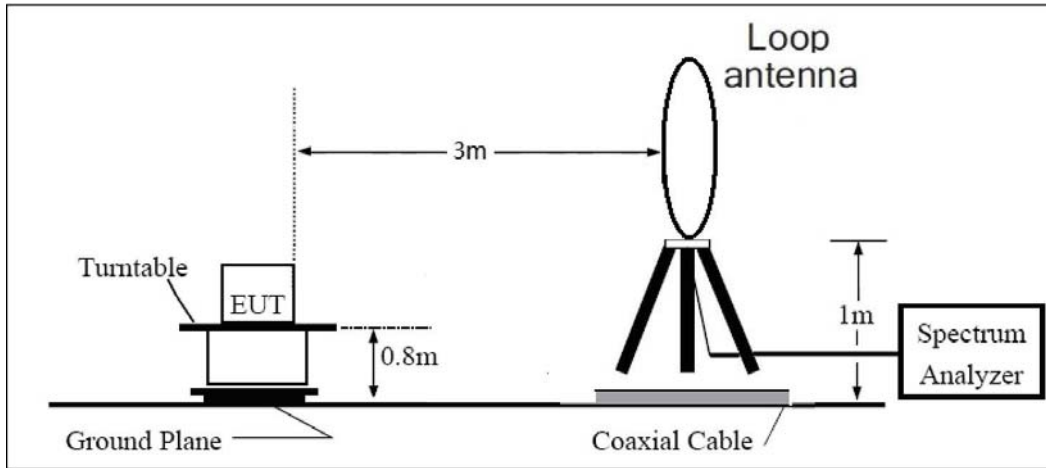

30MHz~ 1GHz

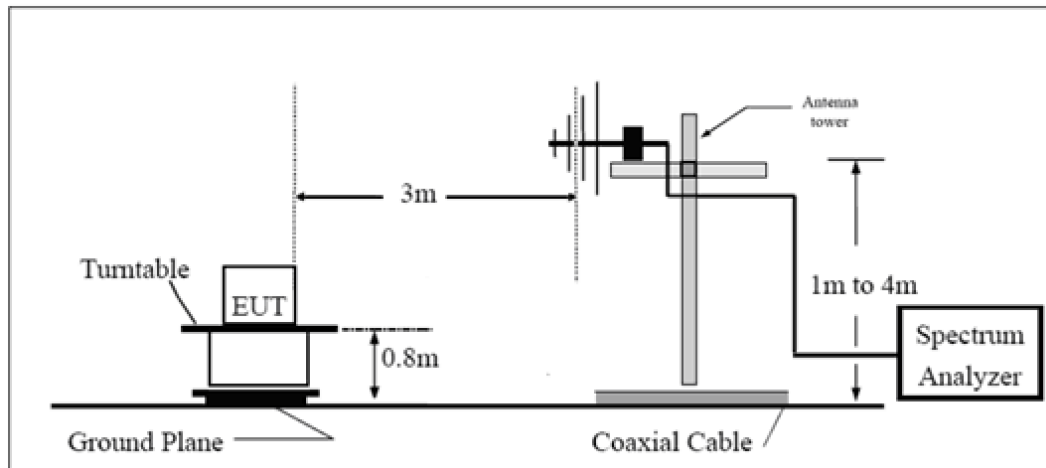

Above 1GHz

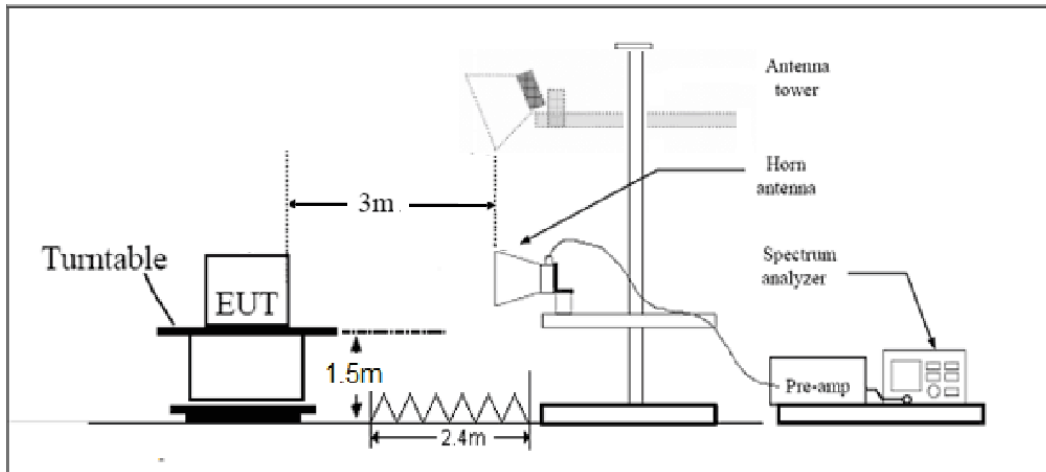

Note: Area side: 2.4mX3.6m

Limits

Rule Part 90.691 specifies that “The power of any emission outside of the authorized operating frequency ranges must be attenuated below the transmitting power (P) by a factor of at least $43 + 10 \log(P)$ dB.”

Limit	-13 dBm
-------	---------

Measurement Uncertainty

The assessed measurement uncertainty to ensure 95% confidence level for the normal distribution is with the coverage factor $k = 1.96$, $U = 3.55$ dB.

Test Results

Refer to the section 6.7 of this report for test data.

6. Test Results

6.1. RF Power Output and Effective Radiated Power

Low Antenna

LTE Band 26						
Bandwidth (MHz)	UL Channel	RB Size	RB Position	Modulation	Power (dBm)	ERP (dBm)
1.4	26697	1	#0	QPSK	24.94	17.19
1.4	26697	1	#Mid	QPSK	25.01	17.26
1.4	26697	1	#Max	QPSK	24.94	17.19
1.4	26697	3	#0	QPSK	24.94	17.19
1.4	26697	3	#Mid	QPSK	24.94	17.19
1.4	26697	3	#Max	QPSK	24.93	17.18
1.4	26697	6	#0	QPSK	23.99	16.24
1.4	26697	1	#0	16QAM	23.83	16.08
1.4	26697	1	#Mid	16QAM	23.92	16.17
1.4	26697	1	#Max	16QAM	23.85	16.10
1.4	26697	3	#0	16QAM	24.02	16.27
1.4	26697	3	#Mid	16QAM	24.00	16.25
1.4	26697	3	#Max	16QAM	24.05	16.30
1.4	26697	6	#0	16QAM	23.00	15.25
1.4	26740	1	#0	QPSK	24.90	17.15
1.4	26740	1	#Mid	QPSK	24.95	17.20
1.4	26740	1	#Max	QPSK	24.87	17.12
1.4	26740	3	#0	QPSK	24.96	17.21
1.4	26740	3	#Mid	QPSK	24.96	17.21
1.4	26740	3	#Max	QPSK	24.92	17.17
1.4	26740	6	#0	QPSK	24.03	16.28
1.4	26740	1	#0	16QAM	23.98	16.23
1.4	26740	1	#Mid	16QAM	24.06	16.31
1.4	26740	1	#Max	16QAM	24.04	16.29
1.4	26740	3	#0	16QAM	23.92	16.17
1.4	26740	3	#Mid	16QAM	23.93	16.18
1.4	26740	3	#Max	16QAM	23.93	16.18
1.4	26740	6	#0	16QAM	22.99	15.24
1.4	26783	1	#0	QPSK	24.96	17.21
1.4	26783	1	#Mid	QPSK	25.01	17.26
1.4	26783	1	#Max	QPSK	24.94	17.19
1.4	26783	3	#0	QPSK	24.99	17.24
1.4	26783	3	#Mid	QPSK	24.99	17.24
1.4	26783	3	#Max	QPSK	24.93	17.18

1.4	26783	6	#0	QPSK	24.02	16.27
1.4	26783	1	#0	16QAM	23.75	16.00
1.4	26783	1	#Mid	16QAM	23.79	16.04
1.4	26783	1	#Max	16QAM	23.81	16.06
1.4	26783	3	#0	16QAM	23.91	16.16
1.4	26783	3	#Mid	16QAM	23.92	16.17
1.4	26783	3	#Max	16QAM	23.90	16.15
1.4	26783	6	#0	16QAM	23.04	15.29
3	26705	1	#0	QPSK	24.68	16.93
3	26705	1	#Mid	QPSK	24.83	17.08
3	26705	1	#Max	QPSK	24.68	16.93
3	26705	8	#0	QPSK	23.90	16.15
3	26705	8	#Mid	QPSK	23.90	16.15
3	26705	8	#Max	QPSK	23.96	16.21
3	26705	15	#0	QPSK	23.91	16.16
3	26705	1	#0	16QAM	23.80	16.05
3	26705	1	#Mid	16QAM	23.95	16.20
3	26705	1	#Max	16QAM	23.85	16.10
3	26705	8	#0	16QAM	22.90	15.15
3	26705	8	#Mid	16QAM	22.89	15.14
3	26705	8	#Max	16QAM	22.93	15.18
3	26705	15	#0	16QAM	22.91	15.16
3	26740	1	#0	QPSK	24.75	17.00
3	26740	1	#Mid	QPSK	24.85	17.10
3	26740	1	#Max	QPSK	24.77	17.02
3	26740	8	#0	QPSK	23.99	16.24
3	26740	8	#Mid	QPSK	23.96	16.21
3	26740	8	#Max	QPSK	24.01	16.26
3	26740	15	#0	QPSK	23.99	16.24
3	26740	1	#0	16QAM	23.74	15.99
3	26740	1	#Mid	16QAM	23.90	16.15
3	26740	1	#Max	16QAM	23.83	16.08
3	26740	8	#0	16QAM	22.95	15.20
3	26740	8	#Mid	16QAM	22.92	15.17
3	26740	8	#Max	16QAM	22.95	15.20
3	26740	15	#0	16QAM	22.86	15.11
3	26775	1	#0	QPSK	24.81	17.06
3	26775	1	#Mid	QPSK	24.93	17.18
3	26775	1	#Max	QPSK	24.86	17.11
3	26775	8	#0	QPSK	24.00	16.25
3	26775	8	#Mid	QPSK	23.97	16.22
3	26775	8	#Max	QPSK	23.99	16.24
3	26775	15	#0	QPSK	24.00	16.25

3	26775	1	#0	16QAM	23.55	15.80
3	26775	1	#Mid	16QAM	23.67	15.92
3	26775	1	#Max	16QAM	23.60	15.85
3	26775	8	#0	16QAM	22.93	15.18
3	26775	8	#Mid	16QAM	22.92	15.17
3	26775	8	#Max	16QAM	22.95	15.20
3	26775	15	#0	16QAM	22.95	15.20
5	26715	1	#0	QPSK	24.93	17.18
5	26715	1	#Mid	QPSK	25.12	17.37
5	26715	1	#Max	QPSK	24.95	17.20
5	26715	12	#0	QPSK	23.90	16.15
5	26715	12	#Mid	QPSK	23.93	16.18
5	26715	12	#Max	QPSK	24.04	16.29
5	26715	25	#0	QPSK	24.00	16.25
5	26715	1	#0	16QAM	24.14	16.39
5	26715	1	#Mid	16QAM	24.26	16.51
5	26715	1	#Max	16QAM	24.18	16.43
5	26715	12	#0	16QAM	22.99	15.24
5	26715	12	#Mid	16QAM	22.95	15.20
5	26715	12	#Max	16QAM	23.03	15.28
5	26715	25	#0	16QAM	23.03	15.28
5	26740	1	#0	QPSK	25.00	17.25
5	26740	1	#Mid	QPSK	25.13	17.38
5	26740	1	#Max	QPSK	25.02	17.27
5	26740	12	#0	QPSK	23.95	16.20
5	26740	12	#Mid	QPSK	23.96	16.21
5	26740	12	#Max	QPSK	23.99	16.24
5	26740	25	#0	QPSK	24.01	16.26
5	26740	1	#0	16QAM	24.17	16.42
5	26740	1	#Mid	16QAM	24.30	16.55
5	26740	1	#Max	16QAM	24.23	16.48
5	26740	12	#0	16QAM	22.94	15.19
5	26740	12	#Mid	16QAM	22.92	15.17
5	26740	12	#Max	16QAM	23.01	15.26
5	26740	25	#0	16QAM	23.04	15.29
5	26765	1	#0	QPSK	25.02	17.27
5	26765	1	#Mid	QPSK	25.17	17.42
5	26765	1	#Max	QPSK	25.02	17.27
5	26765	12	#0	QPSK	24.03	16.28
5	26765	12	#Mid	QPSK	24.01	16.26
5	26765	12	#Max	QPSK	24.02	16.27
5	26765	25	#0	QPSK	24.00	16.25
5	26765	1	#0	16QAM	24.12	16.37

5	26765	1	#Mid	16QAM	24.27	16.52
5	26765	1	#Max	16QAM	24.14	16.39
5	26765	12	#0	16QAM	22.94	15.19
5	26765	12	#Mid	16QAM	22.98	15.23
5	26765	12	#Max	16QAM	22.96	15.21
5	26765	25	#0	16QAM	23.04	15.29
10	26740	1	#0	QPSK	25.10	17.35
10	26740	1	#Mid	QPSK	25.14	17.39
10	26740	1	#Max	QPSK	25.08	17.33
10	26740	25	#0	QPSK	23.93	16.18
10	26740	25	#Mid	QPSK	23.93	16.18
10	26740	25	#Max	QPSK	24.05	16.30
10	26740	50	#0	QPSK	24.05	16.30
10	26740	1	#0	16QAM	24.18	16.43
10	26740	1	#Mid	16QAM	24.25	16.50
10	26740	1	#Max	16QAM	24.21	16.46
10	26740	25	#0	16QAM	22.96	15.21
10	26740	25	#Mid	16QAM	22.95	15.20
10	26740	25	#Max	16QAM	23.05	15.30
10	26740	50	#0	16QAM	23.00	15.25
1.4	26697	1	#0	64QAM	23.49	15.74
1.4	26697	1	#Mid	64QAM	23.58	15.83
1.4	26697	1	#Max	64QAM	23.52	15.77
1.4	26697	3	#0	64QAM	23.75	16.00
1.4	26697	3	#Mid	64QAM	23.72	15.97
1.4	26697	3	#Max	64QAM	23.71	15.96
1.4	26697	6	#0	64QAM	22.73	14.98
1.4	26740	1	#0	64QAM	23.72	15.97
1.4	26740	1	#Mid	64QAM	23.76	16.01
1.4	26740	1	#Max	64QAM	23.68	15.93
1.4	26740	3	#0	64QAM	23.62	15.87
1.4	26740	3	#Mid	64QAM	23.62	15.87
1.4	26740	3	#Max	64QAM	23.62	15.87
1.4	26740	6	#0	64QAM	22.68	14.93
1.4	26783	1	#0	64QAM	23.46	15.71
1.4	26783	1	#Mid	64QAM	23.49	15.74
1.4	26783	1	#Max	64QAM	23.46	15.71
1.4	26783	3	#0	64QAM	23.62	15.87
1.4	26783	3	#Mid	64QAM	23.63	15.88
1.4	26783	3	#Max	64QAM	23.59	15.84
1.4	26783	6	#0	64QAM	22.73	14.98
3	26705	1	#0	64QAM	23.45	15.70
3	26705	1	#Mid	64QAM	23.67	15.92

3	26705	1	#Max	64QAM	23.55	15.80
3	26705	8	#0	64QAM	22.57	14.82
3	26705	8	#Mid	64QAM	22.54	14.79
3	26705	8	#Max	64QAM	22.66	14.91
3	26705	15	#0	64QAM	22.60	14.85
3	26740	1	#0	64QAM	23.47	15.72
3	26740	1	#Mid	64QAM	23.59	15.84
3	26740	1	#Max	64QAM	23.53	15.78
3	26740	8	#0	64QAM	22.59	14.84
3	26740	8	#Mid	64QAM	22.59	14.84
3	26740	8	#Max	64QAM	22.65	14.90
3	26740	15	#0	64QAM	22.55	14.80
3	26775	1	#0	64QAM	23.23	15.48
3	26775	1	#Mid	64QAM	23.41	15.66
3	26775	1	#Max	64QAM	23.26	15.51
3	26775	8	#0	64QAM	22.60	14.85
3	26775	8	#Mid	64QAM	22.61	14.86
3	26775	8	#Max	64QAM	22.65	14.90
3	26775	15	#0	64QAM	22.63	14.88
5	26715	1	#0	64QAM	24.66	16.91
5	26715	1	#Mid	64QAM	24.81	17.06
5	26715	1	#Max	64QAM	24.70	16.95
5	26715	12	#0	64QAM	23.63	15.88
5	26715	12	#Mid	64QAM	23.62	15.87
5	26715	12	#Max	64QAM	23.73	15.98
5	26715	25	#0	64QAM	23.68	15.93
5	26740	1	#0	64QAM	24.72	16.97
5	26740	1	#Mid	64QAM	24.83	17.08
5	26740	1	#Max	64QAM	24.74	16.99
5	26740	12	#0	64QAM	23.67	15.92
5	26740	12	#Mid	64QAM	23.69	15.94
5	26740	12	#Max	64QAM	23.71	15.96
5	26740	25	#0	64QAM	23.71	15.96
5	26765	1	#0	64QAM	24.65	16.90
5	26765	1	#Mid	64QAM	24.77	17.02
5	26765	1	#Max	64QAM	24.65	16.90
5	26765	12	#0	64QAM	23.65	15.90
5	26765	12	#Mid	64QAM	23.66	15.91
5	26765	12	#Max	64QAM	23.72	15.97
5	26765	25	#0	64QAM	23.70	15.95
10	26740	1	#0	64QAM	23.97	16.22
10	26740	1	#Mid	64QAM	24.04	16.29
10	26740	1	#Max	64QAM	24.01	16.26

10	26740	25	#0	64QAM	22.69	14.94
10	26740	25	#Mid	64QAM	22.69	14.94
10	26740	25	#Max	64QAM	22.79	15.04
10	26740	50	#0	64QAM	22.72	14.97

Upper Antenna

LTE Band 26						
Bandwidth (MHz)	UL Channel	RB Size	RB Position	Modulation	Power (dBm)	ERP (dBm)
1.4	26697	1	#0	QPSK	24.45	14.01
1.4	26697	1	#Mid	QPSK	24.56	14.12
1.4	26697	1	#Max	QPSK	24.49	14.05
1.4	26697	3	#0	QPSK	24.45	14.01
1.4	26697	3	#Mid	QPSK	24.44	14.00
1.4	26697	3	#Max	QPSK	24.43	13.99
1.4	26697	6	#0	QPSK	23.52	13.08
1.4	26697	1	#0	16QAM	23.34	12.90
1.4	26697	1	#Mid	16QAM	23.42	12.98
1.4	26697	1	#Max	16QAM	23.37	12.93
1.4	26697	3	#0	16QAM	23.56	13.12
1.4	26697	3	#Mid	16QAM	23.54	13.10
1.4	26697	3	#Max	16QAM	23.54	13.10
1.4	26697	6	#0	16QAM	22.50	12.06
1.4	26740	1	#0	QPSK	24.39	13.95
1.4	26740	1	#Mid	QPSK	24.43	13.99
1.4	26740	1	#Max	QPSK	24.37	13.93
1.4	26740	3	#0	QPSK	24.46	14.02
1.4	26740	3	#Mid	QPSK	24.46	14.02
1.4	26740	3	#Max	QPSK	24.41	13.97
1.4	26740	6	#0	QPSK	23.56	13.12
1.4	26740	1	#0	16QAM	23.51	13.07
1.4	26740	1	#Mid	16QAM	23.58	13.14
1.4	26740	1	#Max	16QAM	23.52	13.08
1.4	26740	3	#0	16QAM	23.44	13.00
1.4	26740	3	#Mid	16QAM	23.42	12.98
1.4	26740	3	#Max	16QAM	23.42	12.98
1.4	26740	6	#0	16QAM	22.49	12.05
1.4	26783	1	#0	QPSK	24.45	14.01
1.4	26783	1	#Mid	QPSK	24.51	14.07
1.4	26783	1	#Max	QPSK	24.44	14.00
1.4	26783	3	#0	QPSK	24.48	14.04
1.4	26783	3	#Mid	QPSK	24.48	14.04
1.4	26783	3	#Max	QPSK	24.45	14.01
1.4	26783	6	#0	QPSK	23.54	13.10
1.4	26783	1	#0	16QAM	23.25	12.81
1.4	26783	1	#Mid	16QAM	23.30	12.86
1.4	26783	1	#Max	16QAM	23.27	12.83
1.4	26783	3	#0	16QAM	23.43	12.99

1.4	26783	3	#Mid	16QAM	23.40	12.96
1.4	26783	3	#Max	16QAM	23.40	12.96
1.4	26783	6	#0	16QAM	22.55	12.11
3	26705	1	#0	QPSK	24.15	13.71
3	26705	1	#Mid	QPSK	24.28	13.84
3	26705	1	#Max	QPSK	24.16	13.72
3	26705	8	#0	QPSK	23.42	12.98
3	26705	8	#Mid	QPSK	23.43	12.99
3	26705	8	#Max	QPSK	23.51	13.07
3	26705	15	#0	QPSK	23.42	12.98
3	26705	1	#0	16QAM	23.39	12.95
3	26705	1	#Mid	16QAM	23.49	13.05
3	26705	1	#Max	16QAM	23.42	12.98
3	26705	8	#0	16QAM	22.38	11.94
3	26705	8	#Mid	16QAM	22.37	11.93
3	26705	8	#Max	16QAM	22.43	11.99
3	26705	15	#0	16QAM	22.30	11.86
3	26740	1	#0	QPSK	24.24	13.80
3	26740	1	#Mid	QPSK	24.38	13.94
3	26740	1	#Max	QPSK	24.34	13.90
3	26740	8	#0	QPSK	23.45	13.01
3	26740	8	#Mid	QPSK	23.46	13.02
3	26740	8	#Max	QPSK	23.48	13.04
3	26740	15	#0	QPSK	23.47	13.03
3	26740	1	#0	16QAM	23.10	12.66
3	26740	1	#Mid	16QAM	23.26	12.82
3	26740	1	#Max	16QAM	23.21	12.77
3	26740	8	#0	16QAM	22.43	11.99
3	26740	8	#Mid	16QAM	22.42	11.98
3	26740	8	#Max	16QAM	22.44	12.00
3	26740	15	#0	16QAM	22.44	12.00
3	26775	1	#0	QPSK	24.15	13.71
3	26775	1	#Mid	QPSK	24.26	13.82
3	26775	1	#Max	QPSK	24.11	13.67
3	26775	8	#0	QPSK	23.42	12.98
3	26775	8	#Mid	QPSK	23.47	13.03
3	26775	8	#Max	QPSK	23.48	13.04
3	26775	15	#0	QPSK	23.45	13.01
3	26775	1	#0	16QAM	23.37	12.93
3	26775	1	#Mid	16QAM	23.51	13.07
3	26775	1	#Max	16QAM	23.44	13.00
3	26775	8	#0	16QAM	22.45	12.01
3	26775	8	#Mid	16QAM	22.44	12.00

3	26775	8	#Max	16QAM	22.47	12.03
3	26775	15	#0	16QAM	22.44	12.00
5	26715	1	#0	QPSK	24.47	14.03
5	26715	1	#Mid	QPSK	24.60	14.16
5	26715	1	#Max	QPSK	24.50	14.06
5	26715	12	#0	QPSK	23.45	13.01
5	26715	12	#Mid	QPSK	23.47	13.03
5	26715	12	#Max	QPSK	23.53	13.09
5	26715	25	#0	QPSK	23.49	13.05
5	26715	1	#0	16QAM	23.72	13.28
5	26715	1	#Mid	16QAM	23.81	13.37
5	26715	1	#Max	16QAM	23.73	13.29
5	26715	12	#0	16QAM	22.39	11.95
5	26715	12	#Mid	16QAM	22.39	11.95
5	26715	12	#Max	16QAM	22.49	12.05
5	26715	25	#0	16QAM	22.54	12.10
5	26740	1	#0	QPSK	24.51	14.07
5	26740	1	#Mid	QPSK	24.65	14.21
5	26740	1	#Max	QPSK	24.52	14.08
5	26740	12	#0	QPSK	23.50	13.06
5	26740	12	#Mid	QPSK	23.48	13.04
5	26740	12	#Max	QPSK	23.54	13.10
5	26740	25	#0	QPSK	23.53	13.09
5	26740	1	#0	16QAM	23.62	13.18
5	26740	1	#Mid	16QAM	23.74	13.30
5	26740	1	#Max	16QAM	23.66	13.22
5	26740	12	#0	16QAM	22.37	11.93
5	26740	12	#Mid	16QAM	22.43	11.99
5	26740	12	#Max	16QAM	22.49	12.05
5	26740	25	#0	16QAM	22.52	12.08
5	26765	1	#0	QPSK	24.47	14.03
5	26765	1	#Mid	QPSK	24.60	14.16
5	26765	1	#Max	QPSK	24.43	13.99
5	26765	12	#0	QPSK	23.54	13.10
5	26765	12	#Mid	QPSK	23.54	13.10
5	26765	12	#Max	QPSK	23.53	13.09
5	26765	25	#0	QPSK	23.55	13.11
5	26765	1	#0	16QAM	23.67	13.23
5	26765	1	#Mid	16QAM	23.84	13.40
5	26765	1	#Max	16QAM	23.69	13.25
5	26765	12	#0	16QAM	22.51	12.07
5	26765	12	#Mid	16QAM	22.54	12.10
5	26765	12	#Max	16QAM	22.56	12.12

5	26765	25	#0	16QAM	22.56	12.12
10	26740	1	#0	QPSK	24.58	14.14
10	26740	1	#Mid	QPSK	24.66	14.22
10	26740	1	#Max	QPSK	24.58	14.14
10	26740	25	#0	QPSK	23.47	13.03
10	26740	25	#Mid	QPSK	23.47	13.03
10	26740	25	#Max	QPSK	23.52	13.08
10	26740	50	#0	QPSK	23.55	13.11
10	26740	1	#0	16QAM	23.65	13.21
10	26740	1	#Mid	16QAM	23.77	13.33
10	26740	1	#Max	16QAM	23.67	13.23
10	26740	25	#0	16QAM	22.48	12.04
10	26740	25	#Mid	16QAM	22.50	12.06
10	26740	25	#Max	16QAM	22.54	12.10
10	26740	50	#0	16QAM	22.47	12.03
1.4	26697	1	#0	64QAM	22.83	12.39
1.4	26697	1	#Mid	64QAM	22.95	12.51
1.4	26697	1	#Max	64QAM	22.86	12.42
1.4	26697	3	#0	64QAM	23.04	12.60
1.4	26697	3	#Mid	64QAM	23.06	12.62
1.4	26697	3	#Max	64QAM	23.05	12.61
1.4	26697	6	#0	64QAM	22.03	11.59
1.4	26740	1	#0	64QAM	23.03	12.59
1.4	26740	1	#Mid	64QAM	23.11	12.67
1.4	26740	1	#Max	64QAM	23.09	12.65
1.4	26740	3	#0	64QAM	22.99	12.55
1.4	26740	3	#Mid	64QAM	22.96	12.52
1.4	26740	3	#Max	64QAM	22.98	12.54
1.4	26740	6	#0	64QAM	22.01	11.57
1.4	26783	1	#0	64QAM	22.83	12.39
1.4	26783	1	#Mid	64QAM	22.82	12.38
1.4	26783	1	#Max	64QAM	22.81	12.37
1.4	26783	3	#0	64QAM	22.95	12.51
1.4	26783	3	#Mid	64QAM	22.96	12.52
1.4	26783	3	#Max	64QAM	22.95	12.51
1.4	26783	6	#0	64QAM	22.07	11.63
3	26705	1	#0	64QAM	22.62	12.18
3	26705	1	#Mid	64QAM	22.78	12.34
3	26705	1	#Max	64QAM	22.71	12.27
3	26705	8	#0	64QAM	21.89	11.45
3	26705	8	#Mid	64QAM	21.95	11.51
3	26705	8	#Max	64QAM	22.00	11.56
3	26705	15	#0	64QAM	21.95	11.51

3	26740	1	#0	64QAM	22.99	12.55
3	26740	1	#Mid	64QAM	23.11	12.67
3	26740	1	#Max	64QAM	23.04	12.60
3	26740	8	#0	64QAM	21.95	11.51
3	26740	8	#Mid	64QAM	21.96	11.52
3	26740	8	#Max	64QAM	22.02	11.58
3	26740	15	#0	64QAM	21.94	11.50
3	26775	1	#0	64QAM	22.96	12.52
3	26775	1	#Mid	64QAM	23.05	12.61
3	26775	1	#Max	64QAM	22.96	12.52
3	26775	8	#0	64QAM	21.97	11.53
3	26775	8	#Mid	64QAM	21.95	11.51
3	26775	8	#Max	64QAM	21.98	11.54
3	26775	15	#0	64QAM	21.88	11.44
5	26715	1	#0	64QAM	23.95	13.51
5	26715	1	#Mid	64QAM	24.08	13.64
5	26715	1	#Max	64QAM	23.98	13.54
5	26715	12	#0	64QAM	22.96	12.52
5	26715	12	#Mid	64QAM	22.98	12.54
5	26715	12	#Max	64QAM	23.07	12.63
5	26715	25	#0	64QAM	23.02	12.58
5	26740	1	#0	64QAM	24.00	13.56
5	26740	1	#Mid	64QAM	24.16	13.72
5	26740	1	#Max	64QAM	24.05	13.61
5	26740	12	#0	64QAM	23.02	12.58
5	26740	12	#Mid	64QAM	23.01	12.57
5	26740	12	#Max	64QAM	23.08	12.64
5	26740	25	#0	64QAM	23.04	12.60
5	26765	1	#0	64QAM	24.05	13.61
5	26765	1	#Mid	64QAM	24.17	13.73
5	26765	1	#Max	64QAM	24.03	13.59
5	26765	12	#0	64QAM	23.09	12.65
5	26765	12	#Mid	64QAM	23.01	12.57
5	26765	12	#Max	64QAM	23.06	12.62
5	26765	25	#0	64QAM	23.08	12.64
10	26740	1	#0	64QAM	23.20	12.76
10	26740	1	#Mid	64QAM	23.32	12.88
10	26740	1	#Max	64QAM	23.25	12.81
10	26740	25	#0	64QAM	22.01	11.57
10	26740	25	#Mid	64QAM	22.01	11.57
10	26740	25	#Max	64QAM	22.07	11.63
10	26740	50	#0	64QAM	21.98	11.54

6.2. Occupied Bandwidth

LTE Band 26							
RB	Modulation	Bandwidth (MHz)	Channel	Frequency (MHz)	99% Power Bandwidth(MHz)	-26dBc Bandwidth(MHz)	
100%	QPSK	1.4	26697	814.7	1.10	1.28	
			26740	819	1.10	1.28	
			26783	823.3	1.09	1.27	
		3	26705	815.5	2.68	2.96	
			26740	819	2.68	2.98	
			26775	822.5	2.69	2.97	
		5	26715	816.5	4.52	4.88	
			26740	819	4.50	4.87	
			26765	821.5	4.51	4.89	
		10	26740	819	8.99	9.76	
		16QAM	1.4	26697	814.7	1.09	1.26
				26740	819	1.10	1.26
	26783			823.3	1.10	1.28	
	3		26705	815.5	2.69	3.01	
			26740	819	2.69	2.98	
			26775	822.5	2.68	2.99	
	5		26715	816.5	4.50	4.88	
			26740	819	4.51	4.89	
			26765	821.5	4.53	4.91	
	10		26740	819	9.00	9.67	
	64QAM		1.4	26697	814.7	1.09	1.27
				26740	819	1.10	1.27
		26783		823.3	1.10	1.30	
		3	26705	815.5	2.70	2.97	
			26740	819	2.69	3.00	
			26775	822.5	2.69	2.96	
		5	26715	816.5	4.50	4.88	
			26740	819	4.50	4.93	
			26765	821.5	4.51	4.93	
		10	26740	819	8.95	9.69	

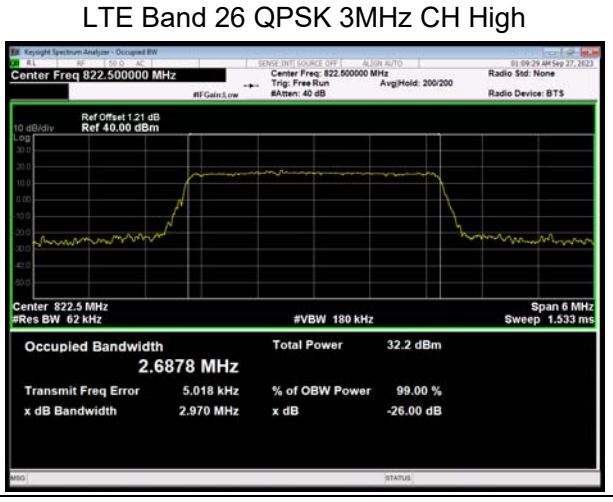
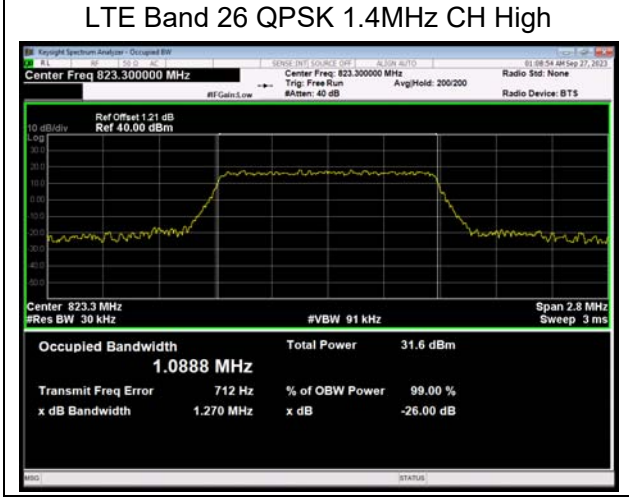
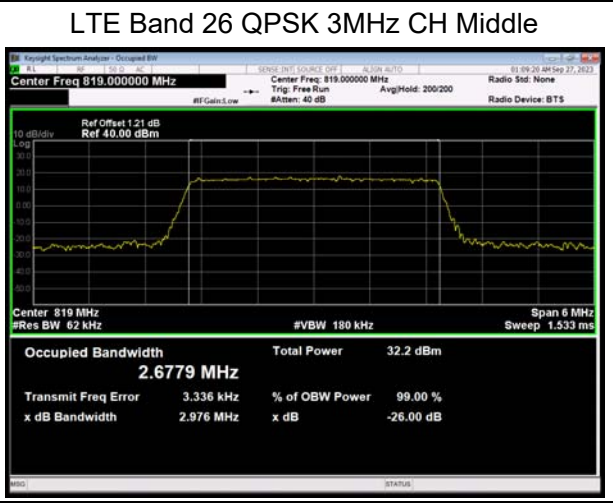
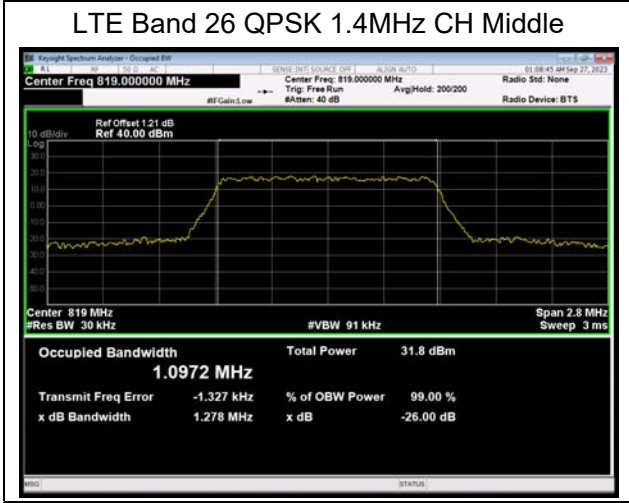
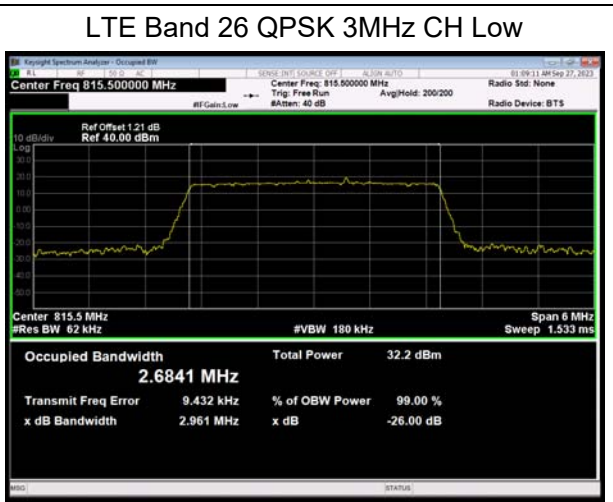
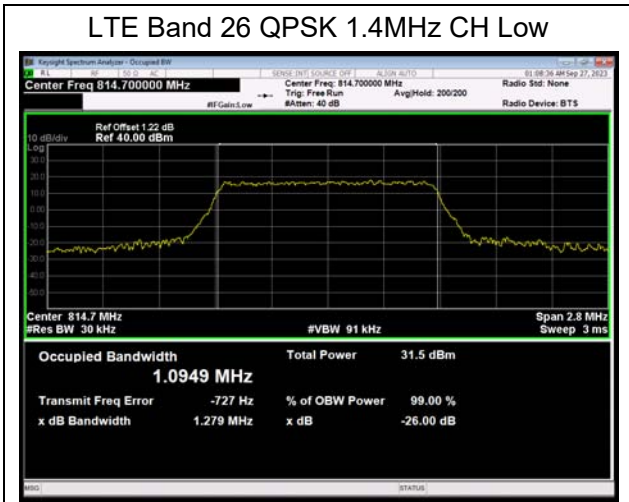

LTE Band 26 QPSK 5MHz CH Low

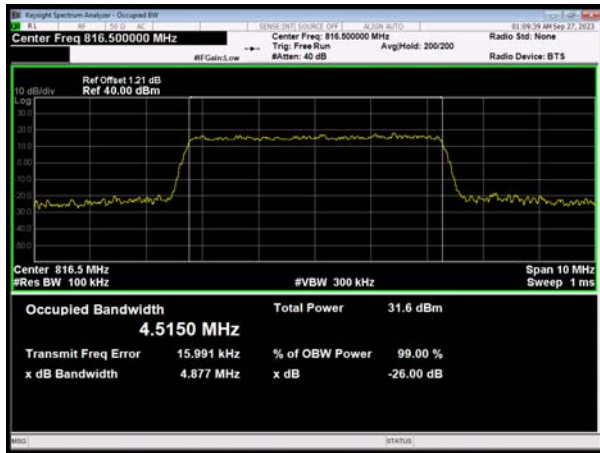

LTE Band 26 QPSK 10MHz CH Middle

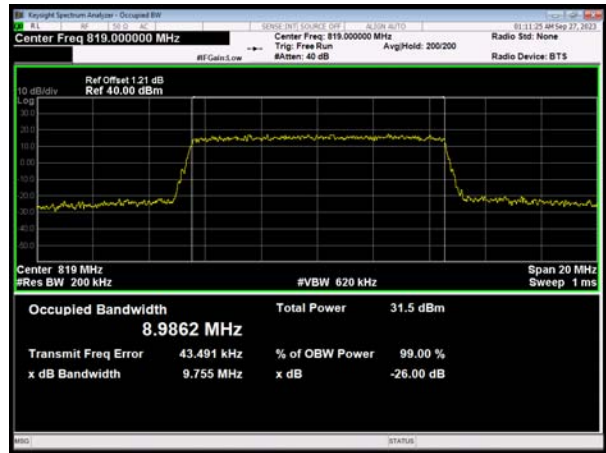

LTE Band 26 QPSK 5MHz CH Middle

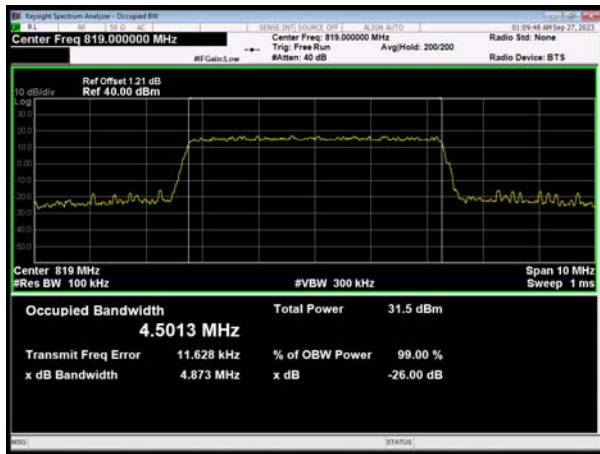

LTE Band 26 QPSK 5MHz CH High



LTE Band 26 16QAM 1.4MHz CH Low

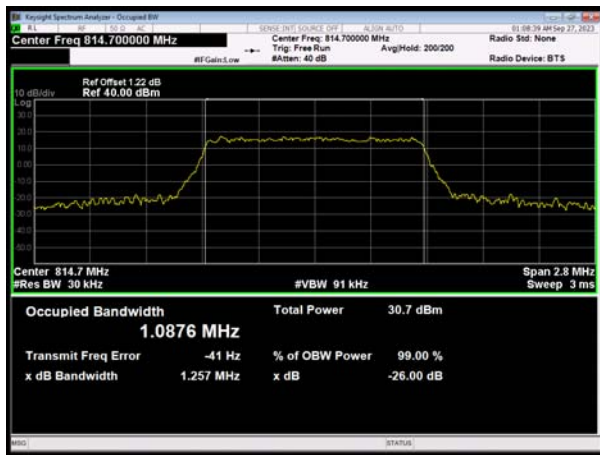

LTE Band 26 16QAM 3MHz CH Low



LTE Band 26 16QAM 1.4MHz CH Middle



LTE Band 26 16QAM 3MHz CH Middle



LTE Band 26 16QAM 1.4MHz CH High

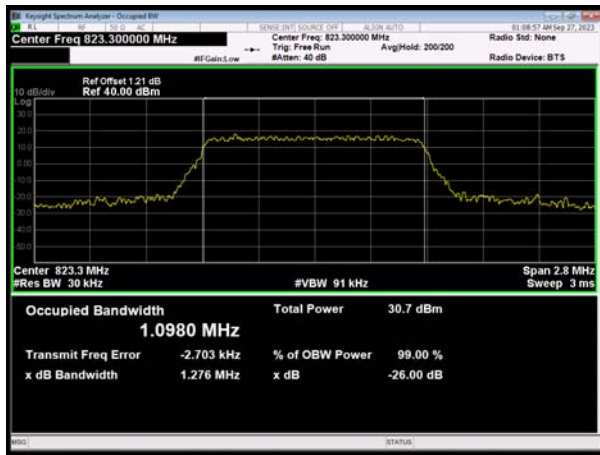

LTE Band 26 16QAM 3MHz CH High



LTE Band 26 16QAM 5MHz CH Low

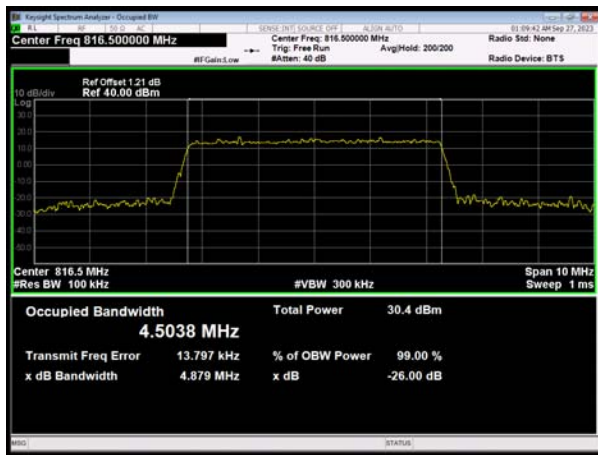

LTE Band 26 16QAM 10MHz CH Middle

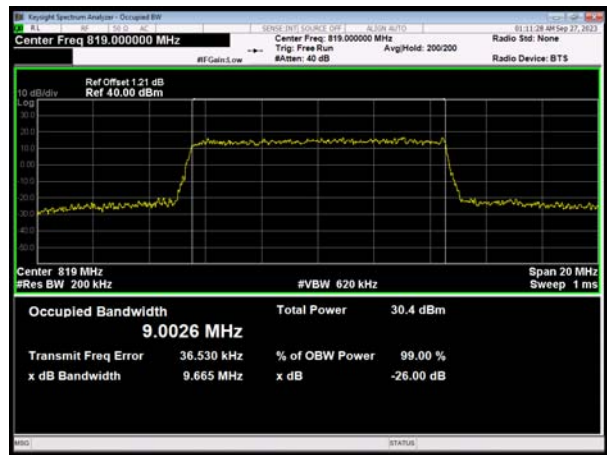

LTE Band 26 16QAM 5MHz CH Middle



LTE Band 26 16QAM 5MHz CH High

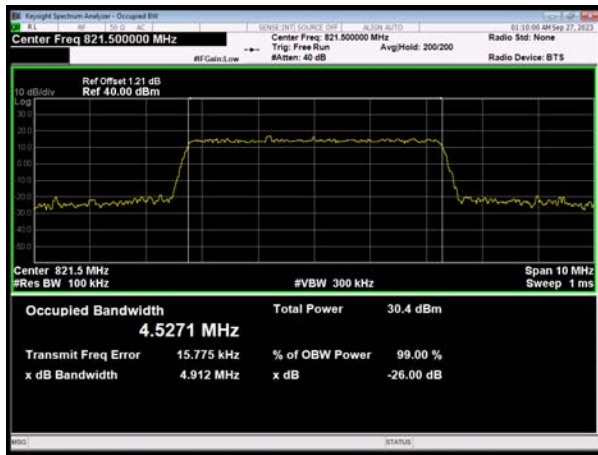

LTE Band 26 64QAM 1.4MHz CH Low

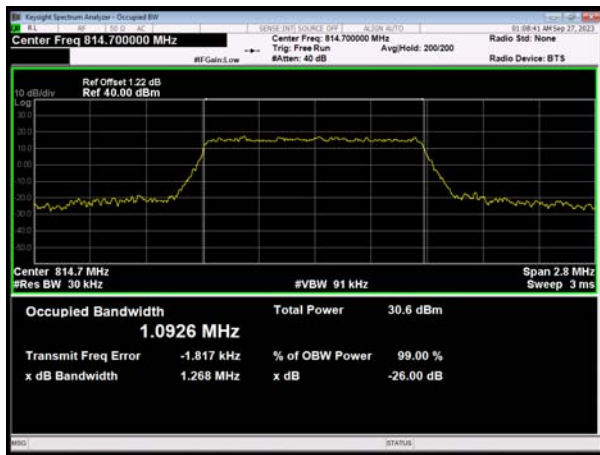

LTE Band 26 64QAM 3MHz CH Low

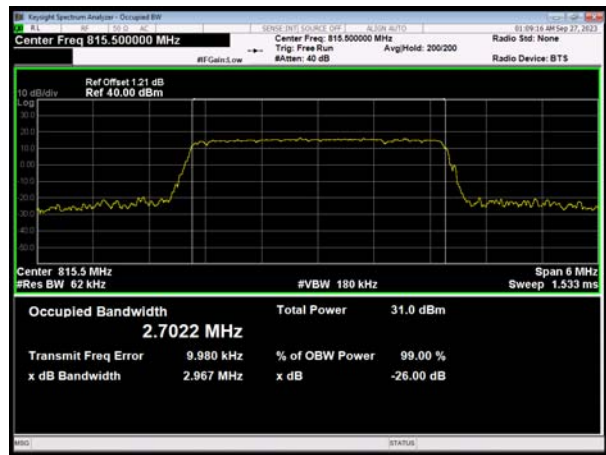

LTE Band 26 64QAM 1.4MHz CH Middle

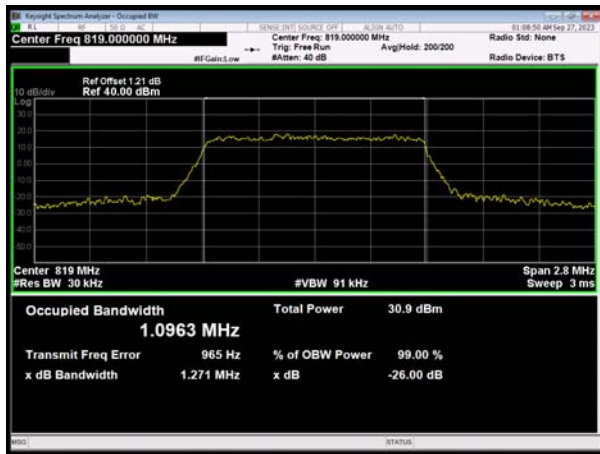

LTE Band 26 64QAM 3MHz CH Middle



LTE Band 26 64QAM 1.4MHz CH High

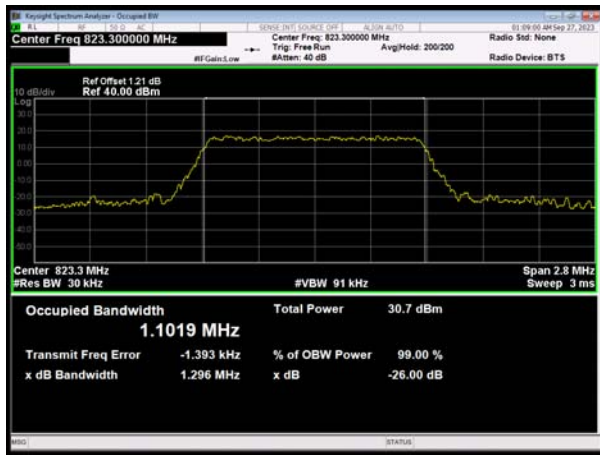

LTE Band 26 64QAM 3MHz CH High

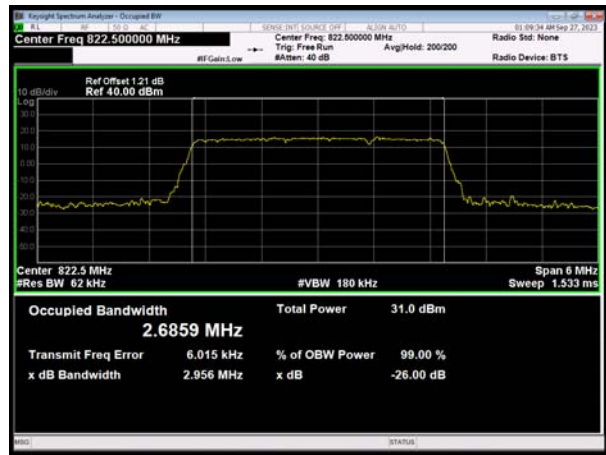

LTE Band 26 64QAM 5MHz CH Low

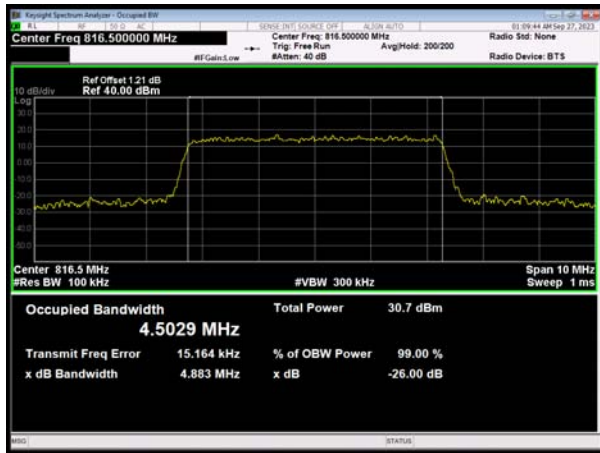

LTE Band 26 64QAM 10MHz CH Middle

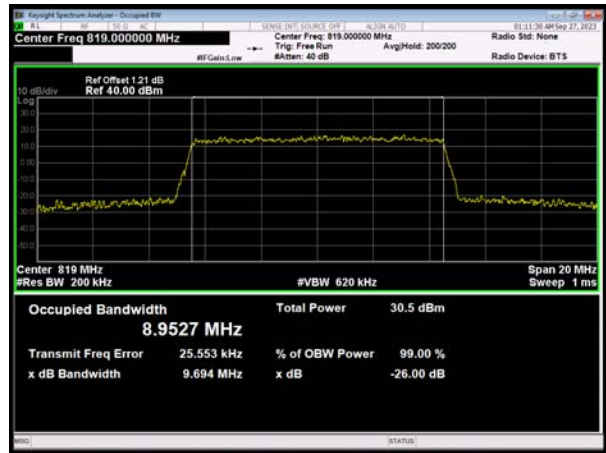

LTE Band 26 64QAM 5MHz CH Middle

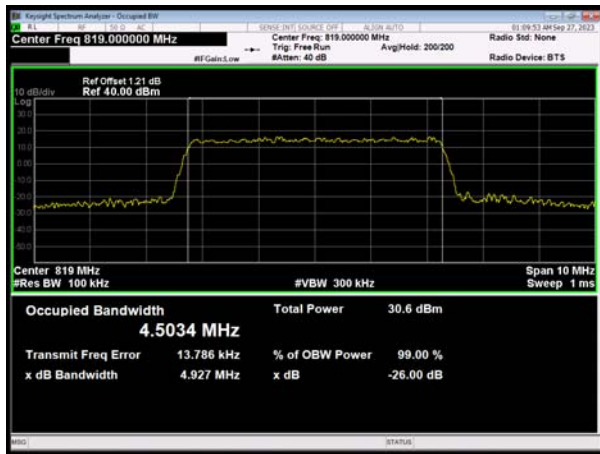

LTE Band 26 64QAM 5MHz CH High

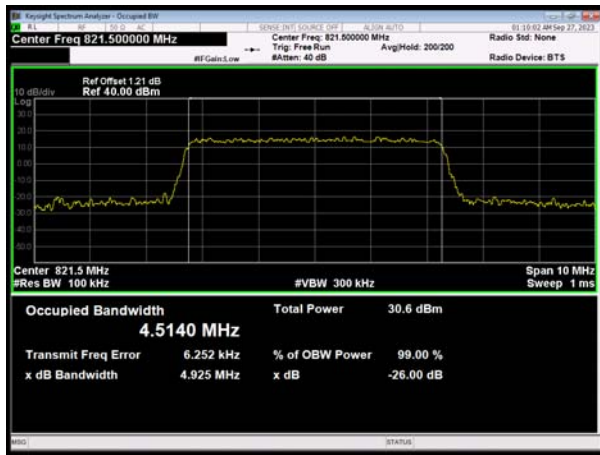

6.3. Emission Mask

LTE Band 26 QPSK 1.4MHz CH-Low 1RB

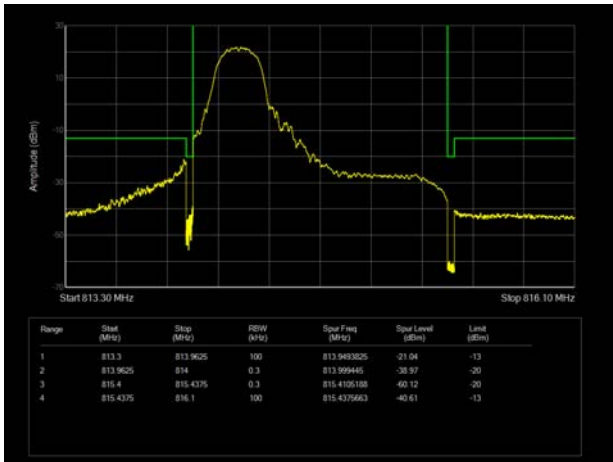

LTE Band 26 QPSK 1.4MHz CH-High 1RB

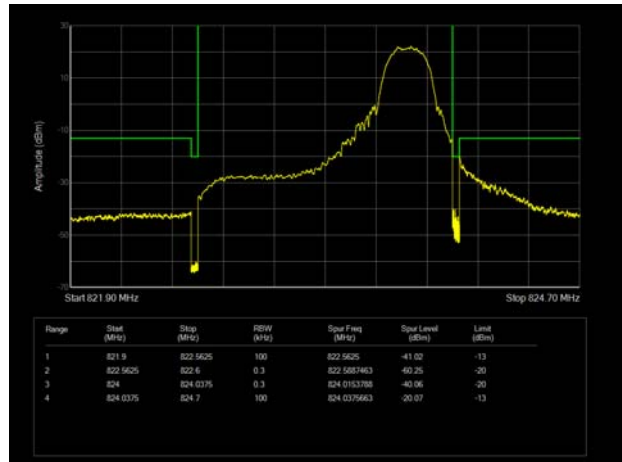

LTE Band 26 QPSK 1.4MHz CH-Low 100%RB

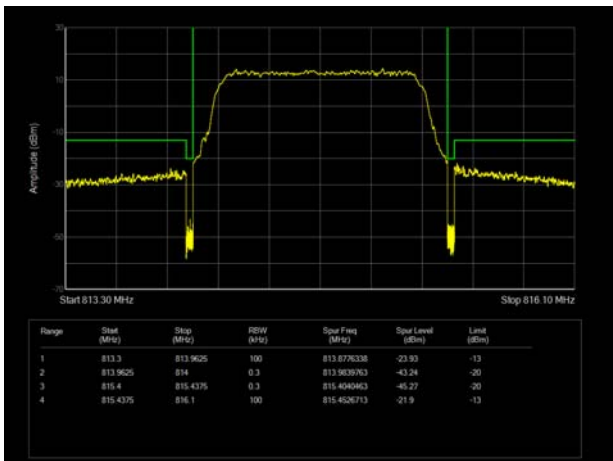

LTE Band 26 QPSK 1.4MHz CH-High 100%RB

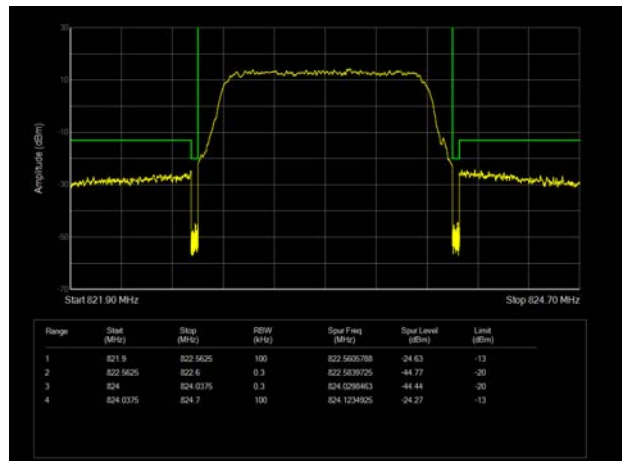

LTE Band 26 QPSK 3MHz CH-Low 1RB

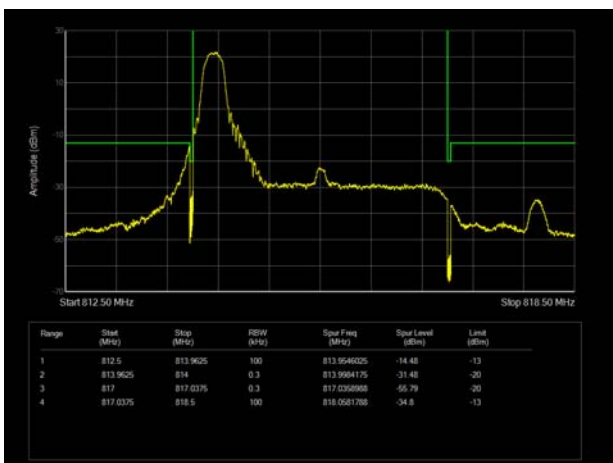

LTE Band 26 QPSK 3MHz CH-High 1RB

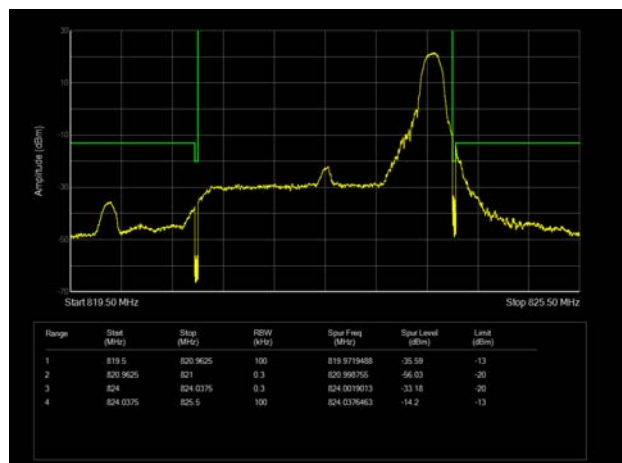

LTE Band 26 QPSK 3MHz CH-Low 100%RB

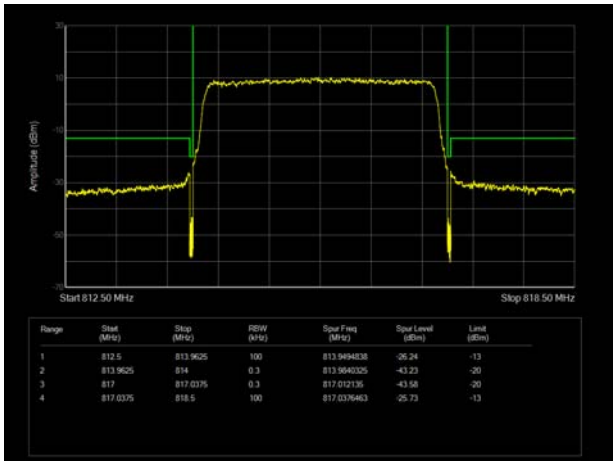

LTE Band 26 QPSK 3MHz CH-High 100%RB

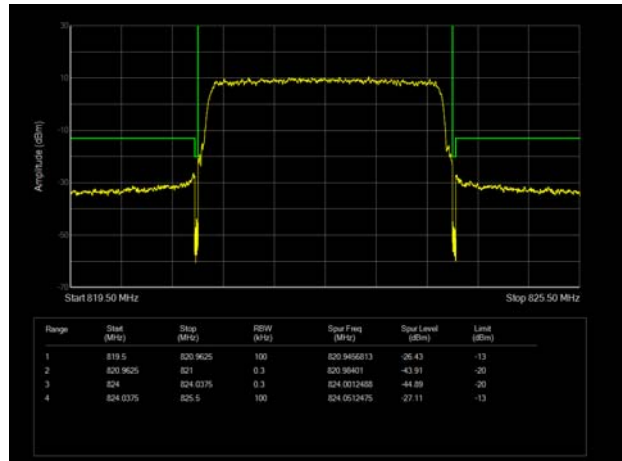

LTE Band 26 QPSK 5MHz CH-Low 1RB

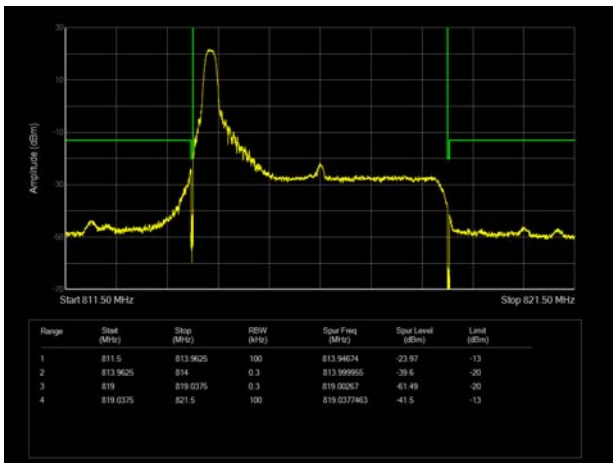

LTE Band 26 QPSK 5MHz CH-High 1RB

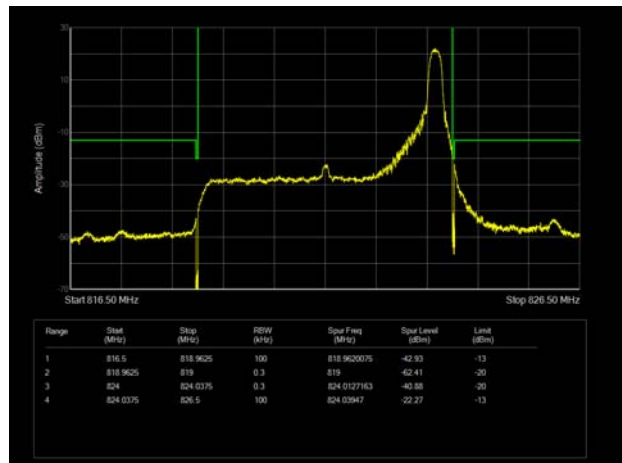

LTE Band 26 QPSK 5MHz CH-Low 100%RB

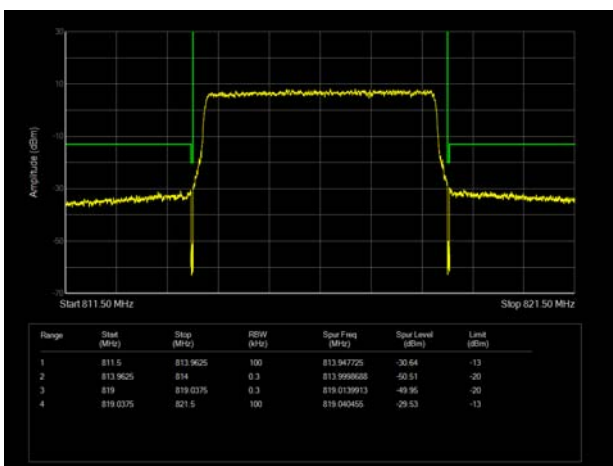

LTE Band 26 QPSK 5MHz CH-High 100%RB

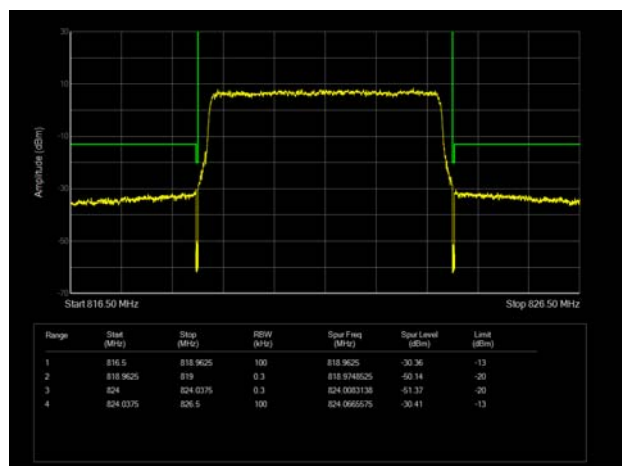

LTE Band 26 QPSK 10MHz CH-Low 1RB

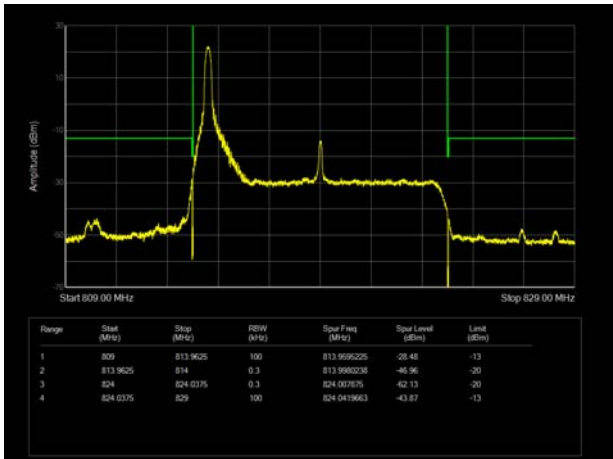

LTE Band 26 QPSK 10MHz CH-High 1RB

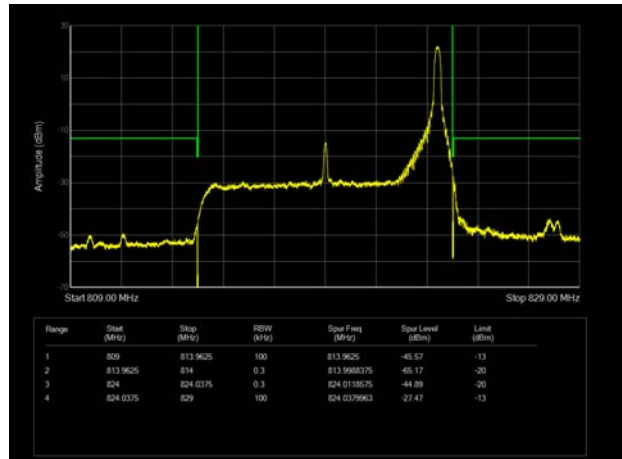

LTE Band 26 QPSK 10MHz CH-Low 100%RB

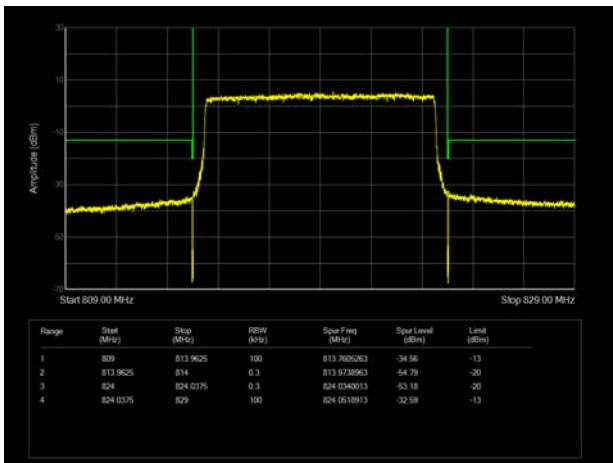

LTE Band 26 QPSK 10MHz CH-High 100%RB

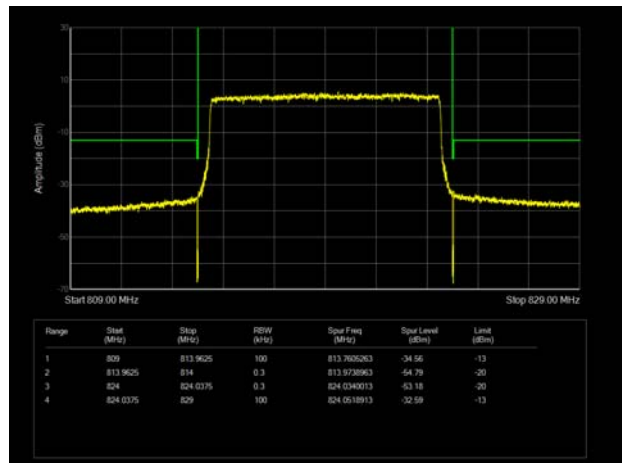

LTE Band 26 16QAM 1.4MHz CH-Low 1RB

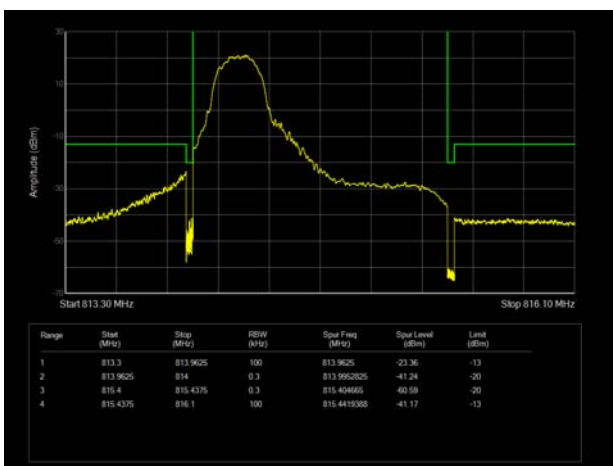

LTE Band 26 16QAM 1.4MHz CH-High 1RB

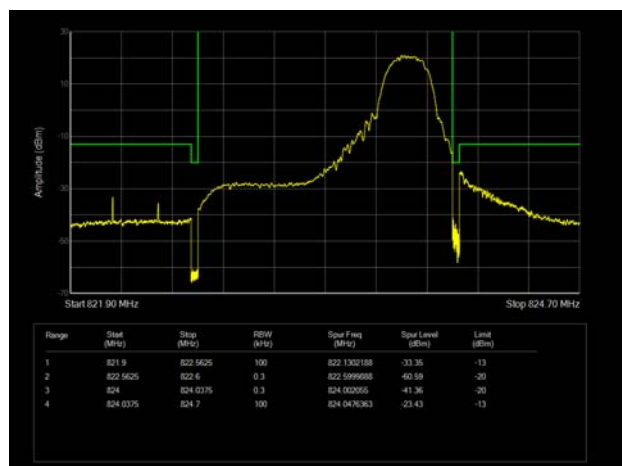

LTE Band 26 16QAM 1.4MHz CH-Low 100%RB

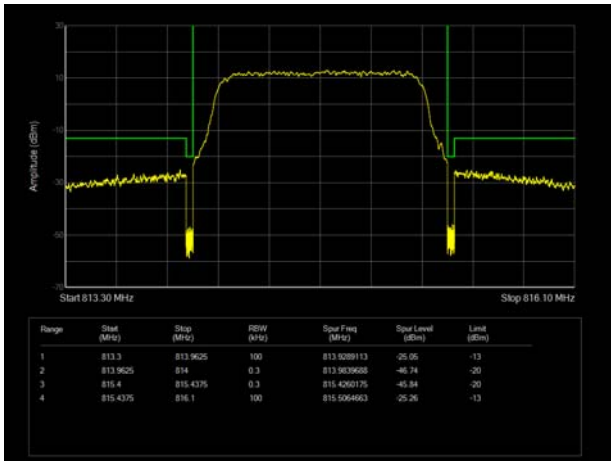

LTE Band 26 16QAM 1.4MHz CH-High 100%RB

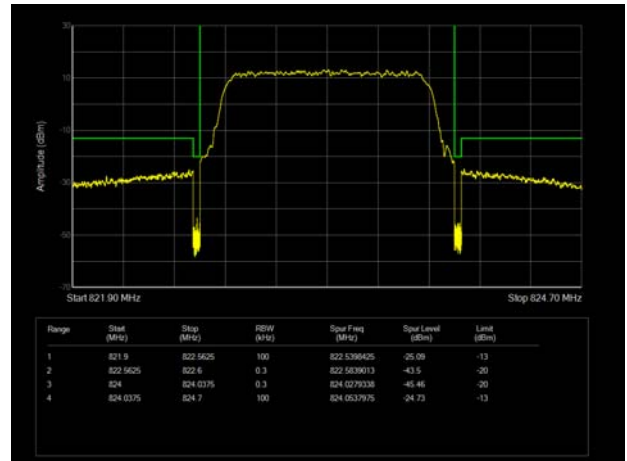

LTE Band 26 16QAM 3MHz CH-Low 1RB

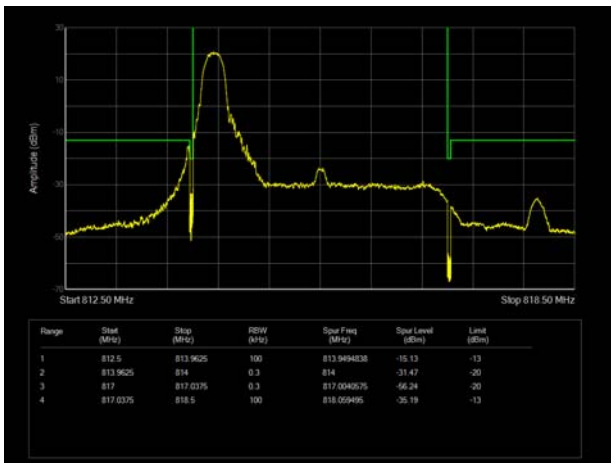

LTE Band 26 16QAM 3MHz CH-High 1RB

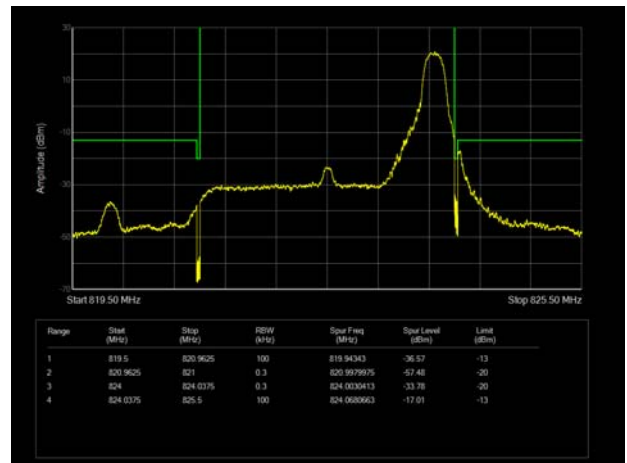

LTE Band 26 16QAM 3MHz CH-Low 100%RB

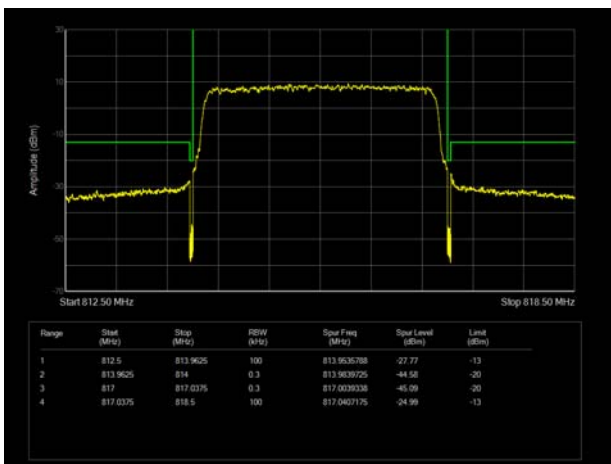

LTE Band 26 16QAM 3MHz CH-High 100%RB

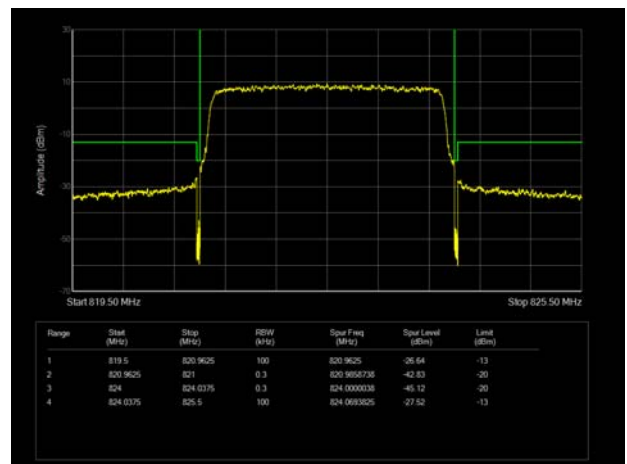

LTE Band 26 16QAM 5MHz CH-Low 1RB

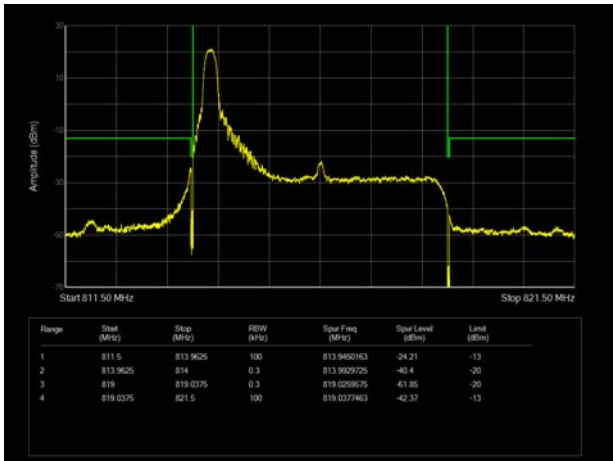

LTE Band 26 16QAM 5MHz CH-High 1RB

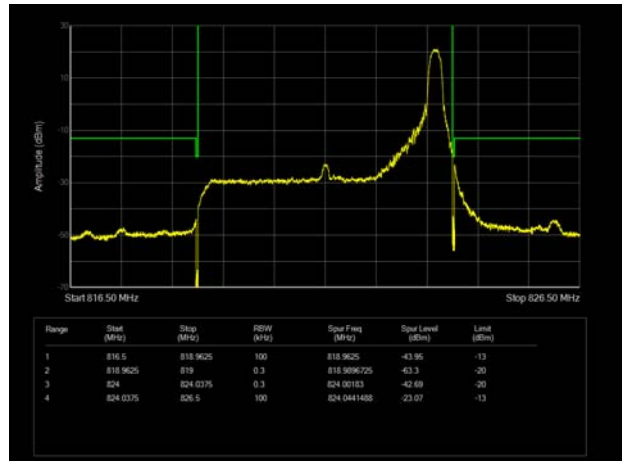

LTE Band 26 16QAM 5MHz CH-Low 100%RB

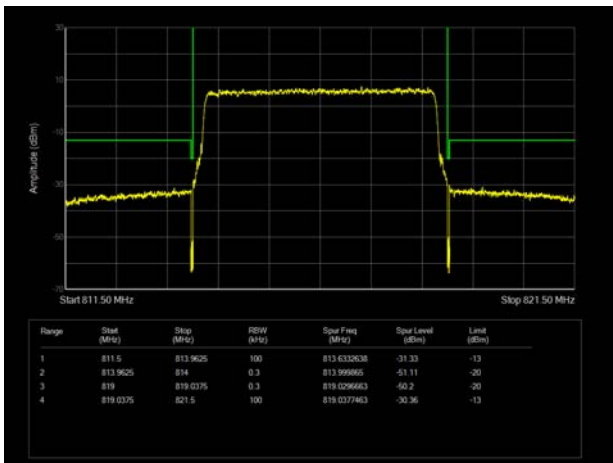

LTE Band 26 16QAM 5MHz CH-High 100%RB

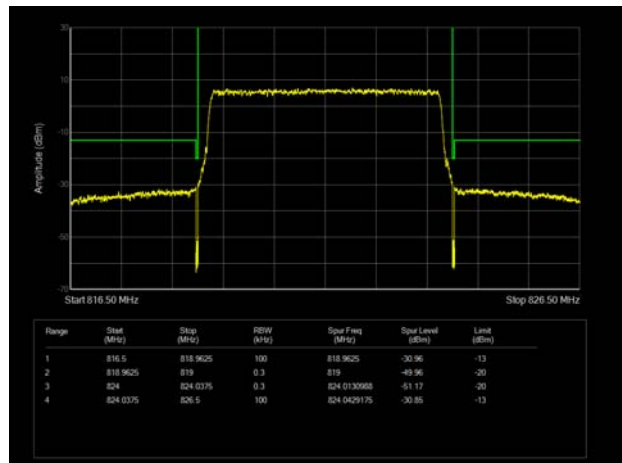

LTE Band 26 16QAM 10MHz CH-Low 1RB

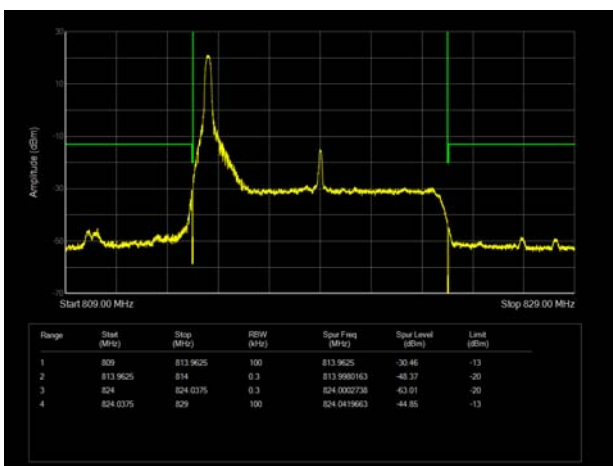

LTE Band 26 16QAM 10MHz CH-High 1RB

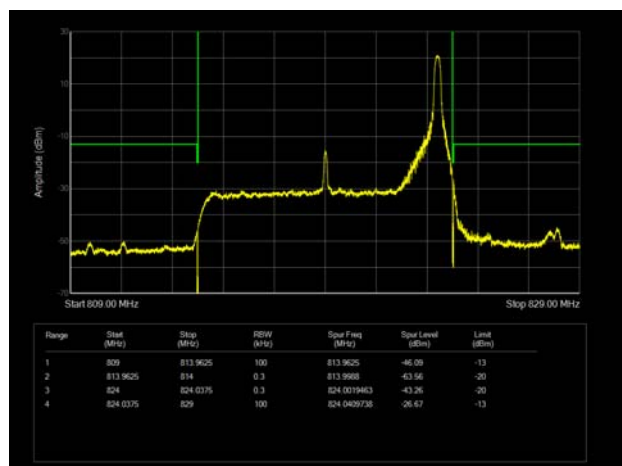

LTE Band 26 16QAM 10MHz CH-Low 100%RB

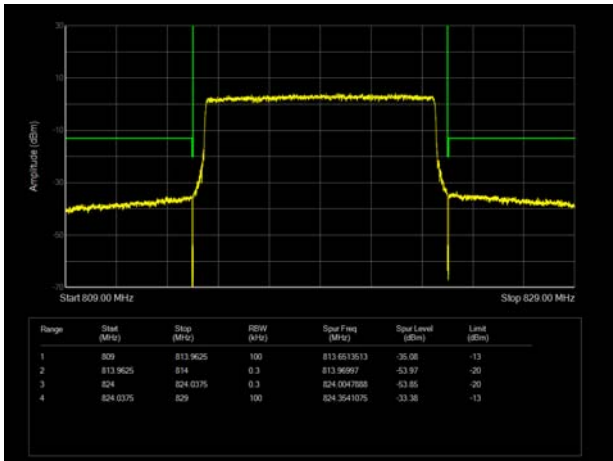

LTE Band 26 16QAM 10MHz CH-High 100%RB

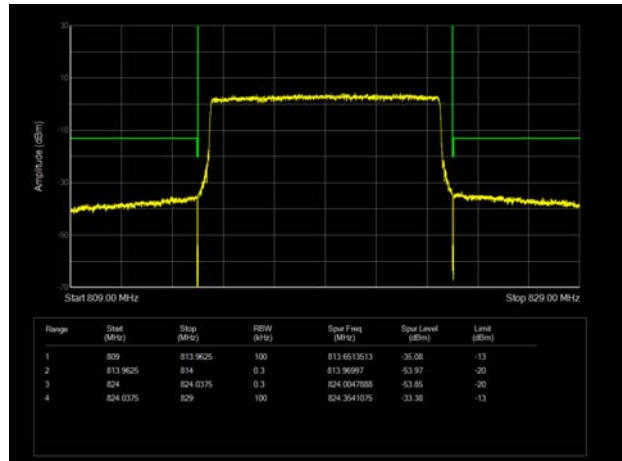

LTE Band 26 64QAM 1.4MHz CH-Low 1RB

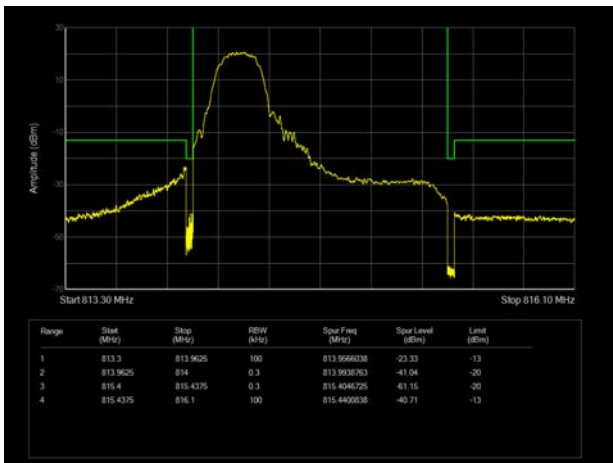

LTE Band 26 64QAM 1.4MHz CH-High 1RB

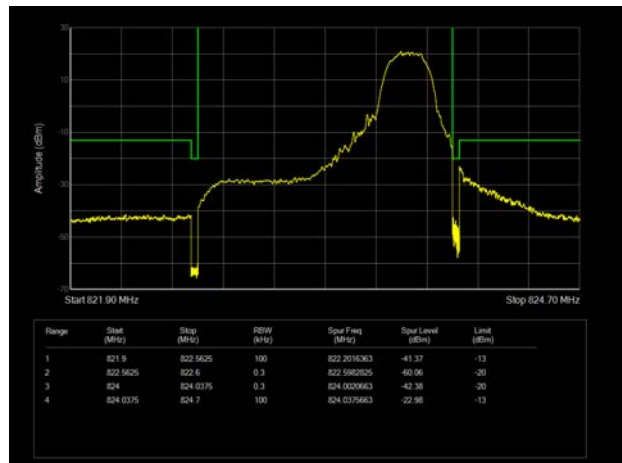

LTE Band 26 64QAM 1.4MHz CH-Low 100%RB

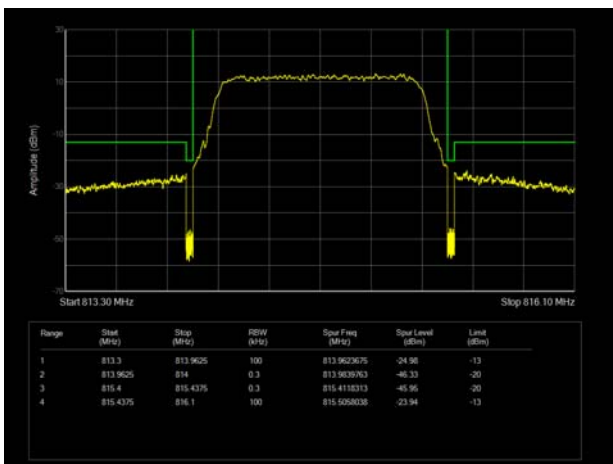

LTE Band 26 64QAM 1.4MHz CH-High 100%RB

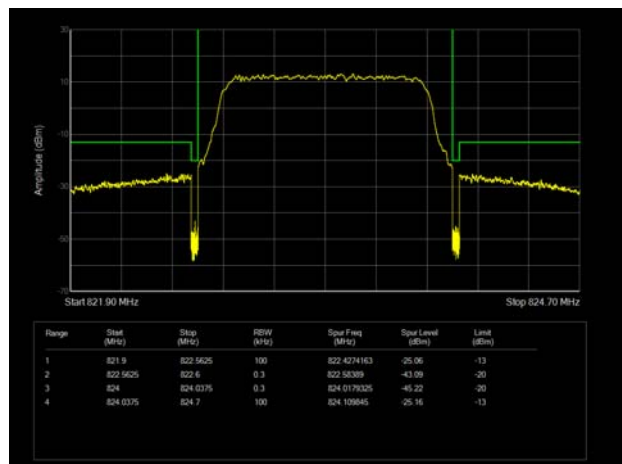

LTE Band 26 64QAM 3MHz CH-Low 1RB

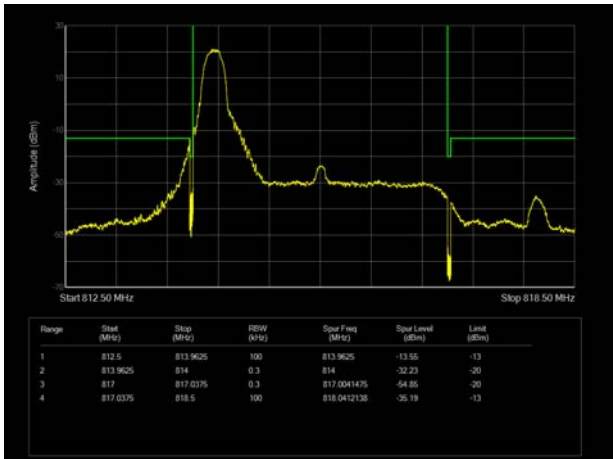

LTE Band 26 64QAM 3MHz CH-High 1RB

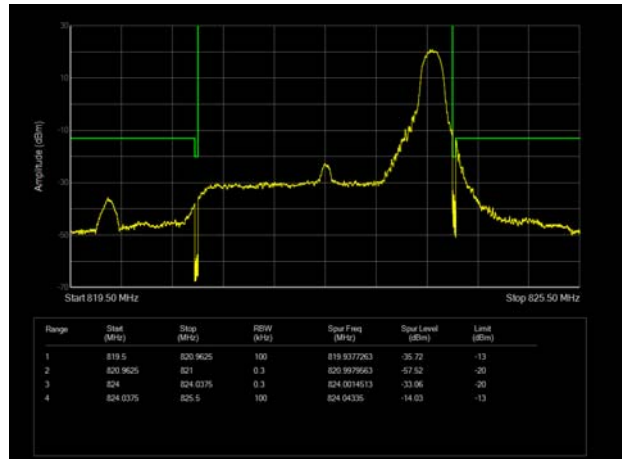

LTE Band 26 64QAM 3MHz CH-Low 100%RB

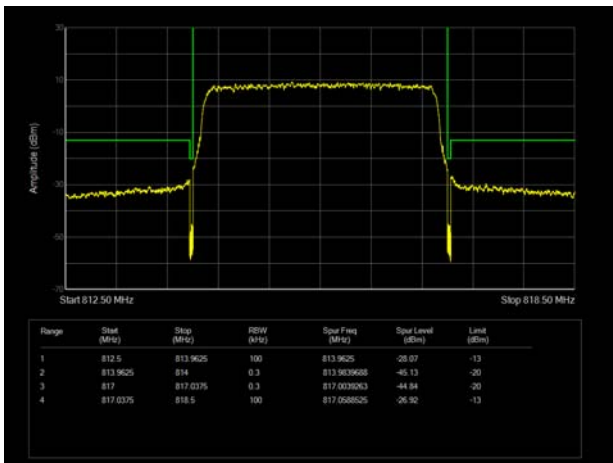

LTE Band 26 64QAM 3MHz CH-High 100%RB

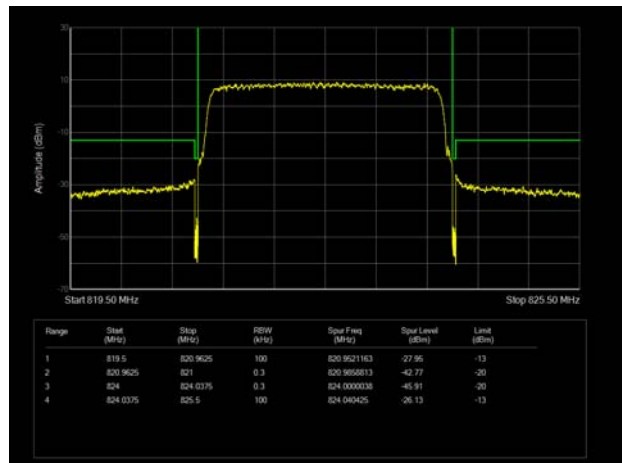

LTE Band 26 64QAM 5MHz CH-Low 1RB

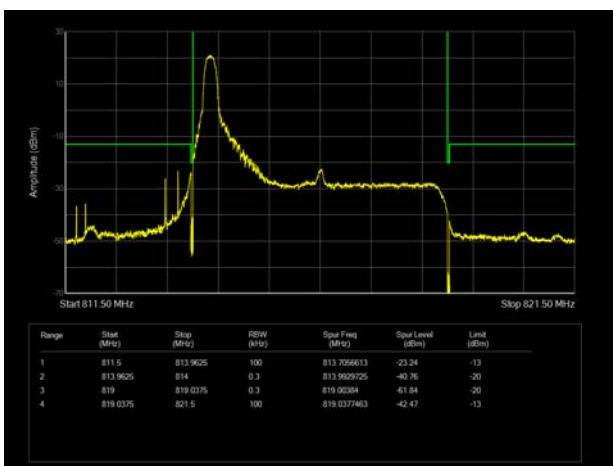

LTE Band 26 64QAM 5MHz CH-High 1RB

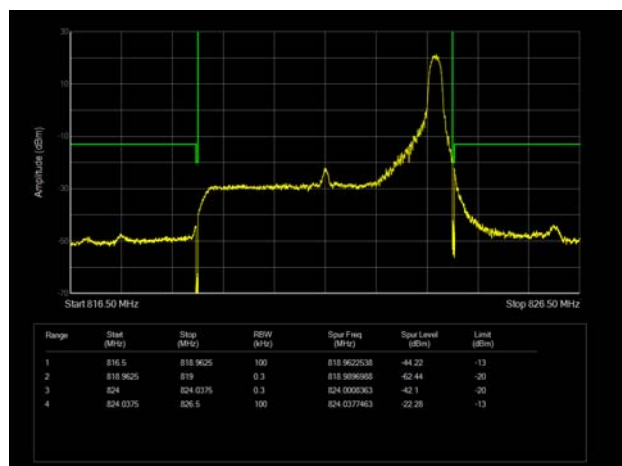

LTE Band 26 64QAM 5MHz CH-Low 100%RB

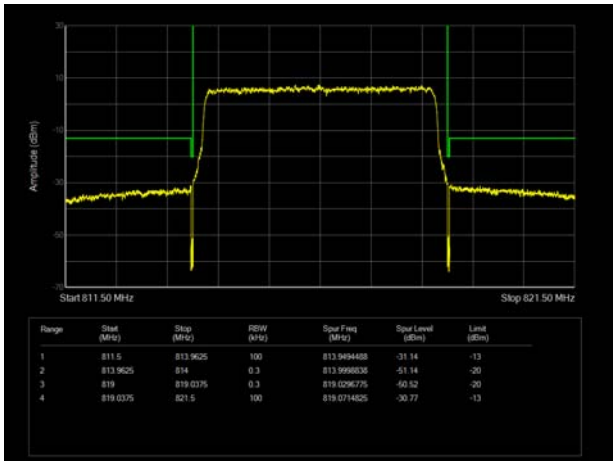

LTE Band 26 64QAM 5MHz CH-High 100%RB

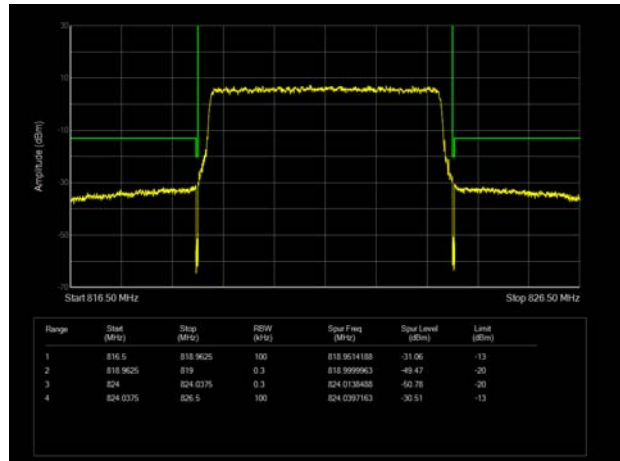

LTE Band 26 64QAM 10MHz CH-Low 1RB

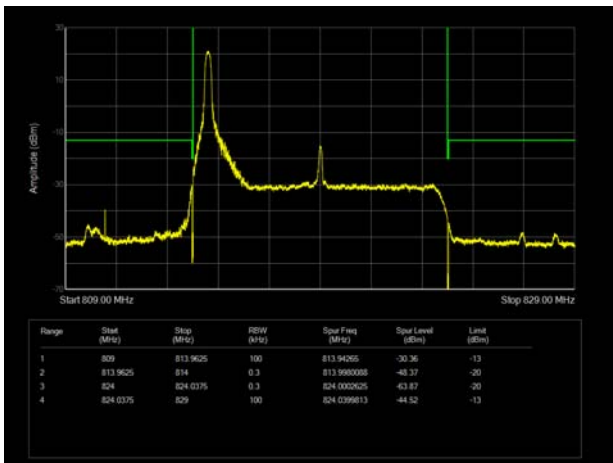

LTE Band 26 64QAM 10MHz CH-High 1RB

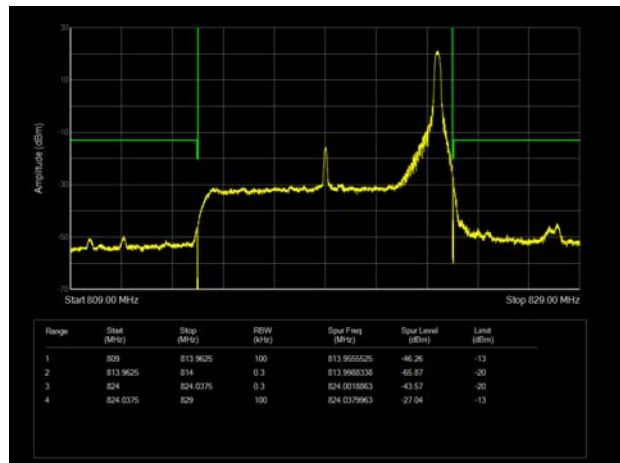

LTE Band 26 64QAM 10MHz CH-Low 100%RB

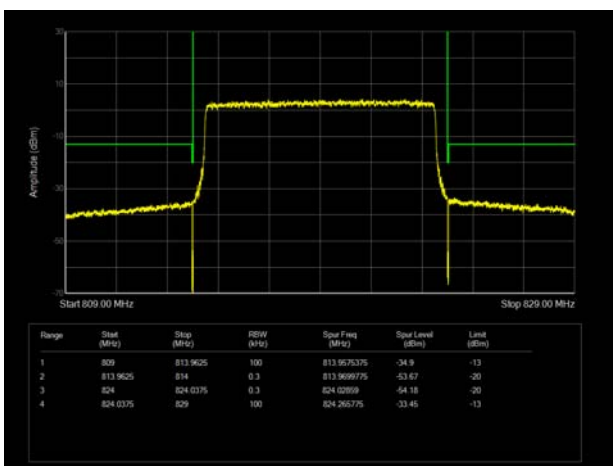

LTE Band 26 64QAM 10MHz CH-High 100%RB

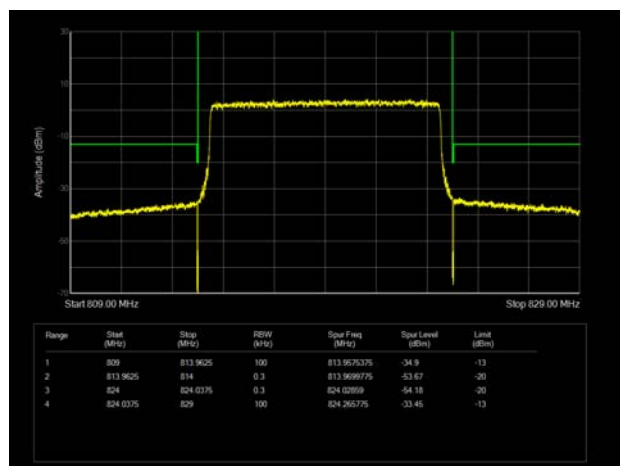

6.4. Peak-to-Average Power Ratio (PAPR)

Mode	Channel	Frequency (MHz)	Peak (dBm)	Avg (dBm)	PAPR (dB)	Limit (dB)	Conclusion
1.4 MHz (QPSK)	26697	814.7	28.42	23.59	4.83	13	PASS
	26740	819	28.41	23.60	4.81	13	PASS
	26783	823.3	28.60	23.58	5.02	13	PASS
3 MHz (QPSK)	26697	814.7	28.43	23.49	4.94	13	PASS
	26740	819	28.37	23.52	4.85	13	PASS
	26783	823.3	28.45	23.48	4.97	13	PASS
5 MHz (QPSK)	26697	814.7	28.57	23.58	4.99	13	PASS
	26740	819	28.48	23.54	4.94	13	PASS
	26783	823.3	28.58	23.58	5.00	13	PASS
10 MHz (QPSK)	26740	819	28.64	23.59	5.05	13	PASS
1.4 MHz (16QAM)	26697	814.7	28.14	22.58	5.56	13	PASS
	26740	819	28.28	22.66	5.62	13	PASS
	26783	823.3	28.37	22.58	5.79	13	PASS
3 MHz (16QAM)	26697	814.7	28.24	22.49	5.75	13	PASS
	26740	819	28.25	22.49	5.76	13	PASS
	26783	823.3	28.35	22.51	5.84	13	PASS
5 MHz (16QAM)	26697	814.7	28.33	22.62	5.71	13	PASS
	26740	819	28.27	22.55	5.72	13	PASS
	26783	823.3	28.38	22.61	5.77	13	PASS
10 MHz (16QAM)	26740	819	28.44	22.55	5.89	13	PASS
1.4 MHz (64QAM)	26697	814.7	28.30	22.63	5.67	13	PASS
	26740	819	28.22	22.62	5.60	13	PASS
	26783	823.3	28.38	22.52	5.86	13	PASS
3 MHz (64QAM)	26697	814.7	28.27	22.48	5.79	13	PASS
	26740	819	28.22	22.47	5.75	13	PASS
	26783	823.3	28.30	22.47	5.83	13	PASS
5 MHz (64QAM)	26697	814.7	28.29	22.59	5.70	13	PASS
	26740	819	28.26	22.58	5.68	13	PASS
	26783	823.3	28.39	22.59	5.80	13	PASS
10 MHz (64QAM)	26740	819	28.44	22.58	5.86	13	PASS

6.5. Frequency Stability

LTE Band 26								
Condition		Freq.Error (Hz)	Freq.Error (Hz)	Freq.Error (Hz)	Frequency Stability (ppm)	Frequency Stability (ppm)	Frequency Stability (ppm)	Verdict
BANDWIDTH	1.4MHz							
Temperature	Voltage	64QAM	16QAM	QPSK	64QAM	16QAM	QPSK	
Normal (25°C)	Normal	8.22	13.23	14.89	0.01004	0.01615	0.01818	PASS
Extreme (50°C)		11.81	12.98	2.21	0.01442	0.01584	0.00270	PASS
Extreme (40°C)		17.79	6.22	3.07	0.02172	0.00759	0.00375	PASS
Extreme (30°C)		8.55	16.47	13.04	0.01044	0.02011	0.01593	PASS
Extreme (20°C)		5.11	11.60	16.24	0.00624	0.01416	0.01983	PASS
Extreme (10°C)		11.51	16.05	10.47	0.01406	0.01960	0.01278	PASS
Extreme (0°C)		9.05	14.71	13.93	0.01105	0.01796	0.01701	PASS
Extreme (-10°C)		2.73	17.12	13.52	0.00333	0.02090	0.01651	PASS
Extreme (-20°C)		15.56	11.23	6.54	0.01900	0.01371	0.00799	PASS
Extreme (-30°C)		1.94	15.92	16.62	0.00237	0.01944	0.02030	PASS
25°C		LV	7.26	2.09	13.81	0.00887	0.00255	0.01686
	HV	12.49	14.98	9.17	0.01525	0.01829	0.01120	PASS
Condition		Freq.Error (Hz)	Freq.Error (Hz)	Freq.Error (Hz)	Frequency Stability (ppm)	Frequency Stability (ppm)	Frequency Stability (ppm)	Verdict
BANDWIDTH	3MHz							
Temperature	Voltage	64QAM	16QAM	QPSK	64QAM	16QAM	QPSK	
Normal (25°C)	Normal	4.27	6.60	5.66	0.00521	0.00806	0.00691	PASS
Extreme (50°C)		8.16	6.47	8.45	0.00997	0.00790	0.01031	PASS
Extreme (40°C)		1.59	8.26	2.32	0.00194	0.01008	0.00283	PASS
Extreme (30°C)		14.99	15.62	13.85	0.01830	0.01908	0.01692	PASS
Extreme (20°C)		4.82	5.46	7.70	0.00589	0.00667	0.00940	PASS
Extreme (10°C)		11.31	8.12	1.19	0.01381	0.00991	0.00146	PASS
Extreme (0°C)		14.54	2.44	3.76	0.01775	0.00298	0.00459	PASS
Extreme (-10°C)		4.90	10.08	14.14	0.00599	0.01230	0.01726	PASS
Extreme (-20°C)		9.65	10.29	1.91	0.01179	0.01256	0.00233	PASS
Extreme (-30°C)		6.57	6.36	8.63	0.00802	0.00776	0.01054	PASS
25°C		LV	6.11	12.38	12.65	0.00746	0.01512	0.01544
	HV	9.28	6.07	16.05	0.01133	0.00742	0.01959	PASS
Condition		Freq.Error (Hz)	Freq.Error (Hz)	Freq.Error (Hz)	Frequency Stability (ppm)	Frequency Stability (ppm)	Frequency Stability (ppm)	Verdict
BANDWIDTH	5MHz							
Temperature	Voltage	64QAM	16QAM	QPSK	64QAM	16QAM	QPSK	

Normal (25°C)	Normal	6.63	10.21	13.97	0.00810	0.01247	0.01706	PASS
Extreme (50°C)		9.60	17.91	4.53	0.01172	0.02187	0.00553	PASS
Extreme (40°C)		7.71	10.93	6.45	0.00941	0.01334	0.00787	PASS
Extreme (30°C)		17.49	10.29	4.61	0.02135	0.01256	0.00563	PASS
Extreme (20°C)		16.58	12.97	12.10	0.02025	0.01584	0.01478	PASS
Extreme (10°C)		9.29	16.58	10.55	0.01134	0.02024	0.01288	PASS
Extreme (0°C)		9.49	2.32	8.41	0.01158	0.00283	0.01027	PASS
Extreme (-10°C)		6.41	8.18	14.94	0.00783	0.00999	0.01824	PASS
Extreme (-20°C)		17.79	6.29	7.26	0.02172	0.00768	0.00887	PASS
Extreme (-30°C)		9.83	13.32	11.07	0.01200	0.01626	0.01352	PASS
25°C		LV	2.71	17.74	10.75	0.00331	0.02166	0.01313
	HV	5.75	6.80	13.48	0.00702	0.00831	0.01646	PASS
Condition		Freq.Error (Hz)	Freq.Error (Hz)	Freq.Error (Hz)	Frequency Stability (ppm)	Frequency Stability (ppm)	Frequency Stability (ppm)	Verdict
BANDWIDTH	10MHz							
Temperature	Voltage	64QAM	16QAM	QPSK	64QAM	16QAM	QPSK	
Normal (25°C)	Normal	7.90	3.71	15.44	0.00965	0.00453	0.01885	
Extreme (50°C)		10.80	12.73	17.18	0.01318	0.01554	0.02097	PASS
Extreme (40°C)		9.21	12.94	16.76	0.01125	0.01580	0.02047	PASS
Extreme (30°C)		7.37	1.37	11.77	0.00900	0.00168	0.01437	PASS
Extreme (20°C)		10.18	15.04	15.16	0.01244	0.01837	0.01851	PASS
Extreme (10°C)		17.77	3.78	10.03	0.02170	0.00462	0.01224	PASS
Extreme (0°C)		12.09	11.78	15.04	0.01477	0.01438	0.01837	PASS
Extreme (-10°C)		10.18	3.77	6.11	0.01243	0.00461	0.00745	PASS
Extreme (-20°C)		6.43	10.29	7.67	0.00786	0.01257	0.00936	PASS
Extreme (-30°C)		7.53	4.94	13.24	0.00919	0.00604	0.01617	PASS
25°C		LV	5.58	17.79	1.71	0.00681	0.02172	0.00209
	HV	4.30	11.77	3.51	0.00526	0.01437	0.00428	PASS

6.6. Spurious Emissions at Antenna Terminals

If disturbances were found more than 20dB below limit line, the mark is not required for the EUT. The signal beyond the limit is carrier.

LTE Band 26 1.4MHz CH Low 9kHz~10GHz

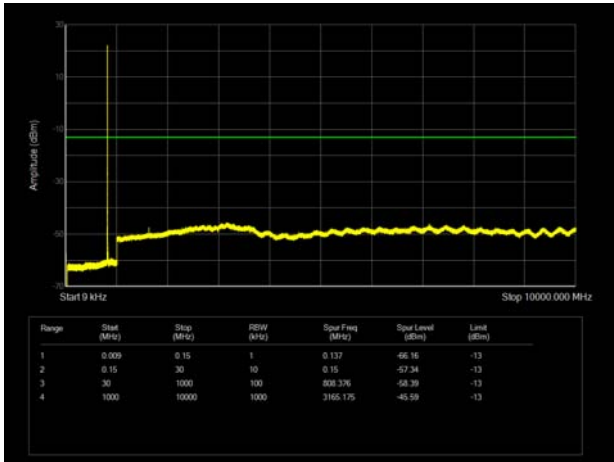

LTE Band 26 3MHz CH Low 9kHz~10GHz

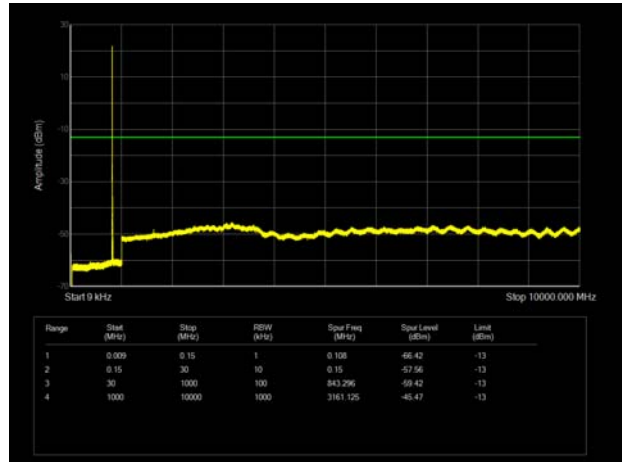

LTE Band 26 1.4MHz CH Middle 9kHz~10GHz

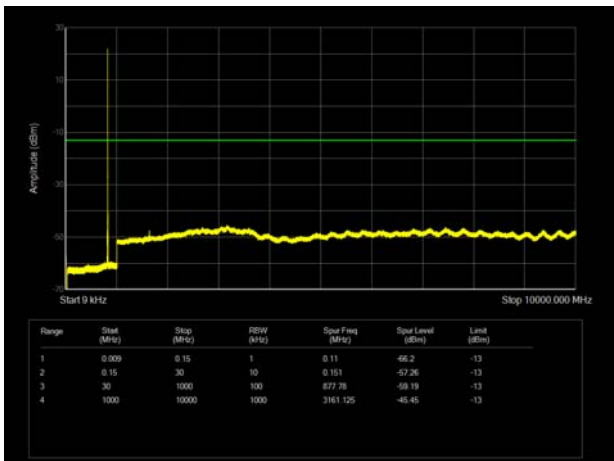

LTE Band 26 3MHz CH Middle 9kHz~10GHz

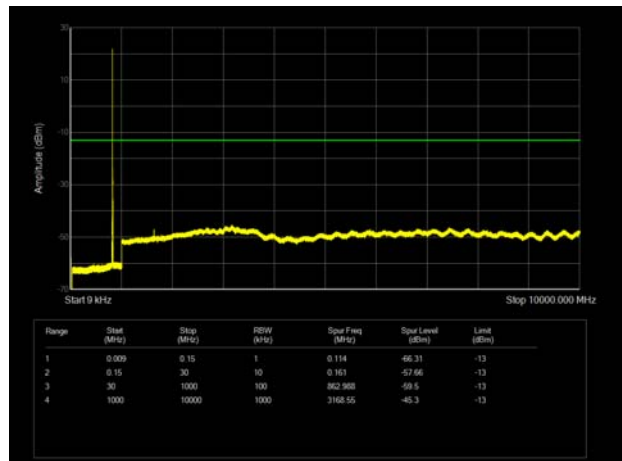

LTE Band 26 1.4MHz CH High 9kHz~10GHz

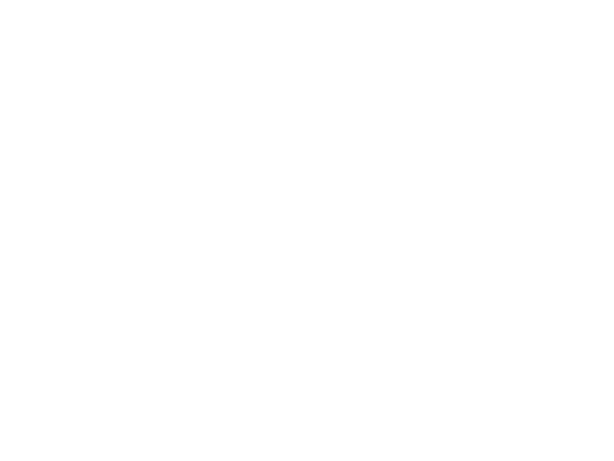

LTE Band 26 3MHz CH High 9kHz~10GHz

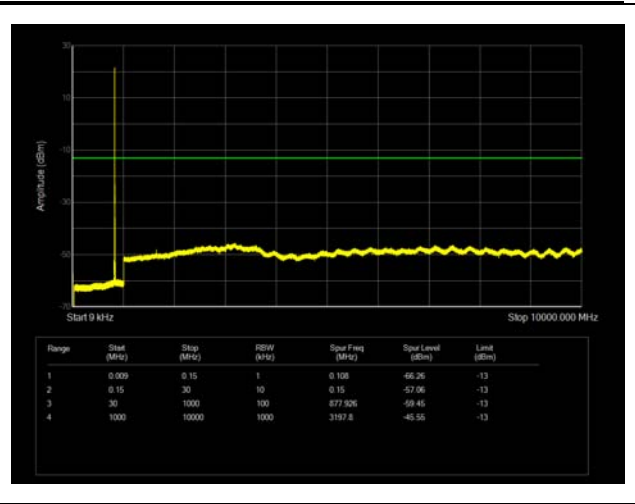
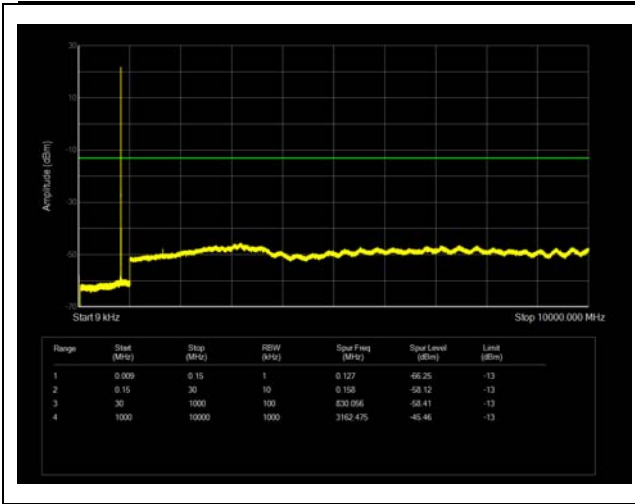

LTE Band 26 5MHz CH Low 9kHz~10GHz

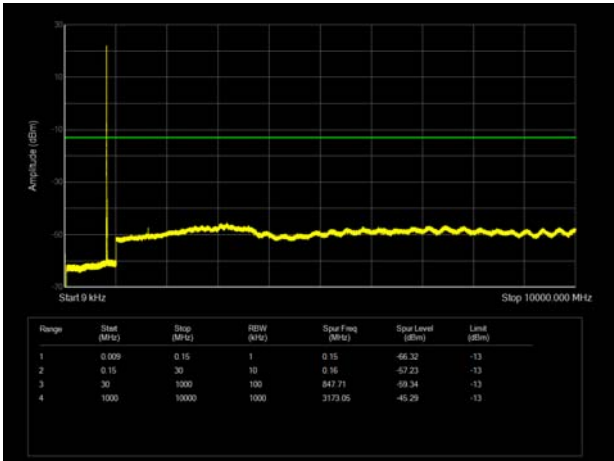

LTE Band 26 10MHz CH Middle 9kHz~10GHz

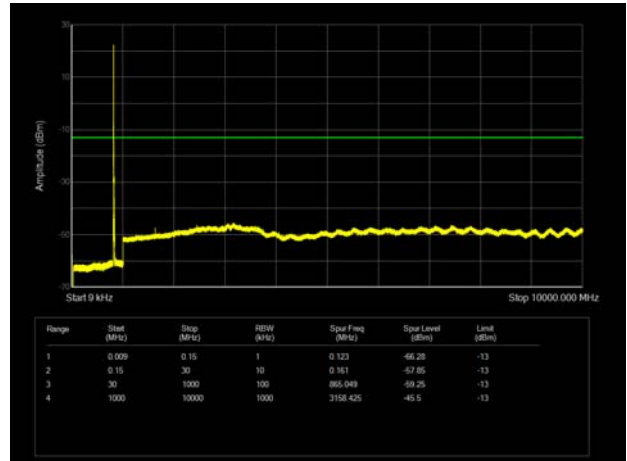

LTE Band 26 5MHz CH Middle 9kHz~10GHz

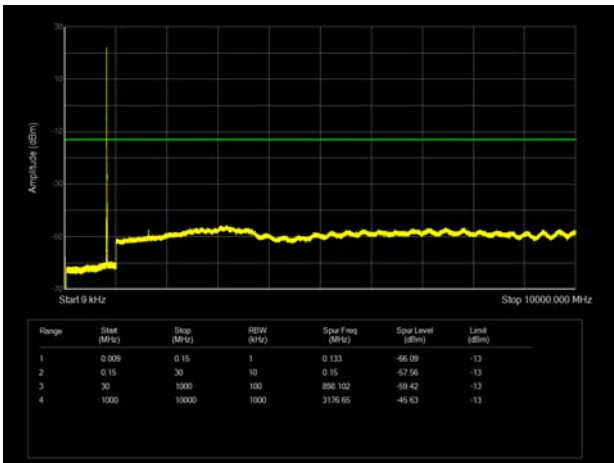

LTE Band 26 5MHz CH High 9kHz~10GHz

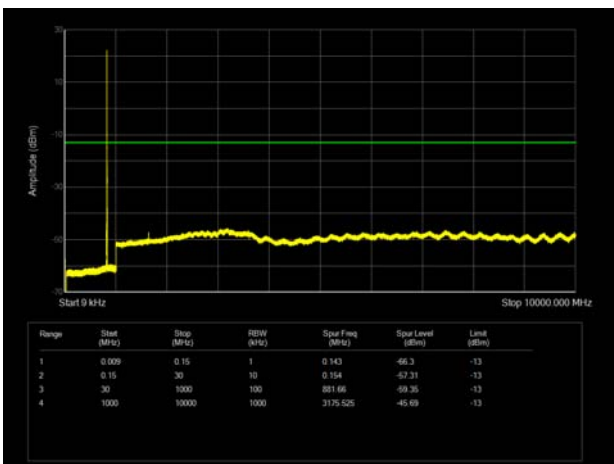

6.7. Radiated Spurious Emission

Sweep the whole frequency band through the range from 9kHz to the 10th harmonic of the carrier, the emissions below the noise floor will not be recorded in the report.

Low Antenna

LTE Band 26 1.4MHz CH Middle

Harmonic	Frequency (MHz)	SG (dBm)	Cable Loss (dB)	Gain (dBi)	Antenna Polarization	ERP Level (dBm)	Limit (dBm)	Margin (dB)	Azimuth (deg)
2	1636.60	-66.93	1.70	8.70	Horizontal	-62.08	-13.00	49.08	135
3	2454.90	-66.93	2.30	12.00	Horizontal	-59.38	-13.00	46.38	90
4	3273.20	-66.91	2.20	13.10	Horizontal	-58.16	-13.00	45.16	165
5	4091.50	-64.25	3.00	12.50	Horizontal	-56.90	-13.00	43.90	17
6	4909.80	-62.30	3.10	12.50	Horizontal	-55.05	-13.00	42.05	52
7	5728.10	-60.75	3.40	12.50	Horizontal	-53.80	-13.00	40.80	136
8	6546.40	-59.71	3.80	11.50	Horizontal	-54.16	-13.00	41.16	47
9	7364.70	-55.38	4.20	12.20	Horizontal	-49.53	-13.00	36.53	165
10	8183.00	-55.72	4.30	12.30	Horizontal	-49.87	-13.00	36.87	15

Note: 1.The other Spurious RF Radiated emissions level is no more than noise floor.
2.The worst emission was found in the antenna is Horizontal position.

LTE Band 26 5MHz CH Middle

Harmonic	Frequency (MHz)	SG (dBm)	Cable Loss (dB)	Gain (dBi)	Antenna Polarization	ERP Level (dBm)	Limit (dBm)	Margin (dB)	Azimuth (deg)
2	1633.00	-68.59	1.70	8.70	Horizontal	-63.74	-13.00	50.74	180
3	2449.50	-64.76	2.30	12.00	Horizontal	-57.21	-13.00	44.21	45
4	3266.00	-67.40	2.20	13.10	Horizontal	-58.65	-13.00	45.65	16
5	4082.50	-63.83	3.00	12.50	Horizontal	-56.48	-13.00	43.48	13
6	4899.00	-62.22	3.10	12.50	Horizontal	-54.97	-13.00	41.97	0
7	5715.50	-60.92	3.40	12.50	Horizontal	-53.97	-13.00	40.97	45
8	6532.00	-58.92	3.80	11.50	Horizontal	-53.37	-13.00	40.37	15
9	7348.50	-55.68	4.20	12.20	Horizontal	-49.83	-13.00	36.83	17
10	8165.00	-54.75	4.30	12.30	Horizontal	-48.90	-13.00	35.90	135

Note: 1.The other Spurious RF Radiated emissions level is no more than noise floor.
2.The worst emission was found in the antenna is Horizontal position.

LTE Band 26 10MHz CH Middle

Harmonic	Frequency (MHz)	SG (dBm)	Cable Loss (dB)	Gain (dBi)	Antenna Polarization	ERP Level (dBm)	Limit (dBm)	Margin (dB)	Azimuth (deg)
2	1628.00	-68.29	1.70	8.70	Horizontal	-63.44	-13.00	50.44	162
3	2442.00	-64.92	2.30	12.00	Horizontal	-57.37	-13.00	44.37	78
4	3256.00	-66.73	2.20	13.10	Horizontal	-57.98	-13.00	44.98	287
5	4070.00	-63.97	3.00	12.50	Horizontal	-56.62	-13.00	43.62	11
6	4884.00	-62.36	3.10	12.50	Horizontal	-55.11	-13.00	42.11	38
7	5698.00	-61.10	3.40	12.50	Horizontal	-54.15	-13.00	41.15	135
8	6512.00	-59.38	3.80	11.50	Horizontal	-53.83	-13.00	40.83	17
9	7326.00	-55.53	4.20	12.20	Horizontal	-49.68	-13.00	36.68	165
10	8140.00	-55.03	4.30	12.30	Horizontal	-49.18	-13.00	36.18	15

Note: 1.The other Spurious RF Radiated emissions level is no more than noise floor.

2.The worst emission was found in the antenna is Horizontal position.

Upper Antenna

LTE Band 26 1.4MHz CH Middle

Harmonic	Frequency (MHz)	SG (dBm)	Cable Loss (dB)	Gain (dBi)	Antenna Polarization	ERP Level (dBm)	Limit (dBm)	Margin (dB)	Azimuth (deg)
2	1636.60	-66.29	1.70	8.70	Vertical	-61.44	-13.00	48.44	45
3	2454.90	-62.02	2.30	12.00	Vertical	-54.47	-13.00	41.47	168
4	3273.20	-67.34	2.20	13.10	Vertical	-58.59	-13.00	45.59	165
5	4091.50	-63.54	3.00	12.50	Vertical	-56.19	-13.00	43.19	17
6	4909.80	-61.82	3.10	12.50	Vertical	-54.57	-13.00	41.57	52
7	5728.10	-60.97	3.40	12.50	Vertical	-54.02	-13.00	41.02	136
8	6546.40	-59.87	3.80	11.50	Vertical	-54.32	-13.00	41.32	47
9	7364.70	-54.88	4.20	12.20	Vertical	-49.03	-13.00	36.03	165
10	8183.00	-54.79	4.30	12.30	Vertical	-48.94	-13.00	35.94	15

Note: 1.The other Spurious RF Radiated emissions level is no more than noise floor.

2.The worst emission was found in the antenna is Vertical position.

LTE Band 26 5MHz CH Middle

Harmonic	Frequency (MHz)	SG (dBm)	Cable Loss (dB)	Gain (dBi)	Antenna Polarization	ERP Level (dBm)	Limit (dBm)	Margin (dB)	Azimuth (deg)
2	1633.00	-67.61	1.70	8.70	Vertical	-62.76	-13.00	49.76	91
3	2449.50	-63.37	2.30	12.00	Vertical	-55.82	-13.00	42.82	0
4	3266.00	-67.73	2.20	13.10	Vertical	-58.98	-13.00	45.98	16
5	4082.50	-62.26	3.00	12.50	Vertical	-54.91	-13.00	41.91	13
6	4899.00	-62.09	3.10	12.50	Vertical	-54.84	-13.00	41.84	0
7	5715.50	-61.00	3.40	12.50	Vertical	-54.05	-13.00	41.05	45
8	6532.00	-60.03	3.80	11.50	Vertical	-54.48	-13.00	41.48	15
9	7348.50	-55.54	4.20	12.20	Vertical	-49.69	-13.00	36.69	17
10	8165.00	-54.76	4.30	12.30	Vertical	-48.91	-13.00	35.91	135

Note: 1.The other Spurious RF Radiated emissions level is no more than noise floor.

2.The worst emission was found in the antenna is Vertical position.

LTE Band 26 10MHz CH Middle

Harmonic	Frequency (MHz)	SG (dBm)	Cable Loss (dB)	Gain (dBi)	Antenna Polarization	ERP Level (dBm)	Limit (dBm)	Margin (dB)	Azimuth (deg)
2	1628.00	-67.38	1.70	8.70	Vertical	-62.53	-13.00	49.53	225
3	2442.00	-63.25	2.30	12.00	Vertical	-55.70	-13.00	42.70	64
4	3256.00	-67.21	2.20	13.10	Vertical	-58.46	-13.00	45.46	287
5	4070.00	-64.11	3.00	12.50	Vertical	-56.76	-13.00	43.76	11
6	4884.00	-62.35	3.10	12.50	Vertical	-55.10	-13.00	42.10	38
7	5698.00	-61.60	3.40	12.50	Vertical	-54.65	-13.00	41.65	135
8	6512.00	-60.35	3.80	11.50	Vertical	-54.80	-13.00	41.80	17
9	7326.00	-55.75	4.20	12.20	Vertical	-49.90	-13.00	36.90	165
10	8140.00	-54.46	4.30	12.30	Vertical	-48.61	-13.00	35.61	15

Note: 1.The other Spurious RF Radiated emissions level is no more than noise floor.

2.The worst emission was found in the antenna is Vertical position.

7. Main Test Instruments

Name	Manufacturer	Type	Serial Number	Calibration Date	Expiration Date
Climate Chamber	WEISS	VT 4002	58226119450010	2023-05-12	2024-05-11
Wireless Communication Tester	R&S	CMW500	150415	2023-05-12	2024-05-11
Spectrum Analyzer	Keysight	N9020A	MY50510203	2023-05-12	2024-05-11
Wireless Communication Tester	Agilent	E5515C	MY48367192	2023-05-12	2024-05-11
DC Power Supply	UNI-T	UTP1310+	C220795889	2023-05-12	2024-05-11
Spectrum Analyzer	R&S	FSV3030	101411	2022-12-10	2023-12-09
Radiated Spurious Emission					
Signal Analyzer	R&S	FSV30	100815	2022-12-10	2023-12-09
Loop Antenna	SCHWARZBECK	FMZB1519	1519-047	2023-04-16	2026-04-15
TRILOG Broadband Antenna	Schwarzbeck	VULB 9163	391	2022-09-29	2025-09-28
Horn Antenna	Schwarzbeck	BBHA 9120D	1594	2020-12-17	2023-12-16
Software	R&S	EMC32	10.35.10	/	/

ANNEX A: The EUT Appearance

The EUT Appearance is submitted separately.

ANNEX B: Test Setup Photos

The Test Setup Photos is submitted separately.

ANNEX C: Product Change Description

The Product Change Description are submitted separately.

***** END OF REPORT *****