



Test Report No.: W7L-P23100008RF08



# FCC TEST REPORT (PART 90)

Applicant:	Xiaomi Communications Co., Ltd.
Address:	#019, 9th Floor, Building 6, 33 Xi'erqi Middle Road, Haidian District, Beijing, China, 100085

Manufacturer or Supplier	Xiaomi Communications Co., Ltd.
Address	#019, 9th Floor, Building 6, 33 Xi'erqi Middle Road, Haidian District, Beijing, China, 100085
Product	Mobile Phone
Brand Name	Redmi
Model Name	2312CRNCCL
FCC ID	2AFZZNCCL
Date of tests	Oct. 16, 2023 ~ Nov. 22, 2023

The tests have been carried out according to the requirements of the following standard:

- FCC Part 90, Subpart R, S     ANSI/TIA/EIA-603- D
- FCC Part 2                       ANSI/TIA/EIA-603-E     ANSI C63.26-2015

CONCLUSION: The submitted sample was found to COMPLY with the test requirement

Prepared by Chao Wu Engineer / Mobile Department	Approved by Peibo Sun Manager / Mobile Department
Date: Nov. 22, 2023	Date: Nov. 22, 2023

This report is governed by, and incorporates by reference, the Conditions of Testing as posted at the date of issuance of this report at <http://www.bureauveritas.com/home/about-us/our-business/cps/about-us/terms-conditions> and is intended for your exclusive use. Any copying or replication of this report to or for any other person or entity, or use of our name or trademark, is permitted only with our prior written permission. This report sets forth our findings solely with respect to the test samples identified herein. The results set forth in this report are not indicative or representative of the quality or characteristics of the lot from which a test sample was taken or any similar or identical product unless specifically and expressly noted. Our report includes all of the tests requested by you and the results thereof based upon the information that you provided to us. Measurement uncertainty is only provided upon request for accredited tests. Statements of conformity are based on simple acceptance criteria without taking measurement uncertainty into account, unless otherwise requested in writing. You have 60 days from date of issuance of this report to notify us of any material error or omission caused by our negligence or if you require measurement uncertainty; provided, however, that such notice shall be in writing and shall specifically address the issue you wish to raise. A failure to raise such issue within the prescribed time shall constitute your unqualified acceptance of the completeness of this report, the tests conducted and the correctness of the report contents.



# TABLE OF CONTENTS

**RELEASE CONTROL RECORD ..... 4**

**1 SUMMARY OF TEST RESULTS ..... 5**

1.1 MEASUREMENT UNCERTAINTY ..... 6

1.2 TEST SITE AND INSTRUMENTS ..... 7

**2 GENERAL INFORMATION..... 10**

2.1 GENERAL DESCRIPTION OF EUT ..... 10

2.2 CONFIGURATION OF SYSTEM UNDER TEST ..... 12

2.3 DESCRIPTION OF SUPPORT UNITS ..... 13

2.4 DESCRIPTION OF TEST MODES..... 13

2.5 GENERAL DESCRIPTION OF APPLIED STANDARDS ..... 15

**3 TEST TYPES AND RESULTS ..... 16**

3.1 OUTPUT POWER MEASUREMENT ..... 16

3.1.1 LIMITS OF OUTPUT POWER MEASUREMENT ..... 16

3.1.2 TEST PROCEDURES ..... 16

3.1.3 TEST SETUP ..... 17

3.1.4 TEST RESULTS ..... 17

3.2 FREQUENCY STABILITY MEASUREMENT ..... 34

3.2.1 LIMITS OF FREQUENCY STABILIIY MEASUREMENT ..... 34

3.2.2 TEST PROCEDURE ..... 34

3.2.3 TEST SETUP ..... 34

3.2.4 TEST RESULTS ..... 35

3.3 OCCUPIED BANDWIDTH MEASUREMENT ..... 36

3.3.1 LIMITS OF OCCUPIED BANDWIDTH MEASUREMENT ..... 36

3.3.2 TEST SETUP ..... 36

3.3.3 TEST PROCEDURES ..... 36

3.3.4 TEST RESULTS ..... 37

3.4 EMISSION MASK MEASUREMENT..... 38

3.4.1 LIMITS OF EMISSION MASK MEASUREMENT ..... 38

3.4.2 TEST SETUP ..... 38

3.4.3 TEST PROCEDURES ..... 39

3.4.4 TEST RESULTS ..... 40

3.5 CONDUCTED SPURIOUS EMISSIONS..... 41

3.5.1 LIMITS OF CONDUCTED SPURIOUS EMISSIONS MEASUREMENT ..... 41

3.5.2 TEST PROCEDURE ..... 41

3.5.3 TEST SETUP ..... 41

3.5.4 TEST RESULTS ..... 42

3.6 RADIATED EMISSION MEASUREMENT ..... 43

3.6.1 LIMITS OF RADIATED EMISSION MEASUREMENT ..... 43

3.6.2 TEST PROCEDURES ..... 43

3.6.3 DEVIATION FROM TEST STANDARD ..... 43

3.6.4 TEST SETUP ..... 44

3.6.5 TEST RESULTS ..... 46

3.7 PEAK TO AVERAGE RATIO ..... 56

3.7.1 LIMITS OF PEAK TO AVERAGE RATIO MEASUREMENT ..... 56

3.7.2 TEST SETUP ..... 56

3.7.3 TEST PROCEDURES ..... 56

3.7.4 TEST RESULTS ..... 57



**BUREAU  
VERITAS**

**Test Report No.: W7L-P23100008RF08**

<b>4 PHOTOGRAPHS OF THE TEST CONFIGURATION.....</b>	<b>58</b>
<b>5 INFORMATION ON THE TESTING LABORATORIES .....</b>	<b>59</b>
<b>6 MODIFICATIONS RECORDERS FOR ENGINEERING CHANGES TO THE EUT BY THE LAB... 60</b>	
<b>7 APPENDIX .....</b>	<b>61</b>
LTE BAND26 .....	61



Test Report No.: W7L-P23100008RF08

## RELEASE CONTROL RECORD

ISSUE NO.	REASON FOR CHANGE	DATE ISSUED
W7L-P23100008RF08	Original release	Nov. 22, 2023



# 1 SUMMARY OF TEST RESULTS

The EUT has been tested according to the following specifications:

APPLIED STANDARD: FCC Part 90 & Part 2			
STANDARD SECTION	TEST TYPE AND LIMIT	RESULT	LAB
§2.1046 §90.635(b)	Conducted Output Power	PASS	A
§2.1055 §90.213	Frequency Stability	PASS	A
§2.1049 §90.209	Occupied Bandwidth	PASS	A
§2.1051 §90.691	Emission Masks	PASS	A
§2.1051 §90.691	Conducted Spurious Emissions	PASS	A
§2.1053 §90.691	Radiated Spurious Emissions	PASS	A

### Test Lab Information Reference:

**Lab A:**

Huarui 7Layers High Technology (Suzhou) Co., Ltd.

**Lab Address:**

Tower N, Innovation Center, 88 Zhuyi Road, High-tech District, Suzhou City, Anhui Province

**Accredited Test Lab Cert 6613.01**

**The FCC Site Registration No. is 434559; The Designation No. is CN1325.**



## 1.1 MEASUREMENT UNCERTAINTY

Where relevant, the following measurement uncertainty levels have been estimated for tests performed on the EUT as specified in CISPR 16-4-2:

MEASUREMENT	FREQUENCY	UNCERTAINTY
Conducted emissions	9kHz~30MHz	2.66dB
Radiated emissions	9KHz ~ 30MHz	2.68dB
	30MHz ~ 1GHz	3.26dB
	1GHz ~ 18GHz	4.48dB
	18GHz ~ 40GHz	4.12dB

This uncertainty represents an expanded uncertainty expressed at approximately the 95% confidence level using a coverage factor of  $k=2$ .



BUREAU  
VERITAS

Test Report No.: W7L-P23100008RF08

## 1.2 TEST SITE AND INSTRUMENTS

Equipment	Manufacturer	Model No.	Serial No.	Last Cal.	Next Cal.
MXE EMI Receiver	KEYSIGHT	N9038A-544	MY54450026	Mar. 28,23	Mar. 27,24
EXA Signal Analyzer	KEYSIGHT	N9010A-544	MY54510355	May.10,23	May.09,24
Loop Antenna	Schwarzbeck	FMZB 1519B	00173	Sep.02,23	Sep.01,24
Bilog Antenna	ETS-LINDGRE N	3143B	00161965	Feb. 18,23	Feb. 17,24
Horn Antenna	ETS-LINDGRE N	3117	00168692	Feb. 18,23	Feb. 17,24
Horn Antenna (18GHz-40GHz)	N/A	QWH-SL-18-40-K- SG/QMS-00361	15433	Sep.03, 23	Sep.02, 24
Radio Communication Analyzer	ANRITSU	MT8820C	6201465426	Feb. 14,23	Feb. 13,24
Signal Pre-Amplifier	EMSI	EMC 9135	980249	May. 06,23	May. 05,24
Signal Pre-Amplifier	EMSI	EMC 012645B	980257	May.10,23	May.09,24
Signal Pre-Amplifier	EMSI	EMC 184045B	980259	Feb. 17,23	Feb.16,24
3m Semi-anechoic Chamber	ETS-LINDGRE N	9m*6m*6m	Euroshieldpn- CT0001143-121 6	May. 22, 23	May. 21,26
Test Software	E3	V 9.160323	N/A	N/A	N/A
Test Software	JS1120	3.1.36	N/A	N/A	N/A
10dB Attenuator	JFW/USA	50HF-010-SMA	50HF-010-SMA	May. 06,23	May. 05,24
Power Meter	Anritsu	ML2495A	1506002	Feb. 14,23	Feb. 13,24
Power Sensor	Anritsu	MA2411B	1339352	Feb. 14,23	Feb. 13,24
Temperature Chamber	ESPEC	SH-242	93000855	May. 06,23	May. 05,24
MXG Analog Microwave Signal Generator	KEYSIGHT	N5183A	MY50143024	Feb. 14,23	Feb. 13,24
Base station R&S CMW500	Rohde&Schwa rz	CMW500	153085	May.10,23	May.09,24
DC Source	Kikusui/JP	PMX18-5A	N/A	Aug. 11,23	Aug. 10,24



Test Report No.: W7L-P23100008RF08

Equipment	Manufacturer	Model No.	Serial No.	Last Cal.	Next Cal.
Pre-Amplifier	R&S	SCU18F1	100815	Aug.30,22	Aug.29,24
Pre-Amplifier	R&S	SCU08F1	101028	Sep.16,22	Sep.15,24
Vector Signal Generator	R&S	SMBV100B	102176	Feb.16,22	Feb.15,24
Signal Generator	R&S	SMB100A	182185	Feb.16,22	Feb.15,24
3m Fully-anechoic Chamber	TDK	9m*6m*6m	HRSW-SZ-EMC-01Chamber	Nov.25,22	Nov.24,25
3m Semi-anechoic Chamber	TDK	9m*6m*6m	HRSW-SZ-EMC-02Chamber	Nov.25,22	Nov.24,25
EMI TEST Receiver	R&S	ESR26	101734	Feb.25,22	Feb.24,24
EMI TEST Receiver	R&S	ESW44	101973	Feb.25,22	Feb.24,24
Bilog Antenna	SCHWARZBECK	VULB 9163	1264	Feb.28,22	Feb.27,24
Horn Antenna	ETS-LINDGREN	3117	227836	Aug.22,22	Aug.21,24
Horn Antenna (18GHz-40GHz)	Steatite Q-par Antennas	QMS 00880	23486	Feb.23,22	Feb.22,24
Horn Antenna	Steatite Q-par Antennas	QMS 00208	23485	Aug.22,22	Aug.21,24
Loop Antenna	SCHWARZ	HFH2-Z2/Z2E	100976	Feb.23,22	Feb.22,24
WIDEBANDRADIO COMMUNICATION TESTER	R&S	CMW500	169399	Jun.27,22	Jun.26,24
Test Software	EMC32	EMC32	N/A	N/A	N/A
6DB attenuator	Tonscend Technology Co., Ltd	N/A	23062787	N/A	N/A
Test Software	ELEKTRA	ELEKTRA4.32	N/A	N/A	N/A
Open Switch and Control Unit	R&S	OSP220	101964	Oct.01,22	Sep.30,24
DC Source	HYELEC	HY3010B	551016	Aug.31,22	Aug.30,24
Hygrothermograph	DELI	20210528	SZ014	Sep.06,22	Sep.05,24
PC	LENOVO	E14	HRSW0024	N/A	N/A
TMC-AMI18843A(CABLE)	R&S	HF290-NMNM-7.00M	N/A	N/A	N/A
TMC-AMI18843A(CABLE)	R&S	HF290-NMNM-4.00M	N/A	N/A	N/A
CABLE	R&S	W13.02	N/A	Apr.28,23	Oct.27,23
CABLE	R&S	W13.02	N/A	Oct.27,23	Apr.26,24
CABLE	R&S	W12.14	N/A	Apr.28,23	Oct.27,23
CABLE	R&S	W12.14	N/A	Oct.27,23	Apr.26,24
CABLE	R&S	J12J103539-00-1	SEP-03-20-069	Apr.28,23	Oct.27,23
CABLE	R&S	J12J103539-00-1	SEP-03-20-069	Oct.27,23	Apr.26,24
CABLE	R&S	J12J103539-00-1	SEP-03-20-070	Apr.28,23	Oct.27,23





**BUREAU  
VERITAS**

**Test Report No.: W7L-P23100008RF08**

CABLE	R&S	J12J103539-00-1	SEP-03-20-070	Oct.27,23	Apr.26,24
Temperature Chamber	votsch	VT4002	58566078100050	May.31,22	May.30,24

**NOTE:** 1. The calibration interval of the above test instruments is 6 months or 12 months or 24 months or 36 months, and the calibrations are traceable to CEPREI/CHINA, GRGT/CHINA and NIM/CHINA.

2. The FCC Site Registration No. is 434559; The Designation No. is CN1325.

## 2 GENERAL INFORMATION

### 2.1 GENERAL DESCRIPTION OF EUT

<b>PRODUCT</b>	Mobile Phone	
<b>BRAND NAME</b>	Redmi	
<b>MODEL NAME</b>	2312CRNCCL	
<b>NOMINAL VOLTAGE</b>	5Vdc (adapter or host equipment) 3.82Vdc (Li-ion, battery)	
<b>MODULATION TECHNOLOGY</b>	LTE	QPSK, 16QAM, 64QAM
<b>FREQUENCY RANGE</b>	LTE Band 26 (Channel Bandwidth: 1.4MHz)	814.7MHz ~ 823.3MHz
	LTE Band 26 (Channel Bandwidth: 3MHz)	815.5MHz ~ 822.5MHz
	LTE Band 26 (Channel Bandwidth: 5MHz)	816.5MHz ~ 821.5MHz
	LTE Band 26 (Channel Bandwidth: 10MHz)	819MHz
<b>EMISSION DESIGNATOR</b>	LTE Band 26 (Channel Bandwidth: 1.4MHz)	QPSK: 1M09G7D
		16QAM: 1M10W7D
		64QAM: 1M10W7D
	LTE Band 26 (Channel Bandwidth: 3MHz)	QPSK: 2M69G7D
		16QAM: 2M69W7D
		64QAM: 2M69W7D
	LTE Band 26 (Channel Bandwidth: 5MHz)	QPSK: 4M50G7D
		16QAM: 4M50W7D
		64QAM: 4M50W7D
	LTE Band 26 (Channel Bandwidth: 10MHz)	QPSK: 8M98G7D
		16QAM: 8M97W7D
		64QAM: 8M98W7D
<b>MAX. EIRP POWER</b>	LTE Band 26 (Channel Bandwidth: 1.4MHz)	46.88mW
	LTE Band 26 (Channel Bandwidth: 3MHz)	46.13mW
	LTE Band 26 (Channel Bandwidth: 5MHz)	45.92mW
	LTE Band 26 (Channel Bandwidth: 10MHz)	46.34mW
<b>ANTENNA TYPE</b>	PIFA Antenna	



**BUREAU  
VERITAS**

**Test Report No.: W7L-P23100008RF08**

<b>ANTENNA GAIN</b>	ANT 0(DOWN): -5.15 dBi forLTE Band 26  ANT 1(UP): -5.37 dBi forLTE Band 26
<b>HW VERSION</b>	13510C3Y
<b>SW VERSION</b>	Android 14
<b>IMEI</b>	864532070015786/94 864532070015406/14 864532070023426/34 864532070023566/74 864532070033300/18
<b>I/O PORTS</b>	Refer to user's manual
<b>DATA CABLE</b>	USB cable: non-shielded cable, with w/o ferrite core, 1.0 meter
<b>EXTREME TEMPERATURE</b>	0-40 °C
<b>EXTREME VOLTAGE</b>	3.6V - 4.25V

**NOTE:**

1. For a more detailed features description, please refer to the manufacturer's specifications or the user's manual.
2. Physically, the EUT provides two completed transmitters and two receivers.

<b>MODULATION MODE</b>	<b>TX FUNCTION</b>
<b>LTE</b>	<b>2TX/2RX</b>

3. For the test results, the EUT had been tested with all conditions. But only the worst case was shown in the test report.
4. Antenna gain and EUT conducted cable loss are provided by the customer, and the laboratory will record the results based on these items that involve these two parameters.

## 2.2 CONFIGURATION OF SYSTEM UNDER TEST

### FOR RADIATION EMISSION TEST

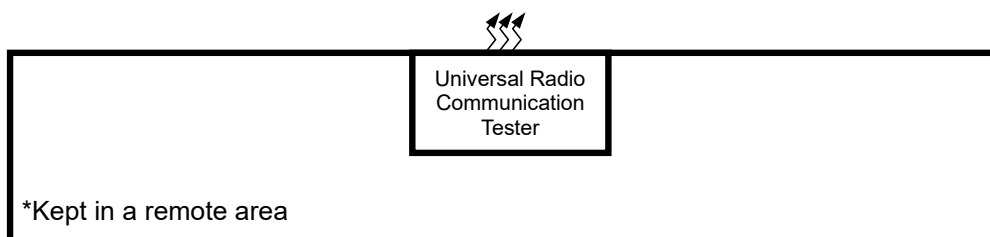
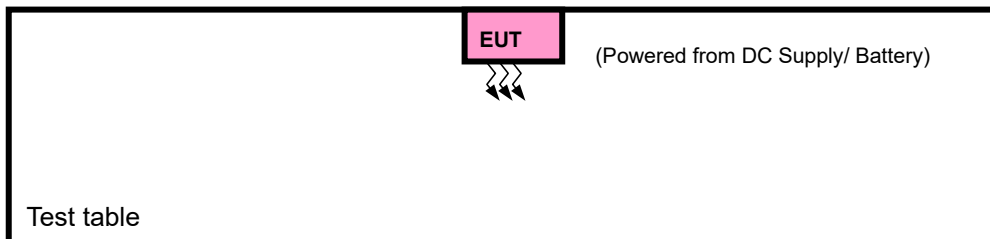
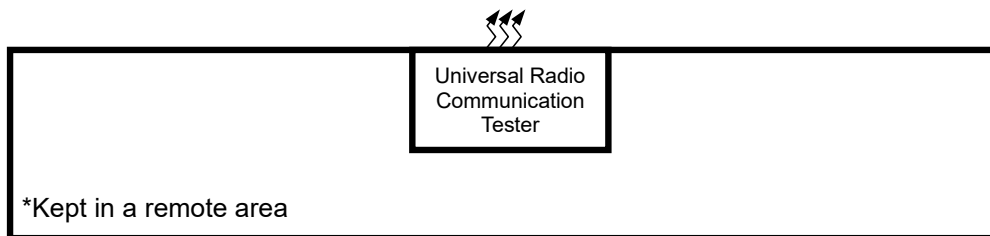
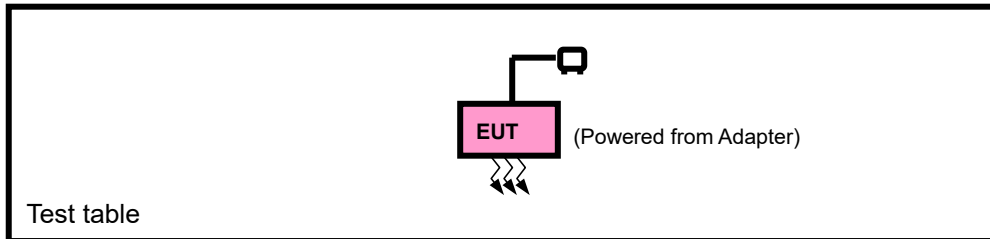



### 2.3 DESCRIPTION OF SUPPORT UNITS

The EUT has been tested as an independent unit together with other necessary accessories or support units. The following support units or accessories were used to form a representative test configuration during the tests.

NO.	PRODUCT	BRAND	MODEL NO.	SERIAL NO.	FCC ID
1	DC source	LONG WEI	PS-6403D	010934269	N/A

NO.	SIGNAL CABLE DESCRIPTION OF THE ABOVE SUPPORT UNITS
1	DC Line: Unshielded, Detachable 1.8m

### 2.4 DESCRIPTION OF TEST MODES

Pre-Scan has been conducted to determine the worst-case mode from all possible combinations between available modulations, data rates, XYZ axis and antenna ports. The worst case in ERP/EIRP and radiated emission was found when positioned on X-plane for LTE. Following channel(s) was (were) selected for the final test as listed below:

EUT CONFIGURE MODE	DESCRIPTION
A	EUT + Adapter + USB Cable with LTE link
B	EUT + DC source with LTE link



Test Report No.: W7L-P23100008RF08

**LTE BAND 26 MODE**

EUT CONFIGURE MODE	TEST ITEM	AVAILABLE CHANNEL	TESTED CHANNEL	CHANNEL BANDWIDTH	MODULATION	MODE		
A	ERP	26697 to 26783	26697, 26740, 26783	1.4MHz	QPSK, 16QAM, 64QAM	1 RB / 0 RB Offset		
		26705 to 26775	26705, 26740, 26775	3MHz	QPSK, 16QAM, 64QAM	1 RB / 0 RB Offset		
		26715 to 26765	26715, 26740, 26765	5MHz	QPSK, 16QAM, 64QAM	1 RB / 0 RB Offset		
		26740	26740	10MHz	QPSK, 16QAM, 64QAM	1 RB / 0 RB Offset		
B	FREQUENCY STABILITY	26740	26740	10MHz	QPSK	50 RB / 0 RB Offset		
A	OCCUPIED BANDWIDTH	26697 to 26783	26697, 26740, 26783	1.4MHz	QPSK, 16QAM, 64QAM	6 RB / 0 RB Offset		
		26705 to 26775	26705, 26740, 26775	3MHz	QPSK, 16QAM, 64QAM	15 RB / 0 RB Offset		
		26715 to 26765	26715, 26740, 26765	5MHz	QPSK, 16QAM, 64QAM	25 RB / 0 RB Offset		
		26740	26740	10MHz	QPSK, 16QAM, 64QAM	50 RB / 0 RB Offset		
A	BAND EDGE	26697 to 26783	26697	1.4MHz	QPSK, 16QAM, 64QAM	1 RB / 0 RB Offset 6 RB / 0 RB Offset		
			26783	1.4MHz	QPSK, 16QAM, 64QAM	1 RB / 5 RB Offset 6 RB / 0 RB Offset		
		26705 to 26775	26705	3MHz	QPSK, 16QAM, 64QAM	1 RB / 0 RB Offset 15 RB / 0 RB Offset		
			26775	3MHz	QPSK, 16QAM, 64QAM	1 RB / 14 RB Offset 15 RB / 0 RB Offset		
		26715 to 26765	26715	5MHz	QPSK, 16QAM, 64QAM	1 RB / 0 RB Offset 25 RB / 0 RB Offset		
			26765	5MHz	QPSK, 16QAM, 64QAM	1 RB / 24 RB Offset 25 RB / 0 RB Offset		
		26740	26740	10MHz	QPSK, 16QAM, 64QAM	1 RB / 0 RB Offset 50 RB / 0 RB Offset		
			26740	10MHz	QPSK, 16QAM, 64QAM	1 RB / 49 RB Offset 50 RB / 0 RB Offset		
		A	PEAK TO AVERAGE RATIO	26740	26740	10MHz	QPSK, 16QAM, 64QAM	1 RB / 0 RB Offset 50 RB / 0 RB Offset
		A	CONDUCTED EMISSION	26697 to 26783	26697, 26740, 26783	1.4MHz	QPSK	1 RB / 0 RB Offset
				26705 to 26775	26705, 26740, 26775	3MHz	QPSK	1 RB / 0 RB Offset
				26715 to 26765	26715, 26740, 26765	5MHz	QPSK	1 RB / 0 RB Offset
26740	26740			10MHz	QPSK	1 RB / 0 RB Offset		
A	RADIATED EMISSION	26697 to 26783	26740	1.4MHz	QPSK	1 RB / 0 RB Offset		
		26705 to 26775	26740	3MHz	QPSK	1 RB / 0 RB Offset		
		26715 to 26765	26740	5MHz	QPSK	1 RB / 0 RB Offset		
		26740	26740	10MHz	QPSK	1 RB / 0 RB Offset		

**Note:** This device was tested under all bandwidths, RB configurations and modulations. The worst case was found in QPSK modulation.



Test Report No.: W7L-P23100008RF08

**TEST CONDITION:**

TEST ITEM	ENVIRONMENTAL CONDITIONS	INPUT POWER	TESTED BY
EIRP(ERP)	24deg. C, 60%RH	DC 5V By Adapter	Jace Hu
FREQUENCY STABILITY	See Note	DC 3.6/3.82/4.25 By DC Source	James Fu
OCCUPIED BANDWIDTH	24deg. C, 61%RH	DC 5V By Adapter	James Fu
BAND EDGE	24deg. C, 61%RH	DC 5V By Adapter	James Fu
CONDUCTED EMISSION	24deg. C, 61%RH	DC 5V By Adapter	James Fu
RADIATED EMISSION	23deg. C, 70%RH	DC 5V By Adapter	Jace Hu

Note: LV = Low voltage (3.6V); NV = Normal voltage (3.82V); HV= High voltage (4.25V).  
NT = Normal temperature (25°C)

## 2.5 GENERAL DESCRIPTION OF APPLIED STANDARDS

The EUT is an RF product. According to the specifications of the manufacturer, it must comply with the requirements of the following standards:

**FCC 47 CFR Part 2**

**FCC 47 CFR Part 90**

**ANSI/TIA/EIA-603-D**

**ANSI/TIA/EIA-603-E**

**ANSI C63.26-2015**

**NOTE:** All test items have been performed and recorded as per the above standards.



### 3 TEST TYPES AND RESULTS

#### 3.1 OUTPUT POWER MEASUREMENT

##### 3.1.1 LIMITS OF OUTPUT POWER MEASUREMENT

Per FCC Part 90.635(a)(b)

The maximum output power of the transmitter for mobile stations is 100 watts (20 dBw).

##### 3.1.2 TEST PROCEDURES

###### EIRP / ERP MEASUREMENT:

Per KDB 971168 D01 Power Meas License Digital Systems v03r01 or subclause 5.2.5.5 of ANSI C63.26-2015, the relevant equation for determining the ERP or EIRP from the conducted RF output power measured using the guidance provided above is:

$$\text{ERP or EIRP} = P_{\text{Meas}} + G_{\text{T}} - L_{\text{C}}$$

Where:

ERP or EIRP = effective radiated power or equivalent isotropically radiated power, respectively  
(expressed in the same units as  $P_{\text{Meas}}$ , typically dBW or dBm).

$P_{\text{Meas}}$  = measured transmitter output power or PSD, in dBm or dBW.

$G_{\text{T}}$  = gain of the transmitting antenna, in dBd (ERP) or dBi (EIRP).

$L_{\text{C}}$  = signal attenuation in the connecting cable between the transmitter and antenna, in dB

###### CONDUCTED POWER MEASUREMENT:

- a. The EUT was set up for the maximum power with LTE link data modulation and link up with simulator.
- b. Set the EUT to transmit under low, middle, and high channel and record the power level shown on simulator.





Test Report No.: W7L-P23100008RF08

### 3.1.3 TEST SETUP

#### CONDUCTED POWER MEASUREMENT:

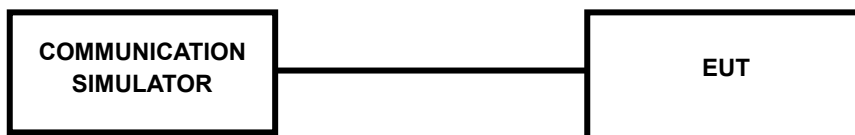

For the actual test configuration, please refer to the attached file (Test Setup Photo).

### 3.1.4 TEST RESULTS

#### CONDUCTED OUTPUT POWER (dBm)



**BUREAU  
VERITAS**

**Test Report No.: W7L-P23100008RF08**

**ANT0(DOWN):  
LTE Band 26**

Band/BW	Modulation	RB Size	RB Offset	Low CHG 26697	Mid CH 26740	High CH 26783
				Frequency 814.7 MHz	Frequency 819 MHz	Frequency 823.3 MHz
26/ 1.4	QPSK	1	0	23.59	23.43	23.59
		1	2	24.01	23.87	23.71
		1	5	23.72	23.77	23.50
		3	0	23.63	23.55	23.65
		3	1	23.86	23.82	23.65
		3	3	23.68	23.58	23.54
		6	0	22.74	22.60	22.69
	16QAM	1	0	22.52	22.41	22.38
		1	2	22.68	22.63	22.57
		1	5	22.61	22.47	22.31
		3	0	22.64	22.47	22.54
		3	1	22.64	22.61	22.70
		3	3	22.65	22.68	22.45
		6	0	21.70	21.62	21.75
	64QAM	1	0	21.81	21.68	21.63
		1	2	21.69	21.61	21.68
		1	5	21.65	21.53	21.33
		3	0	21.69	21.63	21.58
		3	1	21.75	21.74	21.77
		3	3	21.85	21.72	21.70
		6	0	20.57	20.52	20.45



Test Report No.: W7L-P23100008RF08

Band/BW	Modulation	RB Size	RB Offset	Low CHG 26705	Mid CH 26740	High CH 26775
				Frequency 815.5 MHz	Frequency 819 MHz	Frequency 822.5 MHz
26/ 3	QPSK	1	0	23.61	23.44	23.56
		1	7	23.94	23.82	23.73
		1	14	23.76	23.71	23.61
		8	0	22.70	22.59	22.67
		8	3	22.83	22.76	22.61
		8	7	22.66	22.56	22.67
		15	0	22.63	22.65	22.73
	16QAM	1	0	22.56	22.39	22.38
		1	7	22.65	22.51	22.52
		1	14	22.60	22.47	22.25
		8	0	21.64	21.47	21.61
		8	3	21.61	21.55	21.59
		8	7	21.73	21.63	21.47
		15	0	21.76	21.60	21.67
	64QAM	1	0	21.70	21.75	21.66
		1	7	21.80	21.62	21.67
		1	14	21.64	21.48	21.39
		8	0	20.72	20.61	20.57
		8	3	20.78	20.80	20.80
		8	7	20.74	20.62	20.64
		15	0	20.61	20.47	20.43

Band/BW	Modulation	RB Size	RB Offset	Low CHG 26715	Mid CH 26740	High CH 26765
				Frequency 816.5 MHz	Frequency 819 MHz	Frequency 821.5 MHz
26/ 5	QPSK	1	0	23.67	23.52	23.57
		1	12	23.92	23.84	23.72
		1	24	23.76	23.67	23.55
		12	0	22.65	22.58	22.66
		12	6	22.78	22.86	22.58
		12	13	22.62	22.62	22.64
		25	0	22.69	22.66	22.68
	16QAM	1	0	22.46	22.45	22.33
		1	12	22.68	22.63	22.52
		1	24	22.62	22.57	22.26
		12	0	21.59	21.51	21.65
		12	6	21.65	21.54	21.70
		12	13	21.66	21.61	21.55
		25	0	21.75	21.64	21.68
	64QAM	1	0	21.73	21.65	21.75
		1	12	21.66	21.67	21.72
		1	24	21.62	21.44	21.40
		12	0	20.63	20.58	20.63
		12	6	20.73	20.80	20.72
		12	13	20.71	20.63	20.61
		25	0	20.66	20.41	20.43



**BUREAU  
VERITAS**

**Test Report No.: W7L-P23100008RF08**

Band/BW	Modulation	RB Size	RB Offset	/	Mid CH 26740	/
				/	Frequency 819 MHz	/
26/ 10	QPSK	1	0	/	23.55	/
		1	24	/	<b>23.96</b>	/
		1	49	/	23.79	/
		25	0	/	22.67	/
		25	12	/	22.90	/
		25	25	/	22.70	/
		50	0	/	22.73	/
	16QAM	1	0	/	22.46	/
		1	24	/	22.64	/
		1	49	/	22.59	/
		25	0	/	21.55	/
		25	12	/	21.65	/
		25	25	/	21.75	/
		50	0	/	21.70	/
	64QAM	1	0	/	21.76	/
		1	24	/	21.74	/
		1	49	/	21.57	/
		25	0	/	20.66	/
		25	12	/	20.81	/
		25	25	/	20.74	/
		50	0	/	20.54	/



**BUREAU  
VERITAS**

**Test Report No.: W7L-P23100008RF08**

**ANT1(UP):  
LTE Band 26**

Band/BW	Modulation	RB Size	RB Offset	Low CHG 26697	Mid CH 26740	High CH 26783
				Frequency 814.7 MHz	Frequency 819 MHz	Frequency 823.3 MHz
26/ 1.4	QPSK	1	0	23.94	23.92	23.89
		1	2	24.09	23.96	23.87
		1	5	23.96	23.81	23.71
		3	0	23.77	23.68	23.61
		3	1	23.82	23.81	23.58
		3	3	23.86	23.83	23.73
		6	0	22.78	22.72	23.03
	16QAM	1	0	22.93	22.98	22.90
		1	2	23.14	23.01	23.07
		1	5	23.00	22.88	22.93
		3	0	22.72	22.72	22.76
		3	1	22.82	22.69	22.85
		3	3	22.93	22.72	22.58
		6	0	22.11	22.00	21.90
	64QAM	1	0	22.28	22.24	22.25
		1	2	22.52	22.43	22.30
		1	5	22.32	22.17	22.23
		3	0	21.73	21.75	21.67
		3	1	21.93	21.81	21.68
		3	3	21.86	21.68	21.83
		6	0	20.91	20.82	21.00



**Test Report No.: W7L-P23100008RF08**

Band/BW	Modulation	RB Size	RB Offset	Low CHG 26705	Mid CH 26740	High CH 26775
				Frequency 815.5 MHz	Frequency 819 MHz	Frequency 822.5 MHz
26/ 3	QPSK	1	0	23.96	23.83	23.90
		1	7	24.10	23.91	23.97
		1	14	23.86	23.85	23.71
		8	0	22.91	22.90	22.90
		8	3	23.03	22.95	22.80
		8	7	23.05	23.03	22.89
		15	0	22.82	22.84	23.01
	16QAM	1	0	23.00	22.89	22.93
		1	7	23.17	23.05	22.99
		1	14	22.97	22.84	22.91
		8	0	22.01	21.93	21.83
		8	3	21.98	21.80	22.06
		8	7	22.06	22.03	21.79
		15	0	22.09	22.03	21.93
	64QAM	1	0	22.20	22.18	22.24
		1	7	22.50	22.49	22.36
		1	14	22.29	22.18	22.26
		8	0	20.93	20.84	20.84
		8	3	21.07	21.04	20.92
		8	7	21.06	21.00	20.98
		15	0	20.91	20.90	20.97

Band/BW	Modulation	RB Size	RB Offset	Low CHG 26715	Mid CH 26740	High CH 26765
				Frequency 816.5 MHz	Frequency 819 MHz	Frequency 821.5 MHz
26/ 5	QPSK	1	0	24.02	23.94	23.85
		1	12	24.04	24.03	23.89
		1	24	23.89	23.80	23.77
		12	0	22.95	22.93	22.83
		12	6	23.02	23.00	22.86
		12	13	23.08	23.03	22.84
		25	0	22.78	22.76	22.92
	16QAM	1	0	23.06	22.90	22.93
		1	12	23.17	22.91	22.97
		1	24	22.99	22.94	22.98
		12	0	21.89	21.94	21.90
		12	6	21.97	21.87	22.12
		12	13	22.09	21.90	21.86
		25	0	22.10	22.08	21.84
	64QAM	1	0	22.24	22.15	22.28
		1	12	22.54	22.39	22.33
		1	24	22.34	22.14	22.27
		12	0	20.86	20.95	20.76
		12	6	21.19	21.02	21.01
		12	13	20.98	20.96	21.02
		25	0	20.91	20.88	20.90





**BUREAU  
VERITAS**

**Test Report No.: W7L-P23100008RF08**

Band/BW	Modulation	RB Size	RB Offset	/	Mid CH 26740	/
				/	Frequency 819 MHz	/
26/ 10	QPSK	1	0	/	23.96	/
		1	24	/	<b>24.05</b>	/
		1	49	/	23.89	/
		25	0	/	23.00	/
		25	12	/	23.05	/
		25	25	/	23.10	/
		50	0	/	22.87	/
	16QAM	1	0	/	23.01	/
		1	24	/	23.06	/
		1	49	/	22.97	/
		25	0	/	21.98	/
		25	12	/	21.95	/
		25	25	/	22.04	/
		50	0	/	22.09	/
	64QAM	1	0	/	22.27	/
		1	24	/	22.53	/
		1	49	/	22.28	/
		25	0	/	20.98	/
		25	12	/	21.14	/
		25	25	/	21.03	/
		50	0	/	20.95	/



Test Report No.: W7L-P23100008RF08

ERP

ANT0(DOWN):

LTE BAND 26

CHANNEL BANDWIDTH: 1.4MHz QPSK

Channel	Frequency (MHz)	Conducted Power (dBm)	G <sub>T</sub> -L <sub>C</sub> (dB)	ERP (dBm)	ERP (mW)	Limit (W)
26697	814.7	24.01	-5.15	16.71	46.88	100
26740	819	23.87	-5.15	16.57	45.39	100
26783	823.3	23.71	-5.15	16.41	43.75	100

REMARKS: ERP Output Power (dBm) = EIRP (dBm) -2.15(dB).

CHANNEL BANDWIDTH: 1.4MHz 16QAM

Channel	Frequency (MHz)	Conducted Power (dBm)	G <sub>T</sub> -L <sub>C</sub> (dB)	ERP (dBm)	ERP (mW)	Limit (W)
26697	814.7	22.68	-5.15	15.38	34.51	100
26740	819	22.68	-5.15	15.38	34.51	100
26783	823.3	22.7	-5.15	15.4	34.67	100

REMARKS: ERP Output Power (dBm) = EIRP (dBm) -2.15(dB).

CHANNEL BANDWIDTH: 1.4MHz 64QAM

Channel	Frequency (MHz)	Conducted Power (dBm)	G <sub>T</sub> -L <sub>C</sub> (dB)	ERP (dBm)	ERP (mW)	Limit (W)
26697	814.7	21.85	-5.15	14.55	28.51	100
26740	819	21.74	-5.15	14.44	27.8	100
26783	823.3	21.77	-5.15	14.47	27.99	100

REMARKS: ERP Output Power (dBm) = EIRP (dBm) -2.15(dB).

**LTE BAND 26**

**CHANNEL BANDWIDTH: 3MHz QPSK**

Channel	Frequency (MHz)	Conducted Power (dBm)	G <sub>T</sub> -L <sub>C</sub> (dB)	ERP (dBm)	ERP (mW)	Limit (W)
26705	815.5	23.94	-5.15	16.64	46.13	100
26740	819	23.82	-5.15	16.52	44.87	100
26775	822.5	23.73	-5.15	16.43	43.95	100

**REMARKS:** ERP Output Power (dBm) = EIRP (dBm) -2.15(dB).

**CHANNEL BANDWIDTH: 3MHz 16QAM**

Channel	Frequency (MHz)	Conducted Power (dBm)	G <sub>T</sub> -L <sub>C</sub> (dB)	ERP (dBm)	ERP (mW)	Limit (W)
26705	815.5	22.65	-5.15	15.35	34.28	100
26740	819	22.51	-5.15	15.21	33.19	100
26775	822.5	22.52	-5.15	15.22	33.27	100

**REMARKS:** ERP Output Power (dBm) = EIRP (dBm) -2.15(dB).

**CHANNEL BANDWIDTH: 3MHz 64QAM**

Channel	Frequency (MHz)	Conducted Power (dBm)	G <sub>T</sub> -L <sub>C</sub> (dB)	ERP (dBm)	ERP (mW)	Limit (W)
26705	815.5	21.8	-5.15	14.5	28.18	100
26740	819	21.75	-5.15	14.45	27.86	100
26775	822.5	21.67	-5.15	14.37	27.35	100

**REMARKS:** ERP Output Power (dBm) = EIRP (dBm) -2.15(dB).



LTE BAND 26

CHANNEL BANDWIDTH: 5MHz QPSK

Channel	Frequency (MHz)	Conducted Power (dBm)	G <sub>T</sub> -L <sub>C</sub> (dB)	ERP (dBm)	ERP (mW)	Limit (W)
26715	816.5	23.92	-5.15	16.62	45.92	100
26740	819	23.84	-5.15	16.54	45.08	100
26765	821.5	23.72	-5.15	16.42	43.85	100

REMARKS: ERP Output Power (dBm) = EIRP (dBm) -2.15(dB).

CHANNEL BANDWIDTH: 5MHz 16QAM

Channel	Frequency (MHz)	Conducted Power (dBm)	G <sub>T</sub> -L <sub>C</sub> (dB)	ERP (dBm)	ERP (mW)	Limit (W)
26715	816.5	22.68	-5.15	15.38	34.51	100
26740	819	22.63	-5.15	15.33	34.12	100
26765	821.5	22.52	-5.15	15.22	33.27	100

REMARKS: ERP Output Power (dBm) = EIRP (dBm) -2.15(dB).

CHANNEL BANDWIDTH: 5MHz 64QAM

Channel	Frequency (MHz)	Conducted Power (dBm)	G <sub>T</sub> -L <sub>C</sub> (dB)	ERP (dBm)	ERP (mW)	Limit (W)
26715	816.5	21.73	-5.15	14.43	27.73	100
26740	819	21.67	-5.15	14.37	27.35	100
26765	821.5	21.75	-5.15	14.45	27.86	100

REMARKS: ERP Output Power (dBm) = EIRP (dBm) -2.15(dB).

**LTE BAND 26**

**CHANNEL BANDWIDTH: 10MHz QPSK**

Channel	Frequency (MHz)	Conducted Power (dBm)	G <sub>T</sub> -L <sub>C</sub> (dB)	ERP (dBm)	ERP (mW)	Limit (W)
-	-	-	-	-	-	-
26740	819	23.96	-5.15	16.66	46.34	100
-	-	-	-	-	-	-

**REMARKS:** ERP Output Power (dBm) = EIRP (dBm) -2.15(dB).

**CHANNEL BANDWIDTH: 10MHz 16QAM**

Channel	Frequency (MHz)	Conducted Power (dBm)	G <sub>T</sub> -L <sub>C</sub> (dB)	ERP (dBm)	ERP (mW)	Limit (W)
-	-	-	-	-	-	-
26740	819	22.64	-5.15	15.34	34.2	100
-	-	-	-	-	-	-

**REMARKS:** ERP Output Power (dBm) = EIRP (dBm) -2.15(dB).

**CHANNEL BANDWIDTH: 10MHz 64QAM**

Channel	Frequency (MHz)	Conducted Power (dBm)	G <sub>T</sub> -L <sub>C</sub> (dB)	ERP (dBm)	ERP (mW)	Limit (W)
-	-	-	-	-	-	-
26740	819	21.76	-5.15	14.46	27.93	100
-	-	-	-	-	-	-

**REMARKS:** ERP Output Power (dBm) = EIRP (dBm) -2.15(dB).

**ANT1(UP):**

**LTE BAND 26**

**CHANNEL BANDWIDTH: 1.4MHz QPSK**

Channel	Frequency (MHz)	Conducted Power (dBm)	G <sub>T</sub> -L <sub>C</sub> (dB)	ERP (dBm)	ERP (mW)	Limit (W)
26697	814.7	24.09	-5.37	16.57	45.39	100
26740	819	23.96	-5.37	16.44	44.06	100
26783	823.3	23.89	-5.37	16.37	43.35	100

**REMARKS:** ERP Output Power (dBm) = EIRP (dBm) -2.15(dB).

**CHANNEL BANDWIDTH: 1.4MHz 16QAM**

Channel	Frequency (MHz)	Conducted Power (dBm)	G <sub>T</sub> -L <sub>C</sub> (dB)	ERP (dBm)	ERP (mW)	Limit (W)
26697	814.7	23.14	-5.37	15.62	36.48	100
26740	819	23.01	-5.37	15.49	35.4	100
26783	823.3	23.07	-5.37	15.55	35.89	100

**REMARKS:** ERP Output Power (dBm) = EIRP (dBm) -2.15(dB).

**CHANNEL BANDWIDTH: 1.4MHz 64QAM**

Channel	Frequency (MHz)	Conducted Power (dBm)	G <sub>T</sub> -L <sub>C</sub> (dB)	ERP (dBm)	ERP (mW)	Limit (W)
26697	814.7	22.52	-5.37	15	31.62	100
26740	819	22.43	-5.37	14.91	30.97	100
26783	823.3	22.3	-5.37	14.78	30.06	100

**REMARKS:** ERP Output Power (dBm) = EIRP (dBm) -2.15(dB).



Test Report No.: W7L-P23100008RF08

**LTE BAND 26**

**CHANNEL BANDWIDTH: 3MHz QPSK**

Channel	Frequency (MHz)	Conducted Power (dBm)	G <sub>T</sub> -L <sub>C</sub> (dB)	ERP (dBm)	ERP (mW)	Limit (W)
26705	815.5	24.1	-5.37	16.58	45.5	100
26740	819	23.91	-5.37	16.39	43.55	100
26775	822.5	23.97	-5.37	16.45	44.16	100

**REMARKS:** ERP Output Power (dBm) = EIRP (dBm) -2.15(dB).

**CHANNEL BANDWIDTH: 3MHz 16QAM**

Channel	Frequency (MHz)	Conducted Power (dBm)	G <sub>T</sub> -L <sub>C</sub> (dB)	ERP (dBm)	ERP (mW)	Limit (W)
26705	815.5	23.17	-5.37	15.65	36.73	100
26740	819	23.05	-5.37	15.53	35.73	100
26775	822.5	22.99	-5.37	15.47	35.24	100

**REMARKS:** ERP Output Power (dBm) = EIRP (dBm) -2.15(dB).

**CHANNEL BANDWIDTH: 3MHz 64QAM**

Channel	Frequency (MHz)	Conducted Power (dBm)	G <sub>T</sub> -L <sub>C</sub> (dB)	ERP (dBm)	ERP (mW)	Limit (W)
26705	815.5	22.5	-5.37	14.98	31.48	100
26740	819	22.49	-5.37	14.97	31.41	100
26775	822.5	22.36	-5.37	14.84	30.48	100

**REMARKS:** ERP Output Power (dBm) = EIRP (dBm) -2.15(dB).

**LTE BAND 26**

**CHANNEL BANDWIDTH: 5MHz QPSK**

Channel	Frequency (MHz)	Conducted Power (dBm)	G <sub>T</sub> -L <sub>C</sub> (dB)	ERP (dBm)	ERP (mW)	Limit (W)
26715	816.5	24.04	-5.37	16.52	44.87	100
26740	819	24.03	-5.37	16.51	44.77	100
26765	821.5	23.89	-5.37	16.37	43.35	100

**REMARKS:** ERP Output Power (dBm) = EIRP (dBm) -2.15(dB).

**CHANNEL BANDWIDTH: 5MHz 16QAM**

Channel	Frequency (MHz)	Conducted Power (dBm)	G <sub>T</sub> -L <sub>C</sub> (dB)	ERP (dBm)	ERP (mW)	Limit (W)
26715	816.5	23.17	-5.37	15.65	36.73	100
26740	819	22.94	-5.37	15.42	34.83	100
26765	821.5	22.98	-5.37	15.46	35.16	100

**REMARKS:** ERP Output Power (dBm) = EIRP (dBm) -2.15(dB).

**CHANNEL BANDWIDTH: 5MHz 64QAM**

Channel	Frequency (MHz)	Conducted Power (dBm)	G <sub>T</sub> -L <sub>C</sub> (dB)	ERP (dBm)	ERP (mW)	Limit (W)
26715	816.5	22.54	-5.37	15.02	31.77	100
26740	819	22.39	-5.37	14.87	30.69	100
26765	821.5	22.33	-5.37	14.81	30.27	100

**REMARKS:** ERP Output Power (dBm) = EIRP (dBm) -2.15(dB).



**LTE BAND 26**

**CHANNEL BANDWIDTH: 10MHz QPSK**

Channel	Frequency (MHz)	Conducted Power (dBm)	G <sub>T</sub> -L <sub>C</sub> (dB)	ERP (dBm)	ERP (mW)	Limit (W)
-	-	-	-	-	-	-
26740	819	24.05	-5.37	16.53	44.98	100
-	-	-	-	-	-	-

**REMARKS:** ERP Output Power (dBm) = EIRP (dBm) -2.15(dB).

**CHANNEL BANDWIDTH: 10MHz 16QAM**

Channel	Frequency (MHz)	Conducted Power (dBm)	G <sub>T</sub> -L <sub>C</sub> (dB)	ERP (dBm)	ERP (mW)	Limit (W)
-	-	-	-	-	-	-
26740	819	23.06	-5.37	15.54	35.81	100
-	-	-	-	-	-	-

**REMARKS:** ERP Output Power (dBm) = EIRP (dBm) -2.15(dB).

**CHANNEL BANDWIDTH: 10MHz 64QAM**

Channel	Frequency (MHz)	Conducted Power (dBm)	G <sub>T</sub> -L <sub>C</sub> (dB)	ERP (dBm)	ERP (mW)	Limit (W)
-	-	-	-	-	-	-
26740	819	22.53	-5.37	15.01	31.7	100
-	-	-	-	-	-	-

**REMARKS:** ERP Output Power (dBm) = EIRP (dBm) -2.15(dB).

### 3.2 FREQUENCY STABILITY MEASUREMENT

#### 3.2.1 LIMITS OF FREQUENCY STABILITY MEASUREMENT

The frequency stability of mobile, portable and control transmitters operating in the wideband segment must be 1.25 parts per million or better when AFC is locked to a base station, and 5 parts per million or better when AFC is not locked.

#### 3.2.2 TEST PROCEDURE

- a. The device is placed at the oven room. The oven room could control the temperatures and humidity. Power warms up is at least 15 min and power applied should perform before recording frequency error.
- b. EUT is connected the external power supply to control the DC input power. The test voltage range is from minimum to maximum working voltage. Each step shall be recording the frequency error rate.
- c. The temperature range step is 10 degrees in this test items. All temperature levels shall be holding  $\pm 0.5^{\circ}\text{C}$  during the measurement testing. Each temperature step shall be at least 0.5 hours, consider the EUT could be test under the stability condition.

**NOTE:** The frequency error was recorded frequency error from the communication simulator.

#### 3.2.3 TEST SETUP

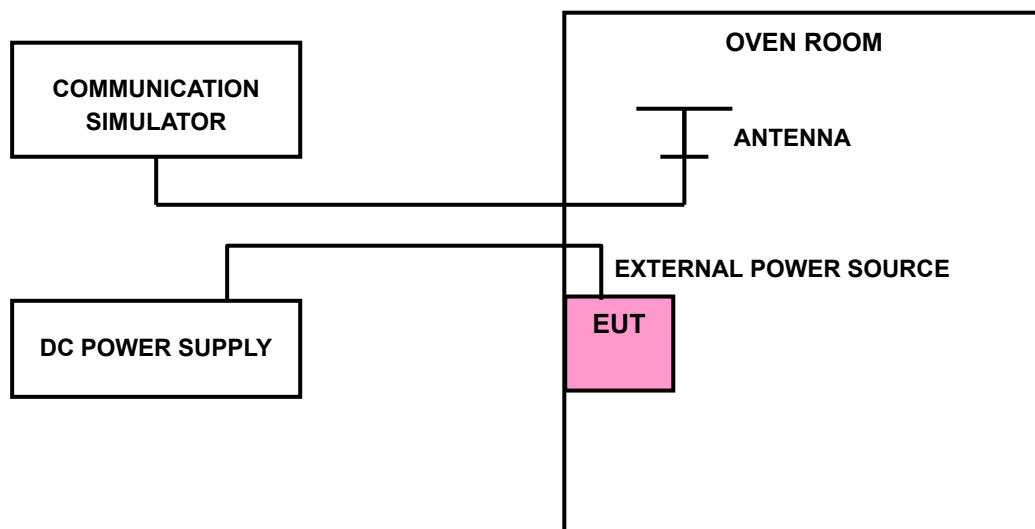



Test Report No.: W7L-P23100008RF08

### 3.2.4 TEST RESULTS

Please Refer to Appendix Of this test report.

### 3.3 OCCUPIED BANDWIDTH MEASUREMENT

#### 3.3.1 LIMITS OF OCCUPIED BANDWIDTH MEASUREMENT

The width of a frequency band such that, below the lower and above the upper frequency limits, the mean powers emitted are each equal to a specified percentage 0.5 %of the total mean power of a given emission.

#### 3.3.2 TEST SETUP

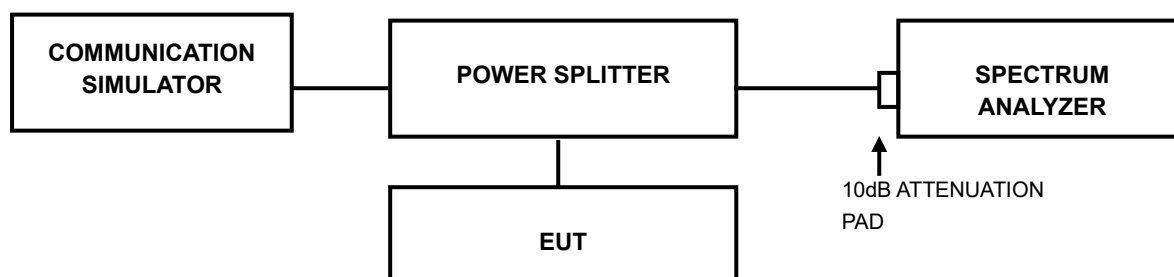

#### 3.3.3 TEST PROCEDURES

- a. The conducted occupied bandwidth used the power splitter via EUT RF power connector between simulation base station and spectrum analyzer.
- b. Use OBW measurement function of Spectrum analyzer to measure 99 % occupied bandwidth.



Test Report No.: W7L-P23100008RF08

### 3.3.4 TEST RESULTS

Please Refer to Appendix Of this test report.

### 3.4 EMISSION MASK MEASUREMENT

#### 3.4.1 LIMITS OF EMISSION MASK MEASUREMENT

According to FCC part 90.691 shall be tested the emission mask. For any frequency removed from the EA licensee's frequency block by up to and including 37.5 kHz, the power of any emission shall be attenuated below the transmitter power (P) in watts by at least  $116 \text{ Log}_{10}(f/6.1)$  decibels or  $50 + 10 \text{ Log}_{10}(P)$  decibels or 80 decibels, whichever is the lesser attenuation, where f is the frequency removed from the center of the outer channel in the block in kilohertz and where f is greater than 12.5 kHz.

For any frequency removed from the EA licensee's frequency block greater than 37.5 kHz, the power of any emission shall be attenuated below the transmitter power (P) in watts by at least  $43 + 10 \text{ Log}_{10}(P)$  decibels or 80 decibels, whichever is the lesser attenuation, where f is the frequency removed from the center of the outer channel in the block in kilohertz and where f is greater than 37.5 kHz.

#### 3.4.2 TEST SETUP

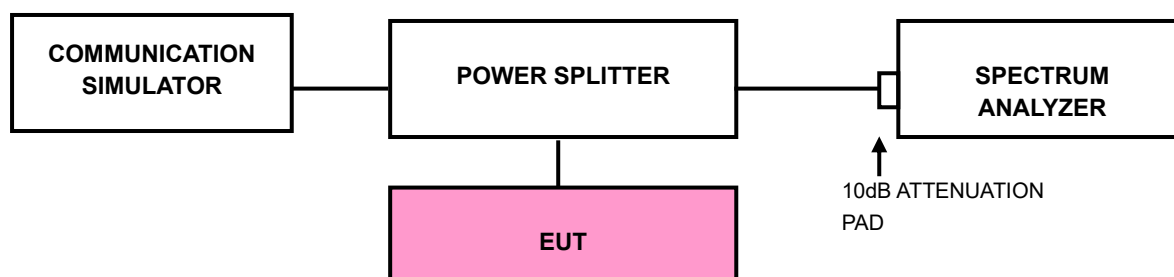



Test Report No.: W7L-P23100008RF08

### 3.4.3 TEST PROCEDURES

- a) Connect the transmitter to the spectrum analyzer via coaxial cable while ensuring proper impedance matching.
- b) Tune the analyzer to the nominal center frequency of the emission bandwidth (EBW).
- c) Set the resolution bandwidth (RBW)  $\geq 1\%$  EBW in the 1MHz band immediately outside and adjacent to the band edge.
- d) Beyond the 1MHz band from the band edge, RBW=1MHz was used.
- e) Set the video bandwidth (VBW) to  $\geq 3 \times$  RBW.
- f) Select the average power (RMS) display detector.
- g) Set the number of measurement points to  $\geq 1001$ .
- h) Use auto-coupled sweep time.
- i) Perform the measurement over an interval of time when the transmission is continuous and at its maximum power level.
- j) The RF fundamental frequency should be excluded against the limit line in the operating frequency band and use RBW is 10KHz or 100KHz.
- k) Record the max trace plot into the test report.



Test Report No.: W7L-P23100008RF08

### 3.4.4 TEST RESULTS

Please Refer to Appendix Of this test report.



### 3.5 CONDUCTED SPURIOUS EMISSIONS

#### 3.5.1 LIMITS OF CONDUCTED SPURIOUS EMISSIONS MEASUREMENT

The power of any emission outside a licensee's frequency block shall be attenuated below the transmitter power (P) by at least  $43 + 10 \log_{10}(P)$  dB. The limit of emission equal to  $-13\text{dBm}$

#### 3.5.2 TEST PROCEDURE

- a. The EUT makes a phone call to the communication simulator. All measurements were done at middle operational frequency range.
- b. Measuring frequency range is from 9kHz up to a frequency including its 10<sup>th</sup> harmonic. 10dB attenuation pad is connected with spectrum. RBW=1MHz and VBW=3MHz is used for conducted emission measurement.

#### 3.5.3 TEST SETUP

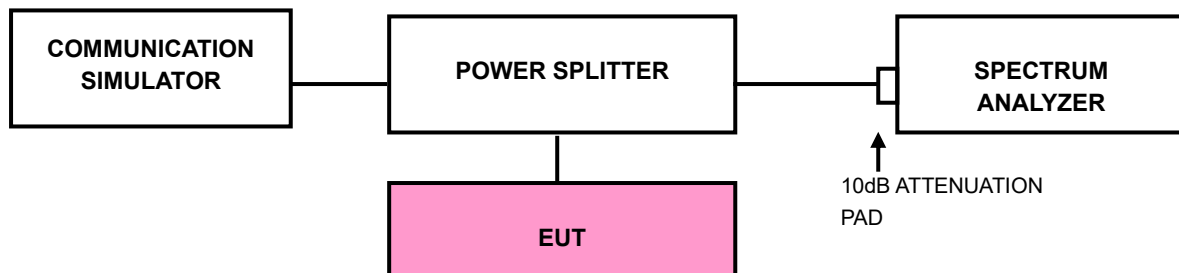



Test Report No.: W7L-P23100008RF08

### 3.5.4 TEST RESULTS

NOTE : The 9K~30MHz amplitude of spurious emissions attenuated more than 20 dB below the permissible value is not required in the report.

Please Refer to Appendix Of this test report.



### 3.6 RADIATED EMISSION MEASUREMENT

#### 3.6.1 LIMITS OF RADIATED EMISSION MEASUREMENT

The power of any emission outside a licensee's frequency block shall be attenuated below the transmitter power (P) by at least  $43 + 10 \log_{10}(P)$  dB. The limit of emission equal to  $-13\text{dBm}$

#### 3.6.2 TEST PROCEDURES

- a. The substitute method is used for E.I.R.P measurement. In the semi-anechoic chamber, EUT placed on the 0.8m height of Turn Table, rotated the table around 360 degrees to search the maximum radiation power and receiver antenna shall be rotated vertical and horizontal polarization and moved height from 1m to 4m to find the maximum polar radiated power. The "Read Value" is the spectrum reading the maximum power value.
- b. The substitution horn antenna is substituted for EUT at the same position and signals generator exports the CW signal to the substitution antenna via a TX cable. Rotated the Turn Table and moved the receiving antenna to find the maximum radiation power. Adjust output power level of S.G to get a Value of spectrum reading equal to "Read Value" of step a. Record the power level of S.G
- c.  $\text{EIRP} = \text{Output power level of S.G} - \text{TX cable loss} + \text{Antenna gain of substitution horn}$ .
- d. E.R.P power can be calculated from E.I.R.P power by subtracting the gain of dipole,  $\text{E.R.P power} = \text{E.I.P.R power} - 2.15\text{dBi}$ .

**NOTE:** The resolution bandwidth of spectrum analyzer is 1 MHz, and the video bandwidth is 3 MHz.

#### 3.6.3 DEVIATION FROM TEST STANDARD

No deviation

### 3.6.4 TEST SETUP

#### <Below 30MHz>

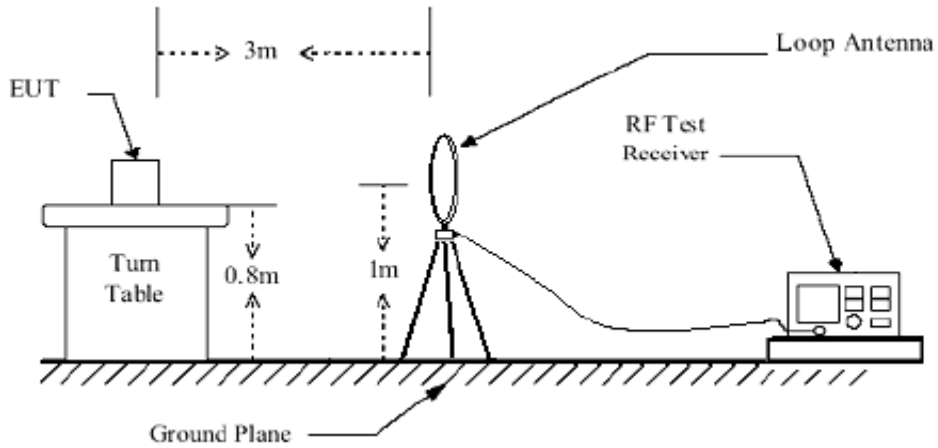

#### < Frequency Range 30MHz~1GHz >

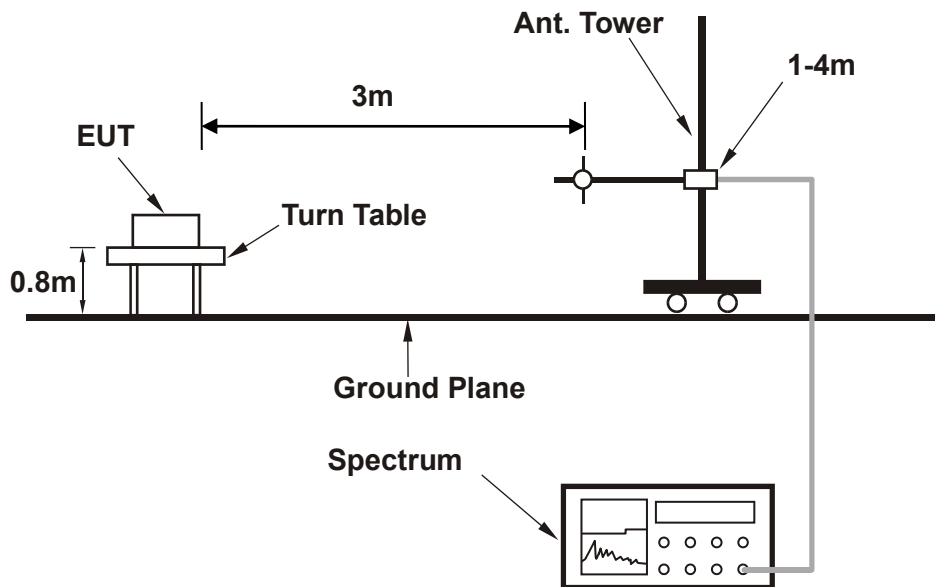

< Frequency Range above 1GHz >

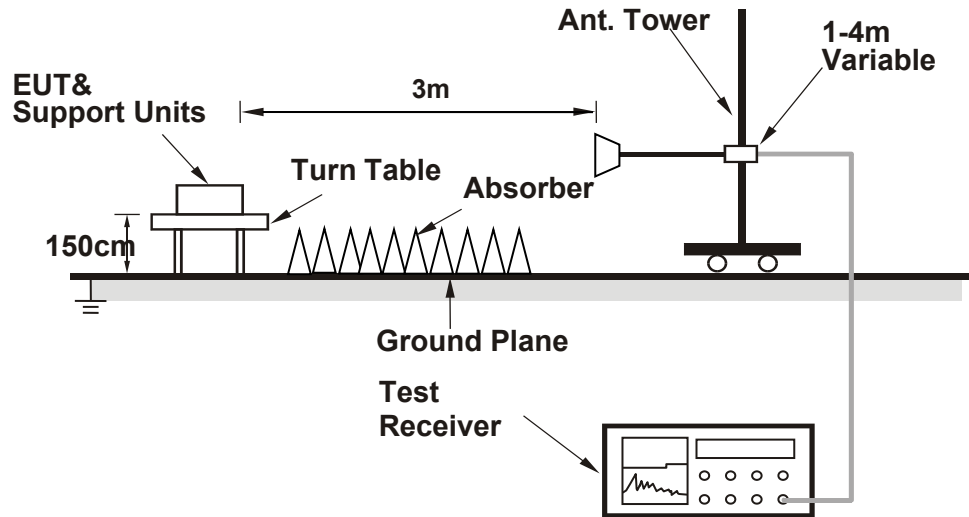

For the actual test configuration, please refer to the attached file (Test Setup Photo).

### 3.6.5 TEST RESULTS

NOTE : The 9K~30MHz amplitude of spurious emissions attenuated more than 20 dB below the permissible value is not required in the report.

#### BELOW 1GHz WORST-CASE DATA

30 MHz – 1GHz data:

LTE Band 26(Ant0) (DOWN):

CHANNEL BANDWIDTH: 10MHz / QPSK

<b>MODE</b>	TX channel 26740	<b>FREQUENCY RANGE</b>	Below 1000MHz
<b>ENVIRONMENTAL CONDITIONS</b>	23deg. C, 70%RH	<b>INPUT POWER</b>	AC 120V/60HZ
<b>TESTED BY</b>	Jace HU		
<b>ANTENNA POLARITY &amp; TEST DISTANCE: HORIZONTAL AT 3 M</b>			

Rg	Frequency [MHz]	PK+ Level [dBm]	PK+ Limit [dBm]	PK+ Margin [dB]	Correction [dB]	Polarization	Azimuth [deg]	Antenna Height [m]
1	32.200	-63.32	-13.00	50.32	5.69	H	246.8	1
1	51.900	-67.86	-13.00	54.86	3.74	H	1	2
1	71.450	-73.64	-13.00	60.64	-3.54	H	5	1
1	99.700	-73.33	-13.00	60.33	-4.90	H	55.8	2
1	232.250	-63.10	-13.00	50.10	8.05	H	133.5	2
1	439.550	-69.65	-13.00	56.65	6.86	H	353.4	1



<b>MODE</b>	TX channel 26740	<b>FREQUENCY RANGE</b>	Below 1000MHz
<b>ENVIRONMENTAL CONDITIONS</b>	23deg. C, 70%RH	<b>INPUT POWER</b>	AC 120V/60HZ
<b>TESTED BY</b>	Jace HU		
<b>ANTENNA POLARITY &amp; TEST DISTANCE: VERTICAL AT 3 M</b>			

Rg	Frequency [MHz]	PK+ Level [dBm]	PK+ Limit [dBm]	PK+ Margin [dB]	Correction [dB]	Polarization	Azimuth [deg]	Antenna Height [m]
1	33.200	-70.88	-13.00	57.88	-0.42	V	359	2
1	58.600	-69.87	-13.00	56.87	2.96	V	1	1
1	99.800	-62.86	-13.00	49.86	11.38	V	273.4	2
1	192.500	-74.45	-13.00	61.45	-1.26	V	273.4	2
1	334.650	-71.26	-13.00	58.26	5.71	V	357.8	1
1	438.550	-70.43	-13.00	57.43	6.40	V	95.3	2

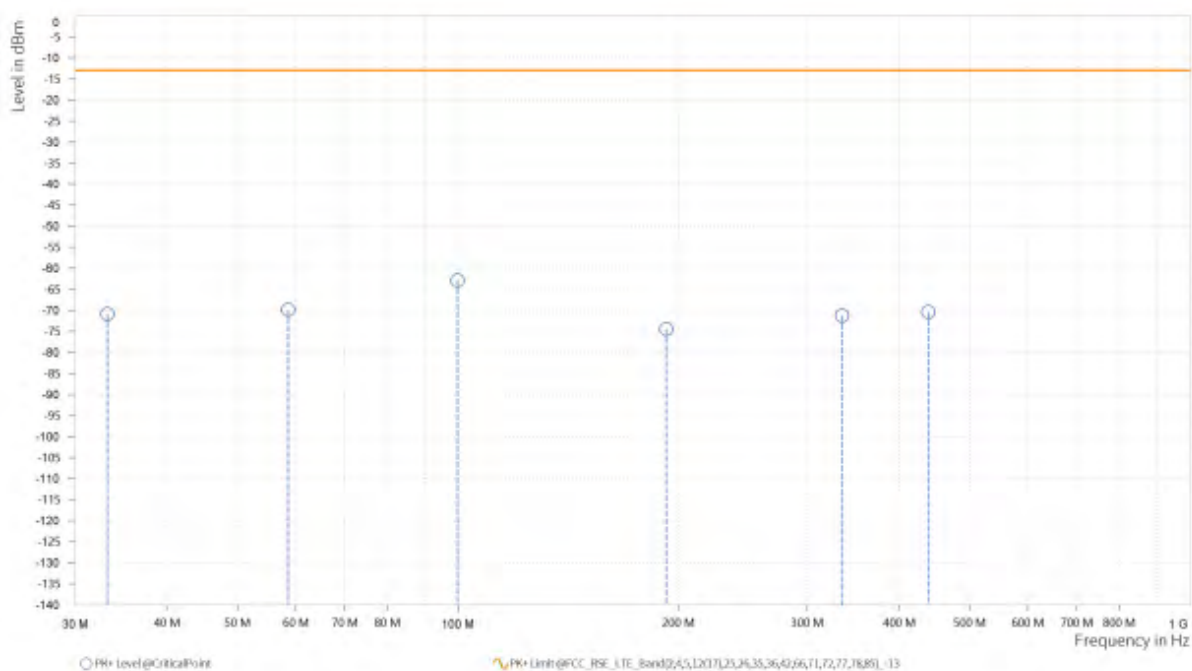



**BUREAU  
VERITAS**

**Test Report No.: W7L-P23100008RF08**

**ABOVE 1GHz**

**Note:** For higher frequency, the emission is too low to be detected.

**LTE BAND 26(Ant0) (DOWN):**

**CHANNEL BANDWIDTH: 1.4MHz / QPSK**

<b>MODE</b>	TX channel 26697	<b>FREQUENCY RANGE</b>	Above 1000MHz
<b>ENVIRONMENTAL CONDITIONS</b>	23deg. C, 70%RH	<b>INPUT POWER</b>	AC 120V/60HZ
<b>TESTED BY</b>	Jace Hu		
<b>ANTENNA POLARITY &amp; TEST DISTANCE: HORIZONTAL AT 3 M</b>			

Rg	Frequency [MHz]	PK+ Level [dBm]	PK+ Limit [dBm]	PK+ Margin [dB]	Correction [dB]	Polarization	Azimuth [deg]	Antenna Height [m]
2	1,637.000	-47.31	-13.00	34.31	14.96	H	2.2	2
3	2,455.500	-41.42	-13.00	28.42	20.95	H	102.2	1

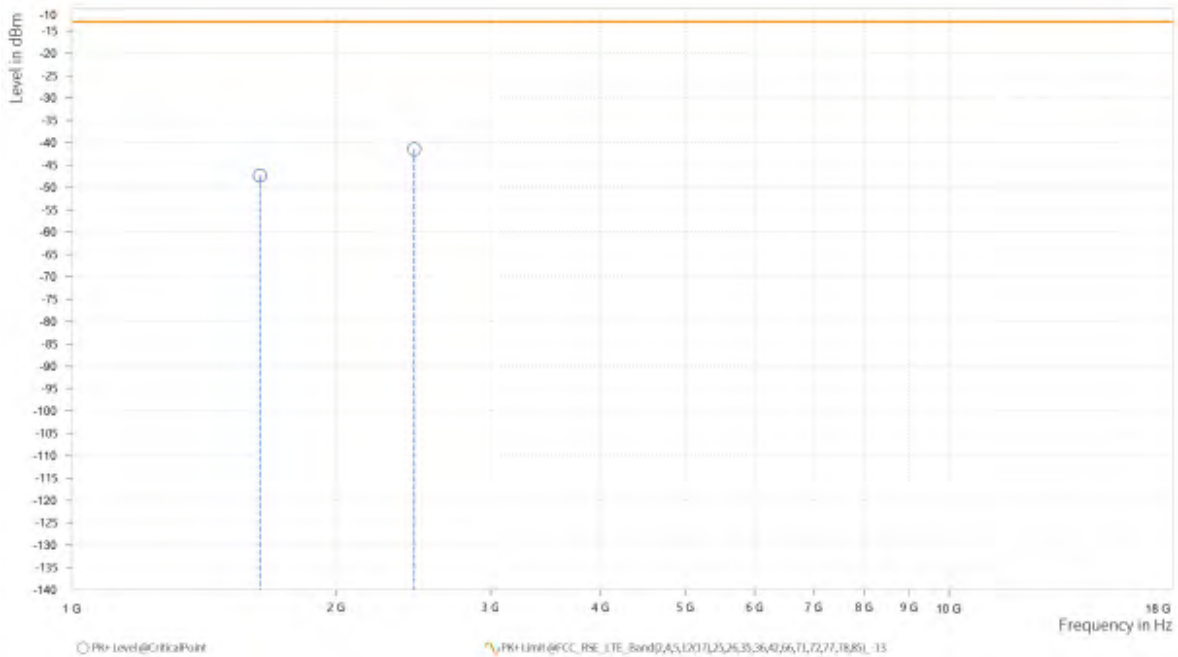





Test Report No.: W7L-P23100008RF08

<b>MODE</b>	TX channel 26697	<b>FREQUENCY RANGE</b>	Above 1000MHz
<b>ENVIRONMENTAL CONDITIONS</b>	23deg. C, 70%RH	<b>INPUT POWER</b>	AC 120V/60HZ
<b>TESTED BY</b>	Jace Hu		
<b>ANTENNA POLARITY &amp; TEST DISTANCE: VERTICAL AT 3 M</b>			

Rg	Frequency [MHz]	PK+ Level [dBm]	PK+ Limit [dBm]	PK+ Margin [dB]	Correction [dB]	Polarization	Azimuth [deg]	Antenna Height [m]
2	1,637.000	-43.73	-13.00	30.73	15.00	V	359	2
3	2,455.500	-41.78	-13.00	28.78	20.97	V	112.8	1

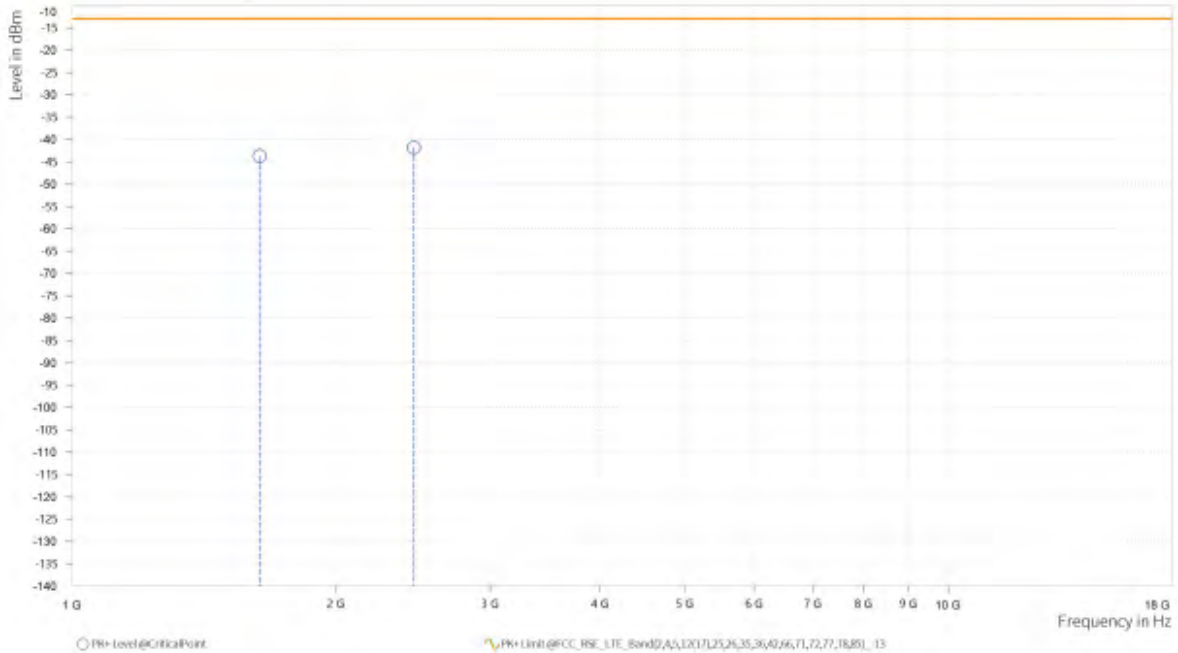



**BUREAU  
VERITAS**

Test Report No.: W7L-P23100008RF08

**CHANNEL BANDWIDTH: 3MHz / QPSK**

<b>MODE</b>	TX channel 26740	<b>FREQUENCY RANGE</b>	Above 1000MHz
<b>ENVIRONMENTAL CONDITIONS</b>	23deg. C, 70%RH	<b>INPUT POWER</b>	AC 120V/60HZ
<b>TESTED BY</b>	Jace Hu		
<b>ANTENNA POLARITY &amp; TEST DISTANCE: HORIZONTAL AT 3 M</b>			

Rg	Frequency [MHz]	PK+ Level [dBm]	PK+ Limit [dBm]	PK+ Margin [dB]	Correction [dB]	Polarization	Azimuth [deg]	Antenna Height [m]
2	1,635.500	-45.98	-13.00	32.98	14.93	H	50.7	1
3	2,453.000	-40.48	-13.00	27.48	21.02	H	100.9	1

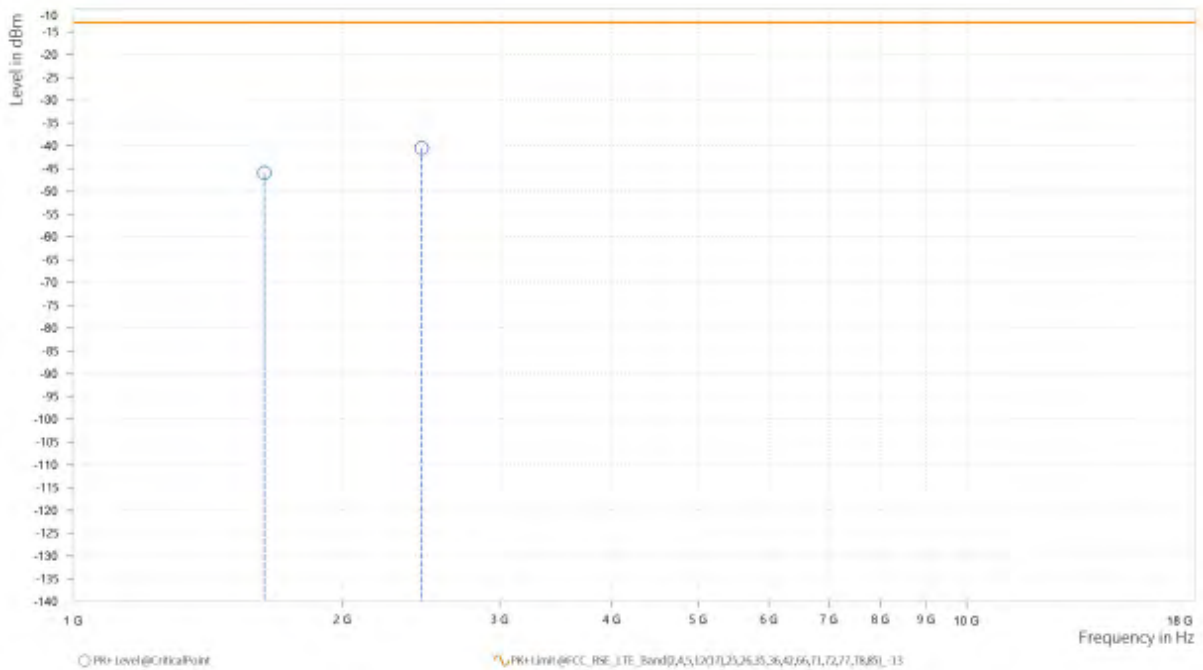



Test Report No.: W7L-P23100008RF08

<b>MODE</b>	TX channel 26740	<b>FREQUENCY RANGE</b>	Above 1000MHz
<b>ENVIRONMENTAL CONDITIONS</b>	23deg. C, 70%RH	<b>INPUT POWER</b>	AC 120V/60HZ
<b>TESTED BY</b>	Jace Hu		
<b>ANTENNA POLARITY &amp; TEST DISTANCE: VERTICAL AT 3 M</b>			

Rg	Frequency [MHz]	PK+ Level [dBm]	PK+ Limit [dBm]	PK+ Margin [dB]	Correction [dB]	Polarization	Azimuth [deg]	Antenna Height [m]
2	1,635.500	-48.14	-13.00	35.14	15.00	V	306.5	1
3	2,453.000	-43.15	-13.00	30.15	20.99	V	58.2	2

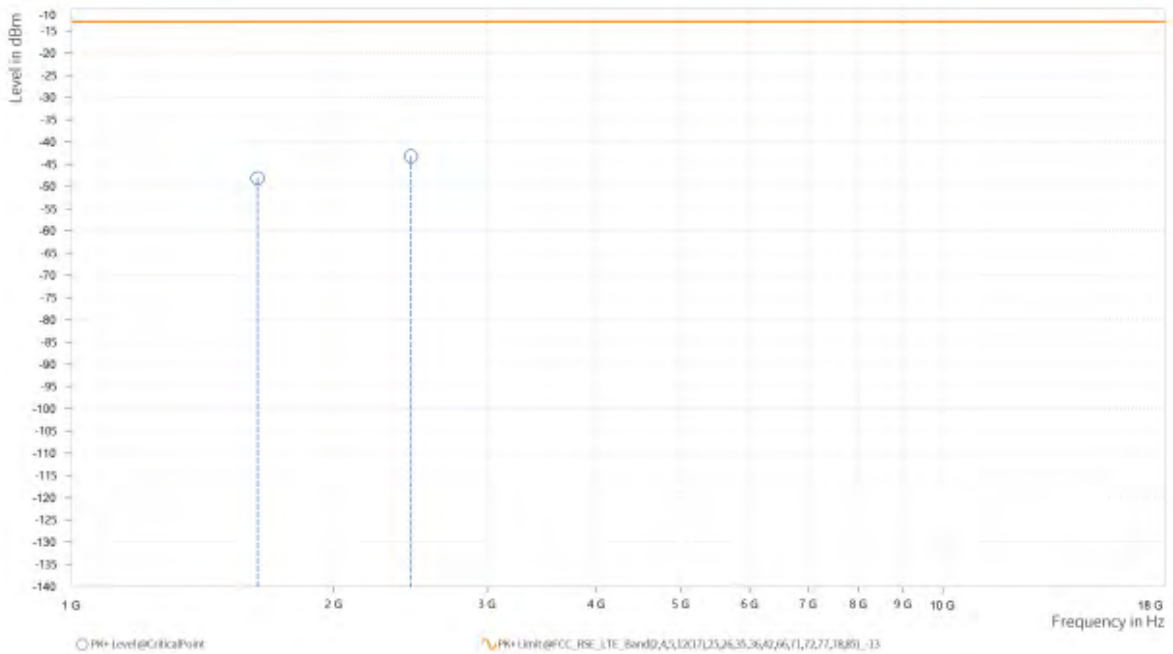



**BUREAU  
VERITAS**

Test Report No.: W7L-P23100008RF08

**CHANNEL BANDWIDTH: 5MHz / QPSK**

<b>MODE</b>	TX channel 26740	<b>FREQUENCY RANGE</b>	Above 1000MHz
<b>ENVIRONMENTAL CONDITIONS</b>	23deg. C, 70%RH	<b>INPUT POWER</b>	AC 120V/60HZ
<b>TESTED BY</b>	Jace Hu		
<b>ANTENNA POLARITY &amp; TEST DISTANCE: HORIZONTAL AT 3 M</b>			

Rg	Frequency [MHz]	PK+ Level [dBm]	PK+ Limit [dBm]	PK+ Margin [dB]	Correction [dB]	Polarization	Azimuth [deg]	Antenna Height [m]
2	1,633.500	-45.46	-13.00	32.46	14.89	H	51.9	1
3	2,450.500	-38.32	-13.00	25.32	21.08	H	257.8	2

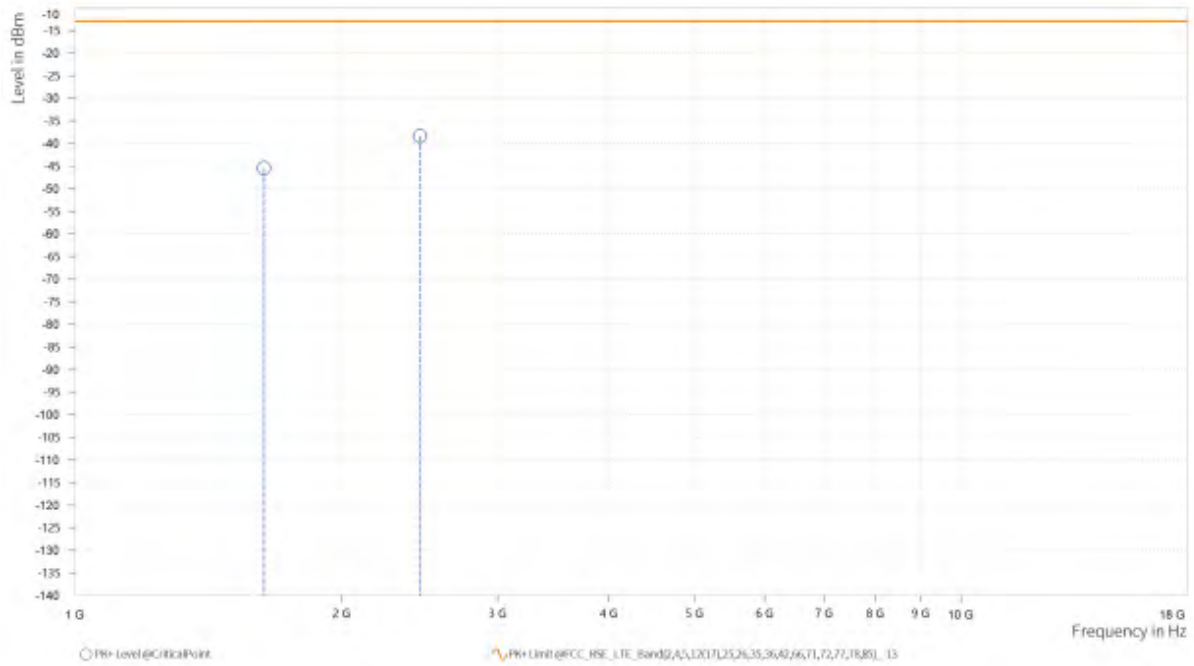



Test Report No.: W7L-P23100008RF08

<b>MODE</b>	TX channel 26740	<b>FREQUENCY RANGE</b>	Above 1000MHz
<b>ENVIRONMENTAL CONDITIONS</b>	23deg. C, 70%RH	<b>INPUT POWER</b>	AC 120V/60HZ
<b>TESTED BY</b>	Jace Hu		
<b>ANTENNA POLARITY &amp; TEST DISTANCE: VERTICAL AT 3 M</b>			

Rg	Frequency [MHz]	PK+ Level [dBm]	PK+ Limit [dBm]	PK+ Margin [dB]	Correction [dB]	Polarization	Azimuth [deg]	Antenna Height [m]
2	1,633.500	-47.72	-13.00	34.72	15.00	V	2	2
3	2,450.000	-41.42	-13.00	28.42	21.02	V	55.9	2

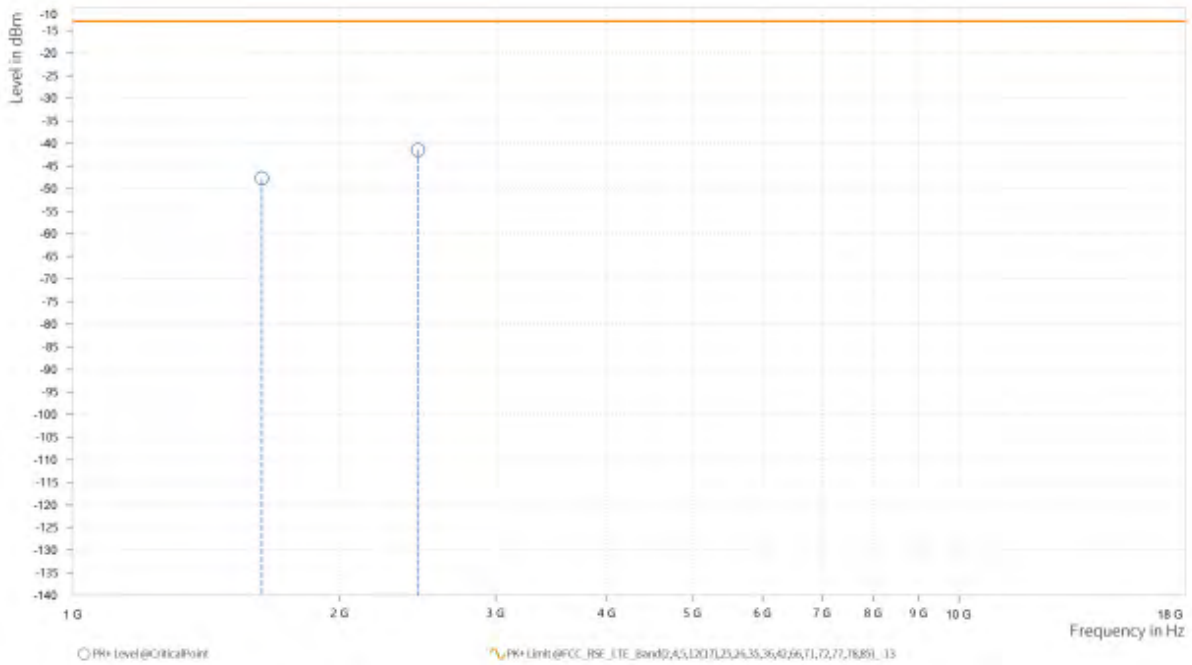



**BUREAU  
VERITAS**

Test Report No.: W7L-P23100008RF08

**CHANNEL BANDWIDTH: 10MHz / QPSK**

<b>MODE</b>	TX channel 26740	<b>FREQUENCY RANGE</b>	Above 1000MHz
<b>ENVIRONMENTAL CONDITIONS</b>	23deg. C, 70%RH	<b>INPUT POWER</b>	AC 120V/60HZ
<b>TESTED BY</b>	Jace Hu		
<b>ANTENNA POLARITY &amp; TEST DISTANCE: HORIZONTAL AT 3 M</b>			

Rg	Frequency [MHz]	PK+ Level [dBm]	PK+ Limit [dBm]	PK+ Margin [dB]	Correction [dB]	Polarization	Azimuth [deg]	Antenna Height [m]
2	1,629.000	-39.29	-13.00	26.29	14.80	H	50.8	1
3	2,444.000	-30.95	-13.00	17.95	21.17	H	101	1

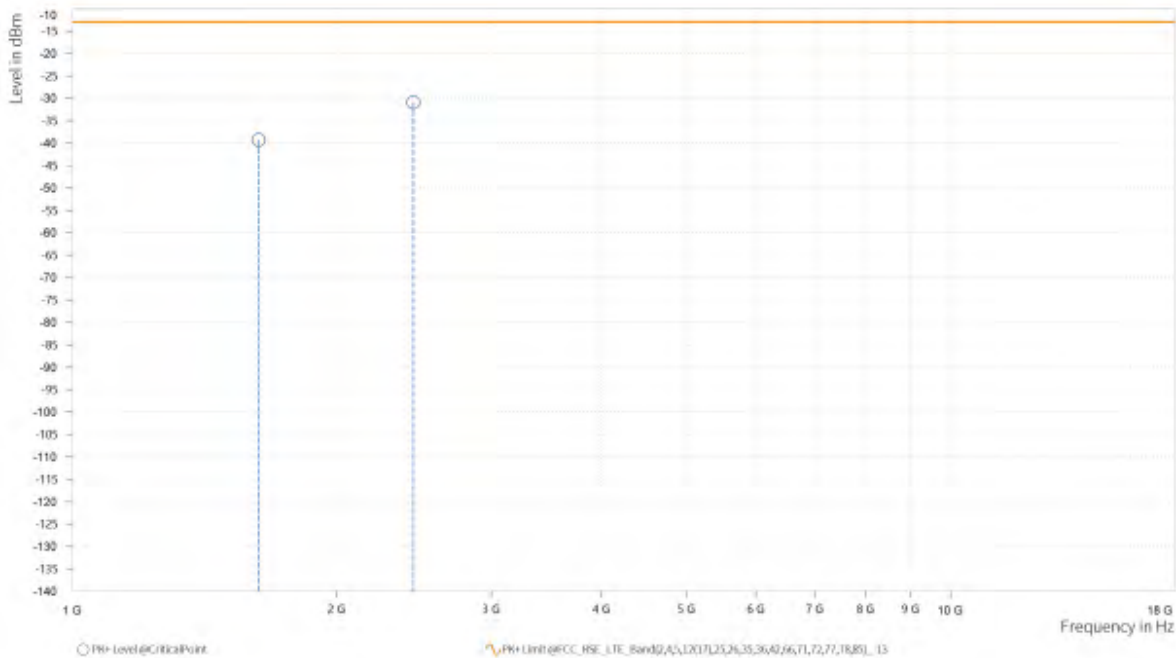



Test Report No.: W7L-P23100008RF08

<b>MODE</b>	TX channel 26740	<b>FREQUENCY RANGE</b>	Above 1000MHz
<b>ENVIRONMENTAL CONDITIONS</b>	23deg. C, 70%RH	<b>INPUT POWER</b>	AC 120V/60HZ
<b>TESTED BY</b>	Jace Hu		
<b>ANTENNA POLARITY &amp; TEST DISTANCE: VERTICAL AT 3 M</b>			

Rg	Frequency [MHz]	PK+ Level [dBm]	PK+ Limit [dBm]	PK+ Margin [dB]	Correction [dB]	Polarization	Azimuth [deg]	Antenna Height [m]
2	1,629.500	-42.79	-13.00	29.79	14.99	V	1	1
3	2,443.500	-33.96	-13.00	20.96	20.99	V	1	1

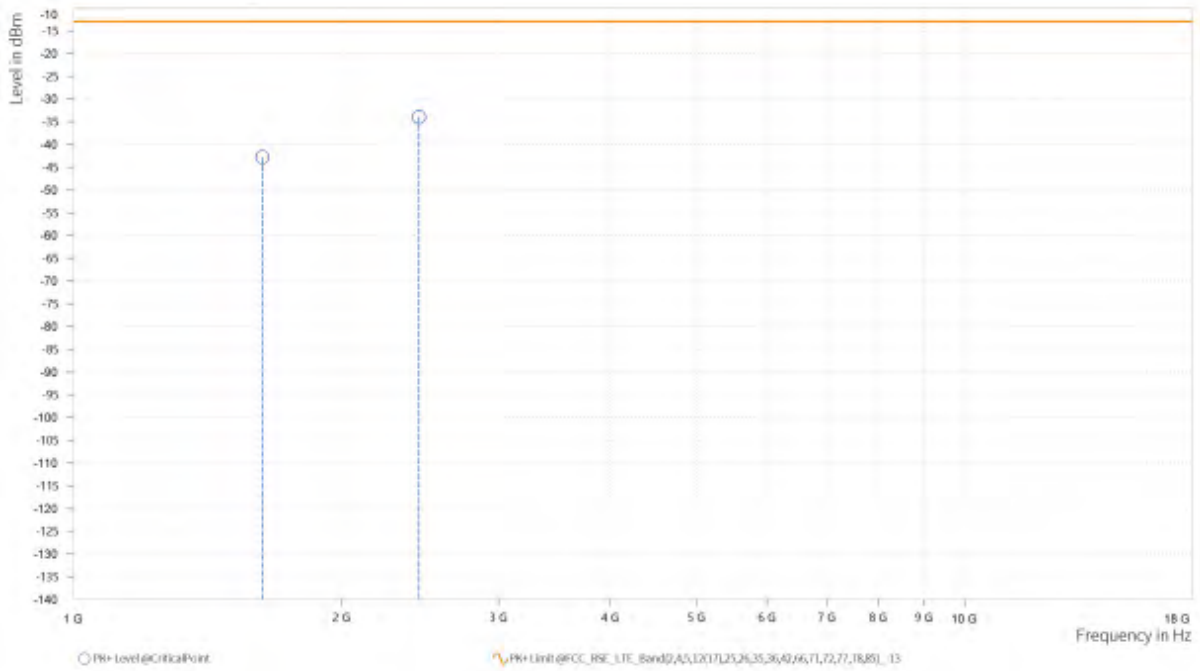

### 3.7 PEAK TO AVERAGE RATIO

#### 3.7.1 LIMITS OF PEAK TO AVERAGE RATIO MEASUREMENT

In measuring transmissions in this band using an average power technique, the peak to-average ratio (PAR) of the transmission may not exceed 13 dB.

#### 3.7.2 TEST SETUP

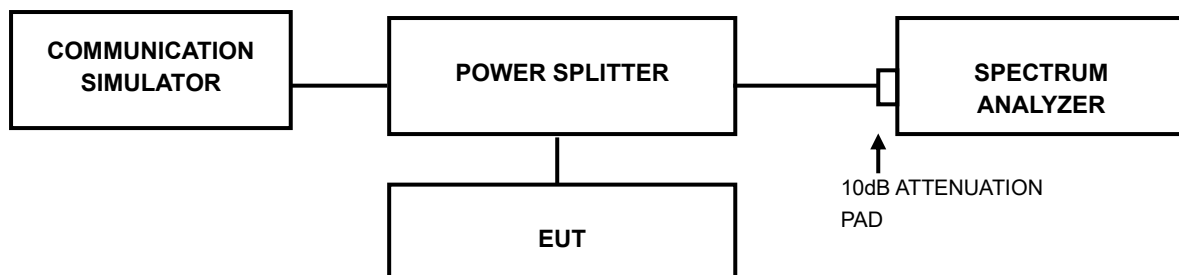

#### 3.7.3 TEST PROCEDURES

1. Set resolution/measurement bandwidth  $\geq$  signal's occupied bandwidth.
2. Set the number of counts to a value that stabilizes the measured CCDF curve.
3. Record the maximum PAPR level associated with a probability of 0.1%.





Test Report No.: W7L-P23100008RF08

### 3.7.4 TEST RESULTS

Please Refer to Appendix Of this test report.



**BUREAU  
VERITAS**

Test Report No.: W7L-P23100008RF08

## 4 PHOTOGRAPHS OF THE TEST CONFIGURATION

Please refer to the attached file (Test Setup Photo).



**BUREAU  
VERITAS**

Test Report No.: W7L-P23100008RF08

## 5 INFORMATION ON THE TESTING LABORATORIES

We, **Huarui 7layers High Technology (Suzhou) Co., Ltd.** were founded in 2020 to provide our best service in EMC, Radio, Telecom and Safety consultation. Our laboratories are accredited and approved according to ISO/IEC 17025.

If you have any comments, please feel free to contact us at the following:

### **Suzhou EMC/RF Lab:**

Tel: +86 (0557) 368 1008



Test Report No.: W7L-P23100008RF08

## 6 MODIFICATIONS RECORDERS FOR ENGINEERING CHANGES TO THE EUT BY THE LAB

No modifications were made to the EUT by the lab during the test.



Test Report No.: W7L-P23100008RF08

## 7 APPENDIX

### LTE BAND26

#### PEAK-TO-AVERAGE RATIO(CCDF)

#### TEST RESULT

Band	Bandwidth	Modulation	Channel	RB Configuration	Result(dB)	Limit(dB)	Verdict
26(814-824)	10MHz	QPSK	26740	1RB#0	4.09	13	PASS
26(814-824)	10MHz	16QAM	26740	1RB#0	5.08	13	PASS
26(814-824)	10MHz	64QAM	26740	1RB#0	5.65	13	PASS
26(814-824)	10MHz	QPSK	26740	50RB#0	5.41	13	PASS
26(814-824)	10MHz	16QAM	26740	50RB#0	6.19	13	PASS
26(814-824)	10MHz	64QAM	26740	50RB#0	5.52	13	PASS



BUREAU VERITAS

Test Report No.: W7L-P23100008RF08

### TEST GRAPHS

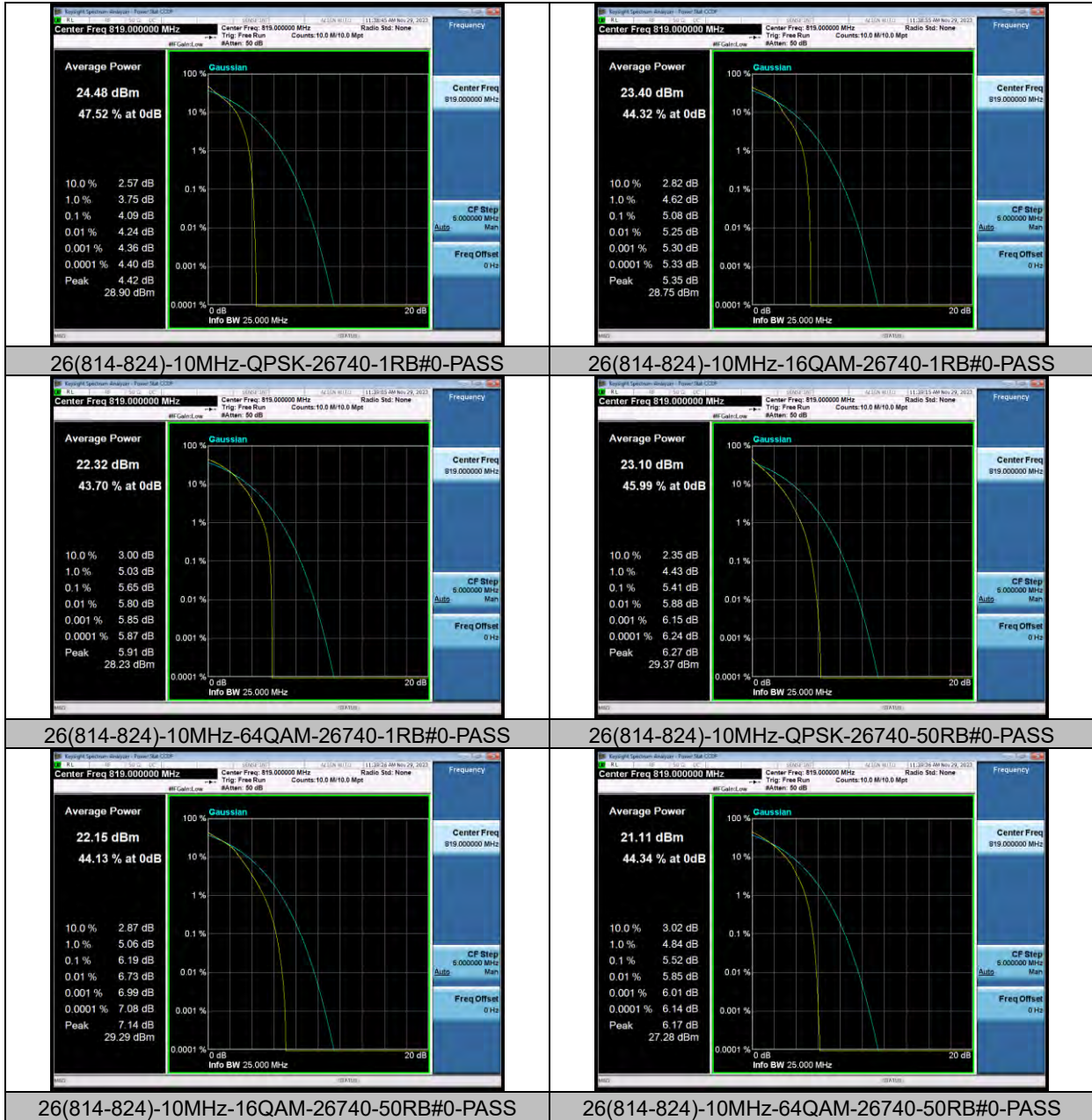



Test Report No.: W7L-P23100008RF08

## 26DB BANDWIDTH AND OCCUPIED BANDWIDTH

### TEST RESULT

Band	Bandwidth	Modulation	Channel	RB Configuration	Occupied Bandwidth (MHz)	26dB Bandwidth (MHz)	Verdict
26(814-824)	1.4MHz	QPSK	26697	6RB#0	1.0931	1.290	PASS
26(814-824)	1.4MHz	16QAM	26697	6RB#0	1.0997	1.303	PASS
26(814-824)	1.4MHz	64QAM	26697	6RB#0	1.0953	1.300	PASS
26(814-824)	1.4MHz	QPSK	26740	6RB#0	1.0934	1.276	PASS
26(814-824)	1.4MHz	16QAM	26740	6RB#0	1.1001	1.299	PASS
26(814-824)	1.4MHz	64QAM	26740	6RB#0	1.0927	1.288	PASS
26(814-824)	1.4MHz	QPSK	26783	6RB#0	1.0894	1.286	PASS
26(814-824)	1.4MHz	16QAM	26783	6RB#0	1.0966	1.299	PASS
26(814-824)	1.4MHz	64QAM	26783	6RB#0	1.0938	1.278	PASS
26(814-824)	3MHz	QPSK	26705	15RB#0	2.6871	2.891	PASS
26(814-824)	3MHz	16QAM	26705	15RB#0	2.6843	2.923	PASS
26(814-824)	3MHz	64QAM	26705	15RB#0	2.6941	2.910	PASS
26(814-824)	3MHz	QPSK	26740	15RB#0	2.6898	2.910	PASS
26(814-824)	3MHz	16QAM	26740	15RB#0	2.6817	2.909	PASS
26(814-824)	3MHz	64QAM	26740	15RB#0	2.6855	2.908	PASS
26(814-824)	3MHz	QPSK	26775	15RB#0	2.6882	2.902	PASS
26(814-824)	3MHz	16QAM	26775	15RB#0	2.6892	2.906	PASS
26(814-824)	3MHz	64QAM	26775	15RB#0	2.6857	2.910	PASS
26(814-824)	5MHz	QPSK	26715	25RB#0	4.5030	4.924	PASS
26(814-824)	5MHz	16QAM	26715	25RB#0	4.4823	4.905	PASS
26(814-824)	5MHz	64QAM	26715	25RB#0	4.4942	4.929	PASS
26(814-824)	5MHz	QPSK	26740	25RB#0	4.4860	4.904	PASS
26(814-824)	5MHz	16QAM	26740	25RB#0	4.4948	4.954	PASS
26(814-824)	5MHz	64QAM	26740	25RB#0	4.4951	4.923	PASS
26(814-824)	5MHz	QPSK	26765	25RB#0	4.4937	4.952	PASS
26(814-824)	5MHz	16QAM	26765	25RB#0	4.5037	4.939	PASS
26(814-824)	5MHz	64QAM	26765	25RB#0	4.4989	5.144	PASS
26(814-824)	10MHz	QPSK	26740	50RB#0	8.9802	9.820	PASS
26(814-824)	10MHz	16QAM	26740	50RB#0	8.9660	9.740	PASS
26(814-824)	10MHz	64QAM	26740	50RB#0	8.9806	9.729	PASS

## TEST GRAPHS

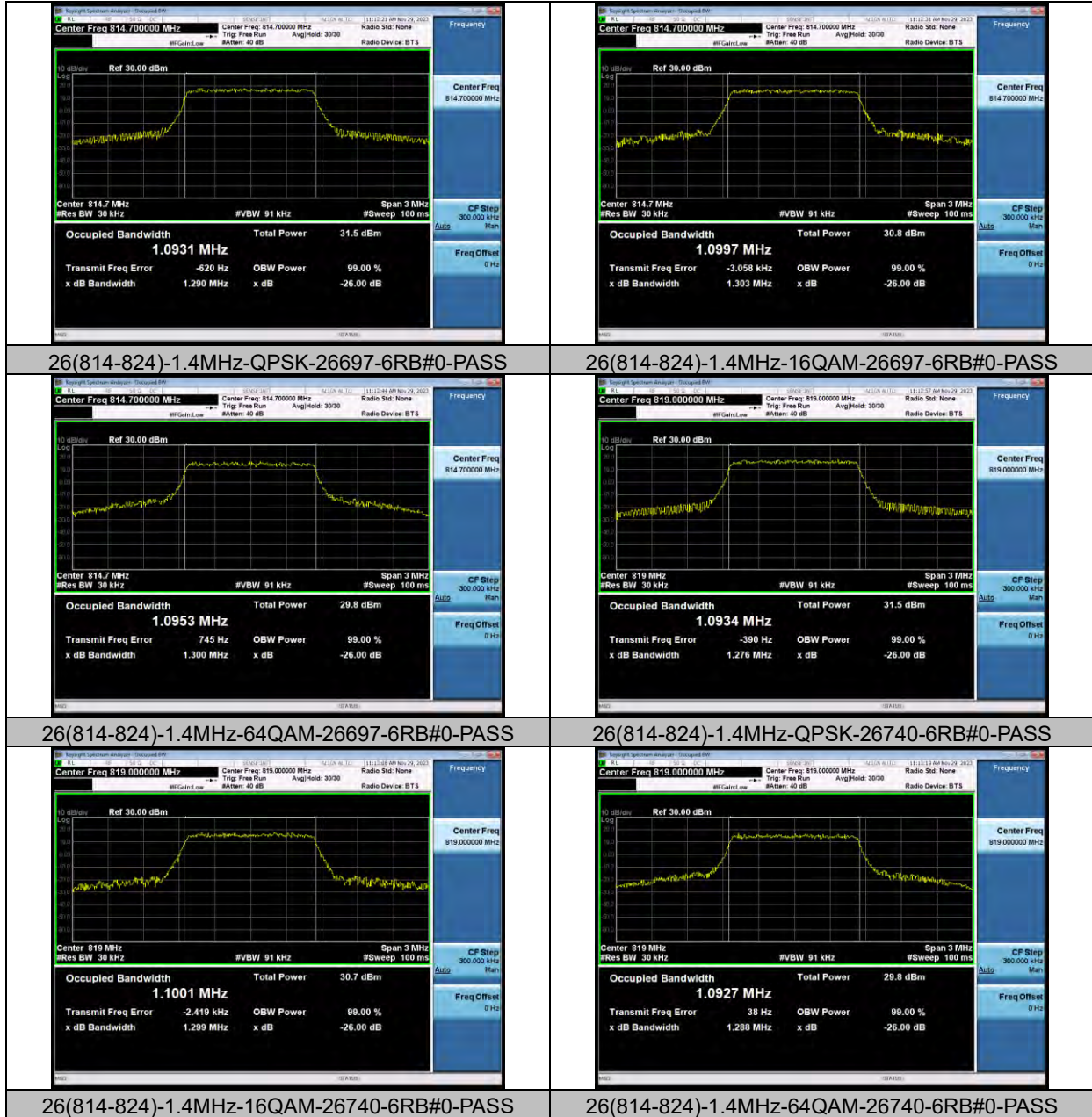





BUREAU VERITAS

Test Report No.: W7L-P23100008RF08

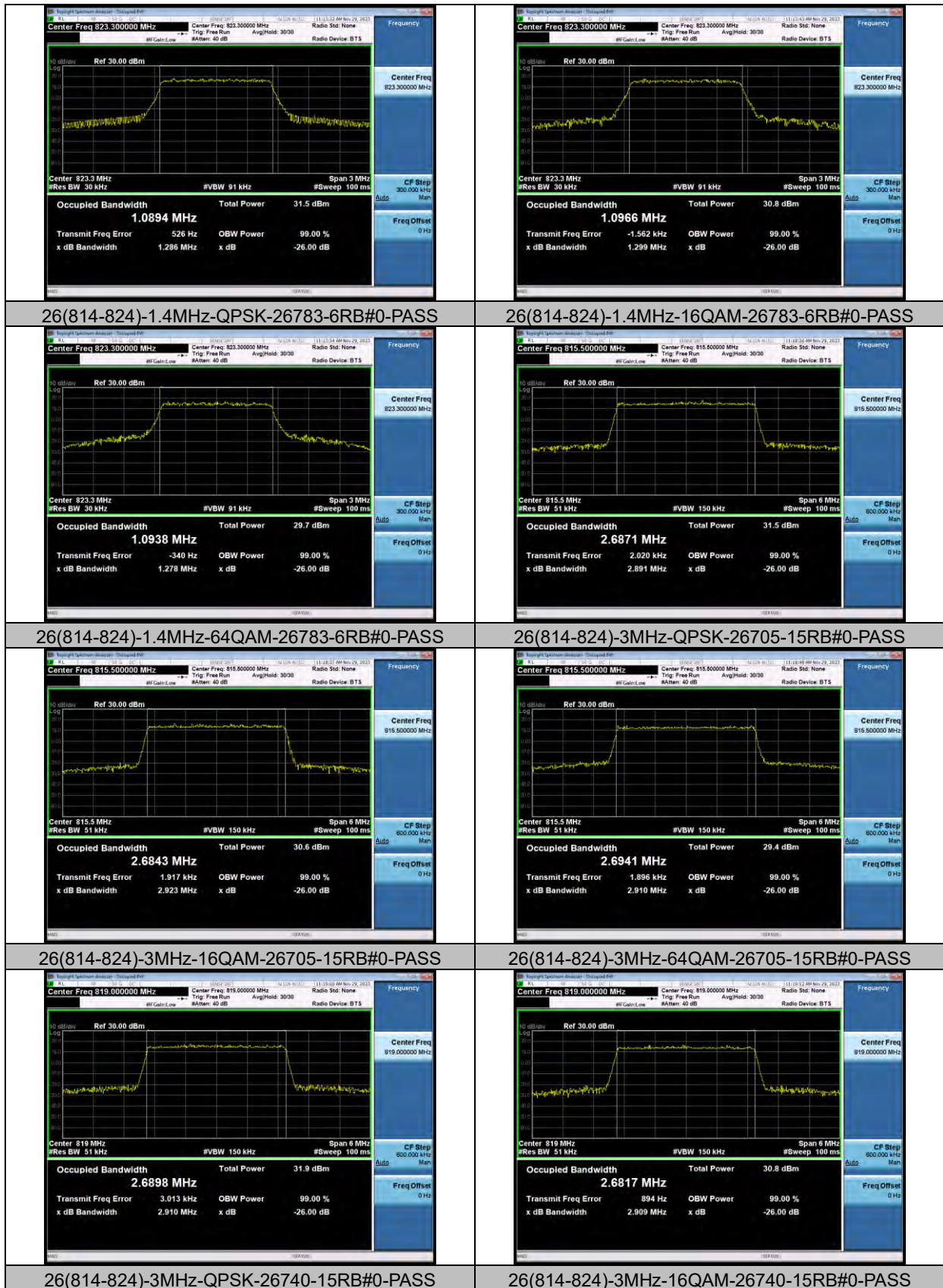



BUREAU VERITAS

Test Report No.: W7L-P23100008RF08

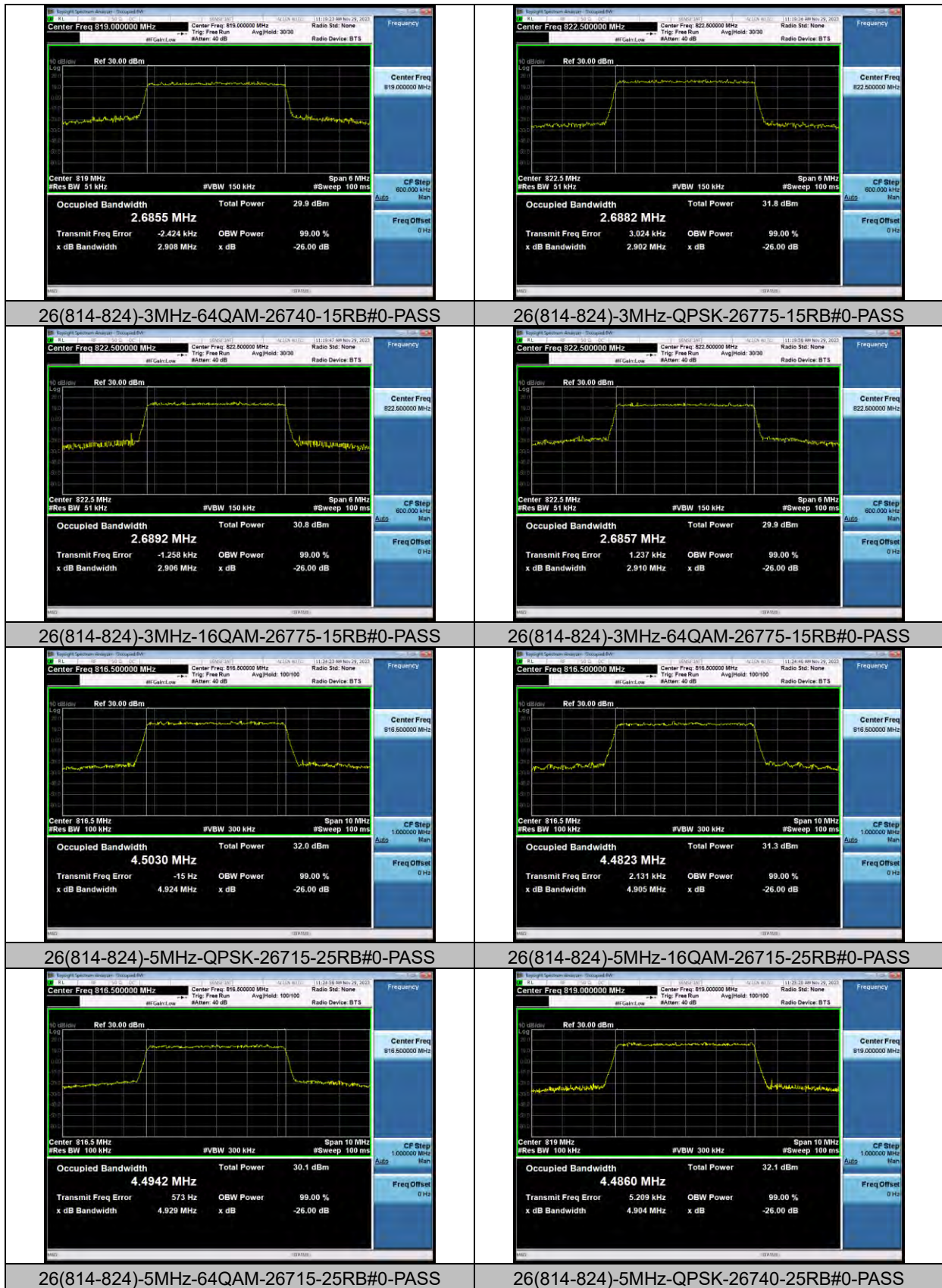





BUREAU VERITAS

# Test Report No.: W7L-P23100008RF08

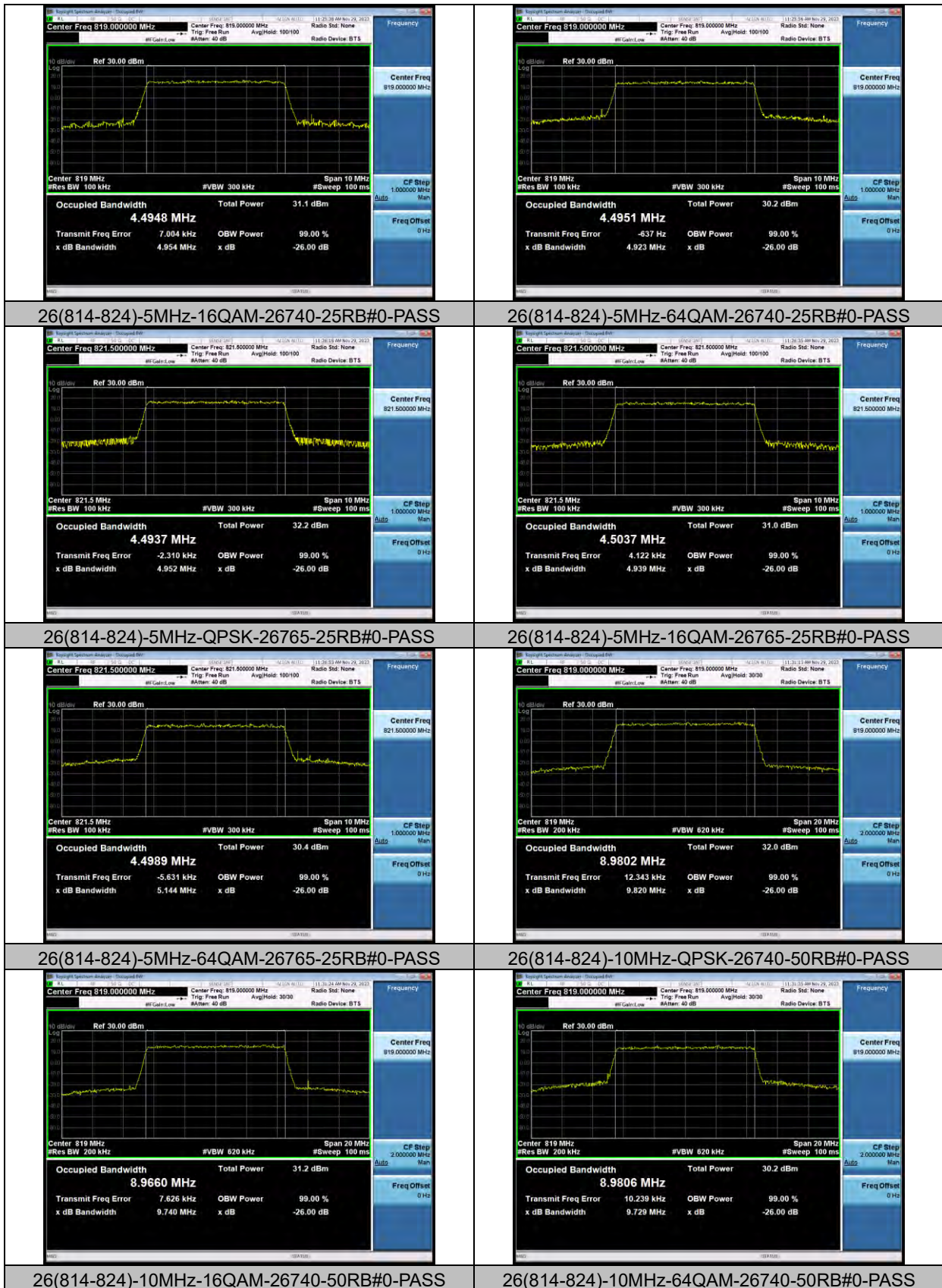



BUREAU  
VERITAS

Test Report No.: W7L-P23100008RF08

## BAND EDGE

## TEST RESULT

Band	Bandwidth	Modulation	Channel	RB Configuration	Result(dBm)	Verdict
26(814-824)	1.4MHz	QPSK	26697	1RB#0	-28.08	PASS
26(814-824)	1.4MHz	16QAM	26697	1RB#0	-30.31	PASS
26(814-824)	1.4MHz	64QAM	26697	1RB#0	-31.89	PASS
26(814-824)	1.4MHz	QPSK	26697	6RB#0	-36.38	PASS
26(814-824)	1.4MHz	16QAM	26697	6RB#0	-31.23	PASS
26(814-824)	1.4MHz	64QAM	26697	6RB#0	-24.90	PASS
26(814-824)	1.4MHz	QPSK	26783	1RB#5	-27.52	PASS
26(814-824)	1.4MHz	16QAM	26783	1RB#5	-29.40	PASS
26(814-824)	1.4MHz	64QAM	26783	1RB#5	-31.26	PASS
26(814-824)	1.4MHz	QPSK	26783	6RB#0	-38.09	PASS
26(814-824)	1.4MHz	16QAM	26783	6RB#0	-32.17	PASS
26(814-824)	1.4MHz	64QAM	26783	6RB#0	-26.24	PASS
26(814-824)	3MHz	QPSK	26705	1RB#0	-29.65	PASS
26(814-824)	3MHz	16QAM	26705	1RB#0	-33.00	PASS
26(814-824)	3MHz	64QAM	26705	1RB#0	-34.26	PASS
26(814-824)	3MHz	QPSK	26705	15RB#0	-43.24	PASS
26(814-824)	3MHz	16QAM	26705	15RB#0	-36.04	PASS
26(814-824)	3MHz	64QAM	26705	15RB#0	-31.52	PASS
26(814-824)	3MHz	QPSK	26775	1RB#14	-30.76	PASS
26(814-824)	3MHz	16QAM	26775	1RB#14	-33.39	PASS
26(814-824)	3MHz	64QAM	26775	1RB#14	-34.93	PASS
26(814-824)	3MHz	QPSK	26775	15RB#0	-43.89	PASS
26(814-824)	3MHz	16QAM	26775	15RB#0	-43.72	PASS
26(814-824)	3MHz	64QAM	26775	15RB#0	-31.30	PASS
26(814-824)	5MHz	QPSK	26715	1RB#0	-31.93	PASS
26(814-824)	5MHz	16QAM	26715	1RB#0	-31.90	PASS
26(814-824)	5MHz	64QAM	26715	1RB#0	-33.06	PASS
26(814-824)	5MHz	QPSK	26715	25RB#0	-44.34	PASS
26(814-824)	5MHz	16QAM	26715	25RB#0	-37.88	PASS
26(814-824)	5MHz	64QAM	26715	25RB#0	-33.01	PASS
26(814-824)	5MHz	QPSK	26765	1RB#24	-32.09	PASS
26(814-824)	5MHz	16QAM	26765	1RB#24	-33.94	PASS
26(814-824)	5MHz	64QAM	26765	1RB#24	-31.50	PASS
26(814-824)	5MHz	QPSK	26765	25RB#0	-45.90	PASS
26(814-824)	5MHz	16QAM	26765	25RB#0	-38.50	PASS
26(814-824)	5MHz	64QAM	26765	25RB#0	-34.04	PASS
26(814-824)	10MHz	QPSK	26740	1RB#0	-37.61	PASS
26(814-824)	10MHz	16QAM	26740	1RB#0	-38.66	PASS
26(814-824)	10MHz	64QAM	26740	1RB#0	-39.04	PASS
26(814-824)	10MHz	QPSK	26740	1RB#49	-37.32	PASS
26(814-824)	10MHz	16QAM	26740	1RB#49	-36.23	PASS
26(814-824)	10MHz	64QAM	26740	1RB#49	-38.99	PASS
26(814-824)	10MHz	QPSK	26740	50RB#0	-41.43	PASS
26(814-824)	10MHz	16QAM	26740	50RB#0	-42.03	PASS
26(814-824)	10MHz	64QAM	26740	50RB#0	-37.24	PASS





BUREAU VERITAS

Test Report No.: W7L-P23100008RF08

### TEST GRAPHS

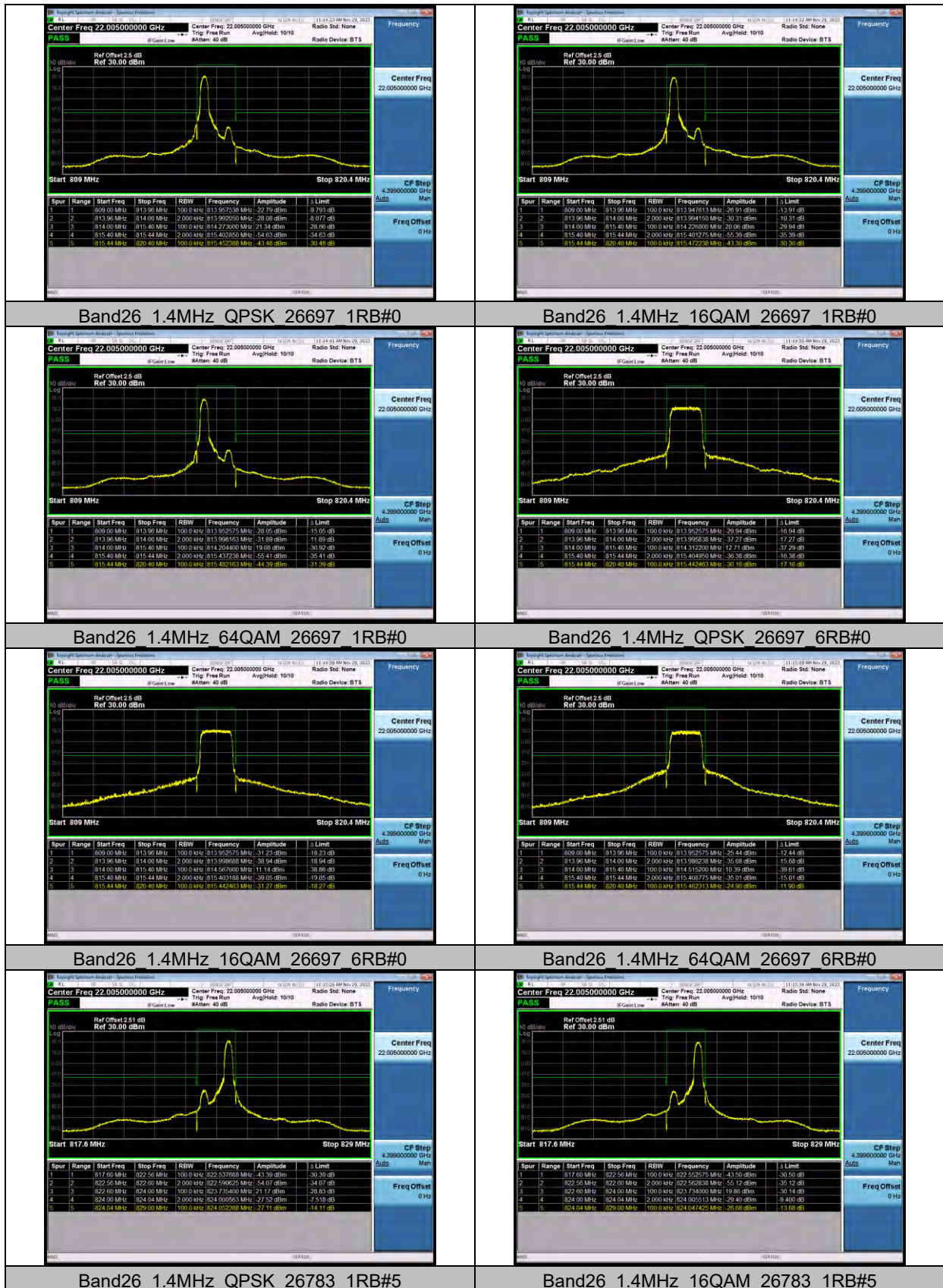



**BUREAU  
VERITAS**

**Test Report No.: W7L-P23100008RF08**

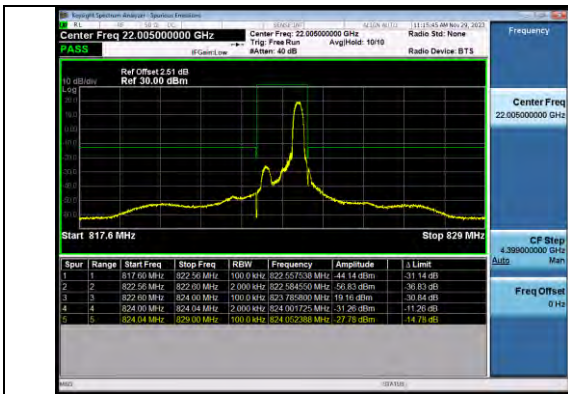

**Band26 1.4MHz 64QAM 26783 1RB#5**

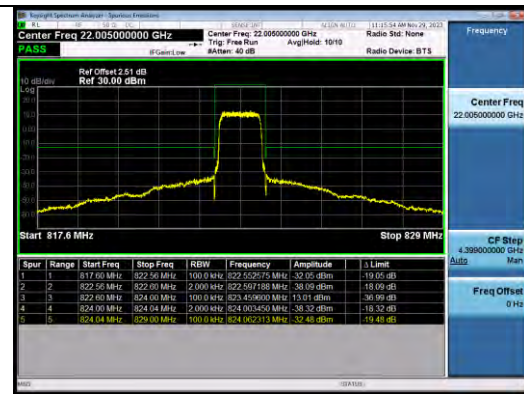

**Band26 1.4MHz QPSK 26783 6RB#0**

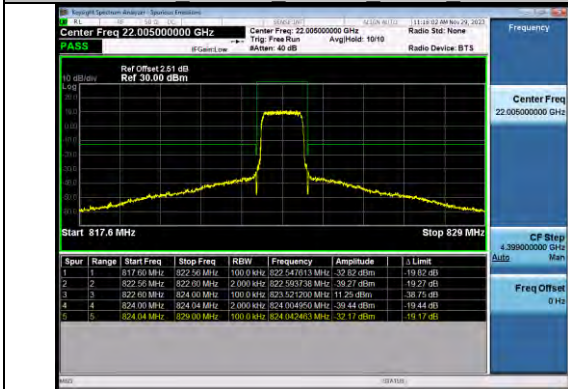

**Band26 1.4MHz 16QAM 26783 6RB#0**

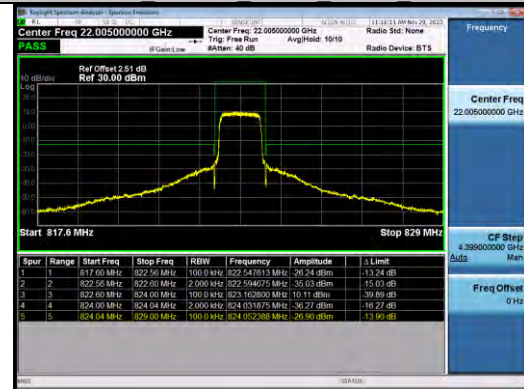

**Band26 1.4MHz 64QAM 26783 6RB#0**

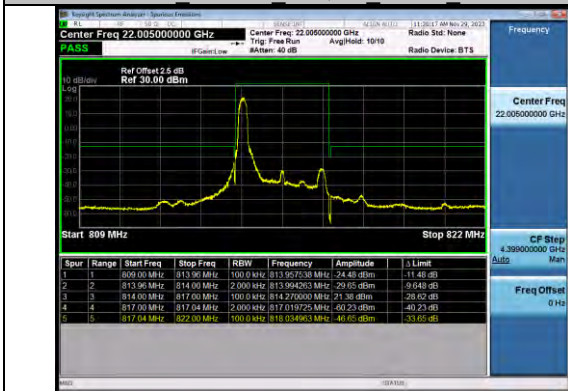

**Band26 3MHz QPSK 26705 1RB#0**

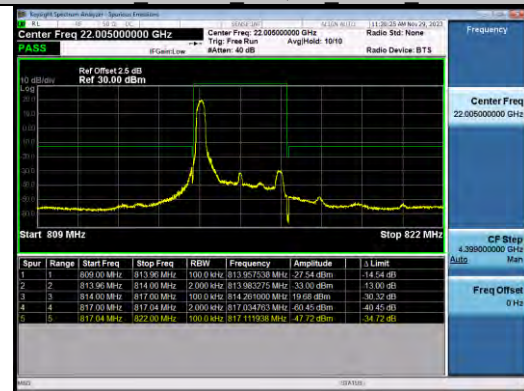

**Band26 3MHz 16QAM 26705 1RB#0**

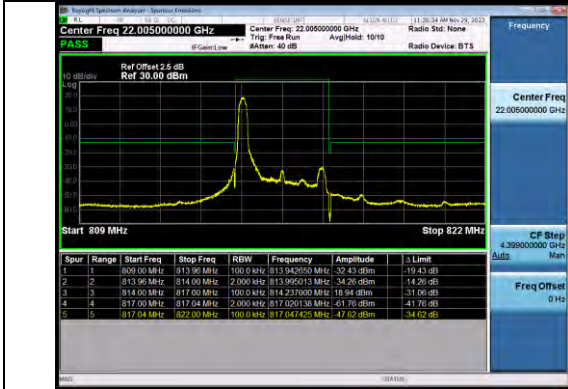

**Band26 3MHz 64QAM 26705 1RB#0**

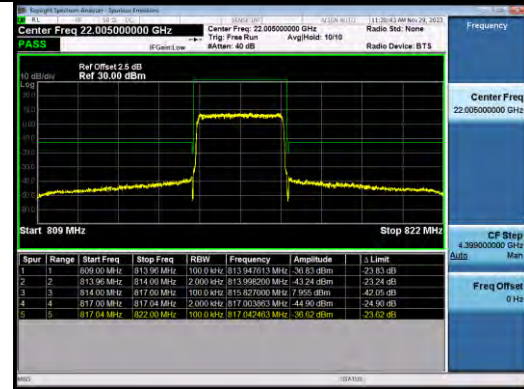

**Band26 3MHz QPSK 26705 15RB#0**





**BUREAU  
VERITAS**

**Test Report No.: W7L-P23100008RF08**



**Band26 3MHz 16QAM 26705 15RB#0**

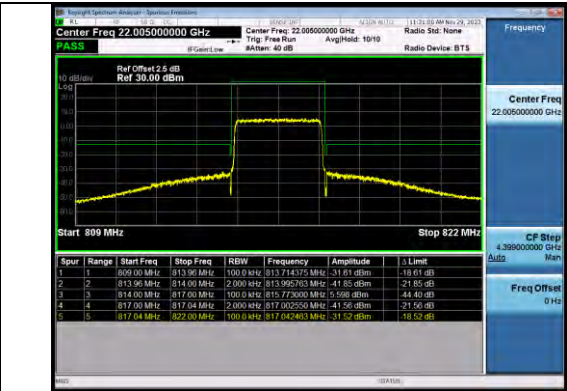

**Band26 3MHz 64QAM 26705 15RB#0**

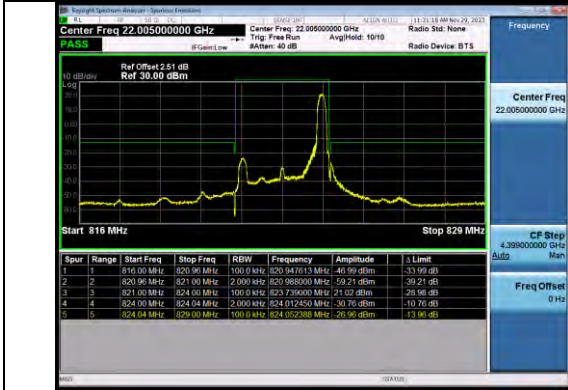

**Band26 3MHz QPSK 26775 1RB#14**

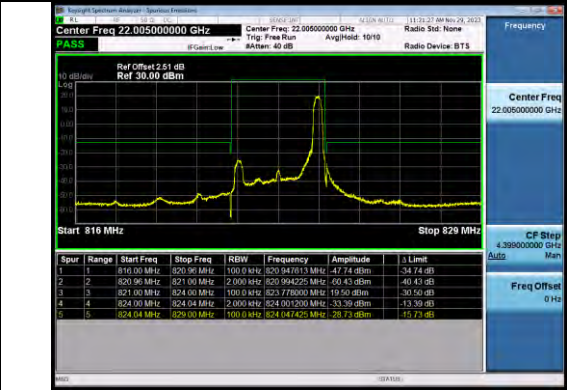

**Band26 3MHz 16QAM 26775 1RB#14**

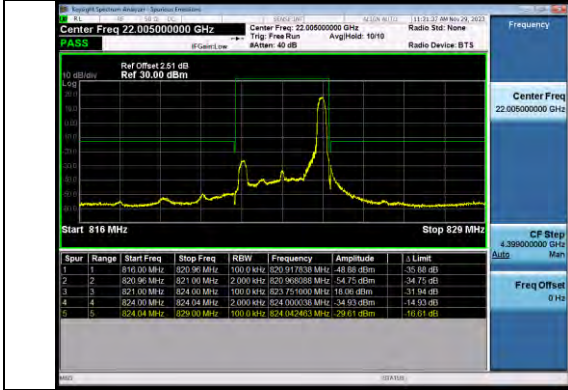

**Band26 3MHz 64QAM 26775 1RB#14**

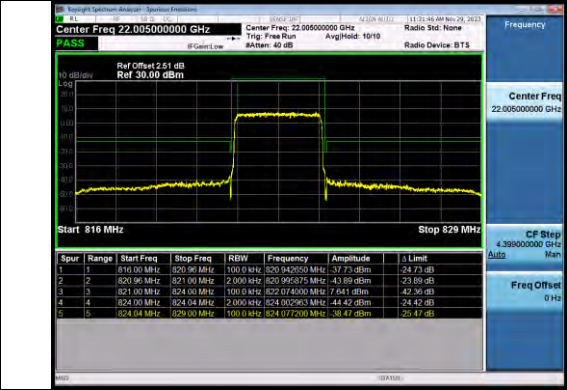

**Band26 3MHz QPSK 26775 15RB#0**

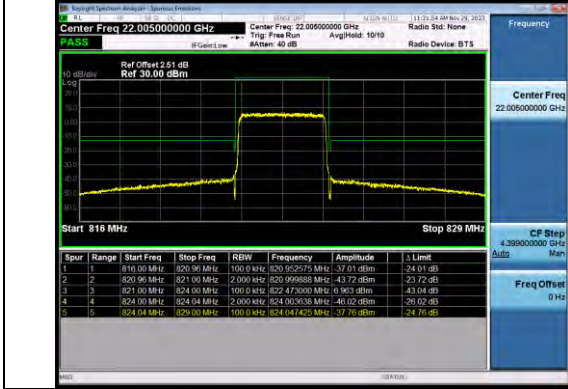

**Band26 3MHz 16QAM 26775 15RB#0**

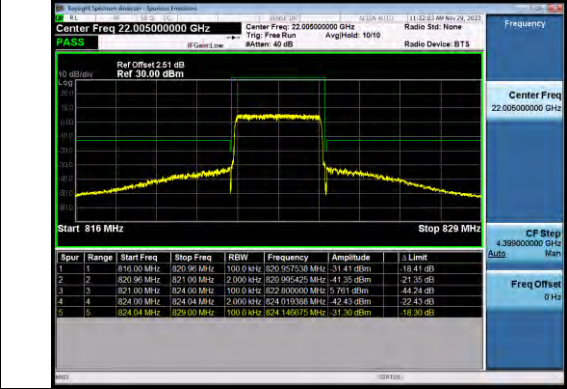

**Band26 3MHz 64QAM 26775 15RB#0**



**BUREAU  
VERITAS**

**Test Report No.: W7L-P23100008RF08**

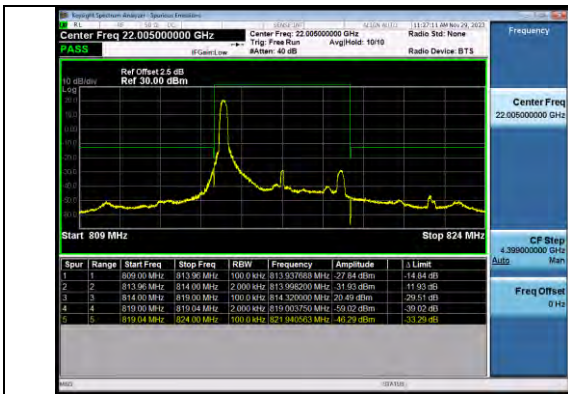

**Band26 5MHz QPSK 26715 1RB#0**

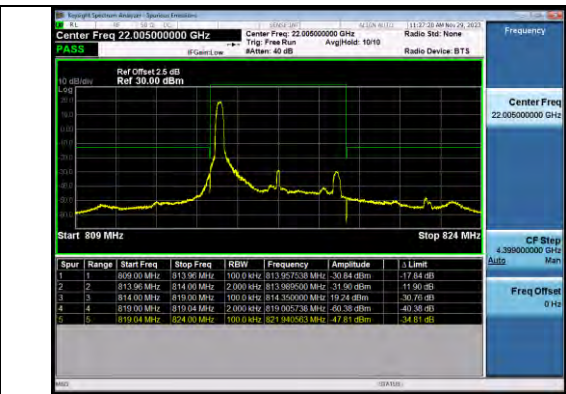

**Band26 5MHz 16QAM 26715 1RB#0**

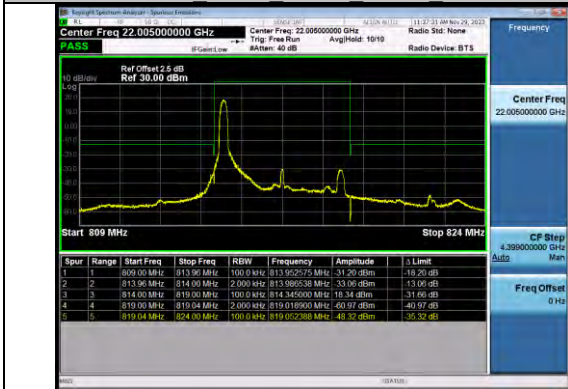

**Band26 5MHz 64QAM 26715 1RB#0**

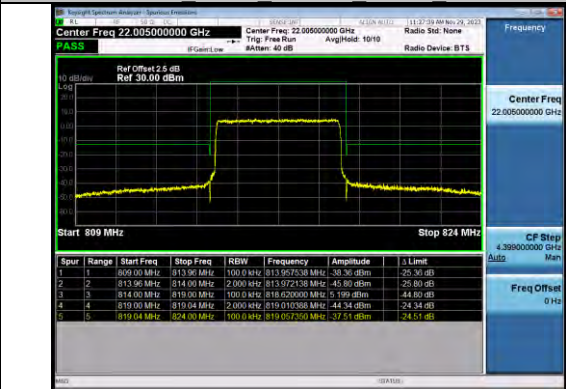

**Band26 5MHz QPSK 26715 25RB#0**



**Band26 5MHz 16QAM 26715 25RB#0**



**Band26 5MHz 64QAM 26715 25RB#0**

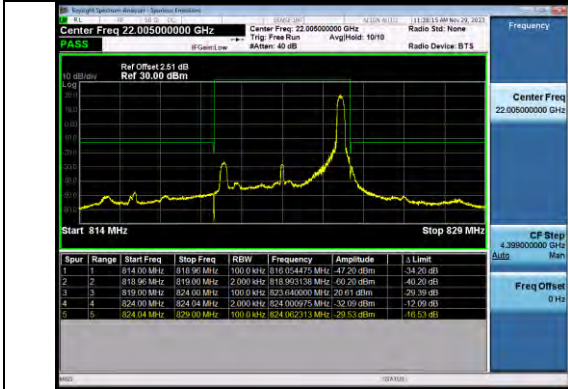

**Band26 5MHz QPSK 26765 1RB#24**

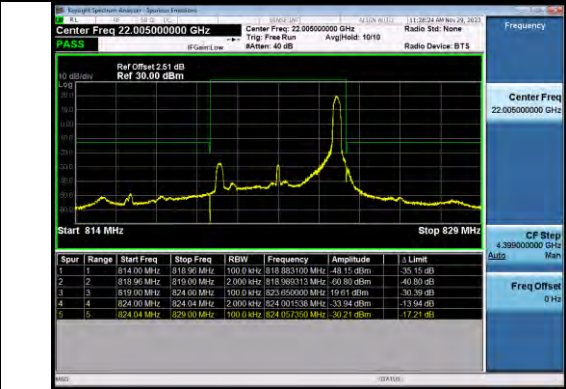

**Band26 5MHz 16QAM 26765 1RB#24**





**BUREAU  
VERITAS**

**Test Report No.: W7L-P23100008RF08**

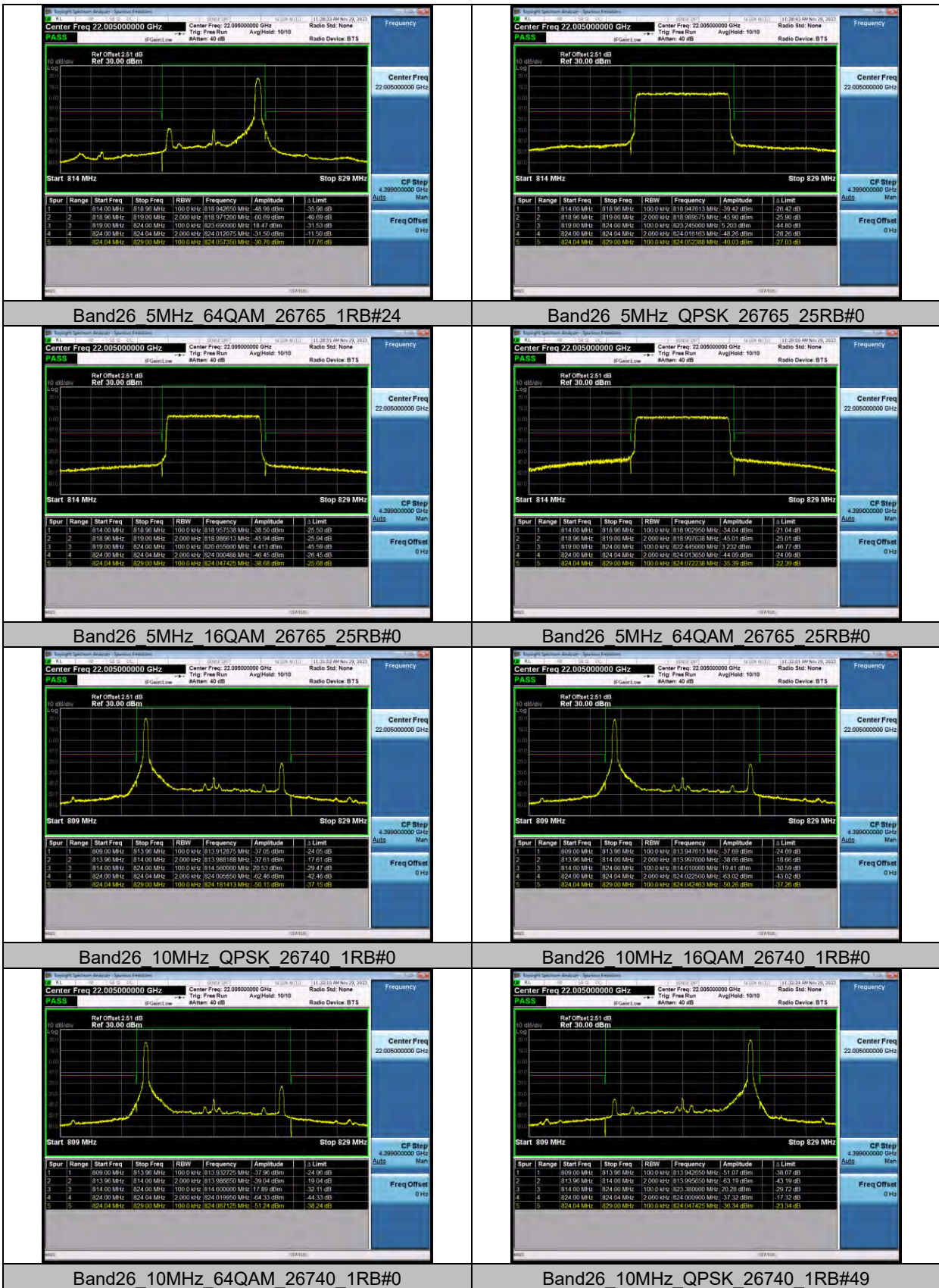



BUREAU VERITAS

Test Report No.: W7L-P23100008RF08

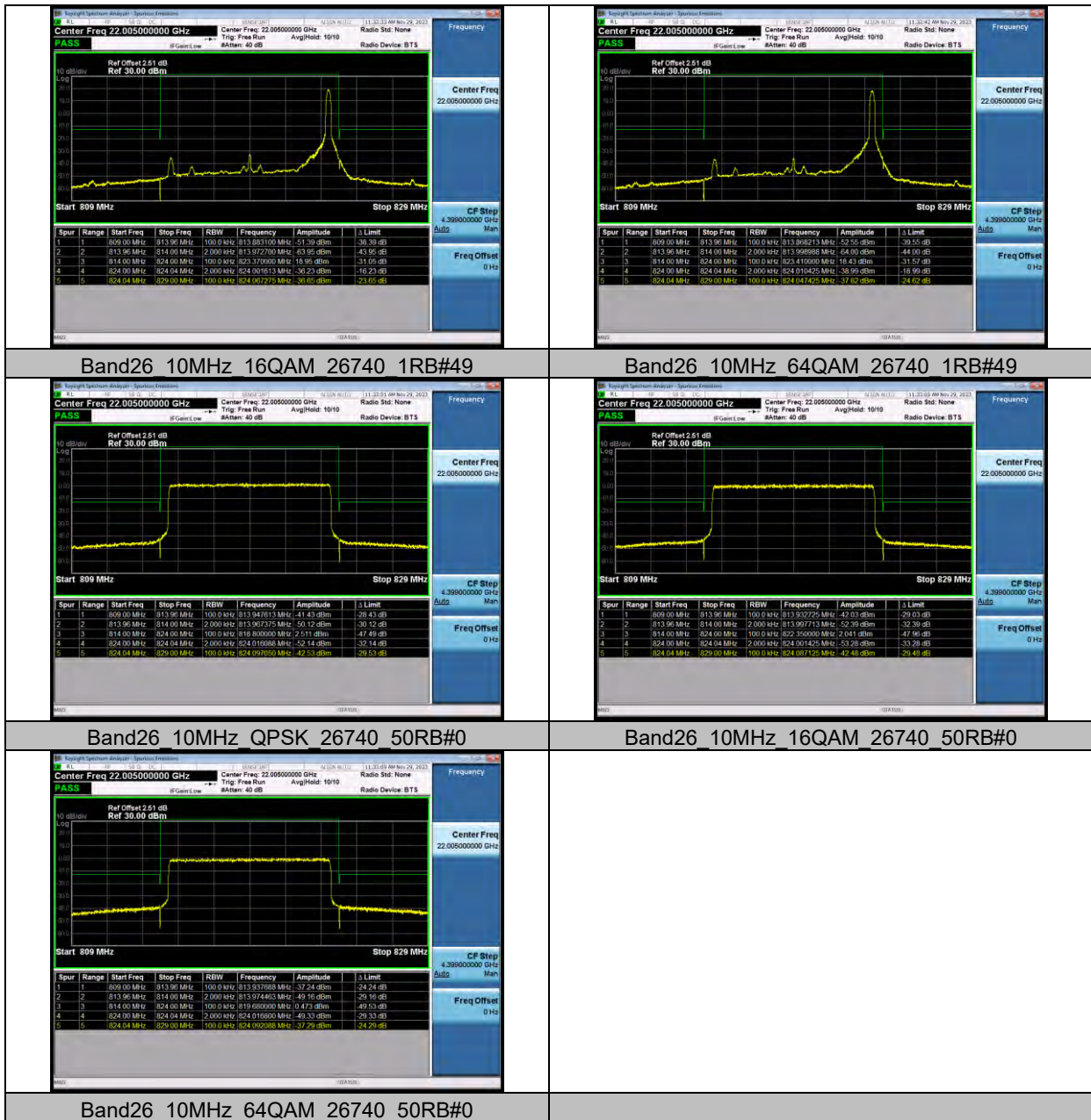



Test Report No.: W7L-P23100008RF08

## CONDUCTED SPURIOUS EMISSION

### TEST RESULT

Band	Bandwidth	Modulation	Channel	RB Configuration	Frequency Range	Result (dBm)	Verdict
26(814-824)	1.4MHz	QPSK	26697	1RB#0	30~1000	-50.30	PASS
26(814-824)	1.4MHz	QPSK	26697	1RB#0	1000~10000	-28.60	PASS
26(814-824)	1.4MHz	QPSK	26740	1RB#0	30~1000	-50.03	PASS
26(814-824)	1.4MHz	QPSK	26740	1RB#0	1000~10000	-29.31	PASS
26(814-824)	1.4MHz	QPSK	26783	1RB#0	30~1000	-50.01	PASS
26(814-824)	1.4MHz	QPSK	26783	1RB#0	1000~10000	-28.87	PASS
26(814-824)	3MHz	QPSK	26705	1RB#0	30~1000	-56.95	PASS
26(814-824)	3MHz	QPSK	26705	1RB#0	1000~10000	-28.72	PASS
26(814-824)	3MHz	QPSK	26740	1RB#0	30~1000	-56.39	PASS
26(814-824)	3MHz	QPSK	26740	1RB#0	1000~10000	-29.13	PASS
26(814-824)	3MHz	QPSK	26775	1RB#0	30~1000	-56.36	PASS
26(814-824)	3MHz	QPSK	26775	1RB#0	1000~10000	-28.60	PASS
26(814-824)	5MHz	QPSK	26715	1RB#0	30~1000	-58.76	PASS
26(814-824)	5MHz	QPSK	26715	1RB#0	1000~10000	-29.10	PASS
26(814-824)	5MHz	QPSK	26740	1RB#0	30~1000	-58.79	PASS
26(814-824)	5MHz	QPSK	26740	1RB#0	1000~10000	-28.82	PASS
26(814-824)	5MHz	QPSK	26765	1RB#0	30~1000	-58.89	PASS
26(814-824)	5MHz	QPSK	26765	1RB#0	1000~10000	-29.32	PASS
26(814-824)	10MHz	QPSK	26740	1RB#0	30~1000	-58.43	PASS
26(814-824)	10MHz	QPSK	26740	1RB#0	1000~10000	-28.96	PASS





BUREAU VERITAS

Test Report No.: W7L-P23100008RF08

### TEST GRAPHS

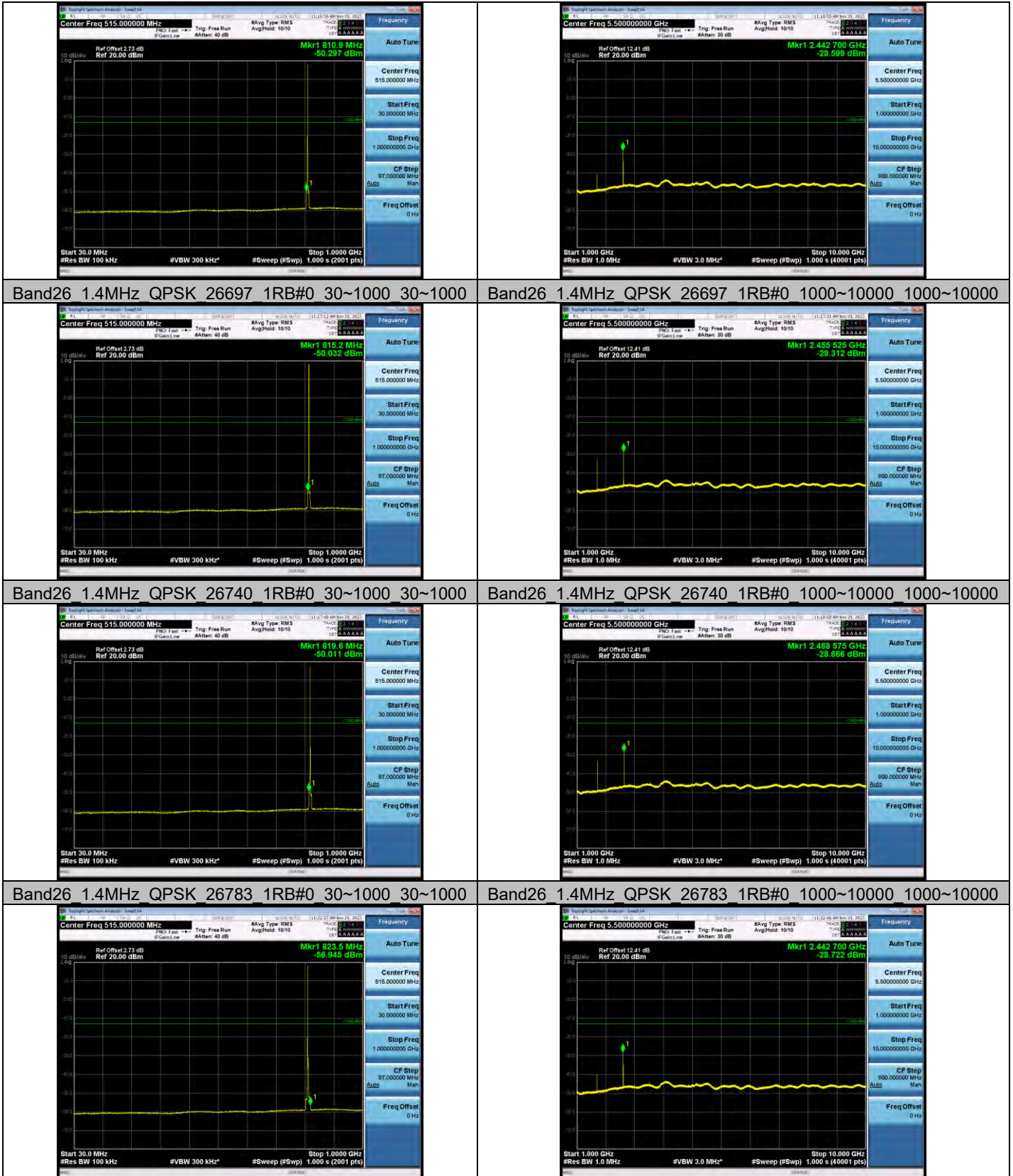



Test Report No.: W7L-P23100008RF08

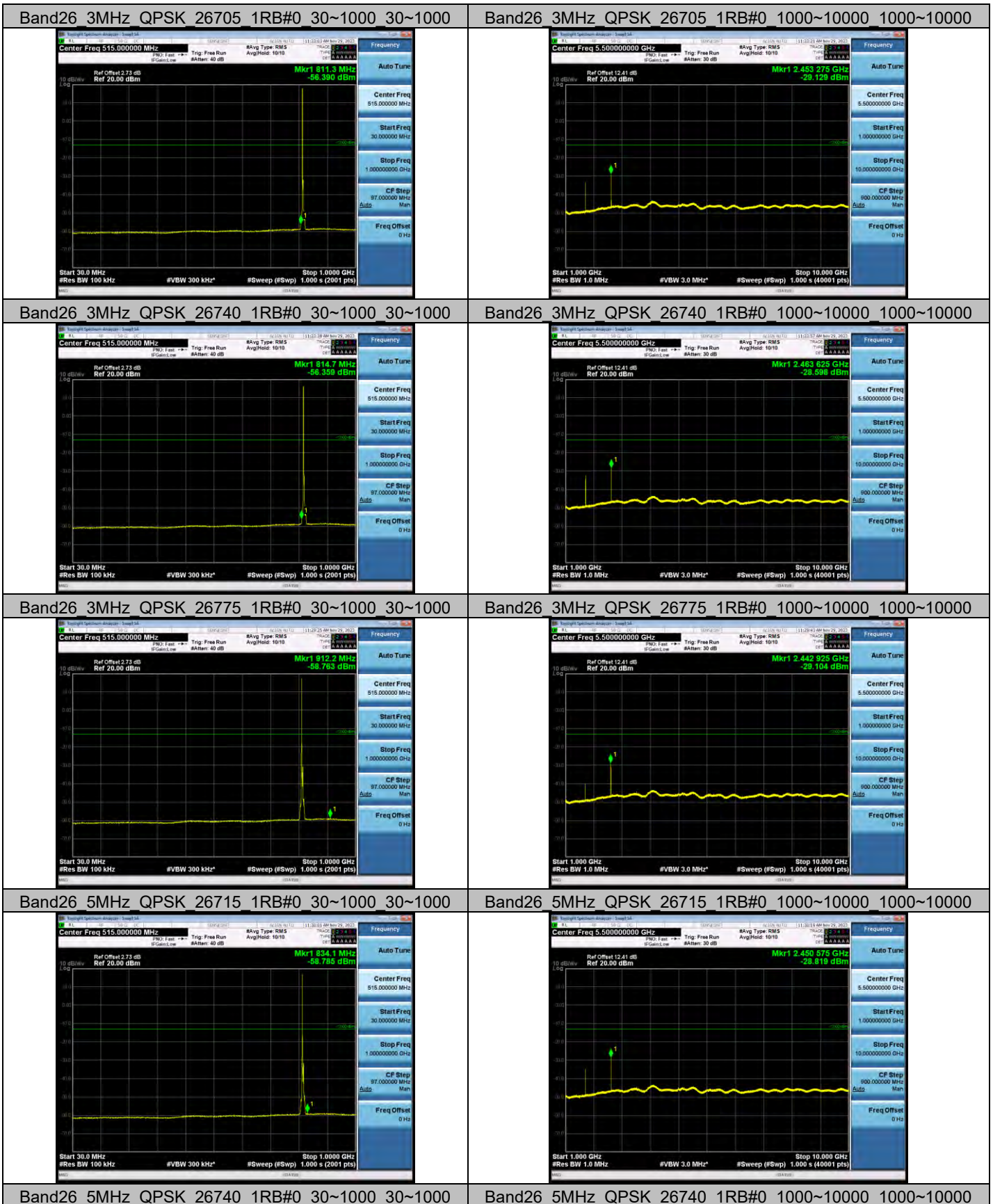





BUREAU VERITAS

Test Report No.: W7L-P23100008RF08



Band26 5MHz QPSK 26765 1RB#0 30~1000 30~1000

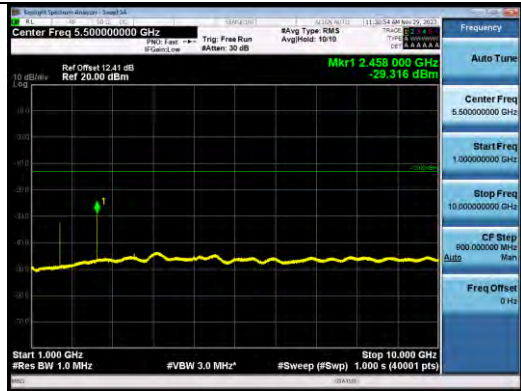

Band26 5MHz QPSK 26765 1RB#0 1000~10000 1000~10000



Band26 10MHz QPSK 26740 1RB#0 30~1000 30~1000

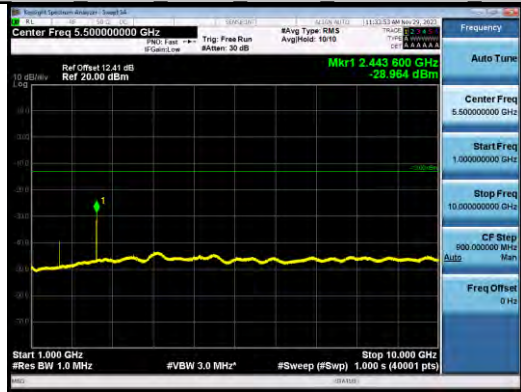

Band26 10MHz QPSK 26740 1RB#0 1000~10000 1000~10000



Test Report No.: W7L-P23100008RF08

## FREQUENCY STABILITY

### TEST RESULT

Voltage										
Band	Bandwidth	Modulation	Channel	RB Configure	Voltage [Vdc]	Temperature (°C)	Deviation (Hz)	Deviation (ppm)	Limit (ppm)	Verdict
26(814-824)	10MHz	QPSK	26740	50RB#0	VN	NT	-11.79	-0.014396	±2.5	PASS
26(814-824)	10MHz	QPSK	26740	50RB#0	VL	NT	-7.24	-0.008840	±2.5	PASS
26(814-824)	10MHz	QPSK	26740	50RB#0	VH	NT	-11.44	-0.013968	±2.5	PASS
26(814-824)	10MHz	16QAM	26740	50RB#0	VN	NT	-11.83	-0.014444	±2.5	PASS
26(814-824)	10MHz	16QAM	26740	50RB#0	VL	NT	-5.95	-0.007265	±2.5	PASS
26(814-824)	10MHz	16QAM	26740	50RB#0	VH	NT	-9.97	-0.012173	±2.5	PASS
26(814-824)	10MHz	64QAM	26740	50RB#0	VN	NT	-7.68	-0.009377	±2.5	PASS
26(814-824)	10MHz	64QAM	26740	50RB#0	VL	NT	4.19	0.005116	±2.5	PASS
26(814-824)	10MHz	64QAM	26740	50RB#0	VH	NT	-9.13	-0.011148	±2.5	PASS

Temperature										
Band	Bandwidth	Modulation	Channel	RB Configure	Voltage [Vdc]	Temperature (°C)	Deviation (Hz)	Deviation (ppm)	Limit (ppm)	Verdict
26(814-824)	10MHz	QPSK	26740	50RB#0	NV	-30	-15.62	-0.019072	±2.5	PASS
26(814-824)	10MHz	QPSK	26740	50RB#0	NV	-20	-7.93	-0.009683	±2.5	PASS
26(814-824)	10MHz	QPSK	26740	50RB#0	NV	-10	-14.09	-0.017204	±2.5	PASS
26(814-824)	10MHz	QPSK	26740	50RB#0	NV	0	-14.66	-0.017900	±2.5	PASS
26(814-824)	10MHz	QPSK	26740	50RB#0	NV	10	-10.54	-0.012869	±2.5	PASS
26(814-824)	10MHz	QPSK	26740	50RB#0	NV	20	-12.16	-0.014847	±2.5	PASS
26(814-824)	10MHz	QPSK	26740	50RB#0	NV	30	-8.15	-0.009951	±2.5	PASS
26(814-824)	10MHz	QPSK	26740	50RB#0	NV	40	-13.75	-0.016789	±2.5	PASS
26(814-824)	10MHz	QPSK	26740	50RB#0	NV	50	-10.09	-0.012320	±2.5	PASS
26(814-824)	10MHz	16QAM	26740	50RB#0	NV	-30	-4.81	-0.005873	±2.5	PASS



BUREAU  
VERITAS

Test Report No.: W7L-P23100008RF08

824)										
26(814-824)	10MHz	16QAM	26740	50RB#0	NV	-20	5.32	0.006496	±2.5	PASS
26(814-824)	10MHz	16QAM	26740	50RB#0	NV	-10	-14.92	-0.018217	±2.5	PASS
26(814-824)	10MHz	16QAM	26740	50RB#0	NV	0	-11.37	-0.013883	±2.5	PASS
26(814-824)	10MHz	16QAM	26740	50RB#0	NV	10	-14.61	-0.017839	±2.5	PASS
26(814-824)	10MHz	16QAM	26740	50RB#0	NV	20	4.06	0.004957	±2.5	PASS
26(814-824)	10MHz	16QAM	26740	50RB#0	NV	30	-2.23	-0.002723	±2.5	PASS
26(814-824)	10MHz	16QAM	26740	50RB#0	NV	40	-5.26	-0.006422	±2.5	PASS
26(814-824)	10MHz	16QAM	26740	50RB#0	NV	50	-11.17	-0.013639	±2.5	PASS
26(814-824)	10MHz	64QAM	26740	50RB#0	NV	-30	-10.83	-0.013223	±2.5	PASS
26(814-824)	10MHz	64QAM	26740	50RB#0	NV	-20	-9.68	-0.011819	±2.5	PASS
26(814-824)	10MHz	64QAM	26740	50RB#0	NV	-10	-13.63	-0.016642	±2.5	PASS
26(814-824)	10MHz	64QAM	26740	50RB#0	NV	0	-13.12	-0.016020	±2.5	PASS
26(814-824)	10MHz	64QAM	26740	50RB#0	NV	10	-15.78	-0.019267	±2.5	PASS
26(814-824)	10MHz	64QAM	26740	50RB#0	NV	20	-5.54	-0.006764	±2.5	PASS
26(814-824)	10MHz	64QAM	26740	50RB#0	NV	30	-12.66	-0.015458	±2.5	PASS
26(814-824)	10MHz	64QAM	26740	50RB#0	NV	40	-9.08	-0.011087	±2.5	PASS
26(814-824)	10MHz	64QAM	26740	50RB#0	NV	50	-10.64	-0.012991	±2.5	PASS

--END--