



# EMC TEST REPORT

**Applicant**      Xiaomi Communications Co., Ltd.  
**FCC ID**            2AFZZN91Y  
**Product**          Mobile Phone  
**Brand**             Redmi  
**Model**             22126RN91Y  
**Report No.**       R2209A0810-E1  
**Issue Date**      November 19, 2022

TA Technology (Shanghai) Co., Ltd. tested the above equipment in accordance with the requirements in **FCC Code CFR47 Part15B (2021)/ ANSI C63.4-2014**. The test results show that the equipment tested is capable of demonstrating compliance with the requirements as documented in this report.

*Liu Wei*

*Prepared by: Liu Wei*

*Fan Guangchang*

*Approved by: Fan Guangchang*

**TA Technology (Shanghai) Co., Ltd.**

*Building 3, No.145, Jintang Rd, Pudong Shanghai, P.R.China*

*TEL: +86-021-50791141/2/3*

*FAX: +86-021-50791141/2/3-8000*



## Table of Contents

1	Test Laboratory.....	4
1.1	Notes of the Test Report.....	4
1.2	Test facility.....	4
1.3	Testing Location.....	4
2	General Description of Equipment under Test.....	5
2.1	Applicant and Manufacturer Information.....	5
2.2	General information.....	5
2.3	Applied Standards.....	7
2.4	Test Mode.....	8
3	Test Case Results.....	9
3.1	Radiated Emission.....	9
3.2	Conducted Emission.....	16
4	Uncertainty Measurement.....	19
5	Main Test Instruments.....	20
	ANNEX A: The EUT Appearance.....	21
	ANNEX B: Test Setup Photos.....	22
	ANNEX C: Product Change Description.....	23

## Summary of measurement results

Number	Test Case	Clause in FCC Rules	Conclusion
1	Radiated Emission	FCC Part15.109, ANSI C63.4-2014	PASS
2	Conducted Emission	FCC Part15.107, ANSI C63.4-2014	PASS
Date of Testing: October 10, 2022 ~ October 21, 2022 Date of Sample Received: October 8, 2022			
Note: All indications of Pass/Fail in this report are opinions expressed by TA Technology (Shanghai) Co., Ltd. based on interpretations and/or observations of test results. Measurement Uncertainties were not taken into account and are published for informational purposes only.			

22126RN91Y (Report No.: R2209A0810-E1) is a variant model of 2212ARNC4L (Report No.: R2209A0813-E1). Test values all duplicated from Original for variant. There is only verified Radiated Emission (Worst case), and did not worsen, so they were not recorded in the report. The detailed product change description please refers to the *Difference Declaration Letter*.

# 1 Test Laboratory

## 1.1 Notes of the Test Report

This report shall not be reproduced in full or partial, without the written approval of **TA Technology (Shanghai) Co., Ltd.** The results documented in this report apply only to the tested sample, under the conditions and modes of operation as described herein. Measurement Uncertainties were not taken into account and are published for informational purposes only. This report is written to support regulatory compliance of the applicable standards stated above.

## 1.2 Test facility

### **FCC (Designation number: CN1179, Test Firm Registration Number: 446626)**

TA Technology (Shanghai) Co., Ltd. has been listed on the US Federal Communications Commission list of test facilities recognized to perform measurements.

### **A2LA (Certificate Number: 3857.01)**

TA Technology (Shanghai) Co., Ltd. has been listed by American Association for Laboratory Accreditation to perform measurement.

## 1.3 Testing Location

Company: TA Technology (Shanghai) Co., Ltd.  
Address: Building 3, No.145, Jintang Rd, Pudong Shanghai, P.R.China  
City: Shanghai  
Post code: 201201  
Country: P. R. China  
Contact: Fan Guangchang  
Telephone: +86-021-50791141/2/3  
Fax: +86-021-50791141/2/3-8000  
Website: <http://www.ta-shanghai.com>  
E-mail: [fanguangchang@ta-shanghai.com](mailto:fanguangchang@ta-shanghai.com)

## 2 General Description of Equipment under Test

### 2.1 Applicant and Manufacturer Information

<b>Applicant</b>	Xiaomi Communications Co., Ltd.
<b>Applicant address</b>	#019, 9th Floor, Building 6, 33 Xi'erqi Middle Road, Haidian District, Beijing, China, 100085
<b>Manufacturer</b>	Xiaomi Communications Co., Ltd.
<b>Manufacturer address</b>	#019, 9th Floor, Building 6, 33 Xi'erqi Middle Road, Haidian District, Beijing, China, 100085

### 2.2 General information

EUT Description			
Device Type	Portable Device		
Model	22126RN91Y		
IMEI	Original (2212ARNC4L)	IMEI 1: 861591060035587 IMEI 2: 861591060035595	
	Variant (22126RN91Y)	IMEI 1: 867932060030141 IMEI 2: 867932060030158	
HW Version	P1.1		
SW Version	MIUI 13		
Connecting I/O Port(s)	Please refer to the User's Manual.		
Antenna Type	PIFA Antenna		
Frequency	Band	Tx (MHz)	Rx (MHz)
	GSM 850	824 ~ 849	869 ~ 894
	GSM 1900	1850 ~ 1910	1930 ~ 1990
	WCDMA Band V	824 ~ 849	869 ~ 894
	LTE Band 5	824 ~ 849	869 ~ 894
	LTE Band 7	2500 ~ 2570	2620 ~ 2690
	LTE Band 38	2570 ~ 2620	2570 ~ 2620
	LTE Band 41	2496 ~ 2690	2496 ~ 2690
	Bluetooth	2400 ~ 2483.5	2400 ~ 2483.5
	Wi-Fi 2.4G	2400 ~ 2483.5	2400 ~ 2483.5
	Wi-Fi 5G(U-NII-1)	5150 ~ 5250	5150 ~ 5250
	Wi-Fi 5G(U-NII-2A)	5250 ~ 5350	5250 ~ 5350
	Wi-Fi 5G(U-NII-2C)	5470 ~ 5725	5470 ~ 5725
	Wi-Fi 5G(U-NII-3)	5725 ~ 5850	5725 ~ 5850
NFC	13.56	13.56	



Auxiliary test equipment	
PC	PC Manufacturer: Microsoft Corporation Model: 1724 SN: 032324771953
Note: 1. The EUT is sent from the applicant to TA and the information of the EUT is declared by the applicant.	



## 2.3 Applied Standards

According to the specifications of the manufacturer, it must comply with the requirements of the following standards:

### Test standards

**FCC Code CFR47 Part15B (2021)**

**ANSI C63.4-2014**

## 2.4 Test Mode

Test Mode	
Mode 1	Adapter +USB cable+ Front camera On
Mode 2	Adapter +USB cable+ Rear camera On
Mode 3	Adapter + USB cable +PLAY COLORBAR (1KHz)
Mode 4	Adapter + USB cable + NFC
Mode 5	Adapter + USB cable + FM(98MHz)+Earphone
Mode 6	Adapter + USB cable + Bluetooth WLAN Traffic
Mode 7	USB Copy(PC with EUT) + USB cable
Mode 8	USB Copy(EUT with PC) + USB cable
Mode 9	USB Copy(SD card with PC) + USB cable
Mode 10	USB Copy(SD card with PC) + USB cable
Mode 11	Front Camera On
Mode 12	Rear camera On
Mode 13	Earphone + FM(98MHz)

During the test, the preliminary test was performed in all modes, mode 7 is selected as the worst condition. The test data of the worst-case condition was recorded in this report.



### 3 Test Case Results

#### 3.1 Radiated Emission

##### Ambient condition

Temperature	Relative humidity	Pressure
15°C~35°C	30%~60%	101.5kPa

##### Methods of Measurement

The EUT is placed on a non-metallic table 0.8m above the horizontal metal reference ground plane. The distance between EUT and receive antenna should be 3 meters. During the test, the EUT was operating in its typical mode. The test method is according to ANSI C63.4-2014. Sweep the whole frequency band through the range from 30MHz to the 5th harmonic of the carrier. During the test, the height of receive antenna shall be moved from 1 to 4 meters, and the antenna shall be performed under horizontal and vertical polarization. The turn table shall be rotated from 0 to 360 degrees for detecting the maximum of radiated signal level.

The data of cable loss and antenna factor has been calibrated in full testing frequency range before the testing. During the test, the EUT is worked at maximum output power.

Set the spectrum analyzer in the following:

Below 1GHz:

RBW=100 kHz / VBW=300 kHz / Sweep=AUTO

Above 1GHz:

(a) PEAK Detector: RBW=1MHz / VBW=3MHz / Sweep=AUTO

(b) AVERAGE Detector: RBW=1MHz / VBW=3MHz / Sweep=AUTO

The radiated emission was measured in the following position: EUT stand-up position (Z axis), lie-down position (X, Y axis). The worst emission was found in lie-down position (X axis) and the worst case was recorded.

During the test, EUT is connected to a laptop via a USB cable in the case of Transfer Data mode. The EUT is used as the peripheral equipment of the PC. The data is transferred from EUT to PC;

## Test Setup

### Below 1GHz

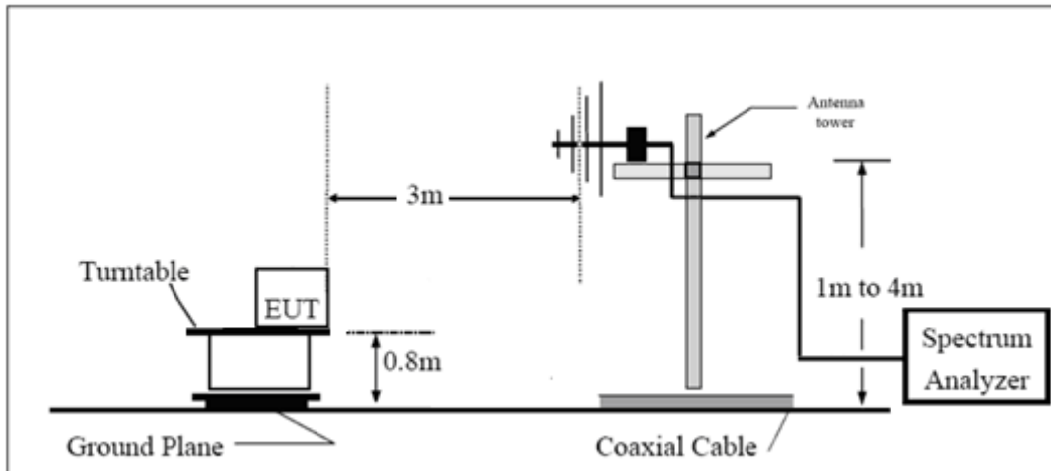

### Above 1GHz

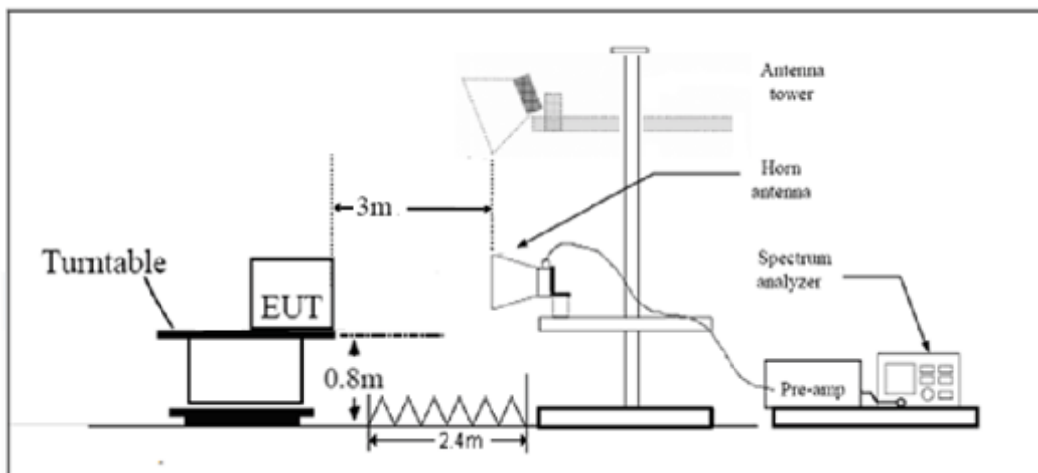

Note: Area side: 2.4mX3.6m

Antenna Tower meets ANSI C63.4 requirements for measurements above 1 GHz by keeping the antenna aimed at the EUT during the antenna's ascent/ descent along the antenna mast.

**Limits****Class B**

<b>Frequency (MHz)</b>	<b>Field Strength (dB<math>\mu</math>V/m)</b>	<b>Detector</b>
30 -88	40.0	Quasi-peak
88-216	43.5	Quasi-peak
216 – 960	46.0	Quasi-peak
960-1000	54.0	Quasi-peak
1000-5 <sup>th</sup> harmonic of the highest frequency or 40GHz, which is lower	54 74	Average Peak

**Test Results**

Sweep the whole frequency band through the range from 30MHz to the 5th harmonic of the carrier. The Emissions in the frequency band 18GHz – 40GHz is more than 20dB below the limit are not reported.

The following graphs display the maximum values of horizontal and vertical by software. For above 1GHz, Blue trace uses the peak detection, Green trace uses the average detection.

**Original:**

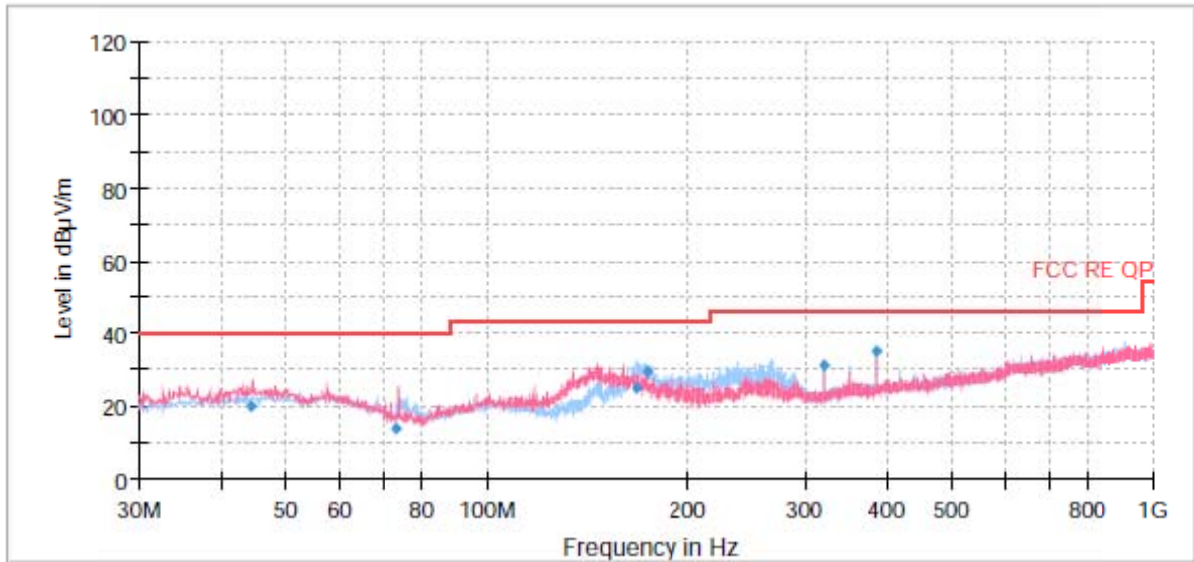

Radiated Emission from 30MHz to 1GHz

Frequency (MHz)	Quasi-Peak (dBµV/m)	Limit (dBµV/m)	Margin (dB)	Height (cm)	Polarization	Azimuth (deg)	Correct Factor (dB)
44.11	20.31	40.00	19.69	125.0	V	16.00	15
73.25	14.04	40.00	25.96	118.0	V	22.00	10
168.06	25.30	43.50	18.20	105.0	H	258.00	11
173.93	29.42	43.50	14.08	206.0	H	266.00	11
320.19	31.22	46.00	14.78	125.0	V	350.00	16
384.01	34.99	46.00	11.01	100.0	H	354.00	18

**Remark: 1. Correction Factor = Antenna factor + Insertion loss(cable loss+amplifier gain)**

**2. Margin = Limit – Quasi-Peak**

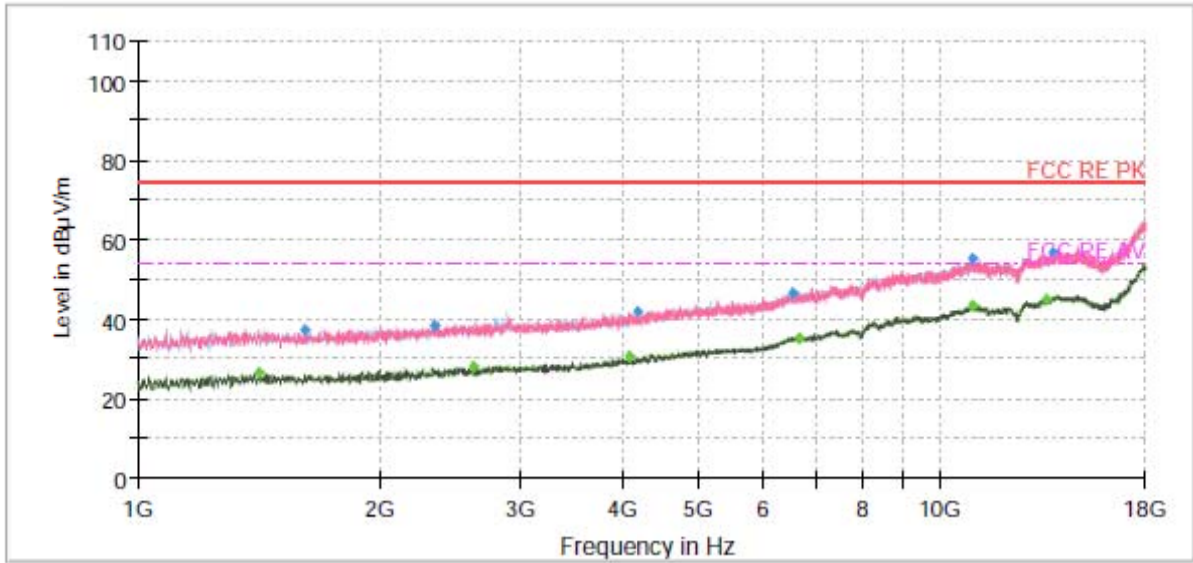

Radiated Emission from 1GHz to 18GHz

Frequency (MHz)	MaxPeak (dBµV/m)	Average (dBµV/m)	Limit (dBµV/m)	Margin (dB)	Meas. Time (ms)	Height (cm)	Pol	Azimuth (deg)	Corr. (dB/m)
1417.16	---	26.58	54.00	27.42	500.00	200.0	V	0.00	-17
1614.30	37.23	---	74.00	36.77	500.00	100.0	V	309.00	-16
2339.52	38.31	---	74.00	35.69	500.00	200.0	H	338.00	-14
2615.17	---	27.92	54.00	26.08	500.00	200.0	H	284.00	-14
4095.91	---	30.49	54.00	23.51	500.00	100.0	V	235.00	-10
4194.36	41.83	---	74.00	32.17	500.00	100.0	V	0.00	-10
6568.07	46.53	---	74.00	27.47	500.00	100.0	H	239.00	-2
6663.95	---	35.31	54.00	18.69	500.00	200.0	V	94.00	-2
10927.74	---	43.61	54.00	10.39	500.00	200.0	V	112.00	4
10966.19	55.41	---	74.00	18.59	500.00	200.0	H	247.00	4
13547.58	---	45.26	54.00	8.74	500.00	100.0	H	165.00	7
13748.68	57.00	---	74.00	17.00	500.00	100.0	V	244.00	7

Remark: 1. Correction Factor = Antenna factor + Insertion loss (cable loss + amplifier gain)

2. Peak Margin = Limit - MAX Peak/ Average

Variant:

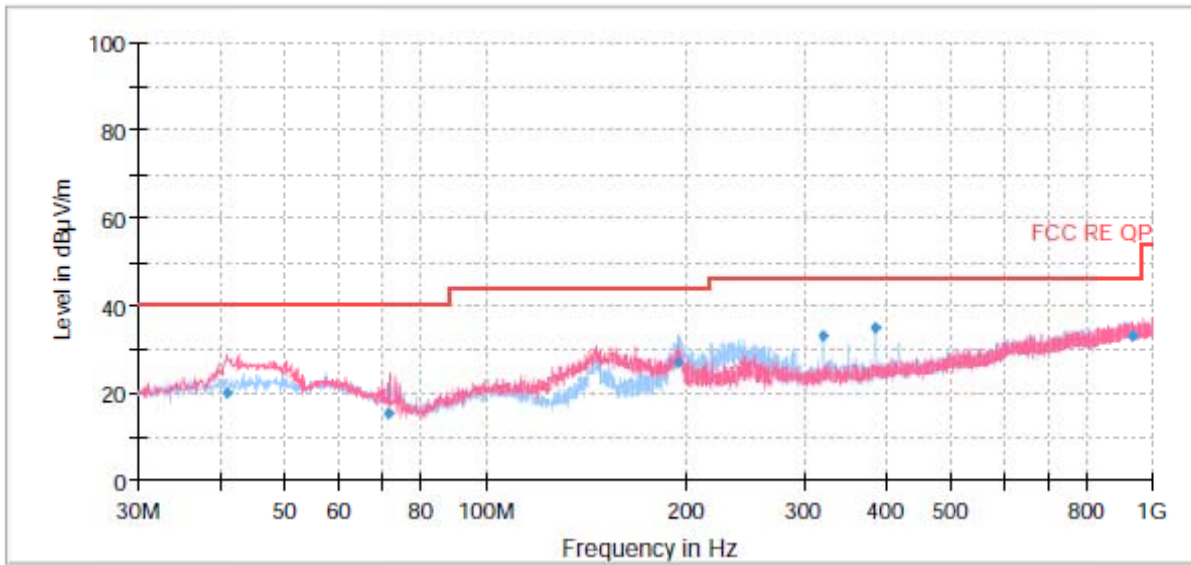

Radiated Emission from 30MHz to 1GHz

Frequency (MHz)	Quasi-Peak (dBµV/m)	Limit (dBµV/m)	Margin (dB)	Height (cm)	Polarization	Azimuth (deg)	Correct Factor (dB)
40.75	19.89	40.00	20.11	179.0	V	22.00	15
71.43	15.33	40.00	24.67	118.0	V	93.00	11
195.02	26.98	43.50	16.52	125.0	H	260.00	14
319.99	32.88	46.00	13.12	100.0	H	334.00	16
384.01	34.71	46.00	11.29	100.0	H	1.00	18
935.50	32.83	46.00	13.17	105.0	V	264.00	27

Remark: 1. Correction Factor = Antenna factor + Insertion loss(cable loss+amplifier gain)

2. Margin = Limit – Quasi-Peak

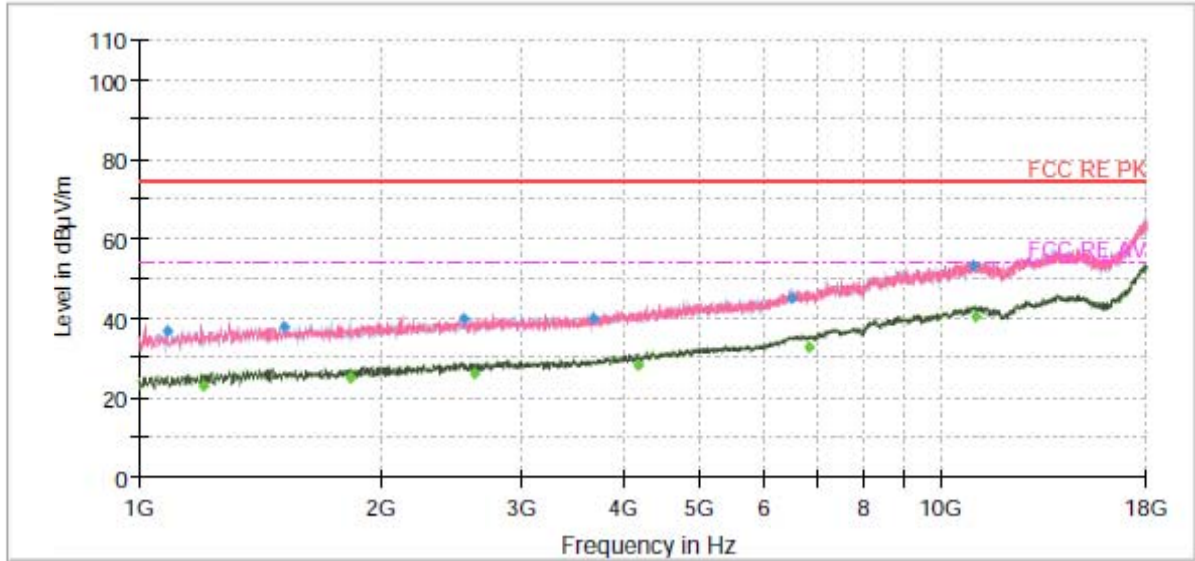

Radiated Emission from 1GHz to 18GHz

Frequency (MHz)	MaxPeak (dBµV/m)	Average (dBµV/m)	Limit (dBµV/m)	Margin (dB)	Meas. Time (ms)	Height (cm)	Pol	Azimuth (deg)	Corr. (dB/m)
1081.21	36.76	---	74.00	37.24	1000.00	210.0	H	317.00	-19
1201.39	---	23.17	54.00	30.83	1000.00	198.0	H	79.00	-18
1515.86	37.71	---	74.00	36.29	1000.00	110.0	H	347.00	-16
1830.95	---	24.83	54.00	29.17	1000.00	206.0	V	256.00	-16
2530.67	39.66	---	74.00	34.34	1000.00	110.0	V	135.00	-14
2613.68	---	26.29	54.00	27.71	1000.00	100.0	V	42.00	-14
3671.36	40.08	---	74.00	33.92	1000.00	110.0	H	304.00	-12
4189.53	---	28.25	54.00	25.75	1000.00	197.0	V	2.00	-10
6492.65	44.84	---	74.00	29.16	1000.00	100.0	H	336.00	-2
6824.14	---	32.67	54.00	21.33	1000.00	210.0	H	85.00	-1
10940.71	53.09	---	74.00	20.91	1000.00	206.0	V	310.00	4
10996.38	---	40.44	54.00	13.56	1000.00	100.0	H	52.00	4

Remark: 1. Correction Factor = Antenna factor + Insertion loss (cable loss + amplifier gain)

2. Peak Margin = Limit - MAX Peak/ Average

### 3.2 Conducted Emission

#### Ambient condition

Temperature	Relative humidity	Pressure
15°C~35°C	30%~60%	101.5kPa

#### Methods of Measurement

The EUT is placed on a non-metallic table of 80cm height above the horizontal metal reference ground plane. During the test, the EUT was operating in its typical mode. The test method is according to ANSI C63.4-2014. Connect the AC power line of the EUT to the L.I.S.N. Use EMI receiver to detect the average and Quasi-peak value. RBW is set to 9 kHz, VBW is set to 30kHz. The measurement result should include both L line and N line.

During the test, EUT is connected to a laptop via a USB cable in the case of Transfer Data mode. The EUT is used as the peripheral equipment of the PC. The data is transferred from EUT to PC;

#### Test Setup

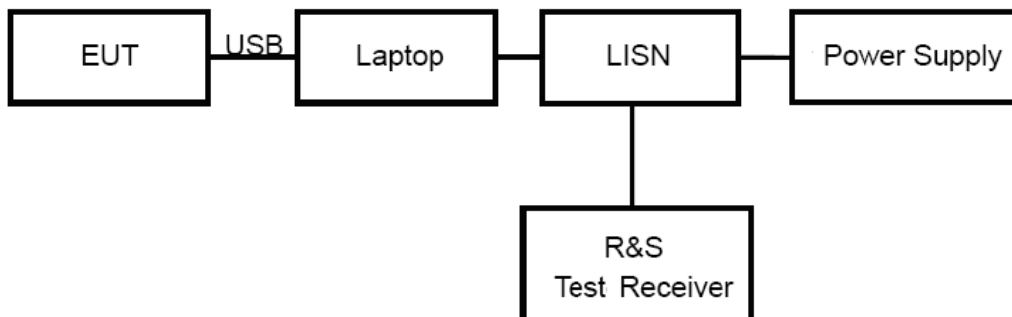

Note: Power Supply is AC Power source and it is used to change the voltage 120V/60Hz.

#### Limits

Frequency (MHz)	Conducted Limits(dBμV)	
	Quasi-peak	Average
0.15 - 0.5	66 to 56 *	56 to 46 *
0.5 - 5	56	46
5 - 30	60	50

\*: Decreases with the logarithm of the frequency.



**Test Results**

Following plots, Blue trace uses the peak detection; Green trace uses the average detection.

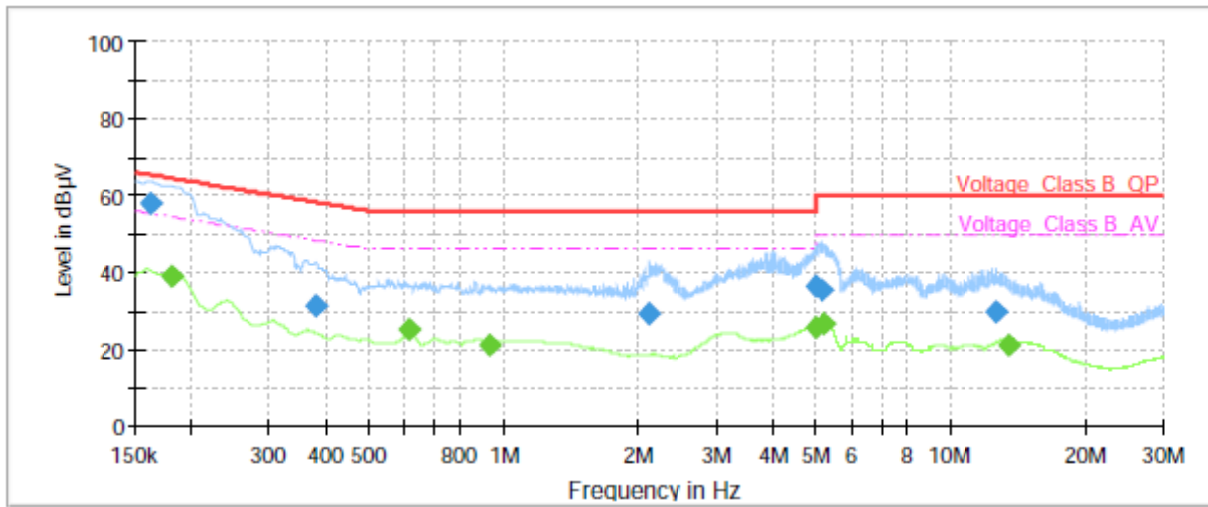

Frequency (MHz)	QuasiPeak (dBµV)	Average (dBµV)	Limit (dBµV)	Margin (dB)	Meas. Time (ms)	Bandwidth (kHz)	Line	Filter	Corr. (dB)
0.161250	58.07	---	65.40	7.33	1000.0	9.000	N	ON	20.8
0.181500	---	38.73	54.42	15.69	1000.0	9.000	N	ON	20.7
0.379500	31.10	---	58.29	27.19	1000.0	9.000	N	ON	20.5
0.615750	---	25.35	46.00	20.65	1000.0	9.000	N	ON	20.2
0.926250	---	21.27	46.00	24.73	1000.0	9.000	N	ON	20.0
2.109750	29.28	---	56.00	26.72	1000.0	9.000	N	ON	19.5
4.989750	36.54	---	56.00	19.46	1000.0	9.000	N	ON	19.5
4.996500	---	25.43	46.00	20.57	1000.0	9.000	N	ON	19.5
5.174250	35.41	---	60.00	24.59	1000.0	9.000	N	ON	19.5
5.205750	---	26.60	50.00	23.40	1000.0	9.000	N	ON	19.5
12.621750	29.66	---	60.00	30.34	1000.0	9.000	N	ON	19.7
13.456500	---	20.88	50.00	29.12	1000.0	9.000	N	ON	19.7

**Remark: Correct factor=cable loss + LISN factor**

L line

Conducted Emission from 150 KHz to 30 MHz

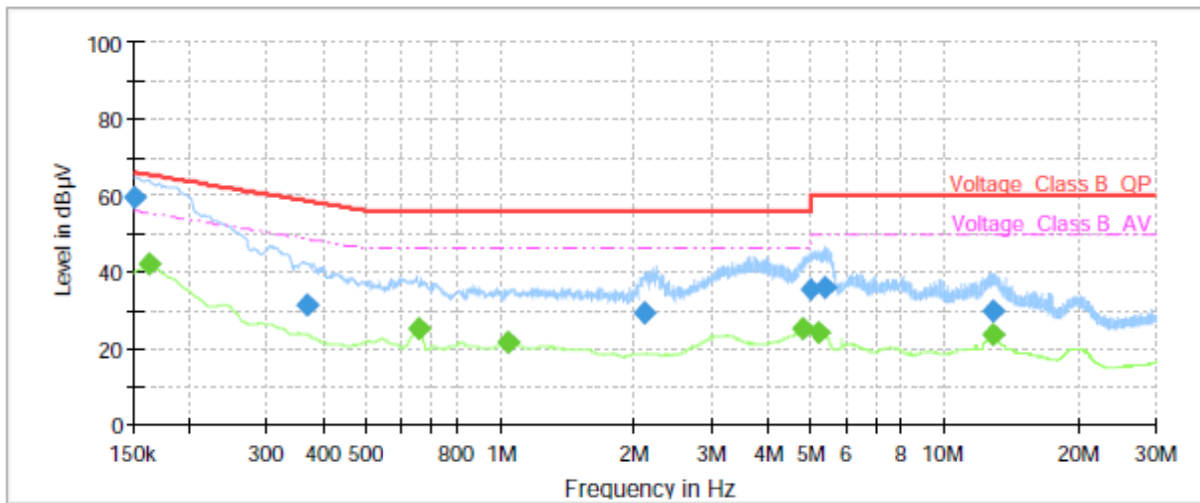

Frequency (MHz)	QuasiPeak (dBµV)	Average (dBµV)	Limit (dBµV)	Margin (dB)	Meas. Time (ms)	Bandwidth (kHz)	Line	Filter	Corr. (dB)
0.150000	59.43	---	66.00	6.57	1000.0	9.000	L1	ON	20.8
0.161250	---	42.18	55.40	13.22	1000.0	9.000	L1	ON	20.8
0.368250	31.28	---	58.54	27.26	1000.0	9.000	L1	ON	20.5
0.654000	---	25.14	46.00	20.86	1000.0	9.000	L1	ON	20.2
1.038750	---	21.30	46.00	24.70	1000.0	9.000	L1	ON	19.9
2.121000	29.14	---	56.00	26.86	1000.0	9.000	L1	ON	19.5
4.785000	---	24.98	46.00	21.02	1000.0	9.000	L1	ON	19.5
4.987500	35.36	---	56.00	20.64	1000.0	9.000	L1	ON	19.5
5.241750	---	24.15	50.00	25.85	1000.0	9.000	L1	ON	19.5
5.421750	35.95	---	60.00	24.05	1000.0	9.000	L1	ON	19.5
12.954750	---	23.41	50.00	26.59	1000.0	9.000	L1	ON	19.7
12.997500	29.91	---	60.00	30.09	1000.0	9.000	L1	ON	19.7

Remark: Correct factor=cable loss + LISN factor

N line

Conducted Emission from 150 KHz to 30 MHz

## 4 Uncertainty Measurement

Case	Uncertainty	Factor k
Radiated Emission 30MHz – 200MHz	4.17 dB	1.96
Radiated Emission 200MHz – 1GHz	4.84 dB	1.96
Radiated Emission 1GHz – 18GHz	4.35 dB	1.96
Radiated Emission 18GHz – 26.5GHz	5.90 dB	1.96
Conducted Emission	2.57 dB	2

## 5 Main Test Instruments

Name of Equipment	Manufacturer	Type/Model	Serial Number	Calibration Date	Expiration Time
Radiated Emission					
EMI Test Receiver	R&S	ESR	102389	2022-05-25	2023-05-24
Signal Analyzer	R&S	FSV40	100816	2021-12-12	2022-12-11
TRILOG Broadband Antenna	SCHWARZBECK	VULB 9163	1023	2020-05-05	2023-05-04
Horn Antenna	R&S	HF907	102723	2020-08-11	2023-08-10
Horn Antenna	ETS-Lindgren	3160-09	00102643	2021-10-10	2024-10-09
Horn Antenna	STEATITE	QSH-SL-26-40-K-15	16779	2019-12-24	2022-12-23
Software	R&S	EMC32	9.26.01	/	/
Conducted Emission					
Artificial main network	R&S	ENV216	102191	2020-12-13	2022-12-12
EMI Test Receiver	R&S	ESR	101667	2022-05-25	2023-05-24
Software	R&S	EMC32	10.35.10	/	/

\*\*\*\*\*END OF REPORT \*\*\*\*\*



## ANNEX A: The EUT Appearance

The EUT Appearance are submitted separately.



## **ANNEX B: Test Setup Photos**

The Test Setup Photos are submitted separately.



## **ANNEX C: Product Change Description**

The Product Change Description are submitted separately.