



FCC RF Test Report

APPLICANT : Xiaomi Communications Co., Ltd.
EQUIPMENT : Mobile Phone
BRAND NAME : Xiaomi
MODEL NAME : 2306EPN60G
FCC ID : 2AFZZN60G
STANDARD : 47 CFR Part 2, 22, 27
CLASSIFICATION : PCS Licensed Transmitter Held to Ear (PCE)
TEST DATE(S) : May 16, 2023 ~ May 29, 2023

We, Sporton International Inc. (Kunshan), would like to declare that the tested sample has been evaluated in accordance with the procedures given in ANSI C63.26-2015 and shown compliance with the applicable technical standards.

This report contains data that were produced under subcontract by Sporton International Inc. (Shenzhen).

The test results in this report apply exclusively to the tested model / sample. Without written approval of Sporton International Inc. (Kunshan), the test report shall not be reproduced except in full.

Jason Jia



Approved by: Jason Jia

Sporton International Inc. (Kunshan)

**No. 1098, Pengxi North Road, Kunshan Economic Development Zone Jiangsu Province 215300
People's Republic of China**



TABLE OF CONTENTS

REVISION HISTORY... 3
SUMMARY OF TEST RESULT ... 4
1 GENERAL DESCRIPTION ... 5
1.1 Applicant ... 5
1.2 Manufacturer ... 5
1.3 Product Feature of Equipment Under Test ... 5
1.4 Product Specification of Equipment Under Test ... 5
1.5 Modification of EUT ... 6
1.6 Maximum ERP/EIRP Power and Emission Designator ... 7
1.7 Testing Location ... 8
1.8 Test Software ... 9
1.9 Applicable Standards ... 9
2 TEST CONFIGURATION OF EQUIPMENT UNDER TEST ... 10
2.1 Test Mode ... 10
2.2 Connection Diagram of Test System ... 12
2.3 Support Unit used in test configuration and system ... 12
2.4 Measurement Results Explanation Example ... 12
2.5 Frequency List of Low/Middle/High Channels ... 13
3 CONDUCTED TEST ITEMS ... 16
3.1 Measuring Instruments ... 16
3.2 Test Setup ... 16
3.3 Test Result of Conducted Test ... 16
3.4 Conducted Output Power and ERP/EIRP ... 17
3.5 Peak-to-Average Ratio ... 18
3.6 Occupied Bandwidth ... 19
3.7 Conducted Band Edge ... 20
3.8 Conducted Spurious Emission ... 22
3.9 Frequency Stability ... 23
4 RADIATED TEST ITEMS ... 24
4.1 Measuring Instruments ... 24
4.2 Test Setup ... 24
4.3 Test Result of Radiated Test ... 25
4.4 Radiated Spurious Emission ... 26
5 LIST OF MEASURING EQUIPMENT ... 27
6 MEASUREMENT UNCERTAINTY ... 28
APPENDIX A. TEST RESULTS OF CONDUCTED TEST
APPENDIX B. TEST RESULTS OF RADIATED TEST
APPENDIX C. TEST SETUP PHOTOGRAPHS



REVISION HISTORY

REPORT NO.	VERSION	DESCRIPTION	ISSUED DATE
FG350505F	Rev. 01	Initial issue of report	Jun. 12, 2023



SUMMARY OF TEST RESULT

Report Section	FCC Rule	Description	Limit	Result	Remark
3.4	§2.1046	Conducted Output Power	Reporting Only	PASS	-
	§22.913(a)(5)	Effective Radiated Power (5G NR n5)	ERP < 7 Watt		
	§27.50(h)(2)	Equivalent Isotropic Radiated Power (5G NR n7, n41, n38)	EIRP < 2Watt		
	§27.50(d)(4)	Equivalent Isotropic Radiated Power (5G NR n66)	EIRP < 1Watt		
3.6	§2.1049	Occupied Bandwidth	Reporting Only	PASS	-
3.7	§2.1051 §22.917(a) §27.53(h)	Conducted Band Edge Measurement (5G NR n5) (5G NR n66)	< 43+10log ₁₀ (P[Watts])	PASS	-
	§27.53(m)(4)	Conducted Band Edge Measurement (5G NR n7, n41, n38)	§27.53(m)(4)		
3.8	§2.1051 §22.917(a) §27.53(h)	Conducted Spurious Emission (5G NR n5) (5G NR n66)	< 43+10log ₁₀ (P[Watts])	PASS	-
	§2.1051 §27.53(m)(4)	Conducted Spurious Emission (5G NR n7, n41, n38)	< 55+10log ₁₀ (P[Watts])		
3.9	§2.1055 §22.355	Frequency Stability Temperature & Voltage	< 2.5 ppm for Part 22	PASS	-
	§27.54		Within Authorized Band		
4.4	§2.1053 §22.917(a) §27.53(h)	Radiated Spurious Emission (5G NR n5) (5G NR n66)	< 43+10log ₁₀ (P[Watts])	PASS	Under limit 29.47 dB at 12554.00 MHz
	§2.1053 §27.53(m)(4)	Radiated Spurious Emission (5G NR n7, n41, n38)	< 55+10log ₁₀ (P[Watts])		

Conformity Assessment Condition:

- The test results (PASS/FAIL) with all measurement uncertainty excluded are presented against the regulation limits or in accordance with the requirements stipulated by the applicant/manufacturer who shall bear all the risks of non-compliance that may potentially occur if measurement uncertainty is taken into account.
- The measurement uncertainty please refer to each test result in the section "Measurement Uncertainty"

Disclaimer:

The product specifications of the EUT presented in the test report that may affect the test assessments are declared by the manufacturer who shall take full responsibility for the authenticity.



1 General Description

1.1 Applicant

Xiaomi Communications Co., Ltd.

#019, 9th Floor, Building 6, 33 Xi'erqi Middle Road, Haidian District, Beijing, China, 100085

1.2 Manufacturer

Xiaomi Communications Co., Ltd.

#019, 9th Floor, Building 6, 33 Xi'erqi Middle Road, Haidian District, Beijing, China, 100085

1.3 Product Feature of Equipment Under Test

Product Feature	
Equipment	Mobile Phone
Brand Name	Xiaomi
Model Name	2306EPN60G
FCC ID	2AFZZN60G
IMEI Code	Conducted: 864825060079089 Radiation: 864825060065484/864825060065492
HW Version	P2.0
SW Version	MIUI 14
EUT Stage	Identical Prototype

1.4 Product Specification of Equipment Under Test

Standards-related Product Specification	
Tx Frequency	5G NR n5 : 824 MHz ~ 849 MHz 5G NR n7 : 2500 MHz ~ 2570 MHz 5G NR n38 : 2570 MHz ~ 2620 MHz 5G NR n41 : 2496 MHz ~ 2690 MHz 5G NR n66 : 1710 MHz ~ 1780 MHz
Rx Frequency	5G NR n5 : 869 MHz ~ 894 MHz 5G NR n7 : 2620 MHz ~ 2690 MHz 5G NR n38: 2570 MHz ~ 2620 MHz 5G NR n41 : 2496 MHz ~ 2690 MHz 5G NR n66 : 2110 MHz~ 2200 MHz
Bandwidth	n5: 5MHz / 10MHz / 15MHz / 20MHz n7: 5MHz / 10MHz / 15MHz / 20MHz / 25MHz / 30MHz / 40MHz / 50MHz n38: 10MHz / 15MHz / 20MHz / 25MHz / 30MHz / 40MHz n41 : 10MHz / 15MHz / 20MHz / 30MHz / 40MHz / 50MHz / 60MHz / 70MHz / 80MHz / 90MHz / 100MHz n66: 5MHz / 10MHz / 15MHz / 20MHz / 30MHz / 40MHz
SCS	15kHz for FDD Band 30kHz for TDD Band
Antenna Gain	<Ant. 0> n5: -5.53 dBi



	<p><Ant. 1> n5: -7.80 dBi n7: -4.50 dBi n38: -4.50 dBi n41: -4.50 dBi n66: -6.00 dBi</p> <p><Ant. 2> n7: -4.90 dBi n38: -4.90 dBi n41: -4.90 dBi n66: -3.60 dBi</p> <p><Ant. 3> n7: -6.30 dBi n38: -6.30 dBi n41: -6.30 dBi n66: -7.20 dBi</p> <p><Ant. 4> n7: -1.50 dBi n38: -1.50 dBi n41: -1.50 dBi n66: -5.00 dBi</p>
Type of Modulation	CP-OFDM: QPSK / 16QAM / 64QAM / 256QAM DFT-s-OFDM: PI/2 BPSK / QPSK / 16QAM / 64QAM / 256QAM

Remark:

1. The maximum ERP/EIRP is calculated from max output power and max antenna gain, only the maximum ERP/EIRP of Ant.0 for 5G NR n5, and Ant.4 for 5G NR n7/n38/n41/n66 are shown in the report.
2. 5G NR n5/n7/n38/n41/n66 support SA mode and NSA mode. According to the maximum power between SA and NSA mode, SA covers NSA mode for n5/n7/n38/n41, and NSA covers SA mode for n66.
3. All the supported ENDC combinations are verified conducted power, only the ENDC combination with highest power are shown in the report.
4. The EN-DC mode combination could be referred to the product spec.

1.5 Modification of EUT

No modifications are made to the EUT during all test items.



1.6 Maximum ERP/EIRP Power and Emission Designator

5G NR n5		PI/2 BPSK / QPSK		16QAM / 64QAM / 256QAM	
BW (MHz)	Frequency Range (MHz)	Maximum ERP(W)	Emission Designator (99%OBW)	Maximum ERP(W)	Emission Designator (99%OBW)
5	826.5 ~ 846.5	0.0450	4M47G7D	0.0329	4M48W7D
10	829.0 ~ 844.0	0.0433	9M29G7D	0.0334	9M29W7D
15	831.5 ~ 841.5	0.0430	14M1G7D	0.0315	14M1W7D
20	834.0 ~ 839.0	0.0469	18M9G7D	0.0374	18M9W7D

5G NR n7		PI/2 BPSK / QPSK		16QAM / 64QAM / 256QAM	
BW (MHz)	Frequency Range (MHz)	Maximum EIRP(W)	Emission Designator (99%OBW)	Maximum EIRP(W)	Emission Designator (99%OBW)
5	2502.5 ~ 2567.5	0.1959	4M46G7D	0.1406	4M47W7D
10	2505.0 ~ 2565.0	0.1959	9M28G7D	0.1466	9M29W7D
15	2507.5 ~ 2562.5	0.1977	14M1G7D	0.1500	14M1W7D
20	2510.0 ~ 2560.0	0.1968	18M9G7D	0.1455	18M9W7D
25	2512.5 ~ 2557.5	0.1734	23M7G7D	0.1291	23M7W7D
30	2515.0 ~ 2555.0	0.1968	28M6G7D	0.1521	28M6W7D
40	2520.0 ~ 2550.0	0.1932	38M6G7D	0.1479	38M6W7D
50	2525.0 ~ 2545.0	0.1982	48M1G7D	0.1321	48M1W7D

5G NR n38		PI/2 BPSK / QPSK		16QAM / 64QAM / 256QAM	
BW (MHz)	Frequency Range (MHz)	Maximum EIRP(W)	Emission Designator (99%OBW)	Maximum EIRP(W)	Emission Designator (99%OBW)
10	2575.0 ~ 2615.0	0.1858	8M60G7D	0.1596	8M59W7D
15	2577.5 ~ 2612.5	0.1968	13M6G7D	0.1626	13M6W7D
20	2580.0 ~ 2610.0	0.1928	18M2G7D	0.1644	18M3W7D
25	2582.5 ~ 2607.5	0.1746	23M1G7D	0.1352	23M2W7D
30	2585.0 ~ 2605.0	0.1936	27M8G7D	0.1570	27M9W7D
40	2590.0 ~ 2600.0	0.1991	37M8G7D	0.1596	37M9W7D

5G NR n66		PI/2 BPSK / QPSK		16QAM / 64QAM / 256QAM	
BW (MHz)	Frequency Range (MHz)	Maximum EIRP(W)	Emission Designator (99%OBW)	Maximum EIRP(W)	Emission Designator (99%OBW)
5	1712.5 ~ 1777.5	0.0776	4M47G7D	0.0630	4M47W7D
10	1715.0 ~ 1775.0	0.0774	9M29G7D	0.0631	9M30W7D
15	1717.5 ~ 1772.5	0.0769	14M1G7D	0.0631	14M1W7D
20	1720.0 ~ 1770.0	0.0774	18M9G7D	0.0564	19M0W7D
25	1722.5 ~ 1767.5	0.0634	23M7G7D	0.0514	23M7W7D
30	1725.0 ~ 1765.0	0.0708	28M6G7D	0.0581	28M6W7D
40	1730.0 ~ 1760.0	0.0782	38M6G7D	0.0577	38M6W7D



5G NR n41		PI/2 BPSK / QPSK		16QAM / 64QAM / 256QAM	
BW (MHz)	Frequency Range (MHz)	Maximum EIRP(W)	Emission Designator (99%OBW)	Maximum EIRP(W)	Emission Designator (99%OBW)
10	2501.01 ~ 2685.00	0.1862	8M60G7D	0.1648	8M59W7D
15	2503.50 ~ 2682.48	0.1914	13M6G7D	0.1603	13M6W7D
20	2506.02 ~ 2679.99	0.1875	18M2G7D	0.1611	18M3W7D
30	2511.00 ~ 2674.98	0.1901	27M8G7D	0.1574	27M9W7D
40	2516.01 ~ 2670.00	0.1936	37M8G7D	0.1596	37M9W7D
50	2521.02 ~ 2664.99	0.1950	47M5G7D	0.1570	47M4W7D
60	2526.00 ~ 2659.98	0.1879	57M8G7D	0.1567	57M9W7D
70	2531.01 ~ 2655.00	0.1884	67M3G7D	0.1563	67M6W7D
80	2536.02 ~ 2649.99	0.1897	77M5G7D	0.1545	77M6W7D
90	2541.00 ~ 2644.98	0.1892	87M5G7D	0.1574	87M6W7D
100	2546.01 ~ 2640.00	0.2089	97M6G7D	0.1718	97M6W7D

Note:

- 5G NR Band n41 overlaps the entire frequency range of Band n38. Therefore, the conducted test results provided in this report covers Band n41 as well as Band n38, and n38 additional supports BW 25MHz, the n38 BW_25M is full tested in the report.
- All modulations have been tested, only the worst test results of PSK & QAM are shown in the report.

1.7 Testing Location

Sporton International Inc. (Kunshan) is accredited to ISO/IEC 17025:2017 by American Association for Laboratory Accreditation with Certificate Number 5145.02.

Test Firm	Sporton International Inc. (Kunshan)		
Test Site Location	No. 1098, Pengxi North Road, Kunshan Economic Development Zone Jiangsu Province 215300 People's Republic of China TEL : +86-512-57900158		
Test Site No.	Sporton Site No.	FCC Designation No.	FCC Test Firm Registration No.
	03CH04-KS	CN1257	314309



Sporton International Inc. (ShenZhen) is accredited to ISO/IEC 17025:2017 by American Association for Laboratory Accreditation with Certificate Number 5145.01.

Test Firm	Sporton International Inc. (ShenZhen)		
Test Site Location	1/F, 2/F, Bldg 5, Shiling Industrial Zone, Xinwei Village, Xili, Nanshan, Shenzhen, 518055 People's Republic of China TEL: +86-755-86379589 FAX: +86-755-86379595		
Test Site No.	Sporton Site No.	FCC Designation No.	FCC Test Firm Registration No.
	TH01-SZ	CN1256	421272

Test data subcontracted: Conducted test cases in section 3 of this report

1.8 Test Software

Item	Site	Manufacturer	Name	Version
1.	03CH04-KS	AUDIX	E3	6.2009-8-24a1

1.9 Applicable Standards

According to the specifications of the manufacturer, the EUT must comply with the requirements of the following standards:

- ♦ 47 CFR Part 2, 22, 27
- ♦ ANSI C63.26-2015
- ♦ FCC KDB 971168 D01 Power Meas License Digital Systems v03r01
- ♦ FCC KDB 412172 D01 Determining ERP and EIRP v01r01

Remark:

All test items were verified and recorded according to the standards and without any deviation during the test.



2 Test Configuration of Equipment Under Test

2.1 Test Mode

Antenna port conducted and radiated test items are performed according to KDB 971168 D01 Power Meas License Digital Systems v03r01 with maximum output power.

For radiated measurement, pre-scanned in three orthogonal panels X, Y, Z. The worst cases (X/Z plane) were recorded in this report.

The device is investigated from 30MHz to 10 times of fundamental signal for radiated spurious emission test under different RB size/offset and modulations in exploratory test. Subsequently, only the worst case emissions are reported.

Orthogonal Planes of EUT	X Plane	Y Plane	Z Plane
			

Test Items	5G NR	Bandwidth (MHz)													Modulation					RB #		Test Channel			
		5	10	15	20	25	30	40	50	60	70	80	90	100	PI/2 BPSK	QPSK	16 QAM	64 QAM	256 QAM	1	Full	L	M	H	
Max. Output Power	n5	v	v	v	v	-	-	-	-	-	-	-	-	-	v	v	v	v	v	v	v	v	v	v	v
	n7	v	v	v	v	v	v	v	v	-	-	-	-	-	v	v	v	v	v	v	v	v	v	v	v
	n38	-	v	v	v	v	v	v	-	-	-	-	-	-	v	v	v	v	v	v	v	v	v	v	v
	n41	-	v	v	v	-	v	v	v	v	v	v	v	v	v	v	v	v	v	v	v	v	v	v	v
	n66	v	v	v	v	v	v	v	-	-	-	-	-	-	v	v	v	v	v	v	v	v	v	v	v
Peak-to-Average Ratio	n5				v	-	-	-	-	-	-	-	-	v	v					v	v		v		
	n7				v					-	-	-	-	v	v					v	v		v		
	n41	-			v	-								v	v					v	v		v		
	n66				v				-	-	-	-	-	v	v					v	v		v		
26dB and 99% Bandwidth	n5	v	v	v	v	-	-	-	-	-	-	-	-	v	v	v	v	v	v		v		v		
	n7	v	v	v	v	v	v	v	v	-	-	-	-	v	v	v	v	v	v		v		v		
	n38	-				v			-	-	-	-	-	v	v	v	v	v	v		v		v		
	n41	-	v	v	v	-	v	v	v	v	v	v	v	v	v	v	v	v	v	v		v		v	
	n66	v	v	v	v	v	v	v	-	-	-	-	-	v	v	v	v	v	v	v		v		v	



Test Items	5G NR	Bandwidth (MHz)													Modulation					RB #		Test Channel			
		5	10	15	20	25	30	40	50	60	70	80	90	100	PI/2 BPSK	QPSK	16 QAM	64 QAM	256 QAM	1	Full	L	M	H	
Conducted Band Edge	n5	v	v		v	-	-	-	-	-	-	-	-	-	v	v				v	v	v		v	
	n7	v				v			v	-	-	-	-	-	v	v				v	v	v		v	
	n38	-				v			-	-	-	-	-	-	v	v				v	v	v		v	
	n41	-	v			-			v						v	v	v				v	v	v		v
	n66	v			v				v	-	-	-	-	-	-	v	v				v	v	v		v
Conducted Spurious Emission	n5	v	v		v	-	-	-	-	-	-	-	-	-	v	v				v		v	v	v	
	n7	v				v			v	-	-	-	-	-	v	v				v		v	v	v	
	n38	-				v			-	-	-	-	-	-	v	v				v		v	v	v	
	n41	-	v			-			v						v	v	v				v		v	v	v
	n66	v			v				v	-	-	-	-	-	-	v	v				v		v	v	v
Frequency Stability	n5				v	-	-	-	-	-	-	-	-	-		v					v		v		
	n7				v					-	-	-	-	-		v					v		v		
	n41	-			v	-										v					v		v		
	n66				v					-	-	-	-	-	-		v					v		v	
E.R.P / E.I.R.P	n5	v	v	v	v	-	-	-	-	-	-	-	-	-	v	v	v	v	v	v	v	v	v	v	
	n7	v	v	v	v	v	v	v	v	-	-	-	-	-	v	v	v	v	v	v	v	v	v	v	
	n38	-	v	v	v	v	v	v	-	-	-	-	-	-	v	v	v	v	v	v	v	v	v	v	
	n41	-	v	v	v	-	v	v	v	v	v	v	v	v	v	v	v	v	v	v	v	v	v	v	
	n66	v	v	v	v	v	v	v	-	-	-	-	-	-	v	v	v	v	v	v	v	v	v	v	
Radiated Spurious Emission	n5	Worst Case																					v		
	n7	Worst Case																					v		
	n38	Worst Case																					v		
	n41	Worst Case																					v		
	n66	Worst Case																					v		
Note	<ol style="list-style-type: none"> The mark "v" means that this configuration is chosen for testing The mark "-" means that this bandwidth is not supported. The device is investigated from 30MHz to 10 times of fundamental signal for radiated spurious emission test under different RB size/offset and modulations in exploratory test. Subsequently, only the worst case emissions are reported. Frequency Stability : Normal Voltage = 3.89V ; Low Voltage =3.60V. ; High Voltage =4.48V All test items are based on engineering evaluation. 																								

2.2 Connection Diagram of Test System

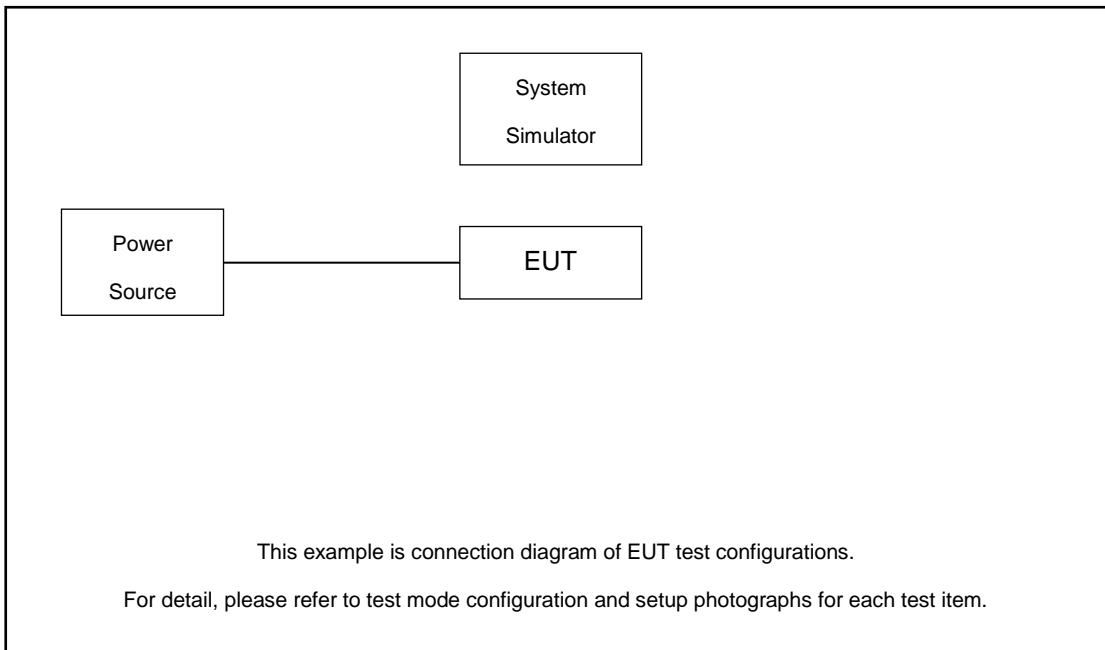

The EUT has been configuration operated in a manner tended to maximize its emission characteristics in a typical application.

2.3 Support Unit used in test configuration and system

Item	Equipment	Trade Name	Model No.	FCC ID	Data Cable	Power Cord
1.	DC Power Supply	GW	GPS-3030D	N/A	N/A	Unshielded, 1.8 m
2.	LTE Base Station	Anritsu	MT8820/8821	N/A	N/A	Unshielded, 1.8 m
3.	NR Base Station	Anritsu	MT8000A	N/A	N/A	Unshielded, 1.8 m

2.4 Measurement Results Explanation Example

For all conducted test items:

The offset level is set in the spectrum analyzer to compensate the RF cable loss between EUT conducted output port and spectrum analyzer. With the offset compensation, the spectrum analyzer reading level is exactly the EUT RF output level.

The spectrum analyzer offset is derived from RF cable loss.

Offset = RF cable loss + attenuator factor.

Following shows an offset computation example with cable loss 8.70 dB.

Example :

$$\text{Offset(dB)} = \text{RF cable loss(dB)} \\ = 7.60 \text{ (dB)}$$



2.5 Frequency List of Low/Middle/High Channels

5G NR n5 Channel and Frequency List				
BW [MHz]	Channel/Frequency(MHz)	Lowest	Middle	Highest
20	Channel	166800	167300	167800
	Frequency	834	836.5	839
15	Channel	166300	167300	168300
	Frequency	831.5	836.5	841.5
10	Channel	165800	167300	168800
	Frequency	829	836.5	844
5	Channel	165300	167300	169300
	Frequency	826.5	836.5	846.5

5G NR n7 Channel and Frequency List				
BW [MHz]	Channel/Frequency(MHz)	Lowest	Middle	Highest
50	Channel	505000	507000	509000
	Frequency	2525	2535	2545
40	Channel	504000	507000	510000
	Frequency	2520	2535	2550
30	Channel	503000	507000	511000
	Frequency	2515	2535	2555
25	Channel	502500	507000	511500
	Frequency	2512.5	2535	2557.5
20	Channel	502000	507000	512000
	Frequency	2510	2535	2560
15	Channel	501500	507000	512500
	Frequency	2507.5	2535	2562.5
10	Channel	501000	507000	513000
	Frequency	2505	2535	2565
5	Channel	500500	507000	513500
	Frequency	2502.5	2535	2567.5



5G NR n38 Channel and Frequency List				
BW [MHz]	Channel/Frequency(MHz)	Lowest	Middle	Highest
40	Channel	518000	519000	520000
	Frequency	2590	2595	2600
30	Channel	517000	519000	521000
	Frequency	2585	2595	2605
25	Channel	516500	519000	521500
	Frequency	2582.5	2595	2607.5
20	Channel	516000	519000	522000
	Frequency	2580	2595	2610
15	Channel	515500	519000	522500
	Frequency	2577.5	2595	2612.5
10	Channel	515000	519000	523000
	Frequency	2575	2595	2615

5G NR n41 Channel and Frequency List				
BW [MHz]	Channel/Frequency(MHz)	Lowest	Middle	Highest
100	Channel	509202	518598	528000
	Frequency	2546.01	2592.99	2640
90	Channel	508200	518598	528996
	Frequency	2541	2592.99	2644.98
80	Channel	507204	518598	529998
	Frequency	2536.02	2592.99	2649.99
70	Channel	506202	518598	531000
	Frequency	2531.01	2592.99	2655
60	Channel	505200	518598	531996
	Frequency	2526	2592.99	2659.98
50	Channel	504204	518598	532998
	Frequency	2521.02	2592.99	2664.99
40	Channel	503202	518598	534000
	Frequency	2516.01	2592.99	2670
30	Channel	502200	518598	534996
	Frequency	2511	2592.99	2674.98
20	Channel	501204	518598	535998
	Frequency	2506.02	2592.99	2679.99
15	Channel	500700	518598	536496
	Frequency	2503.5	2592.99	2682.48
10	Channel	500202	518598	537000
	Frequency	2501.01	2592.99	2685



5G NR n66 Channel and Frequency List				
BW [MHz]	Channel/Frequency(MHz)	Lowest	Middle	Highest
40	Channel	346000	349000	352000
	Frequency	1730	1745	1760
30	Channel	345000	349000	353000
	Frequency	1725	1745	1765
25	Channel	344500	349000	353500
	Frequency	1722.5	1745	1767.5
20	Channel	344000	349000	354000
	Frequency	1720	1745	1770
15	Channel	343500	349000	354500
	Frequency	1717.5	1745	1772.5
10	Channel	343000	349000	355000
	Frequency	1715	1745	1775
5	Channel	342500	349000	355500
	Frequency	1712.5	1745	1777.5

3 Conducted Test Items

3.1 Measuring Instruments

See list of measuring instruments of this test report.

3.2 Test Setup

3.2.1 Conducted Output Power

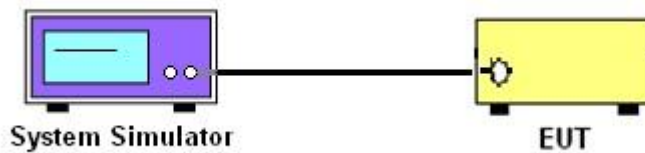

3.2.2 Peak-to-Average Ratio, Occupied Bandwidth, Conducted Band-Edge and Conducted Spurious Emission



3.2.3 Frequency Stability

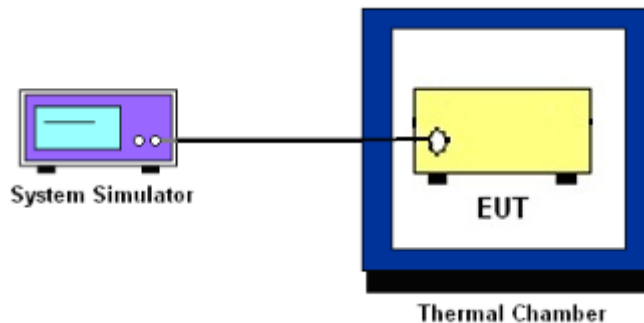

3.3 Test Result of Conducted Test

Please refer to Appendix A.



3.4 Conducted Output Power and ERP/EIRP

3.4.1 Description of the Conducted Output Power Measurement and ERP/EIRP Measurement

A system simulator was used to establish communication with the EUT. Its parameters were set to force the EUT transmitting at maximum output power. The measured power in the radio frequency on the transmitter output terminals shall be reported.

The ERP of mobile transmitters must not exceed 7 Watts for 5G NR n5.

The EIRP of mobile transmitters must not exceed 2 Watts for 5G NR n7, n38, n41.

The EIRP of mobile transmitters must not exceed 1 Watts for 5G NR n66.

According to KDB 412172 D01 Power Approach,

$EIRP = P_T + G_T - L_C$, $ERP = EIRP - 2.15$, where

P_T = transmitter output power in dBm

G_T = gain of the transmitting antenna in dBi

L_C = signal attenuation in the connecting cable between the transmitter and antenna in dB

3.4.2 Test Procedures

1. The testing follows ANSI C63.26 Section 5.2
2. The transmitter output port was connected to the system simulator.
3. Set EUT at maximum power through the system simulator.
4. Select lowest, middle, and highest channels for each band and different modulation.
5. Measure and record the power level from the system simulator.



3.5 Peak-to-Average Ratio

3.5.1 Description of the PAR Measurement

Power Complementary Cumulative Distribution Function (CCDF) curves provide a means for characterizing the power peaks of a digitally modulated signal on a statistical basis. A CCDF curve depicts the probability of the peak signal amplitude exceeding the average power level. Most contemporary measurement instrumentation include the capability to produce CCDF curves for an input signal provided that the instrument's resolution bandwidth can be set wide enough to accommodate the entire input signal bandwidth. In measuring transmissions in this band using an average power technique, the peak-to-average ratio (PAR) of the transmission may not exceed 13 dB.

3.5.2 Test Procedures

1. The testing follows ANSI C63.26 Section 5.2.3.4 (CCDF).
2. The EUT was connected to spectrum and system simulator via a power divider.
3. Set the CCDF (Complementary Cumulative Distribution Function) option in spectrum analyzer.
4. The highest RF powers were measured and recorded the maximum PAPR level associated with a probability of 0.1 %.
5. Record the deviation as Peak to Average Ratio.



3.6 Occupied Bandwidth

3.6.1 Description of Occupied Bandwidth Measurement

The occupied bandwidth is the width of a frequency band such that, below the lower and above the upper frequency limits, the mean powers emitted are each equal to a specified percentage 0.5% of the total mean transmitted power.

The 26 dB emission bandwidth is defined as the frequency range between two points, one above and one below the carrier frequency, at which the spectral density of the emission is attenuated 26 dB below the maximum in-band spectral density of the modulated signal. Spectral density (power per unit bandwidth) is to be measured with a detector of resolution bandwidth equal to approximately 1.0% of the emission bandwidth.

3.6.2 Test Procedures

1. The testing follows ANSI C63.26 Section 5.4
2. The EUT was connected to spectrum analyzer and system simulator via a power divider.
3. The spectrum analyzer center frequency is set to the nominal EUT channel center frequency. The span range for the spectrum analyzer shall be between two and five times the anticipated OBW.
4. The nominal resolution bandwidth (RBW) shall be in the range of 1 to 5 % of the anticipated OBW, and the VBW shall be at least 3 times the RBW.
5. Set the detection mode to peak, and the trace mode to max hold.
6. Determine the reference value: Set the EUT to transmit a modulated signal. Allow the trace to stabilize. Set the spectrum analyzer marker to the highest level of the displayed trace.
(this is the reference value)
7. Determine the “-26 dB down amplitude” as equal to (Reference Value – X).
8. Place two markers, one at the lowest and the other at the highest frequency of the envelope of the spectral display such that each marker is at or slightly below the “-X dB down amplitude” determined in step 6. If a marker is below this “-X dB down amplitude” value it shall be placed as close as possible to this value. The OBW is the positive frequency difference between the two markers.
9. Use the 99 % power bandwidth function of the spectrum analyzer and report the measured bandwidth.



3.7 Conducted Band Edge

3.7.1 Description of Conducted Band Edge Measurement

22.917(a)

For operations in the 824 – 849 MHz band, the FCC limit is $43 + 10\log_{10}(P[\text{Watts}])$ dB below the transmitter power P(Watts) in a 100kHz bandwidth. However, in the 1MHz bands immediately outside and adjacent to the licensee's frequency block, a resolution bandwidth of at least one percent of the emission bandwidth of the fundamental emission of the transmitter may be employed.

27.53 (h)

For operations in the 1710 – 1755 MHz band, the FCC limit is $43 + 10\log_{10}(P[\text{Watts}])$ dB below the transmitter power P(Watts) in a 1 MHz bandwidth. However, in the 1MHz bands immediately outside and adjacent to the licensee's frequency block, a resolution bandwidth of at least one percent of the emission bandwidth of the fundamental emission of the transmitter may be employed.

27.53(m)(4)

For mobile digital stations, the attenuation factor shall be not less than $40 + 10 \log (P)$ dB on all frequencies between the channel edge and 5 megahertz from the channel edge, $43 + 10 \log (P)$ dB on all frequencies between 5 megahertz and X megahertz from the channel edge, and $55 + 10 \log (P)$ dB on all frequencies more than X megahertz from the channel edge, where X is the greater of 6 megahertz or the actual emission bandwidth as defined in paragraph (m)(6) of this section. In addition, the attenuation factor shall not be less that $43 + 10 \log (P)$ dB on all frequencies between 2490.5 MHz and 2496 MHz and $55 + 10 \log (P)$ dB at or below 2490.5 MHz. Mobile Satellite Service licensees operating on frequencies below 2495 MHz may also submit a documented interference complaint against BRS licensees operating on channel BRS Channel 1 on the same terms and conditions as adjacent channel BRS or EBS licensees.



3.7.2 Test Procedures

1. The testing follows ANSI C63.26 section 5.7
2. The EUT was connected to spectrum analyzer and system simulator via a power divider.
3. The band edges of low and high channels for the highest RF powers were measured.
4. Set RBW \geq 1% EBW in the 1MHz band immediately outside and adjacent to the band edge.
5. Beyond the 1 MHz band from the band edge, RBW=1MHz was used or a narrower RBW was used (generally limited to no less than 1% of the OBW) and the measured power was integrated over the full required measurement bandwidth.
6. Set spectrum analyzer with RMS detector.
7. The RF fundamental frequency should be excluded against the limit line in the operating frequency band.
8. Checked that all the results comply with the emission limit line.

Example:

The limit line is derived from $43 + 10\log(P)$ dB below the transmitter power P(Watts)

$$= P(W) - [43 + 10\log(P)] \text{ (dB)}$$

$$= [30 + 10\log(P)] \text{ (dBm)} - [43 + 10\log(P)] \text{ (dB)} = -13\text{dBm}.$$

9. For 5G NR n7/n38/n41, the other 40 dB, and 55 dB have additionally applied same calculation above.
10. When using the integration method, the starting frequency of the integration shall be centered at one-half of the RBW away from the band edge.



3.8 Conducted Spurious Emission

3.8.1 Description of Conducted Spurious Emission Measurement

The power of any emission outside of the authorized operating frequency ranges must be lower than the transmitter power (P) by a factor of at least $43 + 10 \log (P)$ dB.

For 5G NR n7/n38/n41:

The power of any emission outside of the authorized operating frequency ranges must be lower than the transmitter power (P) by a factor of at least $55 + 10 \log (P)$ dB.

It is measured by means of a calibrated spectrum analyzer and scanned from 30 MHz up to a frequency including its 10th harmonic.

3.8.2 Test Procedures

1. The testing follows ANSI C63.26 section 5.7
2. The EUT was connected to spectrum analyzer and system simulator via a power divider.
3. The RF output of EUT was connected to the spectrum analyzer by RF cable and attenuator. The path loss was compensated to the results for each measurement.
4. The middle channel for the highest RF power within the transmitting frequency was measured.
5. The conducted spurious emission for the whole frequency range was taken.
6. Make the measurement with the spectrum analyzer's RBW = 1MHz, VBW = 3MHz.
7. Set spectrum analyzer with RMS detector.
8. Taking the record of maximum spurious emission.
9. The RF fundamental frequency should be excluded against the limit line in the operating frequency band.
10. The limit line is derived from $43 + 10\log(P)$ dB below the transmitter power P(Watts)
 $= P(W) - [43 + 10\log(P)]$ (dB)
 $= [30 + 10\log(P)]$ (dBm) - $[43 + 10\log(P)]$ (dB)
 $= -13$ dBm.
11. For 5G NR n7/n38/n41
The limit line is derived from $55 + 10\log(P)$ dB below the transmitter power P(Watts)
 $= P(W) - [55 + 10\log(P)]$ (dB)
 $= [30 + 10\log(P)]$ (dBm) - $[55 + 10\log(P)]$ (dB)
 $= -25$ dBm.



3.9 Frequency Stability

3.9.1 Description of Frequency Stability Measurement

The frequency stability shall be measured by variation of ambient temperature and variation of primary supply voltage to ensure that the fundamental emission stays within the authorized frequency block. The frequency stability of the transmitter shall be maintained within $\pm 0.00025\%$ ($\pm 2.5\text{ppm}$) of the center frequency.

3.9.2 Test Procedures for Temperature Variation

1. The testing follows ANSI C63.26 section 5.6.4
2. The EUT was set up in the thermal chamber and connected with the system simulator.
3. With power OFF, the temperature was decreased to -30°C and the EUT was stabilized before testing. Power was applied and the maximum change in frequency was recorded within one minute.
4. With power OFF, the temperature was raised in 10°C step up to 50°C . The EUT was stabilized at each step for at least half an hour. Power was applied and the maximum frequency change was recorded within one minute.

3.9.3 Test Procedures for Voltage Variation

1. The testing follows ANSI C63.26 section 5.6.5
2. The EUT was placed in a temperature chamber at $20\pm 5^{\circ}\text{C}$ and connected with the system simulator.
3. The power supply voltage to the EUT was varied from 85% to 115% of the nominal value for other than hand carried battery equipment.
4. For hand carried, battery powered equipment, reduce the primary ac or dc supply voltage to the battery operating end point, which shall be specified by the manufacturer.
5. The variation in frequency was measured for the worst case.

4 Radiated Test Items

4.1 Measuring Instruments

See list of measuring instruments of this test report.

4.2 Test Setup

4.2.1 For radiated test below 30MHz

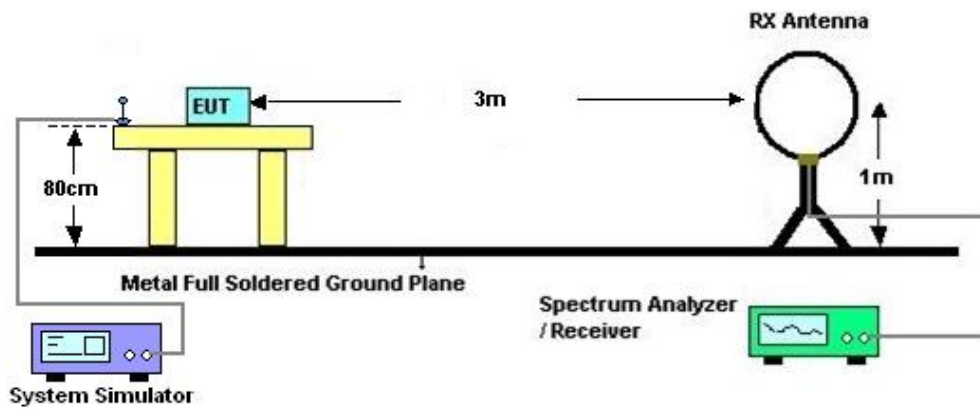

4.2.2 For radiated test from 30MHz to 1GHz

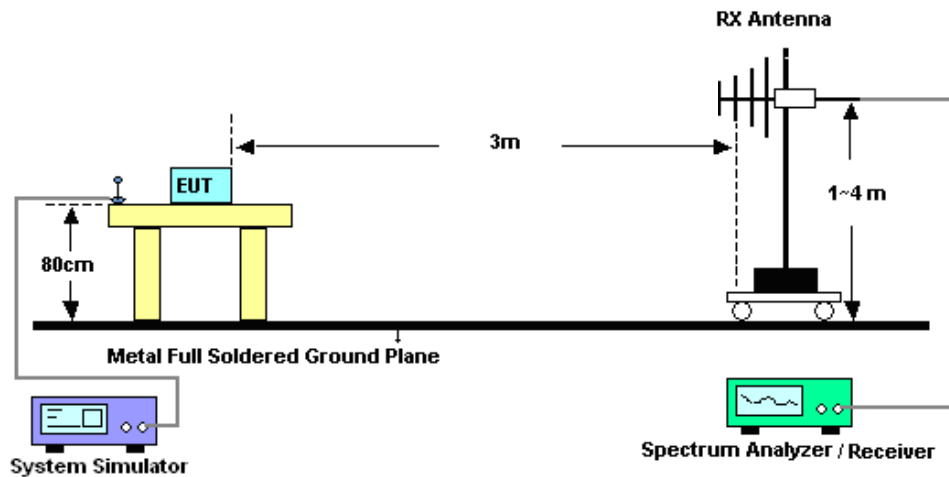

4.2.3 For radiated test above 1GHz

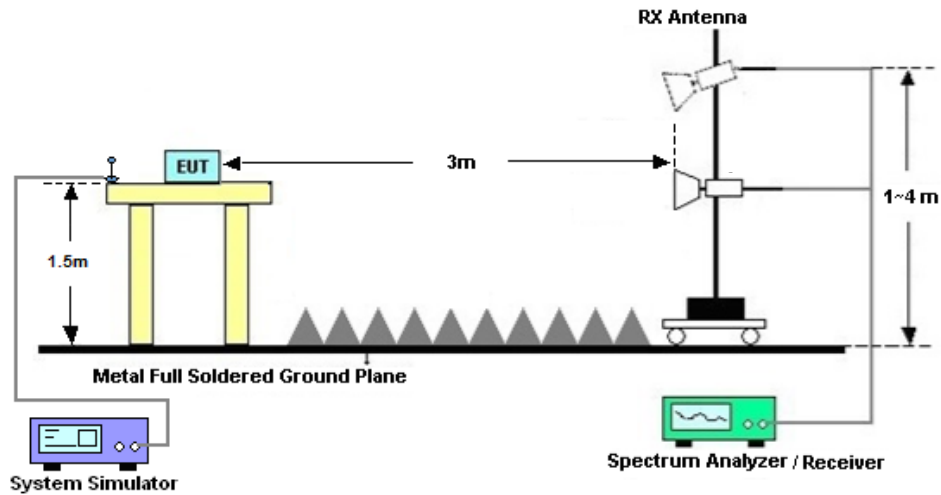

4.3 Test Result of Radiated Test

The low frequency, which started from 9 kHz to 30MHz, was pre-scanned and the result which was 20dB lower than the limit line was not reported.

Please refer to Appendix B.



4.4 Radiated Spurious Emission

4.4.1 Description of Radiated Spurious Emission

The radiated spurious emission was measured by substitution method according to ANSI C63.26. The power of any emission outside of the authorized operating frequency ranges must be attenuated below the transmitter power (P) by a factor of at least $43 + 10 \log (P)$ dB.

For 5G NR n7/n38/n41

The power of any emission outside of the authorized operating frequency ranges must be attenuated below the transmitter power (P) by a factor of at least $55 + 10 \log (P)$ dB.

The spectrum is scanned from 30 MHz up to a frequency including its 10th harmonic.

4.4.2 Test Procedures

1. The testing follows ANSI C63.26 Section 5.5
2. The EUT was placed on a turntable with 0.8 meter height for frequency below 1GHz and 1.5 meter height for frequency above 1GHz respectively above ground.
3. The EUT was set 3 meters from the receiving antenna mounted on the antenna tower.
4. The table was rotated 360 degrees to determine the position of the highest spurious emission.
5. The height of the receiving antenna is varied between 1m to 4m to search the maximum spurious emission for both horizontal and vertical polarizations.
6. During the measurement, the system simulator parameters were set to force the EUT transmitting at maximum output power.
7. Make the measurement with the spectrum analyzer's RBW = 1MHz, VBW = 3MHz, taking the record of maximum spurious emission.
8. A horn antenna was substituted in place of the EUT and was driven by a signal generator.
9. Tune the output power of signal generator to the same emission level with EUT maximum spurious emission.
10. $EIRP (dBm) = S.G. Power - Tx Cable Loss + Tx Antenna Gain$
11. $ERP (dBm) = EIRP - 2.15$
12. The RF fundamental frequency should be excluded against the limit line in the operating frequency band.

The limit line is derived from $43 + 10\log(P)$ dB below the transmitter power P(Watts)
 $= P(W) - [43 + 10\log(P)] (dB)$
 $= [30 + 10\log(P)] (dBm) - [43 + 10\log(P)] (dB)$
 $= -13dBm.$

13. For 5G NR n7/n38/n41:

The limit line is derived from $55 + 10\log(P)$ dB below the transmitter power P(Watts)
The limit line is derived from $55 + 10\log(P)$ dB below the transmitter power P(Watts)



5 List of Measuring Equipment

Instrument	Manufacturer	Model No.	Serial No.	Characteristics	Calibration Date	Test Date	Due Date	Remark
Spectrum Analyzer	R&S	FSV40	101078	10Hz~40GHz	Apr. 06, 2023	May 16, 2023~ May 29, 2023	Apr. 05, 2024	Conducted (TH01-SZ)
Power Divider	TOJOIN	PS-2SM-04 265	60.06.020.007 7	0.4GHz~26.5GHz	Dec. 25, 2022	May 16, 2023~ May 29, 2023	Dec. 24, 2023	Conducted (TH01-SZ)
Thermal Chamber	Ten Billion Hongzhangroup	LP-150U	H2014081803	-40~+150°C	Jul. 07, 2022	May 16, 2023~ May 29, 2023	Jul. 06, 2023	Conducted (TH01-SZ)
EXA Spectrum Analyzer	Keysight	N9010B	MY57471079	10Hz-44G,MAX 30dB	Oct. 12, 2022	May 21, 2023	Oct. 11, 2023	Radiation (03CH04-KS)
Loop Antenna	R&S	HFH2-Z2	100321	9kHz~30MHz	Oct. 16, 2022	May 21, 2023	Oct. 15, 2023	Radiation (03CH04-KS)
Bilog Antenna	TeseQ	CBL6111D	49922	30MHz-1GHz	May 24, 2022	May 21, 2023	May 23, 2023	Radiation (03CH04-KS)
Horn Antenna	Schwarzbeck	BBHA9120D	1284	1GHz~18GHz	Oct. 16, 2022	May 21, 2023	Oct. 15, 2023	Radiation (03CH04-KS)
SHF-EHF Horn	Com-power	AH-840	101070	18GHz~40GHz	Jan. 08, 2023	May 21, 2023	Jan. 07, 2024	Radiation (03CH04-KS)
Amplifier	SONOMA	310N	187289	9KHz-1GHz	May 24, 2022	May 21, 2023	May 23, 2023	Radiation (03CH04-KS)
Amplifier	MITEQ	EM18G40G GA	060728	18~40GHz	Jan. 05, 2023	May 21, 2023	Jan. 04, 2024	Radiation (03CH04-KS)
high gain Amplifier	EM	EM01G18G A	060840	1Ghz-18Ghz	Oct. 12, 2022	May 21, 2023	Oct. 11, 2023	Radiation (03CH04-KS)
Amplifier	Agilent	8449B	3008A02370	1Ghz-18Ghz	Oct. 12, 2022	May 21, 2023	Oct. 11, 2023	Radiation (03CH04-KS)
AC Power Source	Chroma	61601	F104090004	N/A	NCR	May 21, 2023	NCR	Radiation (03CH04-KS)
Turn Table	ChamPro	EM 1000-T	060762-T	0~360 degree	NCR	May 21, 2023	NCR	Radiation (03CH04-KS)
Antenna Mast	ChamPro	EM 1000-A	060762-A	1 m~4 m	NCR	May 21, 2023	NCR	Radiation (03CH04-KS)

NCR: No Calibration Required



6 Measurement Uncertainty

The measurement uncertainties shown below were calculated in accordance with the requirements of ANSI 63.26-2015. All the measurement uncertainty value were shown with a coverage K=2 to indicate 95% level of confidence. The measurement data show herein meets or exceeds the CISPR measurement uncertainty values specified in CISPR 16-4-2 and can be compared directly to specified limit to determine compliance.

Uncertainty of Conducted Measurement

Test Item	Uncertainty
Conducted Power	±1.34 dB
Conducted Emissions	±1.34 dB
Occupied Channel Bandwidth	±0.13 %

Uncertainty of Radiated Emission Measurement (30 MHz ~ 1000 MHz)

Measuring Uncertainty for a Level of Confidence of 95% (U = 2Uc(y))	3.82 dB
---	---------

Uncertainty of Radiated Emission Measurement (1 GHz ~ 18 GHz)

Measuring Uncertainty for a Level of Confidence of 95% (U = 2Uc(y))	3.56 dB
---	---------

Uncertainty of Radiated Emission Measurement (18 GHz ~ 40 GHz)

Measuring Uncertainty for a Level of Confidence of 95% (U = 2Uc(y))	3.54 dB
---	---------

----- THE END -----



Appendix A. Test Results of Conducted Test

Test Engineer :	Khan Zheng	Temperature :	22~23°C
		Relative Humidity :	40~42%

FR1 N5-Ant 0

Transmitter Conducted Output Power And ERP, (G_T - L_C)=-5.53dBi

NR Band	SCS (kHz)	Bandwidth (MHz)	Arfcn	Freq (MHz)	Modulation	RB	Conducted Power(dBm)	ERP(dBm)	ERP(W)
5	15	5	165300	826.5	DFT-s-OFDM QPSK	1@1	23.93	16.25	0.0422
5	15	5	165300	826.5	DFT-s-OFDM 16 QAM	1@1	22.59	14.91	0.0310
5	15	5	167300	836.5	DFT-s-OFDM QPSK	1@1	23.99	16.31	0.0428
5	15	5	167300	836.5	DFT-s-OFDM 16 QAM	1@1	22.67	14.99	0.0316
5	15	5	169300	846.5	DFT-s-OFDM QPSK	1@1	24.21	16.53	0.0450
5	15	5	169300	846.5	DFT-s-OFDM 16 QAM	1@1	22.85	15.17	0.0329
5	15	10	165800	829.0	DFT-s-OFDM QPSK	1@1	23.89	16.21	0.0418
5	15	10	165800	829.0	DFT-s-OFDM 16 QAM	1@1	22.64	14.96	0.0313
5	15	10	167300	836.5	DFT-s-OFDM QPSK	1@1	24.02	16.34	0.0431
5	15	10	167300	836.5	DFT-s-OFDM 16 QAM	1@1	22.92	15.24	0.0334
5	15	10	168800	844.0	DFT-s-OFDM QPSK	1@1	24.04	16.36	0.0433
5	15	10	168800	844.0	DFT-s-OFDM 16 QAM	1@1	22.61	14.93	0.0311
5	15	15	166300	831.5	DFT-s-OFDM QPSK	1@1	23.96	16.28	0.0425
5	15	15	166300	831.5	DFT-s-OFDM 16 QAM	1@1	22.59	14.91	0.0310
5	15	15	167300	836.5	DFT-s-OFDM QPSK	1@1	24.01	16.33	0.0430
5	15	15	167300	836.5	DFT-s-OFDM 16 QAM	1@1	22.63	14.95	0.0313
5	15	15	168300	841.5	DFT-s-OFDM QPSK	1@1	23.95	16.27	0.0424
5	15	15	168300	841.5	DFT-s-OFDM 16 QAM	1@1	22.66	14.98	0.0315
5	15	20	166800	834.0	DFT-s-OFDM PI/2 BPSK	50@25	24.05	16.37	0.0434

5	15	20	166800	834.0	DFT-s-OFDM PI/2 BPSK	1@1	24.01	16.33	0.0430
5	15	20	166800	834.0	DFT-s-OFDM PI/2 BPSK	1@104	24.26	16.58	0.0455
5	15	20	166800	834.0	DFT-s-OFDM QPSK	50@25	24.16	16.48	0.0445
5	15	20	166800	834.0	DFT-s-OFDM QPSK	1@1	24.13	16.45	0.0442
5	15	20	166800	834.0	DFT-s-OFDM QPSK	1@104	24.34	16.66	0.0463
5	15	20	166800	834.0	DFT-s-OFDM 16 QAM	50@25	23.13	15.45	0.0351
5	15	20	166800	834.0	DFT-s-OFDM 16 QAM	1@1	22.71	15.03	0.0318
5	15	20	166800	834.0	DFT-s-OFDM 16 QAM	1@104	22.94	15.26	0.0336
5	15	20	166800	834.0	DFT-s-OFDM 64 QAM	50@25	21.59	13.91	0.0246
5	15	20	166800	834.0	DFT-s-OFDM 64 QAM	1@1	21.83	14.15	0.0260
5	15	20	166800	834.0	DFT-s-OFDM 64 QAM	1@104	22.07	14.39	0.0275
5	15	20	166800	834.0	DFT-s-OFDM 256 QAM	50@25	19.55	11.87	0.0154
5	15	20	166800	834.0	DFT-s-OFDM 256 QAM	1@1	19.72	12.04	0.0160
5	15	20	166800	834.0	DFT-s-OFDM 256 QAM	1@104	19.9	12.22	0.0167
5	15	20	166800	834.0	CP-OFDM QPSK	53@26	22.58	14.9	0.0309
5	15	20	166800	834.0	CP-OFDM QPSK	1@1	22.59	14.91	0.0310
5	15	20	166800	834.0	CP-OFDM QPSK	1@104	22.8	15.12	0.0325
5	15	20	167300	836.5	DFT-s-OFDM PI/2 BPSK	50@25	24.15	16.47	0.0444
5	15	20	167300	836.5	DFT-s-OFDM PI/2 BPSK	1@1	24.08	16.4	0.0437
5	15	20	167300	836.5	DFT-s-OFDM PI/2 BPSK	1@104	24.3	16.62	0.0459
5	15	20	167300	836.5	DFT-s-OFDM QPSK	50@25	24.25	16.57	0.0454
5	15	20	167300	836.5	DFT-s-OFDM QPSK	1@1	24.16	16.48	0.0445
5	15	20	167300	836.5	DFT-s-OFDM QPSK	1@104	24.35	16.67	0.0465
5	15	20	167300	836.5	DFT-s-OFDM 16 QAM	50@25	23.3	15.62	0.0365

5	15	20	167300	836.5	DFT-s-OFDM 16 QAM	1@1	22.69	15.01	0.0317
5	15	20	167300	836.5	DFT-s-OFDM 16 QAM	1@104	22.89	15.21	0.0332
5	15	20	167300	836.5	DFT-s-OFDM 64 QAM	50@25	21.64	13.96	0.0249
5	15	20	167300	836.5	DFT-s-OFDM 64 QAM	1@1	21.92	14.24	0.0265
5	15	20	167300	836.5	DFT-s-OFDM 64 QAM	1@104	22.05	14.37	0.0274
5	15	20	167300	836.5	DFT-s-OFDM 256 QAM	50@25	19.61	11.93	0.0156
5	15	20	167300	836.5	DFT-s-OFDM 256 QAM	1@1	19.79	12.11	0.0163
5	15	20	167300	836.5	DFT-s-OFDM 256 QAM	1@104	20.02	12.34	0.0171
5	15	20	167300	836.5	CP-OFDM QPSK	53@26	22.68	15	0.0316
5	15	20	167300	836.5	CP-OFDM QPSK	1@1	22.65	14.97	0.0314
5	15	20	167300	836.5	CP-OFDM QPSK	1@104	22.93	15.25	0.0335
5	15	20	167800	839.0	DFT-s-OFDM PI/2 BPSK	50@25	24.33	16.65	0.0462
5	15	20	167800	839.0	DFT-s-OFDM PI/2 BPSK	1@1	24.1	16.42	0.0439
5	15	20	167800	839.0	DFT-s-OFDM PI/2 BPSK	1@104	24.39	16.71	0.0469
5	15	20	167800	839.0	DFT-s-OFDM QPSK	50@25	24.36	16.68	0.0466
5	15	20	167800	839.0	DFT-s-OFDM QPSK	1@1	24.21	16.53	0.0450
5	15	20	167800	839.0	DFT-s-OFDM QPSK	1@104	24.3	16.62	0.0459
5	15	20	167800	839.0	DFT-s-OFDM 16 QAM	50@25	23.41	15.73	0.0374
5	15	20	167800	839.0	DFT-s-OFDM 16 QAM	1@1	22.77	15.09	0.0323
5	15	20	167800	839.0	DFT-s-OFDM 16 QAM	1@104	22.99	15.31	0.0340
5	15	20	167800	839.0	DFT-s-OFDM 64 QAM	50@25	21.77	14.09	0.0256
5	15	20	167800	839.0	DFT-s-OFDM 64 QAM	1@1	21.98	14.3	0.0269
5	15	20	167800	839.0	DFT-s-OFDM 64 QAM	1@104	22.11	14.43	0.0277
5	15	20	167800	839.0	DFT-s-OFDM 256 QAM	50@25	19.76	12.08	0.0161

5	15	20	167800	839.0	DFT-s- OFDM 256 QAM	1@1	19.75	12.07	0.0161
5	15	20	167800	839.0	DFT-s- OFDM 256 QAM	1@104	20.08	12.4	0.0174
5	15	20	167800	839.0	CP-OFDM QPSK	53@26	22.83	15.15	0.0327
5	15	20	167800	839.0	CP-OFDM QPSK	1@1	22.65	14.97	0.0314
5	15	20	167800	839.0	CP-OFDM QPSK	1@104	23.04	15.36	0.0344

Frequency Stability

NR Band	SCS (kHz)	Bandwidth (MHz)	Arfcn	Freq (MHz)	Modulation	RB	Deviation (ppm)	Verdict	Environment
5	15	20	167300	836.5	DFT-s-OFDM QPSK	100@0	0.0054	PASS	NV
5	15	20	167300	836.5	DFT-s-OFDM QPSK	100@0	0.0036	PASS	LV
5	15	20	167300	836.5	DFT-s-OFDM QPSK	100@0	0.0051	PASS	HV
5	15	20	167300	836.5	DFT-s-OFDM QPSK	100@0	0.0035	PASS	-30°C
5	15	20	167300	836.5	DFT-s-OFDM QPSK	100@0	0.0026	PASS	-20°C
5	15	20	167300	836.5	DFT-s-OFDM QPSK	100@0	0.0037	PASS	-10°C
5	15	20	167300	836.5	DFT-s-OFDM QPSK	100@0	0.0049	PASS	0°C
5	15	20	167300	836.5	DFT-s-OFDM QPSK	100@0	0.0044	PASS	10°C
5	15	20	167300	836.5	DFT-s-OFDM QPSK	100@0	0.0054	PASS	20°C
5	15	20	167300	836.5	DFT-s-OFDM QPSK	100@0	0.0065	PASS	30°C
5	15	20	167300	836.5	DFT-s-OFDM QPSK	100@0	0.0044	PASS	40°C
5	15	20	167300	836.5	DFT-s-OFDM QPSK	100@0	0.0037	PASS	50°C

Peak to Average Ratio

NR Band	SCS (kHz)	Bandwidth (MHz)	Arfcn	Freq (MHz)	Modulation	RB	Result (dB)	Limit (dB)	Verdict
5	15	20	166800	834.0	DFT-s-OFDM PI/2 BPSK	100@0	3.95	13	PASS
5	15	20	166800	834.0	DFT-s-OFDM PI/2 BPSK	1@0	3.47	13	PASS
5	15	20	166800	834.0	DFT-s-OFDM QPSK	100@0	5.01	13	PASS
5	15	20	166800	834.0	DFT-s-OFDM QPSK	1@0	4.24	13	PASS
5	15	20	167300	836.5	DFT-s-OFDM PI/2 BPSK	100@0	4.0	13	PASS
5	15	20	167300	836.5	DFT-s-OFDM PI/2 BPSK	1@0	3.56	13	PASS
5	15	20	167300	836.5	DFT-s-OFDM QPSK	100@0	5.01	13	PASS
5	15	20	167300	836.5	DFT-s-OFDM QPSK	1@0	4.34	13	PASS
5	15	20	167800	839.0	DFT-s-OFDM PI/2 BPSK	100@0	4.03	13	PASS
5	15	20	167800	839.0	DFT-s-OFDM PI/2 BPSK	1@0	3.45	13	PASS
5	15	20	167800	839.0	DFT-s-OFDM QPSK	100@0	5.08	13	PASS
5	15	20	167800	839.0	DFT-s-OFDM QPSK	1@0	4.27	13	PASS

N5(20M)_DFT-s-OFDM_PI_2-BPSK_Outer_Full_Low_CH



N5(20M)_DFT-s-OFDM_PI_2-BPSK_Edge_1RB_Left_Low_CH



N5(20M)_DFT-s-OFDM_QPSK_Outer_Full_Low_CH



N5(20M)_DFT-s-OFDM_QPSK_Edge_1RB_Left_Low_CH



N5(20M)_DFT-s-OFDM_PI_2-BPSK_Outer_Full_Mid_CH



N5(20M)_DFT-s-OFDM_PI_2-BPSK_Edge_1RB_Left_Mid_CH



N5(20M)_DFT-s-OFDM_QPSK_Outer_Full_Mid_CH



N5(20M)_DFT-s-OFDM_QPSK_Edge_1RB_Left_Mid_CH



N5(20M)_DFT-s-OFDM_PI_2-BPSK_Outer_Full_High_CH

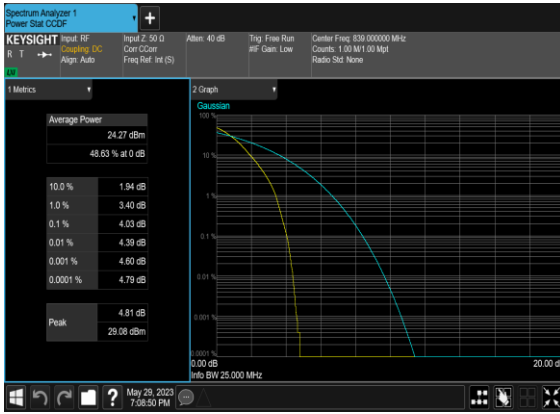

N5(20M)_DFT-s-OFDM_PI_2-BPSK_Edge_1RB_Left_High_CH



N5(20M)_DFT-s-OFDM_QPSK_Outer_Full_High_CH



N5(20M)_DFT-s-OFDM_QPSK_Edge_1RB_Left_High_CH



Occupied Bandwidth

NR Band	SCS (kHz)	Bandwidth (MHz)	Arfcn	Freq (MHz)	Modulation	RB	OBW (MHz)	26dB BW (MHz)
5	15	5	167300	836.5	DFT-s-OFDM PI/2 BPSK	25@0	4.4696	4.754
5	15	5	167300	836.5	DFT-s-OFDM QPSK	25@0	4.4596	4.745
5	15	5	167300	836.5	CP-OFDM QPSK	25@0	4.471	4.821
5	15	5	167300	836.5	CP-OFDM 16 QAM	25@0	4.4594	4.759
5	15	5	167300	836.5	CP-OFDM 64 QAM	25@0	4.4774	4.795
5	15	5	167300	836.5	CP-OFDM 256 QAM	25@0	4.4601	4.765
5	15	10	167300	836.5	DFT-s-OFDM PI/2 BPSK	50@0	8.8755	9.337
5	15	10	167300	836.5	DFT-s-OFDM QPSK	50@0	8.9106	9.333
5	15	10	167300	836.5	CP-OFDM QPSK	52@0	9.2872	9.75
5	15	10	167300	836.5	CP-OFDM 16 QAM	52@0	9.2862	9.715
5	15	10	167300	836.5	CP-OFDM 64 QAM	52@0	9.2755	9.758
5	15	10	167300	836.5	CP-OFDM 256 QAM	52@0	9.2876	9.727
5	15	15	167300	836.5	DFT-s-OFDM PI/2 BPSK	75@0	13.378	13.94
5	15	15	167300	836.5	DFT-s-OFDM QPSK	75@0	13.37	13.94
5	15	15	167300	836.5	CP-OFDM QPSK	79@0	14.07	14.7
5	15	15	167300	836.5	CP-OFDM 16 QAM	79@0	14.105	14.68
5	15	15	167300	836.5	CP-OFDM 64 QAM	79@0	14.121	14.67
5	15	15	167300	836.5	CP-OFDM 256 QAM	79@0	14.081	14.63
5	15	20	167300	836.5	DFT-s-OFDM PI/2 BPSK	100@0	17.834	18.6
5	15	20	167300	836.5	DFT-s-OFDM QPSK	100@0	17.864	18.62
5	15	20	167300	836.5	CP-OFDM QPSK	106@0	18.865	19.53
5	15	20	167300	836.5	CP-OFDM 16 QAM	106@0	18.917	19.69
5	15	20	167300	836.5	CP-OFDM 64 QAM	106@0	18.885	19.73
5	15	20	167300	836.5	CP-OFDM 256 QAM	106@0	18.903	19.63

N5(5M)_DFT-s-OFDM_PI_2- BPSK_Outer_Full_Mid_CH

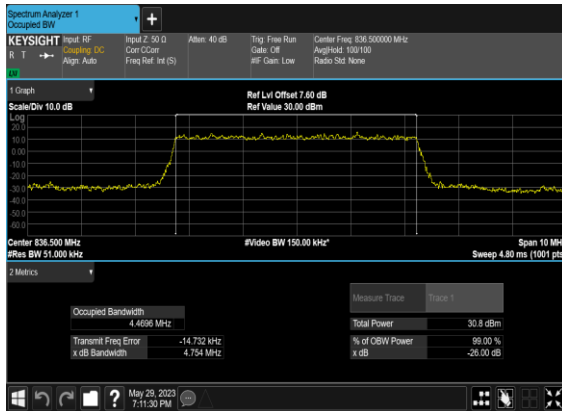

N5(5M)_DFT-s- OFDM_QPSK_Outer_Full_Mid_CH

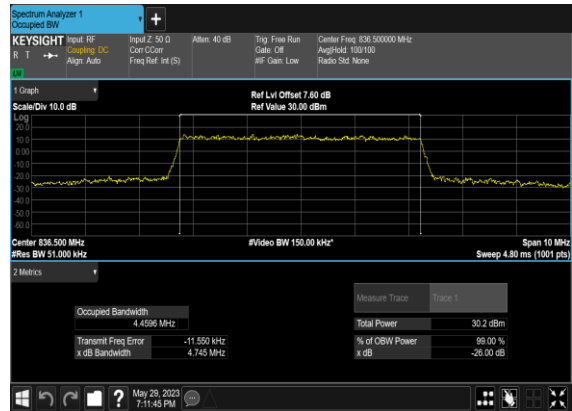

N5(5M)_CP- OFDM_QPSK_Outer_Full_Mid_CH



N5(5M)_CP-OFDM_16 QAM_Outer_Full_Mid_CH

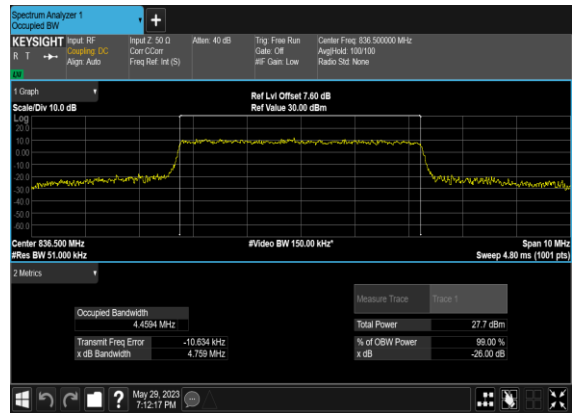

N5(5M)_CP-OFDM_64 QAM_Outer_Full_Mid_CH

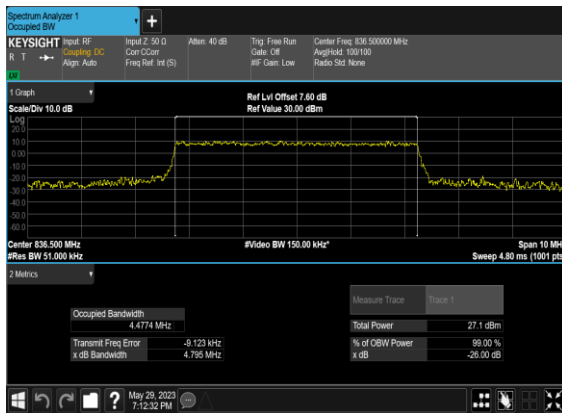

N5(5M)_CP-OFDM_256 QAM_Outer_Full_Mid_CH

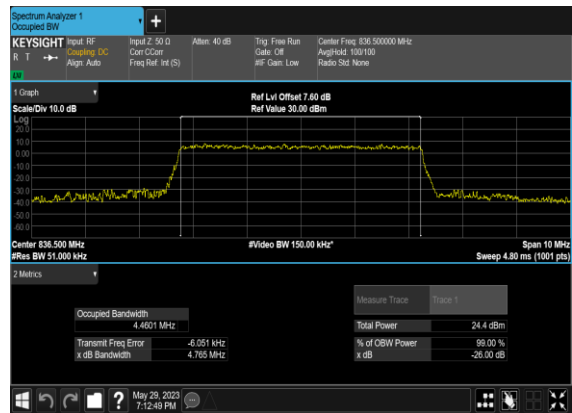

N5(10M)_DFT-s-OFDM_PI_2- BPSK_Outer_Full_Mid_CH

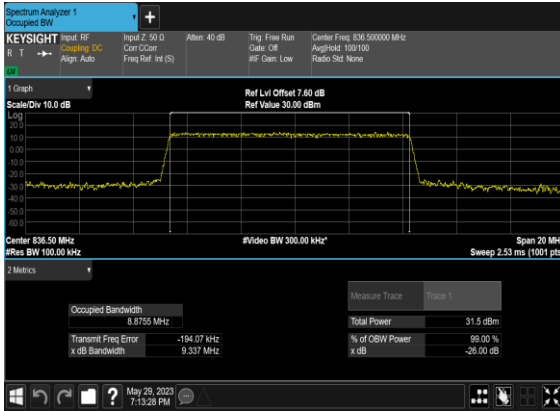

N5(10M)_DFT-s- OFDM_QPSK_Outer_Full_Mid_CH

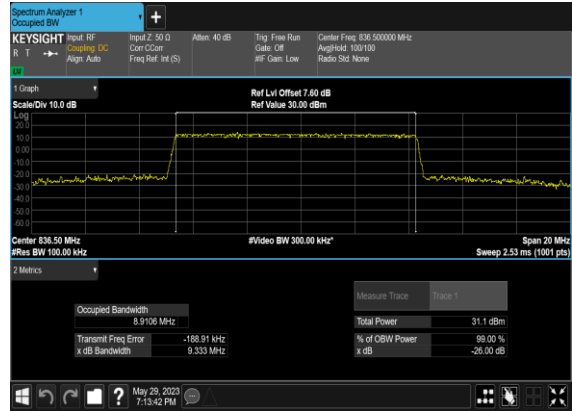

N5(10M)_CP- OFDM_QPSK_Outer_Full_Mid_CH



N5(10M)_CP-OFDM_16 QAM_Outer_Full_Mid_CH



N5(10M)_CP-OFDM_64 QAM_Outer_Full_Mid_CH

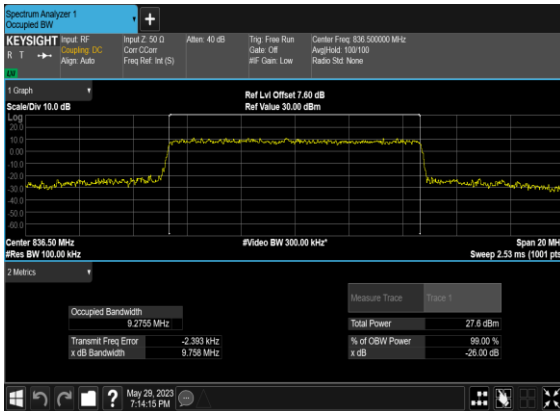

N5(10M)_CP-OFDM_256 QAM_Outer_Full_Mid_CH

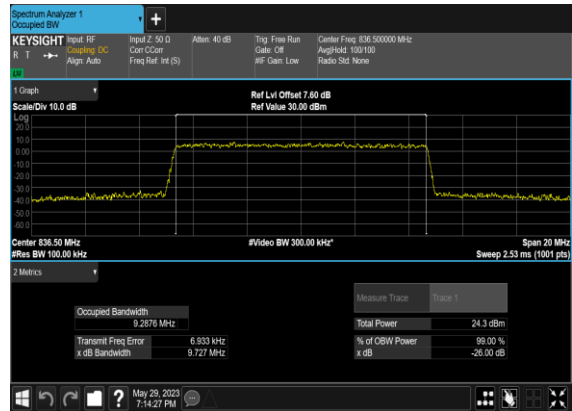

N5(15M)_DFT-s-OFDM_PI_2- BPSK_Outer_Full_Mid_CH

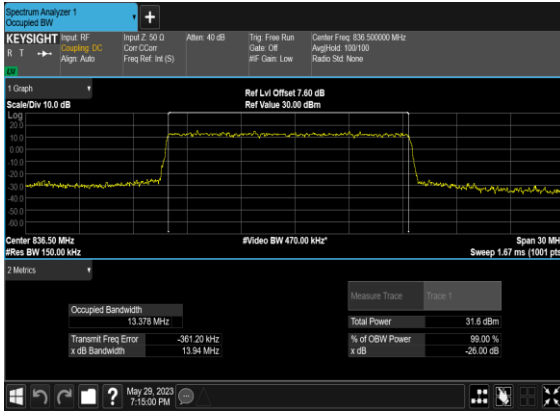

N5(15M)_DFT-s- OFDM_QPSK_Outer_Full_Mid_CH

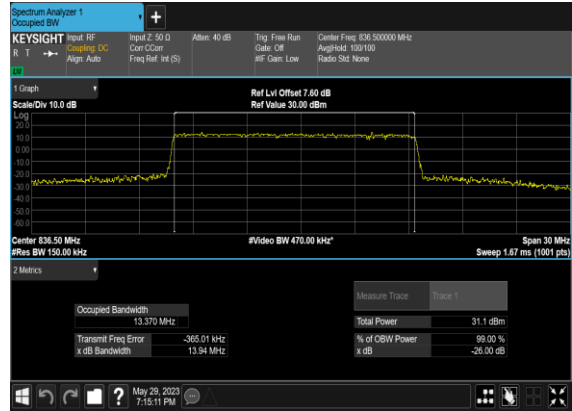

N5(15M)_CP- OFDM_QPSK_Outer_Full_Mid_CH

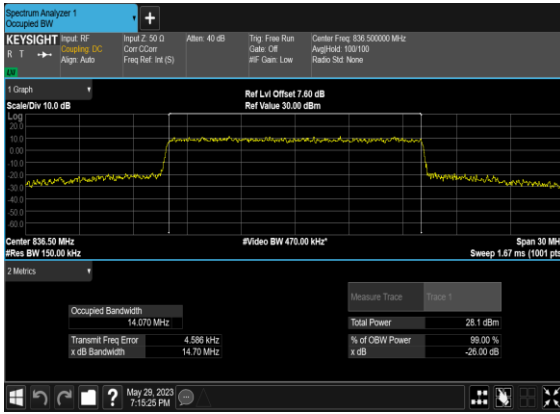

N5(15M)_CP-OFDM_16 QAM_Outer_Full_Mid_CH



N5(15M)_CP-OFDM_64 QAM_Outer_Full_Mid_CH

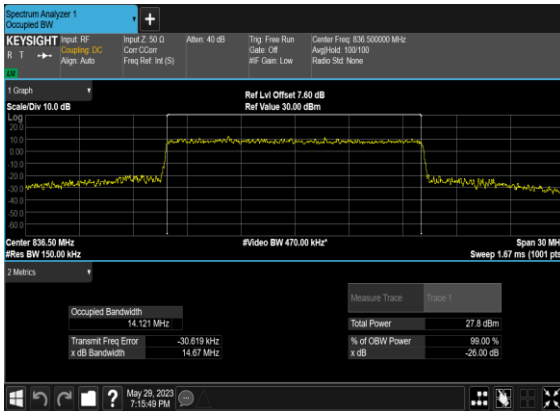

N5(15M)_CP-OFDM_256 QAM_Outer_Full_Mid_CH

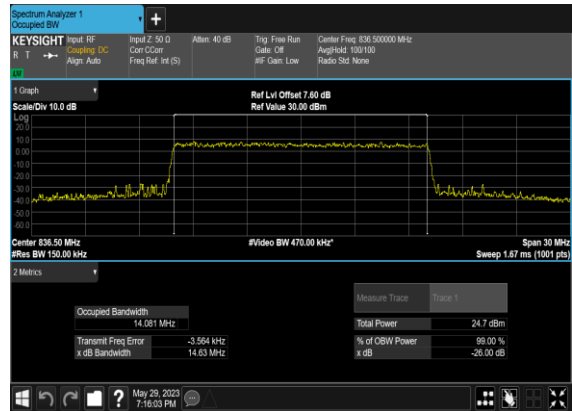

N5(20M)_DFT-s-OFDM_PI_2- BPSK_Outer_Full_Mid_CH

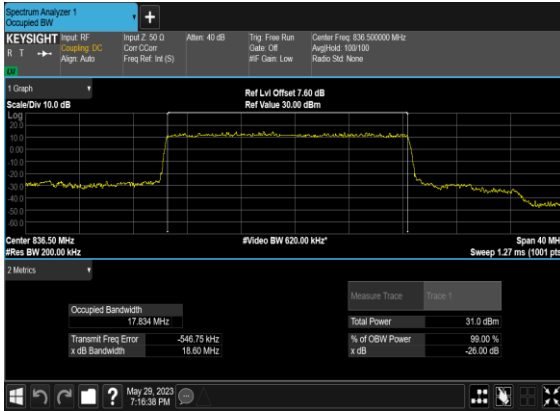

N5(20M)_DFT-s- OFDM_QPSK_Outer_Full_Mid_CH

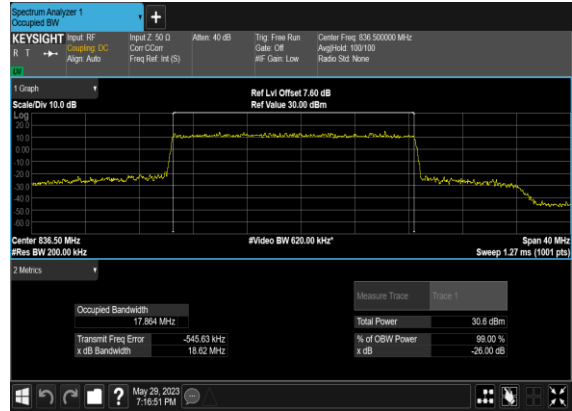

N5(20M)_CP- OFDM_QPSK_Outer_Full_Mid_CH



N5(20M)_CP-OFDM_16 QAM_Outer_Full_Mid_CH

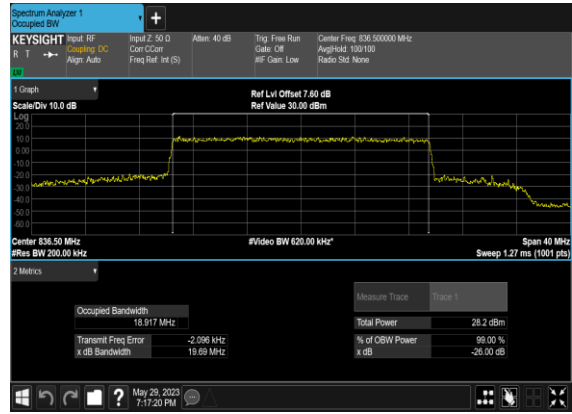

N5(20M)_CP-OFDM_64 QAM_Outer_Full_Mid_CH

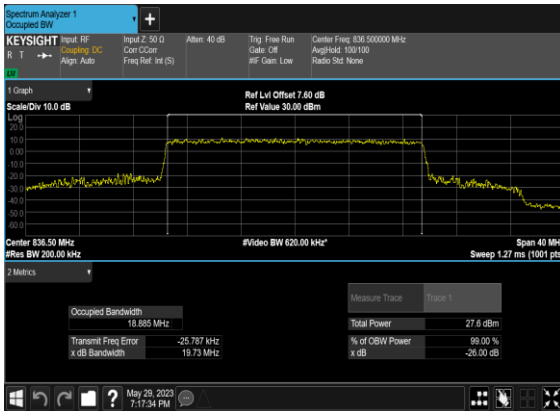

N5(20M)_CP-OFDM_256 QAM_Outer_Full_Mid_CH

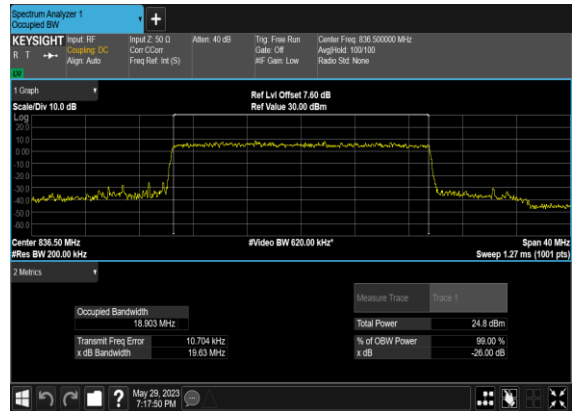

Conducted Spurious Emissions

NR Band	SCS (kHz)	Bandwidth (MHz)	Arfcn	Freq (MHz)	Modulation	RB	Result	Verdict
5	15	5	165300	826.5	DFT-s-OFDM BPSK	1@0	see graph	---
5	15	5	165300	826.5	DFT-s-OFDM BPSK	1@0	see graph	PASS
5	15	5	165300	826.5	DFT-s-OFDM QPSK	1@0	see graph	---
5	15	5	165300	826.5	DFT-s-OFDM QPSK	1@0	see graph	PASS
5	15	5	167300	836.5	DFT-s-OFDM BPSK	1@0	see graph	---
5	15	5	167300	836.5	DFT-s-OFDM BPSK	1@0	see graph	PASS
5	15	5	167300	836.5	DFT-s-OFDM QPSK	1@0	see graph	---
5	15	5	167300	836.5	DFT-s-OFDM QPSK	1@0	see graph	PASS
5	15	5	169300	846.5	DFT-s-OFDM BPSK	1@0	see graph	---
5	15	5	169300	846.5	DFT-s-OFDM BPSK	1@0	see graph	PASS
5	15	5	169300	846.5	DFT-s-OFDM QPSK	1@0	see graph	---
5	15	5	169300	846.5	DFT-s-OFDM QPSK	1@0	see graph	PASS
5	15	10	165800	829.0	DFT-s-OFDM BPSK	1@0	see graph	---
5	15	10	165800	829.0	DFT-s-OFDM BPSK	1@0	see graph	PASS
5	15	10	165800	829.0	DFT-s-OFDM QPSK	1@0	see graph	---
5	15	10	165800	829.0	DFT-s-OFDM QPSK	1@0	see graph	PASS
5	15	10	167300	836.5	DFT-s-OFDM BPSK	1@0	see graph	---
5	15	10	167300	836.5	DFT-s-OFDM BPSK	1@0	see graph	PASS
5	15	10	167300	836.5	DFT-s-OFDM QPSK	1@0	see graph	---
5	15	10	167300	836.5	DFT-s-OFDM QPSK	1@0	see graph	PASS
5	15	10	168800	844.0	DFT-s-OFDM BPSK	1@0	see graph	---
5	15	10	168800	844.0	DFT-s-OFDM BPSK	1@0	see graph	PASS

5	15	10	168800	844.0	DFT-s-OFDM QPSK	1@0	see graph	---
5	15	10	168800	844.0	DFT-s-OFDM QPSK	1@0	see graph	PASS
5	15	20	166800	834.0	DFT-s-OFDM BPSK	1@0	see graph	---
5	15	20	166800	834.0	DFT-s-OFDM BPSK	1@0	see graph	PASS
5	15	20	166800	834.0	DFT-s-OFDM QPSK	1@0	see graph	---
5	15	20	166800	834.0	DFT-s-OFDM QPSK	1@0	see graph	PASS
5	15	20	167300	836.5	DFT-s-OFDM BPSK	1@0	see graph	---
5	15	20	167300	836.5	DFT-s-OFDM BPSK	1@0	see graph	PASS
5	15	20	167300	836.5	DFT-s-OFDM QPSK	1@0	see graph	---
5	15	20	167300	836.5	DFT-s-OFDM QPSK	1@0	see graph	PASS
5	15	20	167800	839.0	DFT-s-OFDM BPSK	1@0	see graph	---
5	15	20	167800	839.0	DFT-s-OFDM BPSK	1@0	see graph	PASS
5	15	20	167800	839.0	DFT-s-OFDM QPSK	1@0	see graph	---
5	15	20	167800	839.0	DFT-s-OFDM QPSK	1@0	see graph	PASS

N5(5M)_DFT-s-OFDM_BPSK_Edge_1RB_Left_Low_CH



N5(5M)_DFT-s-OFDM_QPSK_Edge_1RB_Left_Low_CH



N5(5M)_DFT-s-OFDM_BPSK_Edge_1RB_Left_Mid_CH



N5(5M)_DFT-s-OFDM_QPSK_Edge_1RB_Left_Mid_CH



N5(5M)_DFT-s-OFDM_BPSK_Edge_1RB_Left_High_CH

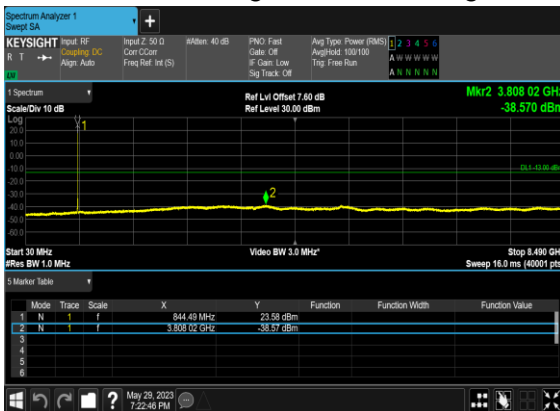

N5(5M)_DFT-s-OFDM_QPSK_Edge_1RB_Left_High_CH

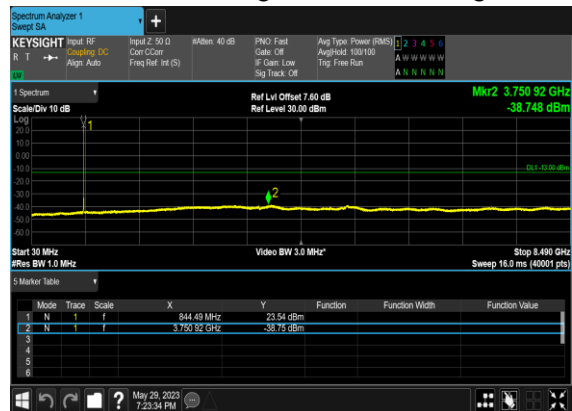

N5(10M)_DFT-s-OFDM_BPSK_Edge_1RB_Left_Low_CH

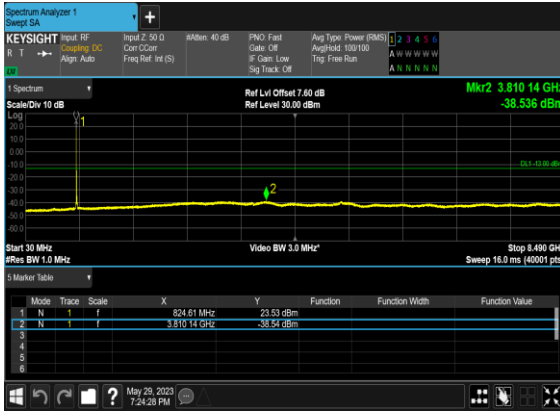

N5(10M)_DFT-s-OFDM_QPSK_Edge_1RB_Left_Low_CH

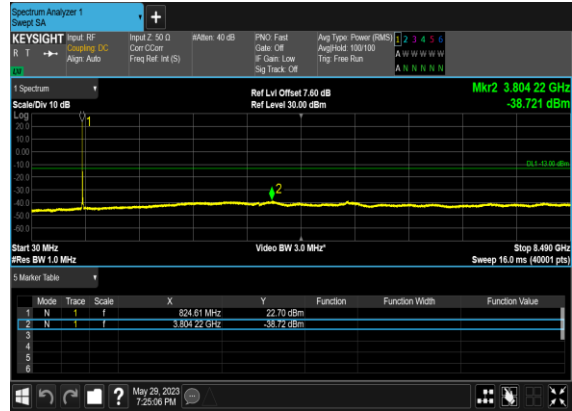

N5(10M)_DFT-s-OFDM_BPSK_Edge_1RB_Left_Mid_CH

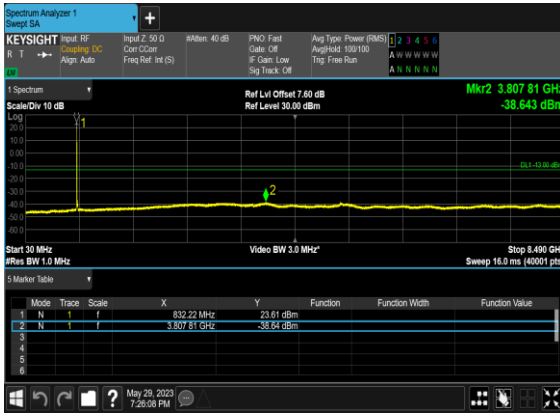

N5(10M)_DFT-s-OFDM_QPSK_Edge_1RB_Left_Mid_CH

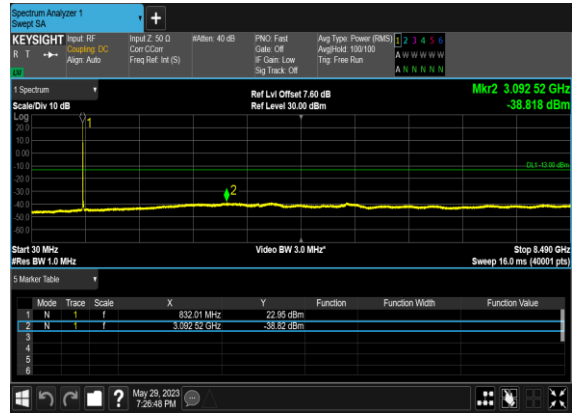

N5(10M)_DFT-s-OFDM_BPSK_Edge_1RB_Left_High_CH



N5(10M)_DFT-s-OFDM_QPSK_Edge_1RB_Left_High_CH



N5(20M)_DFT-s-OFDM_BPSK_Edge_1RB_Left_Low_CH



N5(20M)_DFT-s-OFDM_QPSK_Edge_1RB_Left_Low_CH

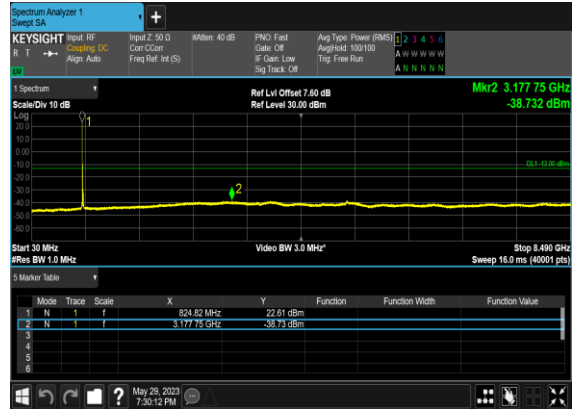

N5(20M)_DFT-s-OFDM_BPSK_Edge_1RB_Left_Mid_CH



N5(20M)_DFT-s-OFDM_QPSK_Edge_1RB_Left_Mid_CH



N5(20M)_DFT-s-OFDM_BPSK_Edge_1RB_Left_High_CH

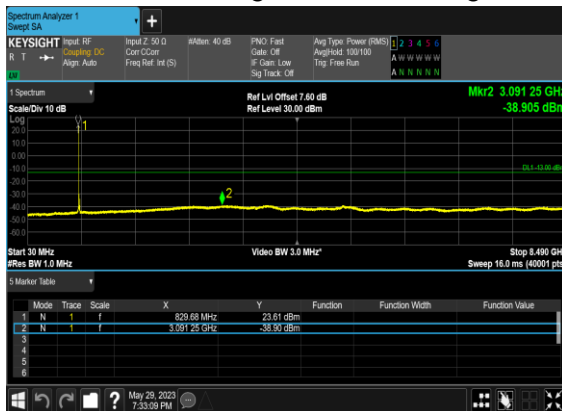

N5(20M)_DFT-s-OFDM_QPSK_Edge_1RB_Left_High_CH

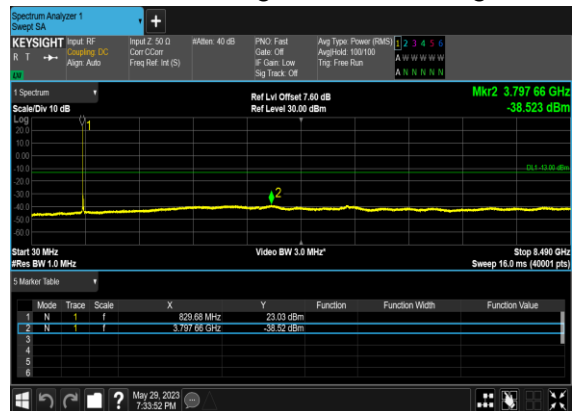

Conducted Band Edge

NR Band	SCS (kHz)	Bandwidth (MHz)	Arfcn	Freq (MHz)	Modulation	RB	Result	Verdict
5	15	5	165300	826.5	DFT-s-OFDM BPSK	1@0	see graph	PASS
5	15	5	165300	826.5	DFT-s-OFDM QPSK	1@0	see graph	PASS
5	15	5	165300	826.5	DFT-s-OFDM BPSK	25@0	see graph	PASS
5	15	5	165300	826.5	DFT-s-OFDM QPSK	25@0	see graph	PASS
5	15	5	169300	846.5	DFT-s-OFDM BPSK	1@24	see graph	PASS
5	15	5	169300	846.5	DFT-s-OFDM QPSK	1@24	see graph	PASS
5	15	5	169300	846.5	DFT-s-OFDM BPSK	25@0	see graph	PASS
5	15	5	169300	846.5	DFT-s-OFDM QPSK	25@0	see graph	PASS
5	15	10	165800	829.0	DFT-s-OFDM BPSK	1@0	see graph	PASS
5	15	10	165800	829.0	DFT-s-OFDM QPSK	1@0	see graph	PASS
5	15	10	165800	829.0	DFT-s-OFDM BPSK	50@0	see graph	PASS
5	15	10	165800	829.0	DFT-s-OFDM QPSK	50@0	see graph	PASS
5	15	10	168800	844.0	DFT-s-OFDM BPSK	1@51	see graph	PASS
5	15	10	168800	844.0	DFT-s-OFDM QPSK	1@51	see graph	PASS
5	15	10	168800	844.0	DFT-s-OFDM BPSK	50@0	see graph	PASS
5	15	10	168800	844.0	DFT-s-OFDM QPSK	50@0	see graph	PASS
5	15	20	166800	834.0	DFT-s-OFDM BPSK	1@0	see graph	PASS
5	15	20	166800	834.0	DFT-s-OFDM QPSK	1@0	see graph	PASS
5	15	20	166800	834.0	DFT-s-OFDM BPSK	100@0	see graph	PASS
5	15	20	166800	834.0	DFT-s-OFDM QPSK	100@0	see graph	PASS
5	15	20	167800	839.0	DFT-s-OFDM BPSK	1@105	see graph	PASS
5	15	20	167800	839.0	DFT-s-OFDM QPSK	1@105	see graph	PASS
5	15	20	167800	839.0	DFT-s-OFDM BPSK	100@0	see graph	PASS
5	15	20	167800	839.0	DFT-s-OFDM QPSK	100@0	see graph	PASS

N5(5M)_DFT-s-
OFDM_BPSK_Edge_1RB_Left_Low_CH



N5(5M)_DFT-s-
OFDM_QPSK_Edge_1RB_Left_Low_CH

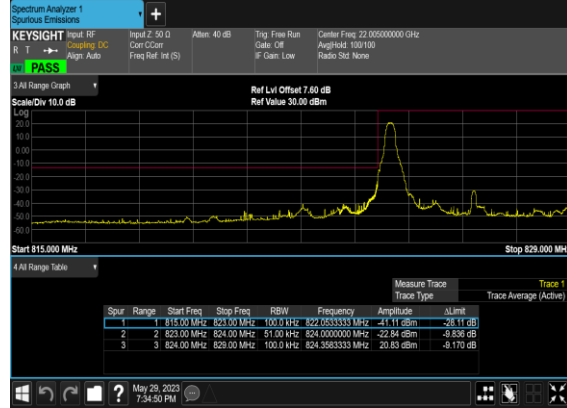

N5(5M)_DFT-s-
OFDM_BPSK_Outer_Full_Low_CH

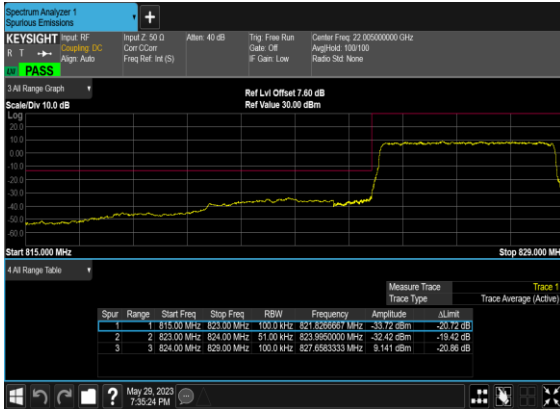

N5(5M)_DFT-s-
OFDM_QPSK_Outer_Full_Low_CH

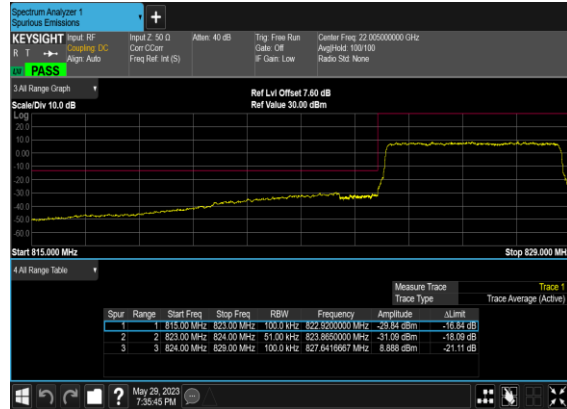

N5(5M)_DFT-s-
OFDM_BPSK_Edge_1RB_Right_High_CH

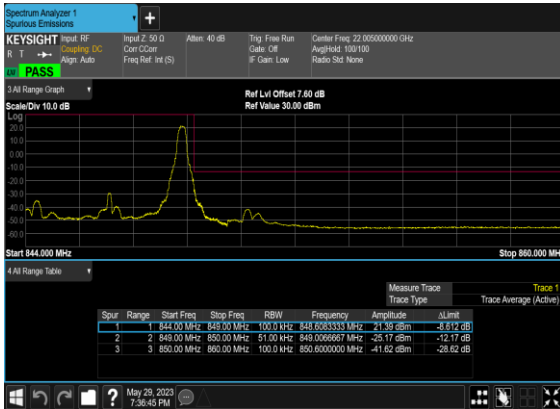

N5(5M)_DFT-s-
OFDM_QPSK_Edge_1RB_Right_High_CH

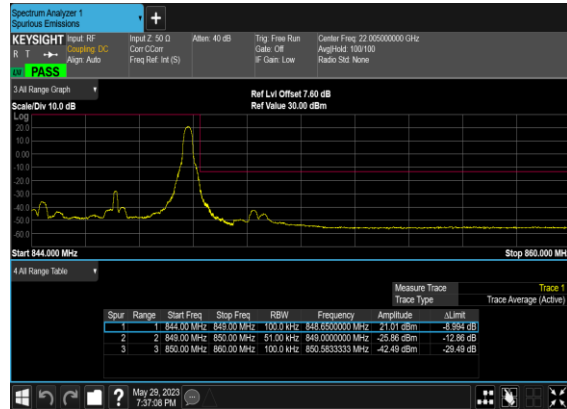

N5(5M)_DFT-s-
OFDM_BPSK_Outer_Full_High_CH



N5(5M)_DFT-s-
OFDM_QPSK_Outer_Full_High_CH



N5(10M)_DFT-s-
OFDM_BPSK_Edge_1RB_Left_Low_CH

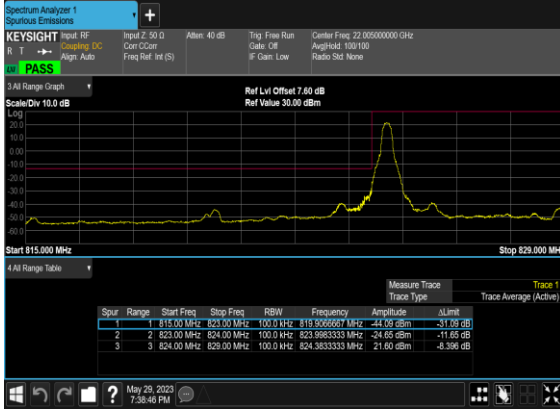

N5(10M)_DFT-s-
OFDM_QPSK_Edge_1RB_Left_Low_CH

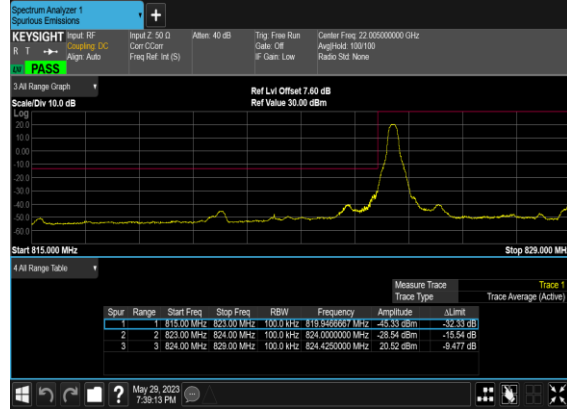

N5(10M)_DFT-s-
OFDM_BPSK_Outer_Full_Low_CH

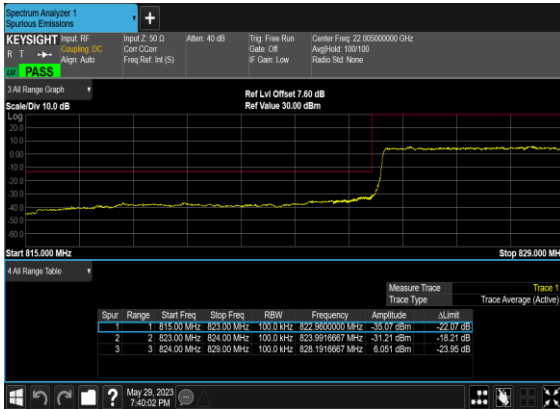

N5(10M)_DFT-s-
OFDM_QPSK_Outer_Full_Low_CH

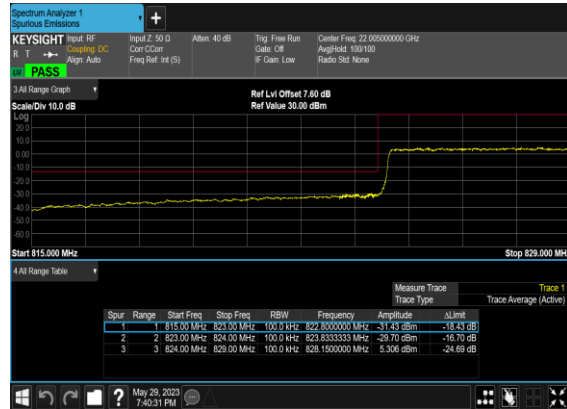

N5(10M)_DFT-s-OFDM_BPSK_Edge_1RB_Right_High_CH

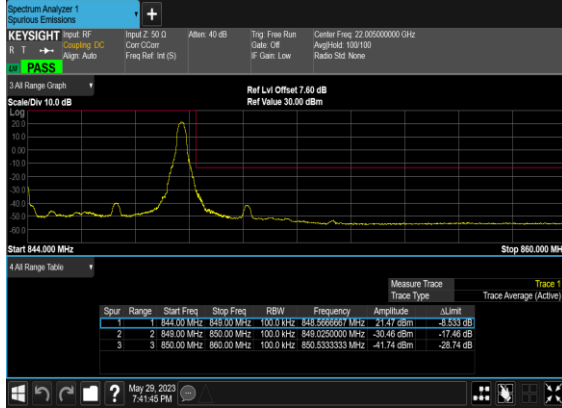

N5(10M)_DFT-s-OFDM_QPSK_Edge_1RB_Right_High_CH

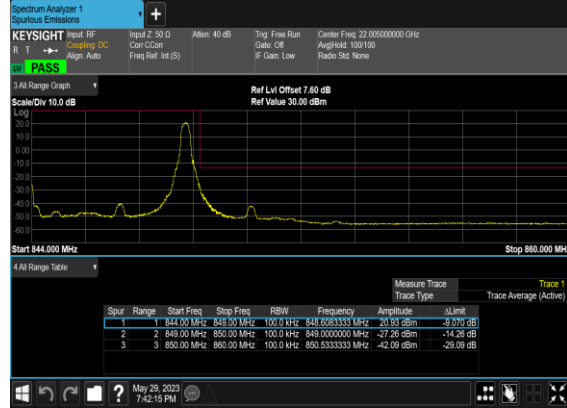

N5(10M)_DFT-s-OFDM_BPSK_Outer_Full_High_CH



N5(10M)_DFT-s-OFDM_QPSK_Outer_Full_High_CH



N5(20M)_DFT-s-OFDM_BPSK_Edge_1RB_Left_Low_CH

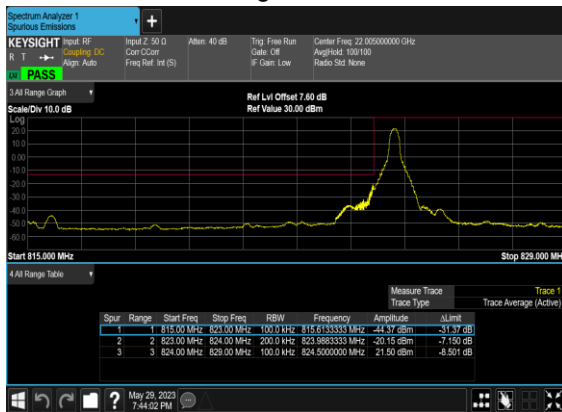

N5(20M)_DFT-s-OFDM_QPSK_Edge_1RB_Left_Low_CH

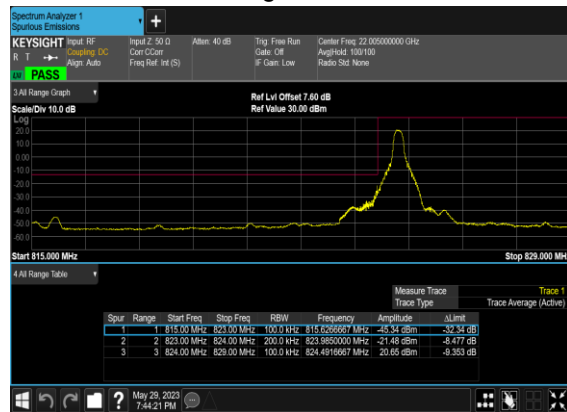

N5(20M)_DFT-s-
OFDM_BPSK_Outer_Full_Low_CH

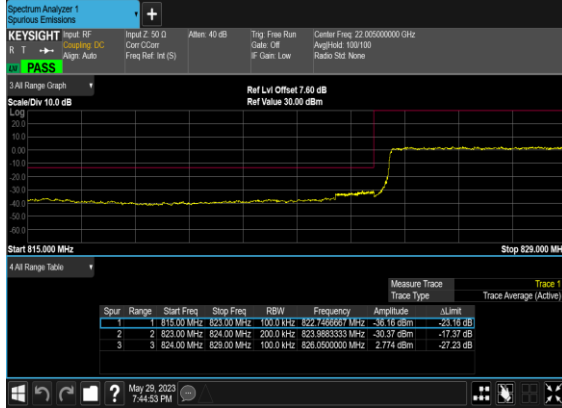

N5(20M)_DFT-s-
OFDM_QPSK_Outer_Full_Low_CH

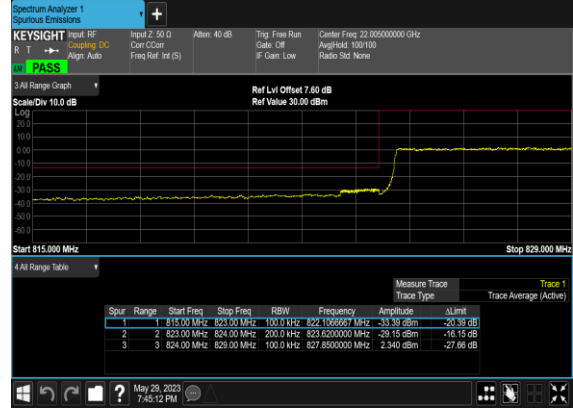

N5(20M)_DFT-s-
OFDM_BPSK_Edge_1RB_Right_High_CH

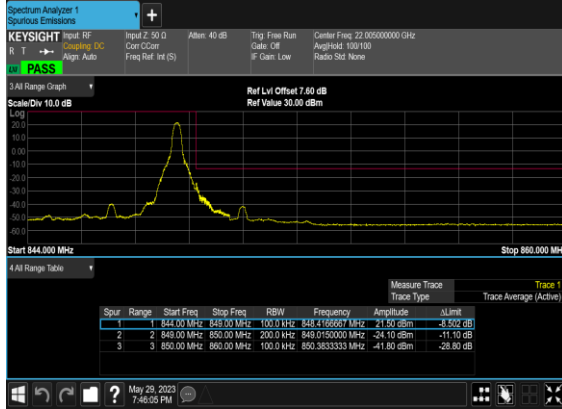

N5(20M)_DFT-s-
OFDM_QPSK_Edge_1RB_Right_High_CH

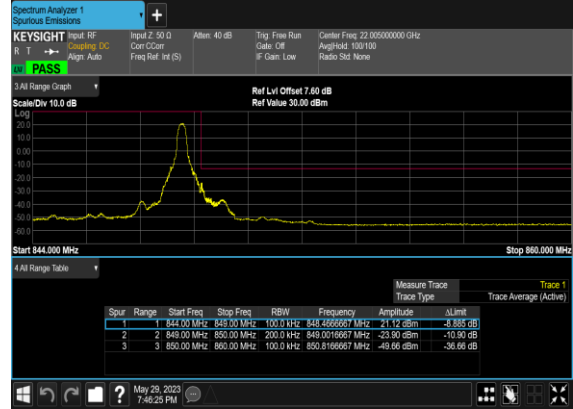

N5(20M)_DFT-s-
OFDM_BPSK_Outer_Full_High_CH



N5(20M)_DFT-s-
OFDM_QPSK_Outer_Full_High_CH

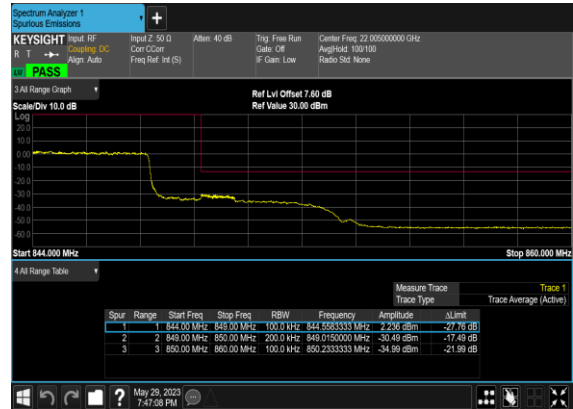

FR1 N7-Ant 4

Transmitter Conducted Output Power And EIRP, (G_T - L_C)=-1.5dBi

NR Band	SCS (kHz)	Bandwidth (MHz)	Arfcn	Freq (MHz)	Modulation	RB	Conducted Power(dBm)	EIRP (dBm)	EIRP (W)
7	15	5	500500	2502.5	DFT-s-OFDM QPSK	1@1	24.04	22.54	0.1795
7	15	5	500500	2502.5	DFT-s-OFDM 16 QAM	1@1	22.13	20.63	0.1156
7	15	5	507000	2535.0	DFT-s-OFDM QPSK	1@1	24.42	22.92	0.1959
7	15	5	507000	2535.0	DFT-s-OFDM 16 QAM	1@1	22.98	21.48	0.1406
7	15	5	513500	2567.5	DFT-s-OFDM QPSK	1@1	24.22	22.72	0.1871
7	15	5	513500	2567.5	DFT-s-OFDM 16 QAM	1@1	22.83	21.33	0.1358
7	15	10	501000	2505.0	DFT-s-OFDM QPSK	1@1	24.03	22.53	0.1791
7	15	10	501000	2505.0	DFT-s-OFDM 16 QAM	1@1	22.65	21.15	0.1303
7	15	10	507000	2535.0	DFT-s-OFDM QPSK	1@1	24.42	22.92	0.1959
7	15	10	507000	2535.0	DFT-s-OFDM 16 QAM	1@1	23.16	21.66	0.1466
7	15	10	513000	2565.0	DFT-s-OFDM QPSK	1@1	24.38	22.88	0.1941
7	15	10	513000	2565.0	DFT-s-OFDM 16 QAM	1@1	23.03	21.53	0.1422
7	15	15	501500	2507.5	DFT-s-OFDM QPSK	1@1	24.04	22.54	0.1795
7	15	15	501500	2507.5	DFT-s-OFDM 16 QAM	1@1	22.62	21.12	0.1294
7	15	15	507000	2535.0	DFT-s-OFDM QPSK	1@1	24.45	22.95	0.1972
7	15	15	507000	2535.0	DFT-s-OFDM 16 QAM	1@1	23.26	21.76	0.1500
7	15	15	512500	2562.5	DFT-s-OFDM QPSK	1@1	24.46	22.96	0.1977
7	15	15	512500	2562.5	DFT-s-OFDM 16 QAM	1@1	23.09	21.59	0.1442
7	15	20	502000	2510.0	DFT-s-OFDM QPSK	1@1	24.03	22.53	0.1791
7	15	20	502000	2510.0	DFT-s-OFDM 16 QAM	1@1	22.74	21.24	0.1330
7	15	20	507000	2535.0	DFT-s-OFDM QPSK	1@1	24.41	22.91	0.1954
7	15	20	507000	2535.0	DFT-s-OFDM 16 QAM	1@1	23.13	21.63	0.1455

7	15	20	512000	2560.0	DFT-s-OFDM QPSK	1@1	24.44	22.94	0.1968
7	15	20	512000	2560.0	DFT-s-OFDM 16 QAM	1@1	23.08	21.58	0.1439
7	15	25	502500	2512.5	DFT-s-OFDM QPSK	1@1	23.32	21.82	0.1521
7	15	25	502500	2512.5	DFT-s-OFDM 16 QAM	1@1	22	20.5	0.1122
7	15	25	507000	2535.0	DFT-s-OFDM QPSK	1@1	23.73	22.23	0.1671
7	15	25	507000	2535.0	DFT-s-OFDM 16 QAM	1@1	22.4	20.9	0.1230
7	15	25	511500	2557.5	DFT-s-OFDM QPSK	1@1	23.89	22.39	0.1734
7	15	25	511500	2557.5	DFT-s-OFDM 16 QAM	1@1	22.61	21.11	0.1291
7	15	30	503000	2515.0	DFT-s-OFDM QPSK	1@1	23.99	22.49	0.1774
7	15	30	503000	2515.0	DFT-s-OFDM 16 QAM	1@1	22.61	21.11	0.1291
7	15	30	507000	2535.0	DFT-s-OFDM QPSK	1@1	24.44	22.94	0.1968
7	15	30	507000	2535.0	DFT-s-OFDM 16 QAM	1@1	23	21.5	0.1413
7	15	30	511000	2555.0	DFT-s-OFDM QPSK	1@1	23.6	22.1	0.1622
7	15	30	511000	2555.0	DFT-s-OFDM 16 QAM	1@1	23.32	21.82	0.1521
7	15	40	504000	2520.0	DFT-s-OFDM QPSK	1@1	24.02	22.52	0.1786
7	15	40	504000	2520.0	DFT-s-OFDM 16 QAM	1@1	22.64	21.14	0.1300
7	15	40	507000	2535.0	DFT-s-OFDM QPSK	1@1	24.33	22.83	0.1919
7	15	40	507000	2535.0	DFT-s-OFDM 16 QAM	1@1	22.89	21.39	0.1377
7	15	40	510000	2550.0	DFT-s-OFDM QPSK	1@1	24.36	22.86	0.1932
7	15	40	510000	2550.0	DFT-s-OFDM 16 QAM	1@1	23.2	21.7	0.1479
7	15	50	505000	2525.0	DFT-s-OFDM PI/2 BPSK	135@67	23.55	22.05	0.1603
7	15	50	505000	2525.0	DFT-s-OFDM PI/2 BPSK	1@1	23.55	22.05	0.1603
7	15	50	505000	2525.0	DFT-s-OFDM PI/2 BPSK	1@268	23.06	21.56	0.1432
7	15	50	505000	2525.0	DFT-s-OFDM QPSK	135@67	23.6	22.1	0.1622
7	15	50	505000	2525.0	DFT-s-OFDM QPSK	1@1	23.16	21.66	0.1466
7	15	50	505000	2525.0	DFT-s-OFDM QPSK	1@268	23.08	21.58	0.1439
7	15	50	505000	2525.0	DFT-s-OFDM 16 QAM	135@67	22.66	21.16	0.1306

7	15	50	505000	2525.0	DFT-s-OFDM 16 QAM	1@1	22.37	20.87	0.1222
7	15	50	505000	2525.0	DFT-s-OFDM 16 QAM	1@268	22.32	20.82	0.1208
7	15	50	505000	2525.0	DFT-s-OFDM 64 QAM	135@67	21.12	19.62	0.0916
7	15	50	505000	2525.0	DFT-s-OFDM 64 QAM	1@1	20.34	18.84	0.0766
7	15	50	505000	2525.0	DFT-s-OFDM 64 QAM	1@268	20.27	18.77	0.0753
7	15	50	505000	2525.0	DFT-s-OFDM 256 QAM	135@67	19.12	17.62	0.0578
7	15	50	505000	2525.0	DFT-s-OFDM 256 QAM	1@1	19.28	17.78	0.0600
7	15	50	505000	2525.0	DFT-s-OFDM 256 QAM	1@268	19.26	17.76	0.0597
7	15	50	505000	2525.0	CP-OFDM QPSK	135@67	22.16	20.66	0.1164
7	15	50	505000	2525.0	CP-OFDM QPSK	1@1	21.75	20.25	0.1059
7	15	50	505000	2525.0	CP-OFDM QPSK	1@268	21.65	20.15	0.1035
7	15	50	507000	2535.0	DFT-s-OFDM PI/2 BPSK	135@67	23.64	22.14	0.1637
7	15	50	507000	2535.0	DFT-s-OFDM PI/2 BPSK	1@1	23.09	21.59	0.1442
7	15	50	507000	2535.0	DFT-s-OFDM PI/2 BPSK	1@268	22.99	21.49	0.1409
7	15	50	507000	2535.0	DFT-s-OFDM QPSK	135@67	23.69	22.19	0.1656
7	15	50	507000	2535.0	DFT-s-OFDM QPSK	1@1	23.17	21.67	0.1469
7	15	50	507000	2535.0	DFT-s-OFDM QPSK	1@268	23.06	21.56	0.1432
7	15	50	507000	2535.0	DFT-s-OFDM 16 QAM	135@67	22.7	21.2	0.1318
7	15	50	507000	2535.0	DFT-s-OFDM 16 QAM	1@1	22.4	20.9	0.1230
7	15	50	507000	2535.0	DFT-s-OFDM 16 QAM	1@268	22.23	20.73	0.1183
7	15	50	507000	2535.0	DFT-s-OFDM 64 QAM	135@67	21.21	19.71	0.0935
7	15	50	507000	2535.0	DFT-s-OFDM 64 QAM	1@1	20.44	18.94	0.0783
7	15	50	507000	2535.0	DFT-s-OFDM 64 QAM	1@268	20.28	18.78	0.0755
7	15	50	507000	2535.0	DFT-s-OFDM 256 QAM	135@67	19.17	17.67	0.0585
7	15	50	507000	2535.0	DFT-s-OFDM 256 QAM	1@1	19.38	17.88	0.0614
7	15	50	507000	2535.0	DFT-s-OFDM 256 QAM	1@268	19.15	17.65	0.0582
7	15	50	507000	2535.0	CP-OFDM QPSK	135@67	22.2	20.7	0.1175

7	15	50	507000	2535.0	CP-OFDM QPSK	1@1	21.76	20.26	0.1062
7	15	50	507000	2535.0	CP-OFDM QPSK	1@268	21.62	20.12	0.1028
7	15	50	509000	2545.0	DFT-s-OFDM PI/2 BPSK	135@67	23.6	22.1	0.1622
7	15	50	509000	2545.0	DFT-s-OFDM PI/2 BPSK	1@1	23.06	21.56	0.1432
7	15	50	509000	2545.0	DFT-s-OFDM PI/2 BPSK	1@268	22.96	21.46	0.1400
7	15	50	509000	2545.0	DFT-s-OFDM QPSK	135@67	24.47	22.97	0.1982
7	15	50	509000	2545.0	DFT-s-OFDM QPSK	1@1	23.11	21.61	0.1449
7	15	50	509000	2545.0	DFT-s-OFDM QPSK	1@268	23.14	21.64	0.1459
7	15	50	509000	2545.0	DFT-s-OFDM 16 QAM	135@67	22.71	21.21	0.1321
7	15	50	509000	2545.0	DFT-s-OFDM 16 QAM	1@1	22.35	20.85	0.1216
7	15	50	509000	2545.0	DFT-s-OFDM 16 QAM	1@268	22.31	20.81	0.1205
7	15	50	509000	2545.0	DFT-s-OFDM 64 QAM	135@67	21.19	19.69	0.0931
7	15	50	509000	2545.0	DFT-s-OFDM 64 QAM	1@1	20.31	18.81	0.0760
7	15	50	509000	2545.0	DFT-s-OFDM 64 QAM	1@268	20.35	18.85	0.0767
7	15	50	509000	2545.0	DFT-s-OFDM 256 QAM	135@67	19.12	17.62	0.0578
7	15	50	509000	2545.0	DFT-s-OFDM 256 QAM	1@1	19.32	17.82	0.0605
7	15	50	509000	2545.0	DFT-s-OFDM 256 QAM	1@268	19.4	17.9	0.0617
7	15	50	509000	2545.0	CP-OFDM QPSK	135@67	22.2	20.7	0.1175
7	15	50	509000	2545.0	CP-OFDM QPSK	1@1	21.66	20.16	0.1038
7	15	50	509000	2545.0	CP-OFDM QPSK	1@268	21.61	20.11	0.1026

Frequency Stability

NR Band	SCS (kHz)	Bandwidth (MHz)	Arfcn	Freq (MHz)	Modulation	RB	Deviation (ppm)	Verdict	Environment
7	15	20	507000	2535.0	DFT-s-OFDM QPSK	100@0	0.0030	PASS	NV
7	15	20	507000	2535.0	DFT-s-OFDM QPSK	100@0	0.0027	PASS	LV
7	15	20	507000	2535.0	DFT-s-OFDM QPSK	100@0	0.0049	PASS	HV
7	15	20	507000	2535.0	DFT-s-OFDM QPSK	100@0	0.0031	PASS	-30°C
7	15	20	507000	2535.0	DFT-s-OFDM QPSK	100@0	0.0028	PASS	-20°C
7	15	20	507000	2535.0	DFT-s-OFDM QPSK	100@0	0.0060	PASS	-10°C
7	15	20	507000	2535.0	DFT-s-OFDM QPSK	100@0	0.0031	PASS	0°C
7	15	20	507000	2535.0	DFT-s-OFDM QPSK	100@0	0.0044	PASS	10°C
7	15	20	507000	2535.0	DFT-s-OFDM QPSK	100@0	0.0030	PASS	20°C
7	15	20	507000	2535.0	DFT-s-OFDM QPSK	100@0	0.0069	PASS	30°C
7	15	20	507000	2535.0	DFT-s-OFDM QPSK	100@0	0.0038	PASS	40°C
7	15	20	507000	2535.0	DFT-s-OFDM QPSK	100@0	0.0055	PASS	50°C

Peak to Average Ratio

NR Band	SCS (kHz)	Bandwidth (MHz)	Arfcn	Freq (MHz)	Modulation	RB	Result (dB)	Limit (dB)	Verdict
7	15	20	502000	2510.0	DFT-s-OFDM PI/2 BPSK	100@0	4.01	13	PASS
7	15	20	502000	2510.0	DFT-s-OFDM PI/2 BPSK	1@0	3.77	13	PASS
7	15	20	502000	2510.0	DFT-s-OFDM QPSK	100@0	4.96	13	PASS
7	15	20	502000	2510.0	DFT-s-OFDM QPSK	1@0	4.56	13	PASS
7	15	20	507000	2535.0	DFT-s-OFDM PI/2 BPSK	100@0	4.15	13	PASS
7	15	20	507000	2535.0	DFT-s-OFDM PI/2 BPSK	1@0	4.03	13	PASS
7	15	20	507000	2535.0	DFT-s-OFDM QPSK	100@0	5.21	13	PASS
7	15	20	507000	2535.0	DFT-s-OFDM QPSK	1@0	4.93	13	PASS
7	15	20	512000	2560.0	DFT-s-OFDM PI/2 BPSK	100@0	3.97	13	PASS
7	15	20	512000	2560.0	DFT-s-OFDM PI/2 BPSK	1@0	3.81	13	PASS
7	15	20	512000	2560.0	DFT-s-OFDM QPSK	100@0	4.72	13	PASS
7	15	20	512000	2560.0	DFT-s-OFDM QPSK	1@0	4.69	13	PASS

N7(20M)_DFT-s-OFDM_PI_2-BPSK_Outer_Full_Low_CH

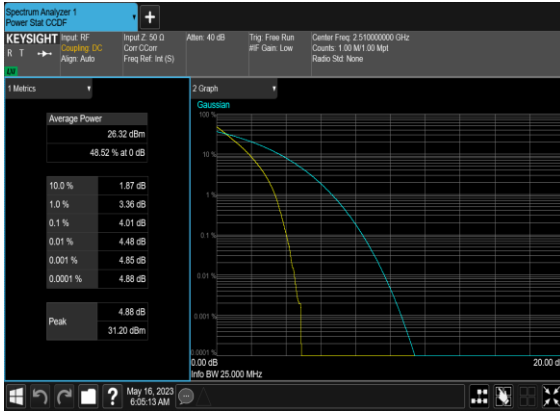

N7(20M)_DFT-s-OFDM_PI_2-BPSK_Edge_1RB_Left_Low_CH



N7(20M)_DFT-s-OFDM_QPSK_Outer_Full_Low_CH



N7(20M)_DFT-s-OFDM_QPSK_Edge_1RB_Left_Low_CH

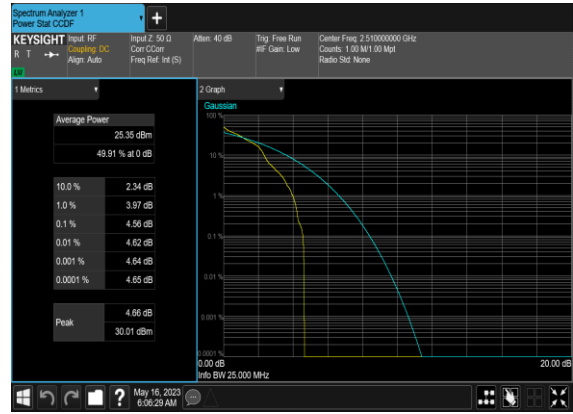

N7(20M)_DFT-s-OFDM_PI_2-BPSK_Outer_Full_Mid_CH

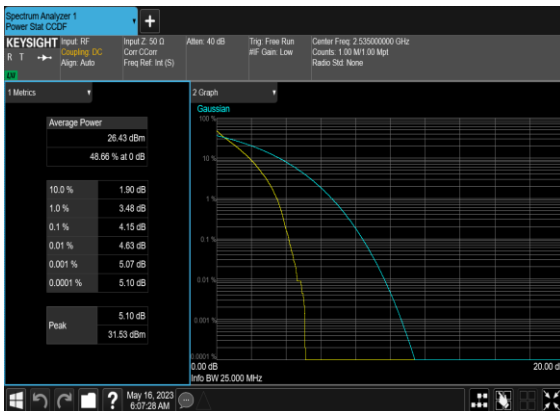

N7(20M)_DFT-s-OFDM_PI_2-BPSK_Edge_1RB_Left_Mid_CH

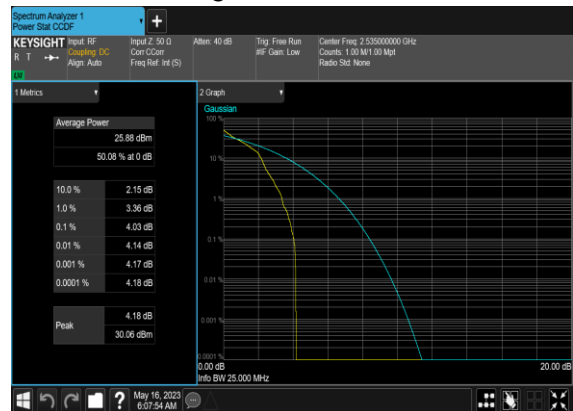

N7(20M)_DFT-s-OFDM_QPSK_Outer_Full_Mid_CH



N7(20M)_DFT-s-OFDM_QPSK_Edge_1RB_Left_Mid_CH



N7(20M)_DFT-s-OFDM_PI_2-BPSK_Outer_Full_High_CH

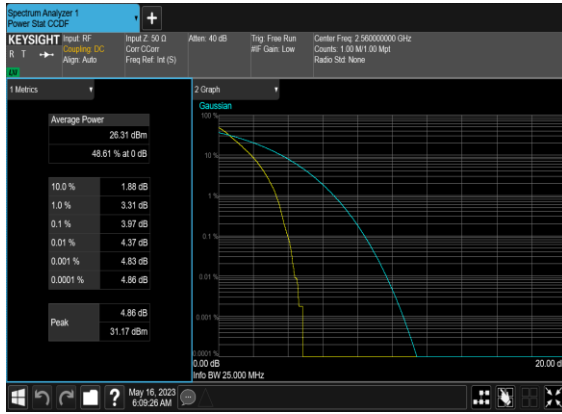

N7(20M)_DFT-s-OFDM_PI_2-BPSK_Edge_1RB_Left_High_CH



N7(20M)_DFT-s-OFDM_QPSK_Outer_Full_High_CH



N7(20M)_DFT-s-OFDM_QPSK_Edge_1RB_Left_High_CH



Occupied Bandwidth

NR Band	SCS (kHz)	Bandwidth (MHz)	Arfcn	Freq (MHz)	Modulation	RB	OBW (MHz)	26dB BW (MHz)
7	15	5	507000	2535.0	DFT-s-OFDM PI/2 BPSK	25@0	4.4556	4.75
7	15	5	507000	2535.0	DFT-s-OFDM QPSK	25@0	4.4576	4.764
7	15	5	507000	2535.0	CP-OFDM QPSK	25@0	4.4585	4.784
7	15	5	507000	2535.0	CP-OFDM 16 QAM	25@0	4.4719	4.769
7	15	5	507000	2535.0	CP-OFDM 64 QAM	25@0	4.4697	4.778
7	15	5	507000	2535.0	CP-OFDM 256 QAM	25@0	4.4615	4.775
7	15	10	507000	2535.0	DFT-s-OFDM PI/2 BPSK	50@0	8.9064	9.364
7	15	10	507000	2535.0	DFT-s-OFDM QPSK	50@0	8.9	9.335
7	15	10	507000	2535.0	CP-OFDM QPSK	52@0	9.2803	9.667
7	15	10	507000	2535.0	CP-OFDM 16 QAM	52@0	9.2703	9.695
7	15	10	507000	2535.0	CP-OFDM 64 QAM	52@0	9.2937	9.687
7	15	10	507000	2535.0	CP-OFDM 256 QAM	52@0	9.2773	9.69
7	15	15	507000	2535.0	DFT-s-OFDM PI/2 BPSK	75@0	13.374	13.97
7	15	15	507000	2535.0	DFT-s-OFDM QPSK	75@0	13.384	13.97
7	15	15	507000	2535.0	CP-OFDM QPSK	79@0	14.122	14.69
7	15	15	507000	2535.0	CP-OFDM 16 QAM	79@0	14.107	14.74
7	15	15	507000	2535.0	CP-OFDM 64 QAM	79@0	14.094	14.68
7	15	15	507000	2535.0	CP-OFDM 256 QAM	79@0	14.111	14.69
7	15	20	507000	2535.0	DFT-s-OFDM PI/2 BPSK	100@0	17.885	18.65
7	15	20	507000	2535.0	DFT-s-OFDM QPSK	100@0	17.837	18.55
7	15	20	507000	2535.0	CP-OFDM QPSK	106@0	18.934	19.67
7	15	20	507000	2535.0	CP-OFDM 16 QAM	106@0	18.918	19.7
7	15	20	507000	2535.0	CP-OFDM 64 QAM	106@0	18.937	19.66
7	15	20	507000	2535.0	CP-OFDM 256 QAM	106@0	18.946	19.6

7	15	25	507000	2535.0	DFT-s-OFDM PI/2 BPSK	128@0	22.842	23.68
7	15	25	507000	2535.0	DFT-s-OFDM QPSK	128@0	22.858	23.7
7	15	25	507000	2535.0	CP-OFDM QPSK	133@0	23.681	24.58
7	15	25	507000	2535.0	CP-OFDM 16 QAM	133@0	23.712	24.54
7	15	25	507000	2535.0	CP-OFDM 64 QAM	133@0	23.737	24.57
7	15	25	507000	2535.0	CP-OFDM 256 QAM	133@0	23.647	24.54
7	15	30	507000	2535.0	DFT-s-OFDM PI/2 BPSK	160@0	28.639	29.61
7	15	30	507000	2535.0	DFT-s-OFDM QPSK	160@0	28.588	29.5
7	15	30	507000	2535.0	CP-OFDM QPSK	160@0	28.577	29.77
7	15	30	507000	2535.0	CP-OFDM 16 QAM	160@0	28.565	29.64
7	15	30	507000	2535.0	CP-OFDM 64 QAM	160@0	28.597	29.6
7	15	30	507000	2535.0	CP-OFDM 256 QAM	160@0	28.558	29.68
7	15	40	507000	2535.0	DFT-s-OFDM PI/2 BPSK	216@0	38.552	39.9
7	15	40	507000	2535.0	DFT-s-OFDM QPSK	216@0	38.595	39.96
7	15	40	507000	2535.0	CP-OFDM QPSK	216@0	38.558	39.92
7	15	40	507000	2535.0	CP-OFDM 16 QAM	216@0	38.513	39.86
7	15	40	507000	2535.0	CP-OFDM 64 QAM	216@0	38.568	39.9
7	15	40	507000	2535.0	CP-OFDM 256 QAM	216@0	38.554	39.9
7	15	50	507000	2535.0	DFT-s-OFDM PI/2 BPSK	270@0	48.112	49.73
7	15	50	507000	2535.0	DFT-s-OFDM QPSK	270@0	48.022	49.75
7	15	50	507000	2535.0	CP-OFDM QPSK	270@0	48.1	49.7
7	15	50	507000	2535.0	CP-OFDM 16 QAM	270@0	48.12	49.72
7	15	50	507000	2535.0	CP-OFDM 64 QAM	270@0	48.053	49.77
7	15	50	507000	2535.0	CP-OFDM 256 QAM	270@0	48.066	49.74