


 Report No.: SZCR240100035204  
 Page: 1 of 115

## TEST REPORT

**Application No.:** SZCR2401000352WM  
**Applicant:** Xiaomi Communications Co., Ltd.  
**Address of Applicant:** #019, 9th Floor, Building 6, 33 Xi'erqi Middle Road, Haidian District, Beijing, China  
**Manufacturer:** Xiaomi Communications Co., Ltd.  
**Address of Manufacturer:** #019, 9th Floor, Building 6, 33 Xi'erqi Middle Road, Haidian District, Beijing, China  
**EUT Description:** Mobile Phone  
**Model No.:** 24049RN28L  
**Trade Mark:** Redmi  
**FCC ID:** 2AFZZN28L  
**Standards:** FCC 47 CFR Part 2, Subpart J  
 FCC 47 CFR Part 15, Subpart C  
**Date of Receipt:** 2024/03/01  
**Date of Test:** 2024/03/06 to 2024/03/18  
**Date of Issue:** 2024/03/22

<b>Test Result :</b>	<b>PASS *</b>
----------------------	---------------

\* In the configuration tested, the EUT detailed in this report complied with the standards specified above.

Authorized Signature:

 Keny Xu  
 Laboratory Manager


Unless otherwise agreed in writing, this document is issued by the Company subject to its General Conditions of Service printed overleaf, available on request or accessible at <https://www.sgs.com/en/Terms-and-Conditions>. Attention is drawn to the limitation of liability, indemnification and jurisdiction issues defined therein. Any holder of this document is advised that information contained hereon reflects the Company's findings at the time of its intervention only and within the limits of Client's instructions, if any. The Company's sole responsibility is to its Client and this document does not exonerate parties to a transaction from exercising all their rights and obligations under the transaction documents. This document cannot be reproduced except in full, without prior written approval of the Company. Any unauthorized alteration, forgery or falsification of the content or appearance of this document is unlawful and offenders may be prosecuted to the fullest extent of the law. Unless otherwise stated the results shown in this test report refer only to the sample(s) tested and such sample(s) are retained for 30 days only.

Attention: To check the authenticity of testing /inspection report & certificate, please contact us at telephone: (86-755) 8307 1443, or email: CN.Doccheck@sgs.com

No.1 Workshop, M-10, Middle Section, Science & Technology Park, Nanshan District, Shenzhen, Guangdong, China 518057 t (86-755) 26012053 www.sgs.com.cn  
 中国·广东·深圳市南山区科技园中区M-10栋1号厂房 邮编: 518057 t (86-755) 26012053 sgs.china@sgs.com



# SGS-CSTC Standards Technical Services Co., Ltd. Shenzhen Branch

Report No.: SZCR240100035204  
Page: 2 of 115

## 1 Version

Revision Record				
Version	Chapter	Date	Modifier	Remark
01		2024/03/22		Original

Prepared By	 _____ (Jack Huang) / Test Engineer
Checked By	 _____ (Flora Wang) / Reviewer



SGS-CSTC Standards Technical Services Co., Ltd.  
Shenzhen Branch, Inspection & Testing Services

Unless otherwise agreed in writing, this document is issued by the Company subject to its General Conditions of Service printed overleaf, available on request or accessible at <https://www.sgs.com/en/Terms-and-Conditions>. Attention is drawn to the limitation of liability, indemnification and jurisdiction issues defined therein. Any holder of this document is advised that information contained hereon reflects the Company's findings at the time of its intervention only and within the limits of Client's instructions, if any. The Company's sole responsibility is to its Client and this document does not exonerate parties to a transaction from exercising all their rights and obligations under the transaction documents. This document cannot be reproduced except in full, without prior written approval of the Company. Any unauthorized alteration, forgery or falsification of the content or appearance of this document is unlawful and offenders may be prosecuted to the fullest extent of the law. Unless otherwise stated the results shown in this test report refer only to the sample(s) tested and such sample(s) are retained for 30 days only.  
Attention: To check the authenticity of testing /inspection report & certificate, please contact us at telephone: (86-755) 8307 1443, or email: CN.Doccheck@sgs.com

No.1 Workshop, M-10, Middle Section, Science & Technology Park, Nanshan District, Shenzhen, Guangdong, China 518057 t (86-755) 26012053 www.sgs.com.cn  
中国·广东·深圳市南山区科技园中区M-10栋1号厂房 邮编: 518057 t (86-755) 26012053 sgs.china@sgs.com



## 2 Test Summary

Test Item	FCC Rule No.	Test Method	Test Result	Result
Antenna Requirement	15.203/15.247(b)	--	Clause 4.1	PASS
AC Power Line Conducted Emission	15.207	ANSI C63.10 2013 Section 6.2	Clause 4.2	PASS
Duty Cycle	--	ANSI C63.10 2013 Section 11.6	Clause 4.3	For Report Purpose
Conducted Output Power	15.247 (b)(3)	ANSI C63.10 2013 Section 11.9.1.3	Clause 4.4	PASS
DTS (6 dB) Bandwidth & 99% Occupied Bandwidth	15.247 (a)(2)	ANSI C63.10 2013 Section 11.8 Option 2 / 6.9.3	Clause 4.5	PASS
Power Spectral Density	15.247 (e)	ANSI C63.10 2013 Section 11.10.2	Clause 4.6	PASS
Band-edge for RF Conducted Emissions	15.247(d)	ANSI C63.10 2013 Section 11.11	Clause 4.7	PASS
RF Conducted Spurious Emissions	15.247(d)	ANSI C63.10 2013 Section 11.11	Clause 4.8	PASS
Radiated Spurious Emissions	15.247(d);15.205/15.209	ANSI C63.10 2013 Section 11.12	Clause 4.9	PASS
Restricted bands around fundamental frequency (Radiated Emission)	15.247(d);15.205/15.209	ANSI C63.10 2013 Section 11.12	Clause 4.10	PASS



Unless otherwise agreed in writing, this document is issued by the Company subject to its General Conditions of Service printed overleaf, available on request or accessible at <https://www.sgs.com/en/Terms-and-Conditions>. Attention is drawn to the limitation of liability, indemnification and jurisdiction issues defined therein. Any holder of this document is advised that information contained hereon reflects the Company's findings at the time of its intervention only and within the limits of Client's instructions, if any. The Company's sole responsibility is to its Client and this document does not exonerate parties to a transaction from exercising all their rights and obligations under the transaction documents. This document cannot be reproduced except in full, without prior written approval of the Company. Any unauthorized alteration, forgery or falsification of the content or appearance of this document is unlawful and offenders may be prosecuted to the fullest extent of the law. Unless otherwise stated the results shown in this test report refer only to the sample(s) tested and such sample(s) are retained for 30 days only.

Attention: To check the authenticity of testing /inspection report & certificate, please contact us at telephone: (86-755) 8307 1443, or email: CN.Doccheck@sgs.com

No.1 Workshop, M-10, Middle Section, Science & Technology Park, Nanshan District, Shenzhen, Guangdong, China 518057 t (86-755) 26012053 www.sgs.com.cn  
 中国·广东·深圳市南山区科技园中区M-10栋1号厂房 邮编: 518057 t (86-755) 26012053 sgs.china@sgs.com



## Contents

1	Version .....	2
2	Test Summary .....	3
3	General Information .....	5
3.1	Details of Client .....	5
3.2	Test Location .....	5
3.3	Test Facility .....	5
3.4	General Description of EUT .....	6
3.5	Test Environment and Mode .....	8
3.6	Description of Support Units .....	8
4	Test results and Measurement Data .....	9
4.1	Antenna Requirement .....	9
4.2	AC Power Line Conducted Emissions .....	10
4.3	Duty Cycle .....	14
4.4	Conducted Output Power .....	15
4.5	DTS (6 dB) Bandwidth & 99% Occupied Bandwidth .....	16
4.6	Power Spectral Density .....	17
4.7	Band-edge for RF Conducted Emissions .....	18
4.8	RF Conducted Spurious Emissions .....	19
4.9	Radiated Spurious Emissions .....	20
4.10	Restricted bands around fundamental frequency .....	24
5	Measurement Uncertainty (95% confidence levels, k=2) .....	27
6	Equipment List .....	28
7	Photographs - EUT Constructional Details .....	30



Unless otherwise agreed in writing, this document is issued by the Company subject to its General Conditions of Service printed overleaf, available on request or accessible at <https://www.sgs.com/en/Terms-and-Conditions>. Attention is drawn to the limitation of liability, indemnification and jurisdiction issues defined therein. Any holder of this document is advised that information contained hereon reflects the Company's findings at the time of its intervention only and within the limits of Client's instructions, if any. The Company's sole responsibility is to its Client and this document does not exonerate parties to a transaction from exercising all their rights and obligations under the transaction documents. This document cannot be reproduced except in full, without prior written approval of the Company. Any unauthorized alteration, forgery or falsification of the content or appearance of this document is unlawful and offenders may be prosecuted to the fullest extent of the law. Unless otherwise stated the results shown in this test report refer only to the sample(s) tested and such sample(s) are retained for 30 days only.

Attention: To check the authenticity of testing /inspection report & certificate, please contact us at telephone: (86-755) 8307 1443, or email: [CN.Doccheck@sgs.com](mailto:CN.Doccheck@sgs.com)

SGS-CSTC Standards Technical Services Co., Ltd.  
Shenzhen Branch, Inspection & Testing Services  
Shenzhen Branch, Inspection & Testing Services

No.1 Workshop, M-10, Middle Section, Science & Technology Park, Nanshan District, Shenzhen, Guangdong, China 518057 t (86-755) 26012053 www.sgs.com.cn  
中国·广东·深圳市南山区科技园中区M-10栋1号厂房 邮编: 518057 t (86-755) 26012053 sgs.china@sgs.com



### 3 General Information

#### 3.1 Details of Client

Applicant:	Xiaomi Communications Co., Ltd.
Address of Applicant:	#019, 9th Floor, Building 6, 33 Xi'erqi Middle Road, Haidian District, Beijing, China
Manufacturer:	Xiaomi Communications Co., Ltd.
Address of Manufacturer:	#019, 9th Floor, Building 6, 33 Xi'erqi Middle Road, Haidian District, Beijing, China

#### 3.2 Test Location

Company:	SGS-CSTC Standards Technical Services Co., Ltd. Shenzhen Branch
Address:	No. 1 Workshop, M-10, Middle section, Science & Technology Park, Nanshan District, Shenzhen, Guangdong, China
Post code:	518057
Test engineer:	Jinhua Wei, Xing Guo

#### 3.3 Test Facility

The test facility is recognized, certified, or accredited by the following organizations:

- **A2LA (Certificate No. 3816.01)**

SGS-CSTC Standards Technical Services Co., Ltd. Shenzhen Branch is accredited by the American Association for Laboratory Accreditation(A2LA). Certificate No. 3816.01.

- **VCCI**

The 3m Fully-anechoic chamber for above 1GHz, 10m Semi-anechoic chamber for below 1GHz, Shielded Room for Mains Port Conducted Interference Measurement and Telecommunication Port Conducted Interference Measurement of SGS-CSTC Standards Technical Services Co., Ltd. have been registered in accordance with the Regulations for Voluntary Control Measures with Registration No.: G-20026, R-14188, C-12383 and T-11153 respectively.

- **Innovation, Science and Economic Development Canada**

SGS-CSTC Standards Technical Services Co., Ltd. Shenzhen Branch has been recognized by ISED as an accredited testing laboratory.

CAB identifier: CN0006.

IC#: 4620C.

- **FCC –Designation Number: CN1336**

SGS-CSTC Standards Technical Services Co., Ltd. Shenzhen Branch has been recognized as an accredited testing laboratory.

Designation Number: CN1336.

Test Firm Registration Number: 787754



Unless otherwise agreed in writing, this document is issued by the Company subject to its General Conditions of Service printed overleaf, available on request or accessible at <https://www.sgs.com/en/Terms-and-Conditions>. Attention is drawn to the limitation of liability, indemnification and jurisdiction issues defined therein. Any holder of this document is advised that information contained hereon reflects the Company's findings at the time of its intervention only and within the limits of Client's instructions, if any. The Company's sole responsibility is to its Client and this document does not exonerate parties to a transaction from exercising all their rights and obligations under the transaction documents. This document cannot be reproduced except in full, without prior written approval of the Company. Any unauthorized alteration, forgery or falsification of the content or appearance of this document is unlawful and offenders may be prosecuted to the fullest extent of the law. Unless otherwise stated the results shown in this test report refer only to the sample(s) tested and such sample(s) are retained for 30 days only.

Attention: To check the authenticity of testing /inspection report & certificate, please contact us at telephone: (86-755) 8307 1443, or email: CN.Doccheck@sgs.com

No.1 Workshop, M-10, Middle Section, Science & Technology Park, Nanshan District, Shenzhen, Guangdong, China 518057 t (86-755) 26012053 www.sgs.com.cn  
 中国·广东·深圳市南山区科技园中区M-10栋1号厂房 邮编: 518057 t (86-755) 26012053 sgs.china@sgs.com





# SGS-CSTC Standards Technical Services Co., Ltd. Shenzhen Branch

Report No.: SZCR240100035204  
Page: 6 of 115

## 3.4 General Description of EUT

EUT Description:	Mobile Phone	
Model No.:	24049RN28L	
Trade Mark:	Redmi	
Hardware Version:	1351N19A	
Software Version:	Xiaomi HyperOS 1.0	
Power Supply:	DC 3.84V from internal rechargeable battery which can be charged by AC/DC adapter.	
IMEI:	RF Conducted	IMEI1:867585070034121 IMEI2:867585070034139
	RSE & AC power line	IMEI1:867585070033800 IMEI2:867585070033818
Operation Frequency:	802.11b/g/n(HT20):	2412MHz to 2462MHz
Modulation Type:	802.11b:	DSSS (DBPSK, DQPSK, CCK)
	802.11g/n:	OFDM (BPSK, QPSK, 16QAM, 64QAM)
Number of Channels:	802.11b/g/n(HT20): 11	
Channel Spacing:	5MHz	
Smart System:	<input checked="" type="checkbox"/> SISO	802.11b/g/n
	<input type="checkbox"/> MIMO	CDD: 802.11b/g/n: Tx & Rx
		STBC: 802.11n: Tx & Rx
	<input type="checkbox"/> Diversity	TXBF: 802.11n: Tx & Rx
	<input type="checkbox"/> Diversity	802.11b/g : Tx & Rx
Antenna Type:	PIFA Antenna	
Antenna Gain:	-0.8dBi(Ant7)	
	Note: The antenna gain are derived from the gain information report provided by the manufacturer.	
RF Cable:	2000MHz ~ 3000MHz (1.1dB)	
Remark:	As above information is provided and confirmed by the applicant. SGS is not liable to the accuracy, suitability, reliability or/and integrity of the information.	



Unless otherwise agreed in writing, this document is issued by the Company subject to its General Conditions of Service printed overleaf, available on request or accessible at <https://www.sgs.com/en/Terms-and-Conditions>. Attention is drawn to the limitation of liability, indemnification and jurisdiction issues defined therein. Any holder of this document is advised that information contained hereon reflects the Company's findings at the time of its intervention only and within the limits of Client's instructions, if any. The Company's sole responsibility is to its Client and this document does not exonerate parties to a transaction from exercising all their rights and obligations under the transaction documents. This document cannot be reproduced except in full, without prior written approval of the Company. Any unauthorized alteration, forgery or falsification of the content or appearance of this document is unlawful and offenders may be prosecuted to the fullest extent of the law. Unless otherwise stated the results shown in this test report refer only to the sample(s) tested and such sample(s) are retained for 30 days only.  
Attention: To check the authenticity of testing /inspection report & certificate, please contact us at telephone: (86-755) 8307 1443, or email: CN.Doccheck@sgs.com

No.1 Workshop, M-10, Middle Section, Science & Technology Park, Nanshan District, Shenzhen, Guangdong, China 518057 t (86-755) 26012053 www.sgs.com.cn  
中国·广东·深圳市南山区科技园中区M-10栋1号厂房 邮编: 518057 t (86-755) 26012053 sgs.china@sgs.com



# SGS-CSTC Standards Technical Services Co., Ltd. Shenzhen Branch

Report No.: SZCR240100035204  
Page: 7 of 115

Operation Frequency of each channel (802.11b/g/n HT20)							
Channel	Frequency	Channel	Frequency	Channel	Frequency	Channel	Frequency
1	2412MHz	4	2427MHz	7	2442MHz	10	2457MHz
2	2417MHz	5	2432MHz	8	2447MHz	11	2462MHz
3	2422MHz	6	2437MHz	9	2452MHz		

Remark:  
In section 15.31(m), regards to the operating frequency range over 10 MHz, the Lowest frequency, the middle frequency, and the highest frequency of channel were selected to perform the test, and the selected channel see below:

Channel	Frequency for 802.11 b/g/n (HT20)
The Lowest channel	2412MHz
The Middle channel	2437MHz
The Highest channel	2462MHz



Unless otherwise agreed in writing, this document is issued by the Company subject to its General Conditions of Service printed overleaf, available on request or accessible at <https://www.sgs.com/en/Terms-and-Conditions>. Attention is drawn to the limitation of liability, indemnification and jurisdiction issues defined therein. Any holder of this document is advised that information contained hereon reflects the Company's findings at the time of its intervention only and within the limits of Client's instructions, if any. The Company's sole responsibility is to its Client and this document does not exonerate parties to a transaction from exercising all their rights and obligations under the transaction documents. This document cannot be reproduced except in full, without prior written approval of the Company. Any unauthorized alteration, forgery or falsification of the content or appearance of this document is unlawful and offenders may be prosecuted to the fullest extent of the law. Unless otherwise stated the results shown in this test report refer only to the sample(s) tested and such sample(s) are retained for 30 days only.

Attention: To check the authenticity of testing /inspection report & certificate, please contact us at telephone: (86-755) 8307 1443, or email: CN.Doccheck@sgs.com

SGS-CSTC Standards Technical Services Co., Ltd.  
Shenzhen Branch, Wireless Laboratory

No.1 Workshop, M-10, Middle Section, Science & Technology Park, Nanshan District, Shenzhen, Guangdong, China 518057 t (86-755) 26012053 www.sgs.com.cn  
中国·广东·深圳市南山区科技园中区M-10栋1号厂房 邮编: 518057 t (86-755) 26012053 sgs.china@sgs.com



### 3.5 Test Environment and Mode

Environment Parameter	101 kPa Selected Values During Tests	
Relative Humidity	44-46 % RH Ambient	
Value	Temperature(°C)	Voltage(V)
NTNV	22~23	3.84
Remark: NV: Normal Voltage NT: Normal Temperature		

### 3.6 Description of Support Units

The EUT has been tested as an independent unit.

### 3.7 Worst-case configuration and mode

Low data rate was used to test on antenna port conducted tests and radiated spurious emissions since it has the highest maximum power. Following are the worst-case data rates set for test:

Modulation Type	SISO - Data Rate	MIMO - Data Rate
802.11b	1 Mbps	/
802.11g	6 Mbps	/
802.11n (HT 20)	MCS0 (6.5 Mbps)	/



Unless otherwise agreed in writing, this document is issued by the Company subject to its General Conditions of Service printed overleaf, available on request or accessible at <https://www.sgs.com/en/Terms-and-Conditions>. Attention is drawn to the limitation of liability, indemnification and jurisdiction issues defined therein. Any holder of this document is advised that information contained hereon reflects the Company's findings at the time of its intervention only and within the limits of Client's instructions, if any. The Company's sole responsibility is to its Client and this document does not exonerate parties to a transaction from exercising all their rights and obligations under the transaction documents. This document cannot be reproduced except in full, without prior written approval of the Company. Any unauthorized alteration, forgery or falsification of the content or appearance of this document is unlawful and offenders may be prosecuted to the fullest extent of the law. Unless otherwise stated the results shown in this test report refer only to the sample(s) tested and such sample(s) are retained for 30 days only.

Attention: To check the authenticity of testing /inspection report & certificate, please contact us at telephone: (86-755) 8307 1443, or email: CN.Doccheck@sgs.com

No.1 Workshop, M-10, Middle Section, Science & Technology Park, Nanshan District, Shenzhen, Guangdong, China 518057 t (86-755) 26012053 www.sgs.com.cn  
 中国·广东·深圳市南山区科技园中区M-10栋1号厂房 邮编: 518057 t (86-755) 26012053 sgs.china@sgs.com





## 4 Test results and Measurement Data

### 4.1 Antenna Requirement

<b>Standard requirement:</b>	47 CFR Part 15C Section 15.203 /247(b)
<p>15.203 requirement:          An intentional radiator shall be designed to ensure that no antenna other than that furnished by the responsible party shall be used with the device. The use of a permanently attached antenna or of an antenna that uses a unique coupling to the intentional radiator, the manufacturer may design the unit so that a broken antenna can be replaced by the user, but the use of a standard antenna jack or electrical connector is prohibited.</p> <p>15.247(b) (4) requirement:          The conducted output power limit specified in paragraph (b) of this section is based on the use of antennas with directional gains that do not exceed 6 dBi. Except as shown in paragraph (c) of this section, if transmitting antennas of directional gain greater than 6 dBi are used, the conducted output power from the intentional radiator shall be reduced below the stated values in paragraphs (b)(1), (b)(2), and (b)(3) of this section, as appropriate, by the amount in dB that the directional gain of the antenna exceeds 6 dBi.</p>	
<p>The antenna is PIFA Antenna and no consideration of replacement. The best case gain of the antenna is -0.8dBi(Ant7)*.</p> <p><i>*Note:</i>  <i>The antenna gain are derived from the gain information report provided by the manufacturer.</i></p> <p><i>Remark:</i>  <i>As above information is provided and confirmed by the applicant. SGS is not liable to the accuracy, suitability, reliability or/and integrity of the information.</i></p>	



Unless otherwise agreed in writing, this document is issued by the Company subject to its General Conditions of Service printed overleaf, available on request or accessible at <https://www.sgs.com/en/Terms-and-Conditions>. Attention is drawn to the limitation of liability, indemnification and jurisdiction issues defined therein. Any holder of this document is advised that information contained hereon reflects the Company's findings at the time of its intervention only and within the limits of Client's instructions, if any. The Company's sole responsibility is to its Client and this document does not exonerate parties to a transaction from exercising all their rights and obligations under the transaction documents. This document cannot be reproduced except in full, without prior written approval of the Company. Any unauthorized alteration, forgery or falsification of the content or appearance of this document is unlawful and offenders may be prosecuted to the fullest extent of the law. Unless otherwise stated the results shown in this test report refer only to the sample(s) tested and such sample(s) are retained for 30 days only.

**Attention:** To check the authenticity of testing /inspection report & certificate, please contact us at telephone: (86-755) 8307 1443, or email: [CN.Doccheck@sgs.com](mailto:CN.Doccheck@sgs.com)

No.1 Workshop, M-10, Middle Section, Science & Technology Park, Nanshan District, Shenzhen, Guangdong, China 518057 t (86-755) 26012053 www.sgs.com.cn  
 中国·广东·深圳市南山区科技园中区M-10栋1号厂房 邮编: 518057 t (86-755) 26012053 sgs.china@sgs.com



## 4.2 AC Power Line Conducted Emissions

Test Requirement:	47 CFR Part 15C Section 15.207		
Test Method:	ANSI C63.10: 2013 Section 6.2		
Test Frequency Range:	150kHz to 30MHz		
Receiver Setup:	RBW = 9kHz, VBW = 30kHz		
Limit:	Frequency range (MHz)	Limit (dBuV)	
		Quasi-peak	Average
	0.15-0.5	66 to 56*	56 to 46*
	0.5-5	56	46
	5-30	60	50
	* Decreases with the logarithm of the frequency.		
Test Procedure:	<p>1) The mains terminal disturbance voltage test was conducted in a shielded room.</p> <p>2) The EUT was connected to AC power source through a LISN 1 (Line Impedance Stabilization Network) which provides a 50Ω/50μH + 5Ω linear impedance. The power cables of all other units of the EUT were connected to a second LISN 2, which was bonded to the ground reference plane in the same way as the LISN 1 for the unit being measured. A multiple socket outlet strip was used to connect multiple power cables to a single LISN provided the rating of the LISN was not exceeded.</p> <p>3) The tabletop EUT was placed upon a non-metallic table 0.8m above the ground reference plane. And for floor-standing arrangement, the EUT was placed on the horizontal ground reference plane,</p> <p>4) The test was performed with a vertical ground reference plane. The rear of the EUT shall be 0.4 m from the vertical ground reference plane. The vertical ground reference plane was bonded to the horizontal ground reference plane. The LISN 1 was placed 0.8 m from the boundary of the unit under test and bonded to a ground reference plane for LISNs mounted on top of the ground reference plane. This distance was between the closest points of the LISN 1 and the EUT. All other units of the EUT and associated equipment was at least 0.8 m from the LISN 2. In order to find the maximum emission, the relative positions of equipment and all of the interface cables must be changed according to ANSI C63.10: 2013 on conducted measurement.</p>		



Unless otherwise agreed in writing, this document is issued by the Company subject to its General Conditions of Service printed overleaf, available on request or accessible at <https://www.sgs.com/en/Terms-and-Conditions>. Attention is drawn to the limitation of liability, indemnification and jurisdiction issues defined therein. Any holder of this document is advised that information contained hereon reflects the Company's findings at the time of its intervention only and within the limits of Client's instructions, if any. The Company's sole responsibility is to its Client and this document does not exonerate parties to a transaction from exercising all their rights and obligations under the transaction documents. This document cannot be reproduced except in full, without prior written approval of the Company. Any unauthorized alteration, forgery or falsification of the content or appearance of this document is unlawful and offenders may be prosecuted to the fullest extent of the law. Unless otherwise stated the results shown in this test report refer only to the sample(s) tested and such sample(s) are retained for 30 days only.

Attention: To check the authenticity of testing /inspection report & certificate, please contact us at telephone: (86-755) 8307 1443, or email: [CN.Doccheck@sgs.com](mailto:CN.Doccheck@sgs.com)



# SGS-CSTC Standards Technical Services Co., Ltd. Shenzhen Branch

Report No.: SZCR240100035204  
Page: 11 of 115

Test Setup:	
Exploratory Test Mode:	Transmitting with all kind of modulations, data rates at lowest, middle and highest channel. Charge + Transmitting mode.
Final Test Mode:	Refer to section 3.7 for details. Only the worst case is recorded in the report.
Instruments Used:	Refer to section 6 for details.
Test Results:	Pass



SGS-CSTC Standards Technical Services Co., Ltd.  
Shenzhen Branch

Unless otherwise agreed in writing, this document is issued by the Company subject to its General Conditions of Service printed overleaf, available on request or accessible at <https://www.sgs.com/en/Terms-and-Conditions>. Attention is drawn to the limitation of liability, indemnification and jurisdiction issues defined therein. Any holder of this document is advised that information contained hereon reflects the Company's findings at the time of its intervention only and within the limits of Client's instructions, if any. The Company's sole responsibility is to its Client and this document does not exonerate parties to a transaction from exercising all their rights and obligations under the transaction documents. This document cannot be reproduced except in full, without prior written approval of the Company. Any unauthorized alteration, forgery or falsification of the content or appearance of this document is unlawful and offenders may be prosecuted to the fullest extent of the law. Unless otherwise stated the results shown in this test report refer only to the sample(s) tested and such sample(s) are retained for 30 days only.  
**Attention: To check the authenticity of testing /inspection report & certificate, please contact us at telephone: (86-755) 8307 1443, or email: CN.Doccheck@sgs.com**

No.1 Workshop, M-10, Middle Section, Science & Technology Park, Nanshan District, Shenzhen, Guangdong, China 518057 t (86-755) 26012053 www.sgs.com.cn  
中国·广东·深圳市南山区科技园中区M-10栋1号厂房 邮编: 518057 t (86-755) 26012053 sgs.china@sgs.com

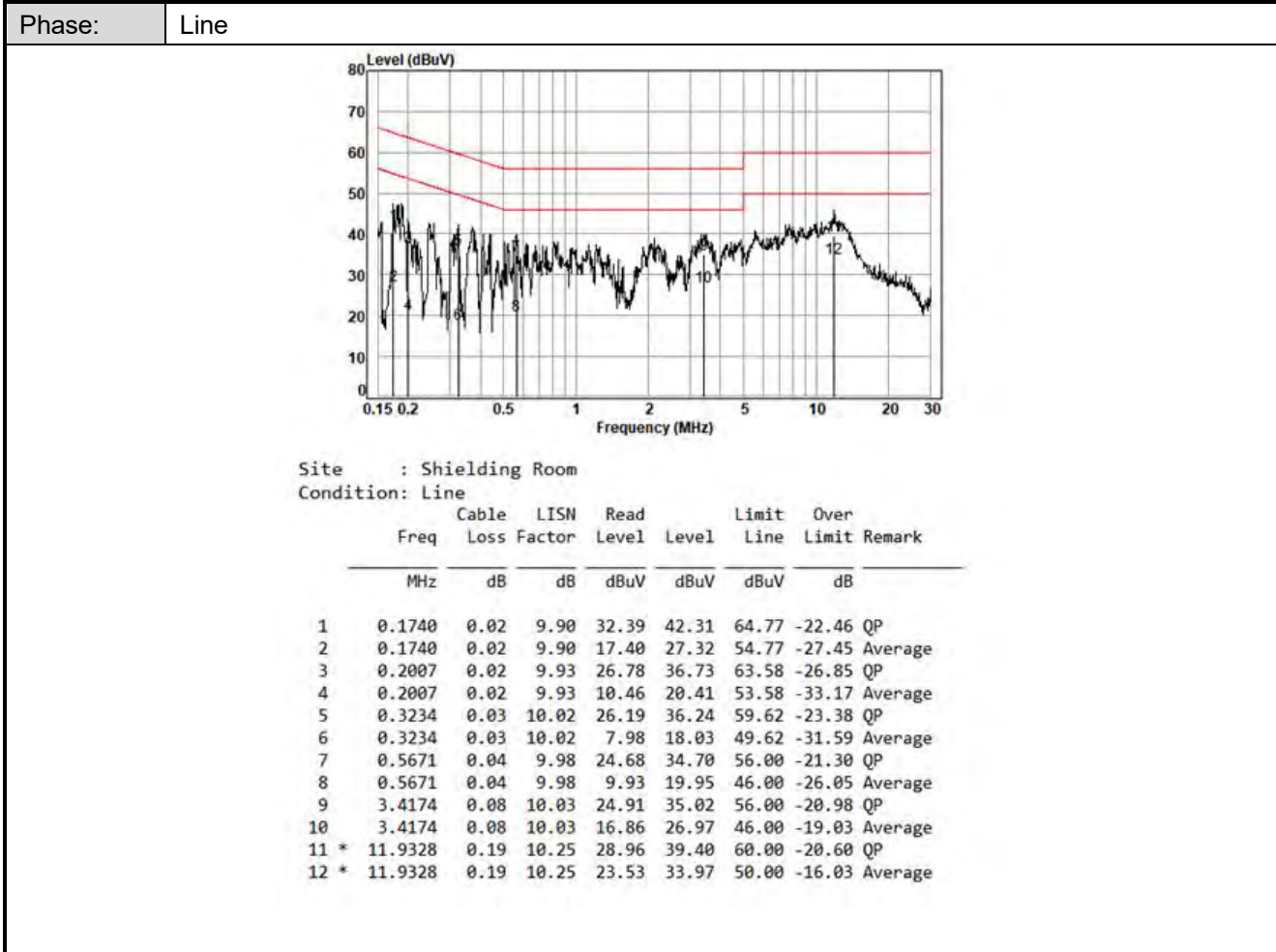


**SGS-CSTC Standards Technical Services Co., Ltd.**  
**Shenzhen Branch**

Report No.: SZCR240100035204  
 Page: 12 of 115

Measurement Data

An initial pre-scan was performed on the live and neutral lines with peak detector. Quasi-Peak and Average measurement were performed at the frequencies with maximized peak emission were detected.



Unless otherwise agreed in writing, this document is issued by the Company subject to its General Conditions of Service printed overleaf, available on request or accessible at <https://www.sgs.com/en/Terms-and-Conditions>. Attention is drawn to the limitation of liability, indemnification and jurisdiction issues defined therein. Any holder of this document is advised that information contained hereon reflects the Company's findings at the time of its intervention only and within the limits of Client's instructions, if any. The Company's sole responsibility is to its Client and this document does not exonerate parties to a transaction from exercising all their rights and obligations under the transaction documents. This document cannot be reproduced except in full, without prior written approval of the Company. Any unauthorized alteration, forgery or falsification of the content or appearance of this document is unlawful and offenders may be prosecuted to the fullest extent of the law. Unless otherwise stated the results shown in this test report refer only to the sample(s) tested and such sample(s) are retained for 30 days only.

Attention: To check the authenticity of testing /inspection report & certificate, please contact us at telephone: (86-755) 8307 1443, or email: CN.Doccheck@sgs.com

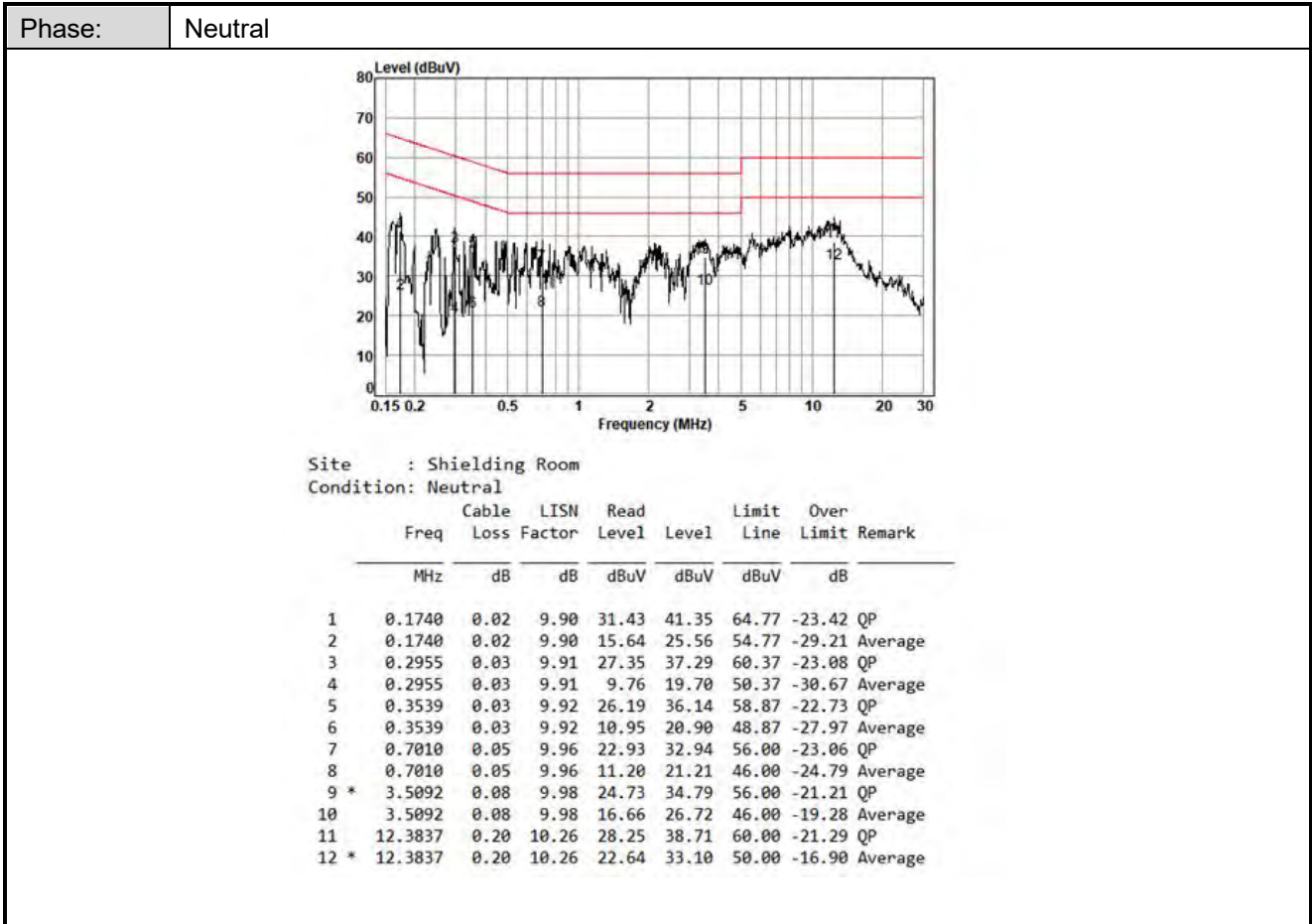
No.1 Workshop, M-10, Middle Section, Science & Technology Park, Nanshan District, Shenzhen, Guangdong, China 518057 t (86-755) 26012053 www.sgs.com.cn  
 中国·广东·深圳市南山区科技园中区M-10栋1号厂房 邮编: 518057 t (86-755) 26012053 sgs.china@sgs.com





**SGS-CSTC Standards Technical Services Co., Ltd.**  
**Shenzhen Branch**

Report No.: SZCR240100035204  
 Page: 13 of 115



Unless otherwise agreed in writing, this document is issued by the Company subject to its General Conditions of Service printed overleaf, available on request or accessible at <https://www.sgs.com/en/Terms-and-Conditions>. Attention is drawn to the limitation of liability, indemnification and jurisdiction issues defined therein. Any holder of this document is advised that information contained hereon reflects the Company's findings at the time of its intervention only and within the limits of Client's instructions, if any. The Company's sole responsibility is to its Client and this document does not exonerate parties to a transaction from exercising all their rights and obligations under the transaction documents. This document cannot be reproduced except in full, without prior written approval of the Company. Any unauthorized alteration, forgery or falsification of the content or appearance of this document is unlawful and offenders may be prosecuted to the fullest extent of the law. Unless otherwise stated the results shown in this test report refer only to the sample(s) tested and such sample(s) are retained for 30 days only.  
 Attention: To check the authenticity of testing /inspection report & certificate, please contact us at telephone: (86-755) 8307 1443, or email: CN.Doccheck@sgs.com

No.1 Workshop, M-10, Middle Section, Science & Technology Park, Nanshan District, Shenzhen, Guangdong, China 518057 t (86-755) 26012053 www.sgs.com.cn  
 中国·广东·深圳市南山区科技园中区M-10栋1号厂房 邮编: 518057 t (86-755) 26012053 sgs.china@sgs.com





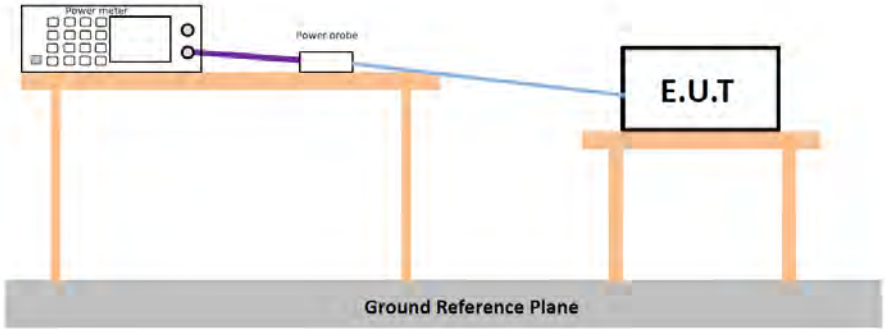
### 4.3 Duty Cycle

Test Requirement:	ANSI C63.10 :2013 Section 11.6
Test Method:	ANSI C63.10 :2013 Section 11.6
Test Setup:	
Instruments Used:	Refer to section 6 for details
Exploratory Test Mode:	Transmitting with all kind of modulations, data rates
Final Test Mode:	Refer to section 3.7 for details.
Limit:	No restriction limits
Test Results:	For Report Purpose
The detailed test data see: <b>Appendix</b>	





#### 4.4 Conducted Output Power

Test Requirement:	47 CFR Part 15C Section 15.247 (b)(3)
Test Method:	ANSI C63.10 :2013 Section 11.9.1.3
Test Setup:	 <p>* Test with power meter (Detector function: Peak)</p>
Test Instruments:	Refer to section 6 for details.
Exploratory Test Mode:	Transmitting with all kind of modulations, data rates
Final Test Mode:	Refer to section 3.7 for details.
Limit:	30dBm
Test Results:	Pass
The detailed test data see: <b>Appendix</b>	





# SGS-CSTC Standards Technical Services Co., Ltd. Shenzhen Branch

Report No.: SZCR240100035204  
Page: 16 of 115

## 4.5 DTS (6 dB) Bandwidth & 99% Occupied Bandwidth

Test Requirement:	47 CFR Part 15C Section 15.247 (a)(2)
Test Method:	ANSI C63.10: 2013 Section 11.8 Option 2 / 6.9.3
Test Setup:	
Instruments Used:	Refer to section 6 for details.
Exploratory Test Mode:	Transmitting with all kind of modulations, data rates
Final Test Mode:	Refer to section 3.7 for details.
Limit:	≥ 500 kHz for DTS Bandwidth
Test Results:	Pass
The detailed test data see: <b>Appendix</b>	



SGS-CSTC Standards Technical Services Co., Ltd.  
Shenzhen Branch, Inspection & Testing Services

Unless otherwise agreed in writing, this document is issued by the Company subject to its General Conditions of Service printed overleaf, available on request or accessible at <https://www.sgs.com/en/Terms-and-Conditions>. Attention is drawn to the limitation of liability, indemnification and jurisdiction issues defined therein. Any holder of this document is advised that information contained hereon reflects the Company's findings at the time of its intervention only and within the limits of Client's instructions, if any. The Company's sole responsibility is to its Client and this document does not exonerate parties to a transaction from exercising all their rights and obligations under the transaction documents. This document cannot be reproduced except in full, without prior written approval of the Company. Any unauthorized alteration, forgery or falsification of the content or appearance of this document is unlawful and offenders may be prosecuted to the fullest extent of the law. Unless otherwise stated the results shown in this test report refer only to the sample(s) tested and such sample(s) are retained for 30 days only.  
**Attention: To check the authenticity of testing /inspection report & certificate, please contact us at telephone: (86-755) 8307 1443, or email: CN.Doccheck@sgs.com**

No.1 Workshop, M-10, Middle Section, Science & Technology Park, Nanshan District, Shenzhen, Guangdong, China 518057 t (86-755) 26012053 www.sgs.com.cn  
中国·广东·深圳市南山区科技园中区M-10栋1号厂房 邮编: 518057 t (86-755) 26012053 sgs.china@sgs.com



#### 4.6 Power Spectral Density

Test Requirement:	47 CFR Part 15C Section 15.247 (e)
Test Method:	ANSI C63.10 :2013 Section 11.10.2
Test Setup:	
Test Instruments:	Refer to section 6 for details.
Exploratory Test Mode:	Transmitting with all kind of modulations, data rates
Final Test Mode:	Refer to section 3.7 for details.
Limit:	$\leq 8.00\text{dBm}/3\text{kHz}$
Test Results:	Pass
The detailed test data see: <b>Appendix</b>	







#### 4.7 Band-edge for RF Conducted Emissions

Test Requirement:	47 CFR Part 15C Section 15.247 (d)
Test Method:	ANSI C63.10: 2013 Section 11.11
Test Setup:	
Instruments Used:	Refer to section 6 for details.
Exploratory Test Mode:	Transmitting with all kind of modulations, data rates
Final Test Mode:	Refer to section 3.7 for details.
Limit:	In any 100 kHz bandwidth outside the frequency band in which the spread spectrum intentional radiator is operating, the radio frequency power that is produced by the intentional radiator shall be at least 20 dB below that in the 100 kHz bandwidth within the band that contains the highest level of the desired power, based on either an RF conducted or a radiated measurement.
Test Results:	Pass
The detailed test data see: <b>Appendix</b>	







#### 4.8 RF Conducted Spurious Emissions

Test Requirement:	47 CFR Part 15C Section 15.247 (d)
Test Method:	ANSI C63.10: 2013 Section 11.11
Test Setup:	
Instruments Used:	Refer to section 6 for details.
Exploratory Test Mode:	Transmitting with all kind of modulations, data rates
Final Test Mode:	Refer to section 3.7 for details.
Limit:	In any 100 kHz bandwidth outside the frequency band in which the spread spectrum intentional radiator is operating, the radio frequency power that is produced by the intentional radiator shall be at least 20 dB below that in the 100 kHz bandwidth within the band that contains the highest level of the desired power, based on either an RF conducted or a radiated measurement.
Test Results:	Pass
The detailed test data see: <b>Appendix</b>	





# SGS-CSTC Standards Technical Services Co., Ltd. Shenzhen Branch

Report No.: SZCR240100035204  
Page: 20 of 115

## 4.9 Radiated Spurious Emissions

Test Requirement:	47 CFR Part 15C Section 15.209 and 15.205				
Test Method:	ANSI C63.10 :2013 Section 11.12				
Test Site:	Measurement Distance: 3m (Semi-Anechoic Chamber)				
Test Frequency:	9kHz ~ 25GHz				
Receiver Setup:	Frequency	Detector	RBW	VBW	Remark
	0.009MHz-0.090MHz	Peak	10kHz	30kHz	Peak
	0.009MHz-0.090MHz	Average	10kHz	30kHz	Average
	0.090MHz-0.110MHz	Quasi-peak	10kHz	30kHz	Quasi-peak
	0.110MHz-0.490MHz	Peak	10kHz	30kHz	Peak
	0.110MHz-0.490MHz	Average	10kHz	30kHz	Average
	0.490MHz -30MHz	Quasi-peak	10kHz	30kHz	Quasi-peak
	30MHz-1GHz	Quasi-peak	120kHz	300kHz	Quasi-peak
Above 1GHz	Peak	1MHz	3MHz	Peak	
	Peak	1MHz	3MHz	Peak	
Limit:	Frequency	Field strength (microvolt/meter)	Limit (dBuV/m)	Remark	Measurement distance (m)
	0.009MHz-0.490MHz	2400/F(kHz)	-	-	300
	0.490MHz-1.705MHz	24000/F(kHz)	-	-	30
	1.705MHz-30MHz	30	-	-	30
	30MHz-88MHz	100	40.0	Quasi-peak	3
	88MHz-216MHz	150	43.5	Quasi-peak	3
	216MHz-960MHz	200	46.0	Quasi-peak	3
	960MHz-1GHz	500	54.0	Quasi-peak	3
	Above 1GHz	500	54.0	Average	3
Remark: 15.35(b), Unless otherwise specified, the limit on peak radio frequency emissions is 20dB above the maximum permitted average emission limit applicable to the equipment under test. This peak limit applies to the total peak emission level radiated by the device.					



Unless otherwise agreed in writing, this document is issued by the Company subject to its General Conditions of Service printed overleaf, available on request or accessible at <https://www.sgs.com/en/Terms-and-Conditions>. Attention is drawn to the limitation of liability, indemnification and jurisdiction issues defined therein. Any holder of this document is advised that information contained hereon reflects the Company's findings at the time of its intervention only and within the limits of Client's instructions, if any. The Company's sole responsibility is to its Client and this document does not exonerate parties to a transaction from exercising all their rights and obligations under the transaction documents. This document cannot be reproduced except in full, without prior written approval of the Company. Any unauthorized alteration, forgery or falsification of the content or appearance of this document is unlawful and offenders may be prosecuted to the fullest extent of the law. Unless otherwise stated the results shown in this test report refer only to the sample(s) tested and such sample(s) are retained for 30 days only.

Attention: To check the authenticity of testing /inspection report & certificate, please contact us at telephone: (86-755) 8307 1443, or email: CN.Doccheck@sgs.com

No.1 Workshop, M-10, Middle Section, Science & Technology Park, Nanshan District, Shenzhen, Guangdong, China 518057 t (86-755) 26012053 www.sgs.com.cn  
中国·广东·深圳市南山区科技园中区M-10栋1号厂房 邮编: 518057 t (86-755) 26012053 sgs.china@sgs.com

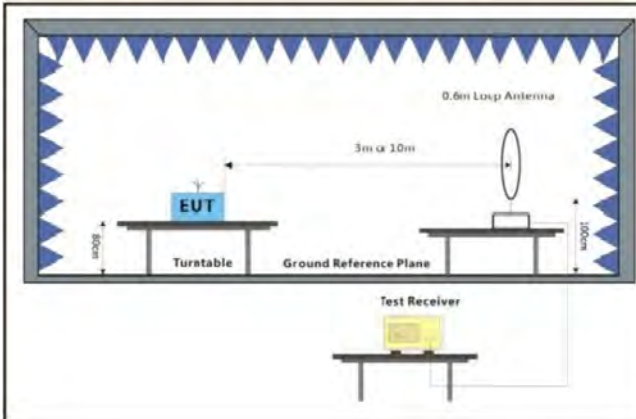
**Test Setup:**


Figure 1. Below 30MHz

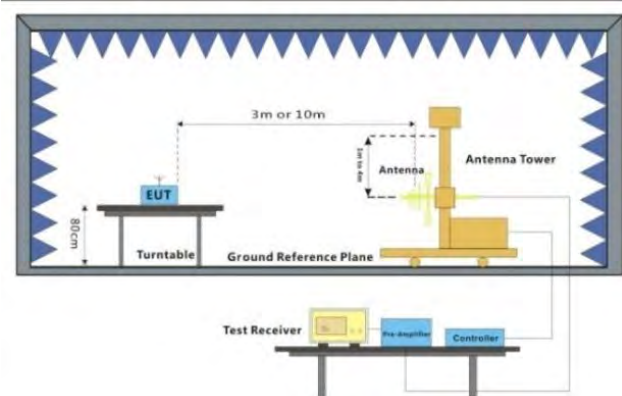


Figure 2. 30MHz to 1GHz

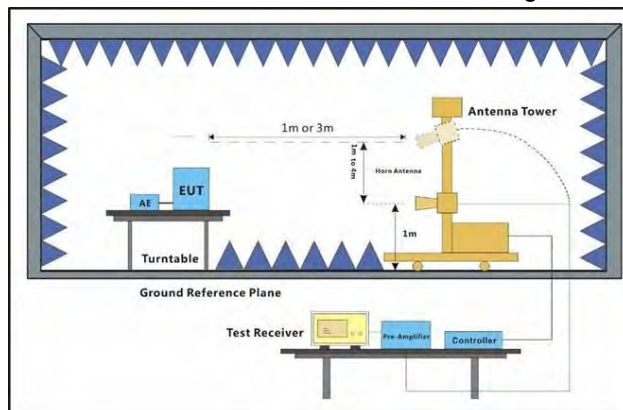


Figure 3. Above 1 GHz

**Test Procedure:**

- For below 1GHz, the EUT was placed on the top of a rotating table 0.8 meters above the ground at a 3 or 10 meter semi-anechoic chamber. The table was rotated 360 degrees to determine the position of the highest radiation.
- For above 1GHz, the EUT was placed on the top of a rotating table 1.5 meters above the ground at a 3 meter semi-anechoic chamber. The table was rotated 360 degrees to determine the position of the highest radiation (Distance from antenna to EUT is 1m for measurements >18GHz).
- The EUT was set 3 or 10 meters away from the interference-receiving antenna, which was mounted on the top of a variable-height antenna tower.
- The antenna height is varied from one meter to four meters above the ground to determine the maximum value of the field strength. Both horizontal and vertical polarizations of the antenna are set to make the measurement.
- For each suspected emission, the EUT was arranged to its worst case and then the antenna was tuned to heights from 1 meter to 4 meters (for the test frequency of below 30MHz, the antenna was tuned to heights 1 meter) and the rotatable table was turned from 0 degrees to 360 degrees to find the





# SGS-CSTC Standards Technical Services Co., Ltd. Shenzhen Branch

Report No.: SZCR240100035204  
Page: 22 of 115

	<p>maximum reading.</p> <p>f. The test-receiver system was set to Peak Detect Function and Specified Bandwidth with Maximum Hold Mode.</p> <p>g. Test the EUT in the lowest channel, the middle channel ,the Highest channel.</p> <p>h. The radiation measurements are performed in X, Y, Z axis positioning for Transmitting mode, And found the Z axis positioning which it is worse case.</p> <p>i. Repeat above procedures until all frequencies measured was complete.</p> <p>j. The low frequency, which started from 9 kHz to 30MHz, was pre-scanned and the result which was 20dB lower than the limit line was not reported</p> <p>k. The disturbance above 18GHz was very low, and the harmonics were the highest point could be found when testing, so only the harmonics had been displayed.</p> <p>l. At a measurement distance of 1 meter the limit line was increased by <math>20 \cdot \text{LOG}(3/1) = 9.54 \text{ dB}</math>.</p>
Test Configuration:	<p>Measurements below 30MHz</p> <ul style="list-style-type: none"> <li>• RBW = 10 kHz</li> <li>• VBW = 30 kHz</li> <li>• Detector = Peak &amp; Average &amp; Quasi-peak</li> <li>• Trace mode = max hold</li> </ul> <p>Measurements Below 1000MHz</p> <ul style="list-style-type: none"> <li>• RBW = 120 kHz</li> <li>• VBW = 300 kHz</li> <li>• Detector = Quasi-peak</li> <li>• Trace mode = max hold</li> </ul> <p>Peak Measurements Above 1000 MHz</p> <ul style="list-style-type: none"> <li>• RBW = 1 MHz</li> <li>• VBW <math>\geq 3 \text{ MHz}</math></li> <li>• Detector = Peak</li> <li>• Sweep time = auto</li> <li>• Trace mode = max hold</li> </ul> <p>Average Measurements Above 1000MHz</p> <ul style="list-style-type: none"> <li>• RBW = 1 MHz</li> <li>• VBW = 10 Hz, when duty cycle is no less than 98 percent.</li> <li>• VBW <math>\geq 1/T</math>, when duty cycle is less than 98 percent where T is the minimum transmission duration over which the transmitter is on and is transmitting at its maximum power control level for the tested mode of operation.</li> </ul>
Exploratory Test Mode:	<p>Transmitting with all kind of modulations, data rates.</p> <p>Charge + Transmitting mode.</p>
Final Test Mode:	<p>Refer to section 3.7 for details.</p> <p>For below 1GHz part, through pre-scan all channels, but only the worst case is recorded in the report.</p>
Instruments Used:	Refer to section 6 for details.
Test Results:	Pass



SGS-CSTC Standards Technical Services Co., Ltd.  
Shenzhen Branch, Wireless Laboratory

Unless otherwise agreed in writing, this document is issued by the Company subject to its General Conditions of Service printed overleaf, available on request or accessible at <https://www.sgs.com/en/Terms-and-Conditions>. Attention is drawn to the limitation of liability, indemnification and jurisdiction issues defined therein. Any holder of this document is advised that information contained hereon reflects the Company's findings at the time of its intervention only and within the limits of Client's instructions, if any. The Company's sole responsibility is to its Client and this document does not exonerate parties to a transaction from exercising all their rights and obligations under the transaction documents. This document cannot be reproduced except in full, without prior written approval of the Company. Any unauthorized alteration, forgery or falsification of the content or appearance of this document is unlawful and offenders may be prosecuted to the fullest extent of the law. Unless otherwise stated the results shown in this test report refer only to the sample(s) tested and such sample(s) are retained for 30 days only.

Attention: To check the authenticity of testing /inspection report & certificate, please contact us at telephone: (86-755) 8307 1443, or email: [CN.Doccheck@sgs.com](mailto:CN.Doccheck@sgs.com)

No.1 Workshop, M-10, Middle Section, Science & Technology Park, Nanshan District, Shenzhen, Guangdong, China 518057 t (86-755) 26012053 www.sgsgroup.com.cn  
中国·广东·深圳市南山区科技园中区M-10栋1号厂房 邮编: 518057 t (86-755) 26012053 sgs.china@sgs.com



# SGS-CSTC Standards Technical Services Co., Ltd. Shenzhen Branch

Report No.: SZCR240100035204  
Page: 23 of 115

The detailed test data see: **Appendix**



Unless otherwise agreed in writing, this document is issued by the Company subject to its General Conditions of Service printed overleaf, available on request or accessible at <https://www.sgs.com/en/Terms-and-Conditions>. Attention is drawn to the limitation of liability, indemnification and jurisdiction issues defined therein. Any holder of this document is advised that information contained hereon reflects the Company's findings at the time of its intervention only and within the limits of Client's instructions, if any. The Company's sole responsibility is to its Client and this document does not exonerate parties to a transaction from exercising all their rights and obligations under the transaction documents. This document cannot be reproduced except in full, without prior written approval of the Company. Any unauthorized alteration, forgery or falsification of the content or appearance of this document is unlawful and offenders may be prosecuted to the fullest extent of the law. Unless otherwise stated the results shown in this test report refer only to the sample(s) tested and such sample(s) are retained for 30 days only.

Attention: To check the authenticity of testing /inspection report & certificate, please contact us at telephone: (86-755) 8307 1443, or email: [CN.Doccheck@sgs.com](mailto:CN.Doccheck@sgs.com)

SGS-CSTC Standards Technical Services Co., Ltd.  
Shenzhen Branch  
Shenzhen Branch Wireless Laboratory

No.1 Workshop, M-10, Middle Section, Science & Technology Park, Nanshan District, Shenzhen, Guangdong, China 518057 t (86-755) 26012053 www.sgsgroup.com.cn  
中国·广东·深圳市南山区科技园中区M-10栋1号厂房 邮编: 518057 t (86-755) 26012053 sgs.china@sgs.com





#### 4.10 Restricted bands around fundamental frequency

Test Requirement:	47 CFR Part 15C Section 15.209 and 15.205		
Test Method:	ANSI C63.10: 2013 Section 11.12		
Test Site:	Measurement Distance: 3m (Semi-Anechoic Chamber)		
Limit:	Frequency	Limit (dBuV/m)	Remark
	30MHz-88MHz	40.0	Quasi-peak
	88MHz-216MHz	43.5	Quasi-peak
	216MHz-960MHz	46.0	Quasi-peak
	960MHz-1GHz	54.0	Quasi-peak
	Above 1GHz	54.0	Average Value
		74.0	Peak Value

#### Test Setup:

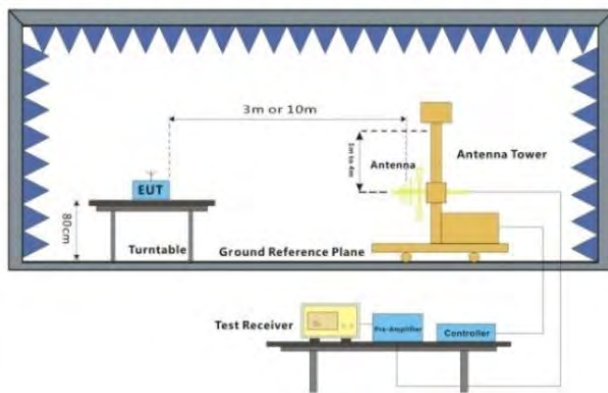


Figure 1. 30MHz to 1GHz

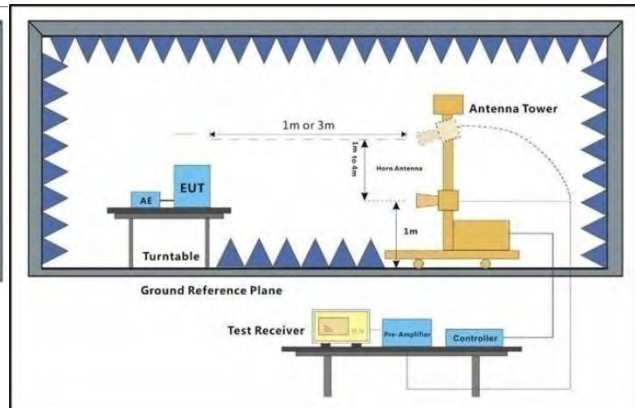


Figure 2. Above 1 GHz





# SGS-CSTC Standards Technical Services Co., Ltd. Shenzhen Branch

Report No.: SZCR240100035204  
Page: 25 of 115

Test Procedure:	<p>a. For below 1GHz, the EUT was placed on the top of a rotating table 0.8 meters above the ground at a 3 or 10 meter semi-anechoic chamber. The table was rotated 360 degrees to determine the position of the highest radiation.</p> <p>b. For above 1GHz, the EUT was placed on the top of a rotating table 1.5 meters above the ground at a 3 meter semi-anechoic chamber. The table was rotated 360 degrees to determine the position of the highest radiation.</p> <p>c. The EUT was set 3 or 10 meters away from the interference-receiving antenna, which was mounted on the top of a variable-height antenna tower.</p> <p>d. The antenna height is varied from one meter to four meters above the ground to determine the maximum value of the field strength. Both horizontal and vertical polarizations of the antenna are set to make the measurement.</p> <p>e. For each suspected emission, the EUT was arranged to its worst case and then the antenna was tuned to heights from 1 meter to 4 meters and the rotatable table was turned from 0 degrees to 360 degrees to find the maximum reading.</p> <p>f. The test-receiver system was set to Peak Detect Function and Specified Bandwidth with Maximum Hold Mode.</p> <p>g. Place a marker at the end of the restricted band closest to the transmit frequency to show compliance. Also measure any emissions in the restricted bands. Save the spectrum analyzer plot. Repeat for each power and modulation for lowest and highest channel</p> <p>h. Test the EUT in the lowest channel , the Highest channel</p> <p>i. The radiation measurements are performed in X, Y, Z axis positioning for Transmitting mode,And found the Z axis positioning which it is worse case.</p> <p>j. Repeat above procedures until all frequencies measured was complete.</p>
Test Configuration:	<p>Measurements Below 1000MHz</p> <ul style="list-style-type: none"> <li>• RBW = 120 kHz</li> <li>• VBW = 300 kHz</li> <li>• Detector = Quasi-peak</li> <li>• Trace mode = max hold</li> </ul> <p>Peak Measurements Above 1000 MHz</p> <ul style="list-style-type: none"> <li>• RBW = 1 MHz</li> <li>• VBW ≥ 3 MHz</li> <li>• Detector = Peak</li> <li>• Sweep time = auto</li> <li>• Trace mode = max hold</li> </ul> <p>Average Measurements Above 1000MHz</p> <ul style="list-style-type: none"> <li>• RBW = 1 MHz</li> <li>• VBW = 10 Hz, when duty cycle is no less than 98 percent.</li> <li>• VBW ≥ 1/T, when duty cycle is less than 98 percent where T is the minimum transmission duration over which the transmitter is on and is transmitting at its maximum power control level for the tested mode of operation.</li> </ul>
Exploratory Test Mode:	<p>Transmitting with all kind of modulations, data rates. Charge + Transmitting mode.</p>
Final Test Mode:	<p>Refer to section 3.7 for details.</p>



Unless otherwise agreed in writing, this document is issued by the Company subject to its General Conditions of Service printed overleaf, available on request or accessible at <https://www.sgs.com/en/Terms-and-Conditions>. Attention is drawn to the limitation of liability, indemnification and jurisdiction issues defined therein. Any holder of this document is advised that information contained hereon reflects the Company's findings at the time of its intervention only and within the limits of Client's instructions, if any. The Company's sole responsibility is to its Client and this document does not exonerate parties to a transaction from exercising all their rights and obligations under the transaction documents. This document cannot be reproduced except in full, without prior written approval of the Company. Any unauthorized alteration, forgery or falsification of the content or appearance of this document is unlawful and offenders may be prosecuted to the fullest extent of the law. Unless otherwise stated the results shown in this test report refer only to the sample(s) tested and such sample(s) are retained for 30 days only.

Attention: To check the authenticity of testing /inspection report & certificate, please contact us at telephone: (86-755) 8307 1443, or email: [CN.Doccheck@sgs.com](mailto:CN.Doccheck@sgs.com)

SGS-CSTC Standards Technical Services Co., Ltd.  
Shenzhen Branch

No.1 Workshop, M-10, Middle Section, Science & Technology Park, Nanshan District, Shenzhen, Guangdong, China 518057 t (86-755) 26012053 www.sgs.com.cn  
中国·广东·深圳市南山区科技园中区M-10栋1号厂房 邮编: 518057 t (86-755) 26012053 sgs.china@sgs.com



# SGS-CSTC Standards Technical Services Co., Ltd. Shenzhen Branch

Report No.: SZCR240100035204  
Page: 26 of 115

Instruments Used:	Refer to section 6 for details.
Test Results:	Pass
The detailed test data see: <b>Appendix</b>	



SGS-CSTC Standards Technical Services Co., Ltd.  
Shenzhen Branch (Shenzhen) Wireless Laboratory

Unless otherwise agreed in writing, this document is issued by the Company subject to its General Conditions of Service printed overleaf, available on request or accessible at <https://www.sgs.com/en/Terms-and-Conditions>. Attention is drawn to the limitation of liability, indemnification and jurisdiction issues defined therein. Any holder of this document is advised that information contained hereon reflects the Company's findings at the time of its intervention only and within the limits of Client's instructions, if any. The Company's sole responsibility is to its Client and this document does not exonerate parties to a transaction from exercising all their rights and obligations under the transaction documents. This document cannot be reproduced except in full, without prior written approval of the Company. Any unauthorized alteration, forgery or falsification of the content or appearance of this document is unlawful and offenders may be prosecuted to the fullest extent of the law. Unless otherwise stated the results shown in this test report refer only to the sample(s) tested and such sample(s) are retained for 30 days only.

Attention: To check the authenticity of testing /inspection report & certificate, please contact us at telephone: (86-755) 8307 1443, or email: [CN.Doccheck@sgs.com](mailto:CN.Doccheck@sgs.com)

No.1 Workshop, M-10, Middle Section, Science & Technology Park, Nanshan District, Shenzhen, Guangdong, China 518057 t (86-755) 26012053 www.sgs.com.cn  
中国·广东·深圳市南山区科技园中区M-10栋1号厂房 邮编: 518057 t (86-755) 26012053 sgs.china@sgs.com



## 5 Measurement Uncertainty (95% confidence levels, k=2)

No.	Item	Measurement Uncertainty
1	Total RF power, conducted	±0.41dB
2	RF power density, conducted	±1.96dB
3	Spurious emissions, conducted	±0.41dB
4	Radio Frequency	±7.10 x 10 <sup>-8</sup> GHz
5	Duty Cycle	±0.49%
6	Occupied Bandwidth	±0.2%
7	Conducted Emissions at Mains Terminals (150kHz-30MHz)	± 3.0dB
8	Radiated Spurious emission test(UE)	±4.8dB (30MHz-1GHz)
		±4.68dB (1GHz-6GHz)
		±4.52dB (6GHz-18GHz)
		±5.26dB (18GHz-40GHz)

**Remark:**

The  $U_{lab}$  (lab Uncertainty) is less than  $U_{CISPR/ETSI}$  (CISPR/ETSI Uncertainty), so the test results  
 – compliance is deemed to occur if no measured disturbance level exceeds the disturbance limit;  
 – non-compliance is deemed to occur if any measured disturbance level exceeds the disturbance limit.






 Report No.: SZCR240100035204  
 Page: 28 of 115

## 6 Equipment List

RF Test System					
Test Equipment	Manufacturer	Model No.	Inventory No.	Cal. date (yyyy/mm/dd)	Cal.Due date (yyyy/mm/dd)
Humidity/ Temperature Indicator	Shanghai Meteorological Industry Factory	HTC-1	SZ-WRG-M-077	2023/05/25	2024/05/24
Spectrum Analyzer	Rohde & Schwarz	FSV	SZ-WRG-M-012	2024/01/30	2025/01/29
DC power supply	HYELEC	HY3005B	SZ-WRG-M-044	2023/09/14	2024/09/13
INSULATION TESTER	FLUKE	1508	SZ-WRG-M-060	2023/12/22	2024/12/21
Wideband Radio Communication Tester	Rohde & Schwarz	CMW500	SZ-WRG-M-033	2024/01/30	2025/01/29
Wideband Radio Communication Tester	Anritsu	MT8821C	SZ-WRG-M-042	2023/05/25	2024/05/24
Programmable Temperature & Humidity Chamber	Votsch Industrietechnik GmbH	VT 4002	SZ-WRG-M-017	2023/12/21	2024/12/20

Conducted Emissions at Mains Terminals (150kHz-30MHz)					
Test Equipment	Manufacturer	Model No.	Inventory No.	Cal. date (yyyy/mm/dd)	Cal.Due date (yyyy/mm/dd)
Shielding Room	ZhongYu Electron	GB-88	SEM001-06	2022/05/14	2025/05/13
EMI Test Receiver	Rohde&Schwarz	ESCI	SEM004-02	2023/03/20	2024/03/19
Measurement Software	AUDIX	e3 V8.2014-6-27a	N/A	NCR	NCR
Coaxial Cable	SGS	N/A	SEM024-01	2023/07/07	2024/07/06
LISN	Rohde&Schwarz	ENV216	SEM007-01	2023/09/19	2024/09/18
LISN	ETS-LINDGREN	Feb-16	SEM007-02	2023/03/20	2024/03/19



Unless otherwise agreed in writing, this document is issued by the Company subject to its General Conditions of Service printed overleaf, available on request or accessible at <https://www.sgs.com/en/Terms-and-Conditions>. Attention is drawn to the limitation of liability, indemnification and jurisdiction issues defined therein. Any holder of this document is advised that information contained hereon reflects the Company's findings at the time of its intervention only and within the limits of Client's instructions, if any. The Company's sole responsibility is to its Client and this document does not exonerate parties to a transaction from exercising all their rights and obligations under the transaction documents. This document cannot be reproduced except in full, without prior written approval of the Company. Any unauthorized alteration, forgery or falsification of the content or appearance of this document is unlawful and offenders may be prosecuted to the fullest extent of the law. Unless otherwise stated the results shown in this test report refer only to the sample(s) tested and such sample(s) are retained for 30 days only.

Attention: To check the authenticity of testing /inspection report & certificate, please contact us at telephone: (86-755) 8307 1443, or email: CN.Doccheck@sgs.com

No.1 Workshop, M-10, Middle Section, Science & Technology Park, Nanshan District, Shenzhen, Guangdong, China 518057 t (86-755) 26012053 www.sgs.com.cn  
 中国·广东·深圳市南山区科技园中区M-10栋1号厂房 邮编: 518057 t (86-755) 26012053 sgs.china@sgs.com



# SGS-CSTC Standards Technical Services Co., Ltd. Shenzhen Branch

Report No.: SZCR240100035204  
Page: 29 of 115

Radiated spurious emissions					
Test Equipment	Manufacturer	Model No.	Inventory No.	Cal. date (yyyy/mm/dd)	Cal.Due date (yyyy/mm/dd)
EMI TEST RECEIVER	Rohde & Schwarz	ESR	SZ-WRG-M-047	2024/01/30	2025/01/29
Signal & Spectrum Analyzer	Rohde & Schwarz	FSV	SZ-WRG-M-048	2024/01/30	2025/01/29
Low Noise Amplifier 9K-3GHz*	Tonscend	TAP9K3G32	SEM005-23	2024/03/05	2025/03/04
Low Noise Amplifier 30M-8GHz	Tonscend	TAP30M8G30	SZ-WRG-M-050	2024/01/30	2025/01/29
Low Noise Amplifier 1G-18GHz	Tonscend	TAP01018050	SZ-WRG-M-051	2024/01/30	2025/01/29
Low Noise Amplifier 18G-40GHz	Tonscend	TAP18040048	SZ-WRG-M-052	2024/01/30	2025/01/29
Active Loop Antenna 9kHz-30MHz	SCHWARZBECK	FMZB 1519B	SZ-WRG-M-053	2023/12/25	2024/12/24
TRILOG Breitband Antenne 30MHz-1GHz	SCHWARZBECK	VULB 9168	SZ-WRG-M-054	2023/12/25	2024/12/24
Double Ridge Horn Antenna 1GHz-18GHz	SCHWARZBECK	BBHA 9120 D	SZ-WRG-M-055	2023/12/21	2024/12/20
SHF-EHF Horn 15GHz-40GHz	SCHWARZBECK	BBHA 9170	SZ-WRG-M-056	2023/12/25	2024/12/24
RSE Test Software	Tonscend	JS32-RSE V4.0.0	SZ-WRG-S-058	NCR	NCR
RE Test Software	Tonscend	JS36-RSE V5.0.0.1	SZ-WRG-S-059	NCR	NCR
Chamber	CRTSGSSAC966	N/A	SZ-WRG-C-063	2022/01/05	2025/01/04
Humidity/ Temperature Indicator	Shanghai Meteorological Industry Factory	HTC-1	SZ-WRG-M-078	2023/05/25	2024/05/24
Spectrum Analyzer	Keysight	N9020A	SZ-WRG-M-002	2023/09/14	2024/09/13

Remark: NCR=No Calibration Requirement.



Unless otherwise agreed in writing, this document is issued by the Company subject to its General Conditions of Service printed overleaf, available on request or accessible at <https://www.sgs.com/en/Terms-and-Conditions>. Attention is drawn to the limitation of liability, indemnification and jurisdiction issues defined therein. Any holder of this document is advised that information contained hereon reflects the Company's findings at the time of its intervention only and within the limits of Client's instructions, if any. The Company's sole responsibility is to its Client and this document does not exonerate parties to a transaction from exercising all their rights and obligations under the transaction documents. This document cannot be reproduced except in full, without prior written approval of the Company. Any unauthorized alteration, forgery or falsification of the content or appearance of this document is unlawful and offenders may be prosecuted to the fullest extent of the law. Unless otherwise stated the results shown in this test report refer only to the sample(s) tested and such sample(s) are retained for 30 days only.

Attention: To check the authenticity of testing /inspection report & certificate, please contact us at telephone: (86-755) 8307 1443, or email: CN.Doccheck@sgs.com

No.1 Workshop, M-10, Middle Section, Science & Technology Park, Nanshan District, Shenzhen, Guangdong, China 518057 t (86-755) 26012053 www.sgs.com.cn  
中国·广东·深圳市南山区科技园中区M-10栋1号厂房 邮编: 518057 t (86-755) 26012053 sgs.china@sgs.com


 Report No.: SZCR240100035204  
 Page: 30 of 115

## 7 Photographs - Setup Photos

Refer to Appendix A.2 WLAN Setup Photos.



Unless otherwise agreed in writing, this document is issued by the Company subject to its General Conditions of Service printed overleaf, available on request or accessible at <https://www.sgs.com/en/Terms-and-Conditions>. Attention is drawn to the limitation of liability, indemnification and jurisdiction issues defined therein. Any holder of this document is advised that information contained hereon reflects the Company's findings at the time of its intervention only and within the limits of Client's instructions, if any. The Company's sole responsibility is to its Client and this document does not exonerate parties to a transaction from exercising all their rights and obligations under the transaction documents. This document cannot be reproduced except in full, without prior written approval of the Company. Any unauthorized alteration, forgery or falsification of the content or appearance of this document is unlawful and offenders may be prosecuted to the fullest extent of the law. Unless otherwise stated the results shown in this test report refer only to the sample(s) tested and such sample(s) are retained for 30 days only.

Attention: To check the authenticity of testing /inspection report & certificate, please contact us at telephone: (86-755) 8307 1443, or email: [CN.Doccheck@sgs.com](mailto:CN.Doccheck@sgs.com)

SGS-CSTC Standards Technical Services Co., Ltd.  
 Shenzhen Branch / Wireless Laboratory

No.1 Workshop, M-10, Middle Section, Science & Technology Park, Nanshan District, Shenzhen, Guangdong, China 518057 t (86-755) 26012053 www.sgsgroup.com.cn  
 中国·广东·深圳市南山区科技园中区M-10栋1号厂房 邮编: 518057 t (86-755) 26012053 sgs.china@sgs.com



**SGS-CSTC Standards Technical Services Co., Ltd.**  
**Shenzhen Branch**

Report No.: SZCR240100035204  
Page: 31 of 115

# Appendix



Unless otherwise agreed in writing, this document is issued by the Company subject to its General Conditions of Service printed overleaf, available on request or accessible at <https://www.sgs.com/en/Terms-and-Conditions>. Attention is drawn to the limitation of liability, indemnification and jurisdiction issues defined therein. Any holder of this document is advised that information contained hereon reflects the Company's findings at the time of its intervention only and within the limits of Client's instructions, if any. The Company's sole responsibility is to its Client and this document does not exonerate parties to a transaction from exercising all their rights and obligations under the transaction documents. This document cannot be reproduced except in full, without prior written approval of the Company. Any unauthorized alteration, forgery or falsification of the content or appearance of this document is unlawful and offenders may be prosecuted to the fullest extent of the law. Unless otherwise stated the results shown in this test report refer only to the sample(s) tested and such sample(s) are retained for 30 days only.

**Attention: To check the authenticity of testing /inspection report & certificate, please contact us at telephone: (86-755) 8307 1443, or email: CN.Doccheck@sgs.com**

SGS-CSTC Standards Technical Services Co., Ltd.  
Shenzhen Branch (In-house Laboratory)

No.1 Workshop, M-10, Middle Section, Science & Technology Park, Nanshan District, Shenzhen, Guangdong, China 518057 t (86-755) 26012053 www.sgsgroup.com.cn  
中国·广东·深圳市南山区科技园中区M-10栋1号厂房 邮编: 518057 t (86-755) 26012053 sgs.china@sgs.com





# SGS-CSTC Standards Technical Services Co., Ltd. Shenzhen Branch

Report No.: SZCR240100035204  
Page: 32 of 115

## Duty Cycle

### Ant7

### Test Result

Ant7							
Mode	TX Type	Frequency (MHz)	T_on (ms)	Period (ms)	Duty Cycle (%)	Duty Cycle Correction Factor (dB)	Max. DC Variation (%)
802.11b	SISO	2412	8.377	8.417	99.52	0.02	0.04
		2437	8.376	8.416	99.52	0.02	0.04
		2462	8.377	8.417	99.52	0.02	0.04
802.11g	SISO	2412	1.388	1.430	97.06	0.13	0.03
		2437	1.388	1.431	97.00	0.13	0.06
		2462	1.388	1.430	97.06	0.13	0.03
802.11n (HT20)	SISO	2412	1.296	1.339	96.79	0.14	0.03
		2437	1.295	1.339	96.71	0.15	0.07
		2462	1.295	1.339	96.71	0.15	0.07

#### Note:

Radiated Emission Average VBW = 1 / T

TestMode	T[ms]	Period[ms]	Duty Cycle[%]	1/T[kHz]	VBW Setting
802.11b	8.377	8.417	99.52	0.11937	10Hz
802.11g	1.388	1.430	97.06	0.72046	0.8KHz
802.11n (HT20)	1.296	1.339	96.79	0.77160	0.8KHz

\*Duty cycle > 98% VBW setting=10Hz



Unless otherwise agreed in writing, this document is issued by the Company subject to its General Conditions of Service printed overleaf, available on request or accessible at <https://www.sgs.com/en/Terms-and-Conditions>. Attention is drawn to the limitation of liability, indemnification and jurisdiction issues defined therein. Any holder of this document is advised that information contained hereon reflects the Company's findings at the time of its intervention only and within the limits of Client's instructions, if any. The Company's sole responsibility is to its Client and this document does not exonerate parties to a transaction from exercising all their rights and obligations under the transaction documents. This document cannot be reproduced except in full, without prior written approval of the Company. Any unauthorized alteration, forgery or falsification of the content or appearance of this document is unlawful and offenders may be prosecuted to the fullest extent of the law. Unless otherwise stated the results shown in this test report refer only to the sample(s) tested and such sample(s) are retained for 30 days only.

Attention: To check the authenticity of testing /inspection report & certificate, please contact us at telephone: (86-755) 8307 1443, or email: CN.Doccheck@sgs.com

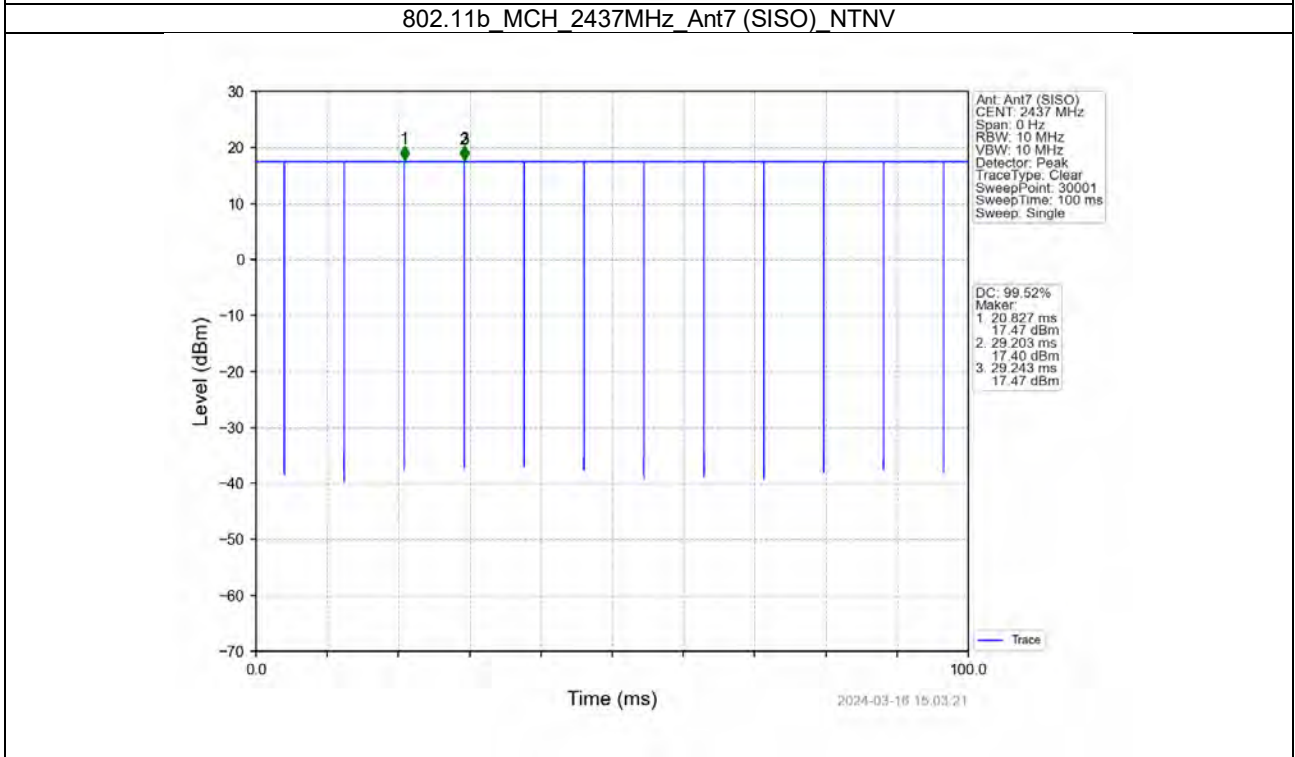
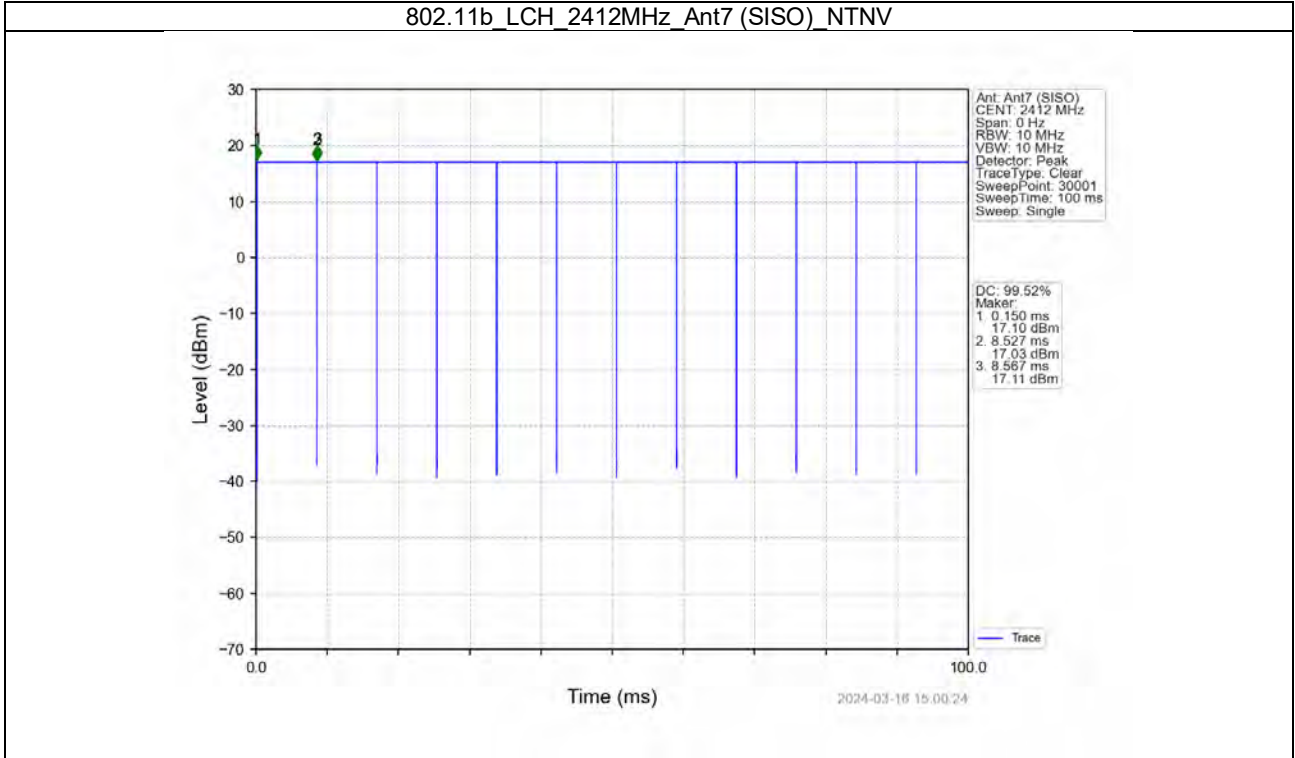
No.1 Workshop, M-10, Middle Section, Science & Technology Park, Nanshan District, Shenzhen, Guangdong, China 518057 t (86-755) 26012053 www.sgs.com.cn  
中国·广东·深圳市南山区科技园中区M-10栋1号厂房 邮编: 518057 t (86-755) 26012053 sgs.china@sgs.com



**SGS-CSTC Standards Technical Services Co., Ltd.**  
**Shenzhen Branch**

Report No.: SZCR240100035204  
 Page: 33 of 115

Test Graph



Unless otherwise agreed in writing, this document is issued by the Company subject to its General Conditions of Service printed overleaf, available on request or accessible at <https://www.sgs.com/en/Terms-and-Conditions>. Attention is drawn to the limitation of liability, indemnification and jurisdiction issues defined therein. Any holder of this document is advised that information contained hereon reflects the Company's findings at the time of its intervention only and within the limits of Client's instructions, if any. The Company's sole responsibility is to its Client and this document does not exonerate parties to a transaction from exercising all their rights and obligations under the transaction documents. This document cannot be reproduced except in full, without prior written approval of the Company. Any unauthorized alteration, forgery or falsification of the content or appearance of this document is unlawful and offenders may be prosecuted to the fullest extent of the law. Unless otherwise stated the results shown in this test report refer only to the sample(s) tested and such sample(s) are retained for 30 days only.

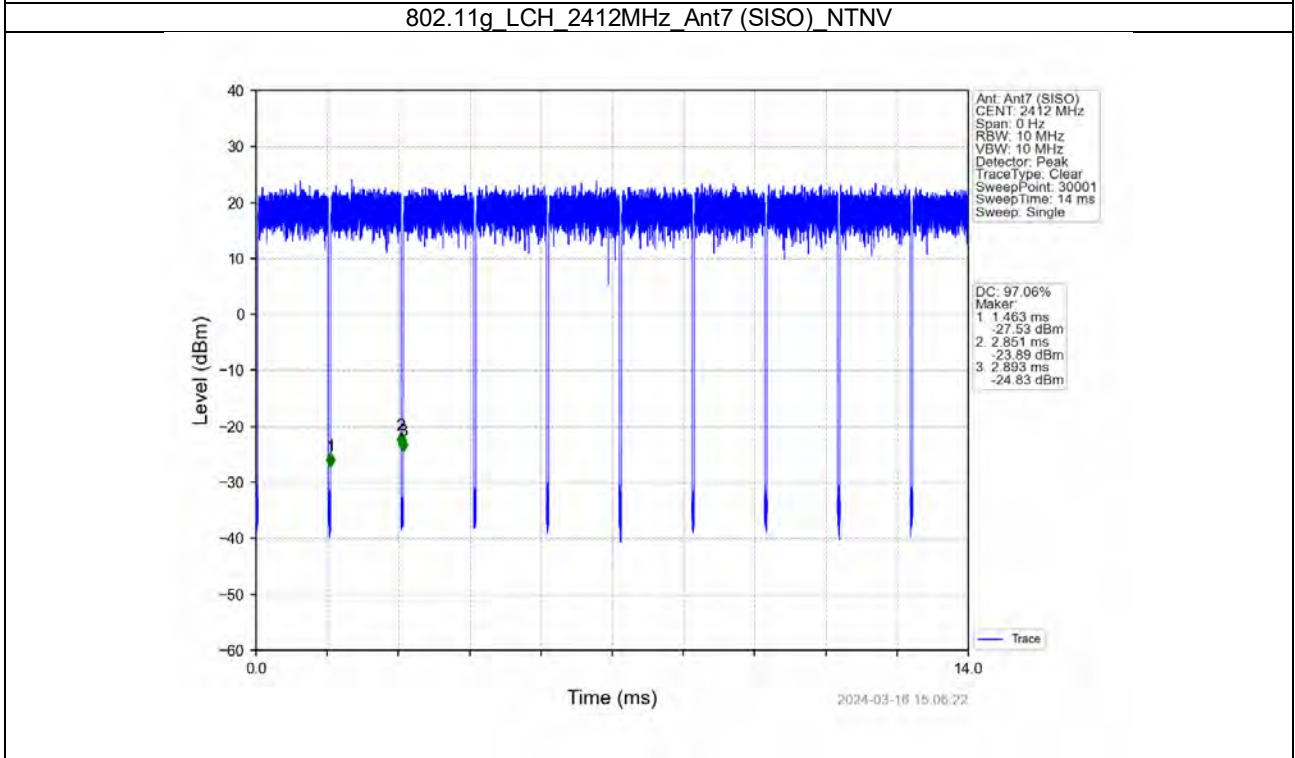
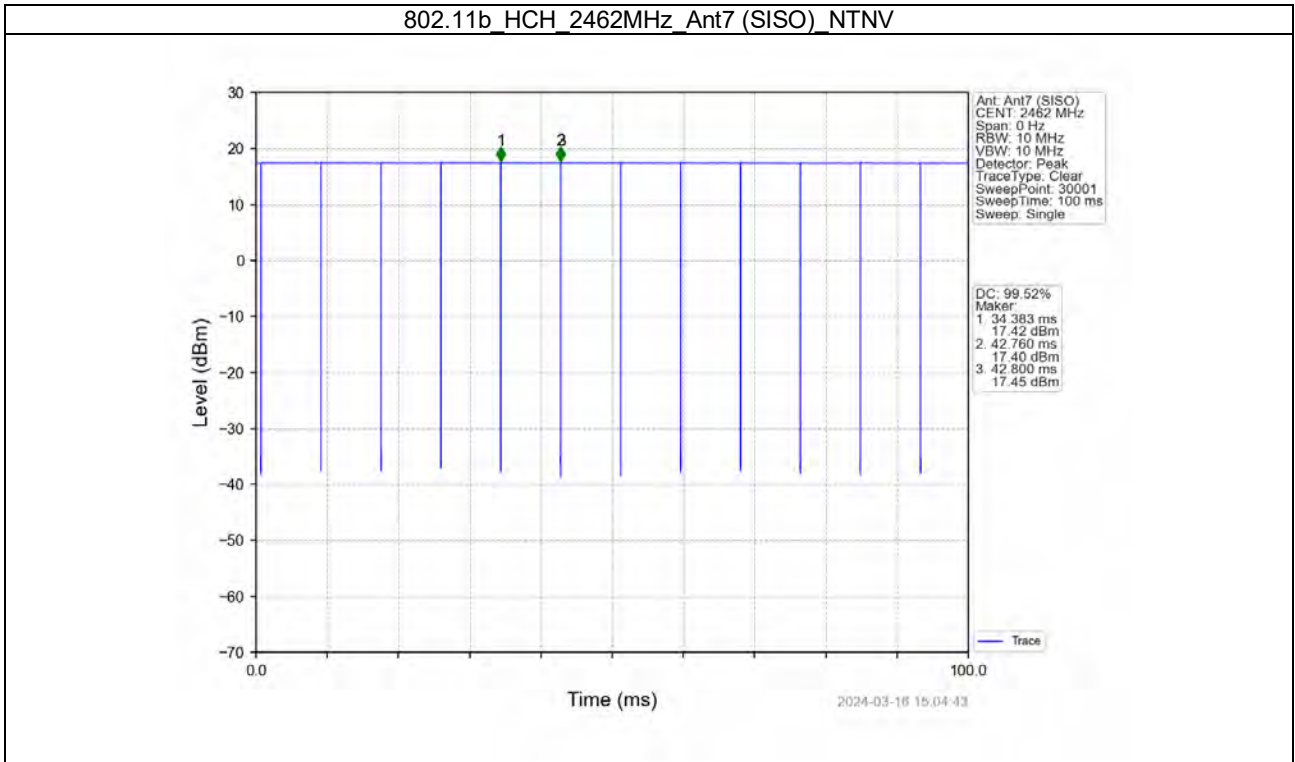
Attention: To check the authenticity of testing /inspection report & certificate, please contact us at telephone: (86-755) 8307 1443, or email: CN.Doccheck@sgs.com

No.1 Workshop, M-10, Middle Section, Science & Technology Park, Nanshan District, Shenzhen, Guangdong, China 518057 t (86-755) 26012053 www.sgs.com.cn  
 中国·广东·深圳市南山区科技园中区M-10栋1号厂房 邮编: 518057 t (86-755) 26012053 sgs.china@sgs.com



**SGS-CSTC Standards Technical Services Co., Ltd.**  
**Shenzhen Branch**

Report No.: SZCR240100035204  
 Page: 34 of 115



Unless otherwise agreed in writing, this document is issued by the Company subject to its General Conditions of Service printed overleaf, available on request or accessible at <https://www.sgs.com/en/Terms-and-Conditions>. Attention is drawn to the limitation of liability, indemnification and jurisdiction issues defined therein. Any holder of this document is advised that information contained hereon reflects the Company's findings at the time of its intervention only and within the limits of Client's instructions, if any. The Company's sole responsibility is to its Client and this document does not exonerate parties to a transaction from exercising all their rights and obligations under the transaction documents. This document cannot be reproduced except in full, without prior written approval of the Company. Any unauthorized alteration, forgery or falsification of the content or appearance of this document is unlawful and offenders may be prosecuted to the fullest extent of the law. Unless otherwise stated the results shown in this test report refer only to the sample(s) tested and such sample(s) are retained for 30 days only.

Attention: To check the authenticity of testing /inspection report & certificate, please contact us at telephone: (86-755) 8307 1443, or email: CN.Doccheck@sgs.com

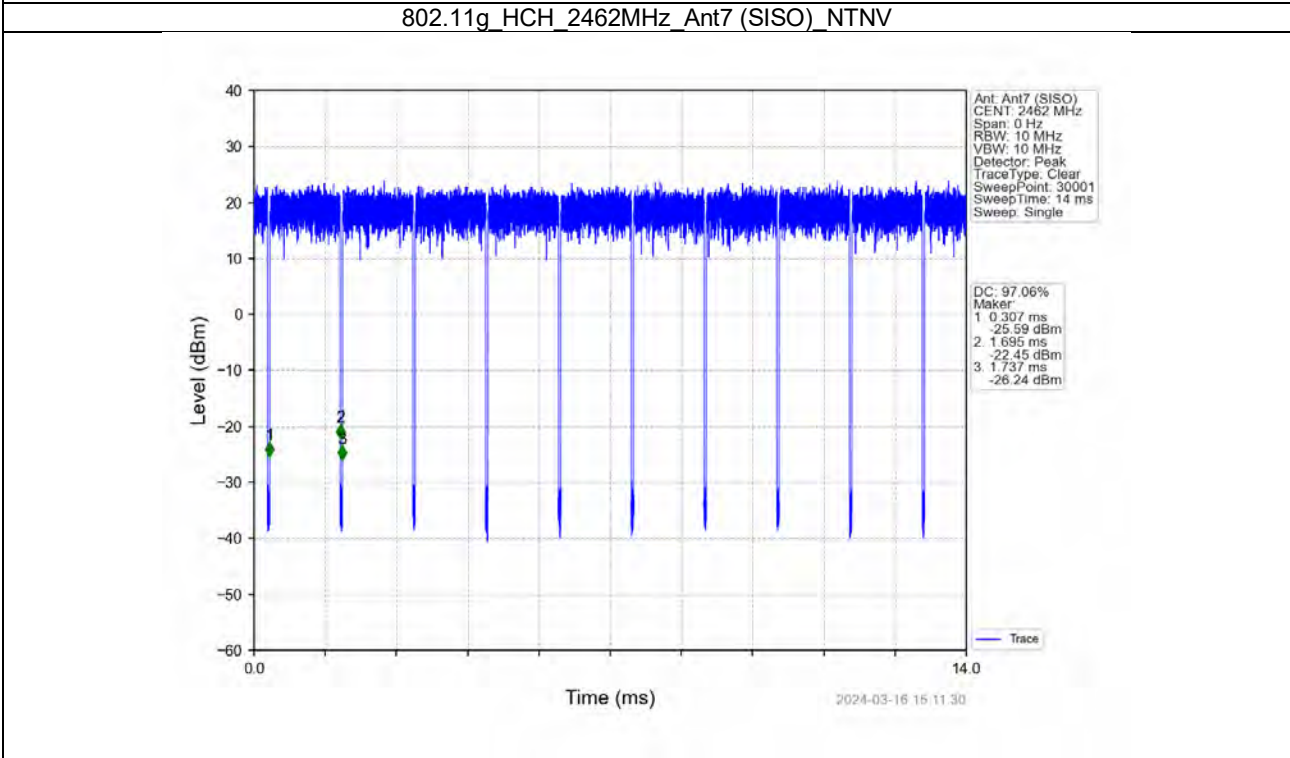
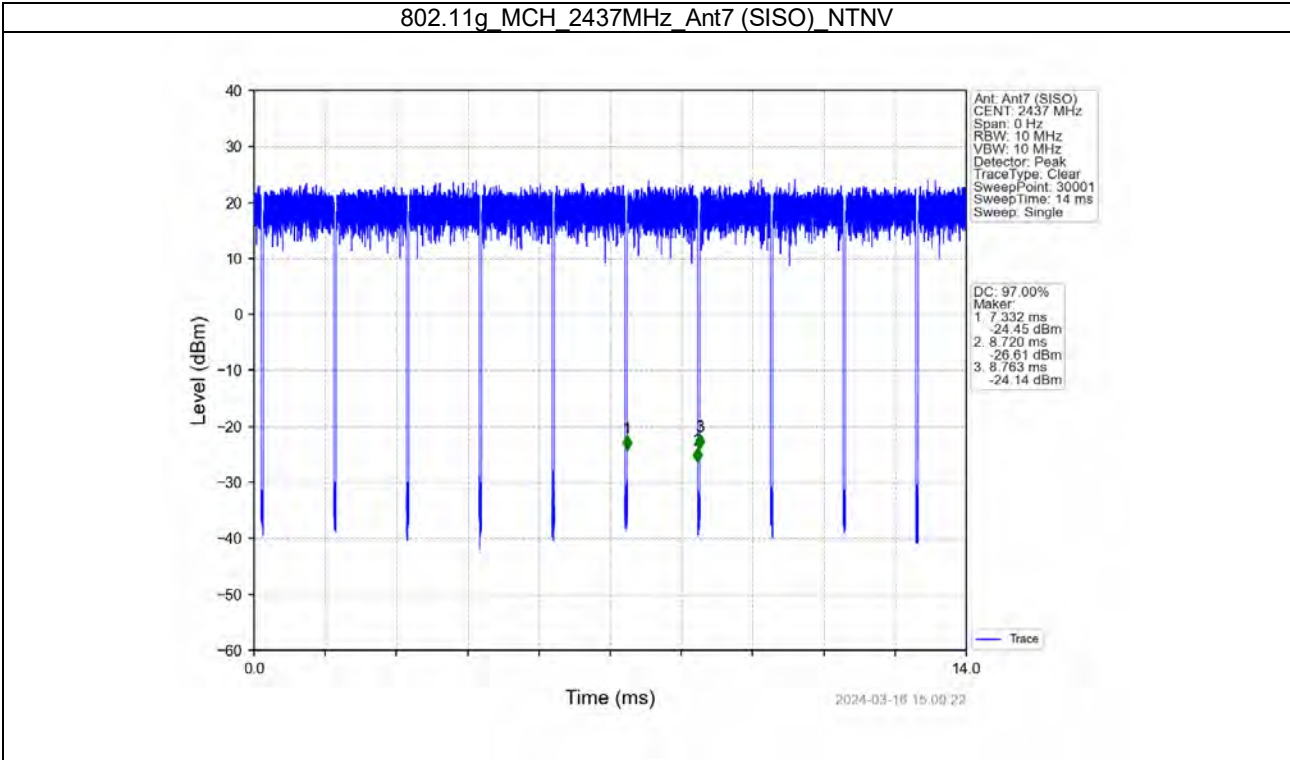
No.1 Workshop, M-10, Middle Section, Science & Technology Park, Nanshan District, Shenzhen, Guangdong, China 518057 t (86-755) 26012053 www.sgs.com.cn  
 中国·广东·深圳市南山区科技园中区M-10栋1号厂房 邮编: 518057 t (86-755) 26012053 sgs.china@sgs.com





**SGS-CSTC Standards Technical Services Co., Ltd.**  
**Shenzhen Branch**

Report No.: SZCR240100035204  
 Page: 35 of 115



Unless otherwise agreed in writing, this document is issued by the Company subject to its General Conditions of Service printed overleaf, available on request or accessible at <https://www.sgs.com/en/Terms-and-Conditions>. Attention is drawn to the limitation of liability, indemnification and jurisdiction issues defined therein. Any holder of this document is advised that information contained hereon reflects the Company's findings at the time of its intervention only and within the limits of Client's instructions, if any. The Company's sole responsibility is to its Client and this document does not exonerate parties to a transaction from exercising all their rights and obligations under the transaction documents. This document cannot be reproduced except in full, without prior written approval of the Company. Any unauthorized alteration, forgery or falsification of the content or appearance of this document is unlawful and offenders may be prosecuted to the fullest extent of the law. Unless otherwise stated the results shown in this test report refer only to the sample(s) tested and such sample(s) are retained for 30 days only.

**Attention: To check the authenticity of testing /inspection report & certificate, please contact us at telephone: (86-755) 8307 1443, or email: CN.Doccheck@sgs.com**

No.1 Workshop, M-10, Middle Section, Science & Technology Park, Nanshan District, Shenzhen, Guangdong, China 518057 t (86-755) 26012053 www.sgs.com.cn  
 中国·广东·深圳市南山区科技园中区M-10栋1号厂房 邮编: 518057 t (86-755) 26012053 sgs.china@sgs.com

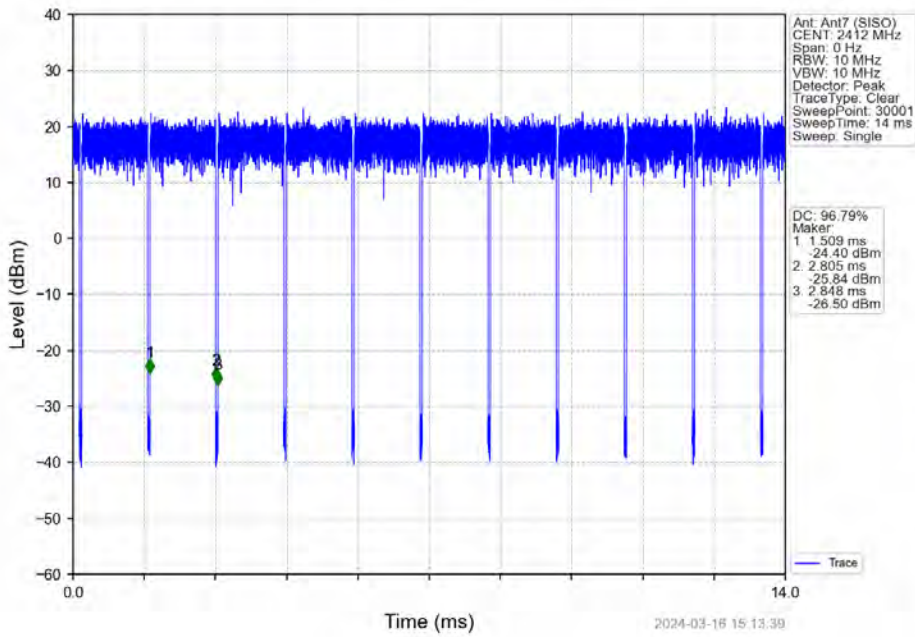




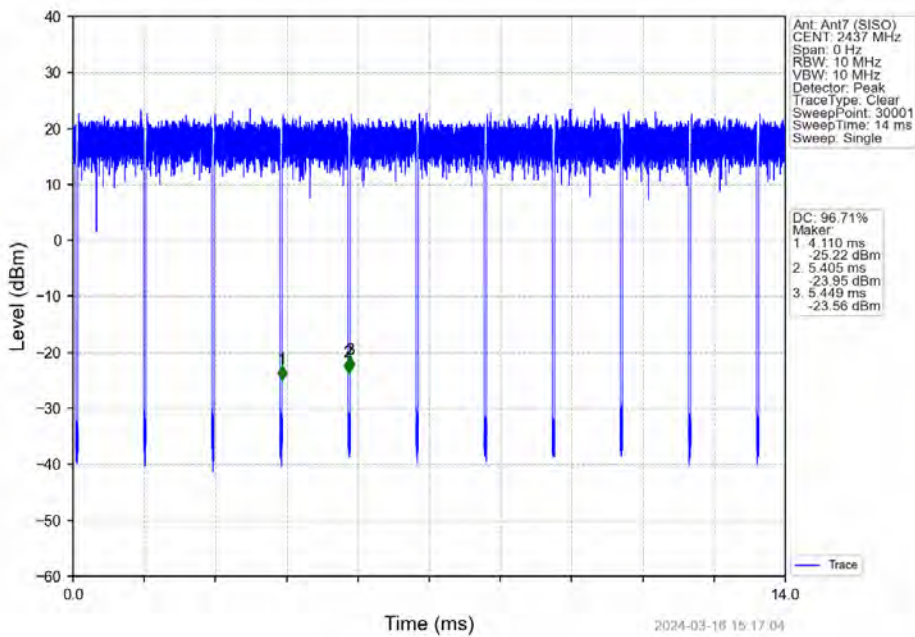
# SGS-CSTC Standards Technical Services Co., Ltd. Shenzhen Branch

Report No.: SZCR240100035204  
Page: 36 of 115

802.11n(HT20)\_LCH\_2412MHz\_Ant7 (SISO)\_NTNV



802.11n(HT20)\_MCH\_2437MHz\_Ant7 (SISO)\_NTNV



Unless otherwise agreed in writing, this document is issued by the Company subject to its General Conditions of Service printed overleaf, available on request or accessible at <https://www.sgs.com/en/Terms-and-Conditions>. Attention is drawn to the limitation of liability, indemnification and jurisdiction issues defined therein. Any holder of this document is advised that information contained hereon reflects the Company's findings at the time of its intervention only and within the limits of Client's instructions, if any. The Company's sole responsibility is to its Client and this document does not exonerate parties to a transaction from exercising all their rights and obligations under the transaction documents. This document cannot be reproduced except in full, without prior written approval of the Company. Any unauthorized alteration, forgery or falsification of the content or appearance of this document is unlawful and offenders may be prosecuted to the fullest extent of the law. Unless otherwise stated the results shown in this test report refer only to the sample(s) tested and such sample(s) are retained for 30 days only.

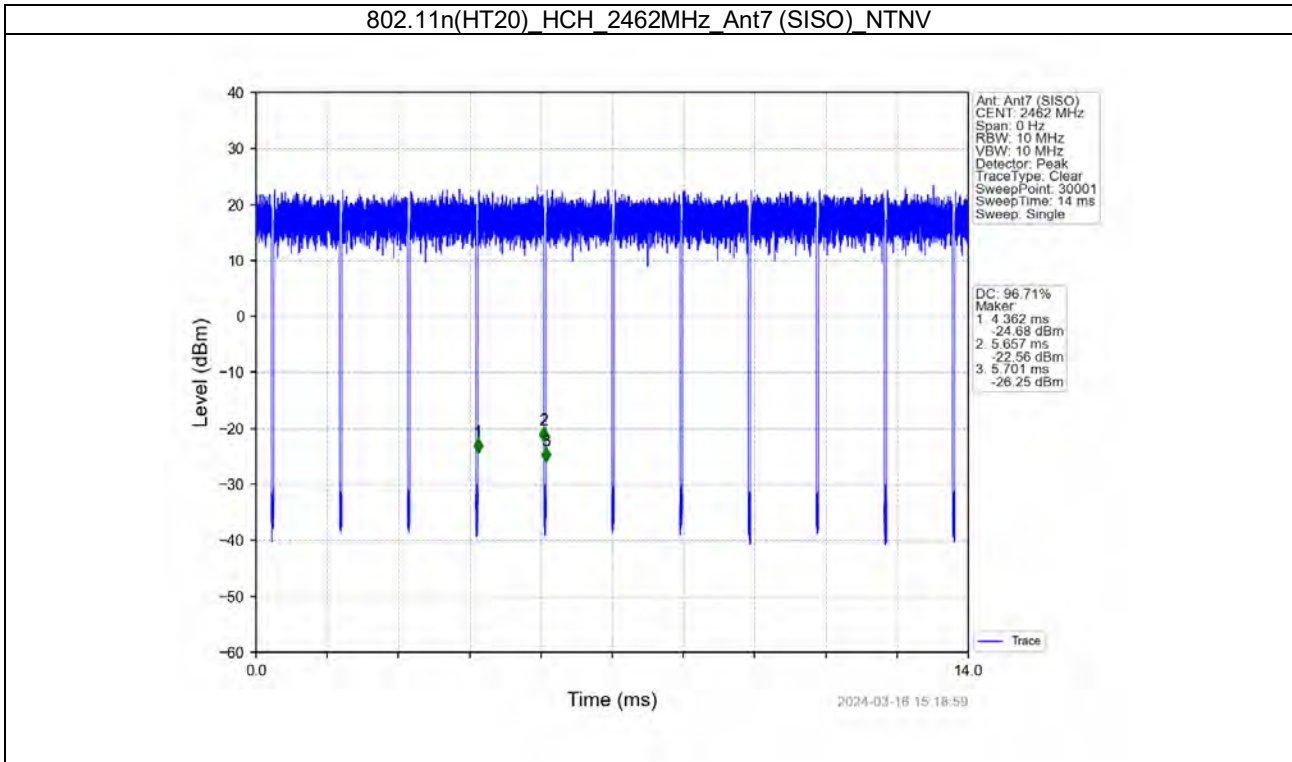
Attention: To check the authenticity of testing /inspection report & certificate, please contact us at telephone: (86-755) 8307 1443, or email: CN.Doccheck@sgs.com

No.1 Workshop, M-10, Middle Section, Science & Technology Park, Nanshan District, Shenzhen, Guangdong, China 518057 t (86-755) 26012053 www.sgs.com.cn  
 中国·广东·深圳市南山区科技园中区M-10栋1号厂房 邮编: 518057 t (86-755) 26012053 sgs.china@sgs.com



**SGS-CSTC Standards Technical Services Co., Ltd.**  
**Shenzhen Branch**

Report No.: SZCR240100035204  
 Page: 37 of 115



Unless otherwise agreed in writing, this document is issued by the Company subject to its General Conditions of Service printed overleaf, available on request or accessible at <https://www.sgs.com/en/Terms-and-Conditions>. Attention is drawn to the limitation of liability, indemnification and jurisdiction issues defined therein. Any holder of this document is advised that information contained hereon reflects the Company's findings at the time of its intervention only and within the limits of Client's instructions, if any. The Company's sole responsibility is to its Client and this document does not exonerate parties to a transaction from exercising all their rights and obligations under the transaction documents. This document cannot be reproduced except in full, without prior written approval of the Company. Any unauthorized alteration, forgery or falsification of the content or appearance of this document is unlawful and offenders may be prosecuted to the fullest extent of the law. Unless otherwise stated the results shown in this test report refer only to the sample(s) tested and such sample(s) are retained for 30 days only.

**Attention: To check the authenticity of testing /inspection report & certificate, please contact us at telephone: (86-755) 8307 1443, or email: CN.Doccheck@sgs.com**

No.1 Workshop, M-10, Middle Section, Science & Technology Park, Nanshan District, Shenzhen, Guangdong, China 518057 t (86-755) 26012053 www.sgs.com.cn  
 中国·广东·深圳市南山区科技园中区M-10栋1号厂房 邮编: 518057 t (86-755) 26012053 sgs.china@sgs.com



# SGS-CSTC Standards Technical Services Co., Ltd. Shenzhen Branch

Report No.: SZCR240100035204  
Page: 38 of 115

## Bandwidth

## OBW

## Test Result

Mode	TX Type	Frequency (MHz)	ANT	99% Occupied Bandwidth (MHz)		Verdict
				Result	Limit	
802.11b	SISO	2412	7	12.848	/	Pass
		2437	7	12.872	/	Pass
		2462	7	12.958	/	Pass
802.11g	SISO	2412	7	17.454	/	Pass
		2437	7	17.437	/	Pass
		2462	7	17.586	/	Pass
802.11n (HT20)	SISO	2412	7	18.243	/	Pass
		2437	7	18.269	/	Pass
		2462	7	18.373	/	Pass



SGS-CSTC Standards Technical Services Co., Ltd.  
Shenzhen Branch Wireless Laboratory

Unless otherwise agreed in writing, this document is issued by the Company subject to its General Conditions of Service printed overleaf, available on request or accessible at <https://www.sgs.com/en/Terms-and-Conditions>. Attention is drawn to the limitation of liability, indemnification and jurisdiction issues defined therein. Any holder of this document is advised that information contained hereon reflects the Company's findings at the time of its intervention only and within the limits of Client's instructions, if any. The Company's sole responsibility is to its Client and this document does not exonerate parties to a transaction from exercising all their rights and obligations under the transaction documents. This document cannot be reproduced except in full, without prior written approval of the Company. Any unauthorized alteration, forgery or falsification of the content or appearance of this document is unlawful and offenders may be prosecuted to the fullest extent of the law. Unless otherwise stated the results shown in this test report refer only to the sample(s) tested and such sample(s) are retained for 30 days only.

Attention: To check the authenticity of testing /inspection report & certificate, please contact us at telephone: (86-755) 8307 1443, or email: CN.Doccheck@sgs.com

No.1 Workshop, M-10, Middle Section, Science & Technology Park, Nanshan District, Shenzhen, Guangdong, China 518057 t (86-755) 26012053 www.sgs.com.cn  
中国·广东·深圳市南山区科技园中区M-10栋1号厂房 邮编: 518057 t (86-755) 26012053 sgs.china@sgs.com

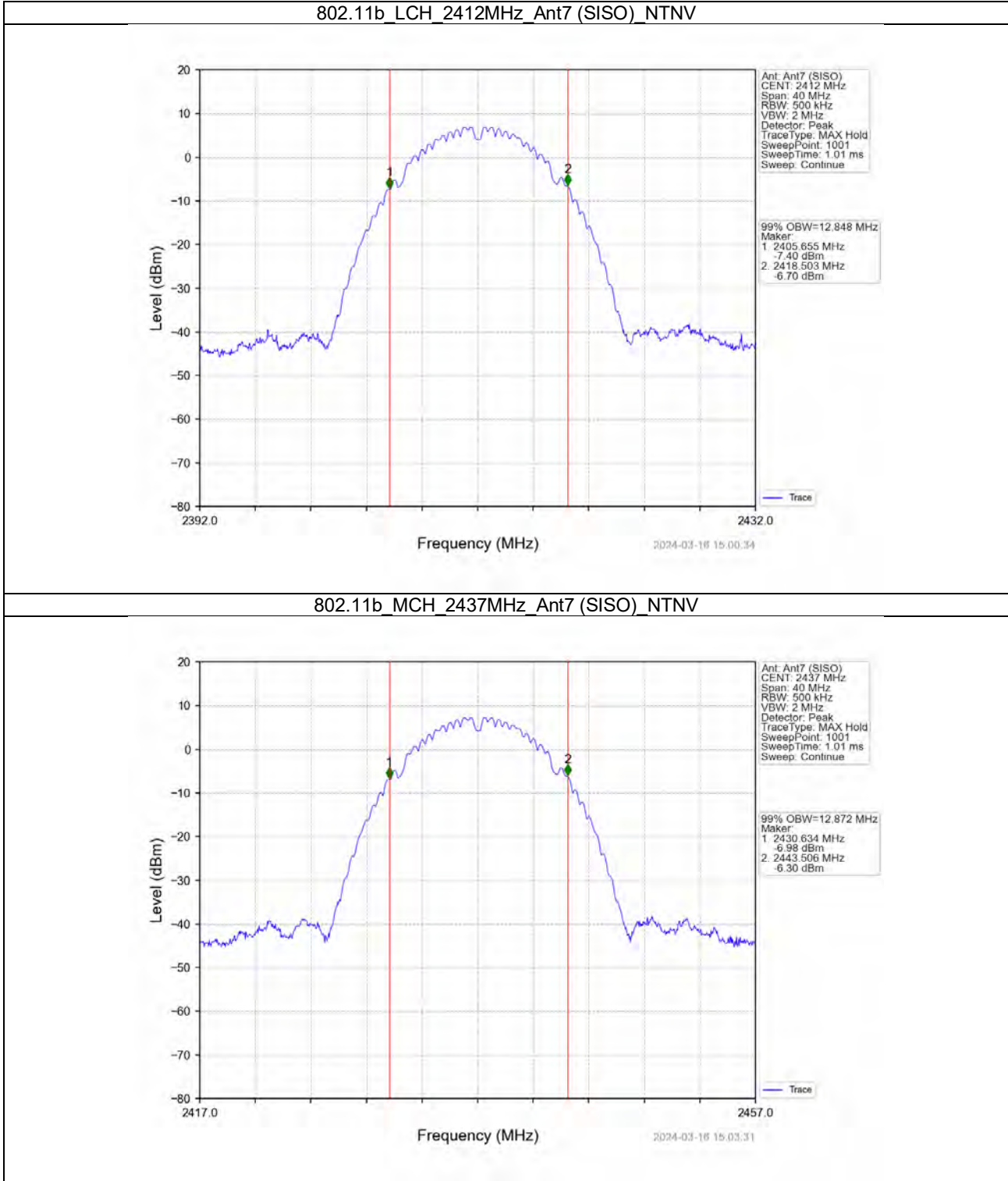




**SGS-CSTC Standards Technical Services Co., Ltd.**  
**Shenzhen Branch**

Report No.: SZCR240100035204  
 Page: 39 of 115

Test Graph



Unless otherwise agreed in writing, this document is issued by the Company subject to its General Conditions of Service printed overleaf, available on request or accessible at <https://www.sgs.com/en/Terms-and-Conditions>. Attention is drawn to the limitation of liability, indemnification and jurisdiction issues defined therein. Any holder of this document is advised that information contained hereon reflects the Company's findings at the time of its intervention only and within the limits of Client's instructions, if any. The Company's sole responsibility is to its Client and this document does not exonerate parties to a transaction from exercising all their rights and obligations under the transaction documents. This document cannot be reproduced except in full, without prior written approval of the Company. Any unauthorized alteration, forgery or falsification of the content or appearance of this document is unlawful and offenders may be prosecuted to the fullest extent of the law. Unless otherwise stated the results shown in this test report refer only to the sample(s) tested and such sample(s) are retained for 30 days only.

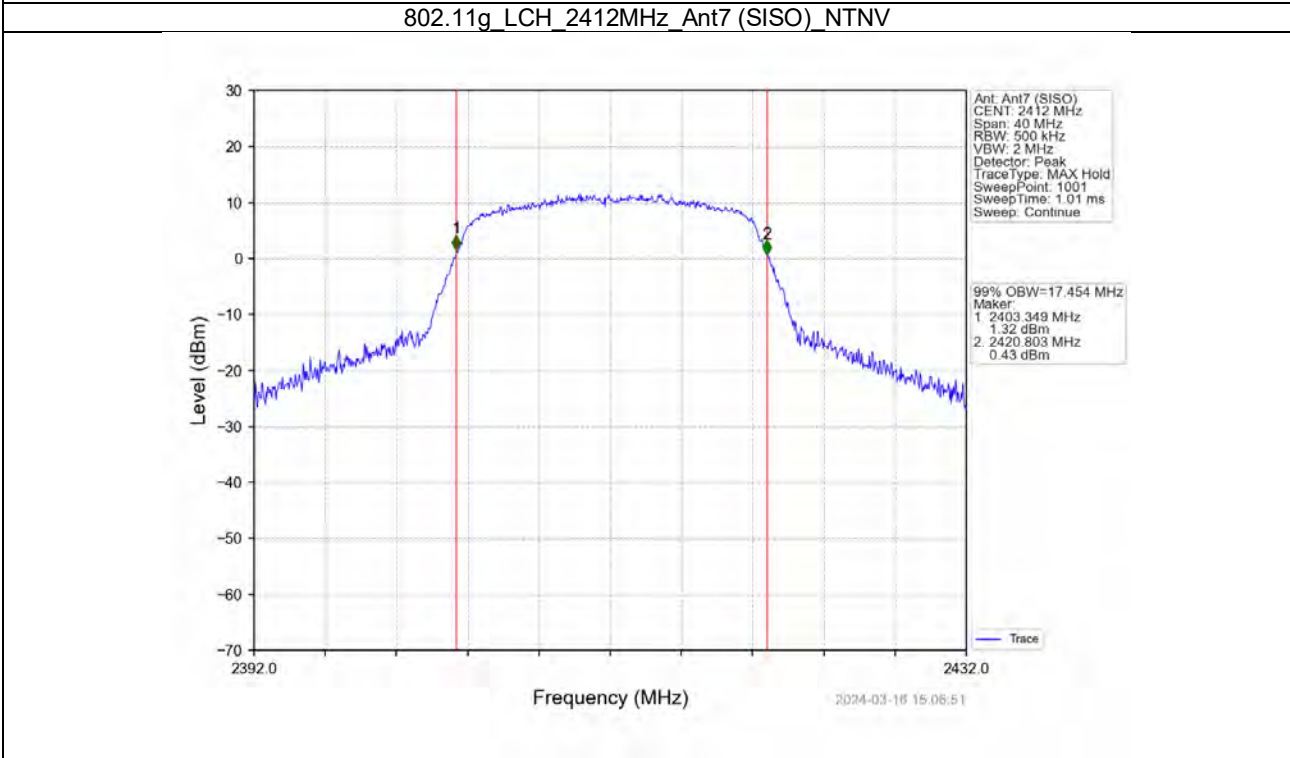
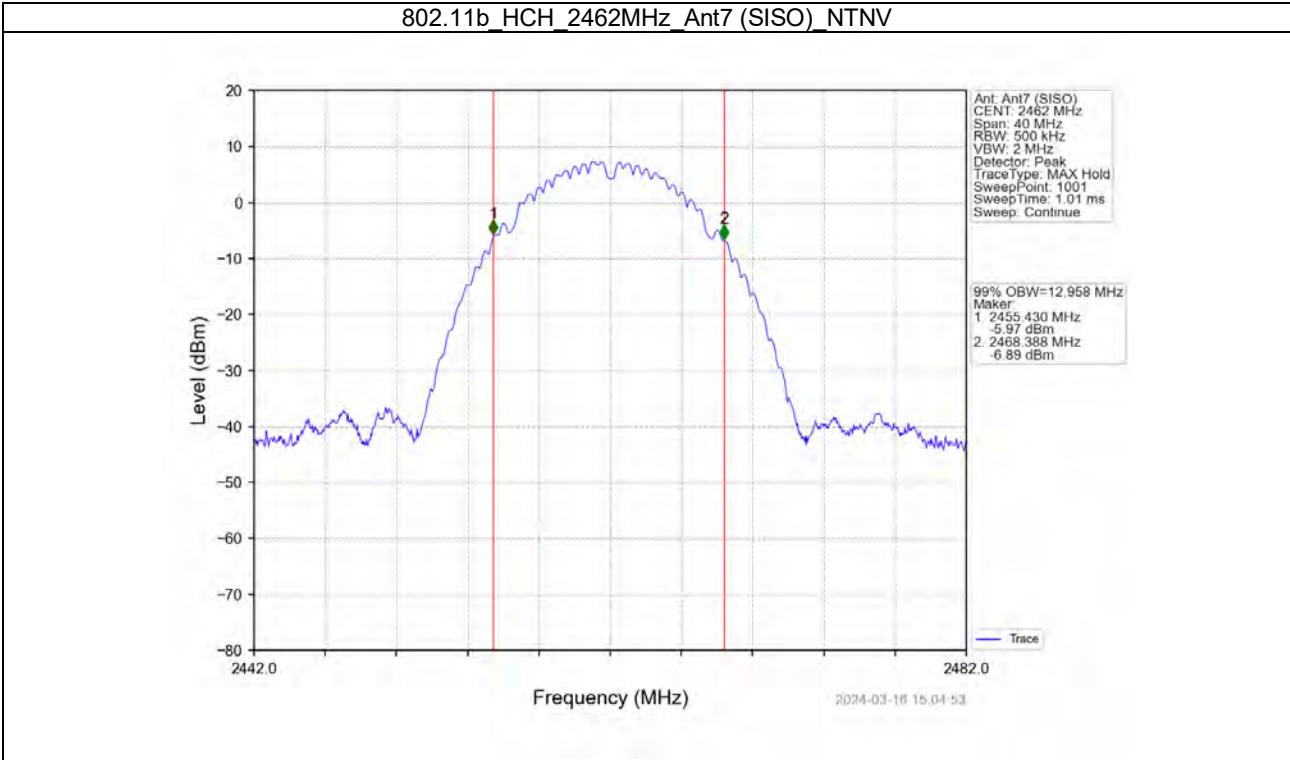
Attention: To check the authenticity of testing /inspection report & certificate, please contact us at telephone: (86-755) 8307 1443, or email: CN.Doccheck@sgs.com  
 No.1 Workshop, M-10, Middle Section, Science & Technology Park, Nanshan District, Shenzhen, Guangdong, China 518057 t (86-755) 26012053 www.sgs.com.cn  
 中国·广东·深圳市南山区科技园中区M-10栋1号厂房 邮编: 518057 t (86-755) 26012053 sgs.china@sgs.com





**SGS-CSTC Standards Technical Services Co., Ltd.**  
**Shenzhen Branch**

Report No.: SZCR240100035204  
 Page: 40 of 115



Unless otherwise agreed in writing, this document is issued by the Company subject to its General Conditions of Service printed overleaf, available on request or accessible at <https://www.sgs.com/en/Terms-and-Conditions>. Attention is drawn to the limitation of liability, indemnification and jurisdiction issues defined therein. Any holder of this document is advised that information contained hereon reflects the Company's findings at the time of its intervention only and within the limits of Client's instructions, if any. The Company's sole responsibility is to its Client and this document does not exonerate parties to a transaction from exercising all their rights and obligations under the transaction documents. This document cannot be reproduced except in full, without prior written approval of the Company. Any unauthorized alteration, forgery or falsification of the content or appearance of this document is unlawful and offenders may be prosecuted to the fullest extent of the law. Unless otherwise stated the results shown in this test report refer only to the sample(s) tested and such sample(s) are retained for 30 days only.

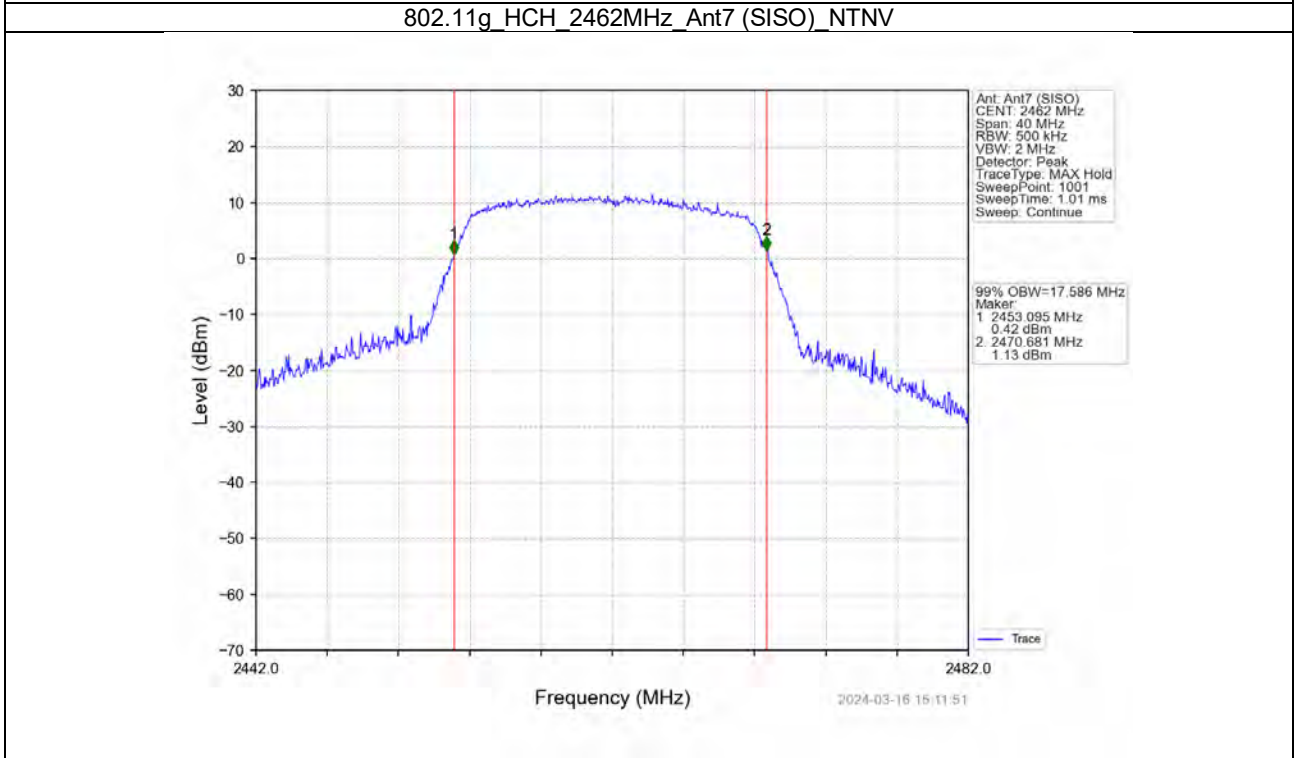
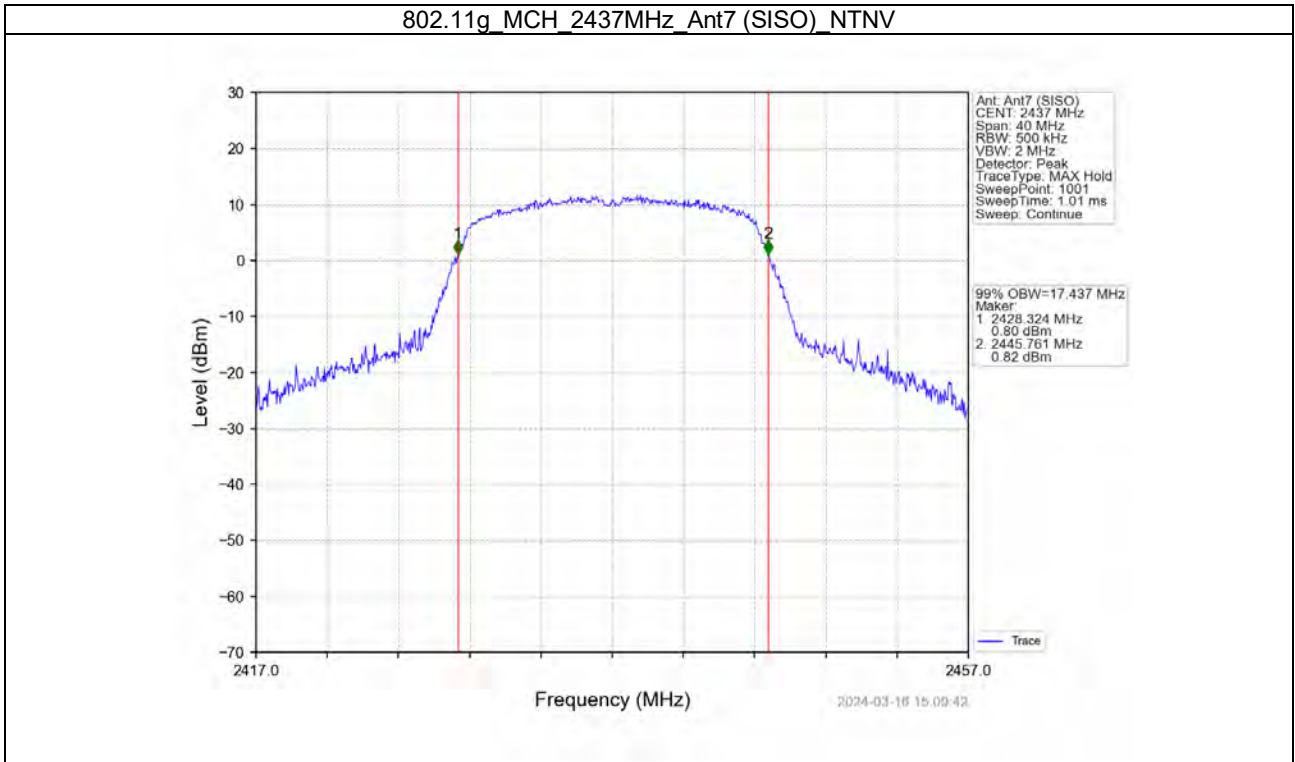
**Attention: To check the authenticity of testing /inspection report & certificate, please contact us at telephone: (86-755) 8307 1443, or email: CN.Doccheck@sgs.com**

No.1 Workshop, M-10, Middle Section, Science & Technology Park, Nanshan District, Shenzhen, Guangdong, China 518057 t (86-755) 26012053 www.sgs.com.cn  
 中国·广东·深圳市南山区科技园中区M-10栋1号厂房 邮编: 518057 t (86-755) 26012053 sgs.china@sgs.com



**SGS-CSTC Standards Technical Services Co., Ltd.**  
**Shenzhen Branch**

Report No.: SZCR240100035204  
 Page: 41 of 115



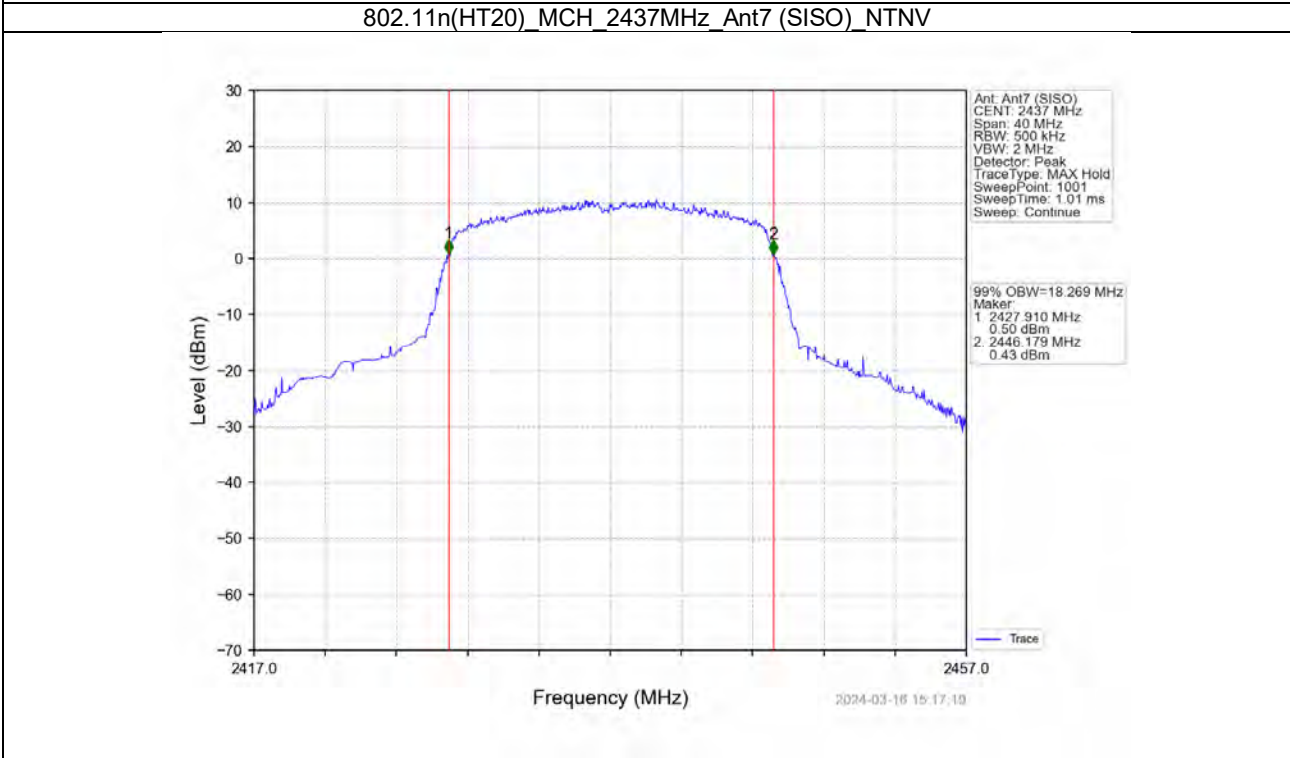
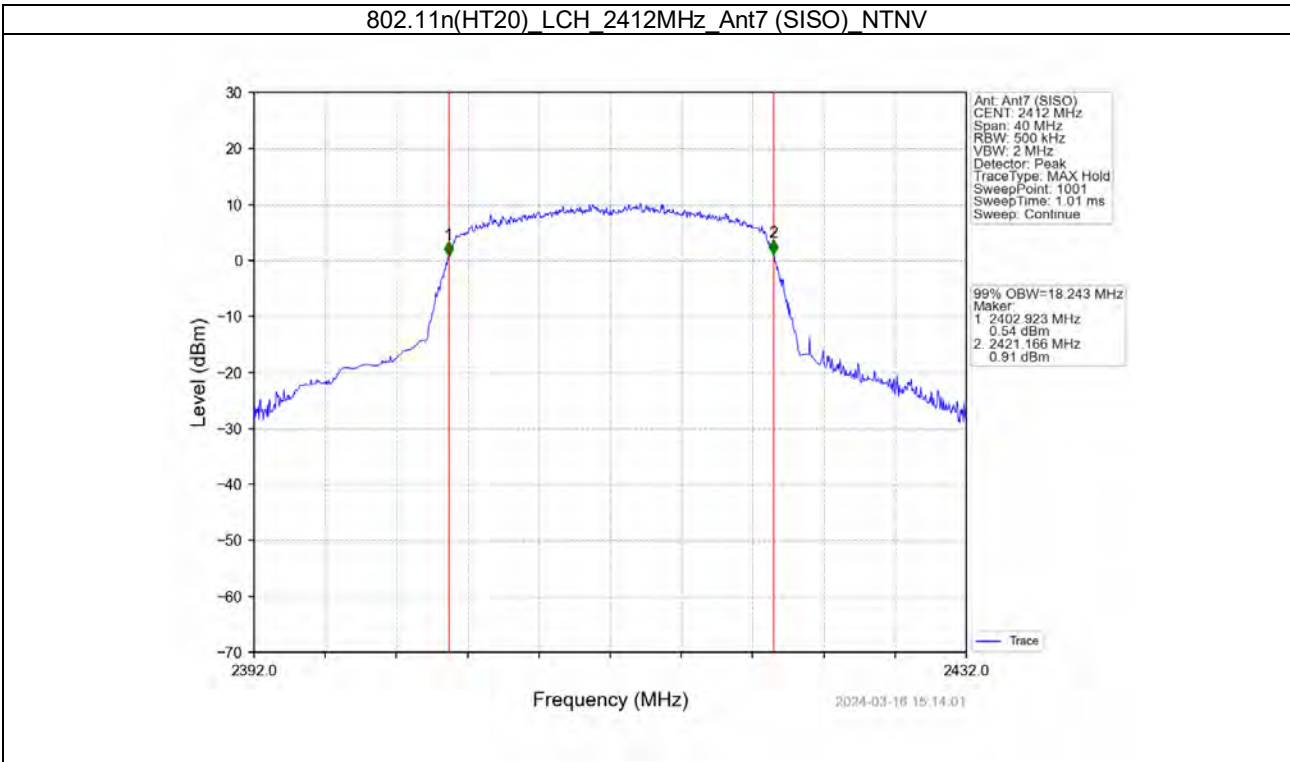
Unless otherwise agreed in writing, this document is issued by the Company subject to its General Conditions of Service printed overleaf, available on request or accessible at <https://www.sgs.com/en/Terms-and-Conditions>. Attention is drawn to the limitation of liability, indemnification and jurisdiction issues defined therein. Any holder of this document is advised that information contained hereon reflects the Company's findings at the time of its intervention only and within the limits of Client's instructions, if any. The Company's sole responsibility is to its Client and this document does not exonerate parties to a transaction from exercising all their rights and obligations under the transaction documents. This document cannot be reproduced except in full, without prior written approval of the Company. Any unauthorized alteration, forgery or falsification of the content or appearance of this document is unlawful and offenders may be prosecuted to the fullest extent of the law. Unless otherwise stated the results shown in this test report refer only to the sample(s) tested and such sample(s) are retained for 30 days only.

Attention: To check the authenticity of testing /inspection report & certificate, please contact us at telephone: (86-755) 8307 1443, or email: CN.Doccheck@sgs.com  
 No.1 Workshop, M-10, Middle Section, Science & Technology Park, Nanshan District, Shenzhen, Guangdong, China 518057 t (86-755) 26012053 www.sgs.com.cn  
 中国·广东·深圳市南山区科技园中区M-10栋1号厂房 邮编: 518057 t (86-755) 26012053 sgs.china@sgs.com



**SGS-CSTC Standards Technical Services Co., Ltd.**  
**Shenzhen Branch**

Report No.: SZCR240100035204  
 Page: 42 of 115



Unless otherwise agreed in writing, this document is issued by the Company subject to its General Conditions of Service printed overleaf, available on request or accessible at <https://www.sgs.com/en/Terms-and-Conditions>. Attention is drawn to the limitation of liability, indemnification and jurisdiction issues defined therein. Any holder of this document is advised that information contained hereon reflects the Company's findings at the time of its intervention only and within the limits of Client's instructions, if any. The Company's sole responsibility is to its Client and this document does not exonerate parties to a transaction from exercising all their rights and obligations under the transaction documents. This document cannot be reproduced except in full, without prior written approval of the Company. Any unauthorized alteration, forgery or falsification of the content or appearance of this document is unlawful and offenders may be prosecuted to the fullest extent of the law. Unless otherwise stated the results shown in this test report refer only to the sample(s) tested and such sample(s) are retained for 30 days only.

Attention: To check the authenticity of testing /inspection report & certificate, please contact us at telephone: (86-755) 8307 1443, or email: CN.Doccheck@sgs.com

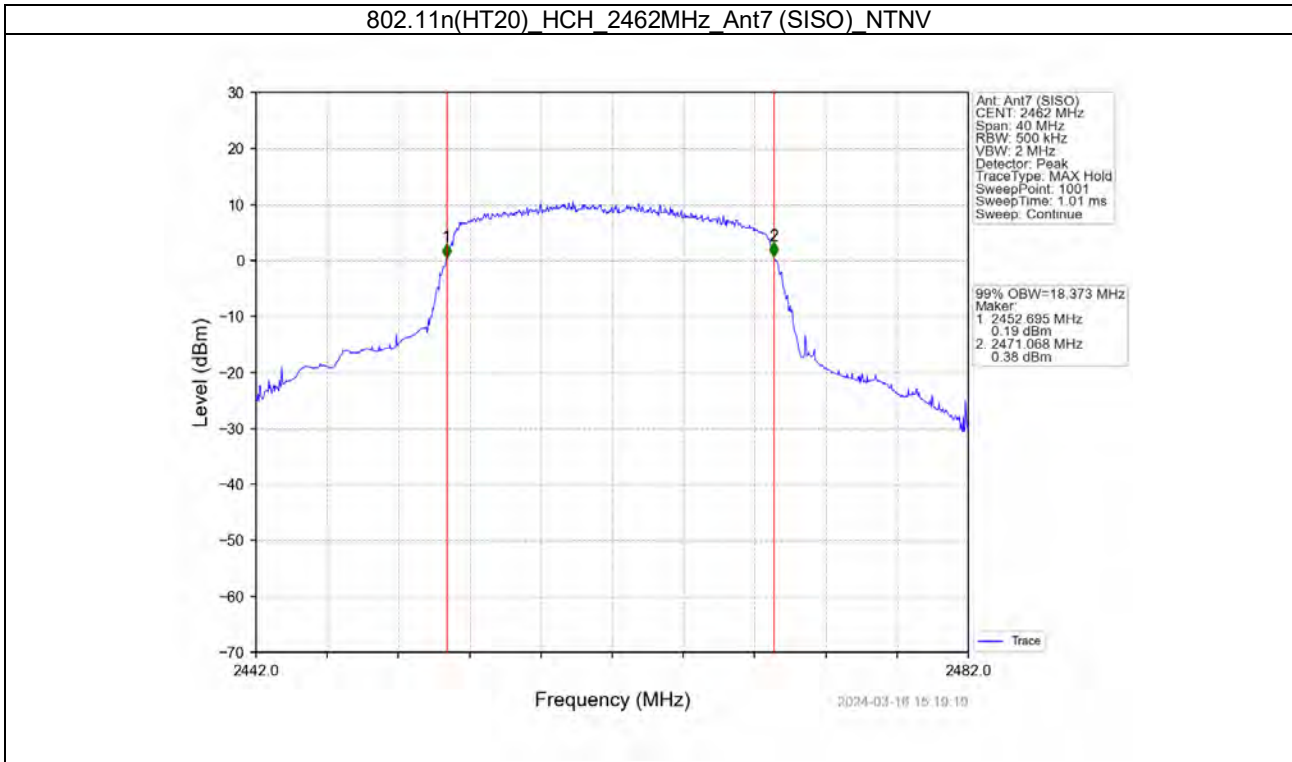
No.1 Workshop, M-10, Middle Section, Science & Technology Park, Nanshan District, Shenzhen, Guangdong, China 518057 t (86-755) 26012053 www.sgs.com.cn  
 中国·广东·深圳市南山区科技园中区M-10栋1号厂房 邮编: 518057 t (86-755) 26012053 sgs.china@sgs.com





**SGS-CSTC Standards Technical Services Co., Ltd.**  
**Shenzhen Branch**

Report No.: SZCR240100035204  
 Page: 43 of 115



Unless otherwise agreed in writing, this document is issued by the Company subject to its General Conditions of Service printed overleaf, available on request or accessible at <https://www.sgs.com/en/Terms-and-Conditions>. Attention is drawn to the limitation of liability, indemnification and jurisdiction issues defined therein. Any holder of this document is advised that information contained hereon reflects the Company's findings at the time of its intervention only and within the limits of Client's instructions, if any. The Company's sole responsibility is to its Client and this document does not exonerate parties to a transaction from exercising all their rights and obligations under the transaction documents. This document cannot be reproduced except in full, without prior written approval of the Company. Any unauthorized alteration, forgery or falsification of the content or appearance of this document is unlawful and offenders may be prosecuted to the fullest extent of the law. Unless otherwise stated the results shown in this test report refer only to the sample(s) tested and such sample(s) are retained for 30 days only.

**Attention: To check the authenticity of testing /inspection report & certificate, please contact us at telephone: (86-755) 8307 1443, or email: CN.Doccheck@sgs.com**

No.1 Workshop, M-10, Middle Section, Science & Technology Park, Nanshan District, Shenzhen, Guangdong, China 518057 t (86-755) 26012053 www.sgs.com.cn  
 中国·广东·深圳市南山区科技园中区M-10栋1号厂房 邮编: 518057 t (86-755) 26012053 sgs.china@sgs.com





# SGS-CSTC Standards Technical Services Co., Ltd. Shenzhen Branch

Report No.: SZCR240100035204  
Page: 44 of 115

6dB BW

## Test Result

Mode	TX Type	Frequency (MHz)	ANT	6dB Bandwidth (MHz)		Verdict
				Result	Limit	
802.11b	SISO	2412	7	8.098	>=0.5	Pass
		2437	7	8.071	>=0.5	Pass
		2462	7	8.094	>=0.5	Pass
802.11g	SISO	2412	7	15.167	>=0.5	Pass
		2437	7	15.162	>=0.5	Pass
		2462	7	15.761	>=0.5	Pass
802.11n (HT20)	SISO	2412	7	15.166	>=0.5	Pass
		2437	7	15.162	>=0.5	Pass
		2462	7	16.130	>=0.5	Pass



Unless otherwise agreed in writing, this document is issued by the Company subject to its General Conditions of Service printed overleaf, available on request or accessible at <https://www.sgs.com/en/Terms-and-Conditions>. Attention is drawn to the limitation of liability, indemnification and jurisdiction issues defined therein. Any holder of this document is advised that information contained hereon reflects the Company's findings at the time of its intervention only and within the limits of Client's instructions, if any. The Company's sole responsibility is to its Client and this document does not exonerate parties to a transaction from exercising all their rights and obligations under the transaction documents. This document cannot be reproduced except in full, without prior written approval of the Company. Any unauthorized alteration, forgery or falsification of the content or appearance of this document is unlawful and offenders may be prosecuted to the fullest extent of the law. Unless otherwise stated the results shown in this test report refer only to the sample(s) tested and such sample(s) are retained for 30 days only.

Attention: To check the authenticity of testing /inspection report & certificate, please contact us at telephone: (86-755) 8307 1443, or email: CN.Doccheck@sgs.com

SGS-CSTC Standards Technical Services Co., Ltd.  
Shenzhen Branch Inspection & Testing Services  
Shenzhen Branch Wireless Laboratory

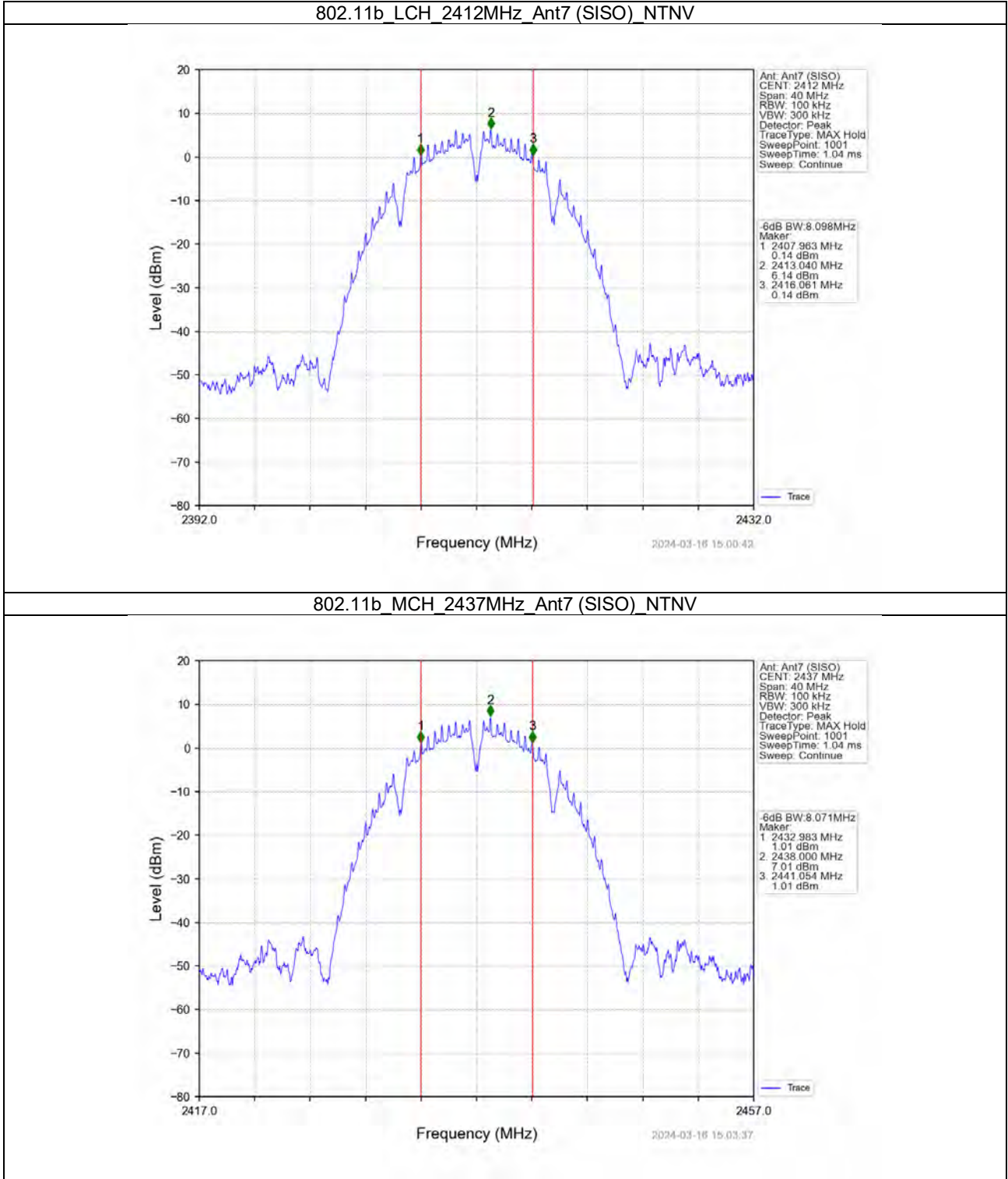
No.1 Workshop, M-10, Middle Section, Science & Technology Park, Nanshan District, Shenzhen, Guangdong, China 518057 t (86-755) 26012053 www.sgsgroup.com.cn  
中国·广东·深圳市南山区科技园中区M-10栋1号厂房 邮编: 518057 t (86-755) 26012053 sgs.china@sgs.com



**SGS-CSTC Standards Technical Services Co., Ltd.**  
**Shenzhen Branch**

Report No.: SZCR240100035204  
 Page: 45 of 115

Test Graph



Unless otherwise agreed in writing, this document is issued by the Company subject to its General Conditions of Service printed overleaf, available on request or accessible at <https://www.sgs.com/en/Terms-and-Conditions>. Attention is drawn to the limitation of liability, indemnification and jurisdiction issues defined therein. Any holder of this document is advised that information contained hereon reflects the Company's findings at the time of its intervention only and within the limits of Client's instructions, if any. The Company's sole responsibility is to its Client and this document does not exonerate parties to a transaction from exercising all their rights and obligations under the transaction documents. This document cannot be reproduced except in full, without prior written approval of the Company. Any unauthorized alteration, forgery or falsification of the content or appearance of this document is unlawful and offenders may be prosecuted to the fullest extent of the law. Unless otherwise stated the results shown in this test report refer only to the sample(s) tested and such sample(s) are retained for 30 days only.

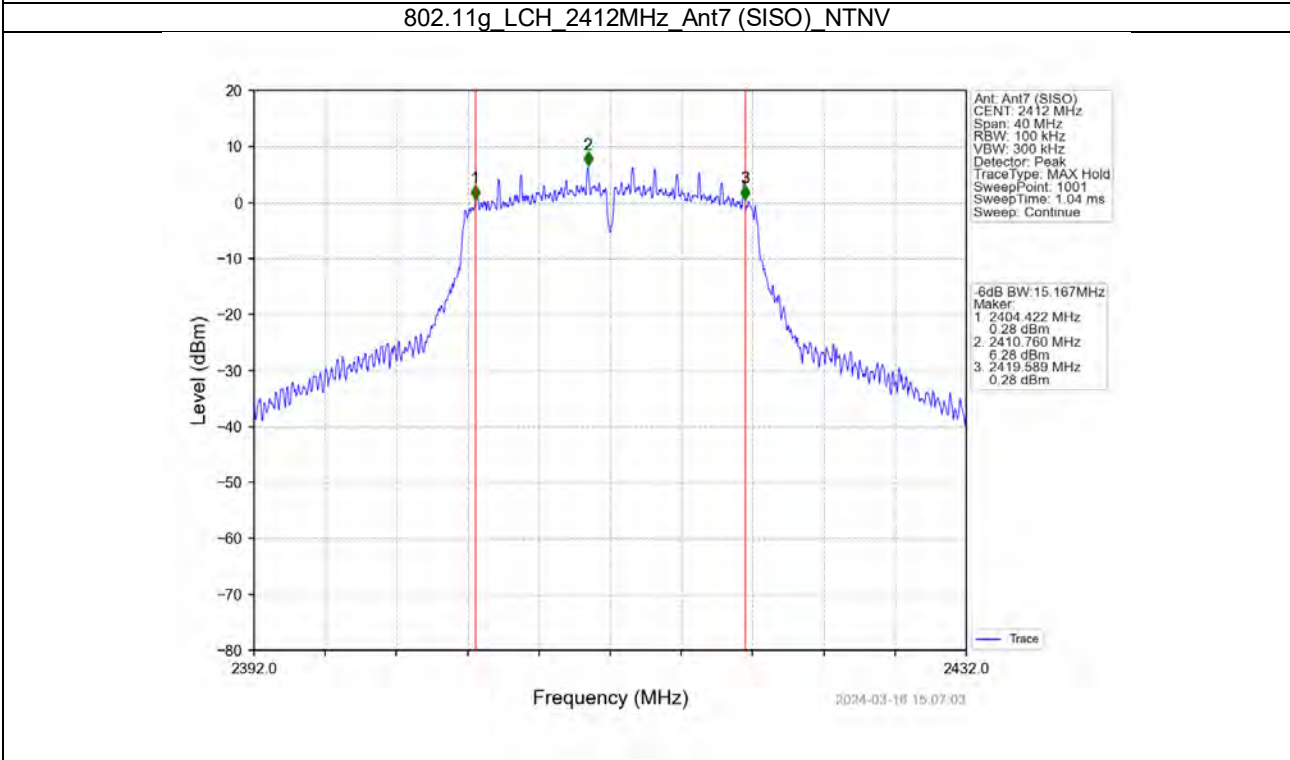
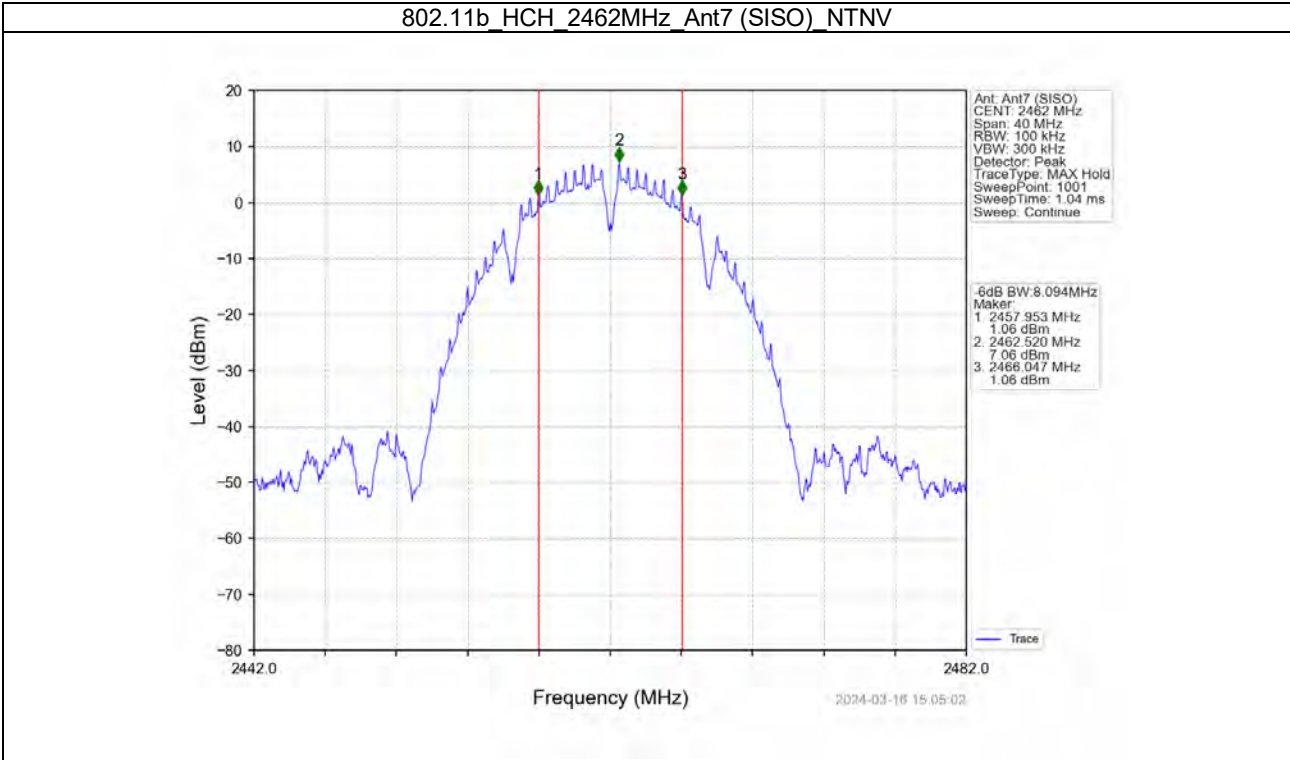
Attention: To check the authenticity of testing /inspection report & certificate, please contact us at telephone: (86-755) 8307 1443, or email: CN.Doccheck@sgs.com

No.1 Workshop, M-10, Middle Section, Science & Technology Park, Nanshan District, Shenzhen, Guangdong, China 518057 t (86-755) 26012053 www.sgs.com.cn  
 中国·广东·深圳市南山区科技园中区M-10栋1号厂房 邮编: 518057 t (86-755) 26012053 sgs.china@sgs.com



**SGS-CSTC Standards Technical Services Co., Ltd.**  
**Shenzhen Branch**

Report No.: SZCR240100035204  
 Page: 46 of 115



Unless otherwise agreed in writing, this document is issued by the Company subject to its General Conditions of Service printed overleaf, available on request or accessible at <https://www.sgs.com/en/Terms-and-Conditions>. Attention is drawn to the limitation of liability, indemnification and jurisdiction issues defined therein. Any holder of this document is advised that information contained hereon reflects the Company's findings at the time of its intervention only and within the limits of Client's instructions, if any. The Company's sole responsibility is to its Client and this document does not exonerate parties to a transaction from exercising all their rights and obligations under the transaction documents. This document cannot be reproduced except in full, without prior written approval of the Company. Any unauthorized alteration, forgery or falsification of the content or appearance of this document is unlawful and offenders may be prosecuted to the fullest extent of the law. Unless otherwise stated the results shown in this test report refer only to the sample(s) tested and such sample(s) are retained for 30 days only.

**Attention: To check the authenticity of testing /inspection report & certificate, please contact us at telephone: (86-755) 8307 1443, or email: CN.Doccheck@sgs.com**

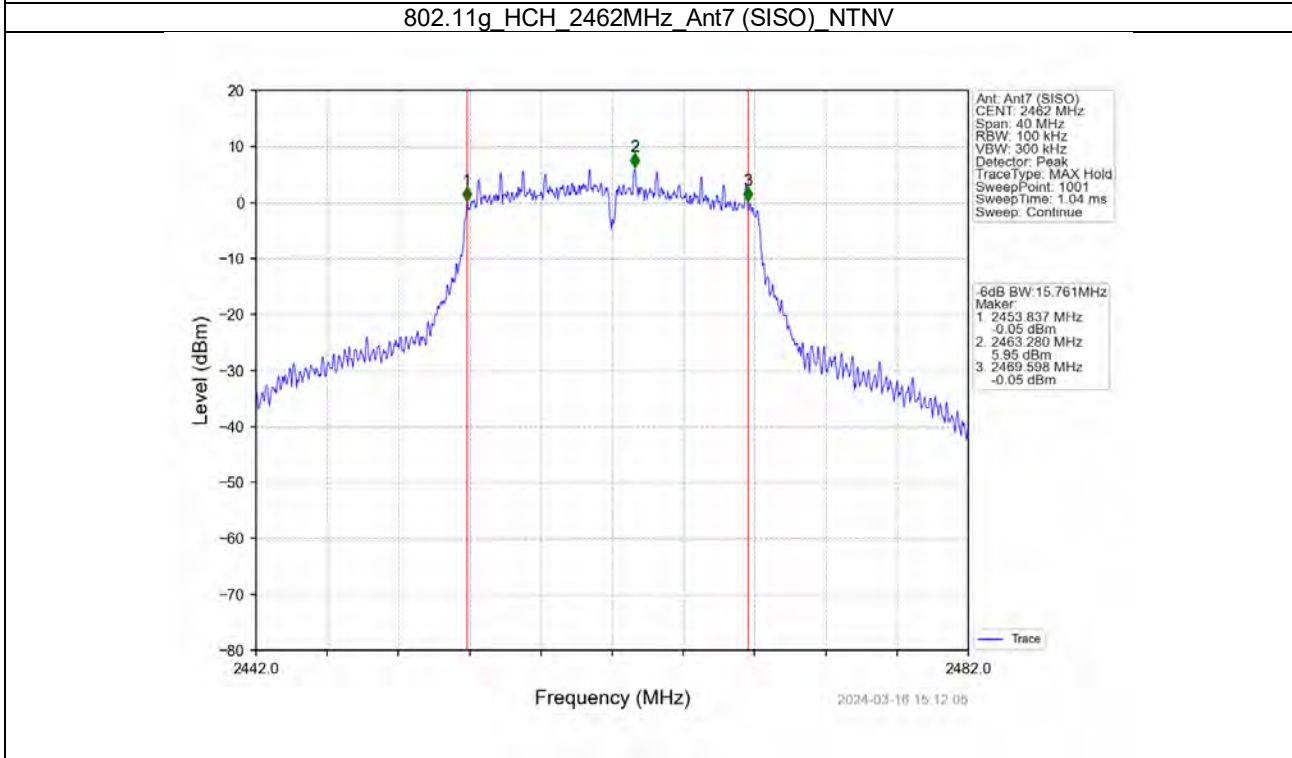
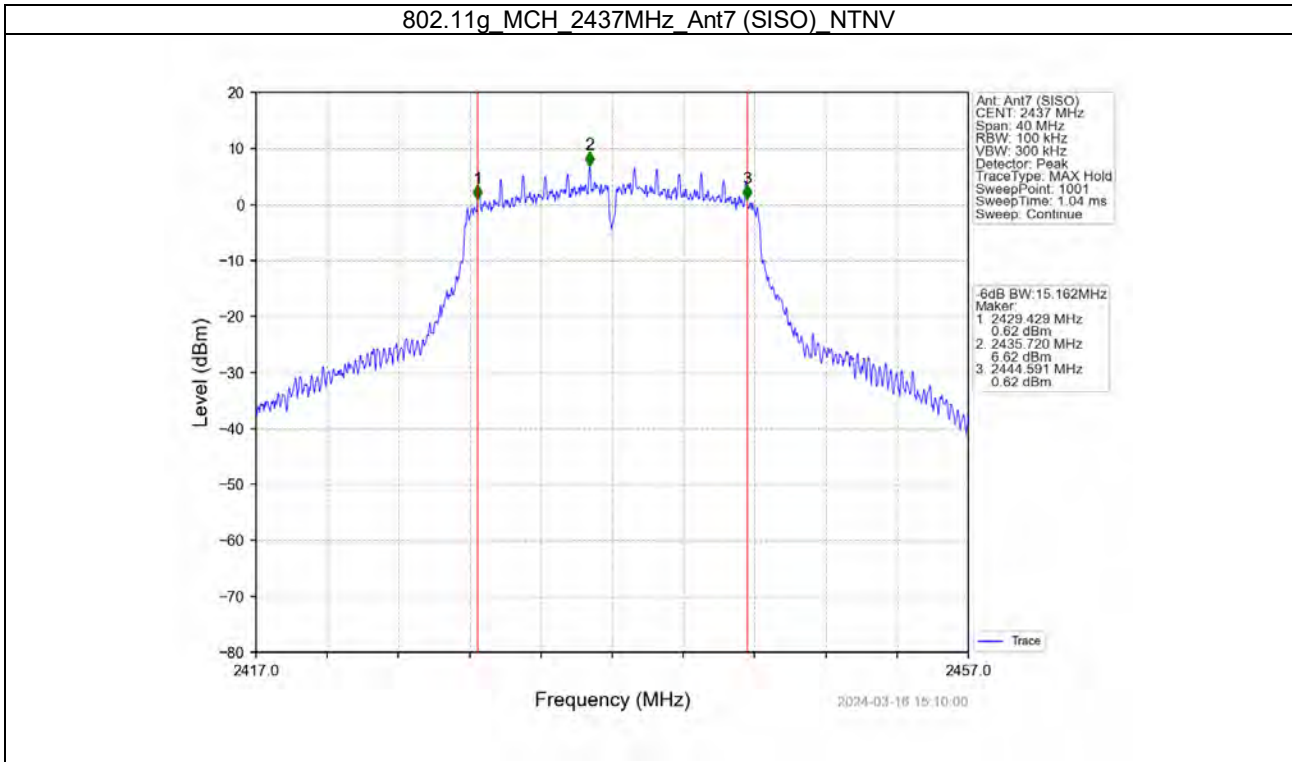
No.1 Workshop, M-10, Middle Section, Science & Technology Park, Nanshan District, Shenzhen, Guangdong, China 518057 t (86-755) 26012053 www.sgs.com.cn  
 中国·广东·深圳市南山区科技园中区M-10栋1号厂房 邮编: 518057 t (86-755) 26012053 sgs.china@sgs.com





**SGS-CSTC Standards Technical Services Co., Ltd.**  
**Shenzhen Branch**

Report No.: SZCR240100035204  
 Page: 47 of 115



Unless otherwise agreed in writing, this document is issued by the Company subject to its General Conditions of Service printed overleaf, available on request or accessible at <https://www.sgs.com/en/Terms-and-Conditions>. Attention is drawn to the limitation of liability, indemnification and jurisdiction issues defined therein. Any holder of this document is advised that information contained hereon reflects the Company's findings at the time of its intervention only and within the limits of Client's instructions, if any. The Company's sole responsibility is to its Client and this document does not exonerate parties to a transaction from exercising all their rights and obligations under the transaction documents. This document cannot be reproduced except in full, without prior written approval of the Company. Any unauthorized alteration, forgery or falsification of the content or appearance of this document is unlawful and offenders may be prosecuted to the fullest extent of the law. Unless otherwise stated the results shown in this test report refer only to the sample(s) tested and such sample(s) are retained for 30 days only.

**Attention: To check the authenticity of testing /inspection report & certificate, please contact us at telephone: (86-755) 8307 1443, or email: CN.Doccheck@sgs.com**

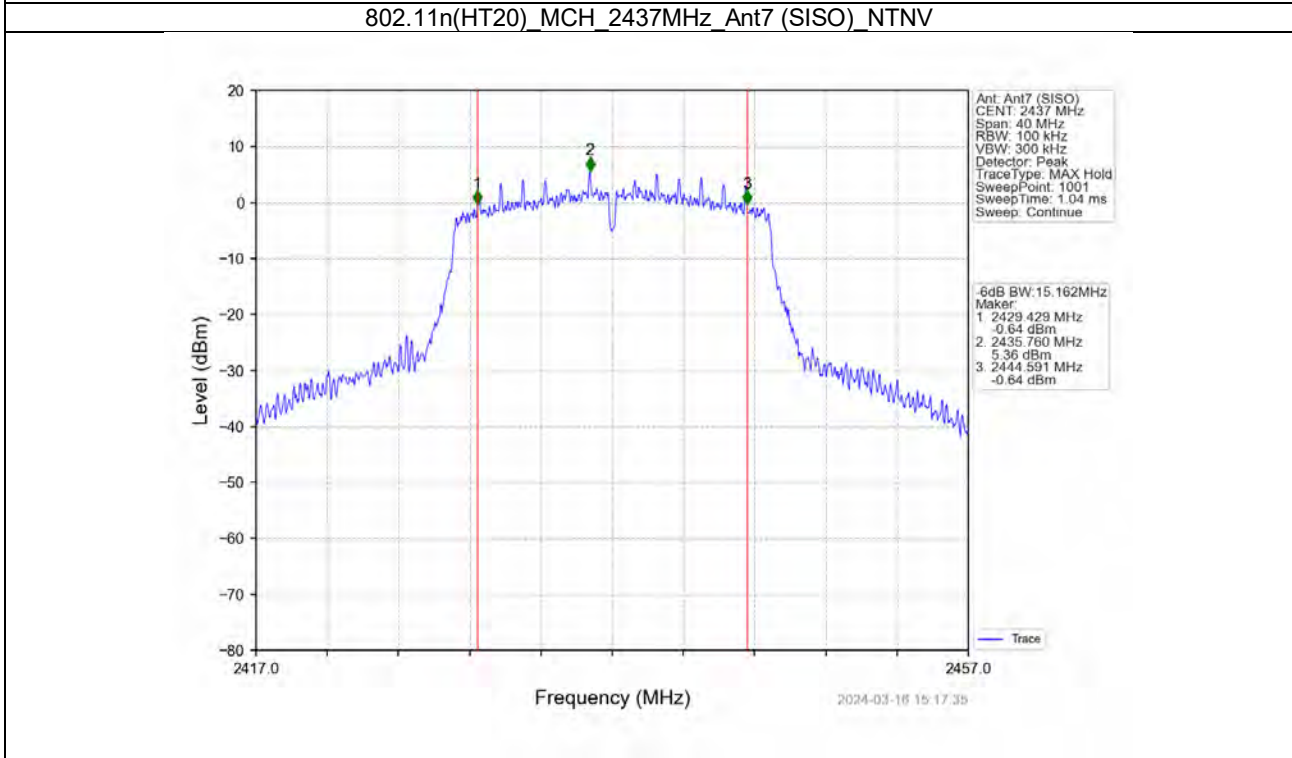
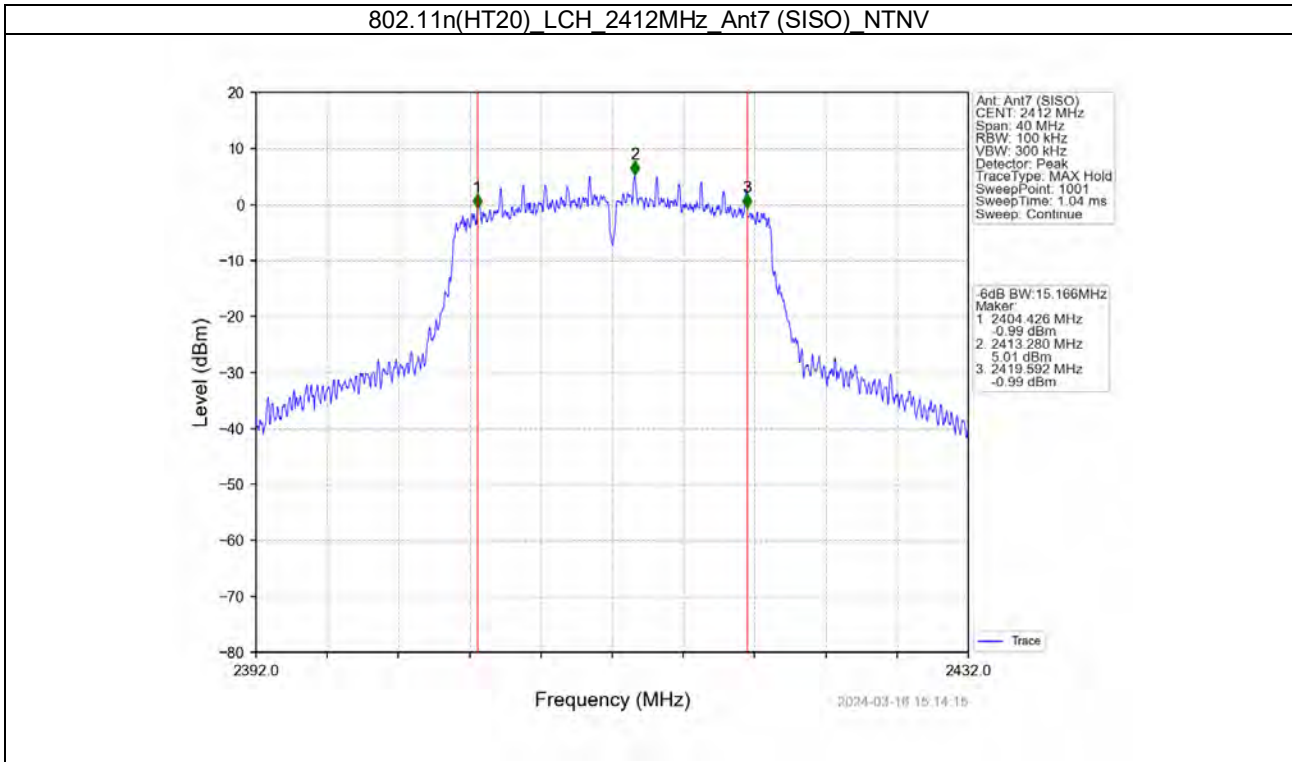
No.1 Workshop, M-10, Middle Section, Science & Technology Park, Nanshan District, Shenzhen, Guangdong, China 518057 t (86-755) 26012053 www.sgs.com.cn  
 中国·广东·深圳市南山区科技园中区M-10栋1号厂房 邮编: 518057 t (86-755) 26012053 sgs.china@sgs.com





**SGS-CSTC Standards Technical Services Co., Ltd.**  
**Shenzhen Branch**

Report No.: SZCR240100035204  
 Page: 48 of 115



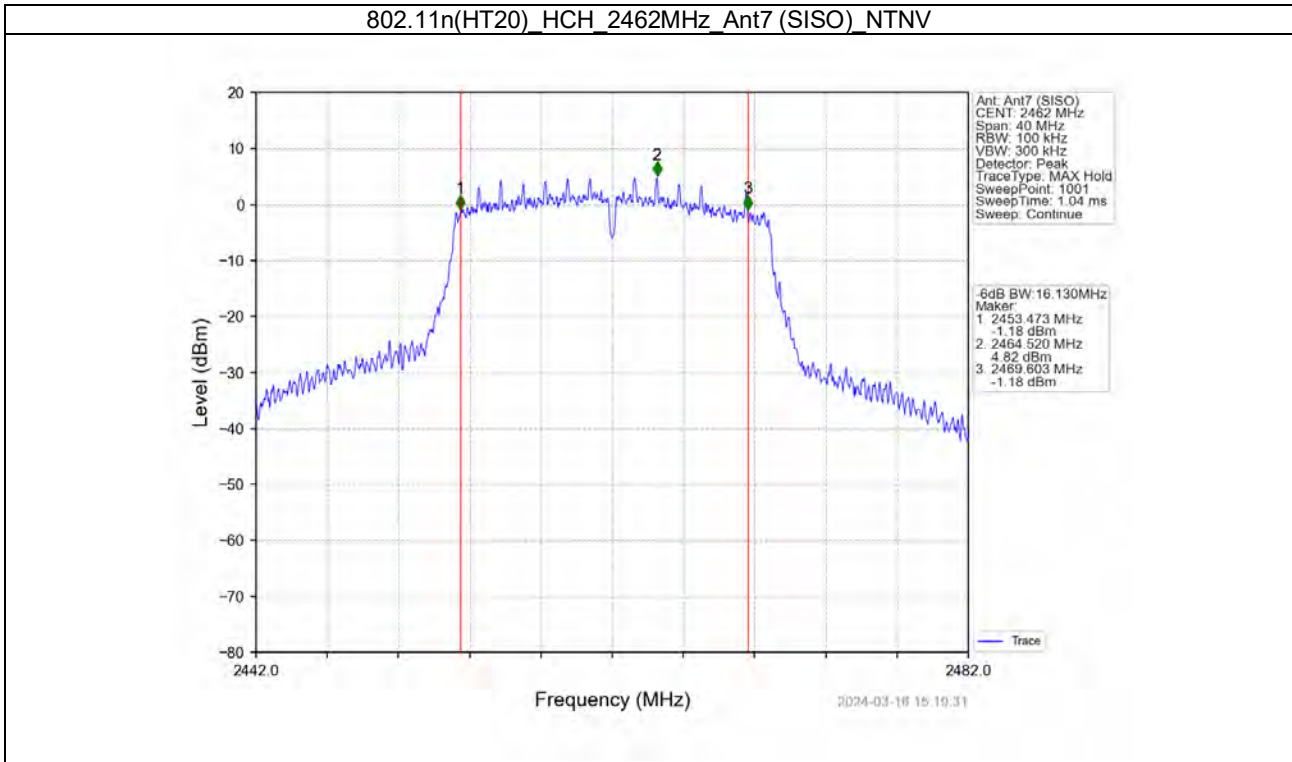
Unless otherwise agreed in writing, this document is issued by the Company subject to its General Conditions of Service printed overleaf, available on request or accessible at <https://www.sgs.com/en/Terms-and-Conditions>. Attention is drawn to the limitation of liability, indemnification and jurisdiction issues defined therein. Any holder of this document is advised that information contained hereon reflects the Company's findings at the time of its intervention only and within the limits of Client's instructions, if any. The Company's sole responsibility is to its Client and this document does not exonerate parties to a transaction from exercising all their rights and obligations under the transaction documents. This document cannot be reproduced except in full, without prior written approval of the Company. Any unauthorized alteration, forgery or falsification of the content or appearance of this document is unlawful and offenders may be prosecuted to the fullest extent of the law. Unless otherwise stated the results shown in this test report refer only to the sample(s) tested and such sample(s) are retained for 30 days only.

Attention: To check the authenticity of testing /inspection report & certificate, please contact us at telephone: (86-755) 8307 1443, or email: CN.Doccheck@sgs.com  
 No.1 Workshop, M-10, Middle Section, Science & Technology Park, Nanshan District, Shenzhen, Guangdong, China 518057 t (86-755) 26012053 www.sgs.com.cn  
 中国·广东·深圳市南山区科技园中区M-10栋1号厂房 邮编: 518057 t (86-755) 26012053 sgs.china@sgs.com



**SGS-CSTC Standards Technical Services Co., Ltd.**  
**Shenzhen Branch**

Report No.: SZCR240100035204  
 Page: 49 of 115



Unless otherwise agreed in writing, this document is issued by the Company subject to its General Conditions of Service printed overleaf, available on request or accessible at <https://www.sgs.com/en/Terms-and-Conditions>. Attention is drawn to the limitation of liability, indemnification and jurisdiction issues defined therein. Any holder of this document is advised that information contained hereon reflects the Company's findings at the time of its intervention only and within the limits of Client's instructions, if any. The Company's sole responsibility is to its Client and this document does not exonerate parties to a transaction from exercising all their rights and obligations under the transaction documents. This document cannot be reproduced except in full, without prior written approval of the Company. Any unauthorized alteration, forgery or falsification of the content or appearance of this document is unlawful and offenders may be prosecuted to the fullest extent of the law. Unless otherwise stated the results shown in this test report refer only to the sample(s) tested and such sample(s) are retained for 30 days only.

**Attention: To check the authenticity of testing /inspection report & certificate, please contact us at telephone: (86-755) 8307 1443, or email: CN.Doccheck@sgs.com**

No.1 Workshop, M-10, Middle Section, Science & Technology Park, Nanshan District, Shenzhen, Guangdong, China 518057 t (86-755) 26012053 www.sgs.com.cn  
 中国·广东·深圳市南山区科技园中区M-10栋1号厂房 邮编: 518057 t (86-755) 26012053 sgs.china@sgs.com


 Report No.: SZCR240100035204  
 Page: 50 of 115

## Maximum Conducted Output Power

### Power

### Test Result

Mode	TX Type	Frequency (MHz)	Maximum Average Conducted Output Power (dBm)		Verdict
			ANT7	Limit	
802.11b	SISO	2412	14.23	<=30	Pass
		2437	14.56	<=30	Pass
		2462	14.58	<=30	Pass
802.11g	SISO	2412	16.29	<=30	Pass
		2437	16.57	<=30	Pass
		2462	16.33	<=30	Pass
802.11n (HT20)	SISO	2412	15.04	<=30	Pass
		2437	15.37	<=30	Pass
		2462	15.38	<=30	Pass

Note1: Antenna Gain: Ant7: -0.80dBi;



Unless otherwise agreed in writing, this document is issued by the Company subject to its General Conditions of Service printed overleaf, available on request or accessible at <https://www.sgs.com/en/Terms-and-Conditions>. Attention is drawn to the limitation of liability, indemnification and jurisdiction issues defined therein. Any holder of this document is advised that information contained hereon reflects the Company's findings at the time of its intervention only and within the limits of Client's instructions, if any. The Company's sole responsibility is to its Client and this document does not exonerate parties to a transaction from exercising all their rights and obligations under the transaction documents. This document cannot be reproduced except in full, without prior written approval of the Company. Any unauthorized alteration, forgery or falsification of the content or appearance of this document is unlawful and offenders may be prosecuted to the fullest extent of the law. Unless otherwise stated the results shown in this test report refer only to the sample(s) tested and such sample(s) are retained for 30 days only.

Attention: To check the authenticity of testing /inspection report & certificate, please contact us at telephone: (86-755) 8307 1443, or email: CN.Doccheck@sgs.com

No.1 Workshop, M-10, Middle Section, Science & Technology Park, Nanshan District, Shenzhen, Guangdong, China 518057 t (86-755) 26012053 www.sgs.com.cn  
 中国·广东·深圳市南山区科技园中区M-10栋1号厂房 邮编: 518057 t (86-755) 26012053 sgs.china@sgs.com


 Report No.: SZCR240100035204  
 Page: 51 of 115

## Maximum Power Spectral Density

### PSD

### Test Result

Mode	TX Type	Frequency (MHz)	Maximum PSD (dBm/3kHz)		Verdict
			ANT7	Limit	
802.11b	SISO	2412	-8.25	<=8	Pass
		2437	-6.34	<=8	Pass
		2462	-7.19	<=8	Pass
802.11g	SISO	2412	-8.21	<=8	Pass
		2437	-8.14	<=8	Pass
		2462	-7.67	<=8	Pass
802.11n (HT20)	SISO	2412	-9.69	<=8	Pass
		2437	-9.41	<=8	Pass
		2462	-9.12	<=8	Pass

Note1: Antenna Gain: Ant7: -0.80dBi;



Unless otherwise agreed in writing, this document is issued by the Company subject to its General Conditions of Service printed overleaf, available on request or accessible at <https://www.sgs.com/en/Terms-and-Conditions>. Attention is drawn to the limitation of liability, indemnification and jurisdiction issues defined therein. Any holder of this document is advised that information contained hereon reflects the Company's findings at the time of its intervention only and within the limits of Client's instructions, if any. The Company's sole responsibility is to its Client and this document does not exonerate parties to a transaction from exercising all their rights and obligations under the transaction documents. This document cannot be reproduced except in full, without prior written approval of the Company. Any unauthorized alteration, forgery or falsification of the content or appearance of this document is unlawful and offenders may be prosecuted to the fullest extent of the law. Unless otherwise stated the results shown in this test report refer only to the sample(s) tested and such sample(s) are retained for 30 days only.

Attention: To check the authenticity of testing /inspection report & certificate, please contact us at telephone: (86-755) 8307 1443, or email: CN.Doccheck@sgs.com

No.1 Workshop, M-10, Middle Section, Science & Technology Park, Nanshan District, Shenzhen, Guangdong, China 518057 t (86-755) 26012053 www.sgs.com.cn  
 中国·广东·深圳市南山区科技园中区M-10栋1号厂房 邮编: 518057 t (86-755) 26012053 sgs.china@sgs.com

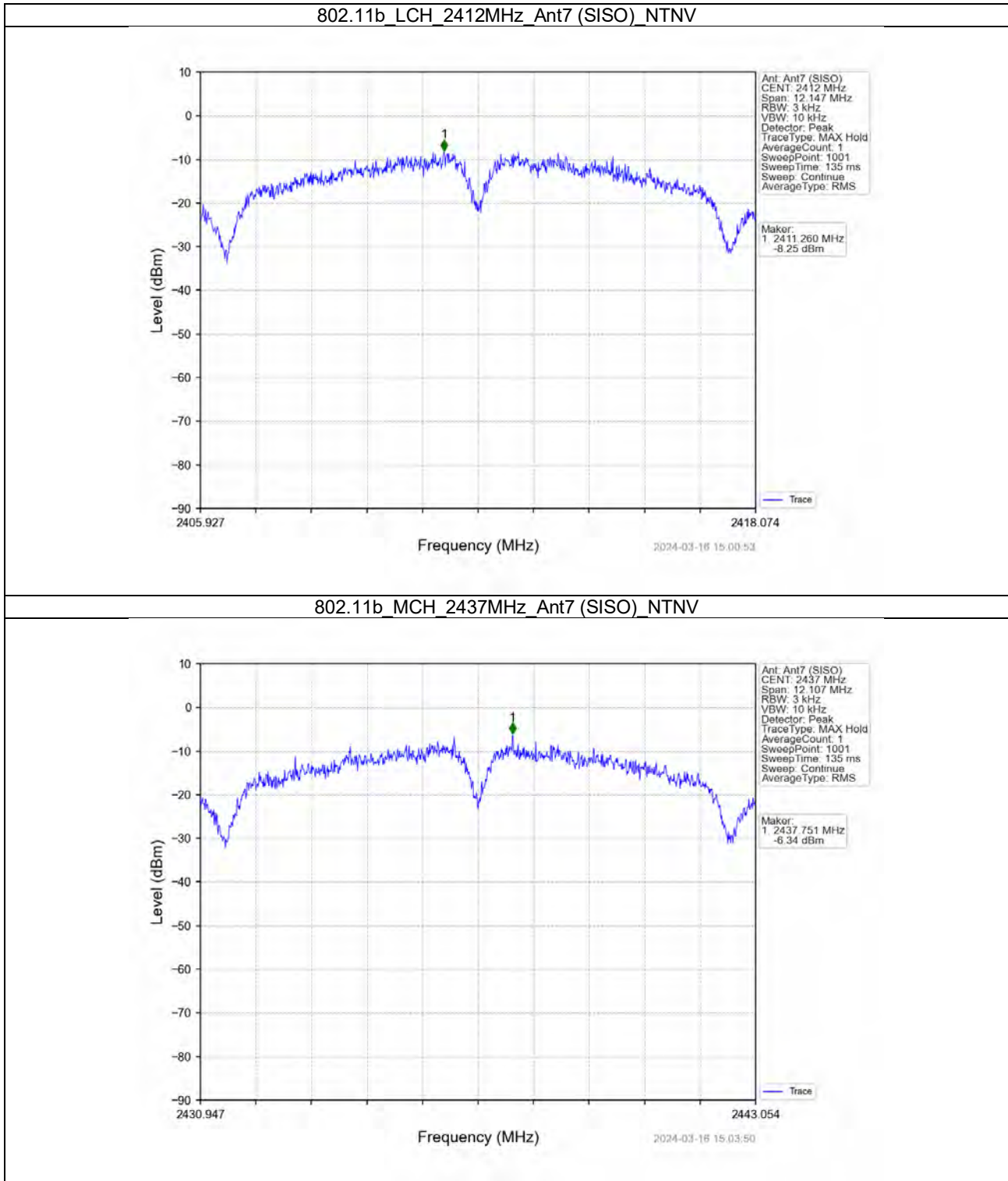




**SGS-CSTC Standards Technical Services Co., Ltd.**  
**Shenzhen Branch**

Report No.: SZCR240100035204  
 Page: 52 of 115

Test Graph



Unless otherwise agreed in writing, this document is issued by the Company subject to its General Conditions of Service printed overleaf, available on request or accessible at <https://www.sgs.com/en/Terms-and-Conditions>. Attention is drawn to the limitation of liability, indemnification and jurisdiction issues defined therein. Any holder of this document is advised that information contained hereon reflects the Company's findings at the time of its intervention only and within the limits of Client's instructions, if any. The Company's sole responsibility is to its Client and this document does not exonerate parties to a transaction from exercising all their rights and obligations under the transaction documents. This document cannot be reproduced except in full, without prior written approval of the Company. Any unauthorized alteration, forgery or falsification of the content or appearance of this document is unlawful and offenders may be prosecuted to the fullest extent of the law. Unless otherwise stated the results shown in this test report refer only to the sample(s) tested and such sample(s) are retained for 30 days only.

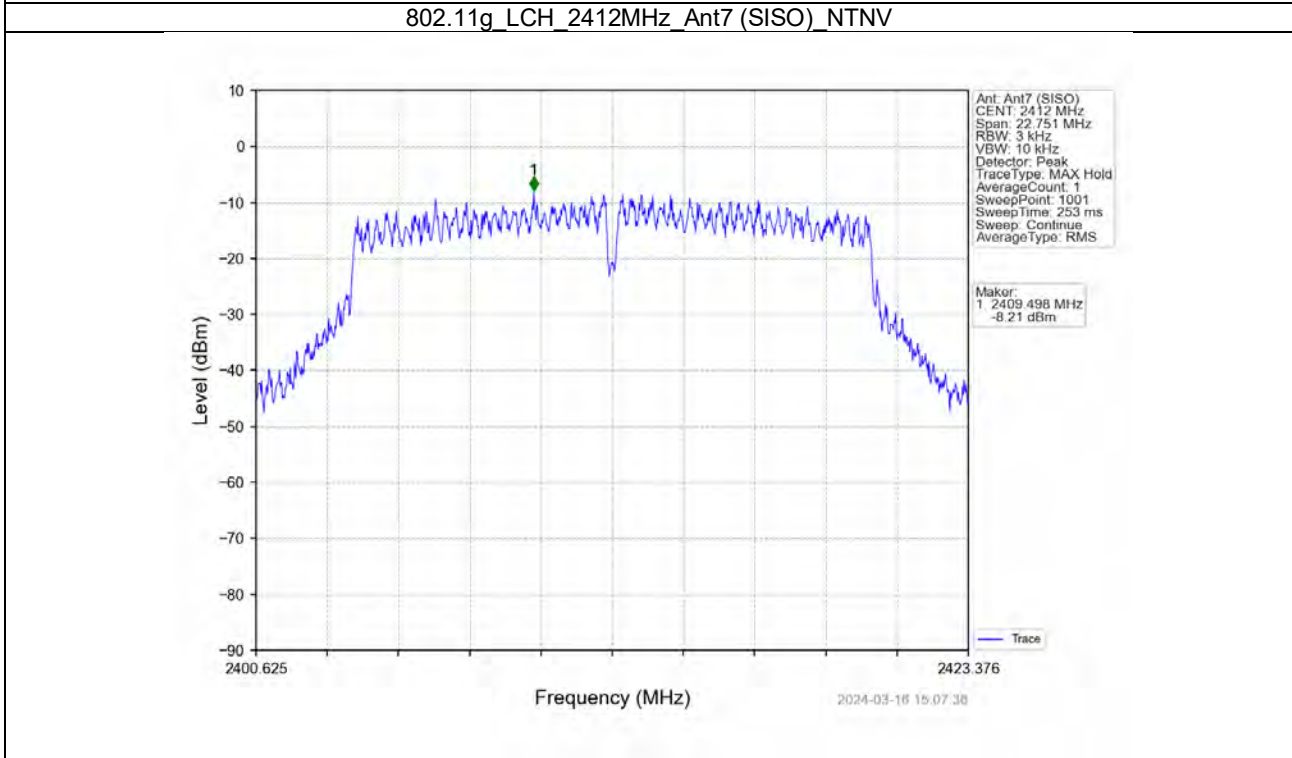
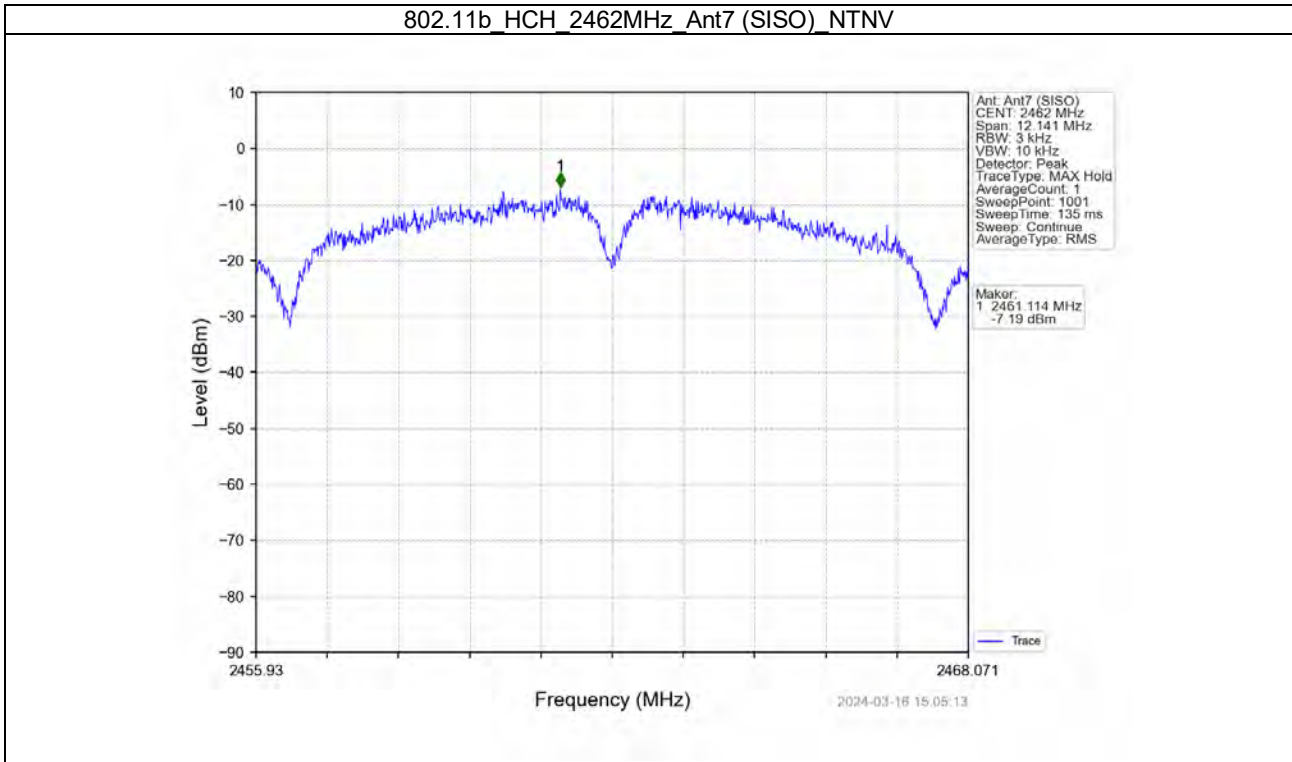
Attention: To check the authenticity of testing /inspection report & certificate, please contact us at telephone: (86-755) 8307 1443, or email: CN.Doccheck@sgs.com

No.1 Workshop, M-10, Middle Section, Science & Technology Park, Nanshan District, Shenzhen, Guangdong, China 518057 t (86-755) 26012053 www.sgs.com.cn  
 中国·广东·深圳市南山区科技园中区M-10栋1号厂房 邮编: 518057 t (86-755) 26012053 sgs.china@sgs.com



**SGS-CSTC Standards Technical Services Co., Ltd.**  
**Shenzhen Branch**

Report No.: SZCR240100035204  
 Page: 53 of 115



Unless otherwise agreed in writing, this document is issued by the Company subject to its General Conditions of Service printed overleaf, available on request or accessible at <https://www.sgs.com/en/Terms-and-Conditions>. Attention is drawn to the limitation of liability, indemnification and jurisdiction issues defined therein. Any holder of this document is advised that information contained hereon reflects the Company's findings at the time of its intervention only and within the limits of Client's instructions, if any. The Company's sole responsibility is to its Client and this document does not exonerate parties to a transaction from exercising all their rights and obligations under the transaction documents. This document cannot be reproduced except in full, without prior written approval of the Company. Any unauthorized alteration, forgery or falsification of the content or appearance of this document is unlawful and offenders may be prosecuted to the fullest extent of the law. Unless otherwise stated the results shown in this test report refer only to the sample(s) tested and such sample(s) are retained for 30 days only.

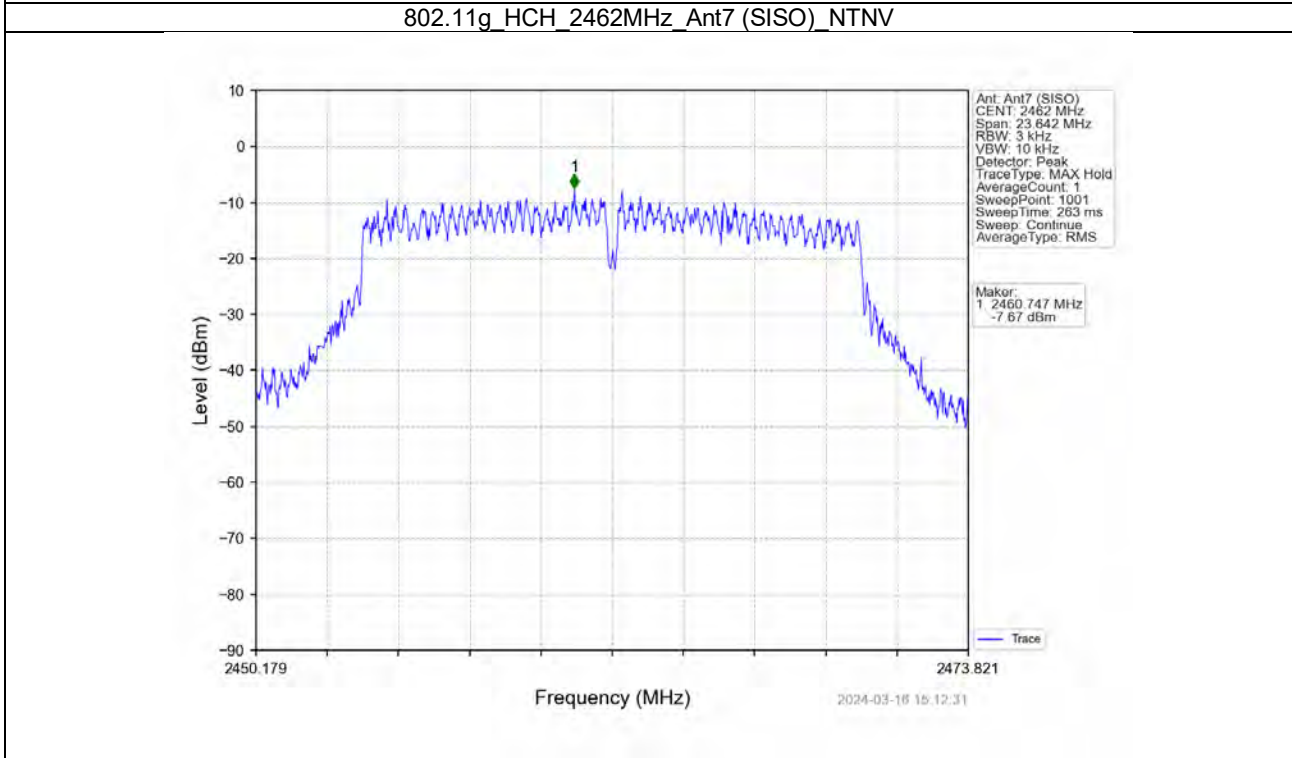
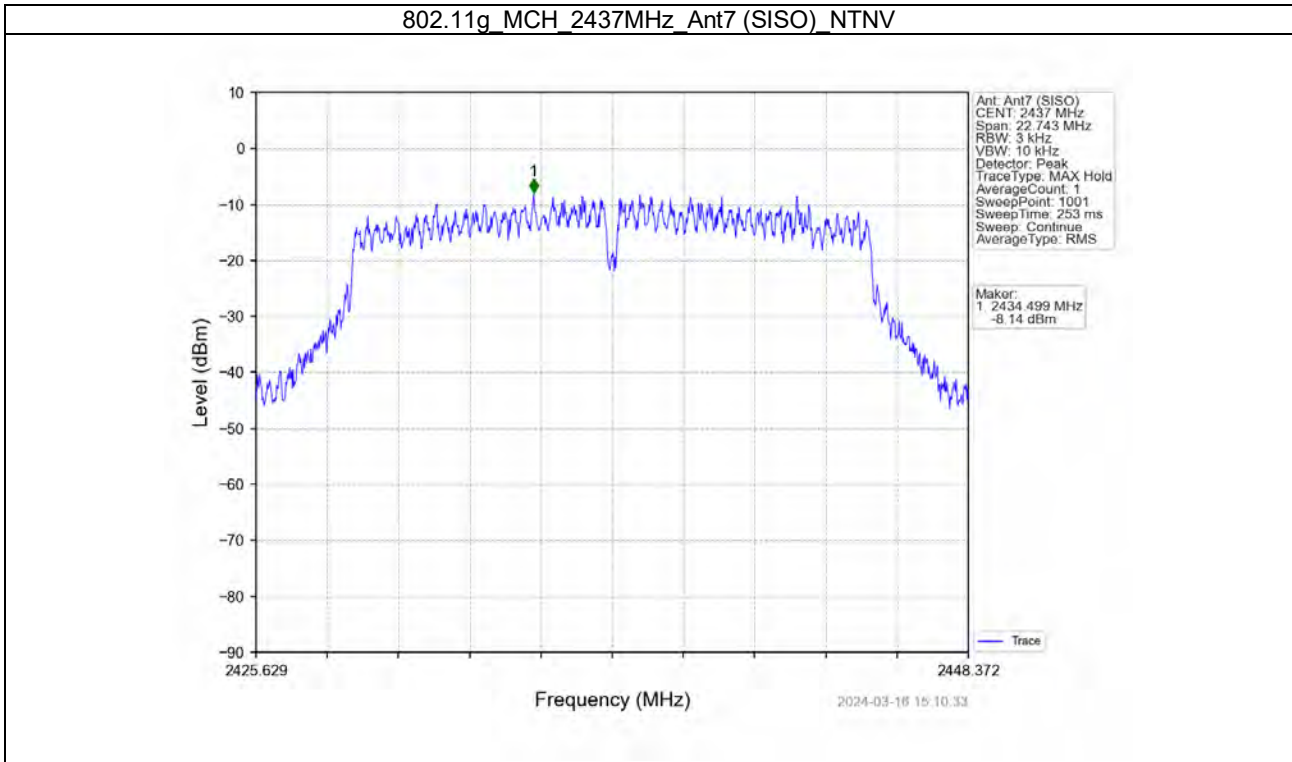
**Attention: To check the authenticity of testing /inspection report & certificate, please contact us at telephone: (86-755) 8307 1443, or email: CN.Doccheck@sgs.com**

No.1 Workshop, M-10, Middle Section, Science & Technology Park, Nanshan District, Shenzhen, Guangdong, China 518057 t (86-755) 26012053 www.sgs.com.cn  
 中国·广东·深圳市南山区科技园中区M-10栋1号厂房 邮编: 518057 t (86-755) 26012053 sgs.china@sgs.com



**SGS-CSTC Standards Technical Services Co., Ltd.**  
**Shenzhen Branch**

Report No.: SZCR240100035204  
 Page: 54 of 115



Unless otherwise agreed in writing, this document is issued by the Company subject to its General Conditions of Service printed overleaf, available on request or accessible at <https://www.sgs.com/en/Terms-and-Conditions>. Attention is drawn to the limitation of liability, indemnification and jurisdiction issues defined therein. Any holder of this document is advised that information contained hereon reflects the Company's findings at the time of its intervention only and within the limits of Client's instructions, if any. The Company's sole responsibility is to its Client and this document does not exonerate parties to a transaction from exercising all their rights and obligations under the transaction documents. This document cannot be reproduced except in full, without prior written approval of the Company. Any unauthorized alteration, forgery or falsification of the content or appearance of this document is unlawful and offenders may be prosecuted to the fullest extent of the law. Unless otherwise stated the results shown in this test report refer only to the sample(s) tested and such sample(s) are retained for 30 days only.

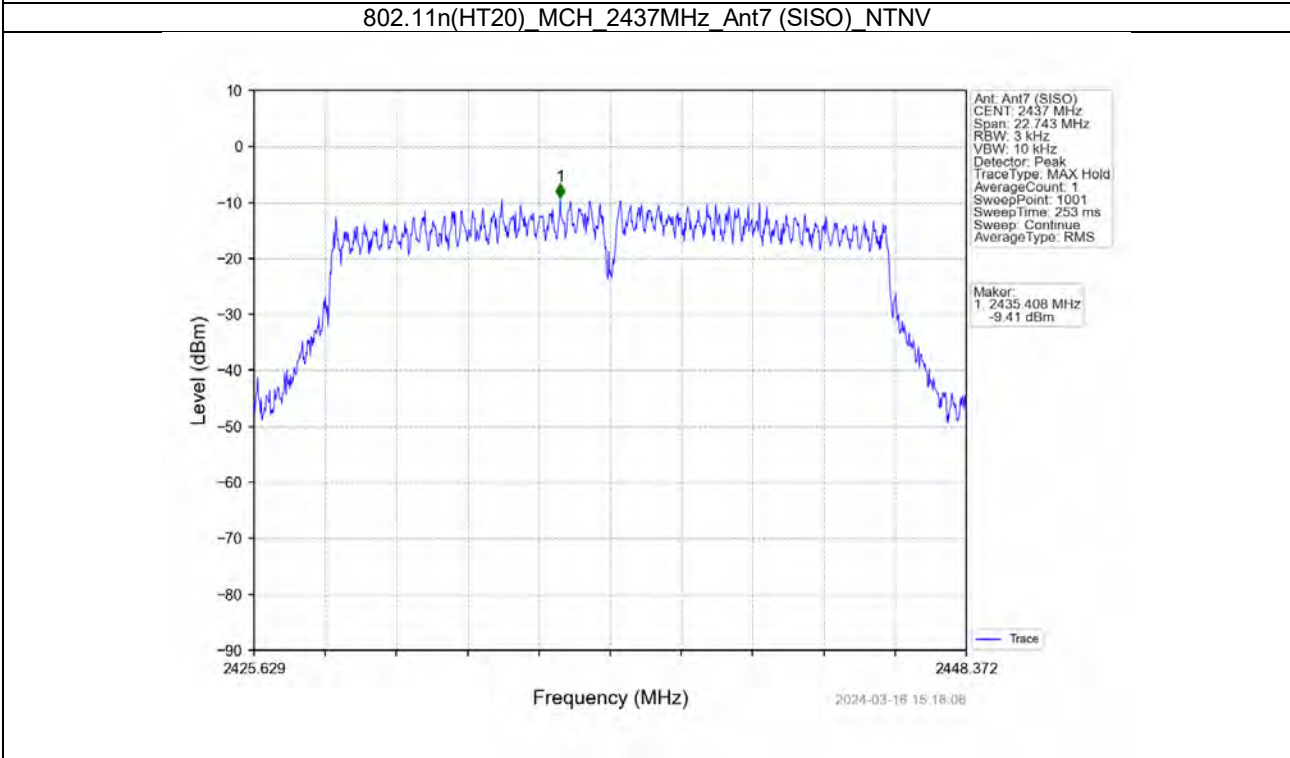
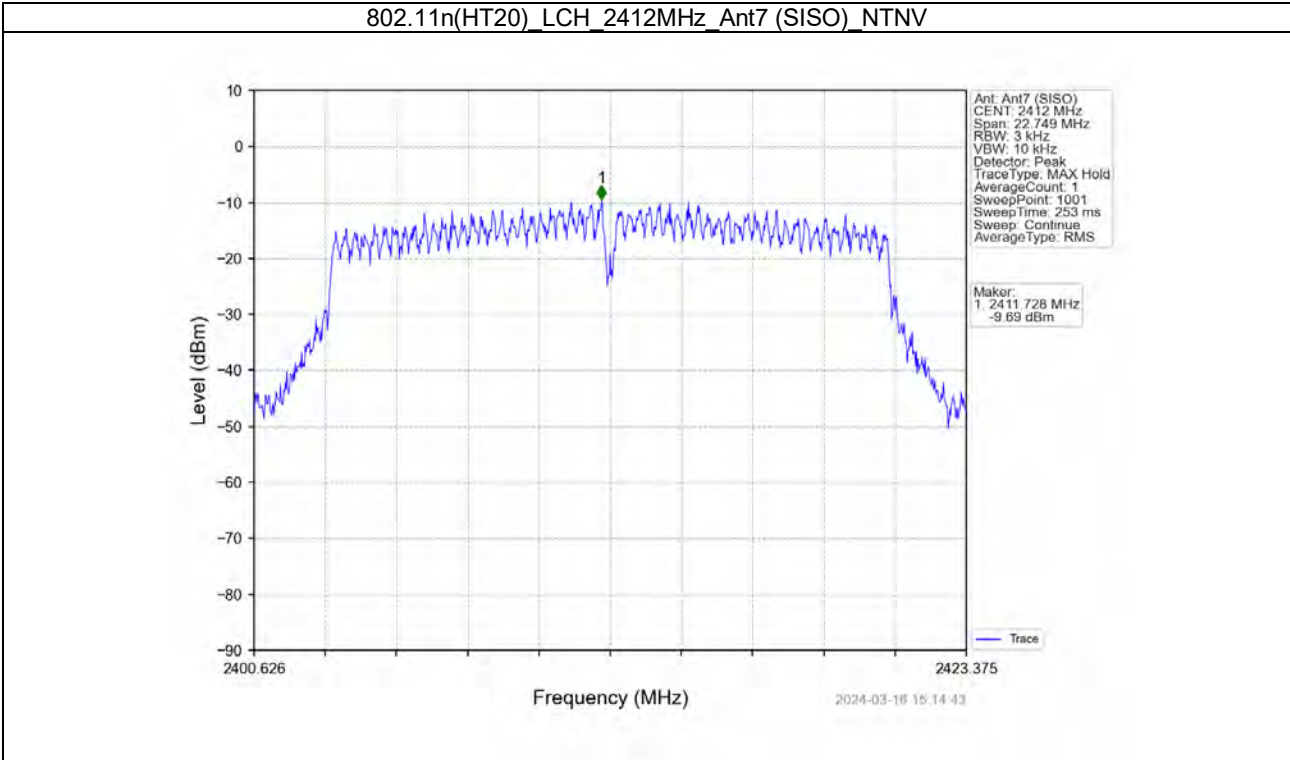
Attention: To check the authenticity of testing /inspection report & certificate, please contact us at telephone: (86-755) 8307 1443, or email: CN.Doccheck@sgs.com  
 No.1 Workshop, M-10, Middle Section, Science & Technology Park, Nanshan District, Shenzhen, Guangdong, China 518057 t (86-755) 26012053 www.sgs.com.cn  
 中国·广东·深圳市南山区科技园中区M-10栋1号厂房 邮编: 518057 t (86-755) 26012053 sgs.china@sgs.com





**SGS-CSTC Standards Technical Services Co., Ltd.**  
**Shenzhen Branch**

Report No.: SZCR240100035204  
 Page: 55 of 115



Unless otherwise agreed in writing, this document is issued by the Company subject to its General Conditions of Service printed overleaf, available on request or accessible at <https://www.sgs.com/en/Terms-and-Conditions>. Attention is drawn to the limitation of liability, indemnification and jurisdiction issues defined therein. Any holder of this document is advised that information contained hereon reflects the Company's findings at the time of its intervention only and within the limits of Client's instructions, if any. The Company's sole responsibility is to its Client and this document does not exonerate parties to a transaction from exercising all their rights and obligations under the transaction documents. This document cannot be reproduced except in full, without prior written approval of the Company. Any unauthorized alteration, forgery or falsification of the content or appearance of this document is unlawful and offenders may be prosecuted to the fullest extent of the law. Unless otherwise stated the results shown in this test report refer only to the sample(s) tested and such sample(s) are retained for 30 days only.

**Attention: To check the authenticity of testing /inspection report & certificate, please contact us at telephone: (86-755) 8307 1443, or email: CN.Doccheck@sgs.com**

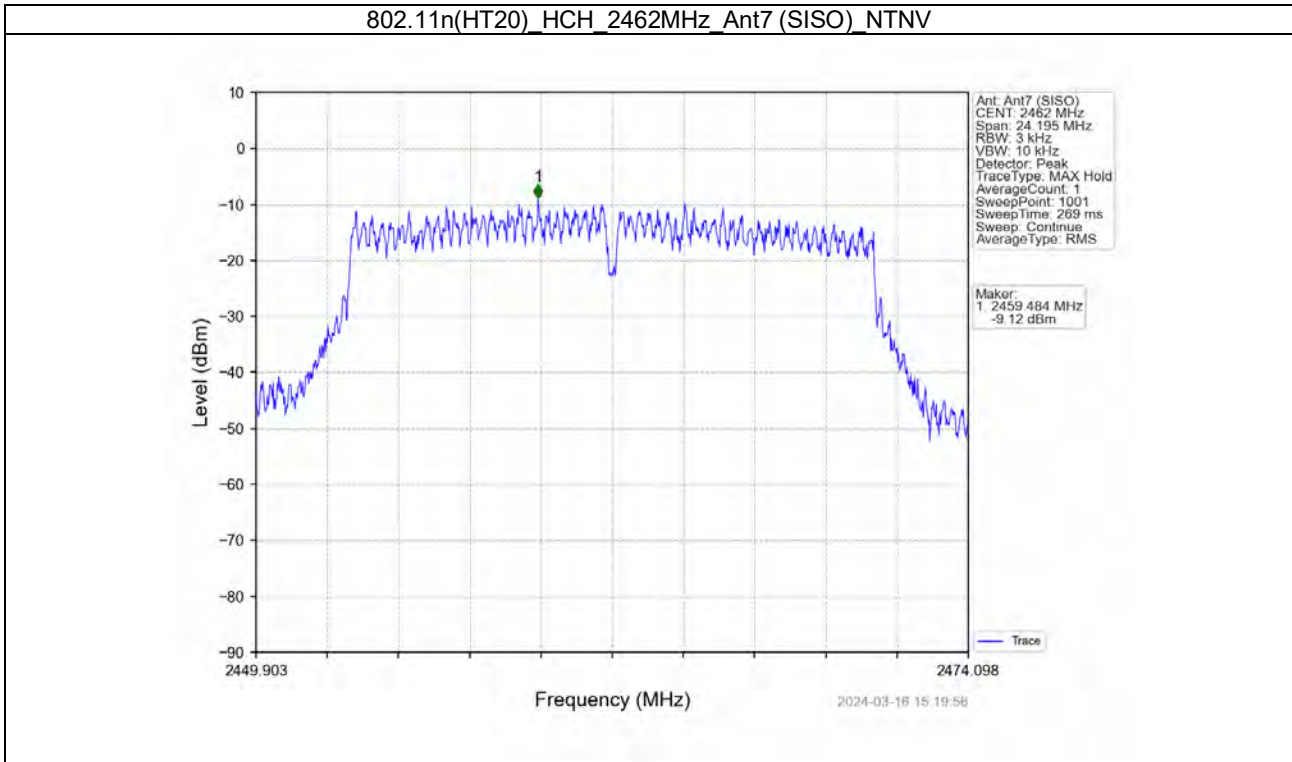
No.1 Workshop, M-10, Middle Section, Science & Technology Park, Nanshan District, Shenzhen, Guangdong, China 518057 t (86-755) 26012053 www.sgs.com.cn  
 中国·广东·深圳市南山区科技园中区M-10栋1号厂房 邮编: 518057 t (86-755) 26012053 sgs.china@sgs.com





**SGS-CSTC Standards Technical Services Co., Ltd.**  
**Shenzhen Branch**

Report No.: SZCR240100035204  
 Page: 56 of 115



Unless otherwise agreed in writing, this document is issued by the Company subject to its General Conditions of Service printed overleaf, available on request or accessible at <https://www.sgs.com/en/Terms-and-Conditions>. Attention is drawn to the limitation of liability, indemnification and jurisdiction issues defined therein. Any holder of this document is advised that information contained hereon reflects the Company's findings at the time of its intervention only and within the limits of Client's instructions, if any. The Company's sole responsibility is to its Client and this document does not exonerate parties to a transaction from exercising all their rights and obligations under the transaction documents. This document cannot be reproduced except in full, without prior written approval of the Company. Any unauthorized alteration, forgery or falsification of the content or appearance of this document is unlawful and offenders may be prosecuted to the fullest extent of the law. Unless otherwise stated the results shown in this test report refer only to the sample(s) tested and such sample(s) are retained for 30 days only.

**Attention: To check the authenticity of testing /inspection report & certificate, please contact us at telephone: (86-755) 8307 1443, or email: CN.Doccheck@sgs.com**

No.1 Workshop, M-10, Middle Section, Science & Technology Park, Nanshan District, Shenzhen, Guangdong, China 518057 t (86-755) 26012053 www.sgs.com.cn  
 中国·广东·深圳市南山区科技园中区M-10栋1号厂房 邮编: 518057 t (86-755) 26012053 sgs.china@sgs.com


 Report No.: SZCR240100035204  
 Page: 57 of 115

## Unwanted Emissions In Non-restricted Frequency Bands

Ref

### Test Result

Mode	TX Type	Frequency (MHz)	ANT	Level of Reference (dBm)
802.11b	SISO	2412	7	6.27
		2437	7	6.78
		2462	7	6.77
802.11g	SISO	2412	7	6.08
		2437	7	6.56
		2462	7	5.78
802.11n (HT20)	SISO	2412	7	4.97
		2437	7	5.30
		2462	7	5.23

Note1: Refer to FCC Part 15.247 (d) and ANSI C63.10-2013, the channel contains the maximum PSD level was used to establish the reference level.


 SGS-CSTC Standards Technical Services Co., Ltd.  
 Shenzhen Branch, Wireless Laboratory

Unless otherwise agreed in writing, this document is issued by the Company subject to its General Conditions of Service printed overleaf, available on request or accessible at <https://www.sgs.com/en/Terms-and-Conditions>. Attention is drawn to the limitation of liability, indemnification and jurisdiction issues defined therein. Any holder of this document is advised that information contained hereon reflects the Company's findings at the time of its intervention only and within the limits of Client's instructions, if any. The Company's sole responsibility is to its Client and this document does not exonerate parties to a transaction from exercising all their rights and obligations under the transaction documents. This document cannot be reproduced except in full, without prior written approval of the Company. Any unauthorized alteration, forgery or falsification of the content or appearance of this document is unlawful and offenders may be prosecuted to the fullest extent of the law. Unless otherwise stated the results shown in this test report refer only to the sample(s) tested and such sample(s) are retained for 30 days only.

Attention: To check the authenticity of testing /inspection report & certificate, please contact us at telephone: (86-755) 8307 1443, or email: CN.Doccheck@sgs.com

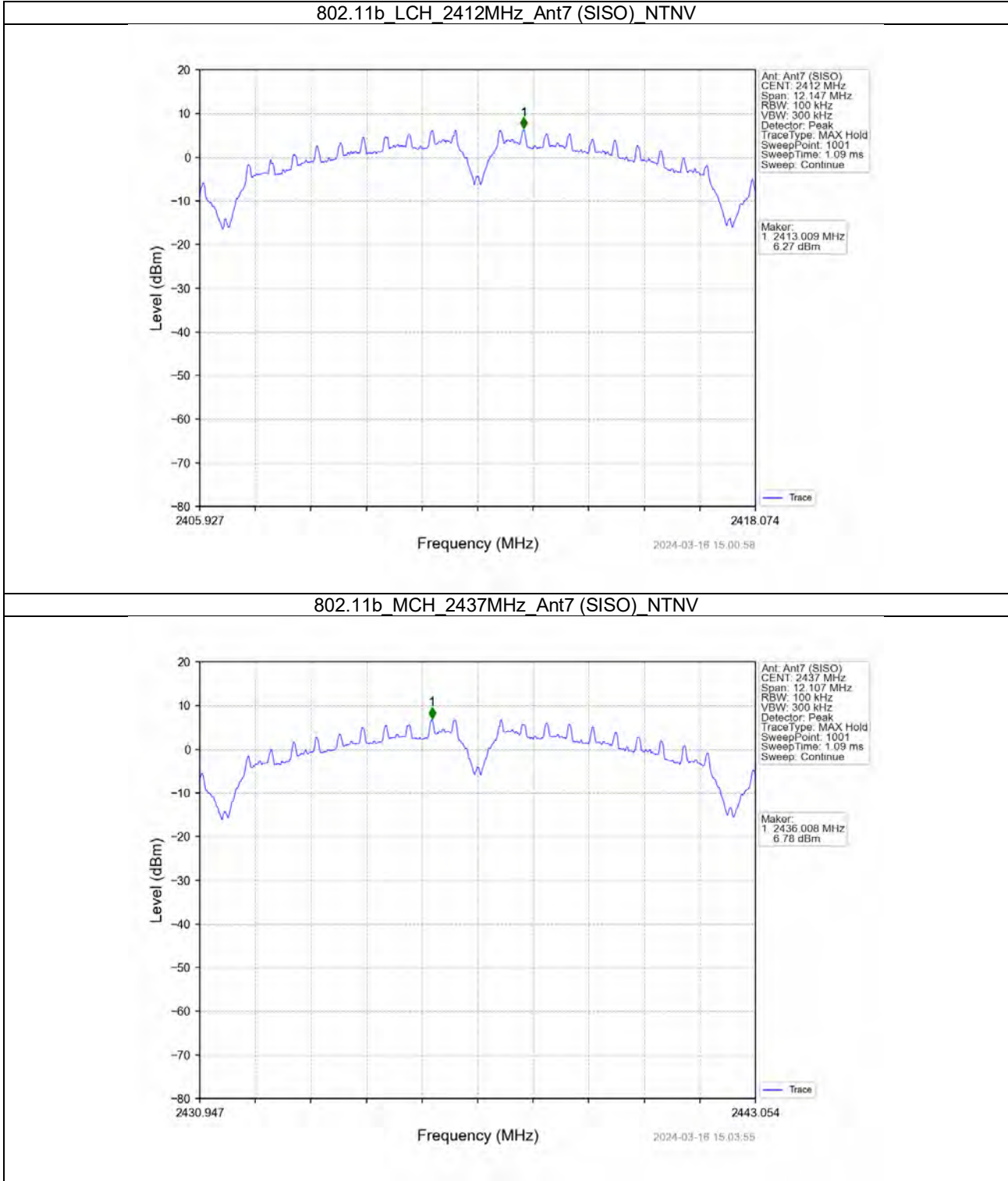
No.1 Workshop, M-10, Middle Section, Science & Technology Park, Nanshan District, Shenzhen, Guangdong, China 518057 t (86-755) 26012053 www.sgs.com.cn  
 中国·广东·深圳市南山区科技园中区M-10栋1号厂房 邮编: 518057 t (86-755) 26012053 sgs.china@sgs.com



**SGS-CSTC Standards Technical Services Co., Ltd.**  
**Shenzhen Branch**

Report No.: SZCR240100035204  
 Page: 58 of 115

Test Graph



Unless otherwise agreed in writing, this document is issued by the Company subject to its General Conditions of Service printed overleaf, available on request or accessible at <https://www.sgs.com/en/Terms-and-Conditions>. Attention is drawn to the limitation of liability, indemnification and jurisdiction issues defined therein. Any holder of this document is advised that information contained hereon reflects the Company's findings at the time of its intervention only and within the limits of Client's instructions, if any. The Company's sole responsibility is to its Client and this document does not exonerate parties to a transaction from exercising all their rights and obligations under the transaction documents. This document cannot be reproduced except in full, without prior written approval of the Company. Any unauthorized alteration, forgery or falsification of the content or appearance of this document is unlawful and offenders may be prosecuted to the fullest extent of the law. Unless otherwise stated the results shown in this test report refer only to the sample(s) tested and such sample(s) are retained for 30 days only.

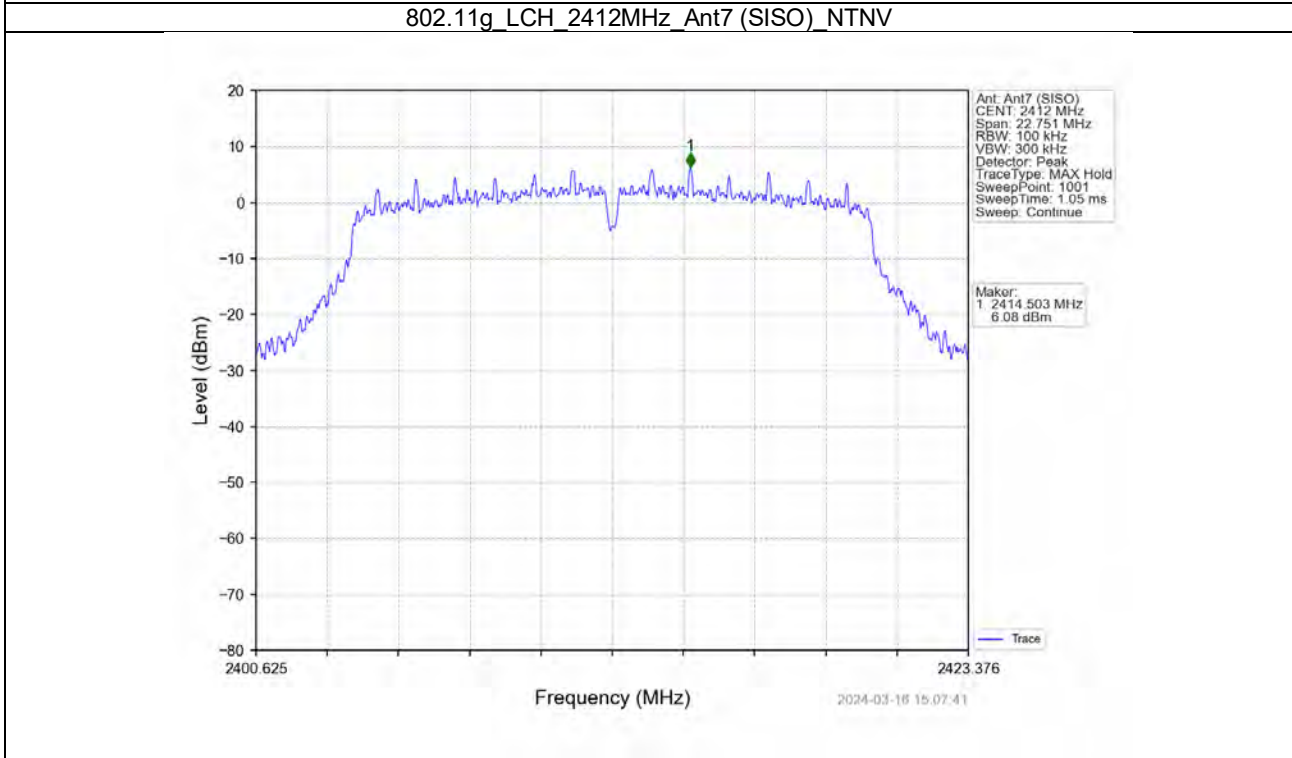
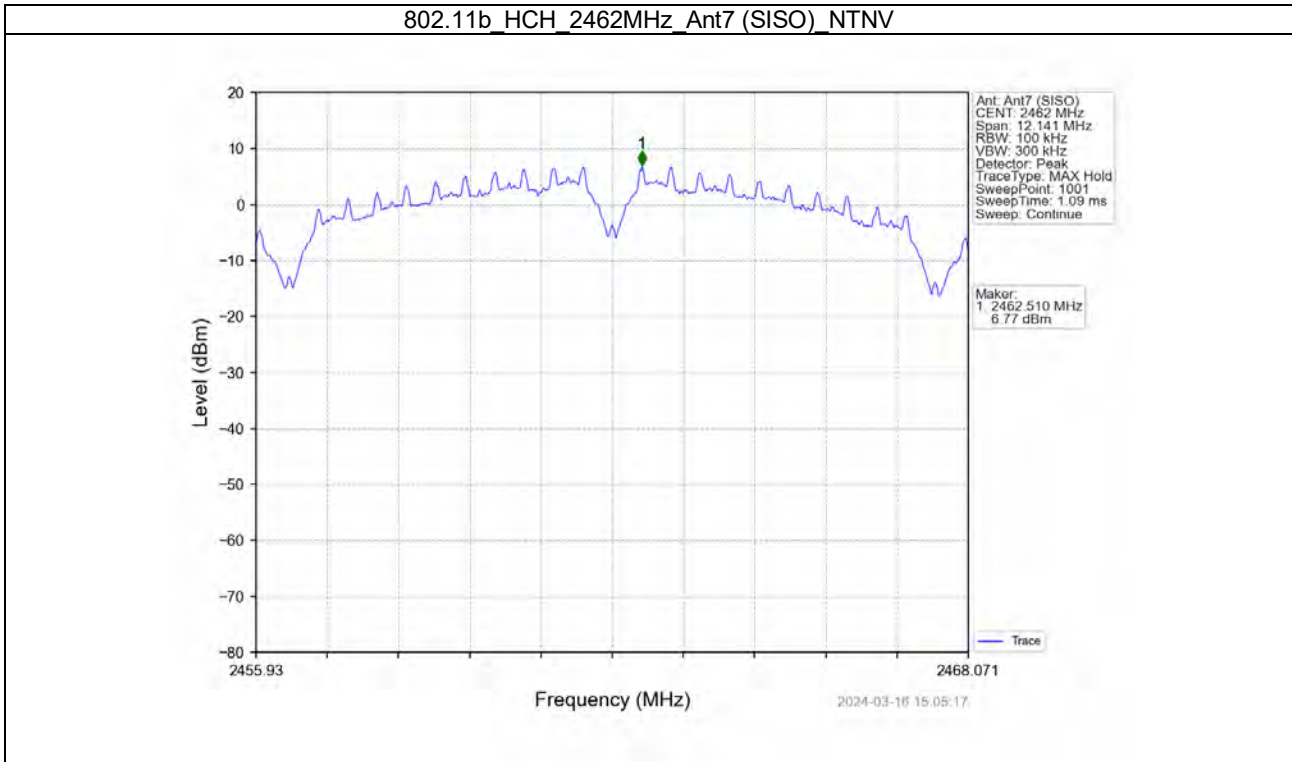
Attention: To check the authenticity of testing /inspection report & certificate, please contact us at telephone: (86-755) 8307 1443, or email: CN.Doccheck@sgs.com

No.1 Workshop, M-10, Middle Section, Science & Technology Park, Nanshan District, Shenzhen, Guangdong, China 518057 t (86-755) 26012053 www.sgs.com.cn  
 中国·广东·深圳市南山区科技园中区M-10栋1号厂房 邮编: 518057 t (86-755) 26012053 sgs.china@sgs.com



**SGS-CSTC Standards Technical Services Co., Ltd.**  
**Shenzhen Branch**

Report No.: SZCR240100035204  
 Page: 59 of 115



Unless otherwise agreed in writing, this document is issued by the Company subject to its General Conditions of Service printed overleaf, available on request or accessible at <https://www.sgs.com/en/Terms-and-Conditions>. Attention is drawn to the limitation of liability, indemnification and jurisdiction issues defined therein. Any holder of this document is advised that information contained hereon reflects the Company's findings at the time of its intervention only and within the limits of Client's instructions, if any. The Company's sole responsibility is to its Client and this document does not exonerate parties to a transaction from exercising all their rights and obligations under the transaction documents. This document cannot be reproduced except in full, without prior written approval of the Company. Any unauthorized alteration, forgery or falsification of the content or appearance of this document is unlawful and offenders may be prosecuted to the fullest extent of the law. Unless otherwise stated the results shown in this test report refer only to the sample(s) tested and such sample(s) are retained for 30 days only.

Attention: To check the authenticity of testing /inspection report & certificate, please contact us at telephone: (86-755) 8307 1443, or email: CN.Doccheck@sgs.com

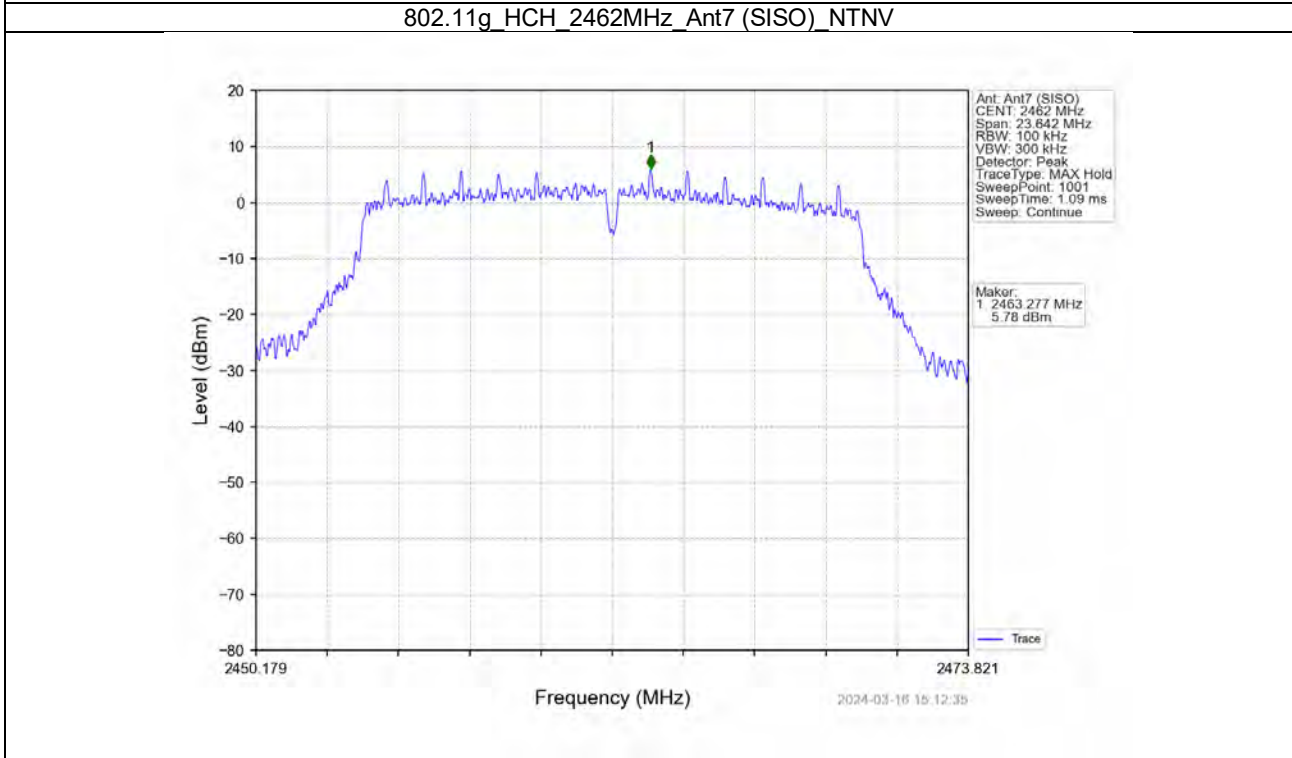
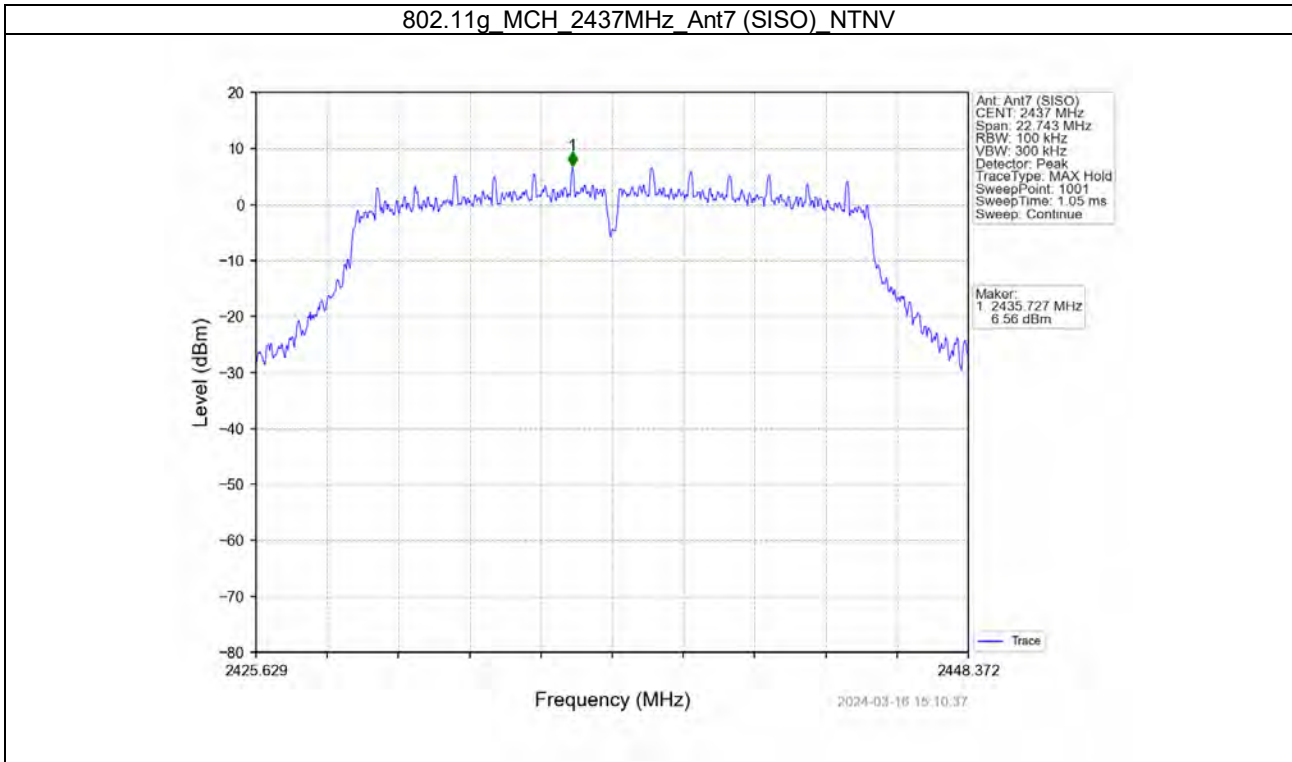
No.1 Workshop, M-10, Middle Section, Science & Technology Park, Nanshan District, Shenzhen, Guangdong, China 518057 t (86-755) 26012053 www.sgs.com.cn  
 中国·广东·深圳市南山区科技园中区M-10栋1号厂房 邮编: 518057 t (86-755) 26012053 sgs.china@sgs.com





**SGS-CSTC Standards Technical Services Co., Ltd.**  
**Shenzhen Branch**

Report No.: SZCR240100035204  
 Page: 60 of 115



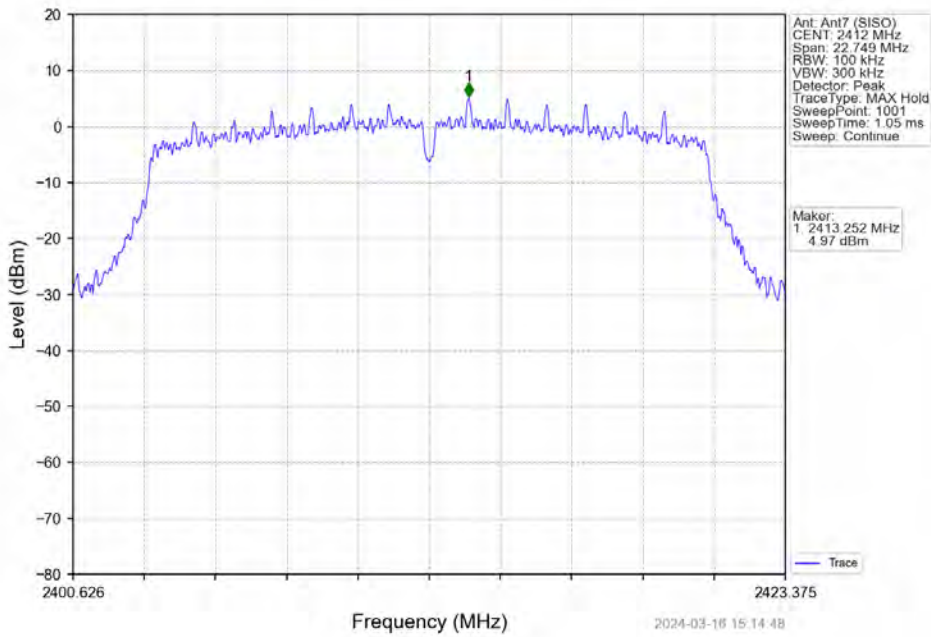
Unless otherwise agreed in writing, this document is issued by the Company subject to its General Conditions of Service printed overleaf, available on request or accessible at <https://www.sgs.com/en/Terms-and-Conditions>. Attention is drawn to the limitation of liability, indemnification and jurisdiction issues defined therein. Any holder of this document is advised that information contained hereon reflects the Company's findings at the time of its intervention only and within the limits of Client's instructions, if any. The Company's sole responsibility is to its Client and this document does not exonerate parties to a transaction from exercising all their rights and obligations under the transaction documents. This document cannot be reproduced except in full, without prior written approval of the Company. Any unauthorized alteration, forgery or falsification of the content or appearance of this document is unlawful and offenders may be prosecuted to the fullest extent of the law. Unless otherwise stated the results shown in this test report refer only to the sample(s) tested and such sample(s) are retained for 30 days only.  
**Attention: To check the authenticity of testing /inspection report & certificate, please contact us at telephone: (86-755) 8307 1443, or email: CN.Doccheck@sgs.com**  
 No.1 Workshop, M-10, Middle Section, Science & Technology Park, Nanshan District, Shenzhen, Guangdong, China 518057 t (86-755) 26012053 www.sgs.com.cn  
 中国·广东·深圳市南山区科技园中区M-10栋1号厂房 邮编: 518057 t (86-755) 26012053 sgs.china@sgs.com



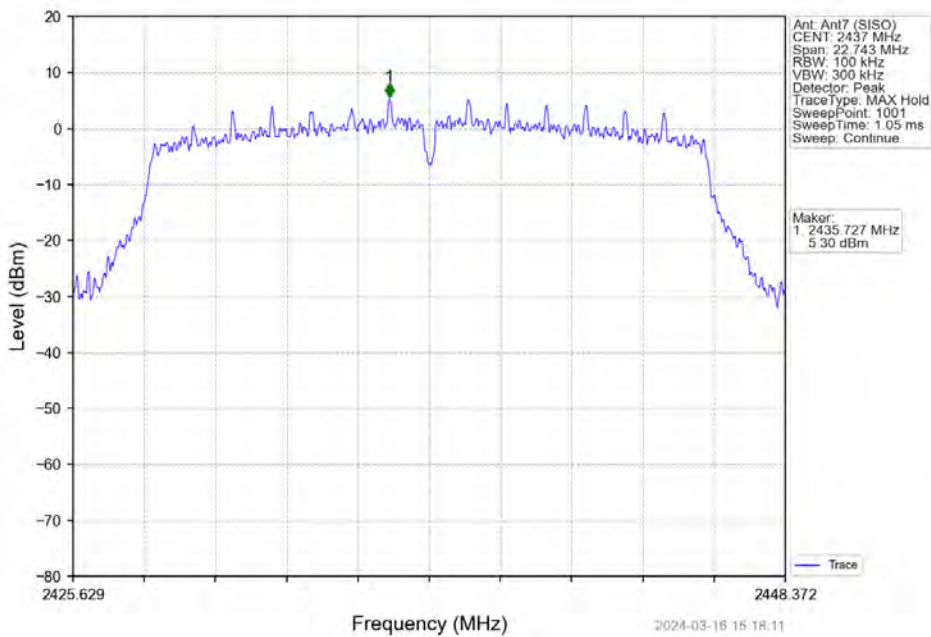
# SGS-CSTC Standards Technical Services Co., Ltd. Shenzhen Branch

Report No.: SZCR240100035204  
Page: 61 of 115

802.11n(HT20)\_LCH\_2412MHz\_Ant7 (SISO)\_NTNV



802.11n(HT20)\_MCH\_2437MHz\_Ant7 (SISO)\_NTNV



Unless otherwise agreed in writing, this document is issued by the Company subject to its General Conditions of Service printed overleaf, available on request or accessible at <https://www.sgs.com/en/Terms-and-Conditions>. Attention is drawn to the limitation of liability, indemnification and jurisdiction issues defined therein. Any holder of this document is advised that information contained hereon reflects the Company's findings at the time of its intervention only and within the limits of Client's instructions, if any. The Company's sole responsibility is to its Client and this document does not exonerate parties to a transaction from exercising all their rights and obligations under the transaction documents. This document cannot be reproduced except in full, without prior written approval of the Company. Any unauthorized alteration, forgery or falsification of the content or appearance of this document is unlawful and offenders may be prosecuted to the fullest extent of the law. Unless otherwise stated the results shown in this test report refer only to the sample(s) tested and such sample(s) are retained for 30 days only.

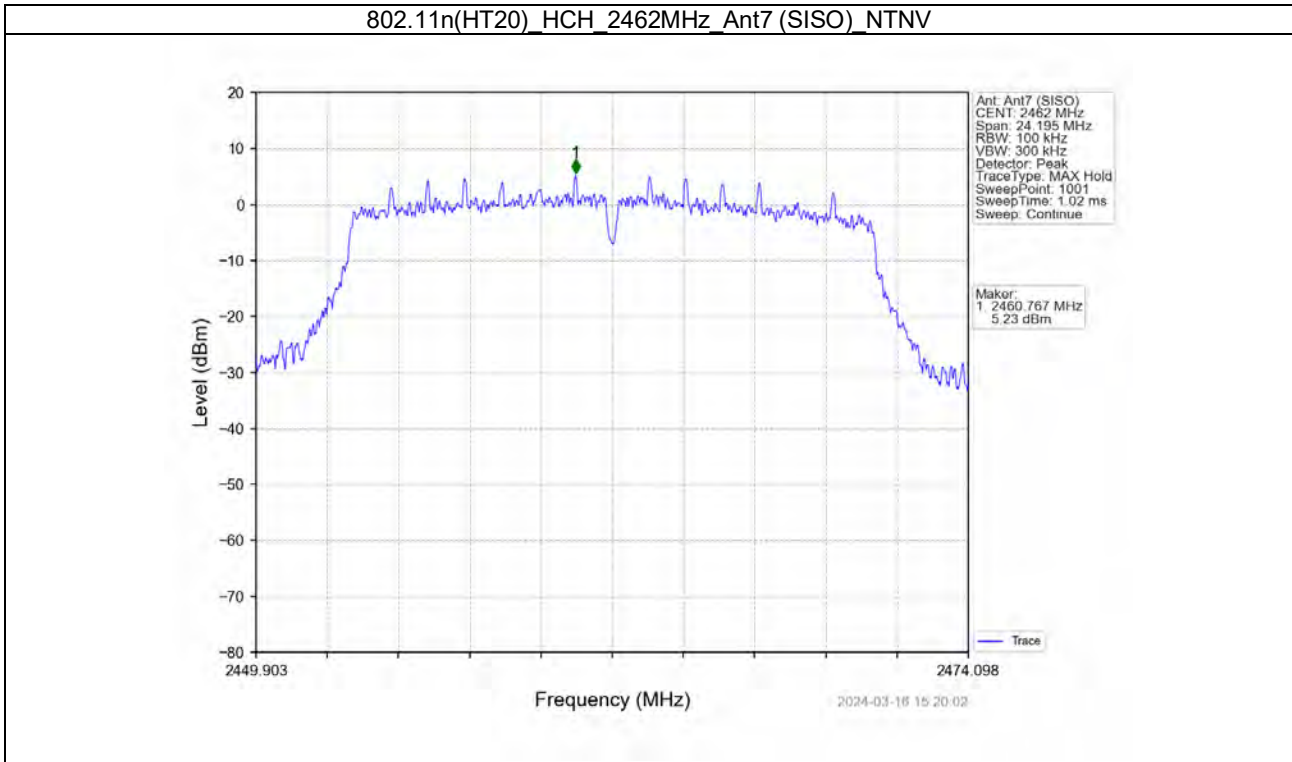
Attention: To check the authenticity of testing /inspection report & certificate, please contact us at telephone: (86-755) 8307 1443, or email: CN.Doccheck@sgs.com

No.1 Workshop, M-10, Middle Section, Science & Technology Park, Nanshan District, Shenzhen, Guangdong, China 518057 t (86-755) 26012053 www.sgs.com.cn  
 中国·广东·深圳市南山区科技园中区M-10栋1号厂房 邮编: 518057 t (86-755) 26012053 sgs.china@sgs.com



**SGS-CSTC Standards Technical Services Co., Ltd.**  
**Shenzhen Branch**

Report No.: SZCR240100035204  
 Page: 62 of 115



Unless otherwise agreed in writing, this document is issued by the Company subject to its General Conditions of Service printed overleaf, available on request or accessible at <https://www.sgs.com/en/Terms-and-Conditions>. Attention is drawn to the limitation of liability, indemnification and jurisdiction issues defined therein. Any holder of this document is advised that information contained hereon reflects the Company's findings at the time of its intervention only and within the limits of Client's instructions, if any. The Company's sole responsibility is to its Client and this document does not exonerate parties to a transaction from exercising all their rights and obligations under the transaction documents. This document cannot be reproduced except in full, without prior written approval of the Company. Any unauthorized alteration, forgery or falsification of the content or appearance of this document is unlawful and offenders may be prosecuted to the fullest extent of the law. Unless otherwise stated the results shown in this test report refer only to the sample(s) tested and such sample(s) are retained for 30 days only.

**Attention: To check the authenticity of testing /inspection report & certificate, please contact us at telephone: (86-755) 8307 1443, or email: CN.Doccheck@sgs.com**

No.1 Workshop, M-10, Middle Section, Science & Technology Park, Nanshan District, Shenzhen, Guangdong, China 518057 t (86-755) 26012053 www.sgs.com.cn  
 中国·广东·深圳市南山区科技园中区M-10栋1号厂房 邮编: 518057 t (86-755) 26012053 sgs.china@sgs.com



# SGS-CSTC Standards Technical Services Co., Ltd. Shenzhen Branch

Report No.: SZCR240100035204  
Page: 63 of 115

CSE

## Test Result

Mode	TX Type	Frequency (MHz)	ANT	Level of Reference (dBm)	Limit (dBm)	Verdict
802.11b	SISO	2412	7	6.78	-23.22	Pass
		2437	7	6.78	-23.22	Pass
		2462	7	6.78	-23.22	Pass
802.11g	SISO	2412	7	6.56	-23.44	Pass
		2437	7	6.56	-23.44	Pass
		2462	7	6.56	-23.44	Pass
802.11n (HT20)	SISO	2412	7	5.30	-24.70	Pass
		2437	7	5.30	-24.70	Pass
		2462	7	5.30	-24.70	Pass

Note1: Refer to FCC Part 15.247 (d) and ANSI C63.10-2013, the channel contains the maximum PSD level was used to establish the reference level.



Unless otherwise agreed in writing, this document is issued by the Company subject to its General Conditions of Service printed overleaf, available on request or accessible at <https://www.sgs.com/en/Terms-and-Conditions>. Attention is drawn to the limitation of liability, indemnification and jurisdiction issues defined therein. Any holder of this document is advised that information contained hereon reflects the Company's findings at the time of its intervention only and within the limits of Client's instructions, if any. The Company's sole responsibility is to its Client and this document does not exonerate parties to a transaction from exercising all their rights and obligations under the transaction documents. This document cannot be reproduced except in full, without prior written approval of the Company. Any unauthorized alteration, forgery or falsification of the content or appearance of this document is unlawful and offenders may be prosecuted to the fullest extent of the law. Unless otherwise stated the results shown in this test report refer only to the sample(s) tested and such sample(s) are retained for 30 days only.

Attention: To check the authenticity of testing /inspection report & certificate, please contact us at telephone: (86-755) 8307 1443, or email: CN.Doccheck@sgs.com

No.1 Workshop, M-10, Middle Section, Science & Technology Park, Nanshan District, Shenzhen, Guangdong, China 518057 t (86-755) 26012053 www.sgs.com.cn  
中国·广东·深圳市南山区科技园中区M-10栋1号厂房 邮编: 518057 t (86-755) 26012053 sgs.china@sgs.com

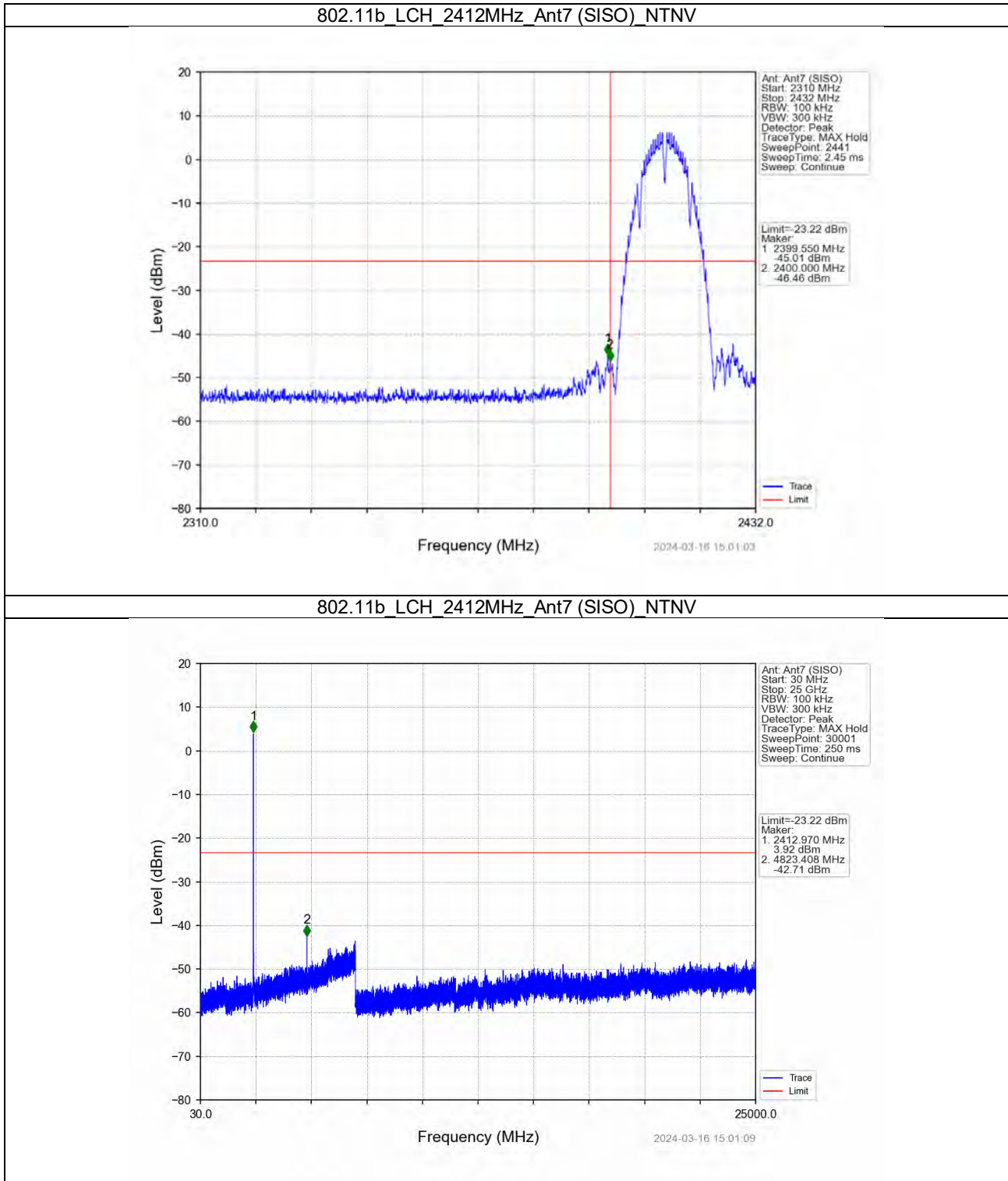




**SGS-CSTC Standards Technical Services Co., Ltd.**  
**Shenzhen Branch**

Report No.: SZCR240100035204  
 Page: 64 of 115

Test Graph



Unless otherwise agreed in writing, this document is issued by the Company subject to its General Conditions of Service printed overleaf, available on request or accessible at <https://www.sgs.com/en/Terms-and-Conditions>. Attention is drawn to the limitation of liability, indemnification and jurisdiction issues defined therein. Any holder of this document is advised that information contained hereon reflects the Company's findings at the time of its intervention only and within the limits of Client's instructions, if any. The Company's sole responsibility is to its Client and this document does not exonerate parties to a transaction from exercising all their rights and obligations under the transaction documents. This document cannot be reproduced except in full, without prior written approval of the Company. Any unauthorized alteration, forgery or falsification of the content or appearance of this document is unlawful and offenders may be prosecuted to the fullest extent of the law. Unless otherwise stated the results shown in this test report refer only to the sample(s) tested and such sample(s) are retained for 30 days only.

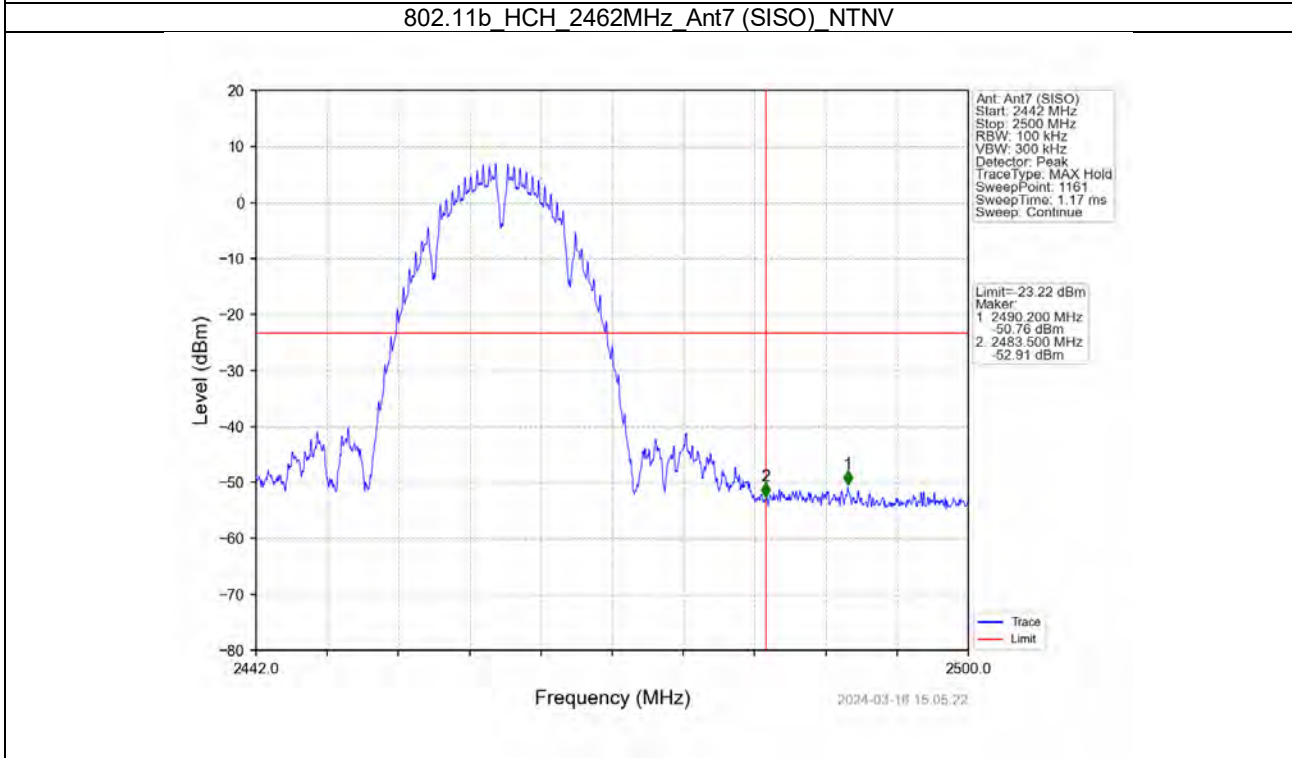
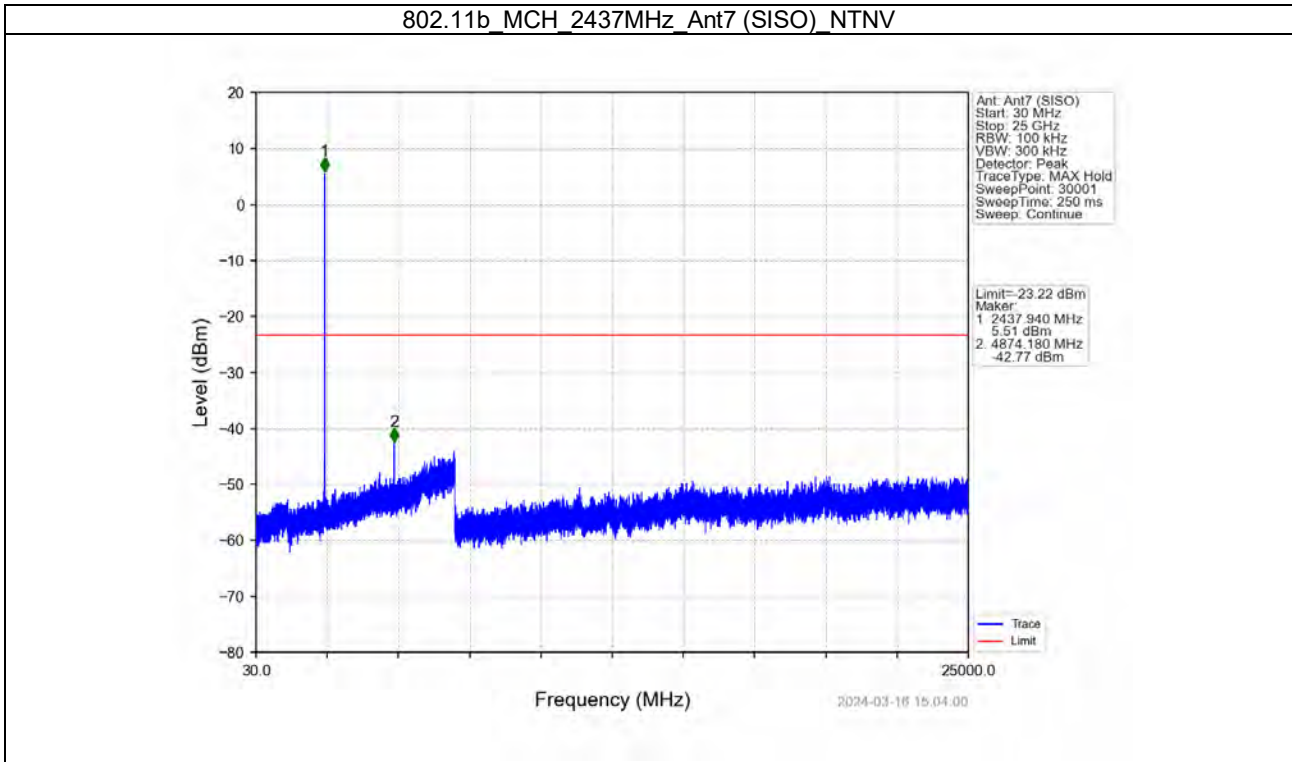
Attention: To check the authenticity of testing /inspection report & certificate, please contact us at telephone: (86-755) 8307 1443, or email: CN.Doccheck@sgs.com

No.1 Workshop, M-10, Middle Section, Science & Technology Park, Nanshan District, Shenzhen, Guangdong, China 518057 t (86-755) 26012053 www.sgs.com.cn  
 中国·广东·深圳市南山区科技园中区M-10栋1号厂房 邮编: 518057 t (86-755) 26012053 sgs.china@sgs.com



**SGS-CSTC Standards Technical Services Co., Ltd.**  
**Shenzhen Branch**

Report No.: SZCR240100035204  
 Page: 65 of 115



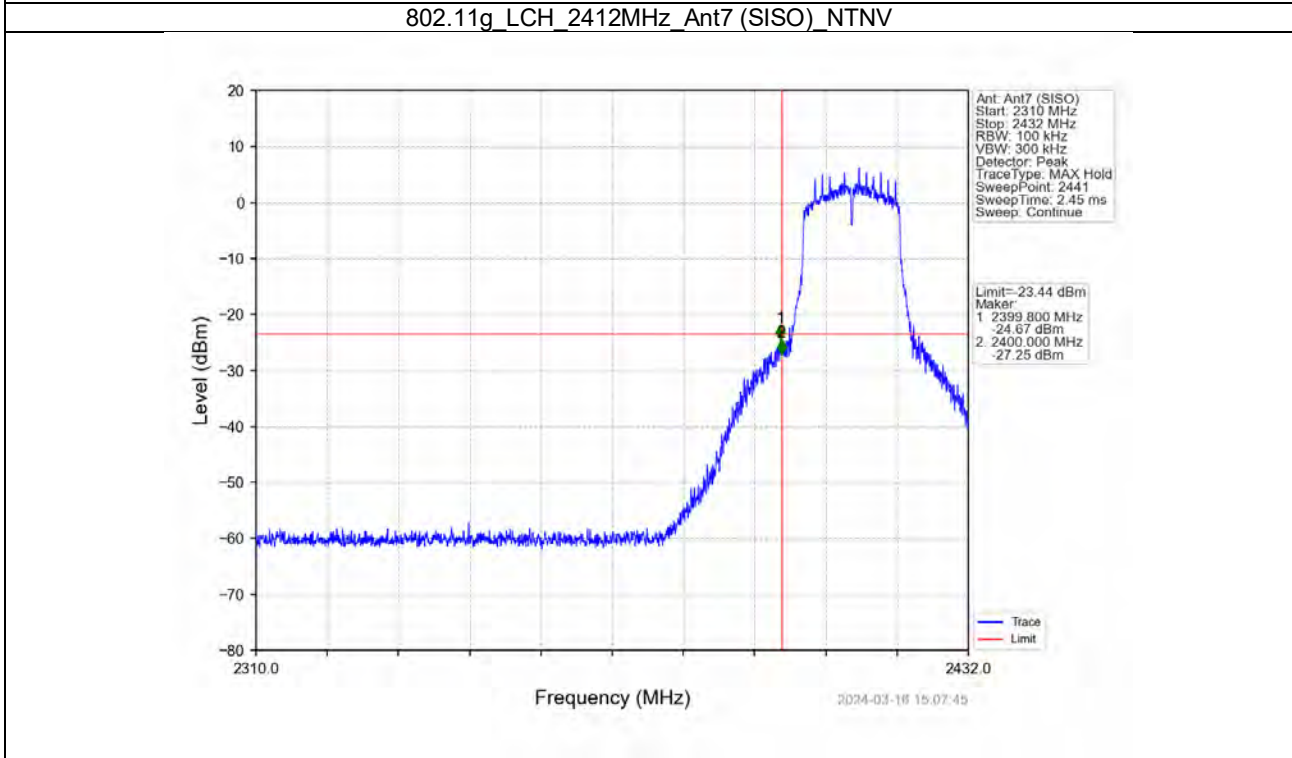
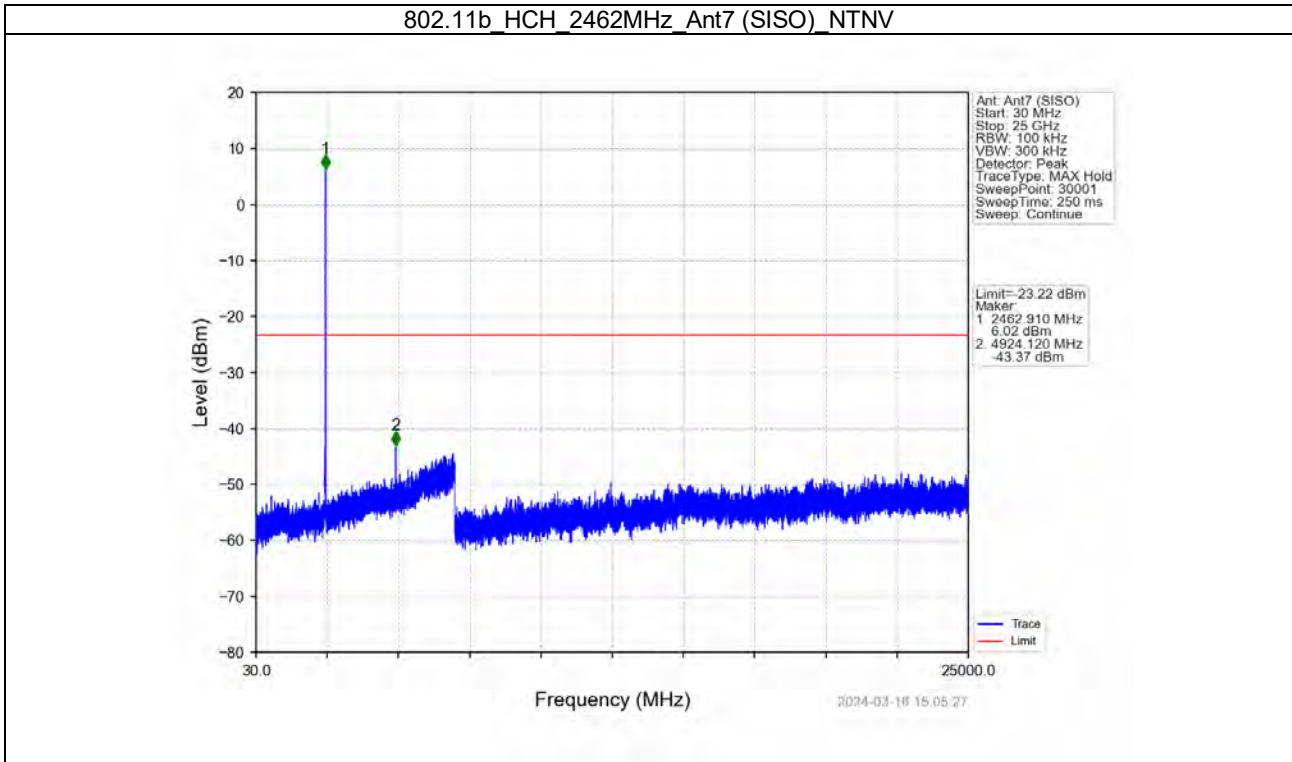
Unless otherwise agreed in writing, this document is issued by the Company subject to its General Conditions of Service printed overleaf, available on request or accessible at <https://www.sgs.com/en/Terms-and-Conditions>. Attention is drawn to the limitation of liability, indemnification and jurisdiction issues defined therein. Any holder of this document is advised that information contained hereon reflects the Company's findings at the time of its intervention only and within the limits of Client's instructions, if any. The Company's sole responsibility is to its Client and this document does not exonerate parties to a transaction from exercising all their rights and obligations under the transaction documents. This document cannot be reproduced except in full, without prior written approval of the Company. Any unauthorized alteration, forgery or falsification of the content or appearance of this document is unlawful and offenders may be prosecuted to the fullest extent of the law. Unless otherwise stated the results shown in this test report refer only to the sample(s) tested and such sample(s) are retained for 30 days only.

Attention: To check the authenticity of testing /inspection report & certificate, please contact us at telephone: (86-755) 8307 1443, or email: CN.Doccheck@sgs.com  
 No.1 Workshop, M-10, Middle Section, Science & Technology Park, Nanshan District, Shenzhen, Guangdong, China 518057 t (86-755) 26012053 www.sgs.com.cn  
 中国·广东·深圳市南山区科技园中区M-10栋1号厂房 邮编: 518057 t (86-755) 26012053 sgs.china@sgs.com



**SGS-CSTC Standards Technical Services Co., Ltd.**  
**Shenzhen Branch**

Report No.: SZCR240100035204  
 Page: 66 of 115



Unless otherwise agreed in writing, this document is issued by the Company subject to its General Conditions of Service printed overleaf, available on request or accessible at <https://www.sgs.com/en/Terms-and-Conditions>. Attention is drawn to the limitation of liability, indemnification and jurisdiction issues defined therein. Any holder of this document is advised that information contained hereon reflects the Company's findings at the time of its intervention only and within the limits of Client's instructions, if any. The Company's sole responsibility is to its Client and this document does not exonerate parties to a transaction from exercising all their rights and obligations under the transaction documents. This document cannot be reproduced except in full, without prior written approval of the Company. Any unauthorized alteration, forgery or falsification of the content or appearance of this document is unlawful and offenders may be prosecuted to the fullest extent of the law. Unless otherwise stated the results shown in this test report refer only to the sample(s) tested and such sample(s) are retained for 30 days only.

Attention: To check the authenticity of testing /inspection report & certificate, please contact us at telephone: (86-755) 8307 1443, or email: CN.Doccheck@sgs.com

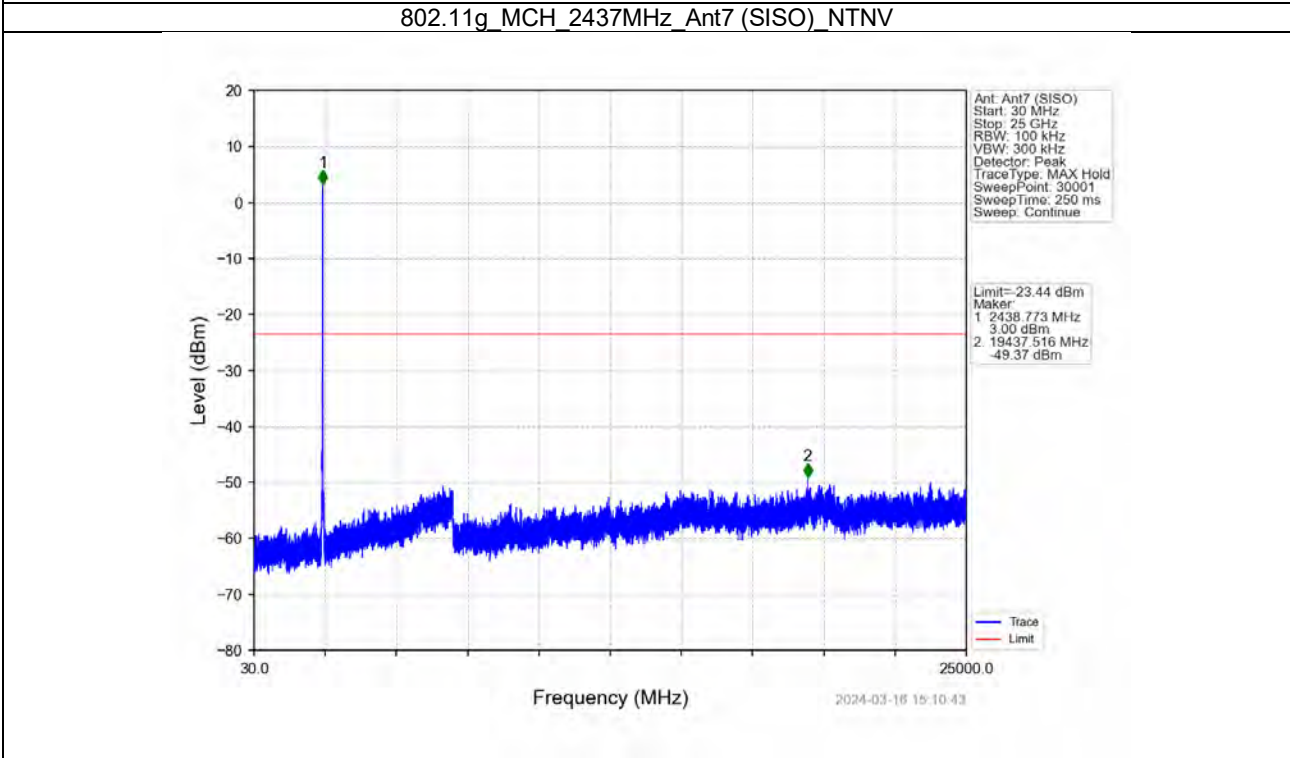
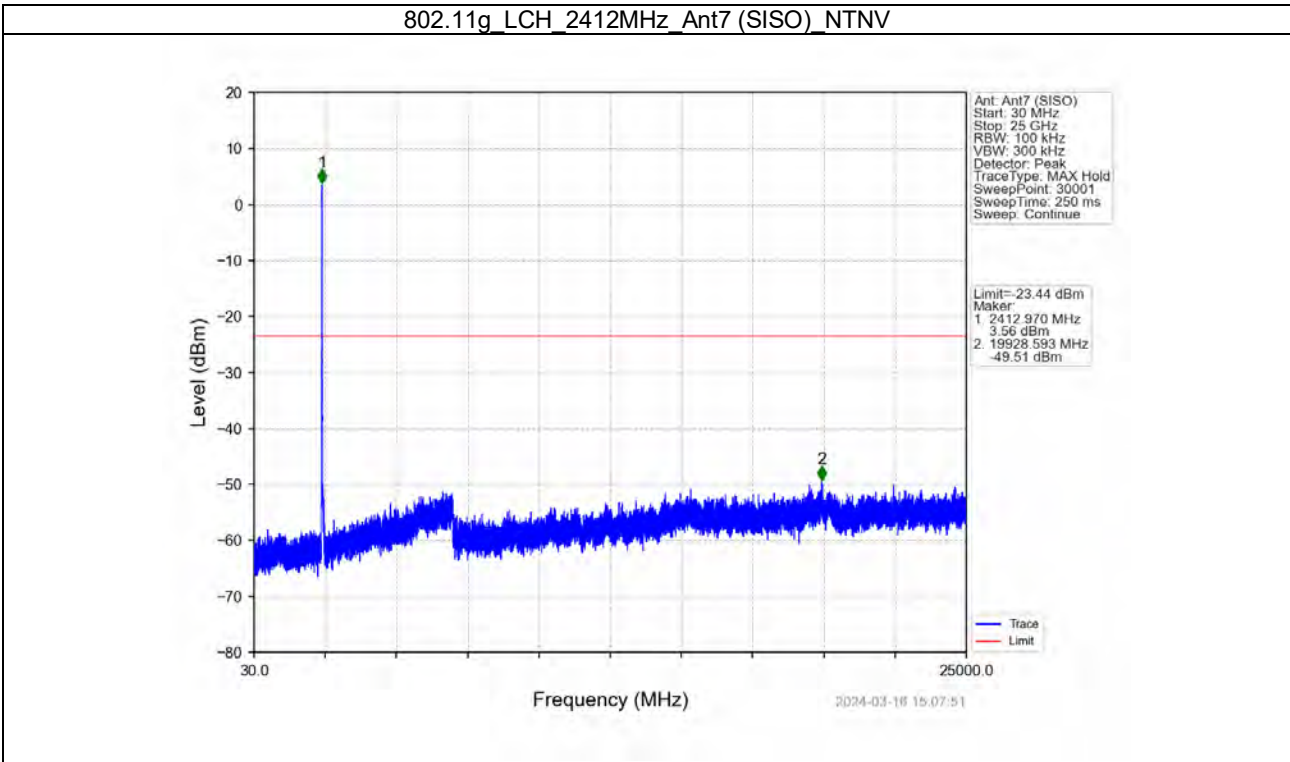
No.1 Workshop, M-10, Middle Section, Science & Technology Park, Nanshan District, Shenzhen, Guangdong, China 518057 t (86-755) 26012053 www.sgs.com.cn  
 中国·广东·深圳市南山区科技园中区M-10栋1号厂房 邮编: 518057 t (86-755) 26012053 sgs.china@sgs.com





**SGS-CSTC Standards Technical Services Co., Ltd.**  
**Shenzhen Branch**

Report No.: SZCR240100035204  
 Page: 67 of 115



Unless otherwise agreed in writing, this document is issued by the Company subject to its General Conditions of Service printed overleaf, available on request or accessible at <https://www.sgs.com/en/Terms-and-Conditions>. Attention is drawn to the limitation of liability, indemnification and jurisdiction issues defined therein. Any holder of this document is advised that information contained hereon reflects the Company's findings at the time of its intervention only and within the limits of Client's instructions, if any. The Company's sole responsibility is to its Client and this document does not exonerate parties to a transaction from exercising all their rights and obligations under the transaction documents. This document cannot be reproduced except in full, without prior written approval of the Company. Any unauthorized alteration, forgery or falsification of the content or appearance of this document is unlawful and offenders may be prosecuted to the fullest extent of the law. Unless otherwise stated the results shown in this test report refer only to the sample(s) tested and such sample(s) are retained for 30 days only.

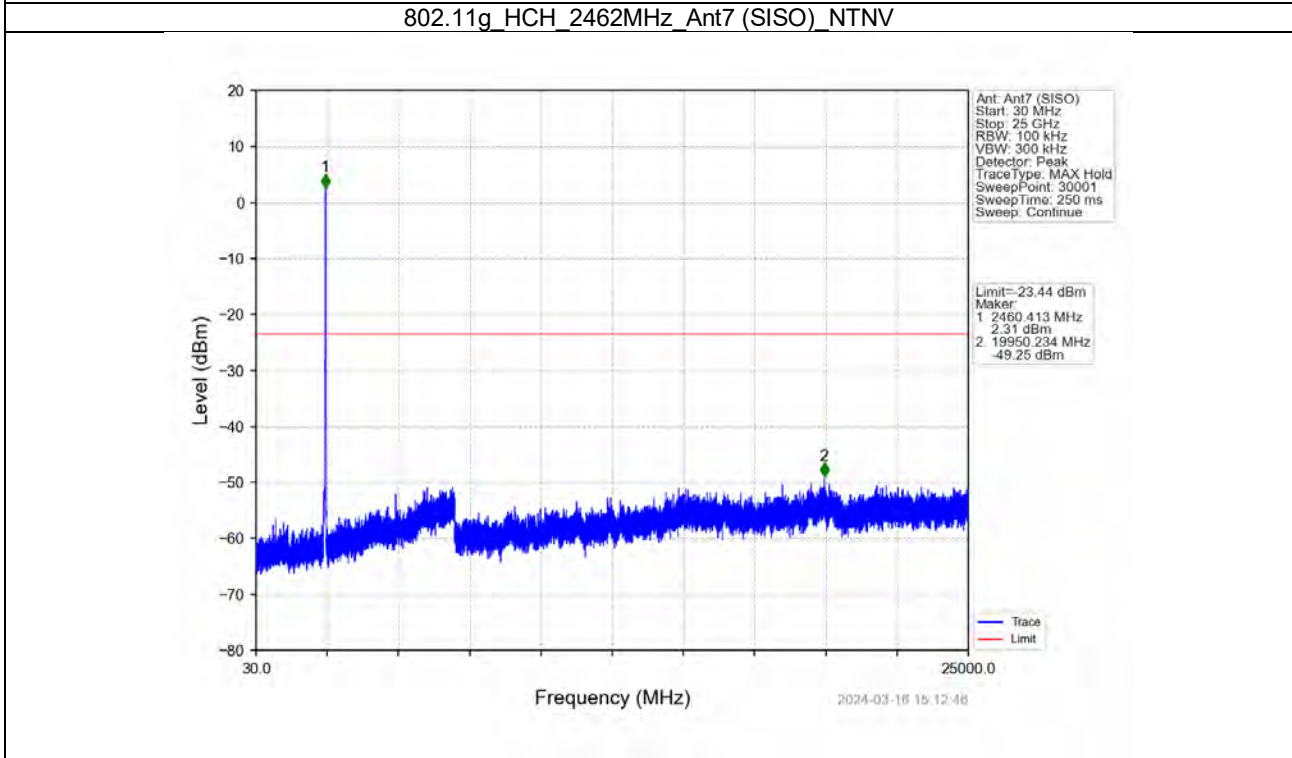
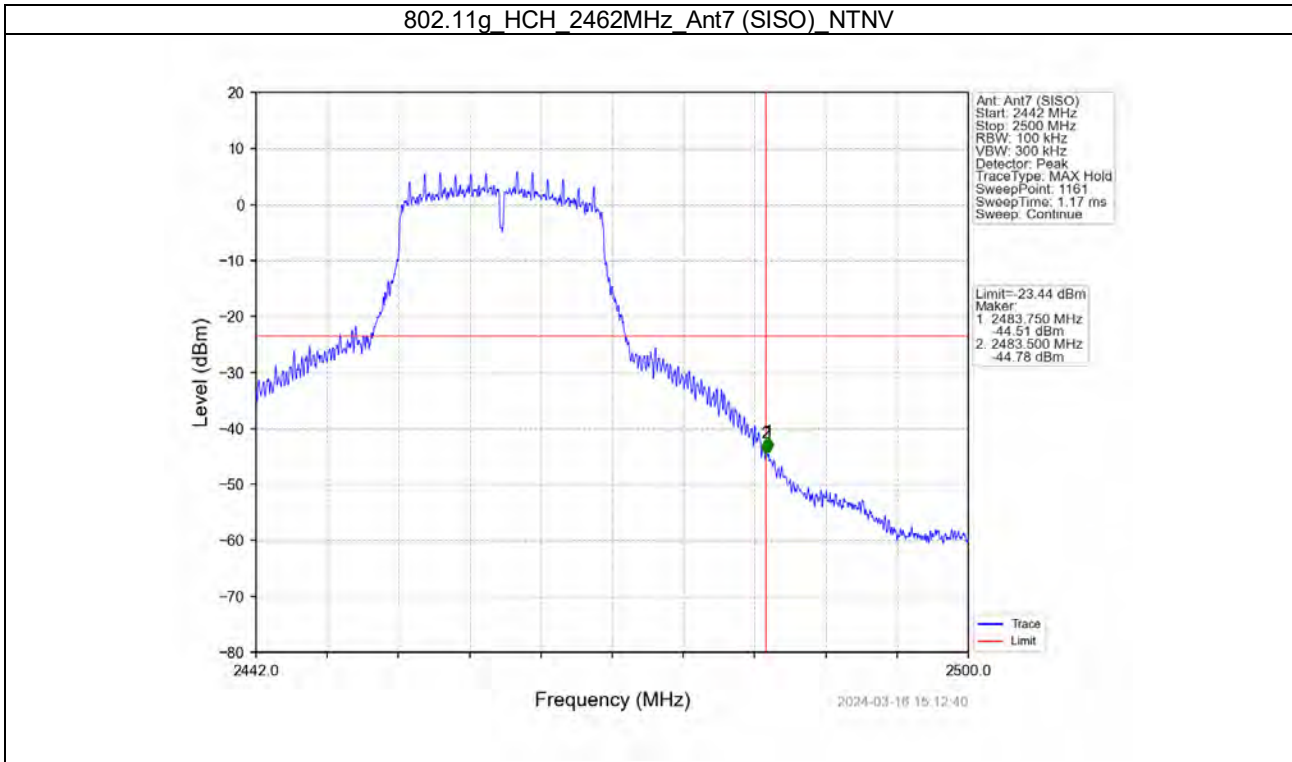
Attention: To check the authenticity of testing /inspection report & certificate, please contact us at telephone: (86-755) 8307 1443, or email: CN.Doccheck@sgs.com  
 No.1 Workshop, M-10, Middle Section, Science & Technology Park, Nanshan District, Shenzhen, Guangdong, China 518057 t (86-755) 26012053 www.sgs.com.cn  
 中国·广东·深圳市南山区科技园中区M-10栋1号厂房 邮编: 518057 t (86-755) 26012053 sgs.china@sgs.com





**SGS-CSTC Standards Technical Services Co., Ltd.**  
**Shenzhen Branch**

Report No.: SZCR240100035204  
 Page: 68 of 115



Unless otherwise agreed in writing, this document is issued by the Company subject to its General Conditions of Service printed overleaf, available on request or accessible at <https://www.sgs.com/en/Terms-and-Conditions>. Attention is drawn to the limitation of liability, indemnification and jurisdiction issues defined therein. Any holder of this document is advised that information contained hereon reflects the Company's findings at the time of its intervention only and within the limits of Client's instructions, if any. The Company's sole responsibility is to its Client and this document does not exonerate parties to a transaction from exercising all their rights and obligations under the transaction documents. This document cannot be reproduced except in full, without prior written approval of the Company. Any unauthorized alteration, forgery or falsification of the content or appearance of this document is unlawful and offenders may be prosecuted to the fullest extent of the law. Unless otherwise stated the results shown in this test report refer only to the sample(s) tested and such sample(s) are retained for 30 days only.

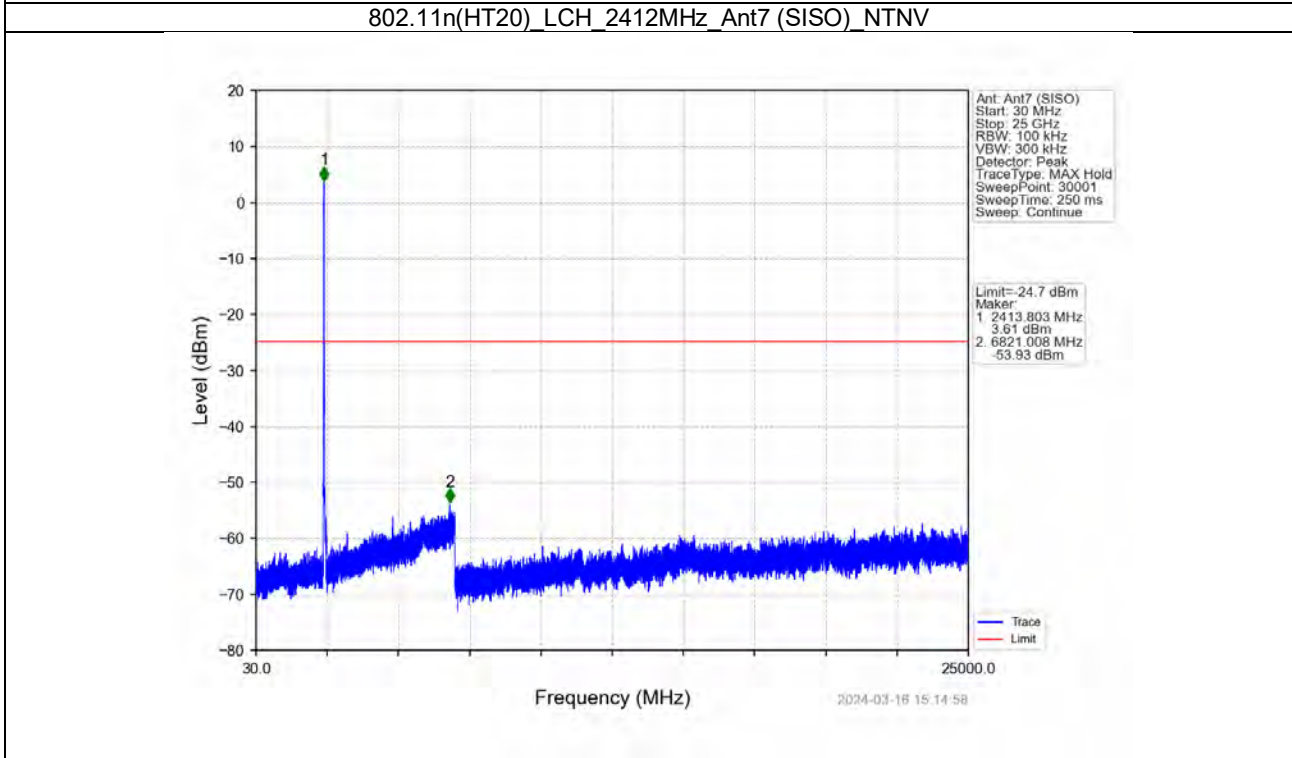
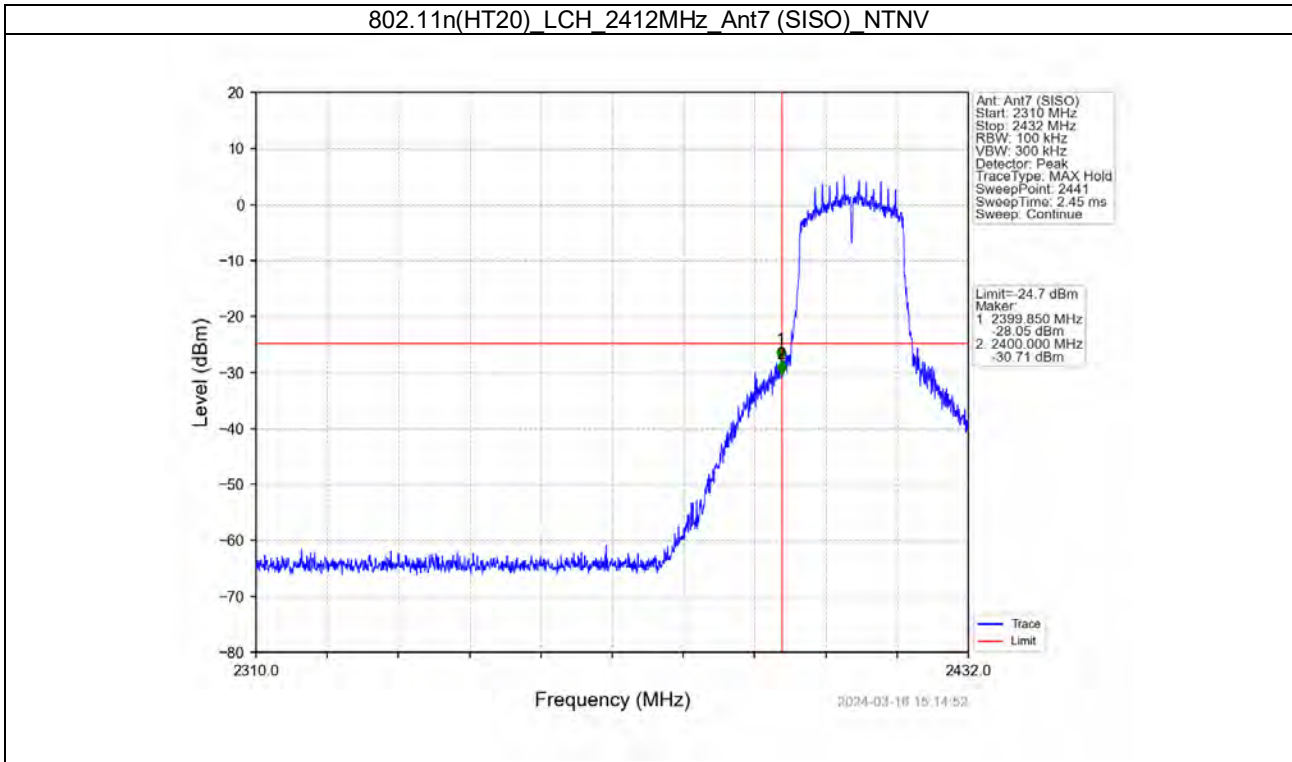
Attention: To check the authenticity of testing /inspection report & certificate, please contact us at telephone: (86-755) 8307 1443, or email: CN.Doccheck@sgs.com

No.1 Workshop, M-10, Middle Section, Science & Technology Park, Nanshan District, Shenzhen, Guangdong, China 518057 t (86-755) 26012053 www.sgs.com.cn  
 中国·广东·深圳市南山区科技园中区M-10栋1号厂房 邮编: 518057 t (86-755) 26012053 sgs.china@sgs.com



**SGS-CSTC Standards Technical Services Co., Ltd.**  
**Shenzhen Branch**

Report No.: SZCR240100035204  
 Page: 69 of 115



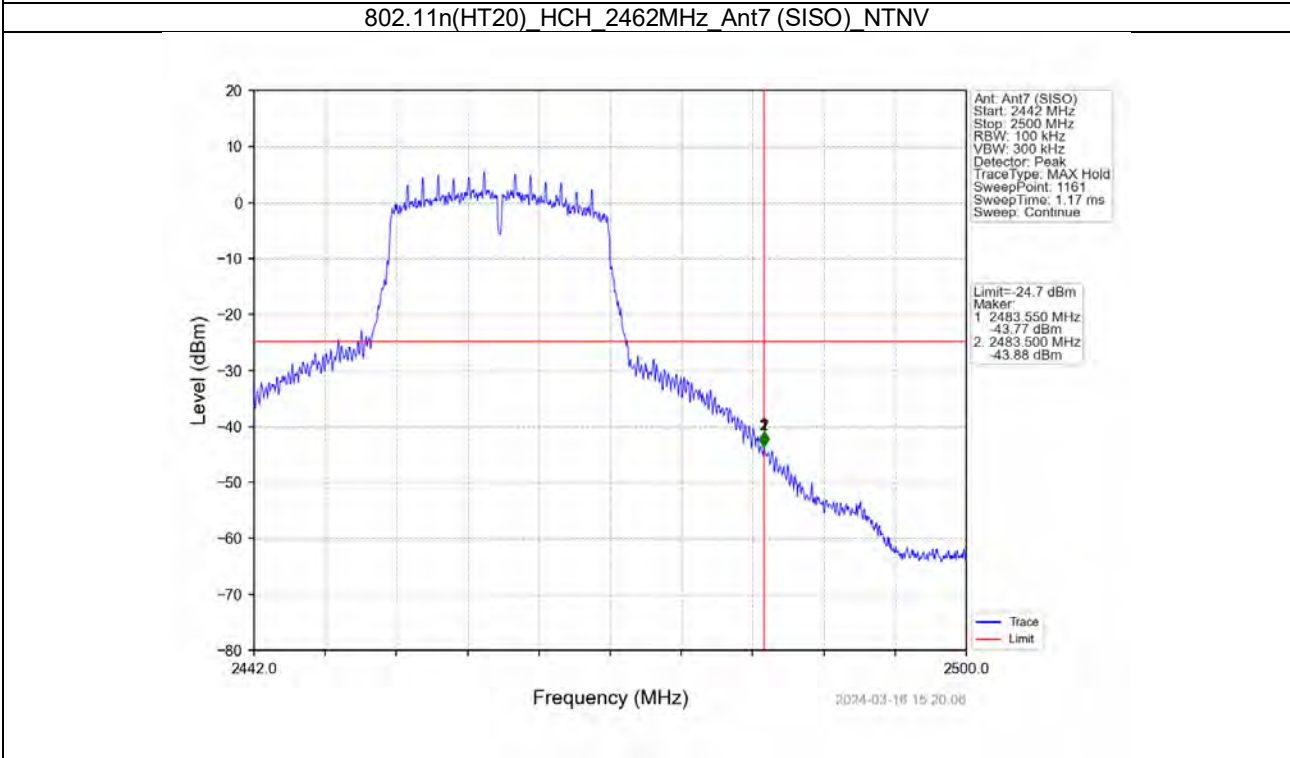
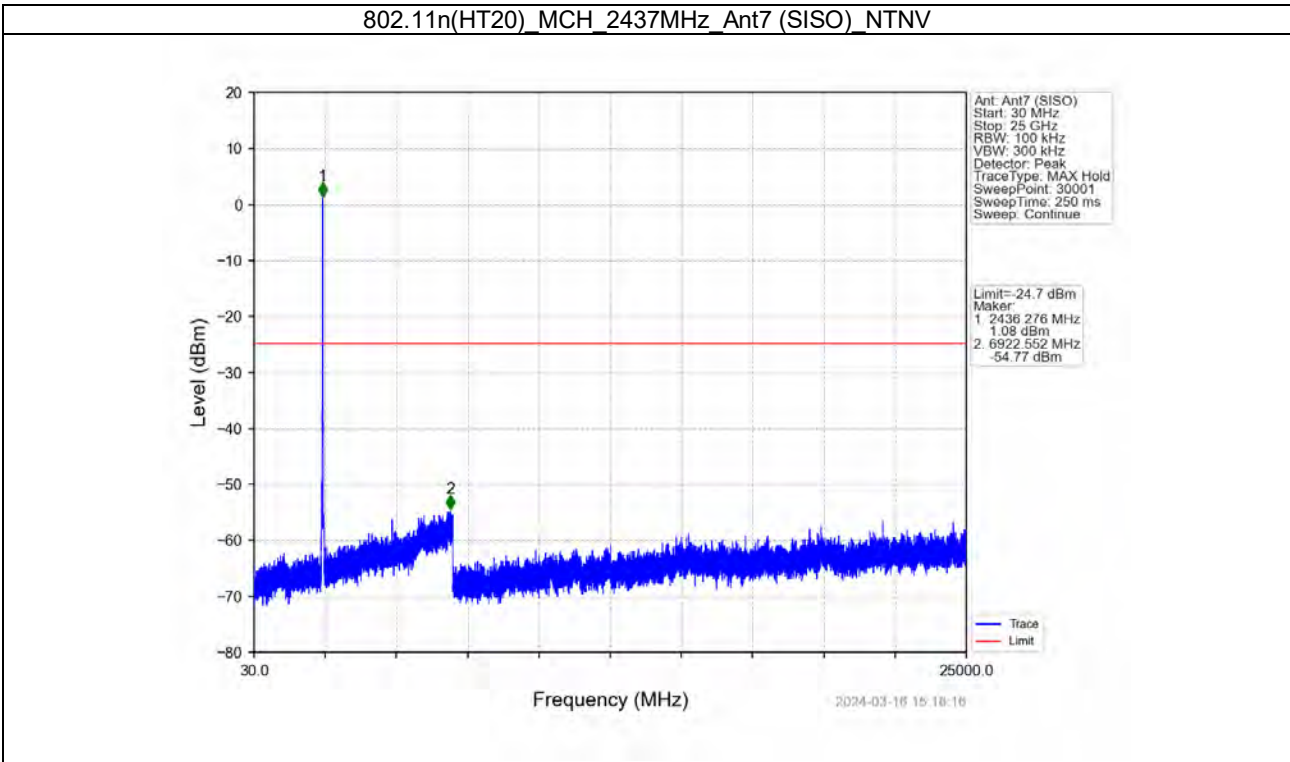
Unless otherwise agreed in writing, this document is issued by the Company subject to its General Conditions of Service printed overleaf, available on request or accessible at <https://www.sgs.com/en/Terms-and-Conditions>. Attention is drawn to the limitation of liability, indemnification and jurisdiction issues defined therein. Any holder of this document is advised that information contained hereon reflects the Company's findings at the time of its intervention only and within the limits of Client's instructions, if any. The Company's sole responsibility is to its Client and this document does not exonerate parties to a transaction from exercising all their rights and obligations under the transaction documents. This document cannot be reproduced except in full, without prior written approval of the Company. Any unauthorized alteration, forgery or falsification of the content or appearance of this document is unlawful and offenders may be prosecuted to the fullest extent of the law. Unless otherwise stated the results shown in this test report refer only to the sample(s) tested and such sample(s) are retained for 30 days only.

Attention: To check the authenticity of testing /inspection report & certificate, please contact us at telephone: (86-755) 8307 1443, or email: CN.Doccheck@sgs.com  
 No.1 Workshop, M-10, Middle Section, Science & Technology Park, Nanshan District, Shenzhen, Guangdong, China 518057 t (86-755) 26012053 www.sgs.com.cn  
 中国·广东·深圳市南山区科技园中区M-10栋1号厂房 邮编: 518057 t (86-755) 26012053 sgs.china@sgs.com



**SGS-CSTC Standards Technical Services Co., Ltd.**  
**Shenzhen Branch**

Report No.: SZCR240100035204  
 Page: 70 of 115



Unless otherwise agreed in writing, this document is issued by the Company subject to its General Conditions of Service printed overleaf, available on request or accessible at <https://www.sgs.com/en/Terms-and-Conditions>. Attention is drawn to the limitation of liability, indemnification and jurisdiction issues defined therein. Any holder of this document is advised that information contained hereon reflects the Company's findings at the time of its intervention only and within the limits of Client's instructions, if any. The Company's sole responsibility is to its Client and this document does not exonerate parties to a transaction from exercising all their rights and obligations under the transaction documents. This document cannot be reproduced except in full, without prior written approval of the Company. Any unauthorized alteration, forgery or falsification of the content or appearance of this document is unlawful and offenders may be prosecuted to the fullest extent of the law. Unless otherwise stated the results shown in this test report refer only to the sample(s) tested and such sample(s) are retained for 30 days only.

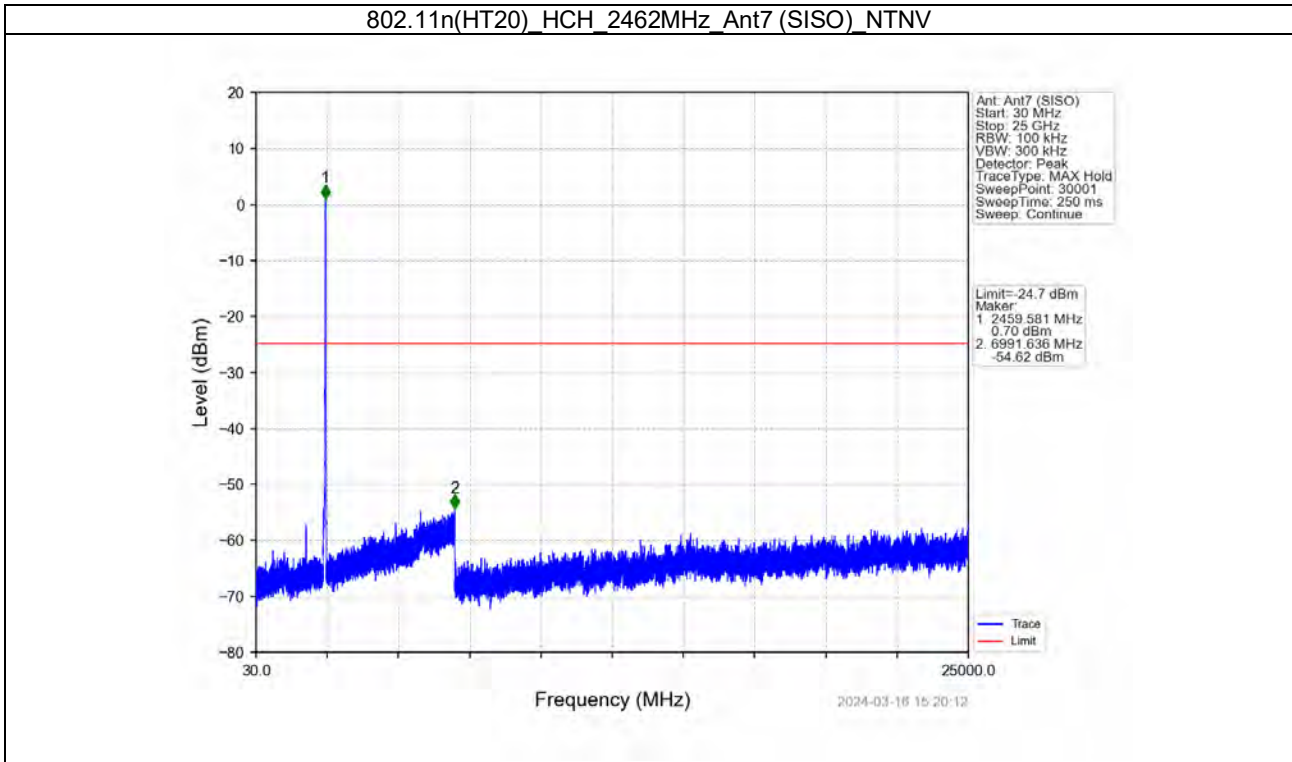
Attention: To check the authenticity of testing /inspection report & certificate, please contact us at telephone: (86-755) 8307 1443, or email: CN.Doccheck@sgs.com  
 No.1 Workshop, M-10, Middle Section, Science & Technology Park, Nanshan District, Shenzhen, Guangdong, China 518057 t (86-755) 26012053 www.sgs.com.cn  
 中国·广东·深圳市南山区科技园中区M-10栋1号厂房 邮编: 518057 t (86-755) 26012053 sgs.china@sgs.com





**SGS-CSTC Standards Technical Services Co., Ltd.**  
**Shenzhen Branch**

Report No.: SZCR240100035204  
 Page: 71 of 115



Unless otherwise agreed in writing, this document is issued by the Company subject to its General Conditions of Service printed overleaf, available on request or accessible at <https://www.sgs.com/en/Terms-and-Conditions>. Attention is drawn to the limitation of liability, indemnification and jurisdiction issues defined therein. Any holder of this document is advised that information contained hereon reflects the Company's findings at the time of its intervention only and within the limits of Client's instructions, if any. The Company's sole responsibility is to its Client and this document does not exonerate parties to a transaction from exercising all their rights and obligations under the transaction documents. This document cannot be reproduced except in full, without prior written approval of the Company. Any unauthorized alteration, forgery or falsification of the content or appearance of this document is unlawful and offenders may be prosecuted to the fullest extent of the law. Unless otherwise stated the results shown in this test report refer only to the sample(s) tested and such sample(s) are retained for 30 days only.

**Attention: To check the authenticity of testing /inspection report & certificate, please contact us at telephone: (86-755) 8307 1443, or email: CN.Doccheck@sgs.com**

No.1 Workshop, M-10, Middle Section, Science & Technology Park, Nanshan District, Shenzhen, Guangdong, China 518057 t (86-755) 26012053 www.sgs.com.cn  
 中国·广东·深圳市南山区科技园中区M-10栋1号厂房 邮编: 518057 t (86-755) 26012053 sgs.china@sgs.com





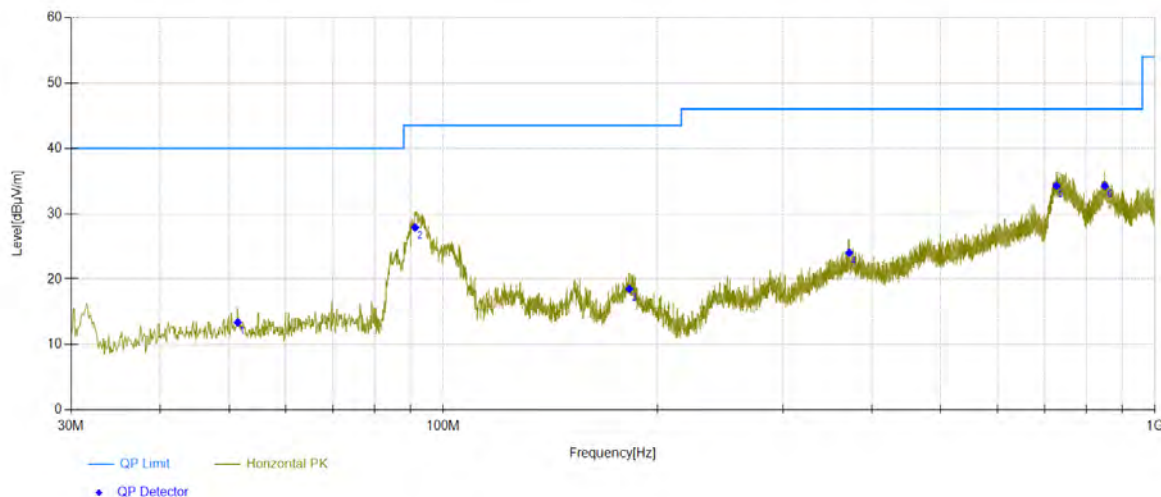
**SGS-CSTC Standards Technical Services Co., Ltd.  
Shenzhen Branch**

Report No.: SZCR240100035204  
Page: 72 of 115

**Radiated Spurious Emissions**

**Radiated emission below 1GHz**

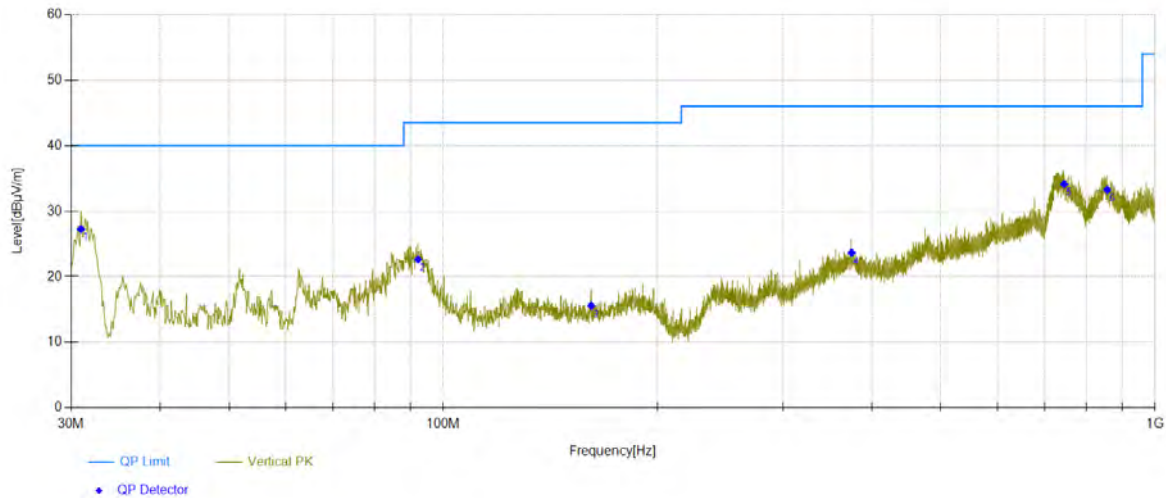
**Worst case Mode: 802.11n20\_Channel 11**



Data List								
NO.	Frequency [MHz]	Reading [dBµV]	Factor [dB]	AF [dB/m]	QP Value [dBµV/m]	QP Limit [dBµV/m]	QP Margin [dB]	Polarity
1	51.4391	27.37	-25.06	11.07	13.38	40.00	26.62	Horizontal
2	91.3101	37.99	-24.47	14.37	27.89	43.50	15.61	Horizontal
3	182.5963	29.17	-23.71	13.02	18.48	43.50	25.02	Horizontal
4	371.8622	27.61	-22.64	19.05	24.02	46.00	21.98	Horizontal
5	727.0147	26.05	-20.78	29.00	34.27	46.00	11.73	Horizontal
6	849.926	27.36	-20.89	27.80	34.27	46.00	11.73	Horizontal



Unless otherwise agreed in writing, this document is issued by the Company subject to its General Conditions of Service printed overleaf, available on request or accessible at <https://www.sgs.com/en/Terms-and-Conditions>. Attention is drawn to the limitation of liability, indemnification and jurisdiction issues defined therein. Any holder of this document is advised that information contained hereon reflects the Company's findings at the time of its intervention only and within the limits of Client's instructions, if any. The Company's sole responsibility is to its Client and this document does not exonerate parties to a transaction from exercising all their rights and obligations under the transaction documents. This document cannot be reproduced except in full, without prior written approval of the Company. Any unauthorized alteration, forgery or falsification of the content or appearance of this document is unlawful and offenders may be prosecuted to the fullest extent of the law. Unless otherwise stated the results shown in this test report refer only to the sample(s) tested and such sample(s) are retained for 30 days only.  
**Attention: To check the authenticity of testing /inspection report & certificate, please contact us at telephone: (86-755) 8307 1443, or email: CN.Doccheck@sgs.com**  
 No.1 Workshop, M-10, Middle Section, Science & Technology Park, Nanshan District, Shenzhen, Guangdong, China 518057 t (86-755) 26012053 www.sgs.com.cn  
 中国·广东·深圳市南山区科技园中区M-10栋1号厂房 邮编: 518057 t (86-755) 26012053 sgs.china@sgs.com



Data List								
NO.	Frequency [MHz]	Reading [dBµV]	Factor [dB]	AF [dB/m]	QP Value [dBµV/m]	QP Limit [dBµV/m]	QP Margin [dB]	Polarity
1	30.9701	43.63	-25.37	9.00	27.26	40.00	12.74	Vertical
2	92.1832	32.74	-24.48	14.38	22.64	43.50	20.86	Vertical
3	161.4481	27.5	-23.89	11.96	15.57	43.50	27.93	Vertical
4	374.7725	27.01	-22.61	19.26	23.66	46.00	22.34	Vertical
5	745.2525	26.22	-20.65	28.54	34.11	46.00	11.89	Vertical
6	856.6197	26.62	-20.77	27.39	33.24	46.00	12.76	Vertical

**Remark:**

- The field strength is calculated by adding the Antenna Factor, Cable Factor & Preamplifier gain. The basic equation with a sample calculation is as follows:  
 Value = Reading(dBµV) + AF(dB/m) + Factor(dB):  
 AF = Antenna Factor(dB/m)  
 Factor = Cable Factor(dB) - Preamplifier gain(dB)  
 Margin = Limit(dBµV/m) – Value(dBµV/m)
- All channels have been tested, but only the worst case data displayed in this report.



Unless otherwise agreed in writing, this document is issued by the Company subject to its General Conditions of Service printed overleaf, available on request or accessible at <https://www.sgs.com/en/Terms-and-Conditions>. Attention is drawn to the limitation of liability, indemnification and jurisdiction issues defined therein. Any holder of this document is advised that information contained hereon reflects the Company's findings at the time of its intervention only and within the limits of Client's instructions, if any. The Company's sole responsibility is to its Client and this document does not exonerate parties to a transaction from exercising all their rights and obligations under the transaction documents. This document cannot be reproduced except in full, without prior written approval of the Company. Any unauthorized alteration, forgery or falsification of the content or appearance of this document is unlawful and offenders may be prosecuted to the fullest extent of the law. Unless otherwise stated the results shown in this test report refer only to the sample(s) tested and such sample(s) are retained for 30 days only.

Attention: To check the authenticity of testing /inspection report & certificate, please contact us at telephone: (86-755) 8307 1443, or email: CN.Doccheck@sgs.com

No.1 Workshop, M-10, Middle Section, Science & Technology Park, Nanshan District, Shenzhen, Guangdong, China 518057 t (86-755) 26012053 www.sgsgroup.com.cn  
 中国·广东·深圳市南山区科技园中区M-10栋1号厂房 邮编: 518057 t (86-755) 26012053 sgs.china@sgs.com

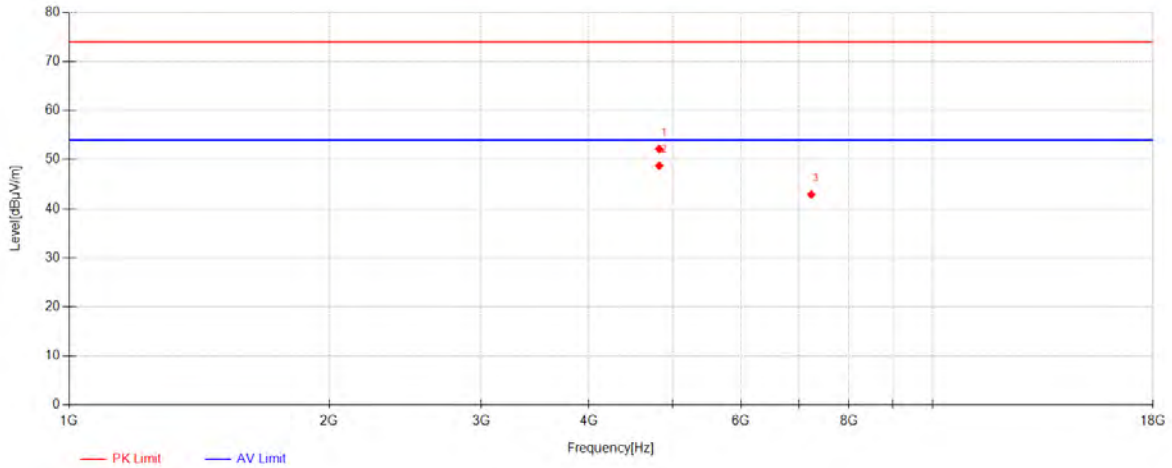


**SGS-CSTC Standards Technical Services Co., Ltd.**  
**Shenzhen Branch**

Report No.: SZCR240100035204  
 Page: 74 of 115

**Transmitter emission Above 1GHz**

**802.11b\_Channel 01**



Data List								
NO.	Frequency [MHz]	Reading [dBμV]	AF [dB/m]	Factor [dB]	Level [dBμV/m]	Limit [dBμV/m]	Margin [dB]	Polarity
1	4824	68.26	30.98	-47.08	52.16	74.00	21.84	Horizontal
2	4824	64.87	30.98	-47.08	48.77	54.00	5.23	Horizontal
3	7236.0000	52.23	36.08	-45.41	42.90	74.00	31.10	Horizontal



Unless otherwise agreed in writing, this document is issued by the Company subject to its General Conditions of Service printed overleaf, available on request or accessible at <https://www.sgs.com/en/Terms-and-Conditions>. Attention is drawn to the limitation of liability, indemnification and jurisdiction issues defined therein. Any holder of this document is advised that information contained hereon reflects the Company's findings at the time of its intervention only and within the limits of Client's instructions, if any. The Company's sole responsibility is to its Client and this document does not exonerate parties to a transaction from exercising all their rights and obligations under the transaction documents. This document cannot be reproduced except in full, without prior written approval of the Company. Any unauthorized alteration, forgery or falsification of the content or appearance of this document is unlawful and offenders may be prosecuted to the fullest extent of the law. Unless otherwise stated the results shown in this test report refer only to the sample(s) tested and such sample(s) are retained for 30 days only.  
**Attention: To check the authenticity of testing /inspection report & certificate, please contact us at telephone: (86-755) 8307 1443, or email: CN.Doccheck@sgs.com**

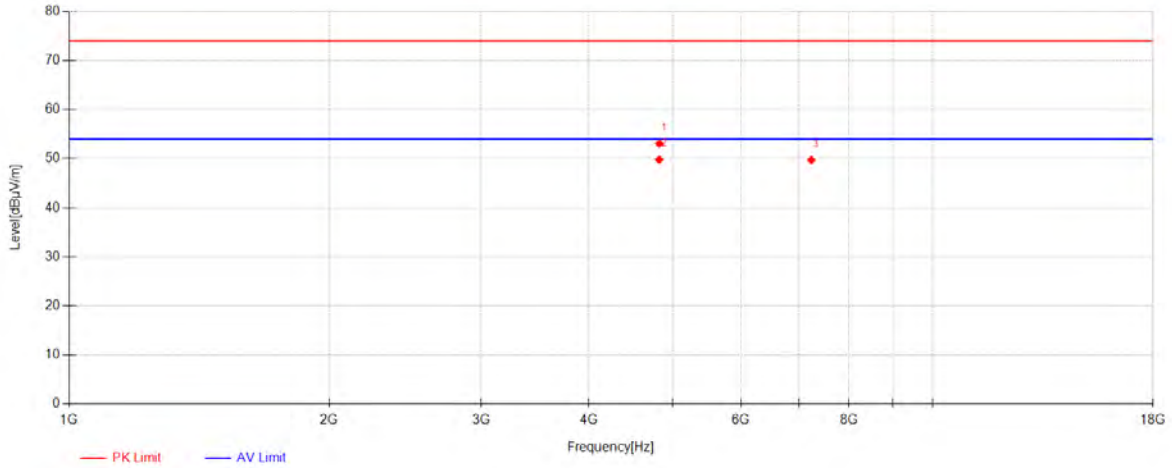
No.1 Workshop, M-10, Middle Section, Science & Technology Park, Nanshan District, Shenzhen, Guangdong, China 518057 t (86-755) 26012053 www.sgs.com.cn  
 中国·广东·深圳市南山区科技园中区M-10栋1号厂房 邮编: 518057 t (86-755) 26012053 sgs.china@sgs.com



**SGS-CSTC Standards Technical Services Co., Ltd.**  
**Shenzhen Branch**

Report No.: SZCR240100035204  
 Page: 75 of 115

**802.11b\_Channel 01**



Data List								
NO.	Frequency [MHz]	Reading [dBµV]	AF [dB/m]	Factor [dB]	Level [dBµV/m]	Limit [dBµV/m]	Margin [dB]	Polarity
1	4824	69.15	30.98	-47.08	53.05	74.00	20.95	Vertical
2	4824	65.88	30.98	-47.08	49.78	54.00	4.22	Vertical
3	7236.0000	59.03	36.08	-45.41	49.70	74.00	24.30	Vertical



Unless otherwise agreed in writing, this document is issued by the Company subject to its General Conditions of Service printed overleaf, available on request or accessible at <https://www.sgs.com/en/Terms-and-Conditions>. Attention is drawn to the limitation of liability, indemnification and jurisdiction issues defined therein. Any holder of this document is advised that information contained hereon reflects the Company's findings at the time of its intervention only and within the limits of Client's instructions, if any. The Company's sole responsibility is to its Client and this document does not exonerate parties to a transaction from exercising all their rights and obligations under the transaction documents. This document cannot be reproduced except in full, without prior written approval of the Company. Any unauthorized alteration, forgery or falsification of the content or appearance of this document is unlawful and offenders may be prosecuted to the fullest extent of the law. Unless otherwise stated the results shown in this test report refer only to the sample(s) tested and such sample(s) are retained for 30 days only.  
 Attention: To check the authenticity of testing /inspection report & certificate, please contact us at telephone: (86-755) 8307 1443, or email: CN.Doccheck@sgs.com

No.1 Workshop, M-10, Middle Section, Science & Technology Park, Nanshan District, Shenzhen, Guangdong, China 518057 t (86-755) 26012053 www.sgsgroup.com.cn  
 中国·广东·深圳市南山区科技园中区M-10栋1号厂房 邮编: 518057 t (86-755) 26012053 sgs.china@sgs.com

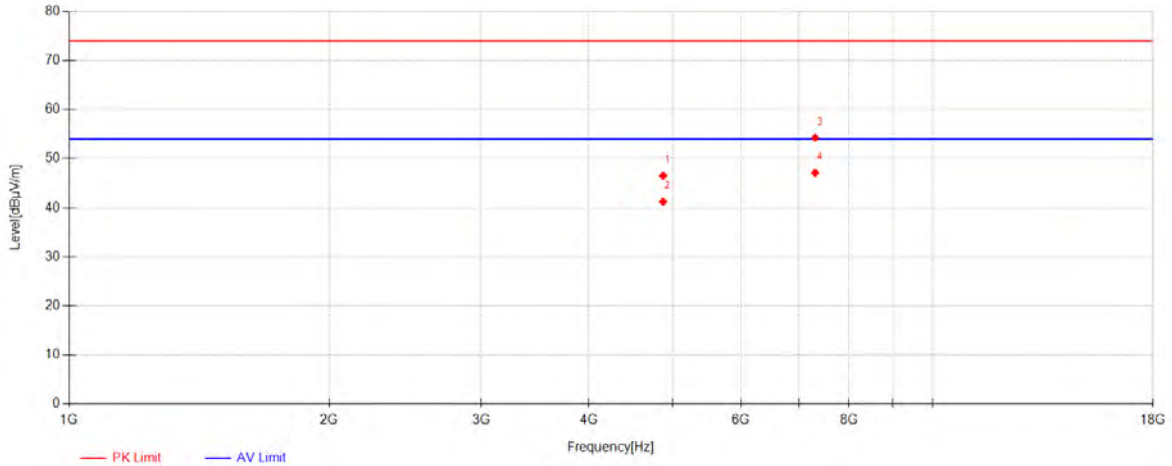




**SGS-CSTC Standards Technical Services Co., Ltd.**  
**Shenzhen Branch**

Report No.: SZCR240100035204  
 Page: 76 of 115

**802.11b\_Channel 06**



Data List								
NO.	Frequency [MHz]	Reading [dBµV]	AF [dB/m]	Factor [dB]	Level [dBµV/m]	Limit [dBµV/m]	Margin [dB]	Polarity
1	4874.0000	62.44	31.10	-47.02	46.52	74.00	27.48	Horizontal
2	4874.0000	57.11	31.10	-47.02	41.19	54.00	12.81	Horizontal
3	7311.0000	63.54	36.17	-45.45	54.26	74.00	19.74	Horizontal
4	7311.0000	56.37	36.17	-45.45	47.09	54.00	6.91	Horizontal

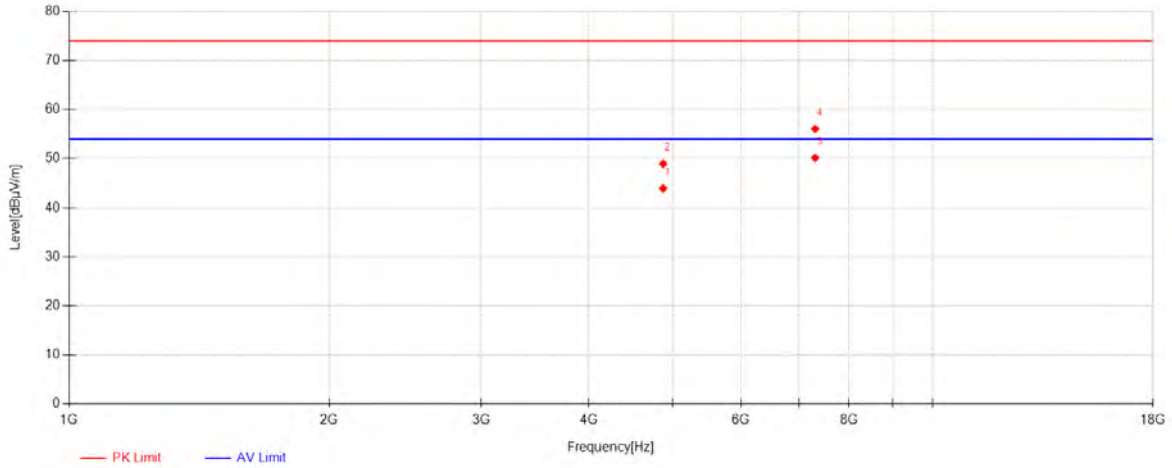


Unless otherwise agreed in writing, this document is issued by the Company subject to its General Conditions of Service printed overleaf, available on request or accessible at <https://www.sgs.com/en/Terms-and-Conditions>. Attention is drawn to the limitation of liability, indemnification and jurisdiction issues defined therein. Any holder of this document is advised that information contained hereon reflects the Company's findings at the time of its intervention only and within the limits of Client's instructions, if any. The Company's sole responsibility is to its Client and this document does not exonerate parties to a transaction from exercising all their rights and obligations under the transaction documents. This document cannot be reproduced except in full, without prior written approval of the Company. Any unauthorized alteration, forgery or falsification of the content or appearance of this document is unlawful and offenders may be prosecuted to the fullest extent of the law. Unless otherwise stated the results shown in this test report refer only to the sample(s) tested and such sample(s) are retained for 30 days only.  
**Attention: To check the authenticity of testing /inspection report & certificate, please contact us at telephone: (86-755) 8307 1443, or email: CN.Doccheck@sgs.com**

No.1 Workshop, M-10, Middle Section, Science & Technology Park, Nanshan District, Shenzhen, Guangdong, China 518057 t (86-755) 26012053 www.sgsgroup.com.cn  
 中国·广东·深圳市南山区科技园中区M-10栋1号厂房 邮编: 518057 t (86-755) 26012053 sgs.china@sgs.com



**802.11b\_Channel 06**

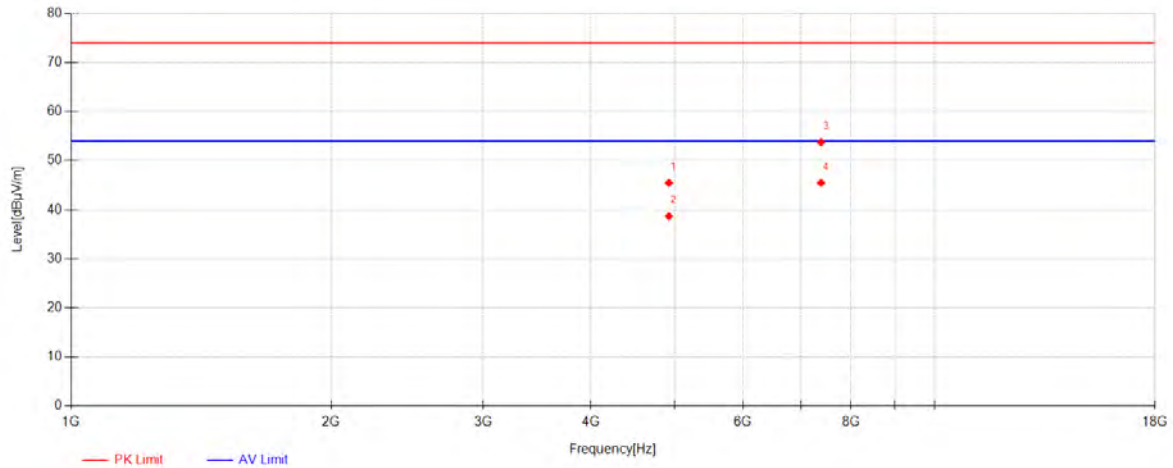


Data List								
NO.	Frequency [MHz]	Reading [dBµV]	AF [dB/m]	Factor [dB]	Level [dBµV/m]	Limit [dBµV/m]	Margin [dB]	Polarity
1	4874.0000	59.84	31.10	-47.02	43.92	54.00	10.08	Vertical
2	4874.0000	64.89	31.10	-47.02	48.97	74.00	25.03	Vertical
3	7311.0000	59.44	36.17	-45.45	50.16	54.00	3.84	Vertical
4	7311.0000	65.34	36.17	-45.45	56.06	74.00	17.94	Vertical



Unless otherwise agreed in writing, this document is issued by the Company subject to its General Conditions of Service printed overleaf, available on request or accessible at <https://www.sgs.com/en/Terms-and-Conditions>. Attention is drawn to the limitation of liability, indemnification and jurisdiction issues defined therein. Any holder of this document is advised that information contained hereon reflects the Company's findings at the time of its intervention only and within the limits of Client's instructions, if any. The Company's sole responsibility is to its Client and this document does not exonerate parties to a transaction from exercising all their rights and obligations under the transaction documents. This document cannot be reproduced except in full, without prior written approval of the Company. Any unauthorized alteration, forgery or falsification of the content or appearance of this document is unlawful and offenders may be prosecuted to the fullest extent of the law. Unless otherwise stated the results shown in this test report refer only to the sample(s) tested and such sample(s) are retained for 30 days only.  
**Attention: To check the authenticity of testing /inspection report & certificate, please contact us at telephone: (86-755) 8307 1443, or email: CN.Doccheck@sgs.com**

No.1 Workshop, M-10, Middle Section, Science & Technology Park, Nanshan District, Shenzhen, Guangdong, China 518057 t (86-755) 26012053 www.sgs.com.cn  
 中国·广东·深圳市南山区科技园中区M-10栋1号厂房 邮编: 518057 t (86-755) 26012053 sgs.china@sgs.com


**802.11b\_Channel 11**


Data List								
NO.	Frequency [MHz]	Reading [dBµV]	AF [dB/m]	Factor [dB]	Level [dBµV/m]	Limit [dBµV/m]	Margin [dB]	Polarity
1	4924.0000	61.28	31.22	-47.04	45.46	74.00	28.54	Horizontal
2	4924.0000	54.52	31.22	-47.04	38.70	54.00	15.30	Horizontal
3	7386.0000	62.61	36.26	-45.13	53.74	74.00	20.26	Horizontal
4	7386.0000	54.35	36.26	-45.13	45.48	54.00	8.52	Horizontal



Unless otherwise agreed in writing, this document is issued by the Company subject to its General Conditions of Service printed overleaf, available on request or accessible at <https://www.sgs.com/en/Terms-and-Conditions>. Attention is drawn to the limitation of liability, indemnification and jurisdiction issues defined therein. Any holder of this document is advised that information contained hereon reflects the Company's findings at the time of its intervention only and within the limits of Client's instructions, if any. The Company's sole responsibility is to its Client and this document does not exonerate parties to a transaction from exercising all their rights and obligations under the transaction documents. This document cannot be reproduced except in full, without prior written approval of the Company. Any unauthorized alteration, forgery or falsification of the content or appearance of this document is unlawful and offenders may be prosecuted to the fullest extent of the law. Unless otherwise stated the results shown in this test report refer only to the sample(s) tested and such sample(s) are retained for 30 days only.

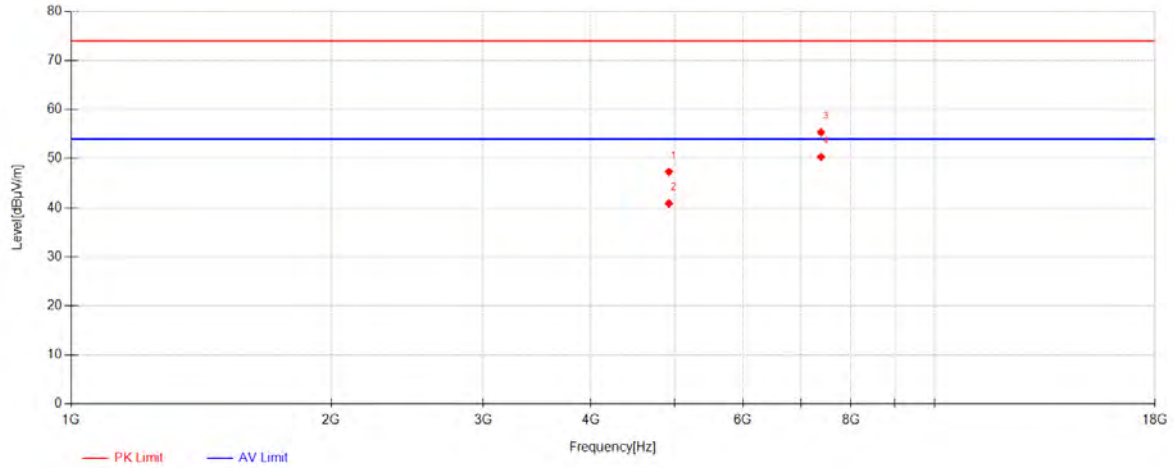
Attention: To check the authenticity of testing /inspection report & certificate, please contact us at telephone: (86-755) 8307 1443, or email: CN.Doccheck@sgs.com



**SGS-CSTC Standards Technical Services Co., Ltd.**  
**Shenzhen Branch**

Report No.: SZCR240100035204  
 Page: 79 of 115

**802.11b\_Channel 11**



Data List								
NO.	Frequency [MHz]	Reading [dBµV]	AF [dB/m]	Factor [dB]	Level [dBµV/m]	Limit [dBµV/m]	Margin [dB]	Polarity
1	4924.0000	63.13	31.22	-47.04	47.31	74.00	26.69	Vertical
2	4924.0000	56.68	31.22	-47.04	40.86	54.00	13.14	Vertical
3	7386.0000	64.22	36.26	-45.13	55.35	74.00	18.65	Vertical
4	7386.0000	59.23	36.26	-45.13	50.36	54.00	3.64	Vertical



Unless otherwise agreed in writing, this document is issued by the Company subject to its General Conditions of Service printed overleaf, available on request or accessible at <https://www.sgs.com/en/Terms-and-Conditions>. Attention is drawn to the limitation of liability, indemnification and jurisdiction issues defined therein. Any holder of this document is advised that information contained hereon reflects the Company's findings at the time of its intervention only and within the limits of Client's instructions, if any. The Company's sole responsibility is to its Client and this document does not exonerate parties to a transaction from exercising all their rights and obligations under the transaction documents. This document cannot be reproduced except in full, without prior written approval of the Company. Any unauthorized alteration, forgery or falsification of the content or appearance of this document is unlawful and offenders may be prosecuted to the fullest extent of the law. Unless otherwise stated the results shown in this test report refer only to the sample(s) tested and such sample(s) are retained for 30 days only.  
**Attention: To check the authenticity of testing /inspection report & certificate, please contact us at telephone: (86-755) 8307 1443, or email: CN.Doccheck@sgs.com**  
 No.1 Workshop, M-10, Middle Section, Science & Technology Park, Nanshan District, Shenzhen, Guangdong, China 518057 t (86-755) 26012053 www.sgsgroup.com.cn  
 中国·广东·深圳市南山区科技园中区M-10栋1号厂房 邮编: 518057 t (86-755) 26012053 sgs.china@sgs.com

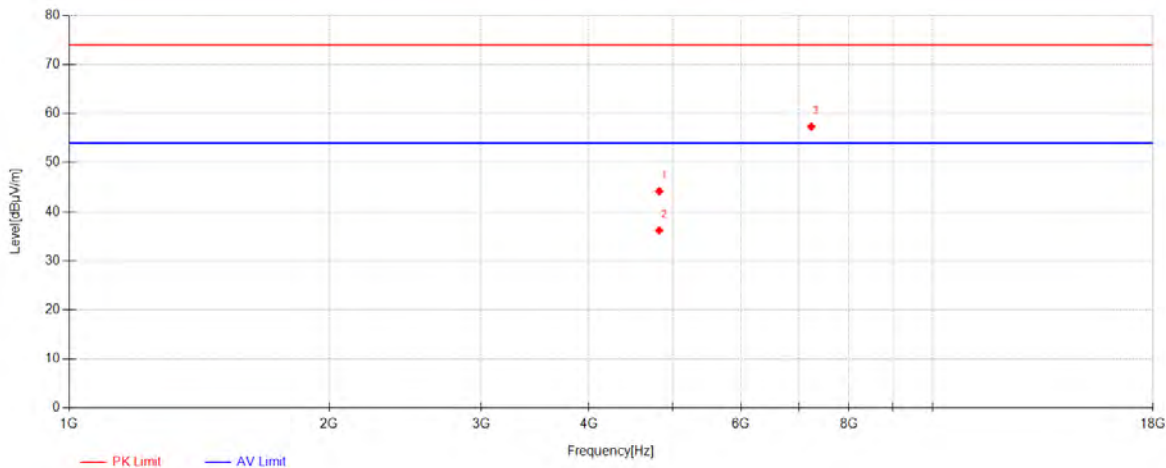




**SGS-CSTC Standards Technical Services Co., Ltd.**  
**Shenzhen Branch**

Report No.: SZCR240100035204  
 Page: 80 of 115

**802.11g\_Channel 01**



Data List								
NO.	Frequency [MHz]	Reading [dBµV]	AF [dB/m]	Factor [dB]	Level [dBµV/m]	Limit [dBµV/m]	Margin [dB]	Polarity
1	4824.0000	60.26	30.98	-47.08	44.16	74.00	29.84	Horizontal
2	4824.0000	52.30	30.98	-47.08	36.20	54.00	17.80	Horizontal
3	7236.0000	66.67	36.08	-45.41	57.34	74.00	16.66	Horizontal



Unless otherwise agreed in writing, this document is issued by the Company subject to its General Conditions of Service printed overleaf, available on request or accessible at <https://www.sgs.com/en/Terms-and-Conditions>. Attention is drawn to the limitation of liability, indemnification and jurisdiction issues defined therein. Any holder of this document is advised that information contained hereon reflects the Company's findings at the time of its intervention only and within the limits of Client's instructions, if any. The Company's sole responsibility is to its Client and this document does not exonerate parties to a transaction from exercising all their rights and obligations under the transaction documents. This document cannot be reproduced except in full, without prior written approval of the Company. Any unauthorized alteration, forgery or falsification of the content or appearance of this document is unlawful and offenders may be prosecuted to the fullest extent of the law. Unless otherwise stated the results shown in this test report refer only to the sample(s) tested and such sample(s) are retained for 30 days only.  
 Attention: To check the authenticity of testing /inspection report & certificate, please contact us at telephone: (86-755) 8307 1443, or email: CN.Doccheck@sgs.com

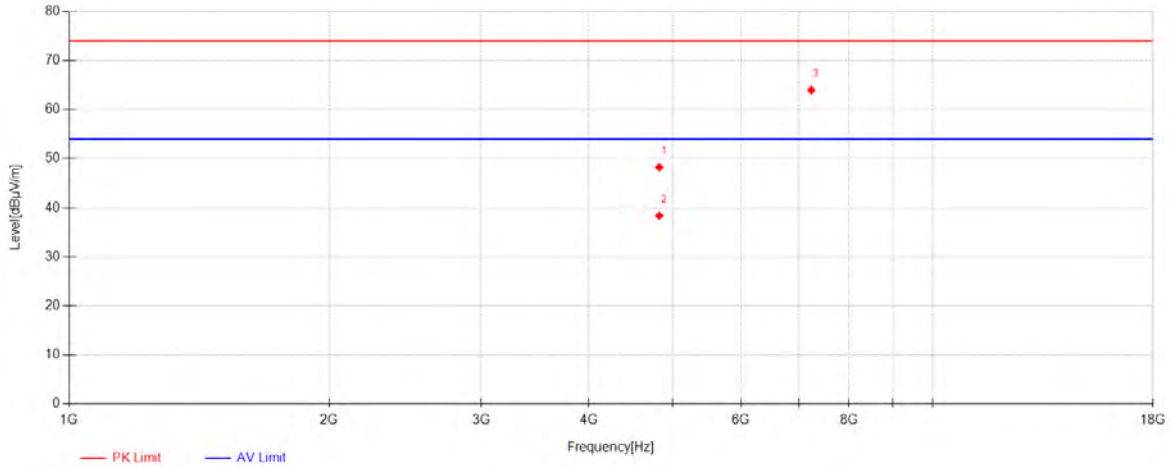
No.1 Workshop, M-10, Middle Section, Science & Technology Park, Nanshan District, Shenzhen, Guangdong, China 518057 t (86-755) 26012053 www.sgsgroup.com.cn  
 中国·广东·深圳市南山区科技园中区M-10栋1号厂房 邮编: 518057 t (86-755) 26012053 sgs.china@sgs.com



**SGS-CSTC Standards Technical Services Co., Ltd.**  
**Shenzhen Branch**

Report No.: SZCR240100035204  
 Page: 81 of 115

**802.11g\_Channel 01**



Data List								
NO.	Frequency [MHz]	Reading [dBµV]	AF [dB/m]	Factor [dB]	Level [dBµV/m]	Limit [dBµV/m]	Margin [dB]	Polarity
1	4824.0000	64.34	30.98	-47.08	48.24	74.00	25.76	Vertical
2	4824.0000	54.49	30.98	-47.08	38.39	54.00	15.61	Vertical
3	7236.0000	73.27	36.08	-45.41	63.94	74.00	10.06	Vertical



Unless otherwise agreed in writing, this document is issued by the Company subject to its General Conditions of Service printed overleaf, available on request or accessible at <https://www.sgs.com/en/Terms-and-Conditions>. Attention is drawn to the limitation of liability, indemnification and jurisdiction issues defined therein. Any holder of this document is advised that information contained hereon reflects the Company's findings at the time of its intervention only and within the limits of Client's instructions, if any. The Company's sole responsibility is to its Client and this document does not exonerate parties to a transaction from exercising all their rights and obligations under the transaction documents. This document cannot be reproduced except in full, without prior written approval of the Company. Any unauthorized alteration, forgery or falsification of the content or appearance of this document is unlawful and offenders may be prosecuted to the fullest extent of the law. Unless otherwise stated the results shown in this test report refer only to the sample(s) tested and such sample(s) are retained for 30 days only.  
 Attention: To check the authenticity of testing /inspection report & certificate, please contact us at telephone: (86-755) 8307 1443, or email: CN.Doccheck@sgs.com

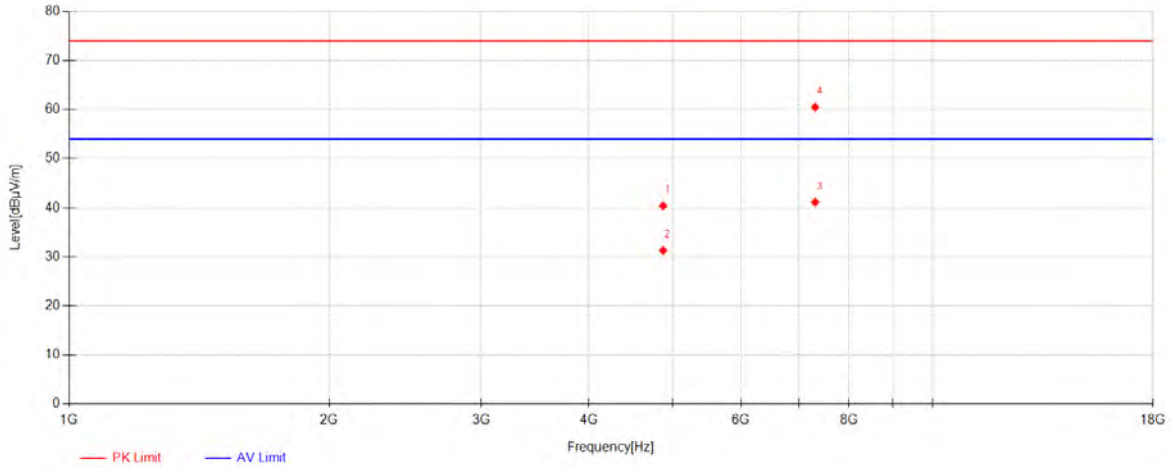
No.1 Workshop, M-10, Middle Section, Science & Technology Park, Nanshan District, Shenzhen, Guangdong, China 518057 t (86-755) 26012053 www.sgs.com.cn  
 中国·广东·深圳市南山区科技园中区M-10栋1号厂房 邮编: 518057 t (86-755) 26012053 sgs.china@sgs.com



**SGS-CSTC Standards Technical Services Co., Ltd.**  
**Shenzhen Branch**

Report No.: SZCR240100035204  
 Page: 82 of 115

**802.11g\_Channel 06**



Data List								
NO.	Frequency [MHz]	Reading [dBµV]	AF [dB/m]	Factor [dB]	Level [dBµV/m]	Limit [dBµV/m]	Margin [dB]	Polarity
1	4874.0000	56.30	31.10	-47.02	40.38	74.00	33.62	Horizontal
2	4874.0000	47.24	31.10	-47.02	31.32	54.00	22.68	Horizontal
3	7311.0000	50.38	36.17	-45.45	41.10	54.00	12.90	Horizontal
4	7311.0000	69.79	36.17	-45.45	60.51	74.00	13.49	Horizontal



Unless otherwise agreed in writing, this document is issued by the Company subject to its General Conditions of Service printed overleaf, available on request or accessible at <https://www.sgs.com/en/Terms-and-Conditions>. Attention is drawn to the limitation of liability, indemnification and jurisdiction issues defined therein. Any holder of this document is advised that information contained hereon reflects the Company's findings at the time of its intervention only and within the limits of Client's instructions, if any. The Company's sole responsibility is to its Client and this document does not exonerate parties to a transaction from exercising all their rights and obligations under the transaction documents. This document cannot be reproduced except in full, without prior written approval of the Company. Any unauthorized alteration, forgery or falsification of the content or appearance of this document is unlawful and offenders may be prosecuted to the fullest extent of the law. Unless otherwise stated the results shown in this test report refer only to the sample(s) tested and such sample(s) are retained for 30 days only.  
**Attention: To check the authenticity of testing /inspection report & certificate, please contact us at telephone: (86-755) 8307 1443, or email: CN.Doccheck@sgs.com**

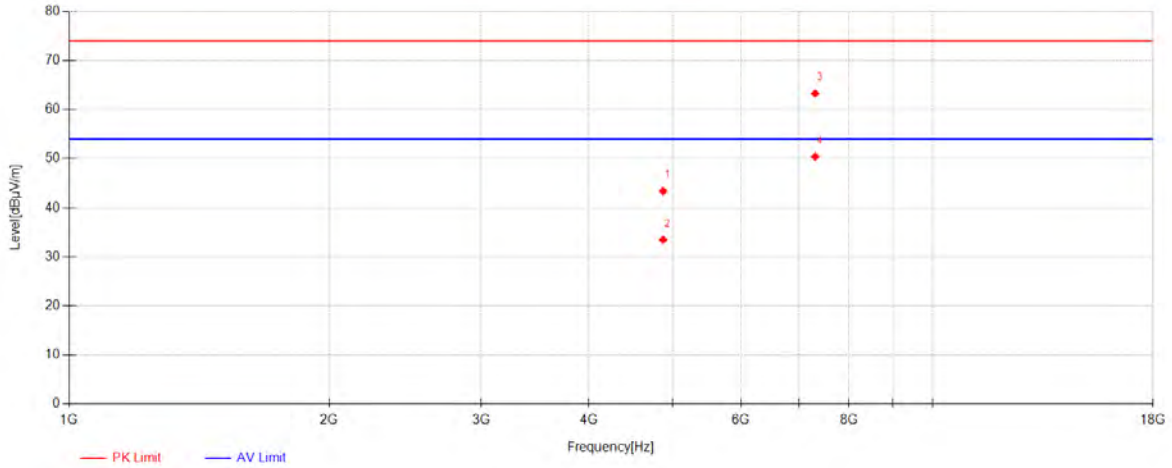
No.1 Workshop, M-10, Middle Section, Science & Technology Park, Nanshan District, Shenzhen, Guangdong, China 518057 t (86-755) 26012053 www.sgs.com.cn  
 中国·广东·深圳市南山区科技园中区M-10栋1号厂房 邮编: 518057 t (86-755) 26012053 sgs.china@sgs.com



**SGS-CSTC Standards Technical Services Co., Ltd.**  
**Shenzhen Branch**

Report No.: SZCR240100035204  
 Page: 83 of 115

**802.11g\_Channel 06**



Data List								
NO.	Frequency [MHz]	Reading [dBµV]	AF [dB/m]	Factor [dB]	Level [dBµV/m]	Limit [dBµV/m]	Margin [dB]	Polarity
1	4874.0000	59.29	31.10	-47.02	43.37	74.00	30.63	Vertical
2	4874.0000	49.41	31.10	-47.02	33.49	54.00	20.51	Vertical
3	7311.0000	72.55	36.17	-45.45	63.27	74.00	10.73	Vertical
4	7311.0000	59.69	36.17	-45.45	50.41	54.00	3.59	Vertical



Unless otherwise agreed in writing, this document is issued by the Company subject to its General Conditions of Service printed overleaf, available on request or accessible at <https://www.sgs.com/en/Terms-and-Conditions>. Attention is drawn to the limitation of liability, indemnification and jurisdiction issues defined therein. Any holder of this document is advised that information contained hereon reflects the Company's findings at the time of its intervention only and within the limits of Client's instructions, if any. The Company's sole responsibility is to its Client and this document does not exonerate parties to a transaction from exercising all their rights and obligations under the transaction documents. This document cannot be reproduced except in full, without prior written approval of the Company. Any unauthorized alteration, forgery or falsification of the content or appearance of this document is unlawful and offenders may be prosecuted to the fullest extent of the law. Unless otherwise stated the results shown in this test report refer only to the sample(s) tested and such sample(s) are retained for 30 days only.  
**Attention: To check the authenticity of testing /inspection report & certificate, please contact us at telephone: (86-755) 8307 1443, or email: CN.Doccheck@sgs.com**  
 No.1 Workshop, M-10, Middle Section, Science & Technology Park, Nanshan District, Shenzhen, Guangdong, China 518057 t (86-755) 26012053 www.sgs.com.cn  
 中国·广东·深圳市南山区科技园中区M-10栋1号厂房 邮编: 518057 t (86-755) 26012053 sgs.china@sgs.com

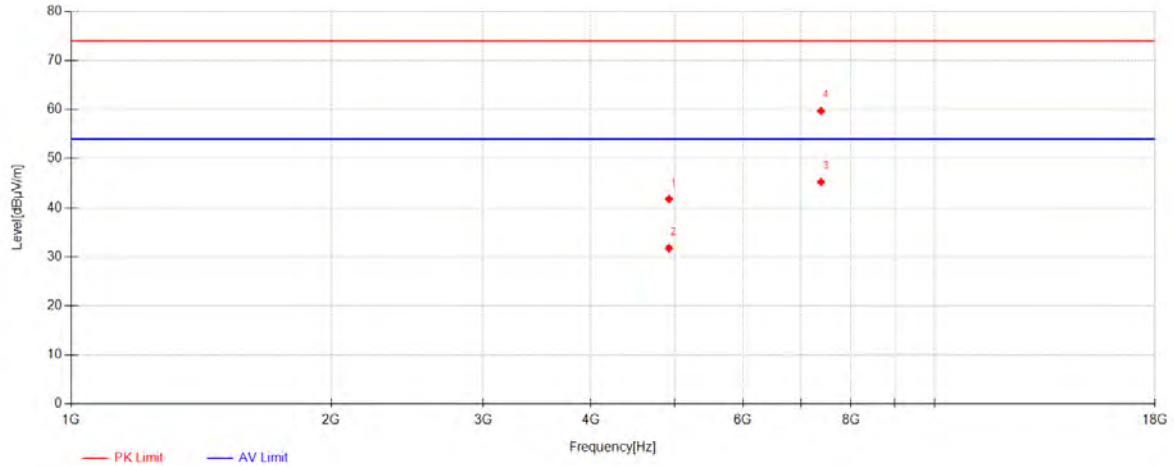




**SGS-CSTC Standards Technical Services Co., Ltd.**  
**Shenzhen Branch**

Report No.: SZCR240100035204  
 Page: 84 of 115

**802.11g\_Channel 11**



Data List								
NO.	Frequency [MHz]	Reading [dBµV]	AF [dB/m]	Factor [dB]	Level [dBµV/m]	Limit [dBµV/m]	Margin [dB]	Polarity
1	4924.0000	57.60	31.22	-47.04	41.78	74.00	32.22	Horizontal
2	4924.0000	47.59	31.22	-47.04	31.77	54.00	22.23	Horizontal
3	7386.0000	54.10	36.26	-45.13	45.23	54.00	8.77	Horizontal
4	7386.0000	68.59	36.26	-45.13	59.72	74.00	14.28	Horizontal



Unless otherwise agreed in writing, this document is issued by the Company subject to its General Conditions of Service printed overleaf, available on request or accessible at <https://www.sgs.com/en/Terms-and-Conditions>. Attention is drawn to the limitation of liability, indemnification and jurisdiction issues defined therein. Any holder of this document is advised that information contained hereon reflects the Company's findings at the time of its intervention only and within the limits of Client's instructions, if any. The Company's sole responsibility is to its Client and this document does not exonerate parties to a transaction from exercising all their rights and obligations under the transaction documents. This document cannot be reproduced except in full, without prior written approval of the Company. Any unauthorized alteration, forgery or falsification of the content or appearance of this document is unlawful and offenders may be prosecuted to the fullest extent of the law. Unless otherwise stated the results shown in this test report refer only to the sample(s) tested and such sample(s) are retained for 30 days only.  
 Attention: To check the authenticity of testing /inspection report & certificate, please contact us at telephone: (86-755) 8307 1443, or email: CN.Doccheck@sgs.com

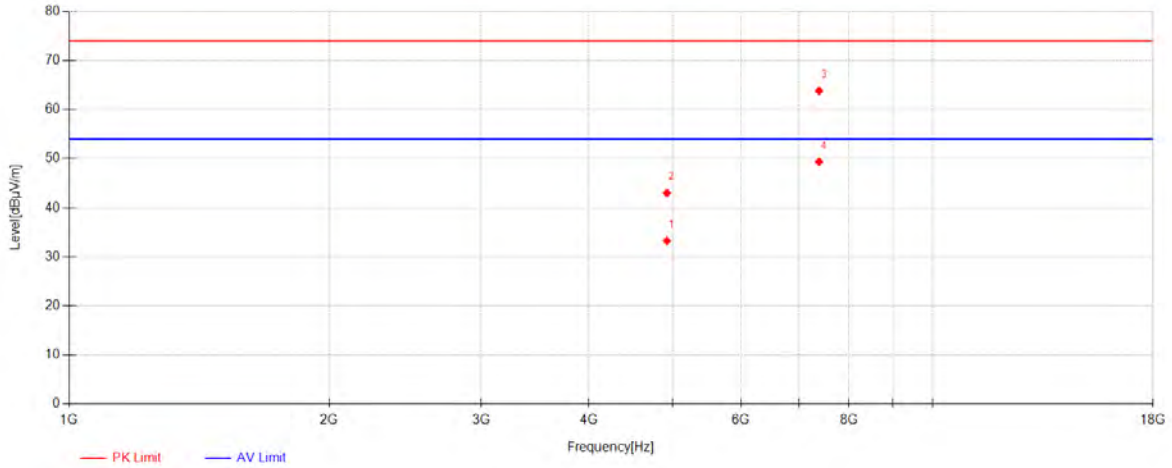
No.1 Workshop, M-10, Middle Section, Science & Technology Park, Nanshan District, Shenzhen, Guangdong, China 518057 t (86-755) 26012053 www.sgs.com.cn  
 中国·广东·深圳市南山区科技园中区M-10栋1号厂房 邮编: 518057 t (86-755) 26012053 sgs.china@sgs.com



**SGS-CSTC Standards Technical Services Co., Ltd.**  
**Shenzhen Branch**

Report No.: SZCR240100035204  
 Page: 85 of 115

**802.11g\_Channel 11**



Data List								
NO.	Frequency [MHz]	Reading [dBµV]	AF [dB/m]	Factor [dB]	Level [dBµV/m]	Limit [dBµV/m]	Margin [dB]	Polarity
1	4924.0000	49.06	31.22	-47.04	33.24	54.00	20.76	Vertical
2	4924.0000	58.83	31.22	-47.04	43.01	74.00	30.99	Vertical
3	7386.0000	72.69	36.26	-45.13	63.82	74.00	10.18	Vertical
4	7386.0000	58.25	36.26	-45.13	49.38	54.00	4.62	Vertical



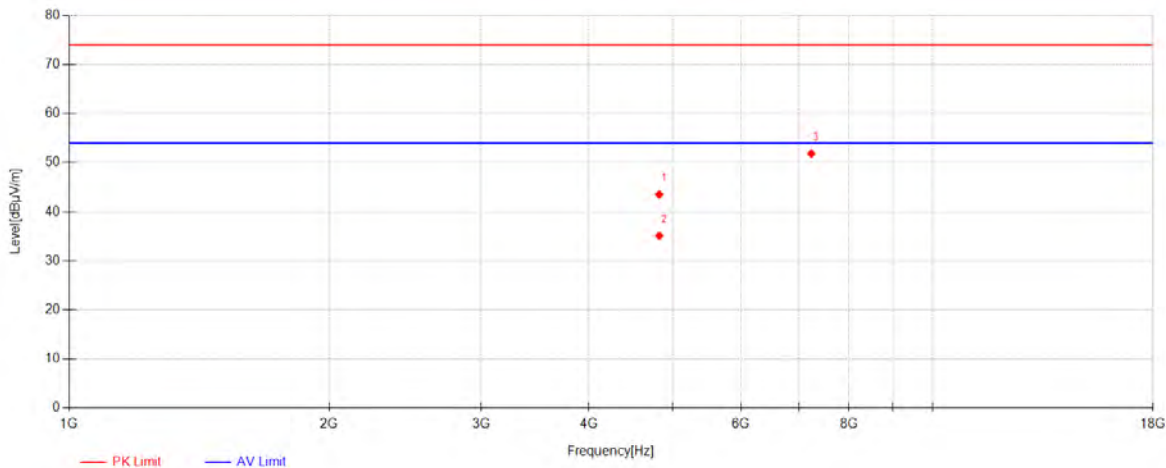
Unless otherwise agreed in writing, this document is issued by the Company subject to its General Conditions of Service printed overleaf, available on request or accessible at <https://www.sgs.com/en/Terms-and-Conditions>. Attention is drawn to the limitation of liability, indemnification and jurisdiction issues defined therein. Any holder of this document is advised that information contained hereon reflects the Company's findings at the time of its intervention only and within the limits of Client's instructions, if any. The Company's sole responsibility is to its Client and this document does not exonerate parties to a transaction from exercising all their rights and obligations under the transaction documents. This document cannot be reproduced except in full, without prior written approval of the Company. Any unauthorized alteration, forgery or falsification of the content or appearance of this document is unlawful and offenders may be prosecuted to the fullest extent of the law. Unless otherwise stated the results shown in this test report refer only to the sample(s) tested and such sample(s) are retained for 30 days only.  
**Attention: To check the authenticity of testing /inspection report & certificate, please contact us at telephone: (86-755) 8307 1443, or email: CN.Doccheck@sgs.com**  
 No.1 Workshop, M-10, Middle Section, Science & Technology Park, Nanshan District, Shenzhen, Guangdong, China 518057 t (86-755) 26012053 www.sgs.com.cn  
 中国·广东·深圳市南山区科技园中区M-10栋1号厂房 邮编: 518057 t (86-755) 26012053 sgs.china@sgs.com



**SGS-CSTC Standards Technical Services Co., Ltd.**  
**Shenzhen Branch**

Report No.: SZCR240100035204  
 Page: 86 of 115

**802.11n20\_Channel 01**



Data List								
NO.	Frequency [MHz]	Reading [dBµV]	AF [dB/m]	Factor [dB]	Level [dBµV/m]	Limit [dBµV/m]	Margin [dB]	Polarity
1	4824.0000	59.61	30.98	-47.08	43.51	74.00	30.49	Horizontal
2	4824.0000	51.17	30.98	-47.08	35.07	54.00	18.93	Horizontal
3	7236.0000	61.18	36.08	-45.41	51.85	74.00	22.15	Horizontal



Unless otherwise agreed in writing, this document is issued by the Company subject to its General Conditions of Service printed overleaf, available on request or accessible at <https://www.sgs.com/en/Terms-and-Conditions>. Attention is drawn to the limitation of liability, indemnification and jurisdiction issues defined therein. Any holder of this document is advised that information contained hereon reflects the Company's findings at the time of its intervention only and within the limits of Client's instructions, if any. The Company's sole responsibility is to its Client and this document does not exonerate parties to a transaction from exercising all their rights and obligations under the transaction documents. This document cannot be reproduced except in full, without prior written approval of the Company. Any unauthorized alteration, forgery or falsification of the content or appearance of this document is unlawful and offenders may be prosecuted to the fullest extent of the law. Unless otherwise stated the results shown in this test report refer only to the sample(s) tested and such sample(s) are retained for 30 days only.  
 Attention: To check the authenticity of testing /inspection report & certificate, please contact us at telephone: (86-755) 8307 1443, or email: CN.Doccheck@sgs.com

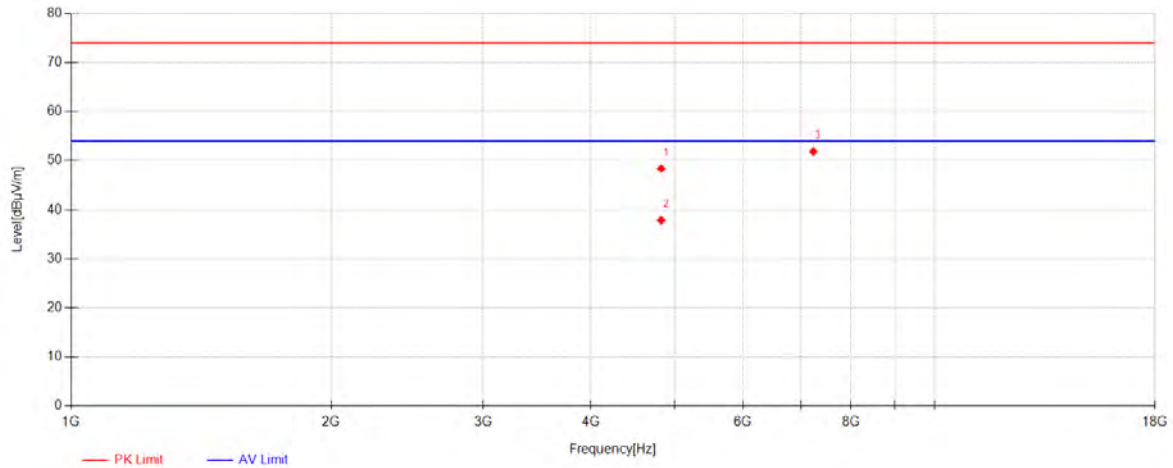
No.1 Workshop, M-10, Middle Section, Science & Technology Park, Nanshan District, Shenzhen, Guangdong, China 518057 t (86-755) 26012053 www.sgsgroup.com.cn  
 中国·广东·深圳市南山区科技园中区M-10栋1号厂房 邮编: 518057 t (86-755) 26012053 sgs.china@sgs.com



# SGS-CSTC Standards Technical Services Co., Ltd. Shenzhen Branch

Report No.: SZCR240100035204  
Page: 87 of 115

## 802.11n20\_Channel 01



Data List								
NO.	Frequency [MHz]	Reading [dBμV]	AF [dB/m]	Factor [dB]	Level [dBμV/m]	Limit [dBμV/m]	Margin [dB]	Polarity
1	4823.0000	64.49	30.98	-47.08	48.39	74.00	25.61	Vertical
2	4823.0000	53.95	30.98	-47.08	37.85	54.00	16.15	Vertical
3	7236.0000	61.21	36.08	-45.41	51.88	74.00	22.12	Vertical



Unless otherwise agreed in writing, this document is issued by the Company subject to its General Conditions of Service printed overleaf, available on request or accessible at <https://www.sgs.com/en/Terms-and-Conditions>. Attention is drawn to the limitation of liability, indemnification and jurisdiction issues defined therein. Any holder of this document is advised that information contained hereon reflects the Company's findings at the time of its intervention only and within the limits of Client's instructions, if any. The Company's sole responsibility is to its Client and this document does not exonerate parties to a transaction from exercising all their rights and obligations under the transaction documents. This document cannot be reproduced except in full, without prior written approval of the Company. Any unauthorized alteration, forgery or falsification of the content or appearance of this document is unlawful and offenders may be prosecuted to the fullest extent of the law. Unless otherwise stated the results shown in this test report refer only to the sample(s) tested and such sample(s) are retained for 30 days only.

Attention: To check the authenticity of testing /inspection report & certificate, please contact us at telephone: (86-755) 8307 1443, or email: CN.Doccheck@sgs.com  
No.1 Workshop, M-10, Middle Section, Science & Technology Park, Nanshan District, Shenzhen, Guangdong, China 518057 t (86-755) 26012053 www.sgsgroup.com.cn  
中国·广东·深圳市南山区科技园中区M-10栋1号厂房 邮编: 518057 t (86-755) 26012053 sgs.china@sgs.com

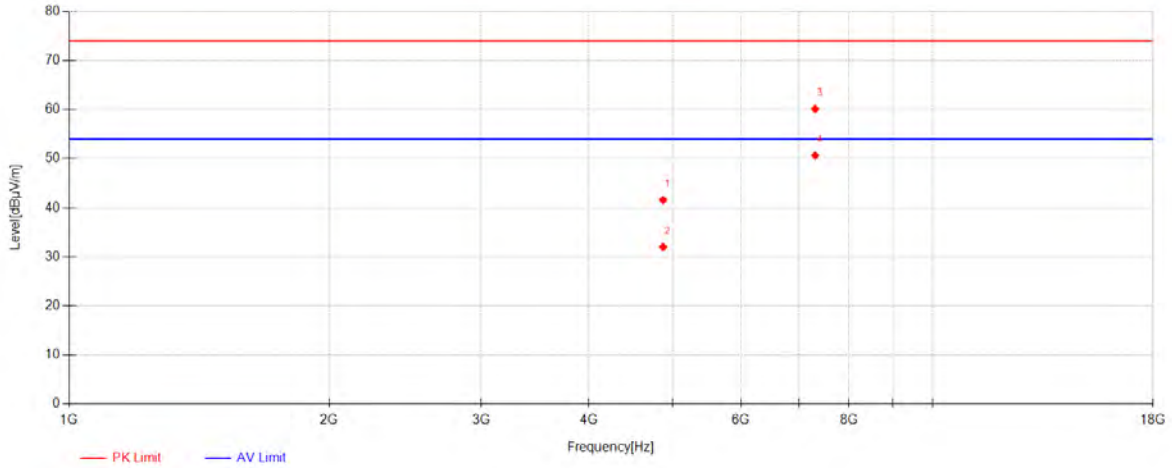




**SGS-CSTC Standards Technical Services Co., Ltd.**  
**Shenzhen Branch**

Report No.: SZCR240100035204  
 Page: 88 of 115

**802.11n20\_Channel 06**



Data List								
NO.	Frequency [MHz]	Reading [dBµV]	AF [dB/m]	Factor [dB]	Level [dBµV/m]	Limit [dBµV/m]	Margin [dB]	Polarity
1	4874.0000	57.48	31.10	-47.02	41.56	74.00	32.44	Horizontal
2	4874.0000	47.91	31.10	-47.02	31.99	54.00	22.01	Horizontal
3	7311.0000	69.43	36.17	-45.45	60.15	74.00	13.85	Horizontal
4	7311.0000	59.93	36.17	-45.45	50.65	54.00	3.35	Horizontal



Unless otherwise agreed in writing, this document is issued by the Company subject to its General Conditions of Service printed overleaf, available on request or accessible at <https://www.sgs.com/en/Terms-and-Conditions>. Attention is drawn to the limitation of liability, indemnification and jurisdiction issues defined therein. Any holder of this document is advised that information contained hereon reflects the Company's findings at the time of its intervention only and within the limits of Client's instructions, if any. The Company's sole responsibility is to its Client and this document does not exonerate parties to a transaction from exercising all their rights and obligations under the transaction documents. This document cannot be reproduced except in full, without prior written approval of the Company. Any unauthorized alteration, forgery or falsification of the content or appearance of this document is unlawful and offenders may be prosecuted to the fullest extent of the law. Unless otherwise stated the results shown in this test report refer only to the sample(s) tested and such sample(s) are retained for 30 days only.  
**Attention: To check the authenticity of testing /inspection report & certificate, please contact us at telephone: (86-755) 8307 1443, or email: CN.Doccheck@sgs.com**

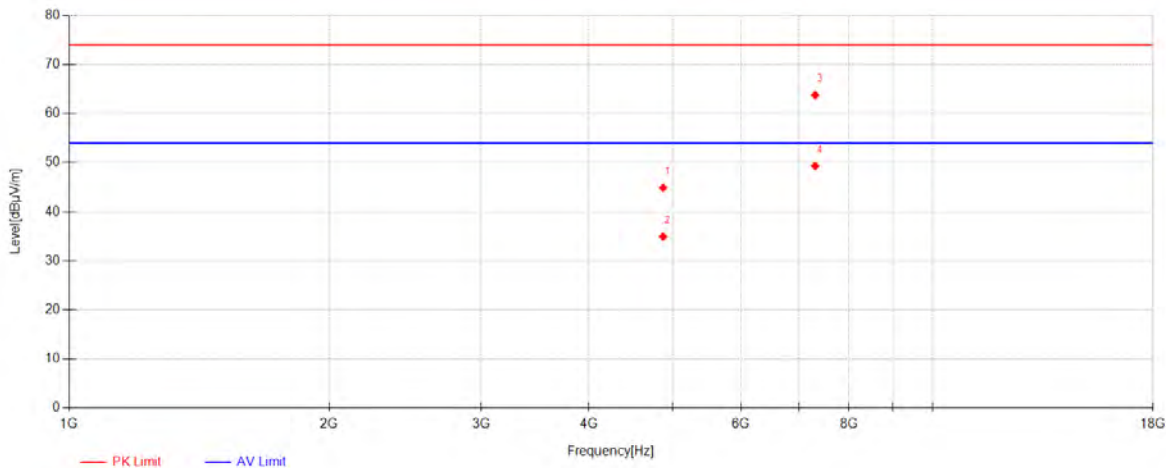
No.1 Workshop, M-10, Middle Section, Science & Technology Park, Nanshan District, Shenzhen, Guangdong, China 518057 t (86-755) 26012053 www.sgsgroup.com.cn  
 中国·广东·深圳市南山区科技园中区M-10栋1号厂房 邮编: 518057 t (86-755) 26012053 sgs.china@sgs.com



**SGS-CSTC Standards Technical Services Co., Ltd.**  
**Shenzhen Branch**

Report No.: SZCR240100035204  
 Page: 89 of 115

**802.11n20\_Channel 06**



Data List								
NO.	Frequency [MHz]	Reading [dBµV]	AF [dB/m]	Factor [dB]	Level [dBµV/m]	Limit [dBµV/m]	Margin [dB]	Polarity
1	4874.0000	60.79	31.10	-47.02	44.87	74.00	29.13	Vertical
2	4874.0000	50.82	31.10	-47.02	34.90	54.00	19.10	Vertical
3	7311.0000	73.05	36.17	-45.45	63.77	74.00	10.73	Vertical
4	7311.0000	58.60	36.17	-45.45	49.32	54.00	4.68	Vertical



Unless otherwise agreed in writing, this document is issued by the Company subject to its General Conditions of Service printed overleaf, available on request or accessible at <https://www.sgs.com/en/Terms-and-Conditions>. Attention is drawn to the limitation of liability, indemnification and jurisdiction issues defined therein. Any holder of this document is advised that information contained hereon reflects the Company's findings at the time of its intervention only and within the limits of Client's instructions, if any. The Company's sole responsibility is to its Client and this document does not exonerate parties to a transaction from exercising all their rights and obligations under the transaction documents. This document cannot be reproduced except in full, without prior written approval of the Company. Any unauthorized alteration, forgery or falsification of the content or appearance of this document is unlawful and offenders may be prosecuted to the fullest extent of the law. Unless otherwise stated the results shown in this test report refer only to the sample(s) tested and such sample(s) are retained for 30 days only.  
 Attention: To check the authenticity of testing /inspection report & certificate, please contact us at telephone: (86-755) 8307 1443, or email: CN.Doccheck@sgs.com

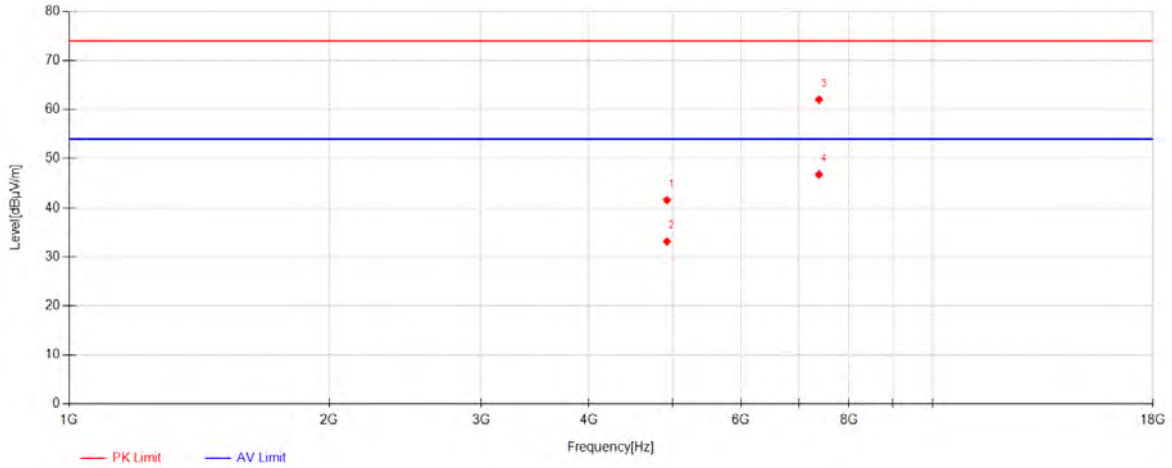
No.1 Workshop, M-10, Middle Section, Science & Technology Park, Nanshan District, Shenzhen, Guangdong, China 518057 t (86-755) 26012053 www.sgsgroup.com.cn  
 中国·广东·深圳市南山区科技园中区M-10栋1号厂房 邮编: 518057 t (86-755) 26012053 sgs.china@sgs.com



**SGS-CSTC Standards Technical Services Co., Ltd.**  
**Shenzhen Branch**

Report No.: SZCR240100035204  
 Page: 90 of 115

**802.11n20\_Channel 11**

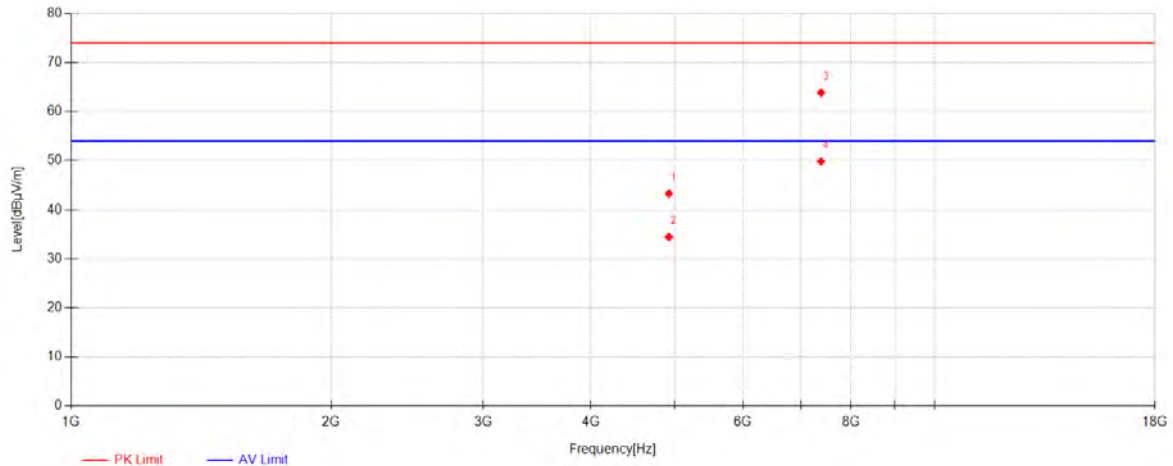


Data List								
NO.	Frequency [MHz]	Reading [dBµV]	AF [dB/m]	Factor [dB]	Level [dBµV/m]	Limit [dBµV/m]	Margin [dB]	Polarity
1	4924.0000	57.35	31.22	-47.04	41.53	74.00	33.47	Horizontal
2	4924.0000	48.94	31.22	-47.04	33.12	54.00	20.88	Horizontal
3	7386.0000	70.88	36.26	-45.13	62.01	74.00	11.99	Horizontal
4	7386.0000	55.62	36.26	-45.13	46.75	54.00	7.25	Horizontal



Unless otherwise agreed in writing, this document is issued by the Company subject to its General Conditions of Service printed overleaf, available on request or accessible at <https://www.sgs.com/en/Terms-and-Conditions>. Attention is drawn to the limitation of liability, indemnification and jurisdiction issues defined therein. Any holder of this document is advised that information contained hereon reflects the Company's findings at the time of its intervention only and within the limits of Client's instructions, if any. The Company's sole responsibility is to its Client and this document does not exonerate parties to a transaction from exercising all their rights and obligations under the transaction documents. This document cannot be reproduced except in full, without prior written approval of the Company. Any unauthorized alteration, forgery or falsification of the content or appearance of this document is unlawful and offenders may be prosecuted to the fullest extent of the law. Unless otherwise stated the results shown in this test report refer only to the sample(s) tested and such sample(s) are retained for 30 days only.  
**Attention: To check the authenticity of testing /inspection report & certificate, please contact us at telephone: (86-755) 8307 1443, or email: CN.Doccheck@sgs.com**

No.1 Workshop, M-10, Middle Section, Science & Technology Park, Nanshan District, Shenzhen, Guangdong, China 518057 t (86-755) 26012053 www.sgsgroup.com.cn  
 中国·广东·深圳市南山区科技园中区M-10栋1号厂房 邮编: 518057 t (86-755) 26012053 sgs.china@sgs.com


**802.11n20\_Channel 11**


Data List								
NO.	Frequency [MHz]	Reading [dBμV]	AF [dB/m]	Factor [dB]	Level [dBμV/m]	Limit [dBμV/m]	Margin [dB]	Polarity
1	4924.0000	59.12	31.22	-47.04	43.30	74.00	30.70	Vertical
2	4924.0000	50.27	31.22	-47.04	34.45	54.00	19.55	Vertical
3	7386.0000	72.73	36.26	-45.13	63.86	74.00	10.14	Vertical
4	7386.0000	58.70	36.26	-45.13	49.83	54.00	4.17	Vertical

**Remark:**

- The field strength is calculated by adding the Antenna Factor, Cable Factor & Preamplifier gain. The basic equation with a sample calculation is as follows:  

$$\text{Level} = \text{Reading}(\text{dB}\mu\text{V}) + \text{AF}(\text{dB}/\text{m}) + \text{Factor}(\text{dB})$$

$$\text{AF} = \text{Antenna Factor}(\text{dB}/\text{m})$$

$$\text{Factor} = \text{Cable Factor}(\text{dB}) - \text{Preamplifier gain}(\text{dB})$$

$$\text{Margin} = \text{Limit}(\text{dB}\mu\text{V}/\text{m}) - \text{Level}(\text{dB}\mu\text{V}/\text{m})$$
- All channels have been tested, but only the worst case data displayed in this report.
- Both peak and average measured complies with the limit line, so test result is "PASS"



Unless otherwise agreed in writing, this document is issued by the Company subject to its General Conditions of Service printed overleaf, available on request or accessible at <https://www.sgs.com/en/Terms-and-Conditions>. Attention is drawn to the limitation of liability, indemnification and jurisdiction issues defined therein. Any holder of this document is advised that information contained hereon reflects the Company's findings at the time of its intervention only and within the limits of Client's instructions, if any. The Company's sole responsibility is to its Client and this document does not exonerate parties to a transaction from exercising all their rights and obligations under the transaction documents. This document cannot be reproduced except in full, without prior written approval of the Company. Any unauthorized alteration, forgery or falsification of the content or appearance of this document is unlawful and offenders may be prosecuted to the fullest extent of the law. Unless otherwise stated the results shown in this test report refer only to the sample(s) tested and such sample(s) are retained for 30 days only.

Attention: To check the authenticity of testing /inspection report & certificate, please contact us at telephone: (86-755) 8307 1443, or email: CN.Doccheck@sgs.com

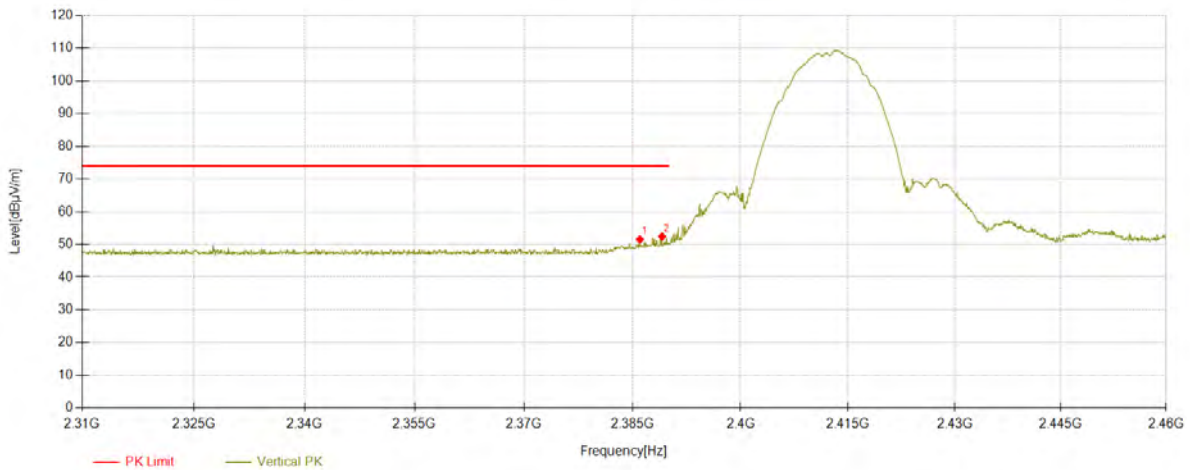
No.1 Workshop, M-10, Middle Section, Science & Technology Park, Nanshan District, Shenzhen, Guangdong, China 518057 t (86-755) 26012053 www.sgs.com.cn  
 中国·广东·深圳市南山区科技园中区M-10栋1号厂房 邮编: 518057 t (86-755) 26012053 sgs.china@sgs.com





## Restricted bands around fundamental frequency

### 802.11b\_Channel 01



Data List								
NO.	Frequency [MHz]	Reading [dBμV]	AF [dB/m]	Factor [dB]	Level [dBμV/m]	Limit [dBμV/m]	Margin [dB]	Polarity
1	2386.013	50.11	27.13	-25.71	51.53	74.00	22.47	Vertical
2	2389.0895	50.97	27.13	-25.70	52.40	74.00	21.60	Vertical

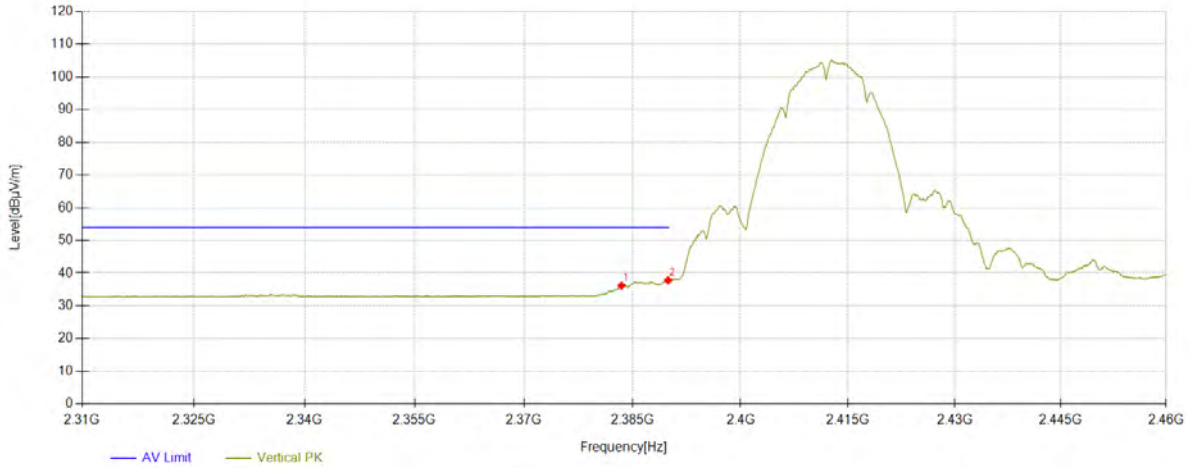




**SGS-CSTC Standards Technical Services Co., Ltd.**  
**Shenzhen Branch**

Report No.: SZCR240100035204  
 Page: 93 of 115

**802.11b\_Channel 01**



Data List								
NO.	Frequency [MHz]	Reading [dBµV]	AF [dB/m]	Factor [dB]	Level [dBµV/m]	Limit [dBµV/m]	Margin [dB]	Polarity
1	2383.4617	34.79	27.12	-25.71	36.20	54.00	17.80	Vertical
2	2389.915	36.39	27.14	-25.70	37.83	54.00	16.17	Vertical

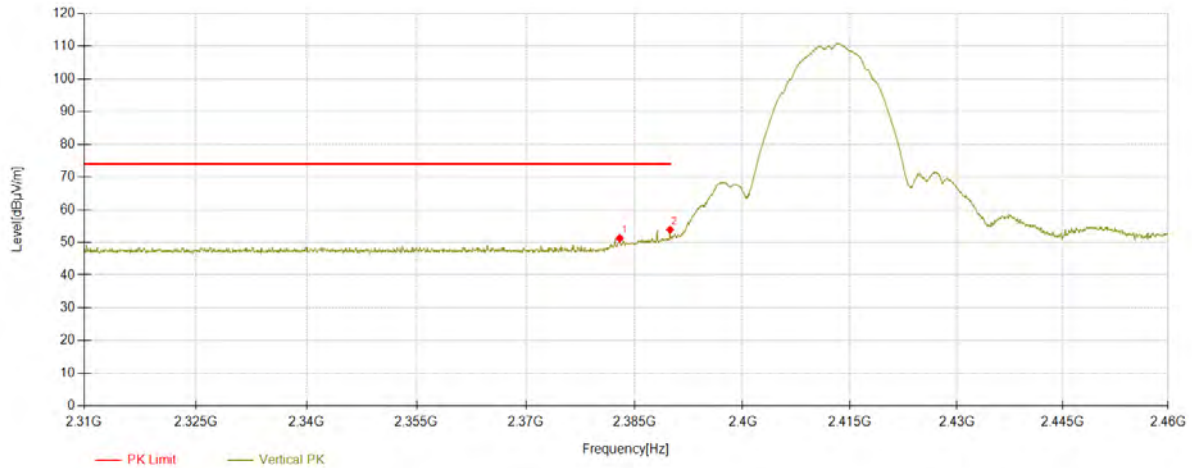


Unless otherwise agreed in writing, this document is issued by the Company subject to its General Conditions of Service printed overleaf, available on request or accessible at <https://www.sgs.com/en/Terms-and-Conditions>. Attention is drawn to the limitation of liability, indemnification and jurisdiction issues defined therein. Any holder of this document is advised that information contained hereon reflects the Company's findings at the time of its intervention only and within the limits of Client's instructions, if any. The Company's sole responsibility is to its Client and this document does not exonerate parties to a transaction from exercising all their rights and obligations under the transaction documents. This document cannot be reproduced except in full, without prior written approval of the Company. Any unauthorized alteration, forgery or falsification of the content or appearance of this document is unlawful and offenders may be prosecuted to the fullest extent of the law. Unless otherwise stated the results shown in this test report refer only to the sample(s) tested and such sample(s) are retained for 30 days only.  
 Attention: To check the authenticity of testing /inspection report & certificate, please contact us at telephone: (86-755) 8307 1443, or email: CN.Doccheck@sgs.com

No.1 Workshop, M-10, Middle Section, Science & Technology Park, Nanshan District, Shenzhen, Guangdong, China 518057 t (86-755) 26012053 www.sgsgroup.com.cn  
 中国·广东·深圳市南山区科技园中区M-10栋1号厂房 邮编: 518057 t (86-755) 26012053 sgs.china@sgs.com

Report No.: SZCR240100035204  
Page: 94 of 115

### 802.11b\_Channel 01



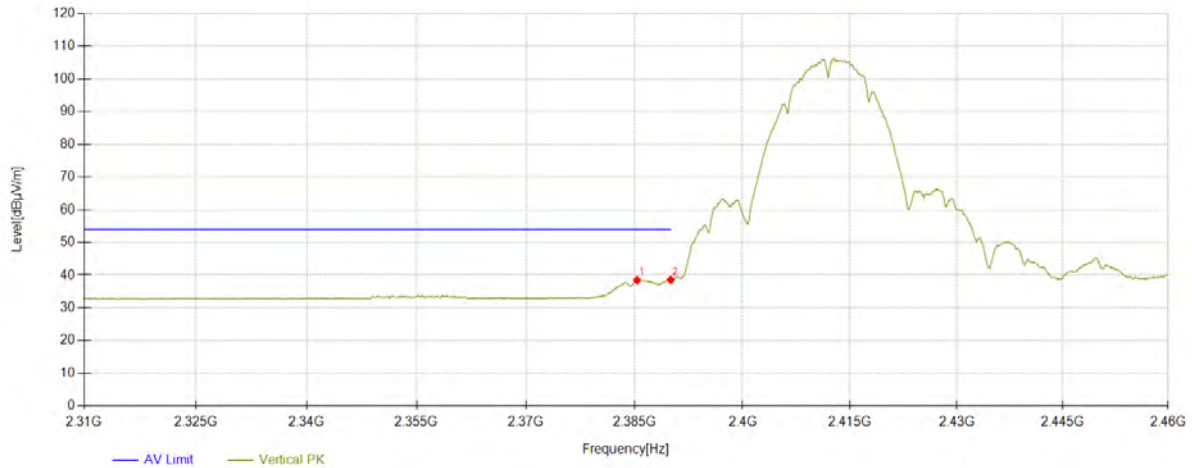
Data List								
NO.	Frequency [MHz]	Reading [dBµV]	AF [dB/m]	Factor [dB]	Level [dBµV/m]	Limit [dBµV/m]	Margin [dB]	Polarity
1	2382.9365	49.90	27.12	-25.72	51.30	74.00	22.70	Vertical
2	2389.915	52.46	27.14	-25.70	53.90	74.00	20.10	Vertical



Unless otherwise agreed in writing, this document is issued by the Company subject to its General Conditions of Service printed overleaf, available on request or accessible at <https://www.sgs.com/en/Terms-and-Conditions>. Attention is drawn to the limitation of liability, indemnification and jurisdiction issues defined therein. Any holder of this document is advised that information contained hereon reflects the Company's findings at the time of its intervention only and within the limits of Client's instructions, if any. The Company's sole responsibility is to its Client and this document does not exonerate parties to a transaction from exercising all their rights and obligations under the transaction documents. This document cannot be reproduced except in full, without prior written approval of the Company. Any unauthorized alteration, forgery or falsification of the content or appearance of this document is unlawful and offenders may be prosecuted to the fullest extent of the law. Unless otherwise stated the results shown in this test report refer only to the sample(s) tested and such sample(s) are retained for 30 days only.

Attention: To check the authenticity of testing /inspection report & certificate, please contact us at telephone: (86-755) 8307 1443, or email: CN.Doccheck@sgs.com

No.1 Workshop, M-10, Middle Section, Science & Technology Park, Nanshan District, Shenzhen, Guangdong, China 518057 t (86-755) 26012053 www.sgs.com.cn  
中国·广东·深圳市南山区科技园中区M-10栋1号厂房 邮编: 518057 t (86-755) 26012053 sgs.china@sgs.com


**802.11b\_Channel 01**


Data List								
NO.	Frequency [MHz]	Reading [dBµV]	AF [dB/m]	Factor [dB]	Level [dBµV/m]	Limit [dBµV/m]	Margin [dB]	Polarity
1	2385.3377	37.05	27.12	-25.71	38.46	54.00	15.54	Vertical
2	2389.99	37.12	27.14	-25.70	38.56	54.00	15.44	Vertical



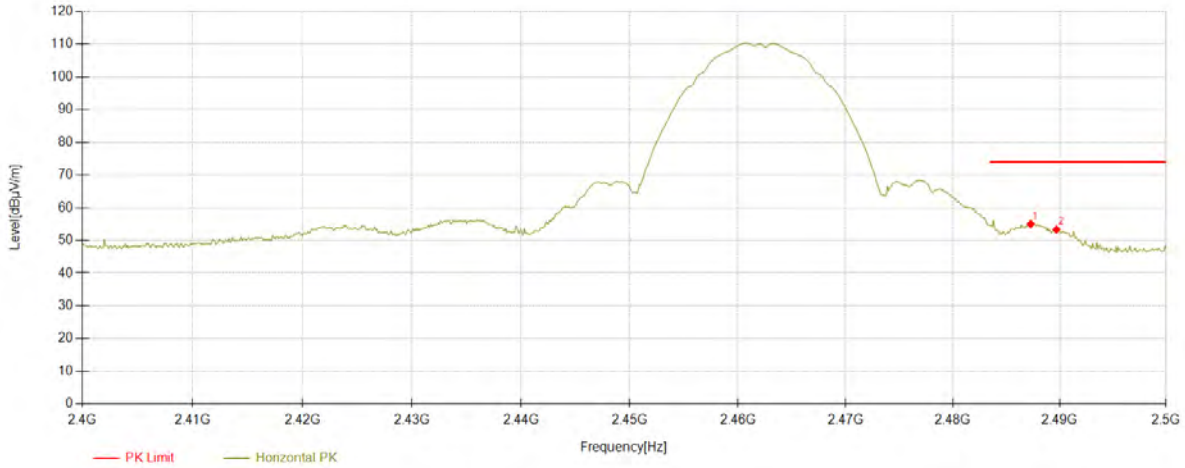




**SGS-CSTC Standards Technical Services Co., Ltd.**  
**Shenzhen Branch**

Report No.: SZCR240100035204  
 Page: 96 of 115

**802.11b\_Channel 11**



Data List								
NO.	Frequency [MHz]	Reading [dBµV]	AF [dB/m]	Factor [dB]	Level [dBµV/m]	Limit [dBµV/m]	Margin [dB]	Polarity
1	2487.3	52.80	27.37	-25.12	55.05	74.00	18.95	Horizontal
2	2489.7	51.06	27.38	-25.11	53.33	74.00	20.67	Horizontal



Unless otherwise agreed in writing, this document is issued by the Company subject to its General Conditions of Service printed overleaf, available on request or accessible at <https://www.sgs.com/en/Terms-and-Conditions>. Attention is drawn to the limitation of liability, indemnification and jurisdiction issues defined therein. Any holder of this document is advised that information contained hereon reflects the Company's findings at the time of its intervention only and within the limits of Client's instructions, if any. The Company's sole responsibility is to its Client and this document does not exonerate parties to a transaction from exercising all their rights and obligations under the transaction documents. This document cannot be reproduced except in full, without prior written approval of the Company. Any unauthorized alteration, forgery or falsification of the content or appearance of this document is unlawful and offenders may be prosecuted to the fullest extent of the law. Unless otherwise stated the results shown in this test report refer only to the sample(s) tested and such sample(s) are retained for 30 days only.  
 Attention: To check the authenticity of testing /inspection report & certificate, please contact us at telephone: (86-755) 8307 1443, or email: CN.Doccheck@sgs.com

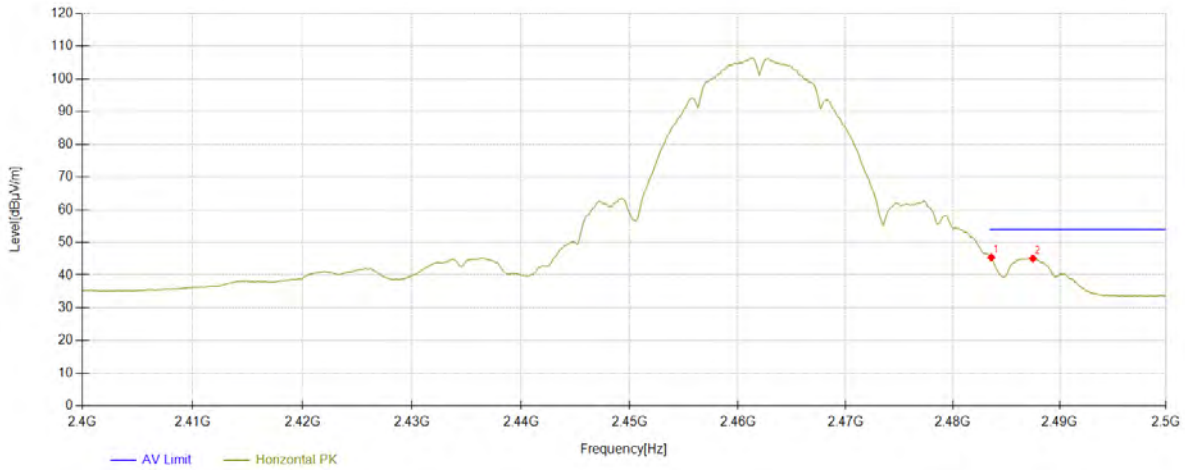
No.1 Workshop, M-10, Middle Section, Science & Technology Park, Nanshan District, Shenzhen, Guangdong, China 518057 t (86-755) 26012053 www.sgs.com.cn  
 中国·广东·深圳市南山区科技园中区M-10栋1号厂房 邮编: 518057 t (86-755) 26012053 sgs.china@sgs.com



# SGS-CSTC Standards Technical Services Co., Ltd. Shenzhen Branch

Report No.: SZCR240100035204  
Page: 97 of 115

## 802.11b\_Channel 11



Data List								
NO.	Frequency [MHz]	Reading [dBµV]	AF [dB/m]	Factor [dB]	Level [dBµV/m]	Limit [dBµV/m]	Margin [dB]	Polarity
1	2483.6	43.19	27.36	-25.14	45.41	54.00	8.59	Horizontal
2	2487.5	42.85	27.37	-25.12	45.10	54.00	8.90	Horizontal



SGS-CSTC Standards Technical Services Co., Ltd.  
Shenzhen Branch

Unless otherwise agreed in writing, this document is issued by the Company subject to its General Conditions of Service printed overleaf, available on request or accessible at <https://www.sgs.com/en/Terms-and-Conditions>. Attention is drawn to the limitation of liability, indemnification and jurisdiction issues defined therein. Any holder of this document is advised that information contained hereon reflects the Company's findings at the time of its intervention only and within the limits of Client's instructions, if any. The Company's sole responsibility is to its Client and this document does not exonerate parties to a transaction from exercising all their rights and obligations under the transaction documents. This document cannot be reproduced except in full, without prior written approval of the Company. Any unauthorized alteration, forgery or falsification of the content or appearance of this document is unlawful and offenders may be prosecuted to the fullest extent of the law. Unless otherwise stated the results shown in this test report refer only to the sample(s) tested and such sample(s) are retained for 30 days only.  
Attention: To check the authenticity of testing /inspection report & certificate, please contact us at telephone: (86-755) 8307 1443, or email: CN.Doccheck@sgs.com

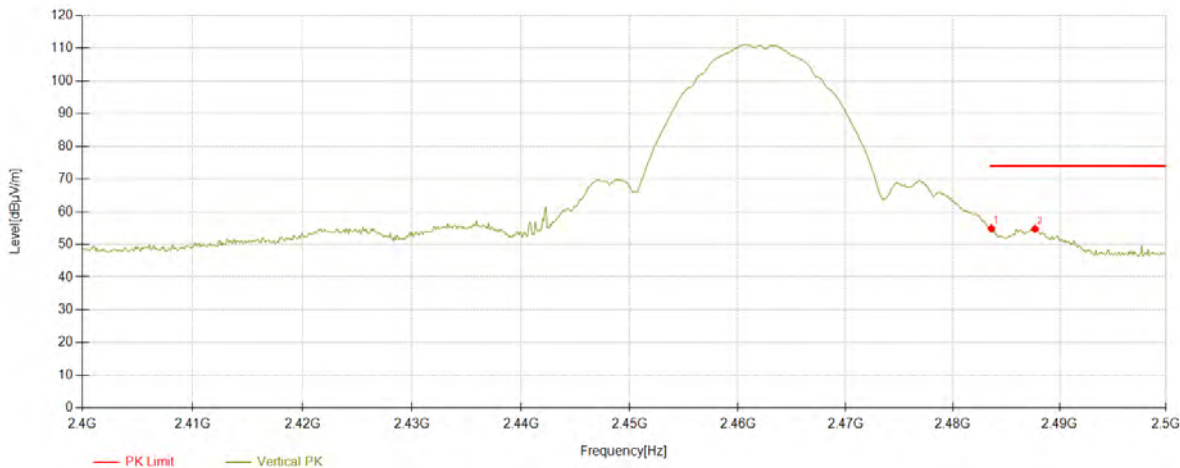
No.1 Workshop, M-10, Middle Section, Science & Technology Park, Nanshan District, Shenzhen, Guangdong, China 518057 t (86-755) 26012053 www.sgs.com.cn  
中国·广东·深圳市南山区科技园中区M-10栋1号厂房 邮编: 518057 t (86-755) 26012053 sgs.china@sgs.com



**SGS-CSTC Standards Technical Services Co., Ltd.**  
**Shenzhen Branch**

Report No.: SZCR240100035204  
 Page: 98 of 115

**802.11b\_Channel 11**



Data List								
NO.	Frequency [MHz]	Reading [dBµV]	AF [dB/m]	Factor [dB]	Level [dBµV/m]	Limit [dBµV/m]	Margin [dB]	Polarity
1	2483.6	52.69	27.36	-25.14	54.91	74.00	19.09	Vertical
2	2487.7	52.51	27.37	-25.12	54.76	74.00	19.24	Vertical



Unless otherwise agreed in writing, this document is issued by the Company subject to its General Conditions of Service printed overleaf, available on request or accessible at <https://www.sgs.com/en/Terms-and-Conditions>. Attention is drawn to the limitation of liability, indemnification and jurisdiction issues defined therein. Any holder of this document is advised that information contained hereon reflects the Company's findings at the time of its intervention only and within the limits of Client's instructions, if any. The Company's sole responsibility is to its Client and this document does not exonerate parties to a transaction from exercising all their rights and obligations under the transaction documents. This document cannot be reproduced except in full, without prior written approval of the Company. Any unauthorized alteration, forgery or falsification of the content or appearance of this document is unlawful and offenders may be prosecuted to the fullest extent of the law. Unless otherwise stated the results shown in this test report refer only to the sample(s) tested and such sample(s) are retained for 30 days only.  
 Attention: To check the authenticity of testing /inspection report & certificate, please contact us at telephone: (86-755) 8307 1443, or email: CN.Doccheck@sgs.com

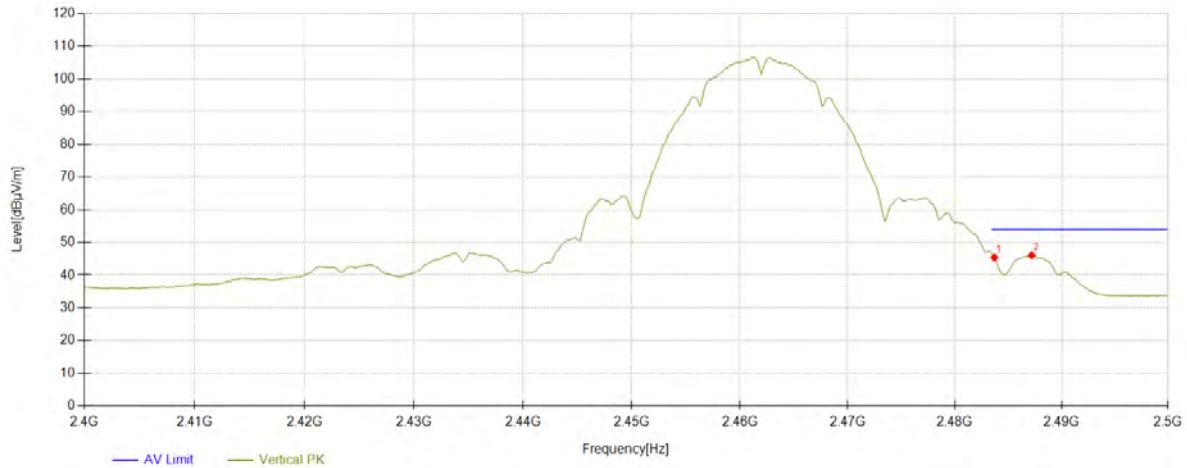
No.1 Workshop, M-10, Middle Section, Science & Technology Park, Nanshan District, Shenzhen, Guangdong, China 518057 t (86-755) 26012053 www.sgs.com.cn  
 中国·广东·深圳市南山区科技园中区M-10栋1号厂房 邮编: 518057 t (86-755) 26012053 sgs.china@sgs.com



# SGS-CSTC Standards Technical Services Co., Ltd. Shenzhen Branch

Report No.: SZCR240100035204  
Page: 99 of 115

## 802.11b\_Channel 11



Data List								
NO.	Frequency [MHz]	Reading [dBµV]	AF [dB/m]	Factor [dB]	Level [dBµV/m]	Limit [dBµV/m]	Margin [dB]	Polarity
1	2483.7	43.18	27.36	-25.14	45.40	54.00	8.60	Vertical
2	2487.2	43.83	27.37	-25.12	46.08	54.00	7.92	Vertical



SGS-CSTC Standards Technical Services Co., Ltd.  
Shenzhen Branch

Unless otherwise agreed in writing, this document is issued by the Company subject to its General Conditions of Service printed overleaf, available on request or accessible at <https://www.sgs.com/en/Terms-and-Conditions>. Attention is drawn to the limitation of liability, indemnification and jurisdiction issues defined therein. Any holder of this document is advised that information contained hereon reflects the Company's findings at the time of its intervention only and within the limits of Client's instructions, if any. The Company's sole responsibility is to its Client and this document does not exonerate parties to a transaction from exercising all their rights and obligations under the transaction documents. This document cannot be reproduced except in full, without prior written approval of the Company. Any unauthorized alteration, forgery or falsification of the content or appearance of this document is unlawful and offenders may be prosecuted to the fullest extent of the law. Unless otherwise stated the results shown in this test report refer only to the sample(s) tested and such sample(s) are retained for 30 days only.  
Attention: To check the authenticity of testing /inspection report & certificate, please contact us at telephone: (86-755) 8307 1443, or email: CN.Doccheck@sgs.com

No.1 Workshop, M-10, Middle Section, Science & Technology Park, Nanshan District, Shenzhen, Guangdong, China 518057 t (86-755) 26012053 www.sgs.com.cn  
中国·广东·深圳市南山区科技园中区M-10栋1号厂房 邮编: 518057 t (86-755) 26012053 sgs.china@sgs.com

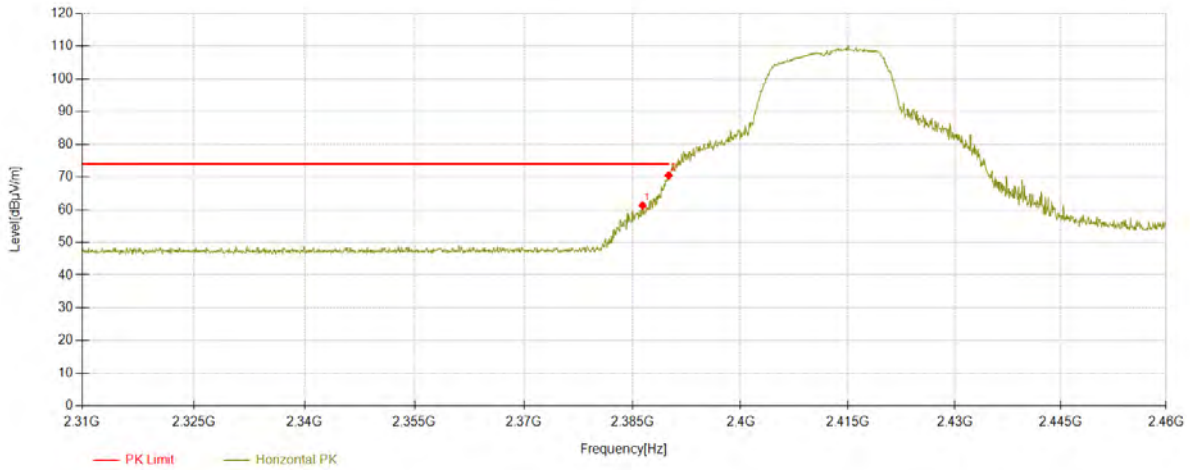




# SGS-CSTC Standards Technical Services Co., Ltd. Shenzhen Branch

Report No.: SZCR240100035204  
Page: 100 of 115

## 802.11g\_Channel 01



Data List								
NO.	Frequency [MHz]	Reading [dBµV]	AF [dB/m]	Factor [dB]	Level [dBµV/m]	Limit [dBµV/m]	Margin [dB]	Polarity
1	2386.3882	59.87	27.13	-25.71	61.29	74.00	12.71	Horizontal
2	2389.99	68.99	27.14	-25.70	70.43	74.00	3.57	Horizontal



SGS-CSTC Standards Technical Services Co., Ltd.  
Shenzhen Branch, Inspection & Testing Services

Unless otherwise agreed in writing, this document is issued by the Company subject to its General Conditions of Service printed overleaf, available on request or accessible at <https://www.sgs.com/en/Terms-and-Conditions>. Attention is drawn to the limitation of liability, indemnification and jurisdiction issues defined therein. Any holder of this document is advised that information contained hereon reflects the Company's findings at the time of its intervention only and within the limits of Client's instructions, if any. The Company's sole responsibility is to its Client and this document does not exonerate parties to a transaction from exercising all their rights and obligations under the transaction documents. This document cannot be reproduced except in full, without prior written approval of the Company. Any unauthorized alteration, forgery or falsification of the content or appearance of this document is unlawful and offenders may be prosecuted to the fullest extent of the law. Unless otherwise stated the results shown in this test report refer only to the sample(s) tested and such sample(s) are retained for 30 days only.

Attention: To check the authenticity of testing /inspection report & certificate, please contact us at telephone: (86-755) 8307 1443, or email: CN.Doccheck@sgs.com

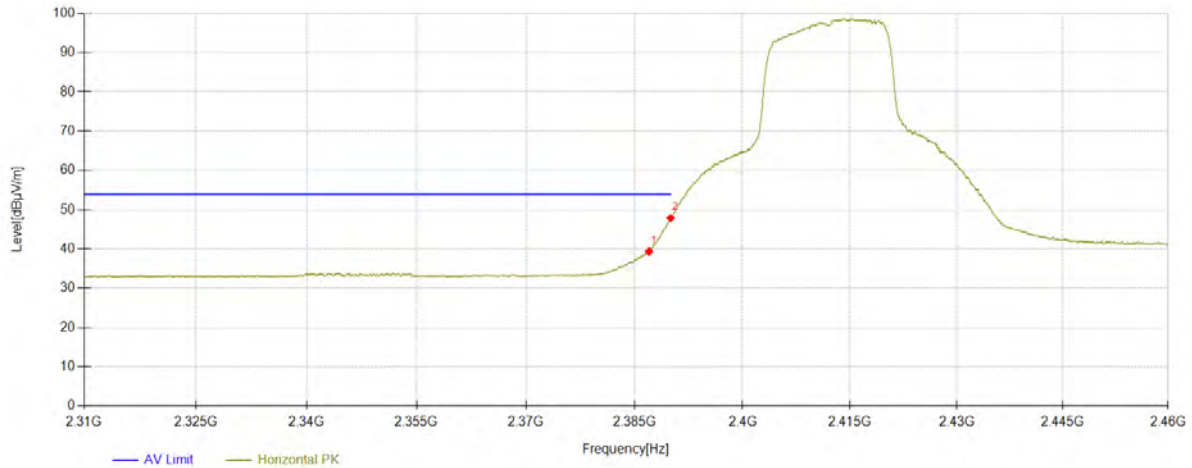
No.1 Workshop, M-10, Middle Section, Science & Technology Park, Nanshan District, Shenzhen, Guangdong, China 518057 t (86-755) 26012053 www.sgsgroup.com.cn  
中国·广东·深圳市南山区科技园中区M-10栋1号厂房 邮编: 518057 t (86-755) 26012053 sgs.china@sgs.com



# SGS-CSTC Standards Technical Services Co., Ltd. Shenzhen Branch

Report No.: SZCR240100035204  
Page: 101 of 115

## 802.11g\_Channel 01



Data List								
NO.	Frequency [MHz]	Reading [dBµV]	AF [dB/m]	Factor [dB]	Level [dBµV/m]	Limit [dBµV/m]	Margin [dB]	Polarity
1	2386.9885	37.93	27.13	-25.71	39.35	54.00	14.65	Horizontal
2	2389.99	46.43	27.14	-25.70	47.87	54.00	6.13	Horizontal



Unless otherwise agreed in writing, this document is issued by the Company subject to its General Conditions of Service printed overleaf, available on request or accessible at <https://www.sgs.com/en/Terms-and-Conditions>. Attention is drawn to the limitation of liability, indemnification and jurisdiction issues defined therein. Any holder of this document is advised that information contained hereon reflects the Company's findings at the time of its intervention only and within the limits of Client's instructions, if any. The Company's sole responsibility is to its Client and this document does not exonerate parties to a transaction from exercising all their rights and obligations under the transaction documents. This document cannot be reproduced except in full, without prior written approval of the Company. Any unauthorized alteration, forgery or falsification of the content or appearance of this document is unlawful and offenders may be prosecuted to the fullest extent of the law. Unless otherwise stated the results shown in this test report refer only to the sample(s) tested and such sample(s) are retained for 30 days only.  
Attention: To check the authenticity of testing /inspection report & certificate, please contact us at telephone: (86-755) 8307 1443, or email: CN.Doccheck@sgs.com

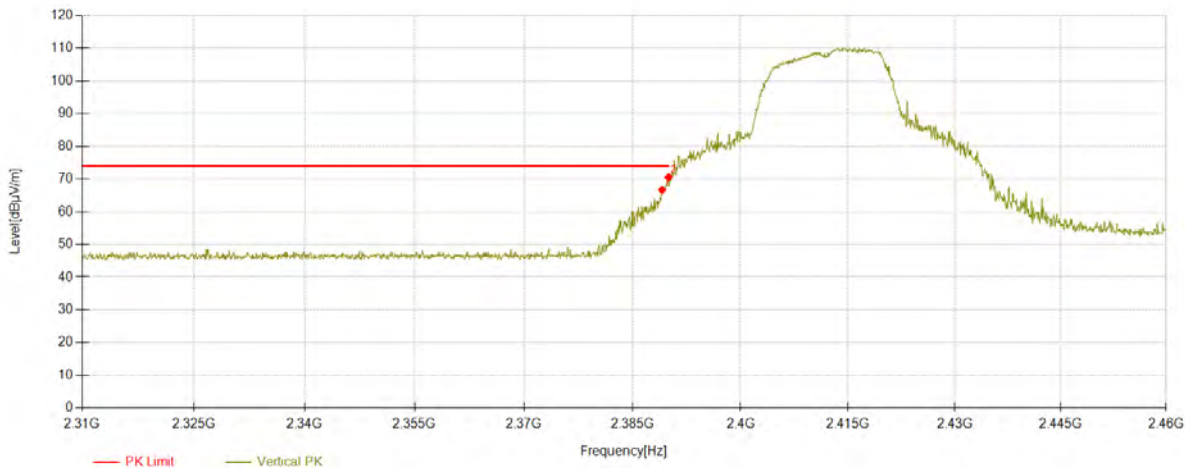
No.1 Workshop, M-10, Middle Section, Science & Technology Park, Nanshan District, Shenzhen, Guangdong, China 518057 t (86-755) 26012053 www.sgsgroup.com.cn  
中国·广东·深圳市南山区科技园中区M-10栋1号厂房 邮编: 518057 t (86-755) 26012053 sgs.china@sgs.com



**SGS-CSTC Standards Technical Services Co., Ltd.**  
**Shenzhen Branch**

Report No.: SZCR240100035204  
 Page: 102 of 115

**802.11g\_Channel 01**



Data List								
NO.	Frequency [MHz]	Reading [dBµV]	AF [dB/m]	Factor [dB]	Level [dBµV/m]	Limit [dBµV/m]	Margin [dB]	Polarity
1	2389.0895	65.18	27.13	-25.70	66.61	74.00	7.39	Vertical
2	2389.99	69.09	27.14	-25.70	70.53	74.00	3.47	Vertical



Unless otherwise agreed in writing, this document is issued by the Company subject to its General Conditions of Service printed overleaf, available on request or accessible at <https://www.sgs.com/en/Terms-and-Conditions>. Attention is drawn to the limitation of liability, indemnification and jurisdiction issues defined therein. Any holder of this document is advised that information contained hereon reflects the Company's findings at the time of its intervention only and within the limits of Client's instructions, if any. The Company's sole responsibility is to its Client and this document does not exonerate parties to a transaction from exercising all their rights and obligations under the transaction documents. This document cannot be reproduced except in full, without prior written approval of the Company. Any unauthorized alteration, forgery or falsification of the content or appearance of this document is unlawful and offenders may be prosecuted to the fullest extent of the law. Unless otherwise stated the results shown in this test report refer only to the sample(s) tested and such sample(s) are retained for 30 days only.  
 Attention: To check the authenticity of testing /inspection report & certificate, please contact us at telephone: (86-755) 8307 1443, or email: CN.Doccheck@sgs.com

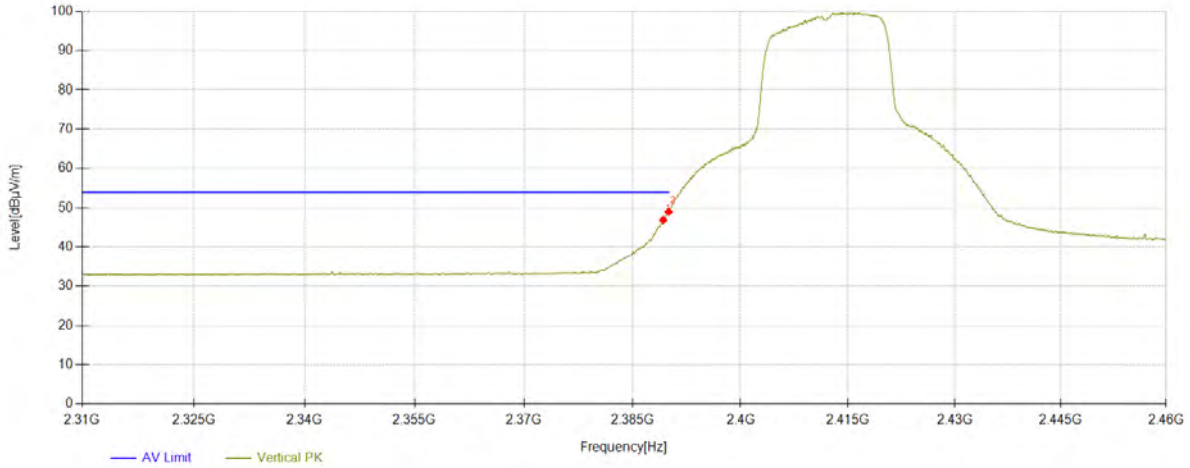
No.1 Workshop, M-10, Middle Section, Science & Technology Park, Nanshan District, Shenzhen, Guangdong, China 518057 t (86-755) 26012053 www.sgs.com.cn  
 中国·广东·深圳市南山区科技园中区M-10栋1号厂房 邮编: 518057 t (86-755) 26012053 sgs.china@sgs.com



**SGS-CSTC Standards Technical Services Co., Ltd.**  
**Shenzhen Branch**

Report No.: SZCR240100035204  
 Page: 103 of 115

**802.11g\_Channel 01**



Data List								
NO.	Frequency [MHz]	Reading [dBµV]	AF [dB/m]	Factor [dB]	Level [dBµV/m]	Limit [dBµV/m]	Margin [dB]	Polarity
1	2389.2396	45.45	27.13	-25.70	46.88	54.00	7.12	Vertical
2	2389.99	47.53	27.14	-25.70	48.97	54.00	5.03	Vertical



Unless otherwise agreed in writing, this document is issued by the Company subject to its General Conditions of Service printed overleaf, available on request or accessible at <https://www.sgs.com/en/Terms-and-Conditions>. Attention is drawn to the limitation of liability, indemnification and jurisdiction issues defined therein. Any holder of this document is advised that information contained hereon reflects the Company's findings at the time of its intervention only and within the limits of Client's instructions, if any. The Company's sole responsibility is to its Client and this document does not exonerate parties to a transaction from exercising all their rights and obligations under the transaction documents. This document cannot be reproduced except in full, without prior written approval of the Company. Any unauthorized alteration, forgery or falsification of the content or appearance of this document is unlawful and offenders may be prosecuted to the fullest extent of the law. Unless otherwise stated the results shown in this test report refer only to the sample(s) tested and such sample(s) are retained for 30 days only.  
**Attention: To check the authenticity of testing /inspection report & certificate, please contact us at telephone: (86-755) 8307 1443, or email: CN.Doccheck@sgs.com**

No.1 Workshop, M-10, Middle Section, Science & Technology Park, Nanshan District, Shenzhen, Guangdong, China 518057 t (86-755) 26012053 www.sgs.com.cn  
 中国·广东·深圳市南山区科技园中区M-10栋1号厂房 邮编: 518057 t (86-755) 26012053 sgs.china@sgs.com

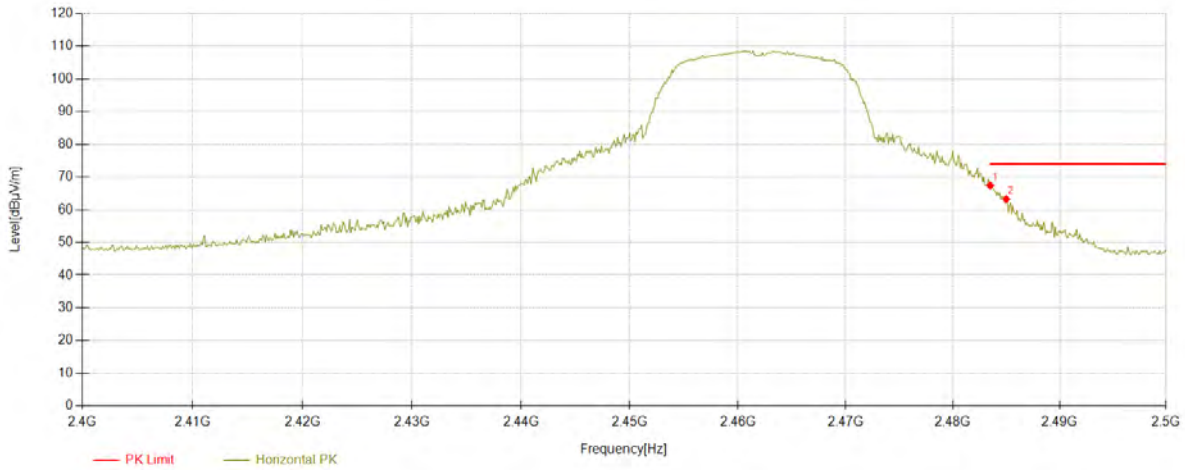




# SGS-CSTC Standards Technical Services Co., Ltd. Shenzhen Branch

Report No.: SZCR240100035204  
Page: 104 of 115

## 802.11g\_Channel 11



Data List								
NO.	Frequency [MHz]	Reading [dBµV]	AF [dB/m]	Factor [dB]	Level [dBµV/m]	Limit [dBµV/m]	Margin [dB]	Polarity
1	2483.5	65.20	27.36	-25.15	67.41	74.00	6.59	Horizontal
2	2485	61.02	27.36	-25.14	63.24	74.00	10.76	Horizontal



Unless otherwise agreed in writing, this document is issued by the Company subject to its General Conditions of Service printed overleaf, available on request or accessible at <https://www.sgs.com/en/Terms-and-Conditions>. Attention is drawn to the limitation of liability, indemnification and jurisdiction issues defined therein. Any holder of this document is advised that information contained hereon reflects the Company's findings at the time of its intervention only and within the limits of Client's instructions, if any. The Company's sole responsibility is to its Client and this document does not exonerate parties to a transaction from exercising all their rights and obligations under the transaction documents. This document cannot be reproduced except in full, without prior written approval of the Company. Any unauthorized alteration, forgery or falsification of the content or appearance of this document is unlawful and offenders may be prosecuted to the fullest extent of the law. Unless otherwise stated the results shown in this test report refer only to the sample(s) tested and such sample(s) are retained for 30 days only.  
Attention: To check the authenticity of testing /inspection report & certificate, please contact us at telephone: (86-755) 8307 1443, or email: CN.Doccheck@sgs.com

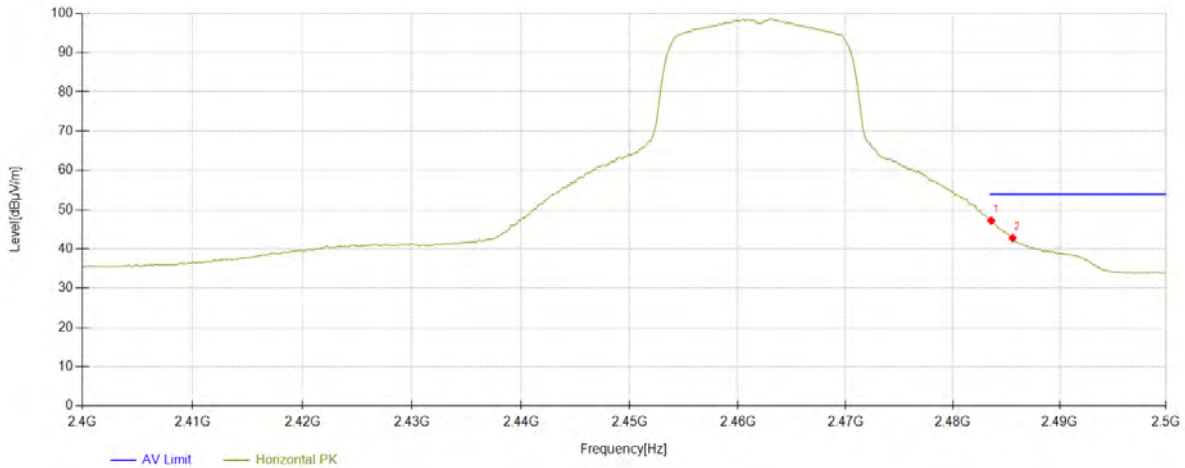
No.1 Workshop, M-10, Middle Section, Science & Technology Park, Nanshan District, Shenzhen, Guangdong, China 518057 t (86-755) 26012053 www.sgs.com.cn  
中国·广东·深圳市南山区科技园中区M-10栋1号厂房 邮编: 518057 t (86-755) 26012053 sgs.china@sgs.com



# SGS-CSTC Standards Technical Services Co., Ltd. Shenzhen Branch

Report No.: SZCR240100035204  
Page: 105 of 115

## 802.11g\_Channel 11



Data List								
NO.	Frequency [MHz]	Reading [dBµV]	AF [dB/m]	Factor [dB]	Level [dBµV/m]	Limit [dBµV/m]	Margin [dB]	Polarity
1	2483.6	45.00	27.36	-25.14	47.22	54.00	6.78	Horizontal
2	2485.6	40.55	27.37	-25.13	42.79	54.00	11.21	Horizontal



Unless otherwise agreed in writing, this document is issued by the Company subject to its General Conditions of Service printed overleaf, available on request or accessible at <https://www.sgs.com/en/Terms-and-Conditions>. Attention is drawn to the limitation of liability, indemnification and jurisdiction issues defined therein. Any holder of this document is advised that information contained hereon reflects the Company's findings at the time of its intervention only and within the limits of Client's instructions, if any. The Company's sole responsibility is to its Client and this document does not exonerate parties to a transaction from exercising all their rights and obligations under the transaction documents. This document cannot be reproduced except in full, without prior written approval of the Company. Any unauthorized alteration, forgery or falsification of the content or appearance of this document is unlawful and offenders may be prosecuted to the fullest extent of the law. Unless otherwise stated the results shown in this test report refer only to the sample(s) tested and such sample(s) are retained for 30 days only.

Attention: To check the authenticity of testing /inspection report & certificate, please contact us at telephone: (86-755) 8307 1443, or email: CN.Doccheck@sgs.com

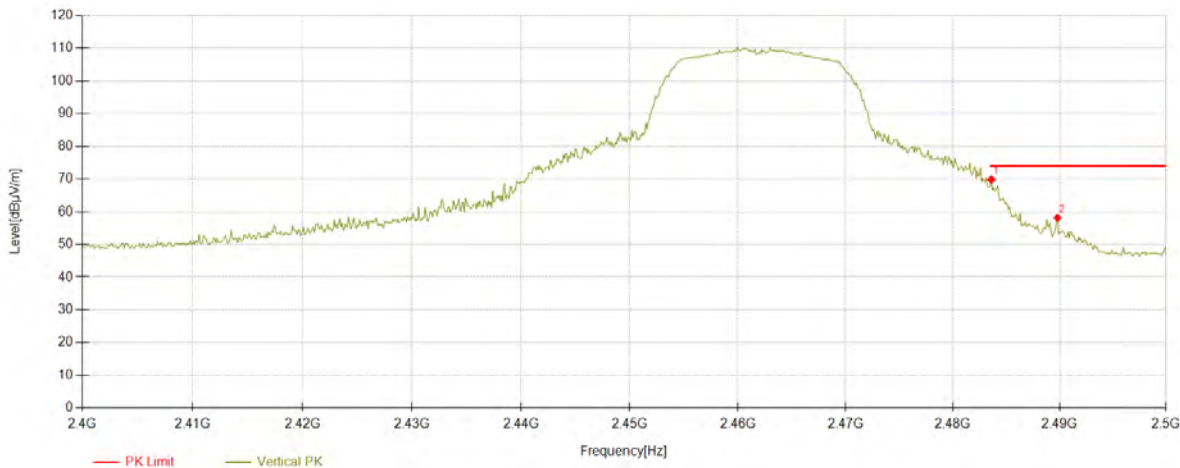
No.1 Workshop, M-10, Middle Section, Science & Technology Park, Nanshan District, Shenzhen, Guangdong, China 518057 t (86-755) 26012053 www.sgs.com.cn  
中国·广东·深圳市南山区科技园中区M-10栋1号厂房 邮编: 518057 t (86-755) 26012053 sgs.china@sgs.com



**SGS-CSTC Standards Technical Services Co., Ltd.**  
**Shenzhen Branch**

Report No.: SZCR240100035204  
 Page: 106 of 115

**802.11g\_Channel 11**



Data List								
NO.	Frequency [MHz]	Reading [dBµV]	AF [dB/m]	Factor [dB]	Level [dBµV/m]	Limit [dBµV/m]	Margin [dB]	Polarity
1	2483.6	67.62	27.36	-25.14	69.84	74.00	4.16	Vertical
2	2489.8	55.88	27.38	-25.11	58.15	74.00	15.85	Vertical



Unless otherwise agreed in writing, this document is issued by the Company subject to its General Conditions of Service printed overleaf, available on request or accessible at <https://www.sgs.com/en/Terms-and-Conditions>. Attention is drawn to the limitation of liability, indemnification and jurisdiction issues defined therein. Any holder of this document is advised that information contained hereon reflects the Company's findings at the time of its intervention only and within the limits of Client's instructions, if any. The Company's sole responsibility is to its Client and this document does not exonerate parties to a transaction from exercising all their rights and obligations under the transaction documents. This document cannot be reproduced except in full, without prior written approval of the Company. Any unauthorized alteration, forgery or falsification of the content or appearance of this document is unlawful and offenders may be prosecuted to the fullest extent of the law. Unless otherwise stated the results shown in this test report refer only to the sample(s) tested and such sample(s) are retained for 30 days only.

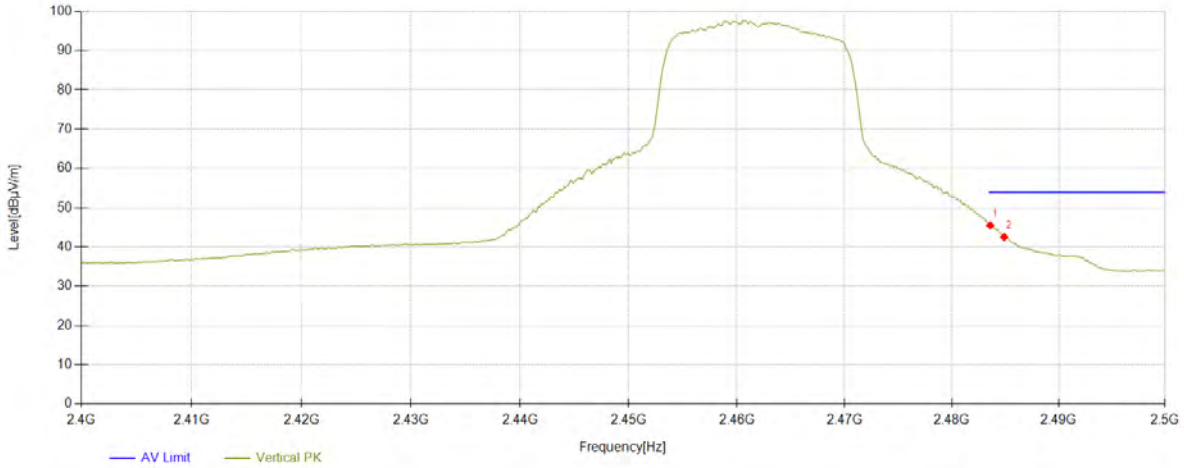
Attention: To check the authenticity of testing /inspection report & certificate, please contact us at telephone: (86-755) 8307 1443, or email: CN.Doccheck@sgs.com  
 No.1 Workshop, M-10, Middle Section, Science & Technology Park, Nanshan District, Shenzhen, Guangdong, China 518057 t (86-755) 26012053 www.sgs.com.cn  
 中国·广东·深圳市南山区科技园中区M-10栋1号厂房 邮编: 518057 t (86-755) 26012053 sgs.china@sgs.com



**SGS-CSTC Standards Technical Services Co., Ltd.**  
**Shenzhen Branch**

Report No.: SZCR240100035204  
 Page: 107 of 115

**802.11g\_Channel 11**



Data List								
NO.	Frequency [MHz]	Reading [dBµV]	AF [dB/m]	Factor [dB]	Level [dBµV/m]	Limit [dBµV/m]	Margin [dB]	Polarity
1	2483.6	43.29	27.36	-25.14	45.51	54.00	8.49	Vertical
2	2484.9	40.33	27.36	-25.14	42.55	54.00	11.45	Vertical



Unless otherwise agreed in writing, this document is issued by the Company subject to its General Conditions of Service printed overleaf, available on request or accessible at <https://www.sgs.com/en/Terms-and-Conditions>. Attention is drawn to the limitation of liability, indemnification and jurisdiction issues defined therein. Any holder of this document is advised that information contained hereon reflects the Company's findings at the time of its intervention only and within the limits of Client's instructions, if any. The Company's sole responsibility is to its Client and this document does not exonerate parties to a transaction from exercising all their rights and obligations under the transaction documents. This document cannot be reproduced except in full, without prior written approval of the Company. Any unauthorized alteration, forgery or falsification of the content or appearance of this document is unlawful and offenders may be prosecuted to the fullest extent of the law. Unless otherwise stated the results shown in this test report refer only to the sample(s) tested and such sample(s) are retained for 30 days only.

Attention: To check the authenticity of testing /inspection report & certificate, please contact us at telephone: (86-755) 8307 1443, or email: CN.Doccheck@sgs.com  
 No.1 Workshop, M-10, Middle Section, Science & Technology Park, Nanshan District, Shenzhen, Guangdong, China 518057 t (86-755) 26012053 www.sgs.com.cn  
 中国·广东·深圳市南山区科技园中区M-10栋1号厂房 邮编: 518057 t (86-755) 26012053 sgs.china@sgs.com

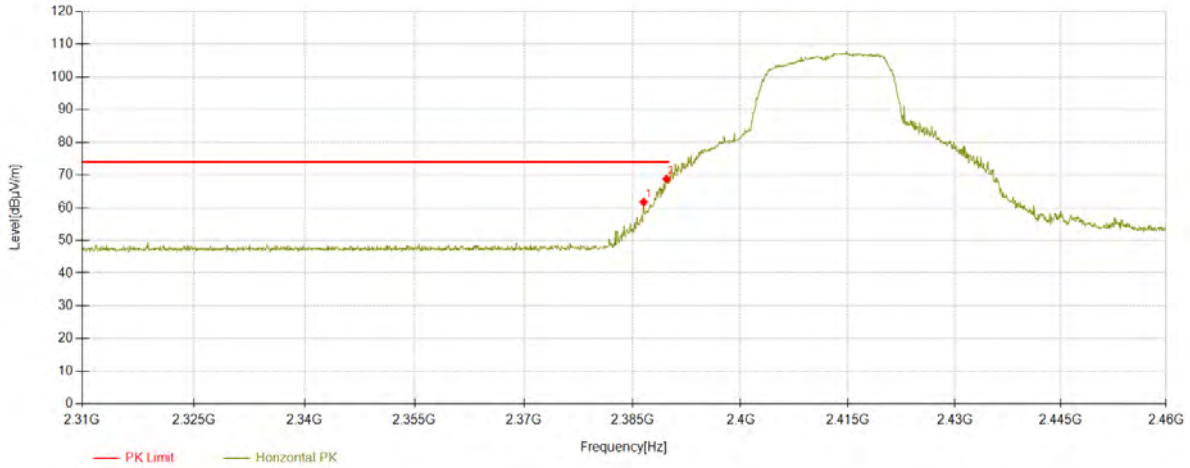




**SGS-CSTC Standards Technical Services Co., Ltd.**  
**Shenzhen Branch**

Report No.: SZCR240100035204  
 Page: 108 of 115

**802.11n20\_Channel 01**



Data List								
NO.	Frequency [MHz]	Reading [dBµV]	AF [dB/m]	Factor [dB]	Level [dBµV/m]	Limit [dBµV/m]	Margin [dB]	Polarity
1	2386.5383	60.25	27.13	-25.71	61.67	74.00	12.33	Horizontal
2	2389.6898	67.33	27.14	-25.70	68.77	74.00	5.23	Horizontal



Unless otherwise agreed in writing, this document is issued by the Company subject to its General Conditions of Service printed overleaf, available on request or accessible at <https://www.sgs.com/en/Terms-and-Conditions>. Attention is drawn to the limitation of liability, indemnification and jurisdiction issues defined therein. Any holder of this document is advised that information contained hereon reflects the Company's findings at the time of its intervention only and within the limits of Client's instructions, if any. The Company's sole responsibility is to its Client and this document does not exonerate parties to a transaction from exercising all their rights and obligations under the transaction documents. This document cannot be reproduced except in full, without prior written approval of the Company. Any unauthorized alteration, forgery or falsification of the content or appearance of this document is unlawful and offenders may be prosecuted to the fullest extent of the law. Unless otherwise stated the results shown in this test report refer only to the sample(s) tested and such sample(s) are retained for 30 days only.

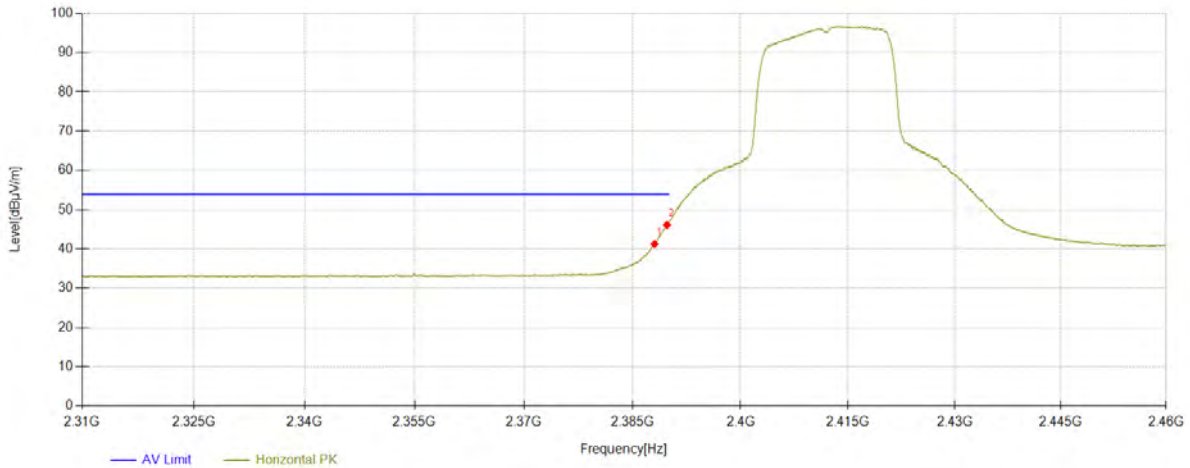
Attention: To check the authenticity of testing /inspection report & certificate, please contact us at telephone: (86-755) 8307 1443, or email: CN.Doccheck@sgs.com  
 No.1 Workshop, M-10, Middle Section, Science & Technology Park, Nanshan District, Shenzhen, Guangdong, China 518057 t (86-755) 26012053 www.sgsgroup.com.cn  
 中国·广东·深圳市南山区科技园中区M-10栋1号厂房 邮编: 518057 t (86-755) 26012053 sgs.china@sgs.com



# SGS-CSTC Standards Technical Services Co., Ltd. Shenzhen Branch

Report No.: SZCR240100035204  
Page: 109 of 115

## 802.11n20\_Channel 01



Data List								
NO.	Frequency [MHz]	Reading [dBµV]	AF [dB/m]	Factor [dB]	Level [dBµV/m]	Limit [dBµV/m]	Margin [dB]	Polarity
1	2388.039	39.86	27.13	-25.71	41.28	54.00	12.72	Horizontal
2	2389.7649	44.72	27.14	-25.70	46.16	54.00	7.84	Horizontal



SGS-CSTC Standards Technical Services Co., Ltd.  
Shenzhen Branch, Wireless Laboratory

Unless otherwise agreed in writing, this document is issued by the Company subject to its General Conditions of Service printed overleaf, available on request or accessible at <https://www.sgs.com/en/Terms-and-Conditions>. Attention is drawn to the limitation of liability, indemnification and jurisdiction issues defined therein. Any holder of this document is advised that information contained hereon reflects the Company's findings at the time of its intervention only and within the limits of Client's instructions, if any. The Company's sole responsibility is to its Client and this document does not exonerate parties to a transaction from exercising all their rights and obligations under the transaction documents. This document cannot be reproduced except in full, without prior written approval of the Company. Any unauthorized alteration, forgery or falsification of the content or appearance of this document is unlawful and offenders may be prosecuted to the fullest extent of the law. Unless otherwise stated the results shown in this test report refer only to the sample(s) tested and such sample(s) are retained for 30 days only.  
Attention: To check the authenticity of testing /inspection report & certificate, please contact us at telephone: (86-755) 8307 1443, or email: CN.Doccheck@sgs.com

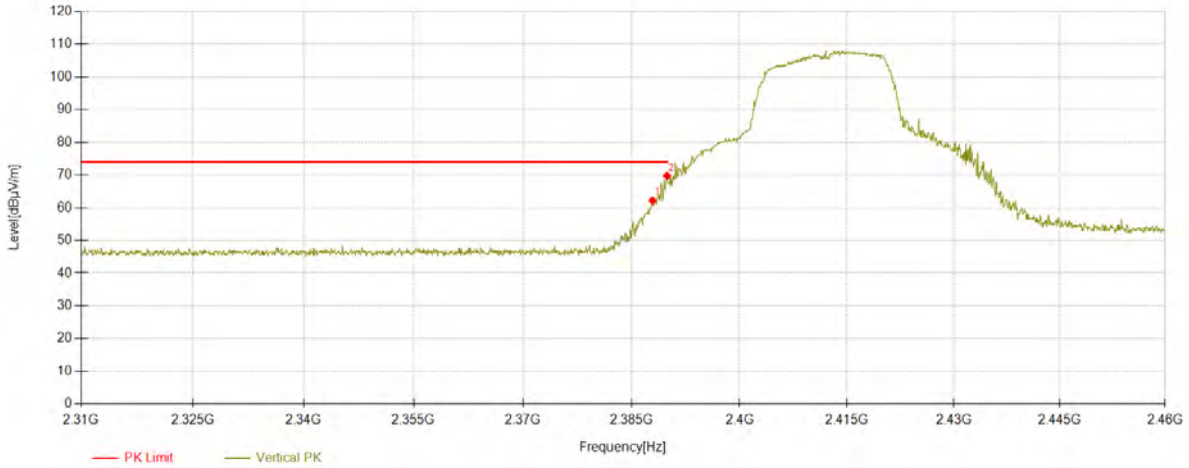
No.1 Workshop, M-10, Middle Section, Science & Technology Park, Nanshan District, Shenzhen, Guangdong, China 518057 t (86-755) 26012053 www.sgsgroup.com.cn  
中国·广东·深圳市南山区科技园中区M-10栋1号厂房 邮编: 518057 t (86-755) 26012053 sgs.china@sgs.com



**SGS-CSTC Standards Technical Services Co., Ltd.**  
**Shenzhen Branch**

Report No.: SZCR240100035204  
 Page: 110 of 115

**802.11n20\_Channel 01**



Data List								
NO.	Frequency [MHz]	Reading [dBµV]	AF [dB/m]	Factor [dB]	Level [dBµV/m]	Limit [dBµV/m]	Margin [dB]	Polarity
1	2387.8889	60.76	27.13	-25.71	62.18	74.00	11.82	Vertical
2	2389.915	68.28	27.14	-25.70	69.72	74.00	4.28	Vertical



Unless otherwise agreed in writing, this document is issued by the Company subject to its General Conditions of Service printed overleaf, available on request or accessible at <https://www.sgs.com/en/Terms-and-Conditions>. Attention is drawn to the limitation of liability, indemnification and jurisdiction issues defined therein. Any holder of this document is advised that information contained hereon reflects the Company's findings at the time of its intervention only and within the limits of Client's instructions, if any. The Company's sole responsibility is to its Client and this document does not exonerate parties to a transaction from exercising all their rights and obligations under the transaction documents. This document cannot be reproduced except in full, without prior written approval of the Company. Any unauthorized alteration, forgery or falsification of the content or appearance of this document is unlawful and offenders may be prosecuted to the fullest extent of the law. Unless otherwise stated the results shown in this test report refer only to the sample(s) tested and such sample(s) are retained for 30 days only.

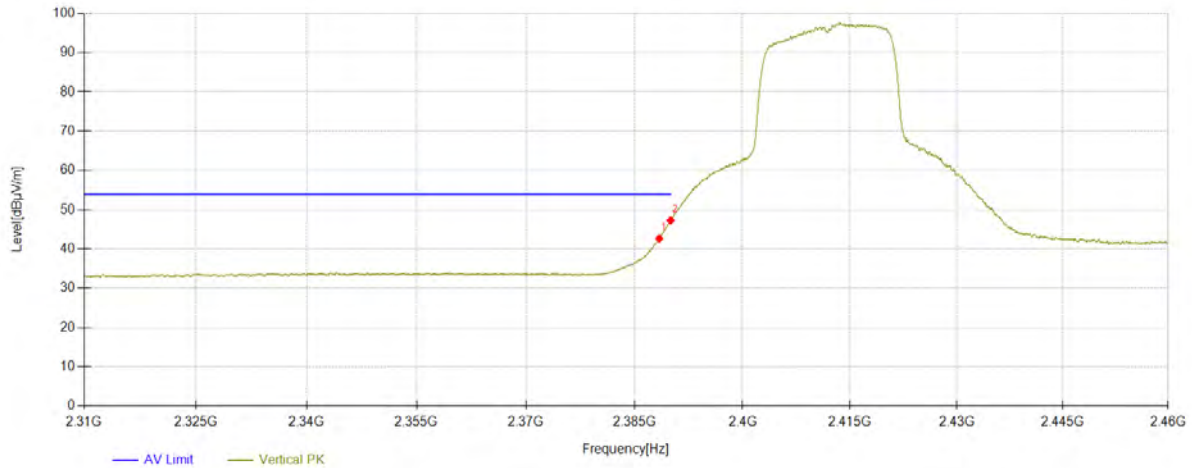
Attention: To check the authenticity of testing /inspection report & certificate, please contact us at telephone: (86-755) 8307 1443, or email: CN.Doccheck@sgs.com  
 No.1 Workshop, M-10, Middle Section, Science & Technology Park, Nanshan District, Shenzhen, Guangdong, China 518057 t (86-755) 26012053 www.sgs.com.cn  
 中国·广东·深圳市南山区科技园中区M-10栋1号厂房 邮编: 518057 t (86-755) 26012053 sgs.china@sgs.com



# SGS-CSTC Standards Technical Services Co., Ltd. Shenzhen Branch

Report No.: SZCR240100035204  
Page: 111 of 115

## 802.11n20\_Channel 01



Data List								
NO.	Frequency [MHz]	Reading [dBµV]	AF [dB/m]	Factor [dB]	Level [dBµV/m]	Limit [dBµV/m]	Margin [dB]	Polarity
1	2388.4142	41.24	27.13	-25.70	42.67	54.00	11.33	Vertical
2	2389.99	45.83	27.14	-25.70	47.27	54.00	6.73	Vertical

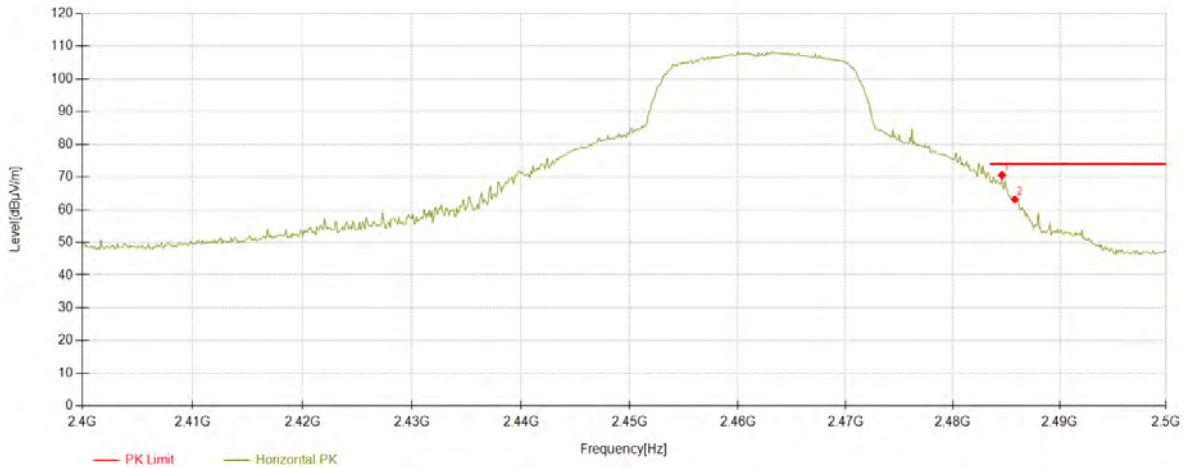


Unless otherwise agreed in writing, this document is issued by the Company subject to its General Conditions of Service printed overleaf, available on request or accessible at <https://www.sgs.com/en/Terms-and-Conditions>. Attention is drawn to the limitation of liability, indemnification and jurisdiction issues defined therein. Any holder of this document is advised that information contained hereon reflects the Company's findings at the time of its intervention only and within the limits of Client's instructions, if any. The Company's sole responsibility is to its Client and this document does not exonerate parties to a transaction from exercising all their rights and obligations under the transaction documents. This document cannot be reproduced except in full, without prior written approval of the Company. Any unauthorized alteration, forgery or falsification of the content or appearance of this document is unlawful and offenders may be prosecuted to the fullest extent of the law. Unless otherwise stated the results shown in this test report refer only to the sample(s) tested and such sample(s) are retained for 30 days only.

Attention: To check the authenticity of testing /inspection report & certificate, please contact us at telephone: (86-755) 8307 1443, or email: CN.Doccheck@sgs.com

No.1 Workshop, M-10, Middle Section, Science & Technology Park, Nanshan District, Shenzhen, Guangdong, China 518057 t (86-755) 26012053 www.sgsgroup.com.cn  
中国·广东·深圳市南山区科技园中区M-10栋1号厂房 邮编: 518057 t (86-755) 26012053 sgs.china@sgs.com




**802.11n20\_Channel 11**


Data List								
NO.	Frequency [MHz]	Reading [dBµV]	AF [dB/m]	Factor [dB]	Level [dBµV/m]	Limit [dBµV/m]	Margin [dB]	Polarity
1	2484.6	68.32	27.36	-25.14	70.54	74.00	3.46	Horizontal
2	2485.8	60.91	27.37	-25.13	63.15	74.00	10.85	Horizontal


 SGS-CSTC Standards Technical Services Co., Ltd.  
 Shenzhen Branch, Inspection & Testing Services

Unless otherwise agreed in writing, this document is issued by the Company subject to its General Conditions of Service printed overleaf, available on request or accessible at <https://www.sgs.com/en/Terms-and-Conditions>. Attention is drawn to the limitation of liability, indemnification and jurisdiction issues defined therein. Any holder of this document is advised that information contained hereon reflects the Company's findings at the time of its intervention only and within the limits of Client's instructions, if any. The Company's sole responsibility is to its Client and this document does not exonerate parties to a transaction from exercising all their rights and obligations under the transaction documents. This document cannot be reproduced except in full, without prior written approval of the Company. Any unauthorized alteration, forgery or falsification of the content or appearance of this document is unlawful and offenders may be prosecuted to the fullest extent of the law. Unless otherwise stated the results shown in this test report refer only to the sample(s) tested and such sample(s) are retained for 30 days only.

Attention: To check the authenticity of testing /inspection report & certificate, please contact us at telephone: (86-755) 8307 1443, or email: CN.Doccheck@sgs.com

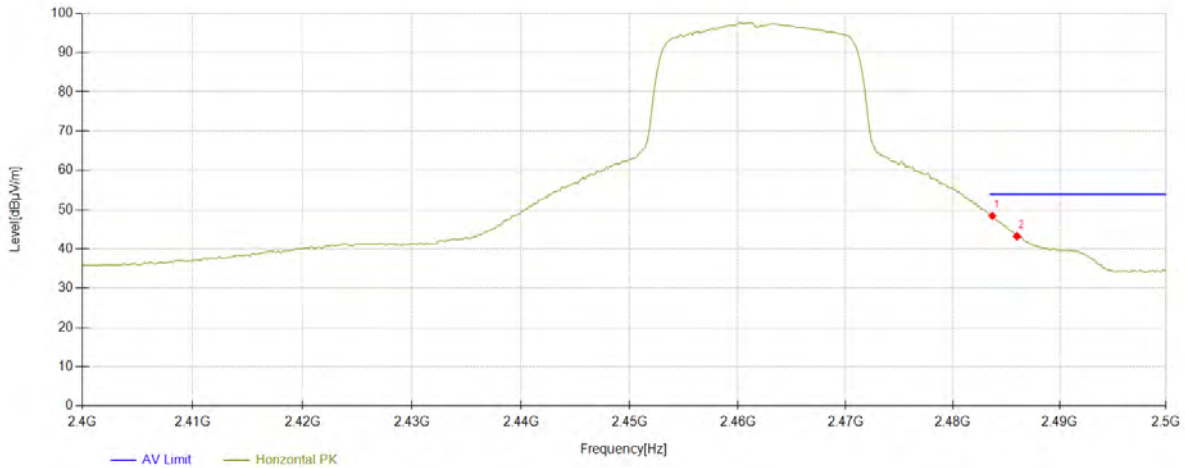
No.1 Workshop, M-10, Middle Section, Science & Technology Park, Nanshan District, Shenzhen, Guangdong, China 518057 t (86-755) 26012053 www.sgs.com.cn  
 中国·广东·深圳市南山区科技园中区M-10栋1号厂房 邮编: 518057 t (86-755) 26012053 sgs.china@sgs.com



# SGS-CSTC Standards Technical Services Co., Ltd. Shenzhen Branch

Report No.: SZCR240100035204  
Page: 113 of 115

## 802.11n20\_Channel 11



Data List								
NO.	Frequency [MHz]	Reading [dBµV]	AF [dB/m]	Factor [dB]	Level [dBµV/m]	Limit [dBµV/m]	Margin [dB]	Polarity
1	2483.7	46.22	27.36	-25.14	48.44	54.00	5.56	Horizontal
2	2486	41.01	27.37	-25.13	43.25	54.00	10.75	Horizontal



SGS-CSTC Standards Technical Services Co., Ltd.  
Shenzhen Branch, Inspection & Testing Services

Unless otherwise agreed in writing, this document is issued by the Company subject to its General Conditions of Service printed overleaf, available on request or accessible at <https://www.sgs.com/en/Terms-and-Conditions>. Attention is drawn to the limitation of liability, indemnification and jurisdiction issues defined therein. Any holder of this document is advised that information contained hereon reflects the Company's findings at the time of its intervention only and within the limits of Client's instructions, if any. The Company's sole responsibility is to its Client and this document does not exonerate parties to a transaction from exercising all their rights and obligations under the transaction documents. This document cannot be reproduced except in full, without prior written approval of the Company. Any unauthorized alteration, forgery or falsification of the content or appearance of this document is unlawful and offenders may be prosecuted to the fullest extent of the law. Unless otherwise stated the results shown in this test report refer only to the sample(s) tested and such sample(s) are retained for 30 days only.  
Attention: To check the authenticity of testing /inspection report & certificate, please contact us at telephone: (86-755) 8307 1443, or email: CN.Doccheck@sgs.com

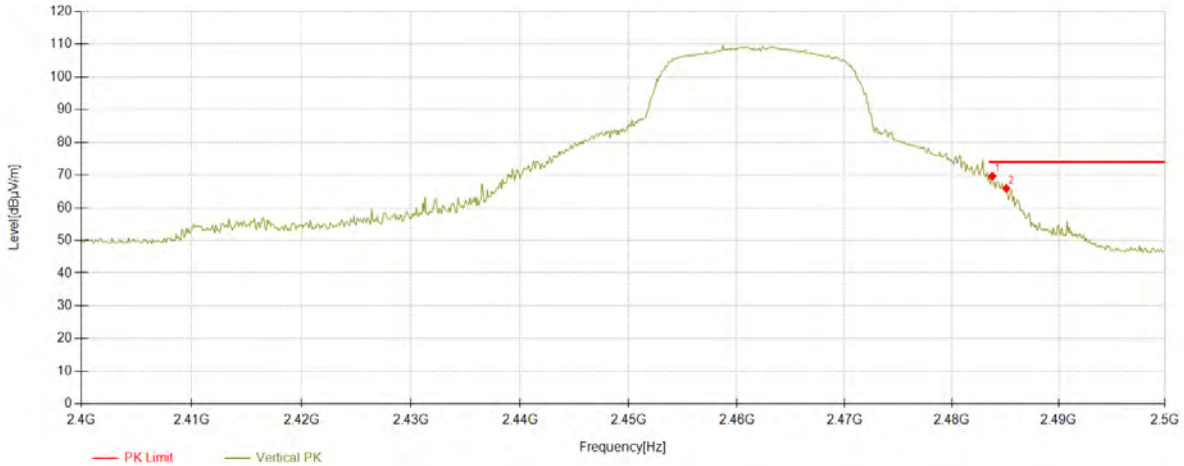
No.1 Workshop, M-10, Middle Section, Science & Technology Park, Nanshan District, Shenzhen, Guangdong, China 518057 t (86-755) 26012053 www.sgs.com.cn  
中国·广东·深圳市南山区科技园中区M-10栋1号厂房 邮编: 518057 t (86-755) 26012053 sgs.china@sgs.com



**SGS-CSTC Standards Technical Services Co., Ltd.**  
**Shenzhen Branch**

Report No.: SZCR240100035204  
 Page: 114 of 115

**802.11n20\_Channel 11**

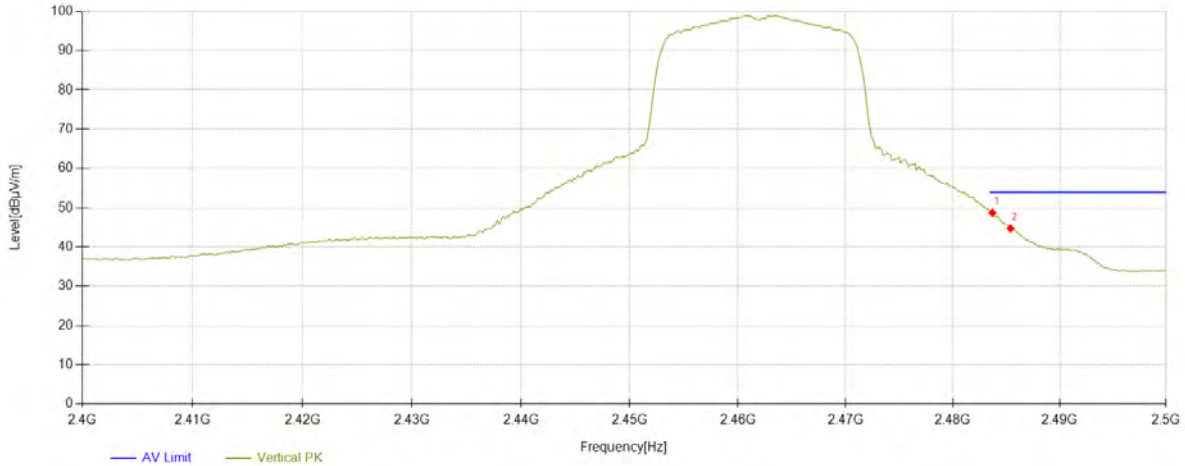


Data List								
NO.	Frequency [MHz]	Reading [dBµV]	AF [dB/m]	Factor [dB]	Level [dBµV/m]	Limit [dBµV/m]	Margin [dB]	Polarity
1	2483.8	67.41	27.36	-25.14	69.63	74.00	4.37	Vertical
2	2485.1	63.64	27.36	-25.14	65.86	74.00	8.14	Vertical



Unless otherwise agreed in writing, this document is issued by the Company subject to its General Conditions of Service printed overleaf, available on request or accessible at <https://www.sgs.com/en/Terms-and-Conditions>. Attention is drawn to the limitation of liability, indemnification and jurisdiction issues defined therein. Any holder of this document is advised that information contained hereon reflects the Company's findings at the time of its intervention only and within the limits of Client's instructions, if any. The Company's sole responsibility is to its Client and this document does not exonerate parties to a transaction from exercising all their rights and obligations under the transaction documents. This document cannot be reproduced except in full, without prior written approval of the Company. Any unauthorized alteration, forgery or falsification of the content or appearance of this document is unlawful and offenders may be prosecuted to the fullest extent of the law. Unless otherwise stated the results shown in this test report refer only to the sample(s) tested and such sample(s) are retained for 30 days only.

Attention: To check the authenticity of testing /inspection report & certificate, please contact us at telephone: (86-755) 8307 1443, or email: CN.Doccheck@sgs.com  
 No.1 Workshop, M-10, Middle Section, Science & Technology Park, Nanshan District, Shenzhen, Guangdong, China 518057 t (86-755) 26012053 www.sgs.com.cn  
 中国·广东·深圳市南山区科技园中区M-10栋1号厂房 邮编: 518057 t (86-755) 26012053 sgs.china@sgs.com


**802.11n20\_Channel 11**


Data List								
NO.	Frequency [MHz]	Reading [dBµV]	AF [dB/m]	Factor [dB]	Level [dBµV/m]	Limit [dBµV/m]	Margin [dB]	Polarity
1	2483.7	46.50	27.36	-25.14	48.72	54.00	5.28	Vertical
2	2485.4	42.50	27.36	-25.13	44.73	54.00	9.27	Vertical

**Remark:**

- The field strength is calculated by adding the Antenna Factor, Cable Factor & Pre-amplifier gain. The basic equation with a sample calculation is as follows:  

$$\text{Level} = \text{Reading}(\text{dB}\mu\text{V}) + \text{AF}(\text{dB}/\text{m}) + \text{Factor}(\text{dB})$$

$$\text{AF} = \text{Antenna Factor}(\text{dB}/\text{m})$$

$$\text{Factor} = \text{Cable Factor}(\text{dB}) - \text{Pre-amplifier gain}(\text{dB})$$

$$\text{Margin} = \text{Limit}(\text{dB}\mu\text{V}/\text{m}) - \text{Level}(\text{dB}\mu\text{V}/\text{m})$$
- Both peak and average measured complies with the limit line, so test result is "PASS"

---End of Report---



Unless otherwise agreed in writing, this document is issued by the Company subject to its General Conditions of Service printed overleaf, available on request or accessible at <https://www.sgs.com/en/Terms-and-Conditions>. Attention is drawn to the limitation of liability, indemnification and jurisdiction issues defined therein. Any holder of this document is advised that information contained hereon reflects the Company's findings at the time of its intervention only and within the limits of Client's instructions, if any. The Company's sole responsibility is to its Client and this document does not exonerate parties to a transaction from exercising all their rights and obligations under the transaction documents. This document cannot be reproduced except in full, without prior written approval of the Company. Any unauthorized alteration, forgery or falsification of the content or appearance of this document is unlawful and offenders may be prosecuted to the fullest extent of the law. Unless otherwise stated the results shown in this test report refer only to the sample(s) tested and such sample(s) are retained for 30 days only.

Attention: To check the authenticity of testing /inspection report & certificate, please contact us at telephone: (86-755) 8307 1443, or email: [CN.Doccheck@sgs.com](mailto:CN.Doccheck@sgs.com)

No.1 Workshop, M-10, Middle Section, Science & Technology Park, Nanshan District, Shenzhen, Guangdong, China 518057 t (86-755) 26012053 www.sgs.com.cn  
 中国·广东·深圳市南山区科技园中区M-10栋1号厂房 邮编: 518057 t (86-755) 26012053 sgs.china@sgs.com