

# FCC DFS Test Report

## FCC ID: 2AFZZL09G

This report concerns: Original Grant

**Project No.** : 2106C114  
**Equipment** : Mi Smart Speaker  
**Brand Name** : MI  
**Test Model** : L09G  
**Series Model** : N/A  
**Applicant** : Xiaomi Communications Co.,Ltd  
**Address** : #019, 9th Floor, Building 6, 33 Xi'erqi Middle Road, Haidian District, Beijing, China  
**Manufacturer** : Xiaomi Communications Co.,Ltd  
**Address** : #019, 9th Floor, Building 6, 33 Xi'erqi Middle Road, Haidian District, Beijing, China  
**Factory** : Huizhou MTN WEIYE Technology Development Co.,Ltd  
**Address** : No.2 Huitai Road,Huinan High-tech Industrial Park,Huihao Avenue,Huizhou City,Guangdong Province,China. 516000  
**Date of Receipt** : Jun. 16, 2021  
**Date of Test** : Jun. 16, 2021 ~ Aug. 05, 2021  
**Issued Date** : Aug. 13, 2021  
**Report Version** : R00  
**Test Sample** : Engineering Sample No.: DG202106169  
**Standard(s)** : FCC CFR Title 47, Part 15, Subpart E  
FCC KDB 789033 D02 General U-NII Test Procedures New Rules v02r01  
FCC KDB 905462 D02 UNII DFS Compliance Procedures New Rules v02  
FCC KDB 905462 D03 UNII Clients Without Radar Detection New Rules v01r02

The above equipment has been tested and found compliance with the requirement of the relative standards by BTL Inc.



Prepared by : Chella Zheng



Approved by : Ethan Ma



TESTING CERT #5123.02

Add: No. 3 Jinshagang 1st Rd. Shixia, Dalang Town, Dongguan City, Guangdong, People's Republic of China.

Tel: +86-769-8318-3000

Web: www.newbtl.com

**Declaration**

**BTL** represents to the client that testing is done in accordance with standard procedures as applicable and that test instruments used has been calibrated with standards traceable to international standard(s) and/or national standard(s).

**BTL's** reports apply only to the specific samples tested under conditions. It is manufacture's responsibility to ensure that additional production units of this model are manufactured with the identical electrical and mechanical components. **BTL** shall have no liability for any declarations, inferences or generalizations drawn by the client or others from **BTL** issued reports.

The report must not be used by the client to claim product certification, approval, or endorsement by NVLAP, NIST, A2LA, or any agency of the U.S. Government.

This report is the confidential property of the client. As a mutual protection to the clients, the public and ourselves, the test report shall not be reproduced, except in full, without our written approval.

**BTL's** laboratory quality assurance procedures are in compliance with the **ISO/IEC 17025** requirements, and accredited by the conformity assessment authorities listed in this test report.

**BTL** is not responsible for the sampling stage, so the results only apply to the sample as received.

The information, data and test plan are provided by manufacturer which may affect the validity of results, so it is manufacturer's responsibility to ensure that the apparatus meets the essential requirements of applied standards and in all the possible configurations as representative of its intended use.

**Limitation**

For the use of the authority's logo is limited unless the Test Standard(s)/Scope(s)/Item(s) mentioned in this test report is (are) included in the conformity assessment authorities acceptance respective.

Please note that the measurement uncertainty is provided for informational purpose only and are not use in determining the Pass/Fail results.

<b>Table of Contents</b>	<b>Page</b>
<b>REPORT ISSUED HISTORY</b>	<b>4</b>
<b>1 . TEST FACILITY</b>	<b>5</b>
<b>2 . TEST ENVIRONMENT CONDITIONS</b>	<b>5</b>
<b>3 . SUMMARY OF TEST RESULTS</b>	<b>5</b>
<b>4 . GENERAL INFORMATION</b>	<b>6</b>
4.1 GENERAL DESCRIPTION OF EUT	6
4.2 MAXIMUM OUTPUT POWER AND E.I.R.P.	8
4.3 TRANSMIT POWER CONTROL (TPC)	9
4.4 DESCRIPTION OF TEST MODES	11
<b>5 . U-NII DFS RULE REQUIREMENTS</b>	<b>12</b>
5.1 WORKING MODES AND REQUIRED TEST ITEMS	12
5.2 TEST LIMITS AND RADAR SIGNAL PARAMETERS	13
<b>6 . MEASUREMENT INSTRUMENTS LIST</b>	<b>14</b>
<b>7 . DYNAMIC FREQUENCY SELECTION (DFS)</b>	<b>15</b>
7.1 DFS MEASUREMENT SYSTEM	15
7.2 CALIBRATION OF DFS DETECTION THRESHOLD LEVEL	17
7.3 DEVIATION FROM TEST STANDARD	17
<b>8 . TEST RESULTS</b>	<b>18</b>
8.1 SUMMARY OF DFS TEST RESULT	18
8.2 DFS DETECTION THRESHOLD	19
8.3 CHANNEL MOVE TIME AND CHANNEL CLOSING TRANSMISSION TIME	20
8.4 NON-OCCUPANCY PERIOD	22
<b>9 . EUT TEST PHOTO</b>	<b>23</b>

**REPORT ISSUED HISTORY**

Report Version	Description	Issued Date
R00	Original Issue.	Aug. 13, 2021

## 1. TEST FACILITY

The test facilities used to collect the test data in this report is **TR16** at the location of No. 3 Jinshagang 1st Rd. Shixia, Dalang Town, Dongguan City, Guangdong, People's Republic of China.

## 2. TEST ENVIRONMENT CONDITIONS

Test Item	Temperature	Humidity	Test Voltage	Tested By
Dynamic Frequency Selection (DFS)	23.3°C	62%	DC 12V	Youny Zou

## 3. SUMMARY OF TEST RESULTS

Test procedures according to the technical standard(s):

FCC CFR Title 47, Part 15, Subpart E				
Standard(s) Section	Test Item	Test Result	Judgment	Remark
FCC 15.407(h)	Transmit Power Control (TPC) and Dynamic Frequency Selection (DFS)	-----	PASS	-----

## 4. GENERAL INFORMATION

### 4.1 GENERAL DESCRIPTION OF EUT

Equipment	Mi Smart Speaker
Brand Name	Xiaomi
Test Model	L09G
Series Model	N/A
Model Difference(s)	N/A
Power Source	DC voltage supplied from AC adapter. Model: CYXT18-120150U
Power Rating	I/P: 100-240V~50/60Hz 0.6A O/P: 12V1.5A
Operation Frequency Band(s)	UNII-2A: 5250 MHz ~ 5350 MHz UNII-2C: 5470 MHz ~ 5725 MHz
Modulation Type	IEEE 802.11a/n/ac: OFDM
Bit Rate of Transmitter	IEEE 802.11a: 54/48/36/24/18/12/9/6 Mbps IEEE 802.11n: up to 150 Mbps IEEE 802.11ac: up to 433.3 Mbps
Operating Mode(s)	<input type="checkbox"/> Master <input checked="" type="checkbox"/> Client device without radar detection <input type="checkbox"/> Client device with radar detection
Max. Output Power UNII-2A	IEEE 802.11ac(VHT40): 16.30 dBm (0.0427 W)
Max. Output Power UNII-2C	IEEE 802.11a: 16.30 dBm (0.0427 W)

Note:

1. For a more detailed features description, please refer to the manufacturer's specifications or the user's manual.

2. Channel List:

IEEE 802.11a IEEE 802.11n(HT20) IEEE 802.11ac(VHT20)		IEEE 802.11n(HT40) IEEE 802.11ac(VHT40)		IEEE 802.11ac(VHT80)	
UNII-2A		UNII-2A		UNII-2A	
Channel	Frequency (MHz)	Channel	Frequency (MHz)	Channel	Frequency (MHz)
52	5260	54	5270	58	5290
56	5280	62	5310		
60	5300				
64	5320				

IEEE 802.11a IEEE 802.11n(HT20) IEEE 802.11ac(VHT20)		IEEE 802.11n(HT40) IEEE 802.11ac(VHT40)		IEEE 802.11ac(VHT80)	
UNII-2C		UNII-2C		UNII-2C	
Channel	Frequency (MHz)	Channel	Frequency (MHz)	Channel	Frequency (MHz)
100	5500	102	5510	106	5530
104	5520	110	5550	122	5610
108	5540	118	5590		
112	5560	126	5630		
116	5580	134	5670		
120	5600				
124	5620				
128	5640				
132	5660				
136	5680				
140	5700				

**3. Antenna Specification:**

Ant.	Brand	P/N	Antenna Type	Connector	Gain (dBi)
1	 South Star	N12-6457-R04	FPC	N/A	3.57

**Note:**

- 1) The antenna gain is provided by the manufacturer.

**4.2 MAXIMUM OUTPUT POWER AND E.I.R.P.**

<b>Frequency Band (MHz)</b>	<b>Max Output Power (dBm)</b>	<b>Antenna Gain (dBi)</b>	<b>Max. e.i.r.p. (dBm)</b>	<b>Max. e.i.r.p. (mW)</b>
5250~5350	16.30	3.57	19.87	97.0510
5470~5725	16.30	3.57	19.87	97.0510

## Note:

- 1) U-NII devices operating in the 5.25-5.35 GHz band and the 5.47-5.725 GHz band shall employ a TPC mechanism. A TPC mechanism is not required for systems with an e.i.r.p. of less than 500 mW.



### 4.3 TRANSMIT POWER CONTROL (TPC)

The U-NII device is required to have the capability to operate at least 6 dB below the mean EIRP value of 30 dBm.

Test Mode: UNII-2A / IEEE 802.11a Mode			
Channel	Frequency (MHz)	Output Power (TPC High) (dBm)	Output Power (TPC Low) (dBm)
52	5260	14.23	8.23
60	5300	15.64	9.64
64	5320	15.37	9.37

Test Mode: UNII-2A / IEEE 802.11n(HT20) Mode			
Channel	Frequency (MHz)	Output Power (TPC High) (dBm)	Output Power (TPC Low) (dBm)
52	5260	15.03	9.03
60	5300	15.46	9.46
64	5320	15.34	9.34

Test Mode: UNII-2A / IEEE 802.11n(HT40) Mode			
Channel	Frequency (MHz)	Output Power (TPC High) (dBm)	Output Power (TPC Low) (dBm)
54	5270	16.27	10.27
62	5310	15.20	9.20

Test Mode: UNII-2A / IEEE 802.11ac(VHT20) Mode			
Channel	Frequency (MHz)	Output Power (TPC High) (dBm)	Output Power (TPC Low) (dBm)
52	5260	15.18	9.18
60	5300	15.54	9.54
64	5320	15.44	9.44

Test Mode: UNII-2A / IEEE 802.11ac(VHT40) Mode			
Channel	Frequency (MHz)	Output Power (TPC High) (dBm)	Output Power (TPC Low) (dBm)
54	5270	16.30	10.30
62	5310	15.09	9.09

Test Mode: UNII-2A / IEEE 802.11ac(VHT80) Mode			
Channel	Frequency (MHz)	Output Power (TPC High) (dBm)	Output Power (TPC Low) (dBm)
58	5290	14.29	8.29

Test Mode: UNII-2C / IEEE 802.11a Mode			
Channel	Frequency (MHz)	Output Power (TPC High) (dBm)	Output Power (TPC Low) (dBm)
100	5500	16.07	10.07
116	5580	16.17	10.17
140	5700	16.30	10.30

Test Mode: UNII-2C / IEEE 802.11n(HT20) Mode			
Channel	Frequency (MHz)	Output Power (TPC High) (dBm)	Output Power (TPC Low) (dBm)
100	5500	15.77	9.77
116	5580	15.87	9.87
140	5700	16.00	10.00

Test Mode: UNII-2C / IEEE 802.11n(HT40) Mode			
Channel	Frequency (MHz)	Output Power (TPC High) (dBm)	Output Power (TPC Low) (dBm)
102	5510	14.95	8.95
110	5550	15.14	9.14
134	5670	15.36	9.36

Test Mode: UNII-2C / IEEE 802.11ac(VHT20) Mode			
Channel	Frequency (MHz)	Output Power (TPC High) (dBm)	Output Power (TPC Low) (dBm)
100	5500	15.69	9.69
116	5580	15.81	9.81
140	5700	16.02	10.02

Test Mode: UNII-2C / IEEE 802.11ac(VHT40) Mode			
Channel	Frequency (MHz)	Output Power (TPC High) (dBm)	Output Power (TPC Low) (dBm)
102	5510	15.10	9.10
110	5550	15.15	9.15
134	5670	15.26	9.26

Test Mode: UNII-2C / IEEE 802.11ac(VHT80) Mode			
Channel	Frequency (MHz)	Output Power (TPC High) (dBm)	Output Power (TPC Low) (dBm)
106	5530	13.07	7.07
122	5610	13.18	7.18

**4.4 DESCRIPTION OF TEST MODES**

Test Mode	Description
Mode 1	IEEE 802.11a: 5260MHz/5700MHz
Mode 2	IEEE 802.11n(HT40): 5270MHz/5670MHz
Mode 3	IEEE 802.11ac(VHT80): 5290MHz/5530MHz

## 5. U-NII DFS RULE REQUIREMENTS

### 5.1 WORKING MODES AND REQUIRED TEST ITEMS

The manufacturer shall state whether the UUT is capable of operating as a Master and/or a Client. If the UUT is capable of operating in more than one operating mode then each operating mode shall be tested separately. See tables below for the applicability of DFS requirements for each of the operational modes.

Applicability of DFS requirements prior to use a channel

Requirement	Operational Mode		
	Master	Client without radar detection	Client with radar detection
Non-Occupancy Period	√	√	√
DFS Detection Threshold	√	Not required	√
Channel Availability Check Time	√	Not required	Not required
U-NII Detection Bandwidth	√	Not required	√

Applicability of DFS requirements during normal operation

Requirement	Operational Mode		
	Master	Client without radar detection	Client with radar detection
DFS Detection Threshold	√	Not required	√
Channel Closing Transmission Time	√	√	√
Channel Move Time	√	√	√
U-NII Detection Bandwidth	√	Not required	√

Additional requirements for devices with multiple bandwidth modes	Master Device or Client with Radar Detection	Client Without Radar Detection
U-NII Detection Bandwidth and Statistical Performance Check	All BW modes must be tested	Not required
Channel Move Time and Channel Closing Transmission Time	Test using widest BW mode available	Test using the widest BW mode available for the link
All other tests	Any single BW mode	Not required

Note: Frequencies selected for statistical performance check should include several frequencies within the radar detection bandwidth and frequencies near the edge of the radar detection bandwidth. For 802.11 devices it is suggested to select frequencies in each of the bonded 20 MHz channels and the channel center frequency.

## 5.2 TEST LIMITS AND RADAR SIGNAL PARAMETERS

### DETECTION THRESHOLD VALUES

DFS Detection Thresholds for Master Devices and Client Devices with Radar Detection

Maximum Transmit Power	Value (See Notes 1, 2 and 3)
e.i.r.p. $\geq$ 200 milliwatt	-64 dBm
e.i.r.p. $<$ 200 milliwatt and power spectral density $<$ 10 dBm/MHz	-62 dBm
e.i.r.p. $<$ 200 milliwatt that do not meet the power spectral density requirement	-64 dBm

**Note 1:** This is the level at the input of the receiver assuming a 0 dBi receive antenna.

**Note 2:** Throughout these test procedures an additional 1 dB has been added to the amplitude of the test transmission waveforms to account for variations in measurement equipment. This will ensure that the test signal is at or above the detection threshold level to trigger a DFS response.

**Note 3:** e.i.r.p. is based on the highest antenna gain. For MIMO devices refer to KDB Publication 662911 D01.

### TEST LIMIT

DFS Response Requirement Values

Parameter	Value
Non-occupancy period	Minimum 30 minutes
Channel Availability Check Time	60 seconds
Channel Move Time	10 seconds. See Note 1.
Channel Closing Transmission Time	200 milliseconds + an aggregate of 60 milliseconds over remaining 10 second period. See Notes 1 and 2.
U-NII Detection Bandwidth	Minimum 100% of the UNII 99% transmission power bandwidth. See Note 3.

**Note 1:** Channel Move Time and the Channel Closing Transmission Time should be performed with Radar Type 0. The measurement timing begins at the end of the Radar Type 0 burst.

**Note 2:** The Channel Closing Transmission Time is comprised of 200 milliseconds starting at the beginning of the Channel Move Time plus any additional intermittent control signals required to facilitate a Channel move (an aggregate of 60 milliseconds) during the remainder of the 10 second period. The aggregate duration of control signals will not count quiet periods in between transmissions.

**Note 3:** During the U-NII Detection Bandwidth detection test, radar type 0 should be used. For each frequency step the minimum percentage of detection is 90 percent. Measurements are performed with no data traffic.

### PARAMETERS OF DFS TEST SIGNALS

Step intervals of 0.1 microsecond for Pulse Width, 1 microsecond for PRI, 1 MHz for chirp width and 1 for the number of pulses will be utilized for the random determination of specific test waveforms.

Short Pulse Radar Test Waveforms.

Radar Type	Pulse Width ( $\mu$ sec)	PRI ( $\mu$ sec)	Number of Pulses	Minimum Percentage of Successful Detection	Minimum Number of Trials
0	1	1428	18	See Note 1	See Note 1

**Note 1:** Short Pulse Radar Type 0 should be used for the detection bandwidth test, channel move time, and channel closing time tests.

**6. MEASUREMENT INSTRUMENTS LIST**

Kind of Equipment	Manufacturer	Type No.	Serial No.	Calibrated until
Signal Generator	Agilent	E4438C	MY49071316	Feb. 27, 2022
EXA Spectrum Analyzer	Agilent	N9010A	MY50520044	Feb. 28, 2022
POWER SPLITTER	Mini-Circuits	ZN4PD1-63-S+	SF9335D1045-1	Feb. 27, 2022
POWER SPLITTER	Mini-Circuits	ZFRSC-123-S+	331000910-1	Feb. 27, 2022
Attenuator	WOKEN	6SM3502	VAS1214NL	Feb. 07, 2022
Wi-Fi Router	tp-link	Archer AX6000	N/A	N/A

Remark: "N/A" denotes no model name, serial no. or calibration specified.

All calibration period of equipment list is one year.

Wi-Fi Router's FCC ID: TE7AX6000

## 7. DYNAMIC FREQUENCY SELECTION (DFS)

### 7.1 DFS MEASUREMENT SYSTEM

#### Test Procedure

1. Master device and client device are set up by conduction method as the following configuration.
2. The client device is connected to notebook and to access a IP address on wireless connection with the master device.
3. Then the master device is connected to another notebook to access a IP address.
4. Finally, let the two IP addresses run traffic with each other through the Run flow software "Lan test" to reach 17% channel loading as below.

#### Setup for Client with injection at the Master

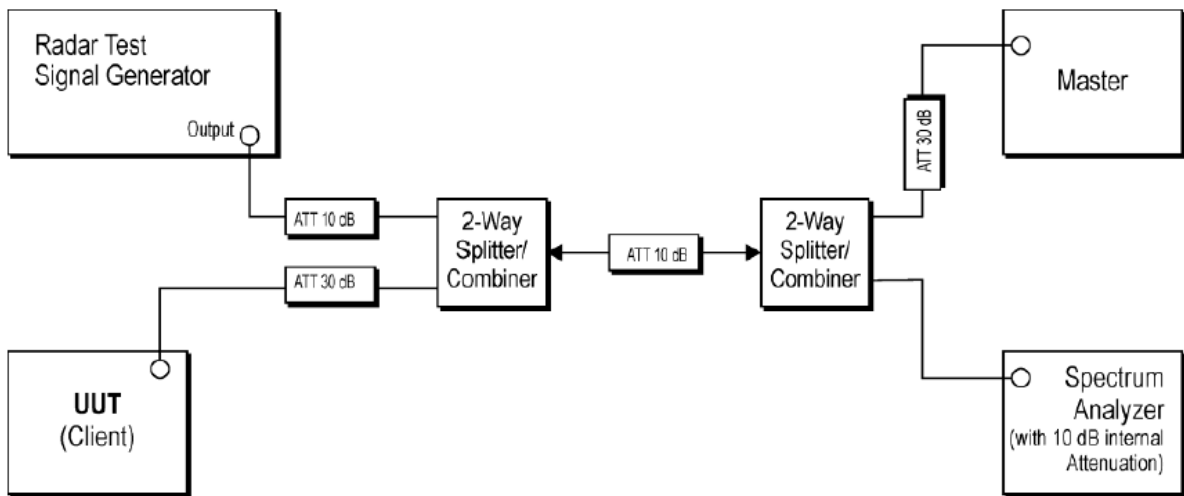

Radars Test Waveforms are injected into the Master.

### Channel Loading

#### IEEE 802.11ac(VHT80) Mode

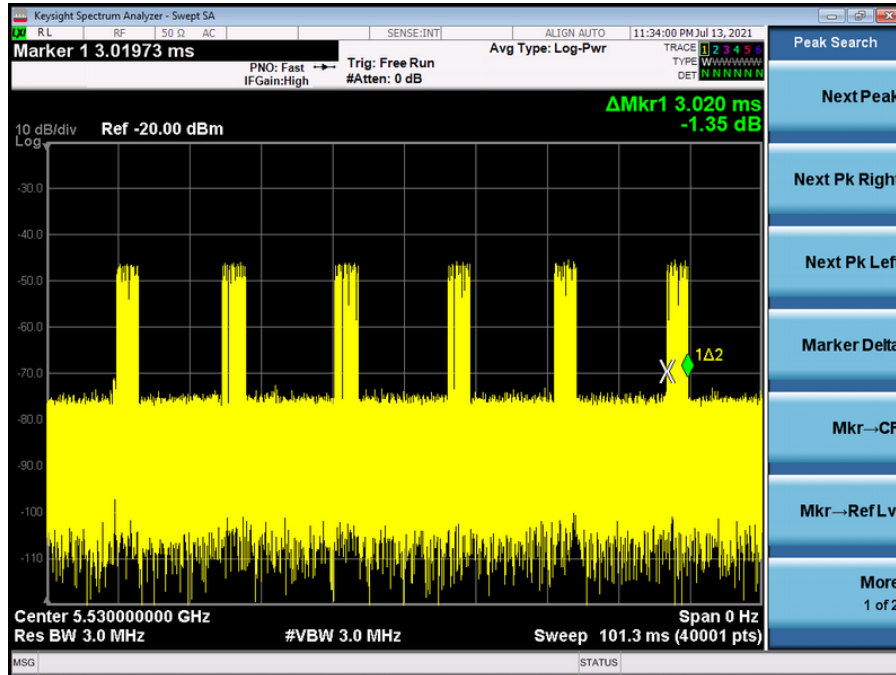

Frequency (MHz)	Marker Delta (ms)	Number	On Time (ms)	Total Time (ms)	Duty cycle (%)	Limit (%)
5530	3.02	6	18.12	101.3	17.89	17.00

The signal monitoring equipment consists of a spectrum analyzer set to display 8001 bins on the horizontal axis. The time-domain resolution is 2 msec / bin with a 16 second sweep time, meeting the 10 second short pulse reporting criteria. The aggregate ON time is calculated by multiplying the number of bins above a threshold during a particular observation period by the dwell time per bin, with the analyzer set to peak detection and max hold.

Should multiple RF ports be utilized for the Master and/or Slave devices (for example, for diversity or MIMO implementations), additional combiner/dividers are inserted between the Master Combiner/Divider and the pad connected to the Master Device (and/or between the Slave Combiner/Divider and the pad connected to the Slave Device). Additional pads are utilized such that there is one pad at each RF port on each EUT.



## 7.2 CALIBRATION OF DFS DETECTION THRESHOLD LEVEL

A 50 ohm load is connected in place of the spectrum analyzer, and the spectrum analyzer is connected in place of the master device and the signal generator is set to CW mode. The amplitude of the signal generator is adjusted to yield a level of -64dBm as measured on the spectrum analyzer.

Without changing any of the instrument settings, the spectrum analyzer is reconnected to the Common port of the Spectrum Analyzer Combiner/Divider. Measure the amplitude and calculate the difference from -64 dBm. Adjust the Reference Level Offset of the spectrum analyzer to this difference.

The spectrum analyzer displays the level of the signal generator as received at the antenna ports of the Master Device. The interference detection threshold may be varied from the calibrated value of -64 dBm and the spectrum analyzer will still indicate the level as received by the Master Device.

Set the signal generator to produce a radar waveform, trigger a burst manually and measure the level on the spectrum analyzer. Readjust the amplitude of the signal generator as required so that the peak level of the waveform is at a displayed level equal to the required or desired interference detection threshold. Separate signal generator amplitude settings are determined as required for each radar type.

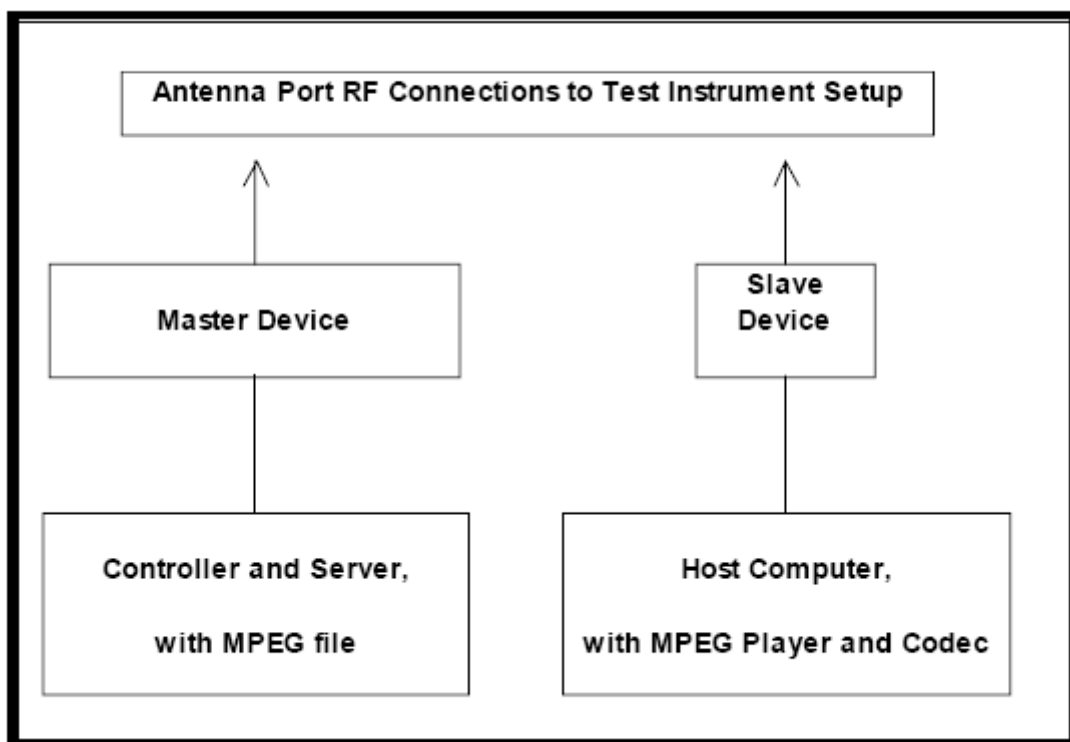

## 7.3 DEVIATION FROM TEST STANDARD

No deviation.

**8. TEST RESULTS****8.1 SUMMARY OF DFS TEST RESULT**

<b>Clause</b>	<b>Test Parameter</b>	<b>Remarks</b>	<b>Result</b>
FCC 15.407	Channel Move Time	Applicable	Pass
	Channel Closing Transmission Time	Applicable	Pass
	Non-Occupancy Period	Applicable	Pass

## 8.2 DFS DETECTION THRESHOLD

Calibration:

The EUT is slave equipment and it with a lowest gain is 3.57dBi.

For a detection threshold level of -62dBm and the master antenna gain is 2.90 dBi, required detection threshold is -59.10 dBm (= -62+2.90).

Note: Maximum Transmit Power is less than 200 milliwatt in this report, so detection threshold level is -62dBm.

Radar Signal 0

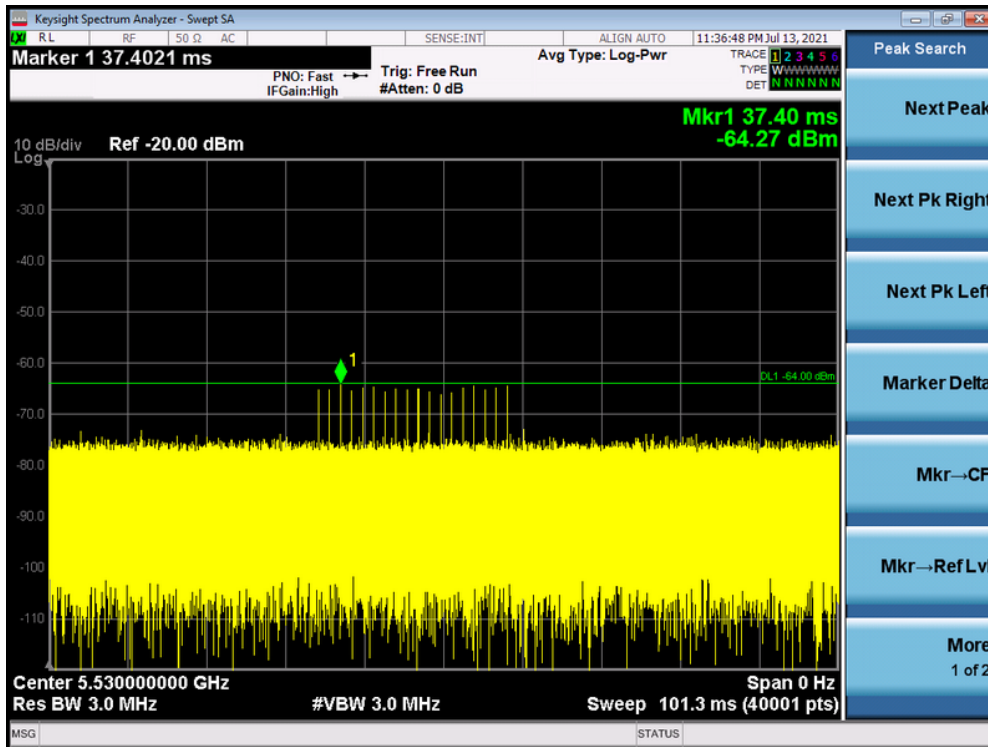

### 8.3 CHANNEL MOVE TIME AND CHANNEL CLOSING TRANSMISSION TIME

TX (IEEE 802.11ac(VHT80) Mode)

Radar signal 0

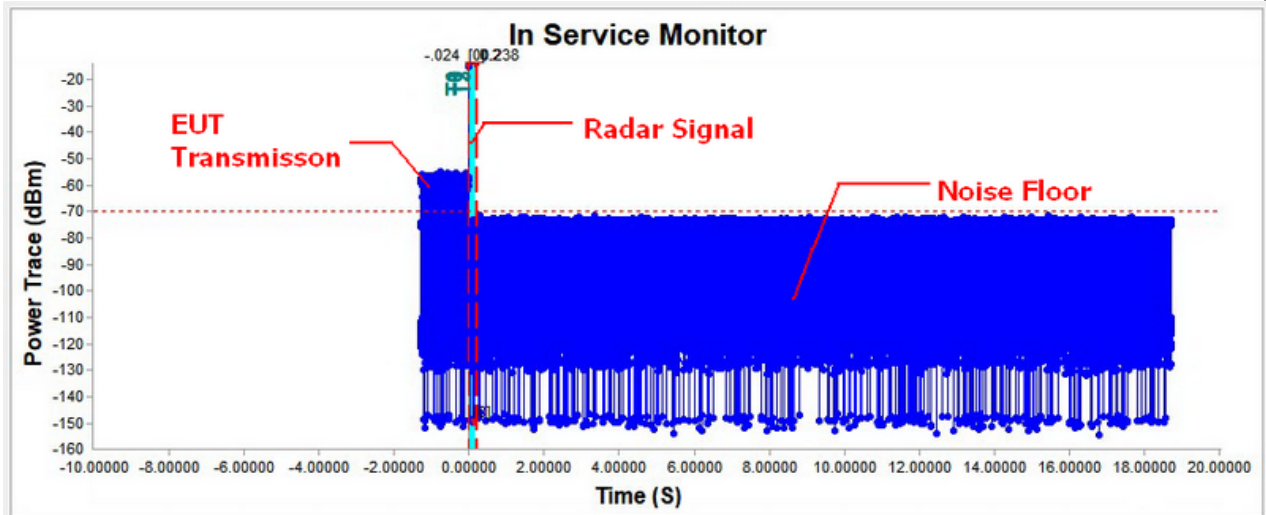

Time Index Info

T0 : -0.0240 S (Radar Injection Start)	Time Per Bin: 0.4999875	Channel Move Time: 0.2379941 S
T1 : 0.0000 S (Radar Injection Stop)	T2~T3 Bins Over Threshold:	Channel Close Time: 0.0 S
T2 : 0.2000 S (200msec Interval)	= 0 Bins	
T3 : 0.2380 S (Channel Move Time)		

**Note:** T0 denotes the Radar Injection Start.  
 T1 denotes the start of Channel Move Time upon the end of the last Radar burst.  
 T2 denotes the data transmission time of 200ms from T1.  
 T3 denotes the end of Channel Move Time.

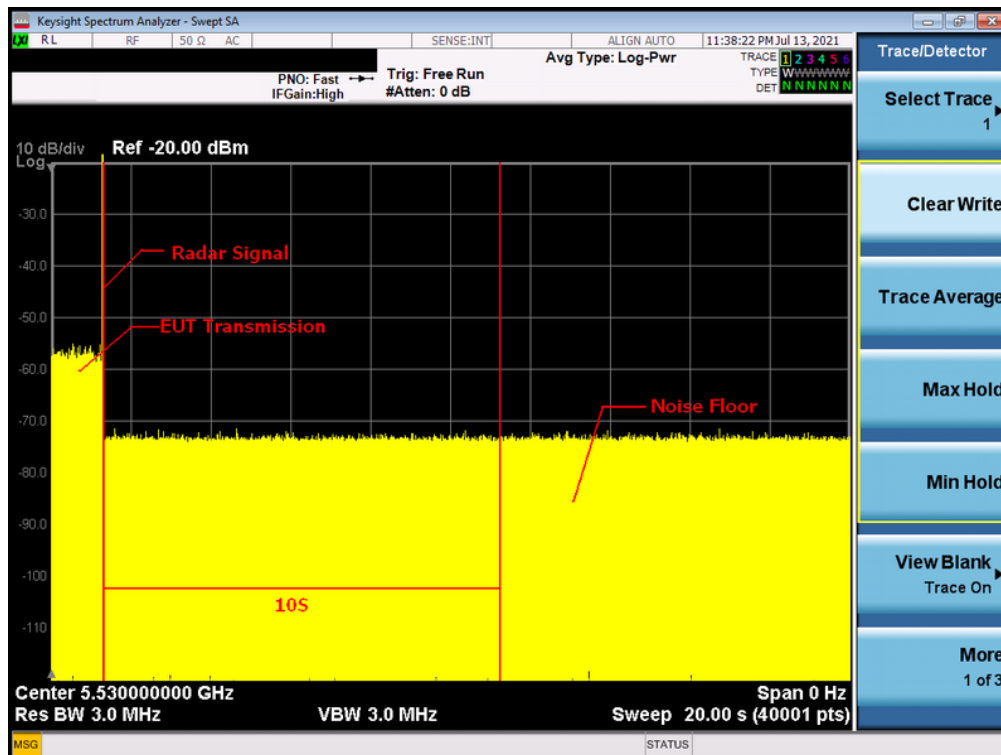

**Note:** An expanded plot for the device vacates the channel in the required 500ms

IEEE 802.11ac(VHT80) Mode		
Item	Measured Value(s)	Limit(s)
Channel Move Time	0.2379941	10
Channel Close Time	0.0	200 milliseconds + an aggregate of 60 milliseconds over remaining 10 second period.

## 8.4 NON-OCCUPANCY PERIOD

During the 30 minutes observation time, UUT did not make any transmissions on a channel after a radar signal was detected on that channel by either the Channel Availability Check or the In-Service Monitoring.

### TX (IEEE 802.11ac(VHT80) Mode) 5530MHz\_Non-Occupancy Period

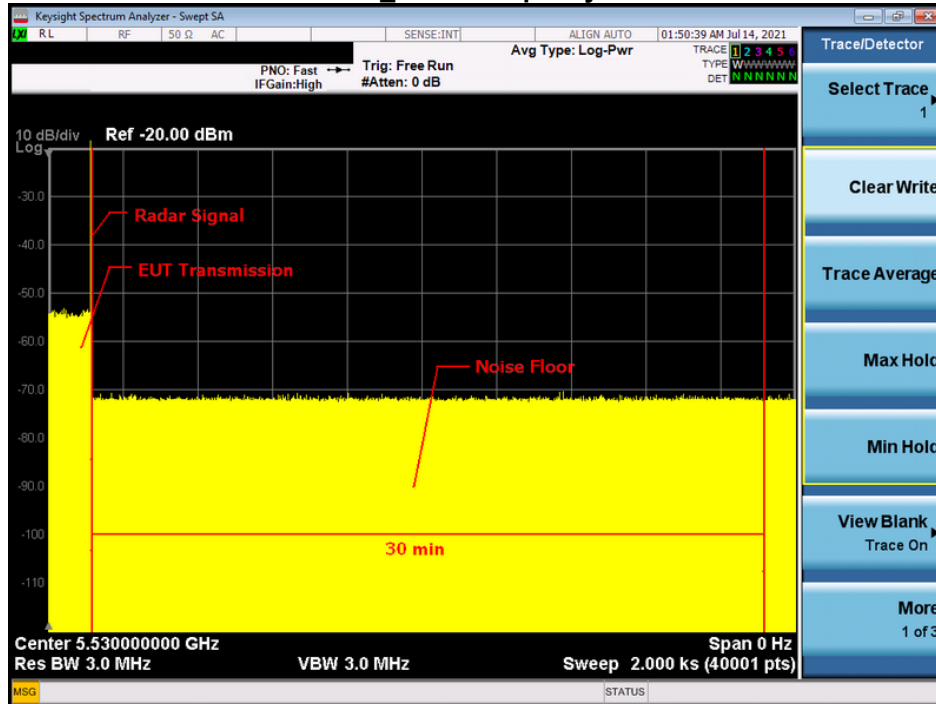

**9. EUT TEST PHOTO****End of Test Report**