



RF TEST REPORT

Applicant Xiaomi Communications Co., Ltd.
FCC ID 2AFZZK7BNY
Product Mobile Phone
Brand Redmi
Model M2101K7BNY
Report No. R2101A0095-R6V1
Issue Date March 23, 2021

TA Technology (Shanghai) Co., Ltd. tested the above equipment in accordance with the requirements in **FCC CFR47 Part 15E (2019)**. The test results show that the equipment tested is capable of demonstrating compliance with the requirements as documented in this report.

Prepared by: Peng Tao

Approved by: Kai Xu

TA Technology (Shanghai) Co., Ltd.

No.145, Jintang Rd, Tangzhen Industry Park, Pudong Shanghai, China

TEL: +86-021-50791141/2/3

FAX: +86-021-50791141/2/3-8000



TABLE OF CONTENT

1. Test Laboratory	5
1.1. Notes of the test report.....	5
1.2. Test facility	5
1.3. Testing Location.....	5
2. General Description of Equipment under Test.....	6
2.1. Applicant and Manufacturer Information.....	6
2.2. General information.....	6
3. Applied Standards	8
4. Test Configuration	9
5. Test Case Results	12
5.1. Occupied Bandwidth	12
5.2. Average Power Output.....	30
5.3. Frequency Stability.....	38
5.4. Power Spectral Density.....	42
5.5. Unwanted Emission	57
5.6. Conducted Emission	150
6. Main Test Instruments.....	153
ANNEX A: The EUT Appearance	154
ANNEX B: Test Setup Photos	155



Version	Revision description	Issue Date
Rev.0	Initial issue of report.	March 17, 2021
Rev.1	Update description in Page 7.	March 23, 2021

Note: This revised report (Report No. R2101A0095-R6V1) supersedes and replaces the previously issued report (Report No. R2101A0095-R6). Please discard or destroy the previously issued report and dispose of it accordingly.



Summary of measurement results

Number	Test Case	Clause in FCC rules	Verdict
1	Average output power	15.407(a)	PASS
2	Occupied bandwidth	15.407(e)	PASS
3	Frequency stability	15.407(g)	PASS
4	Power spectral density	15.407(a)	PASS
5	Unwanted Emissions	15.407(b)	PASS
6	Conducted Emissions	15.207	PASS
Date of Testing: February 7, 2021 ~March 10, 2021			
Date of Sample Received: February 7, 2021			
Note: All indications of Pass/Fail in this report are opinions expressed by TA Technology (Shanghai) Co., Ltd. based on interpretations and/or observations of test results. Measurement Uncertainties were not taken into account and are published for informational purposes only.			



1. Test Laboratory

1.1. Notes of the test report

This report shall not be reproduced in full or partial, without the written approval of **TA technology (shanghai) co., Ltd.** The results documented in this report apply only to the tested sample, under the conditions and modes of operation as described herein. Measurement Uncertainties were not taken into account and are published for informational purposes only. This report is written to support regulatory compliance of the applicable standards stated above.

1.2. Test facility

FCC (Designation number: CN1179, Test Firm Registration Number: 446626)

TA Technology (Shanghai) Co., Ltd. has been listed on the US Federal Communications Commission list of test facilities recognized to perform electromagnetic emissions measurements.

A2LA (Certificate Number: 3857.01)

TA Technology (Shanghai) Co., Ltd. has been listed by American Association for Laboratory Accreditation to perform electromagnetic emission measurement.

1.3. Testing Location

Company: TA Technology (Shanghai) Co., Ltd.
Address: No.145, Jintang Rd, Tangzhen Industry Park, Pudong
City: Shanghai
Post code: 201201
Country: P. R. China
Contact: Xu Kai
Telephone: +86-021-50791141/2/3
Fax: +86-021-50791141/2/3-8000
Website: <http://www.ta-shanghai.com>
E-mail: xukai@ta-shanghai.com

2. General Description of Equipment under Test

2.1. Applicant and Manufacturer Information

Applicant	Xiaomi Communications Co., Ltd.
Applicant address	#019, 9th Floor, Building 6, 33 Xi'erqi Middle Road, Haidian District, Beijing, China, 100085
Manufacturer	Xiaomi Communications Co., Ltd.
Manufacturer address	#019, 9th Floor, Building 6, 33 Xi'erqi Middle Road, Haidian District, Beijing, China, 100085

2.2. General information

EUT Description	
Model	M2101K7BNY
IMEI	IMEI 1: 869421050030962 IMEI 2: 869421050030970
Hardware Version	P2
Software Version	MIUI 12
Power Supply	Battery/AC adapter
Antenna Type	Fixed Internal Antenna
Antenna Gain	5150 MHz: -3.55 dBi 5550 MHz: -0.44 dBi
	5200 MHz: -1.18 dBi 5600 MHz: -0.53 dBi
	5250 MHz: -0.41 dBi 5650 MHz: -0.09 dBi
	5300 MHz: -0.68 dBi 5700 MHz: -0.59 dBi
	5350 MHz: -1.17 dBi 5750 MHz: -0.27 dBi
	5400 MHz: -0.55 dBi 5800 MHz: -0.36 dBi
	5450 MHz: -0.01 dBi 5850 MHz: -0.22 dBi
	5500 MHz: -0.40 dBi -- --
Directional Gain	NA
Test Band	U-NII-1 (5150MHz-5250MHz) U-NII-2A (5250MHz-5350MHz) U-NII-2C (5470MHz-5725MHz) U-NII-3 (5725MHz-5850MHz)
Modulation Type	802.11a/n (HT20/HT40) : OFDM 802.11ac (VHT20/VHT40/VHT80): OFDM
Max. Conducted Power	15.17 dBm
Operating Frequency Range(s)	U-NII-1: 5150MHz-5250MHz U-NII-2A: 5250MHz -5350MHz



	U-NII-2C: 5470MHz-5725MHz U-NII-3: 5725MHz -5850MHz
Extreme Temperature range:	-20 ° C to 50° C
Operating temperature range:	0 ° C to 40° C
Supply Voltage range:	3.6 V to 4.45 V
State DC voltage:	3.87V
<p>Note:1. The EUT is sent from the applicant to TA and the information of the EUT is declared by the applicant.</p> <p>2. This device support automatically discontinue transmission, while the device is not transmitting any information, the device can automatically discontinue transmission andbecome standby mode for power saving. The device can detect the controlling signal of ACK message transmitting from remote device and verify whether it shall resend ordiscontinue transmission.</p>	



3. Applied Standards

According to the specifications of the manufacturer, it must comply with the requirements of the following standards:

Test standards:

FCC CFR47 Part 15E (2019) Unlicensed National Information Infrastructure Devices

ANSI C63.10 (2013)

Reference standard:

KDB 789033 D02 General UNII Test Procedures New Rules v02r01

4. Test Configuration

Test Mode

The EUT has been associated with peripherals and configuration operated in a manner tended to maximize its emission characteristics in a typical application.

The radiated emission was measured in the following position: EUT stand-up position (Z axis), lie-down position (X, Y axis). The worst emission was found in lie-down position (Y axis) and the worst case was recorded.

In order to find the worst case condition, Pre-tests are needed at the presence of different data rate. Preliminary tests have been done on all the configuration for confirming worst case. Data rate below means worst-case rate of each test item.

Worst-case data rates are shown as following table.

Mode	Data Rate
802.11a	6 Mbps
802.11n HT20	MCS0
802.11n HT40	MCS0
802.11ac VHT20	MCS0
802.11ac VHT40	MCS0
802.11ac VHT80	MCS0

**Wireless Technology and Frequency Range**

Wireless Technology		Bandwidth	Channel	Frequency
Wi-Fi	U-NII-1	20 MHz	36	5180MHz
			40	5200MHz
			44	5220MHz
			48	5240MHz
		40 MHz	38	5190MHz
			46	5230MHz
	80 MHz	42	5210MHz	
	U-NII-2A	20 MHz	52	5260MHz
			56	5280MHz
			60	5300MHz
			64	5320MHz
		40 MHz	54	5270MHz
			62	5310MHz
	80 MHz	58	5290MHz	
	U-NII-2C	20 MHz	100	5500MHz
			104	5520MHz
			108	5540MHz
			112	5560MHz
			116	5580MHz
			120	5600MHz
			124	5620MHz
			128	5640MHz
			132	5660MHz
			136	5680MHz
		140	5700MHz	
		40 MHz	102	5510MHz
			110	5550MHz
			118	5590MHz
			126	5630MHz
			134	5670MHz
			142	5710MHz
		80 MHz	106	5530MHz
122	5610MHz			
138	5690MHz			
U-NII-3	20 MHz	149	5745MHz	
		153	5765MHz	
		157	5785MHz	
		161	5805MHz	



			165	5825MHz
		40 MHz	151	5755MHz
			159	5795MHz
		80 MHz	155	5775MHz
Does this device support TPC Function? <input type="checkbox"/> Yes <input checked="" type="checkbox"/> No				
Does this device support TDWR Band? <input checked="" type="checkbox"/> Yes <input type="checkbox"/> No				

5. Test Case Results

5.1. Occupied Bandwidth

Ambient condition

Temperature	Relative humidity	Pressure
23°C ~25°C	45%~50%	101.5kPa

Method of Measurement

The EUT was connected to the spectrum analyzer through an external attenuator (20dB) and a known loss cable.

For U-NII-1/U-NII-2A/U-NII-2C, set RBW \approx 1% OCB kHz, VBW \geq 3 \times RBW, measure the maximum width of the emission that is constrained by the frequencies associated with the two outermost amplitude points (upper and lower frequencies) that are attenuated by 26 dB relative to the maximum level measured in the fundamental emission.

For U-NII-3, Set RBW = 100 kHz, VBW \geq 3 \times RBW, measure the maximum width of the emission that is constrained by the frequencies associated with the two outermost amplitude points (upper and lower frequencies) that are attenuated by 6 dB relative to the maximum level measured in the fundamental emission.

Note: The automatic bandwidth measurement capability of a spectrum analyzer or EMI receiver may be employed if it implements the functionality described above.

Use the 99 % power bandwidth function of the instrument

Test Setup

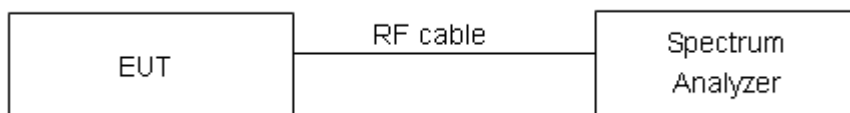

Limits

Rule FCC Part §15.407(e)

Within the 5.725-5.85 GHz band, the minimum 6 dB bandwidth of U-NII devices shall be at least 500 kHz.

Measurement Uncertainty

The assessed measurement uncertainty to ensure 95% confidence level for the normal distribution is with the coverage factor $k = 2$, $U = 936$ Hz.

**Test Results:****U-NII-1**

Mode	Carrier frequency (MHz)	99% bandwidth (MHz)	Minimum 26 dB bandwidth (MHz)	Conclusion
802.11a	5180	16.357	19.812	PASS
	5200	16.409	20.055	PASS
	5240	16.333	19.669	PASS
802.11n HT20	5180	17.517	19.988	PASS
	5200	17.541	19.999	PASS
	5240	17.504	20.134	PASS
802.11n HT40	5190	35.870	39.824	PASS
	5230	35.892	41.428	PASS
802.11ac VHT20	5180	17.537	19.910	PASS
	5200	17.539	19.979	PASS
	5240	17.476	19.838	PASS
802.11ac VHT40	5190	35.836	39.845	PASS
	5230	35.843	39.995	PASS
802.11ac VHT80	5210	75.372	80.700	PASS

U-NII-2A

Mode	Carrier frequency (MHz)	99% bandwidth (MHz)	Minimum 26 dB bandwidth (MHz)	Conclusion
802.11a	5260	16.427	19.752	PASS
	5300	16.381	19.656	PASS
	5320	16.410	19.597	PASS
802.11n HT20	5260	17.553	19.872	PASS
	5300	17.549	19.982	PASS
	5320	17.538	20.053	PASS
802.11n HT40	5270	36.098	41.281	PASS
	5310	36.067	40.625	PASS
802.11ac VHT20	5260	17.538	19.943	PASS
	5300	17.519	19.900	PASS
	5320	17.576	19.999	PASS
802.11ac VHT40	5270	36.053	40.381	PASS
	5310	36.065	40.562	PASS
802.11ac VHT80	5290	75.223	80.009	PASS



U-NII-2C

Mode	Carrier frequency (MHz)	99% bandwidth (MHz)	Minimum 26 dB bandwidth (MHz)	Conclusion
802.11a	5500	16.377	19.613	PASS
	5600	16.436	19.771	PASS
	5700	16.400	19.513	PASS
	5720	16.397	19.599	PASS
802.11n HT20	5500	17.542	19.911	PASS
	5600	17.564	20.500	PASS
	5700	17.567	19.913	PASS
	5720	17.525	20.372	PASS
802.11n HT40	5510	36.042	40.354	PASS
	5590	36.023	40.206	PASS
	5670	35.921	40.089	PASS
	5710	35.861	40.247	PASS
802.11ac VHT20	5500	17.542	19.946	PASS
	5600	17.536	20.037	PASS
	5700	17.547	19.771	PASS
	5720	17.530	19.811	PASS
802.11ac VHT40	5510	35.971	40.356	PASS
	5590	35.969	39.983	PASS
	5670	35.935	39.924	PASS
	5710	35.898	40.198	PASS
802.11ac VHT80	5530	75.313	80.619	PASS
	5610	75.226	80.405	PASS
	5690	75.211	80.282	PASS



U-NII-3

Mode	Carrier frequency (MHz)	99% bandwidth (MHz)	Minimum 6 dB bandwidth (MHz)	Limit (kHz)	Conclusion
802.11a	5745	16.427	14.915	500	PASS
	5785	16.469	15.000	500	PASS
	5825	16.404	15.677	500	PASS
802.11n HT20	5745	17.571	15.670	500	PASS
	5785	17.530	15.075	500	PASS
	5825	17.547	15.273	500	PASS
802.11n HT40	5755	35.959	35.090	500	PASS
	5795	36.095	32.528	500	PASS
802.11ac VHT20	5745	17.550	15.632	500	PASS
	5785	17.559	13.882	500	PASS
	5825	17.559	15.276	500	PASS
802.11ac VHT40	5755	35.955	33.773	500	PASS
	5795	36.043	35.109	500	PASS
802.11ac VHT80	5775	75.200	75.086	500	PASS



Antenna 1

U-NII-1, 802.11a
Carrier frequency (MHz): 5180



U-NII-1, 802.11n HT20
Carrier frequency (MHz): 5180

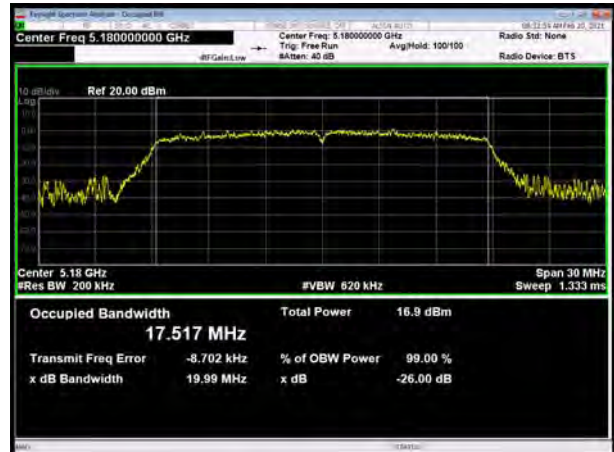

U-NII-1, 802.11a
Carrier frequency (MHz): 5200

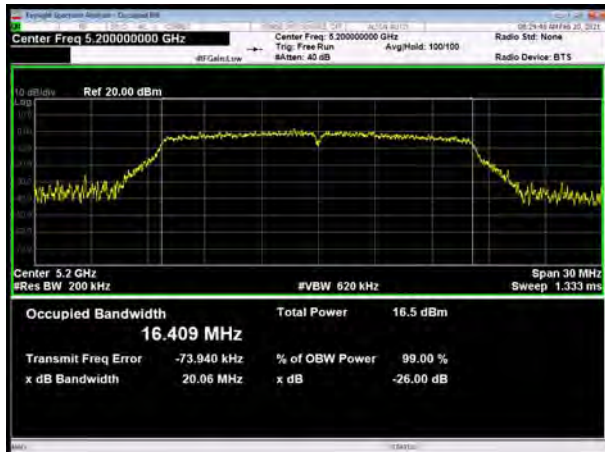

U-NII-1, 802.11n HT20
Carrier frequency (MHz): 5200

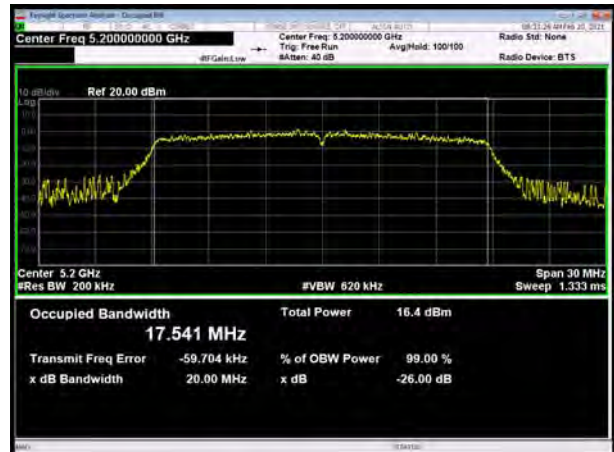

U-NII-1, 802.11a
Carrier frequency (MHz):5240



U-NII-1, 802.11n HT20
Carrier frequency (MHz):5240



U-NII-1, 802.11n HT40
Carrier frequency (MHz): 5190



U-NII-1, 802.11ac VHT20
Carrier frequency (MHz): 5180

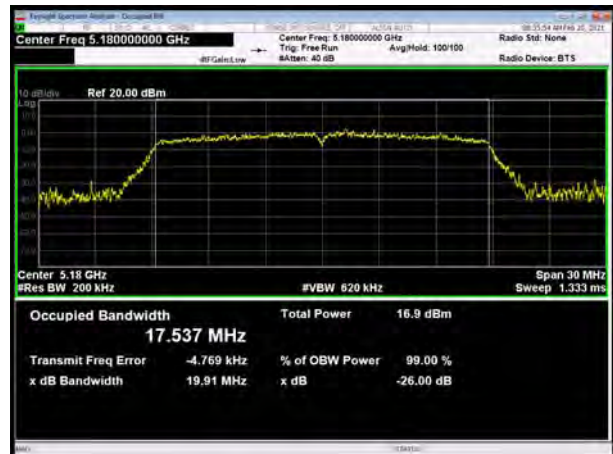

U-NII-1, 802.11n HT40
Carrier frequency (MHz): 5230



U-NII-1, 802.11ac VHT20
Carrier frequency (MHz): 5200



U-NII-1, 802.11ac VHT40
Carrier frequency (MHz): 5190



U-NII-1, 802.11ac VHT20
Carrier frequency (MHz): 5240



U-NII-1, 802.11ac VHT40
Carrier frequency (MHz): 5230



U-NII-1, 802.11ac VHT80
Carrier frequency (MHz): 5210

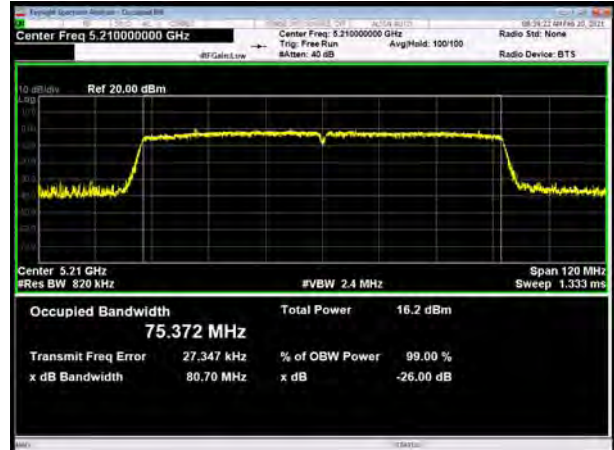

U-NII-2A, 802.11a
Carrier frequency (MHz): 5260



U-NII-2A, 802.11n HT20
Carrier frequency (MHz): 5260



U-NII-2A, 802.11a
Carrier frequency (MHz): 5300

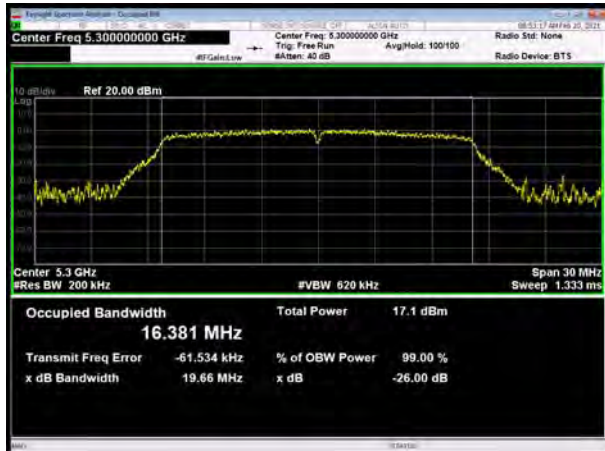

U-NII-2A, 802.11n HT20
Carrier frequency (MHz): 5300

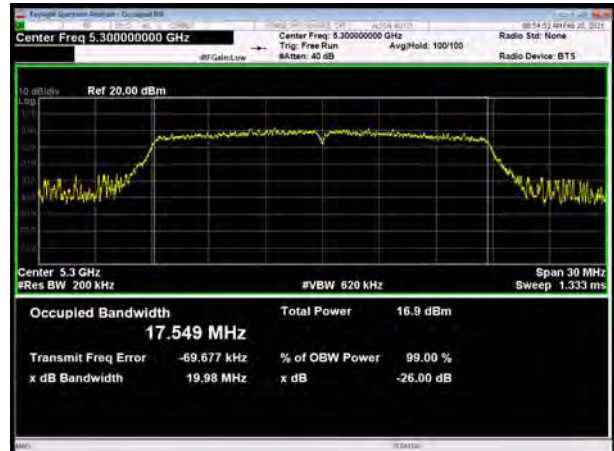

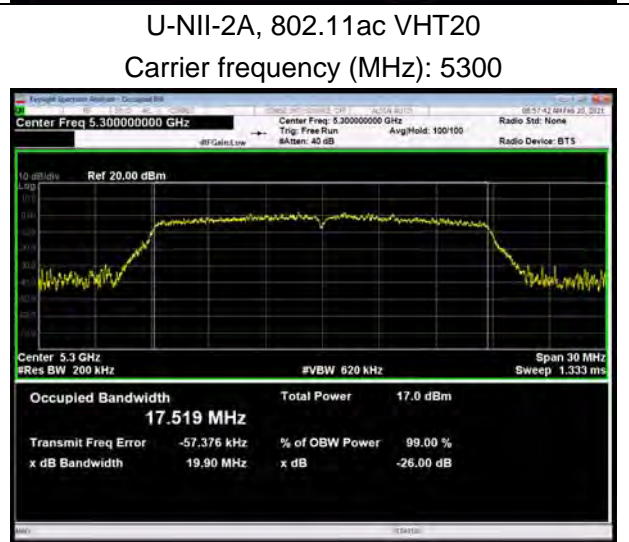
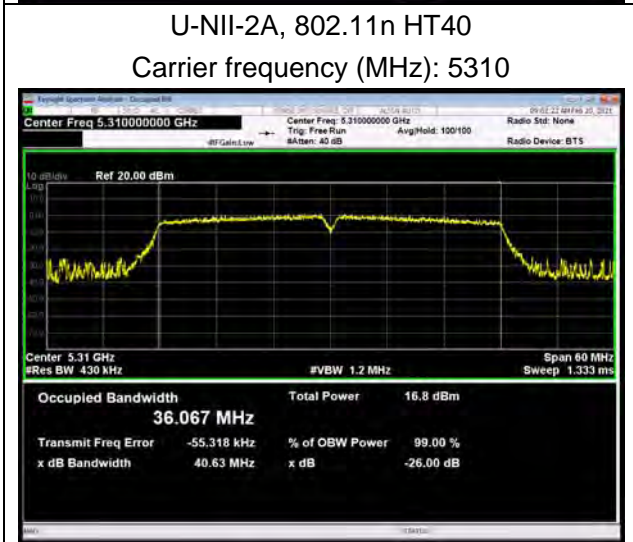
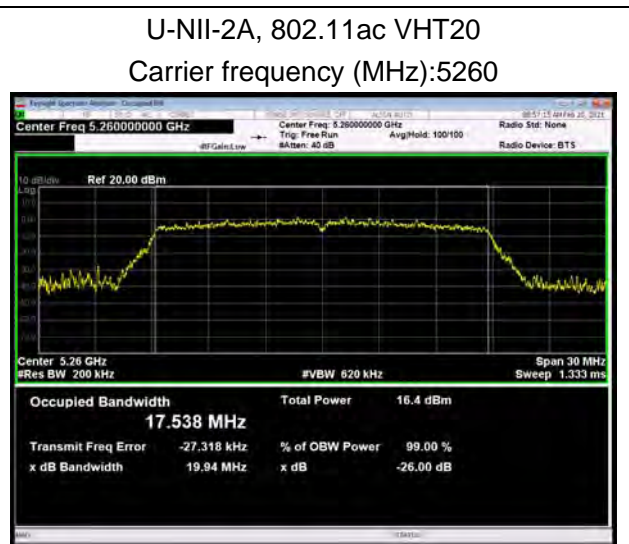
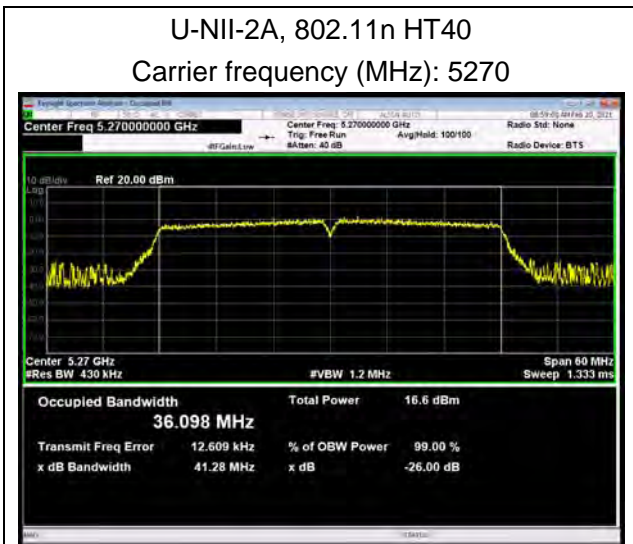
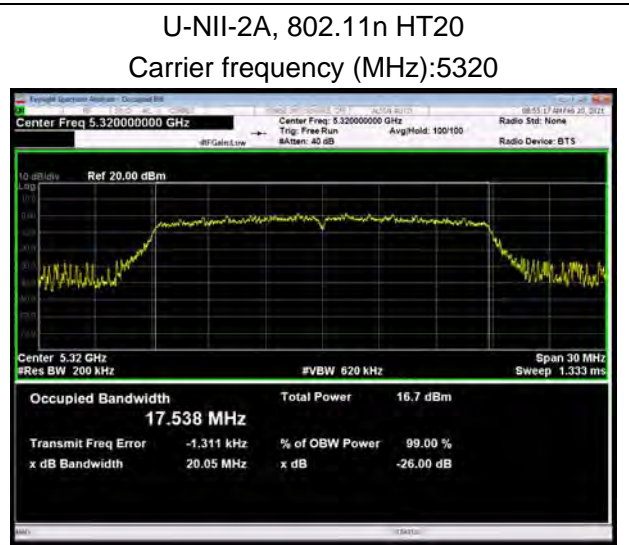
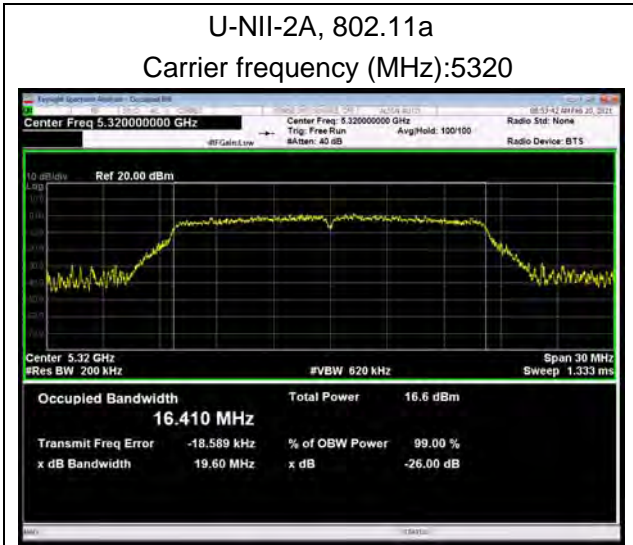

U-NII-2A, 802.11ac VHT40
Carrier frequency (MHz): 5270



U-NII-2A, 802.11ac VHT20
Carrier frequency (MHz): 5320



U-NII-2A, 802.11ac VHT40
Carrier frequency (MHz): 5310



U-NII-2A, 802.11ac VHT80
Carrier frequency (MHz): 5290



U-NII-2C, 802.11a
Carrier frequency (MHz): 5500



U-NII-2C, 802.11n HT20
Carrier frequency (MHz): 5500

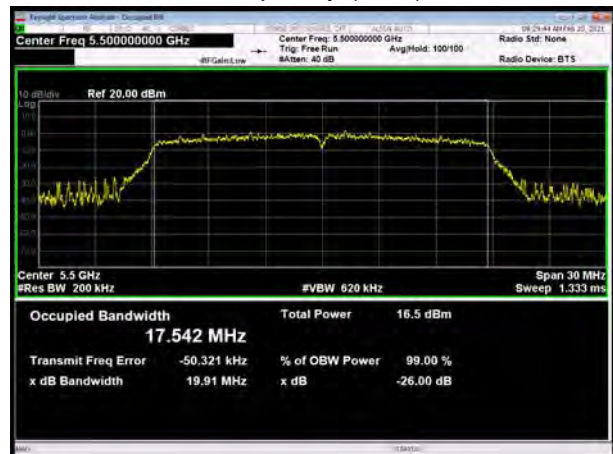

U-NII-2C, 802.11a
Carrier frequency (MHz): 5600

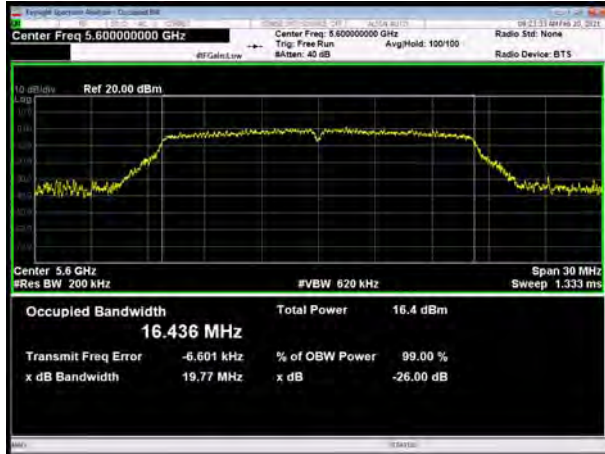

U-NII-2C, 802.11n HT20
Carrier frequency (MHz): 5600

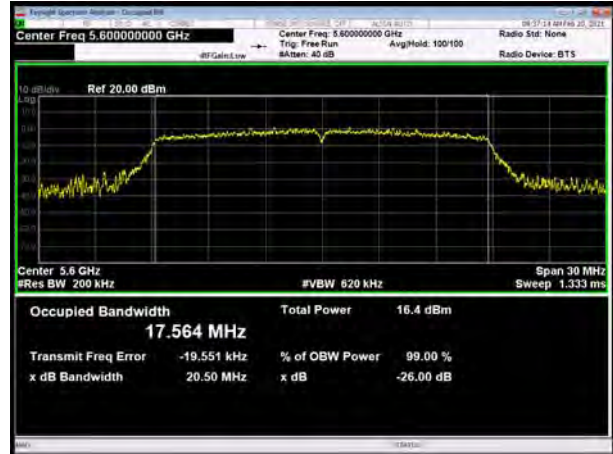

U-NII-2C, 802.11a
Carrier frequency (MHz): 5700



U-NII-2C, 802.11n HT20
Carrier frequency (MHz): 5700

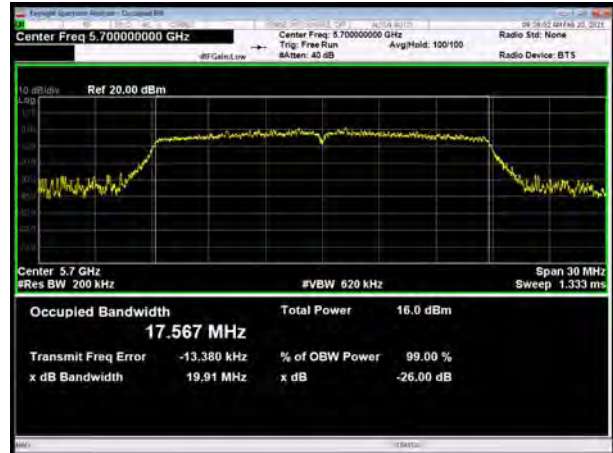

U-NII-2C, 802.11a
Carrier frequency (MHz): 5720



U-NII-2C, 802.11n HT20
Carrier frequency (MHz): 5720





U-NII-2C, 802.11n HT40
Carrier frequency (MHz): 5510



U-NII-2C, 802.11ac VHT20
Carrier frequency (MHz): 5500

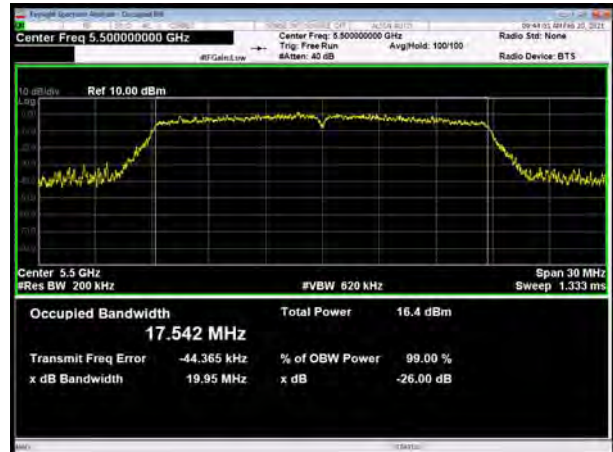

U-NII-2C, 802.11n HT40
Carrier frequency (MHz): 5590



U-NII-2C, 802.11ac VHT20
Carrier frequency (MHz): 5600

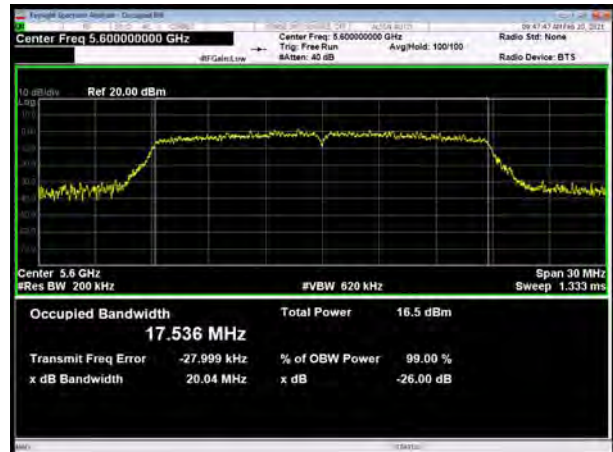

U-NII-2C, 802.11n HT40
Carrier frequency (MHz): 5670



U-NII-2C, 802.11ac VHT20
Carrier frequency (MHz): 5700



U-NII-2C, 802.11n HT40
Carrier frequency (MHz): 5710



U-NII-2C, 802.11ac VHT20
Carrier frequency (MHz): 5720

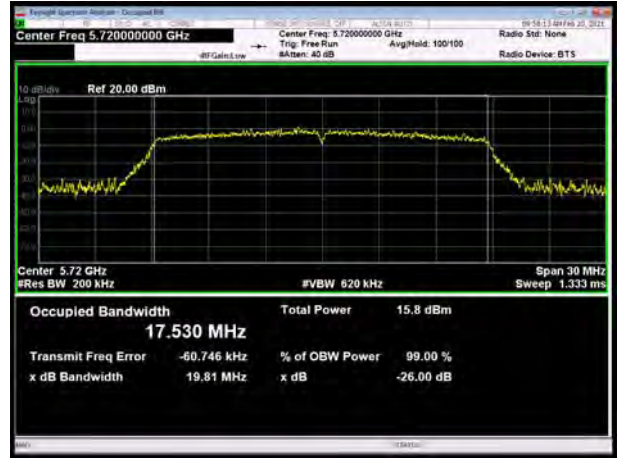

U-NII-2C, 802.11ac VHT40
Carrier frequency (MHz): 5510

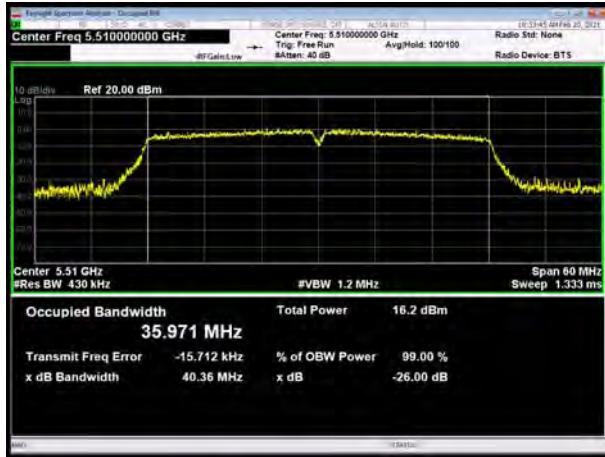

U-NII-2C, 802.11ac VHT80
Carrier frequency (MHz): 5530

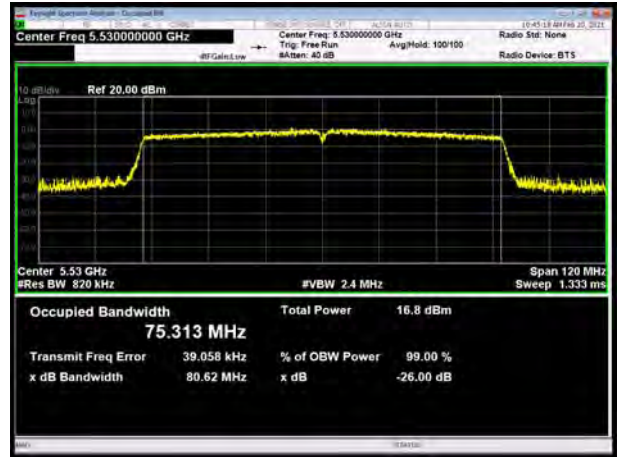

U-NII-2C, 802.11ac VHT40
Carrier frequency (MHz): 5590

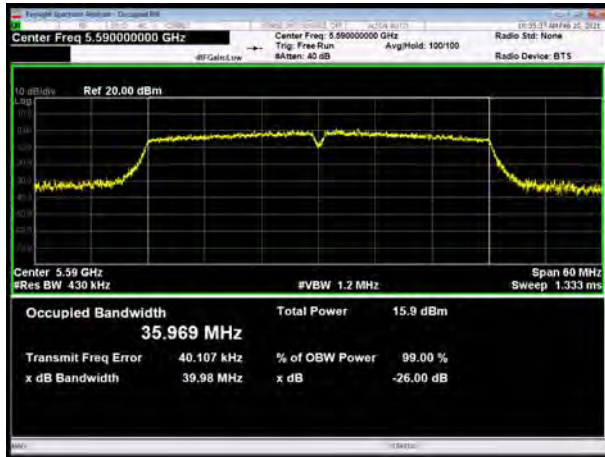

U-NII-2C, 802.11ac VHT80
Carrier frequency (MHz): 5610



U-NII-2C, 802.11ac VHT40
Carrier frequency (MHz): 5670



U-NII-2C, 802.11ac VHT80
Carrier frequency (MHz): 5690



U-NII-2C, 802.11ac VHT40
Carrier frequency (MHz): 5710



Minimum 6 dB bandwidth

U-NII-3, 802.11a
Carrier frequency (MHz): 5745



U-NII-3, 802.11n HT20
Carrier frequency (MHz): 5745



U-NII-3, 802.11a
Carrier frequency (MHz): 5785



U-NII-3, 802.11n HT20
Carrier frequency (MHz): 5785



U-NII-3, 802.11a
Carrier frequency (MHz): 5825

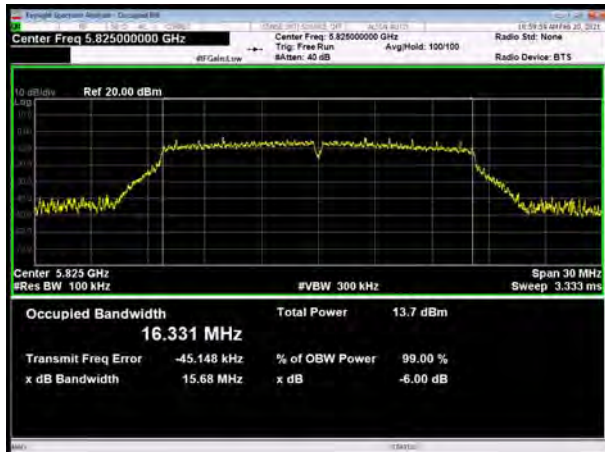

U-NII-3, 802.11n HT20
Carrier frequency (MHz): 5825

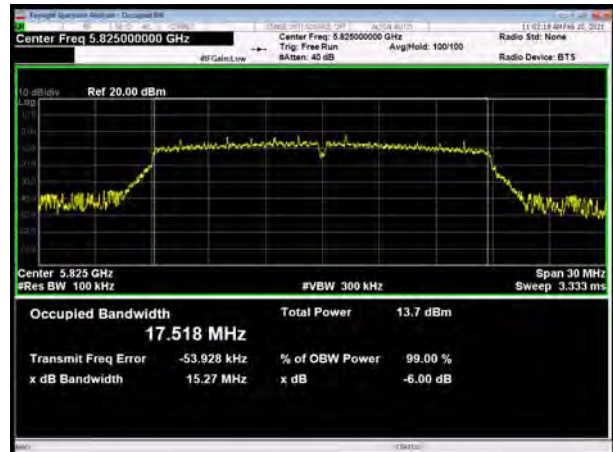

U-NII-3, 802.11n HT40
Carrier frequency (MHz): 5755



U-NII-3, 802.11ac VHT20
Carrier frequency (MHz): 5745



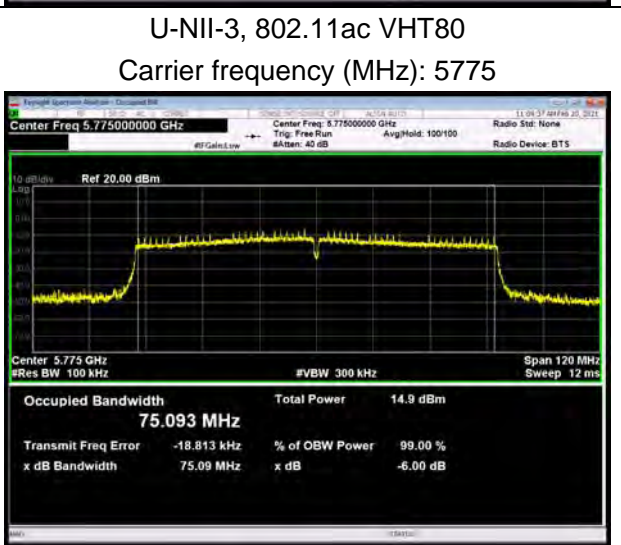
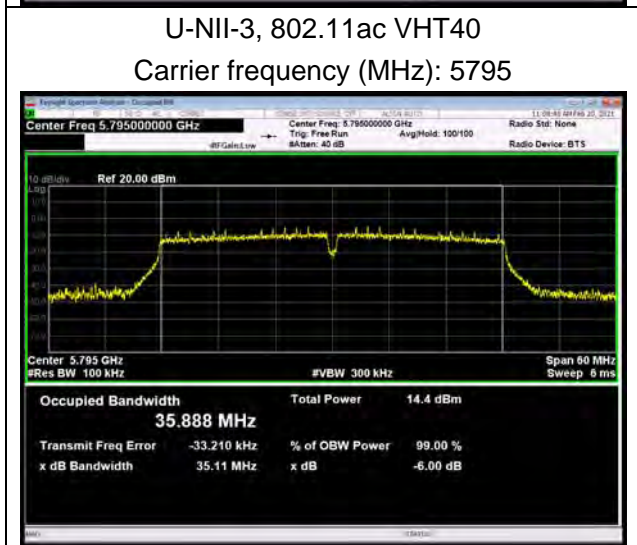
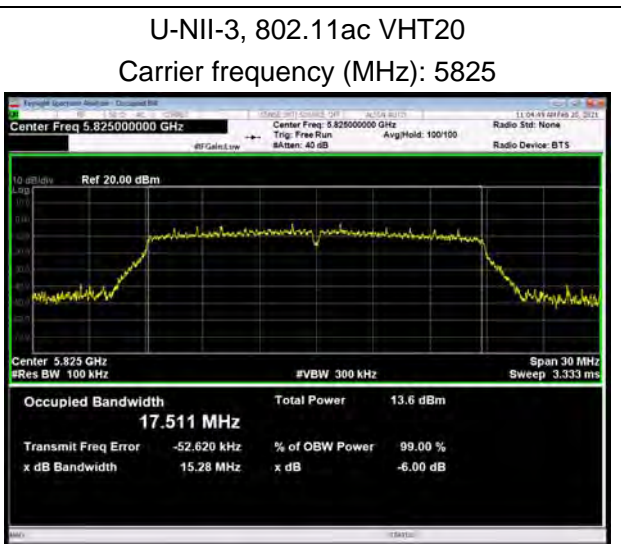
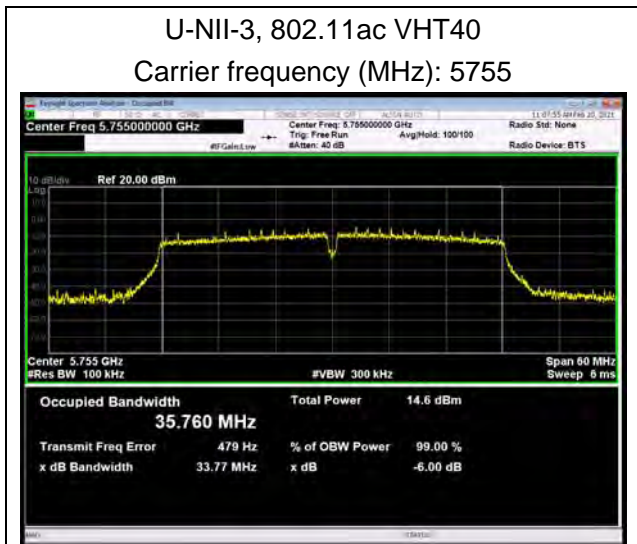
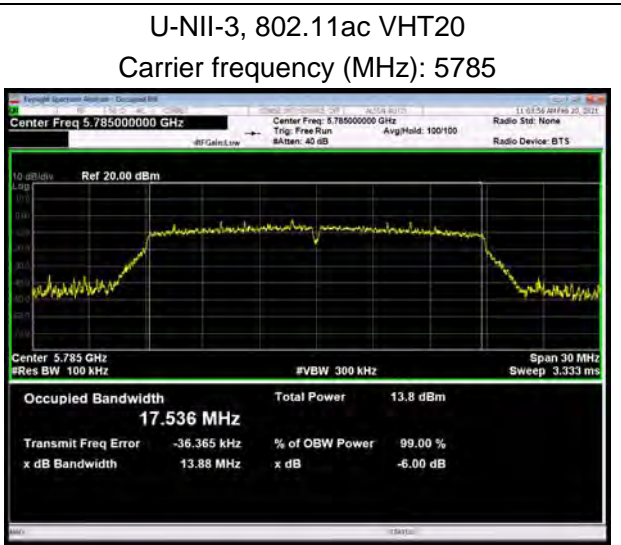
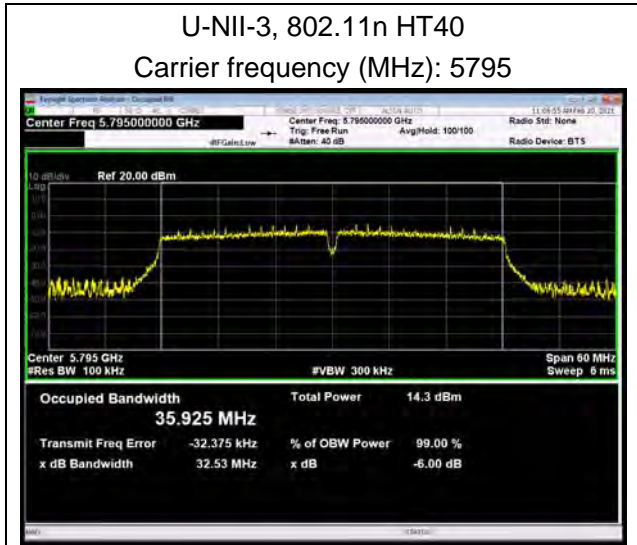



99% bandwidth

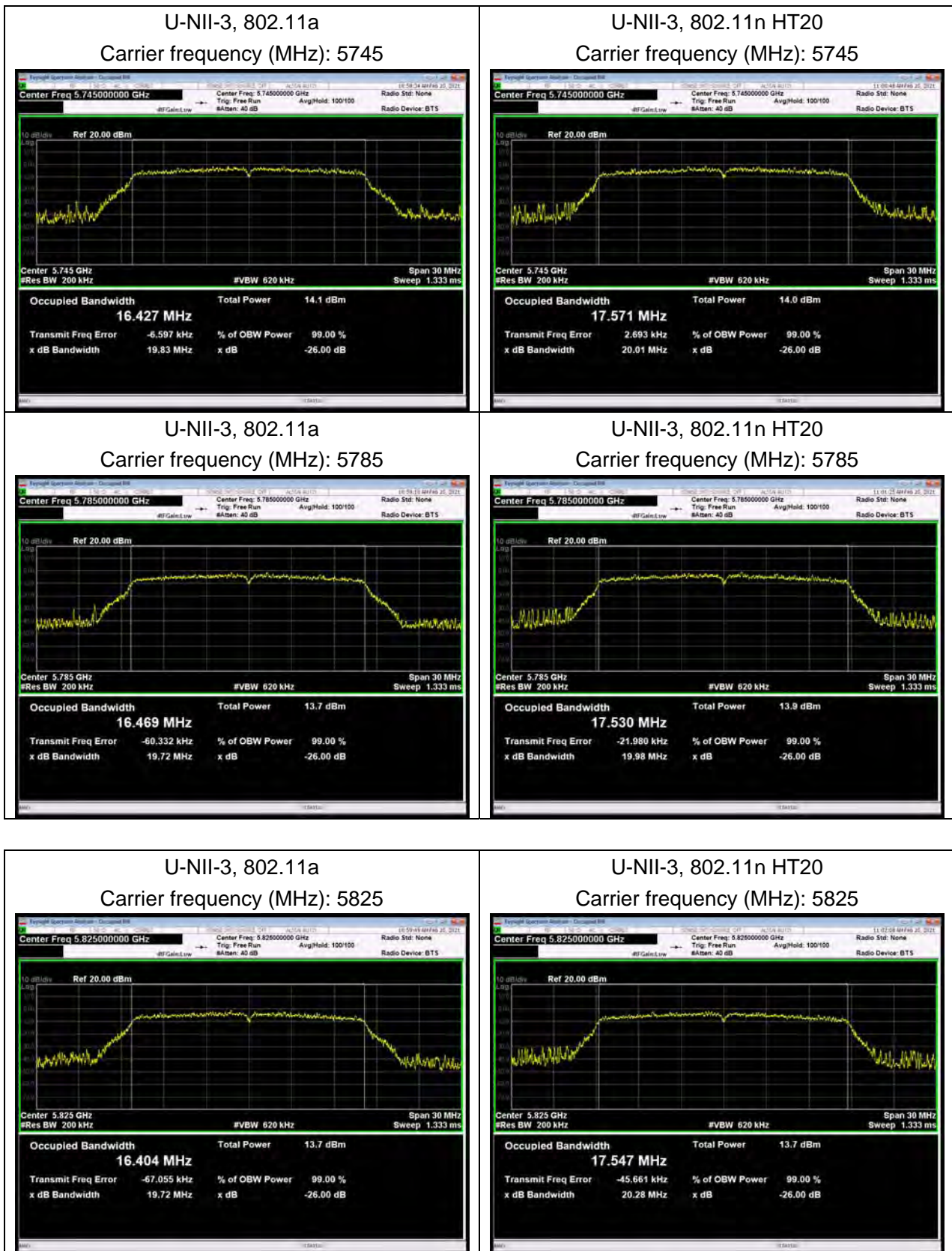

U-NII-3, 802.11n HT40
Carrier frequency (MHz): 5755

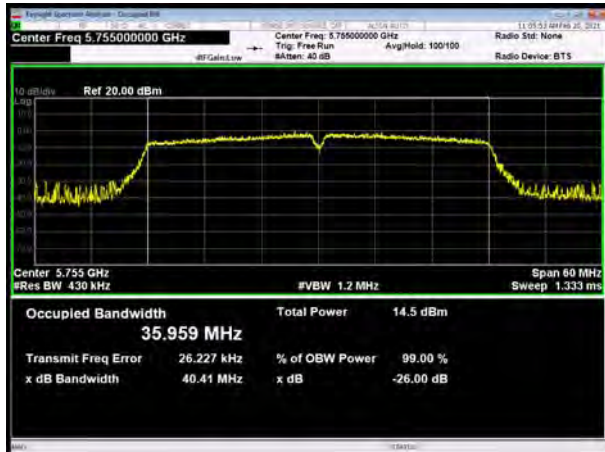

U-NII-3, 802.11ac VHT20
Carrier frequency (MHz): 5745



U-NII-3, 802.11n HT40
Carrier frequency (MHz): 5795



U-NII-3, 802.11ac VHT20
Carrier frequency (MHz): 5785



U-NII-3, 802.11ac VHT40
Carrier frequency (MHz): 5755



U-NII-3, 802.11ac VHT20
Carrier frequency (MHz): 5825





U-NII-3, 802.11ac VHT40
Carrier frequency (MHz): 5795

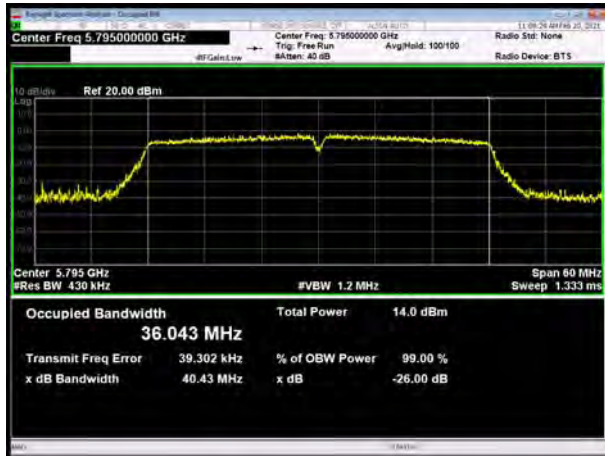

U-NII-3, 802.11ac VHT80
Carrier frequency (MHz): 5775

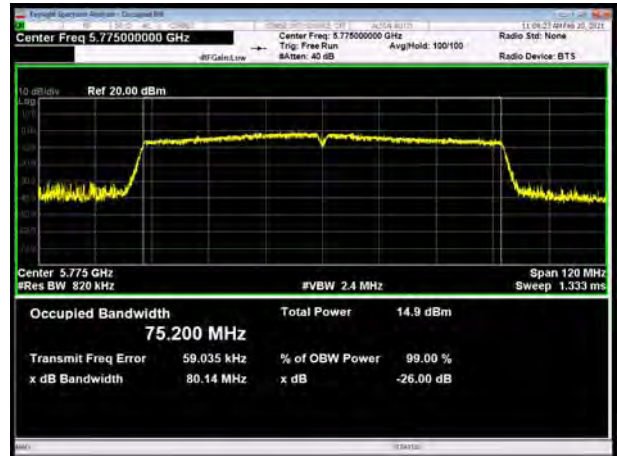

5.2. Average Power Output

Ambient condition

Temperature	Relative humidity	Pressure
23°C ~25°C	45%~50%	101.5kPa

Methods of Measurement

During the process of the testing, The EUT was connected to the average power meter through an external attenuator and a known loss cable. The EUT is max power transmission with proper modulation. We use Maximum average Conducted Output Power Level Method in KDB789033 for this test

Test Setup

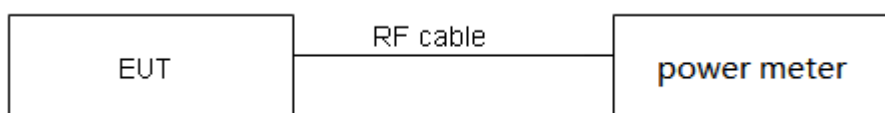

Limits

Rule FCC Part 15.407(a)(1)(2)(3)

(1) For the band 5.15-5.25 GHz.

(i) For an outdoor access point operating in the band 5.15-5.25 GHz, the maximum conducted output power over the frequency band of operation shall not exceed 1 W provided the maximum antenna gain does not exceed 6 dBi. In addition, the maximum power spectral density shall not exceed 17 dBm in any 1 megahertz band. If transmitting antennas of directional gain greater than 6 dBi are used, both the maximum conducted output power and the maximum power spectral density shall be reduced by the amount in dB that the directional gain of the antenna exceeds 6 dBi. The maximum e.i.r.p. at any elevation angle above 30 degrees as measured from the horizon must not exceed 125 mW (21 dBm).

(ii) For an indoor access point operating in the band 5.15-5.25 GHz, the maximum conducted output power over the frequency band of operation shall not exceed 1 W provided the maximum antenna gain does not exceed 6 dBi. In addition, the maximum power spectral density shall not exceed 17 dBm in any 1 megahertz band. If transmitting antennas of directional gain greater than 6 dBi are used, both the maximum conducted output power and the maximum power spectral density shall be reduced by the amount in dB that the directional gain of the antenna exceeds 6 dBi.

(iii) For fixed point-to-point access points operating in the band 5.15-5.25 GHz, the maximum conducted output power over the frequency band of operation shall not exceed 1 W. In addition, the maximum power spectral density shall not exceed 17 dBm in any 1 megahertz band. Fixed point-to-point U-NII devices may employ antennas with directional gain up to 23 dBi without any corresponding reduction in the maximum conducted output power or maximum power spectral density. For fixed point-to-point transmitters that employ a directional antenna gain greater than 23 dBi, a 1 dB reduction in maximum conducted output power and maximum power spectral density is required for each 1 dB of antenna gain in excess of 23 dBi. Fixed, point-to-point operations exclude



the use of point-to-multipoint systems, omnidirectional applications, and multiple collocated transmitters transmitting the same information. The operator of the U-NII device, or if the equipment is professionally installed, the installer, is responsible for ensuring that systems employing high gain directional antennas are used exclusively for fixed, point-to-point operations.

(iv) For client devices in the 5.15-5.25 GHz band, the maximum conducted output power over the frequency band of operation shall not exceed 250 mW provided the maximum antenna gain does not exceed 6 dBi. In addition, the maximum power spectral density shall not exceed 11 dBm in any 1 megahertz band. If transmitting antennas of directional gain greater than 6 dBi are used, both the maximum conducted output power and the maximum power spectral density shall be reduced by the amount in dB that the directional gain of the antenna exceeds 6 dBi.

(2) For the 5.25-5.35 GHz and 5.47-5.725 GHz bands, the maximum conducted output power over the frequency bands of operation shall not exceed the lesser of 250 mW or 11 dBm + 10 log B, where B is the 26 dB emission bandwidth in megahertz. In addition, the maximum power spectral density shall not exceed 11 dBm in any 1 megahertz band. If transmitting antennas of directional gain greater than 6 dBi are used, both the maximum conducted output power and the maximum power spectral density shall be reduced by the amount in dB that the directional gain of the antenna exceeds 6 dBi.

(3) For the band 5.725-5.85 GHz, the maximum conducted output power over the frequency band of operation shall not exceed 1 W. In addition, the maximum power spectral density shall not exceed 30 dBm in any 500-kHz band. If transmitting antennas of directional gain greater than 6 dBi are used, both the maximum conducted output power and the maximum power spectral density shall be reduced by the amount in dB that the directional gain of the antenna exceeds 6 dBi.

Measurement Uncertainty

The assessed measurement uncertainty to ensure 95% confidence level for the normal distribution is with the coverage factor $k = 2$, $U = 0.44$ dB.

Test Results

Mode	T _{on} (ms)	T _(on+off) (ms)	Duty cycle	Duty cycle correction Factor(dB)
802.11a	1.39	1.44	0.97	0.15
802.11n HT20	1.30	1.35	0.96	0.16
802.11n HT40	0.65	0.69	0.94	0.27
802.11ac VHT20	1.30	1.34	0.97	0.14
802.11ac VHT40	0.65	0.69	0.94	0.27
802.11ac VHT80	1.06	1.09	0.97	0.12

Note: when Duty cycle ≥ 0.98 , Duty cycle correction Factor not required.

Power Index								
Channel	802.11a	802.11n HT20	802.11ac VHT20	Channel	802.11n HT40	802.11ac VHT40	Channel	802.11ac VHT80
CH36	15	15	15	CH38	15	15	CH42	15
CH40	15	15	15	CH46	15	15	/	/
CH48	15	15	15	/	/	/	/	/
CH52	15	15	15	CH54	15	15	CH58	14
CH60	15	15	15	CH62	15	15	/	/
CH64	15	15	15	/	/	/	/	/
CH100	14.5	14	14.5	CH102	12	14.5	CH106	13
CH120	14.5	14.5	14.5	CH118	12	14.5	CH122	13
CH140	14.5	14.5	14.5	CH134	12	14.5	CH138	13
CH144	14.5	14.5	14.5	CH142	12	14.5	/	/
CH149	13.5	13.5	13.5	CH151	13.5	13.5	CH155	13.5
CH157	13.5	13.5	13.5	CH159	13.5	13.5	/	/
CH165	13.5	13.5	13.5	/	/	/	/	/



Network Standards		Channel/Frequency (MHz)	B=26 dB bandwidth (MHz)	Limit 11 dBm + 10 log B (dBm)	Final Limit(dBm)
U-NII-2A	802.11a	52/5260	19.75	23.96 < 24.00	23.96
		60/5300	19.66	23.94 < 24.00	23.94
		64/5320	19.60	23.92 < 24.00	23.92
	802.11n HT20	52/5260	19.87	23.98 < 24.00	23.98
		60/5300	19.98	24.01 > 24.00	24.00
		64/5320	20.05	24.02 > 24.00	24.00
	802.11n HT40	54/5270	41.28	27.16 > 24.00	24.00
		62/5310	40.63	27.09 > 24.00	24.00
	802.11ac VHT20	52/5260	19.94	24.00	24.00
		60/5300	19.90	23.99 < 24.00	23.99
		64/5320	20.00	24.01 > 24.00	24.00
802.11ac VHT40	54/5270	40.38	27.06 > 24.00	24.00	
	62/5310	40.56	27.08 > 24.00	24.00	
802.11ac VHT80	58/5290	80.01	30.03 > 24.00	24.00	
U-NII-2C	802.11a	100/5500	19.61	23.92 < 24.00	23.92
		120/5600	19.77	23.96 < 24.00	23.96
		140/5700	19.51	23.90 < 24.00	23.90
		144/5720	19.60	23.92 < 24.00	23.92
	802.11n HT20	100/5500	19.91	23.99 < 24.00	23.99
		120/5600	20.50	24.12 > 24.00	24.00
		140/5700	19.91	23.99 < 24.00	23.99
		144/5720	20.37	24.09 > 24.00	24.00
	802.11n HT40	102/5510	40.35	27.06 > 24.00	24.00
		118/5590	40.21	27.04 > 24.00	24.00
		134/5670	40.09	27.03 > 24.00	24.00
		142/5710	40.25	27.05 > 24.00	24.00
	802.11ac VHT20	100/5500	19.95	24.00	24.00
		120/5600	20.04	24.02 > 24.00	24.00
		140/5700	19.77	23.96 < 24.00	23.96
		144/5720	19.81	23.97 < 24.00	23.97
	802.11ac VHT40	102/5510	40.36	27.06 > 24.00	24.00
		118/5590	39.98	27.02 > 24.00	24.00
		134/5670	39.92	27.01 > 24.00	24.00
		142/5710	40.20	27.04 > 24.00	24.00
	802.11ac VHT80	106/5530	80.62	30.06 > 24.00	24.00
122/5610		80.40	30.05 > 24.00	24.00	
138/5690		80.28	30.05 > 24.00	24.00	

Note: 250mW=24dBm



Note: Average Power with duty factor = Average Power Measured +Duty cycle correction factor

U-NII-1

Network Standards	Channel/ Frequency (MHz)	Average Power Measured (dBm)	Average Power with duty factor (dBm)	Limit (dBm)	Conclusion
802.11a	36/5180	14.36	14.51	24	PASS
	40/5200	14.47	14.62	24	PASS
	48/5240	14.56	14.71	24	PASS
802.11n HT20	36/5180	14.49	14.65	24	PASS
	40/5200	14.42	14.58	24	PASS
	48/5240	14.55	14.71	24	PASS
802.11n HT40	38/5190	14.26	14.53	24	PASS
	46/5230	14.31	14.58	24	PASS
802.11ac VHT20	36/5180	14.48	14.62	24	PASS
	40/5200	14.42	14.56	24	PASS
	48/5240	14.38	14.52	24	PASS
802.11ac VHT40	38/5190	14.32	14.59	24	PASS
	46/5230	14.24	14.51	24	PASS
802.11ac VHT80	42/5210	13.96	14.08	24	PASS

Note: Average Power with duty factor = Average Power Measured +Duty cycle correction factor



U-NII-2A

Network Standards	Channel/ Frequency (MHz)	Average Power Measured (dBm)	Average Power with duty factor (dBm)	Limit (dBm)	Conclusion
802.11a	52/5260	14.52	14.67	23.96	PASS
	60/5300	14.68	14.83	23.94	PASS
	64/5320	14.79	14.94	23.92	PASS
802.11n HT20	52/5260	14.36	14.52	23.98	PASS
	60/5300	14.61	14.77	24.00	PASS
	64/5320	14.72	14.88	24.00	PASS
802.11n HT40	54/5270	14.24	14.51	24.00	PASS
	62/5310	14.29	14.56	24.00	PASS
802.11ac VHT20	52/5260	14.38	14.52	24.00	PASS
	60/5300	14.63	14.77	23.99	PASS
	64/5320	14.77	14.91	24.00	PASS
802.11ac VHT40	54/5270	14.35	14.62	24.00	PASS
	62/5310	14.32	14.59	24.00	PASS
802.11ac VHT80	58/5290	13.24	13.36	24.00	PASS

Note: Average Power with duty factor = Average Power Measured +Duty cycle correction factor

U-NII-2C

Network Standards	Channel/ Frequency (MHz)	Average Power Measured (dBm)	Average Power with duty factor (dBm)	Limit (dBm)	Conclusion
802.11a	100/5500	14.86	15.01	23.92	PASS
	120/5600	15.02	15.17	23.96	PASS
	140/5700	14.53	14.68	23.90	PASS
	144/5720	14.61	14.76	23.92	PASS
802.11n HT20	100/5500	14.04	14.20	23.99	PASS
	120/5600	14.98	15.14	24.00	PASS
	140/5700	14.47	14.63	23.99	PASS
	144/5720	14.53	14.69	24.00	PASS
802.11n HT40	102/5510	11.77	12.04	24.00	PASS
	118/5590	12.15	12.42	24.00	PASS
	134/5670	11.81	12.08	24.00	PASS
	142/5710	11.96	12.23	24.00	PASS
802.11ac VHT20	100/5500	14.55	14.69	24.00	PASS
	120/5600	14.96	15.10	24.00	PASS
	140/5700	14.61	14.75	23.96	PASS
	144/5720	14.53	14.67	23.97	PASS
802.11ac VHT40	102/5510	14.42	14.69	24.00	PASS
	118/5590	14.73	15.00	24.00	PASS
	134/5670	14.45	14.72	24.00	PASS
	142/5710	14.48	14.75	24.00	PASS
802.11ac VHT80	106/5530	12.58	12.70	24.00	PASS
	122/5610	12.72	12.84	24.00	PASS
	138/5690	12.61	12.73	24.00	PASS

Note: Average Power with duty factor = Average Power Measured +Duty cycle correction factor



U-NII-3

Network Standards	Channel/ Frequency (MHz)	Average Power Measured (dBm)	Average Power with duty factor (dBm)	Limit (dBm)	Conclusion
802.11a	149/5745	13.39	13.54	30	PASS
	157/5785	13.48	13.63	30	PASS
	165/5825	13.12	13.27	30	PASS
802.11n HT20	149/5745	13.32	13.48	30	PASS
	157/5785	13.40	13.56	30	PASS
	165/5825	13.14	13.30	30	PASS
802.11n HT40	151/5755	13.11	13.38	30	PASS
	159/5795	13.16	13.43	30	PASS
802.11ac VHT20	149/5745	13.41	13.55	30	PASS
	157/5785	13.53	13.67	30	PASS
	165/5825	13.21	13.35	30	PASS
802.11ac VHT40	151/5755	13.24	13.51	30	PASS
	159/5795	13.18	13.45	30	PASS
802.11ac VHT80	155/5775	13.18	13.30	30	PASS

Note: Average Power with duty factor = Average Power Measured +Duty cycle correction factor

5.3. Frequency Stability

Ambient condition

Temperature	Relative humidity	Pressure
23°C ~25°C	45%~50%	101.5kPa

Method of Measurement

1. Frequency stability with respect to ambient temperature

a) Supply the EUT with a nominal ac voltage or install a new or fully charged battery in the EUT. If possible, a dummy load shall be connected to the EUT because an antenna near the metallic walls of an environmental test chamber could affect the output frequency of the EUT. If the EUT is equipped with a permanently attached, adjustable-length antenna, then the EUT shall be placed in the center of the chamber with the antenna adjusted to the shortest length possible. Turn ON the EUT and tune it to one of the number of frequencies shown in 5.6.

b) Couple the unlicensed wireless device output to the measuring instrument by connecting an antenna to the measuring instrument with a suitable length of coaxial cable and placing the measuring antenna near the EUT (e.g., 15 cm away), or by connecting a dummy load to the measuring instrument, through an attenuator if necessary.

c) Adjust the location of the measurement antenna and the controls on the measurement instrument to obtain a suitable signal level (i.e., a level that will not overload the measurement instrument but is strong enough to allow measurement of the operating or fundamental frequency of the EUT).

d) Turn the EUT OFF and place it inside the environmental temperature chamber. For devices that have oscillator heaters, energize only the heater circuit.

e) Set the temperature control on the chamber to the highest specified in the regulatory requirements for the type of device and allow the oscillator heater and the chamber temperature to stabilize.

f) While maintaining a constant temperature inside the environmental chamber, turn the EUT ON and record the operating frequency at startup, and at 2 minutes, 5 minutes, and 10 minutes after the EUT is energized. Four measurements in total are made.

g) Measure the frequency at each of frequencies specified in 5.6.

h) Switch OFF the EUT but do not switch OFF the oscillator heater.

i) Lower the chamber temperature by not more than 10°C, and allow the temperature inside the chamber to stabilize.

j) Repeat step f) through step i) down to the lowest specified temperature.

2. Frequency stability when varying supply voltage

Unless otherwise specified, these tests shall be made at ambient room temperature (+15°C to +25 °C). An antenna shall be connected to the antenna output terminals of the EUT if possible. If the EUT is equipped with or uses an adjustable-length antenna, then it shall be fully extended.

a) Supply the EUT with nominal voltage or install a new or fully charged battery in the EUT. Turn ON the EUT and couple its output to a frequency counter or other frequency-measuring instrument.

b) Tune the EUT to one of the number of frequencies required in 5.6. Adjust the location of the



measurement antenna and the controls on the measurement instrument to obtain a suitable signal level (i.e., a level that will not overload the measurement instrument but is strong enough to allow measurement of the operating or fundamental frequency of the EUT).

- c) Measure the frequency at each of the frequencies specified in 5.6.
- d) Repeat the above procedure at 85% and 115% of the nominal supply voltage.

Limit

Manufacturers of U-NII devices are responsible for ensuring frequency stability such that an emission is maintained within the band of operation under all conditions of normal operation as specified in the users manual.

Measurement Uncertainty

The assessed measurement uncertainty to ensure 95% confidence level for the normal distribution is with the coverage factor $k = 2$, $U = 936\text{Hz}$

**Test Results**

Voltage (V)	Temperature (°C)	U-NII-1 Test Results			
		5200MHz			
		1min	2min	5min	10min
3.87	-20	5199.997034	5199.988808	5199.983272	5199.979157
3.87	-10	5200.003590	5199.982206	5199.980075	5199.977272
3.87	0	5199.997115	5199.980676	5199.973726	5199.970268
3.87	10	5199.996679	5199.978770	5199.964215	5199.967384
3.87	20	5199.988754	5199.973157	5199.955681	5199.960030
3.87	30	5199.984413	5199.969804	5199.949166	5199.950949
3.87	40	5199.977343	5199.969611	5199.949128	5199.942031
3.87	50	5199.975417	5199.963628	5199.940979	5199.942006
3.6	20	5199.970714	5199.958178	5199.932692	5199.937221
4.45	20	5199.961248	5199.950264	5199.923926	5199.928593
MHz		-0.038752	-0.049736	-0.076074	-0.071407
PPM		-7.452317	-9.564682	-14.629692	-13.732144

Voltage (V)	Temperature (°C)	U-NII-2A Test Results			
		5300MHz			
		1min	2min	5min	10min
3.87	-20	5299.992701	5299.983585	5299.974223	5299.971139
3.87	-10	5299.990989	5299.973739	5299.966401	5299.965819
3.87	0	5299.984639	5299.969953	5299.960833	5299.957417
3.87	10	5299.979519	5299.960124	5299.951710	5299.951767
3.87	20	5299.972478	5299.951533	5299.942082	5299.943675
3.87	30	5299.971818	5299.945263	5299.932426	5299.936974
3.87	40	5299.965393	5299.939409	5299.932275	5299.927819
3.87	50	5299.959687	5299.934673	5299.923644	5299.927502
3.6	20	5299.952069	5299.927232	5299.914121	5299.920621
4.45	20	5299.950459	5299.919169	5299.907296	5299.917295
MHz		-0.049541	-0.080831	-0.092704	-0.082705
PPM		-9.347396	-15.251157	-17.491267	-15.604712



Voltage (V)	Temperature (°C)	U-NII-2C Test Results			
		5580MHz			
		1min	2min	5min	10min
3.87	-20	5580.008955	5579.999148	5579.997412	5579.989099
3.87	-10	5580.004000	5579.997863	5579.996830	5579.983385
3.87	0	5580.000693	5579.989744	5579.987821	5579.975160
3.87	10	5579.991274	5579.981908	5579.985628	5579.969210
3.87	20	5579.984043	5579.974185	5579.982717	5579.961009
3.87	30	5579.975802	5579.968688	5579.972958	5579.953209
3.87	40	5579.974649	5579.967673	5579.965650	5579.948358
3.87	50	5579.966513	5579.961991	5579.965555	5579.945866
3.6	20	5579.965004	5579.958097	5579.956184	5579.940953
4.45	20	5579.961532	5579.948852	5579.947752	5579.931497
MHz		-0.038468	-0.051148	-0.052248	-0.068503
PPM		-6.893849	-9.166248	-9.363486	-12.276504

Voltage (V)	Temperature (°C)	U-NII-3 Test Results			
		5785MHz			
		1min	2min	5min	10min
3.87	-20	5785.003416	5785.000316	5784.995351	5784.988420
3.87	-10	5784.996057	5784.997592	5784.986951	5784.980281
3.87	0	5784.986577	5784.993457	5784.977458	5784.971850
3.87	10	5784.979452	5784.985104	5784.974830	5784.964585
3.87	20	5784.978168	5784.978410	5784.972776	5784.957000
3.87	30	5784.973881	5784.975146	5784.967440	5784.956346
3.87	40	5784.970389	5784.972796	5784.967160	5784.953837
3.87	50	5784.963000	5784.965663	5784.961299	5784.947928
3.6	20	5784.962560	5784.962153	5784.957906	5784.943467
4.45	20	5784.960903	5784.961168	5784.949715	5784.940706
MHz		-0.039097	-0.038832	-0.050285	-0.059294
PPM		-6.758369	-6.712464	-8.692243	-10.249544

5.4. Power Spectral Density

Ambient condition

Temperature	Relative humidity	Pressure
23°C ~25°C	45%~50%	101.5kPa

Method of Measurement

The EUT was connected to the spectrum analyzer through an external attenuator (20dB) and a known loss cable.

Set RBW = 1MHz, VBW =3MHz for the band 5.150-5.250GHz, 5.250-5.350GHz, 5.470-5.725GHz.

Set RBW = 470kHz, VBW =1.5MHz for the band 5.725-5.850GHz

The conducted PSD is measured at each antenna port. The measured results at the various antenna ports are then summed mathematically.

Test setup

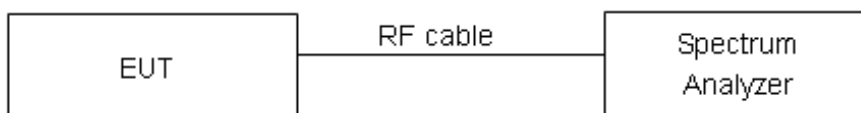

Limits

Rule FCC Part 15.407(a)(1)/ Part 15.407(a)(2) / Part 15.407(a)(3)

For client devices in the 5.15-5.25 GHz band, the maximum conducted output power over the frequency band of operation shall not exceed 250 mW provided the maximum antenna gain does not exceed 6 dBi. In addition, the maximum power spectral density shall not exceed 11 dBm in any 1 megahertz band. If transmitting antennas of directional gain greater than 6 dBi are used, both the maximum conducted output power and the maximum power spectral density shall be reduced by the amount in dB that the directional gain of the antenna exceeds 6 dBi.

For the 5.25-5.35 GHz and 5.47-5.725 GHz bands, the maximum power spectral density shall not exceed 11 dBm in any 1 megahertz band. If transmitting antennas of directional gain greater than 6 dBi are used, both the maximum conducted output power and the maximum power spectral density shall be reduced by the amount in dB that the directional gain of the antenna exceeds 6 dBi.

For the band 5.725-5.85 GHz, the maximum power spectral density shall not exceed 30 dBm in any 500kHz band. If transmitting antennas of directional gain greater than 6 dBi are used, both the maximum conducted output power and the maximum power spectral density shall be reduced by the amount in dB that the directional gain of the antenna exceeds 6 dBi.

Frequency Bands/MHz	Limits
5150-5250	11dBm/MHz
5.25-5.35 GHz and 5.47-5.725 GHz	11dBm/MHz
5725-5850	30dBm/500kHz

Measurement Uncertainty

The assessed measurement uncertainty to ensure 95% confidence level for the normal distribution is with the coverage factor $k = 2$, $U = 0.75\text{dB}$.

**Test Results:**

Note: Power Spectral Density =Read Value+Duty cycle correction factor

U-NII-1

Mode	Channel Number	Read Value (dBm /MHz)	Power Spectral Density (dBm /MHz)	Limit (dBm /MHz)	Conclusion
802.11a	36	5.09	5.24	11	PASS
	40	4.68	4.83	11	PASS
	48	5.54	5.69	11	PASS
802.11n HT20	36	4.94	5.09	11	PASS
	40	4.32	4.47	11	PASS
	48	4.78	4.94	11	PASS
802.11n HT40	38	2.14	2.41	11	PASS
	46	2.10	2.37	11	PASS
802.11ac VHT20	36	4.90	5.03	11	PASS
	40	4.24	4.38	11	PASS
	48	4.79	4.93	11	PASS
802.11ac VHT40	38	2.01	2.29	11	PASS
	46	2.04	2.31	11	PASS
802.11ac VHT80	42	-4.02	-3.89	11	PASS

U-NII-2A

Mode	Channel Number	Read Value (dBm /MHz)	Power Spectral Density (dBm /MHz)	Limit (dBm /MHz)	Conclusion
802.11a	52	4.66	4.81	11	PASS
	60	5.34	5.49	11	PASS
	64	4.61	4.76	11	PASS
802.11n HT20	52	4.29	4.45	11	PASS
	60	4.73	4.89	11	PASS
	64	4.33	4.49	11	PASS
802.11n HT40	54	1.29	1.56	11	PASS
	62	1.51	1.78	11	PASS
802.11ac VHT20	52	4.46	4.59	11	PASS
	60	4.78	4.92	11	PASS
	64	4.46	4.59	11	PASS



802.11ac VHT40	54	1.17	1.44	11	PASS
	62	1.05	1.32	11	PASS
802.11ac VHT80	58	-3.53	-3.41	11	PASS

U-NII-2C

Mode	Channel Number	Read Value (dBm /MHz)	Power Spectral Density (dBm /MHz)	Limit (dBm /MHz)	Conclusion
802.11a	100	4.72	4.86	11	PASS
	120	4.72	4.87	11	PASS
	140	3.92	4.07	11	PASS
	144	4.22	4.37	11	PASS
802.11n HT20	100	4.50	4.66	11	PASS
	120	4.82	4.97	11	PASS
	140	3.73	3.89	11	PASS
	144	3.72	3.88	11	PASS
802.11n HT40	102	-2.05	-1.77	11	PASS
	118	-2.17	-1.90	11	PASS
	134	-2.13	-1.85	11	PASS
	142	-2.37	-2.10	11	PASS
802.11ac VHT20	100	4.62	4.75	11	PASS
	120	4.40	4.54	11	PASS
	140	3.80	3.94	11	PASS
	144	3.77	3.91	11	PASS
802.11ac VHT40	102	1.03	1.30	11	PASS
	118	0.92	1.19	11	PASS
	134	1.30	1.58	11	PASS
	142	1.22	1.49	11	PASS
802.11ac VHT80	106	-2.31	-2.19	11	PASS
	122	-1.98	-1.85	11	PASS
	138	-2.91	-2.78	11	PASS



U-NII-3

Mode	Channel Number	Read Value (dBm/470kHz)	Power Spectral Density (dBm/500kHz)	Limit (dBm/500kHz)	Conclusion
802.11a	149	-1.03	-0.61	30	PASS
	157	-1.39	-0.97	30	PASS
	165	-1.44	-1.02	30	PASS
802.11n HT20	149	-1.31	-0.88	30	PASS
	157	-1.55	-1.13	30	PASS
	165	-1.96	-1.54	30	PASS
802.11n HT40	151	-3.70	-3.15	30	PASS
	159	-4.72	-4.18	30	PASS
802.11ac VHT20	149	-1.35	-0.94	30	PASS
	157	-1.08	-0.67	30	PASS
	165	-1.97	-1.56	30	PASS
802.11ac VHT40	151	-4.19	-3.64	30	PASS
	159	-4.65	-4.11	30	PASS
802.11ac VHT80	155	-6.81	-6.42	30	PASS

Note: PSD=Read Value+Duty cycle+10*LOG(500/470) correction factor

U-NII-1, 802.11a, Channel No.: 36

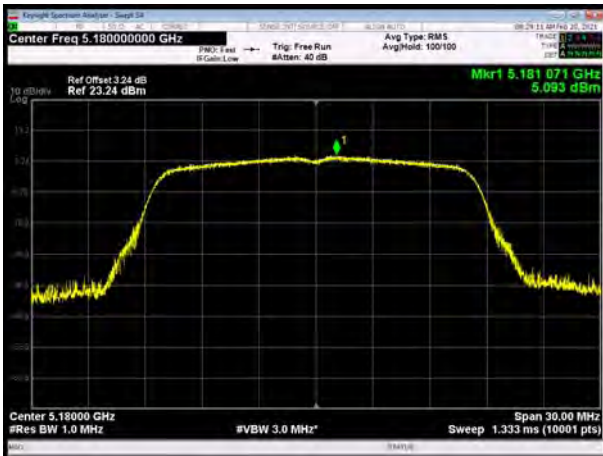

U-NII-1, 802.11n HT20, Channel No.: 36

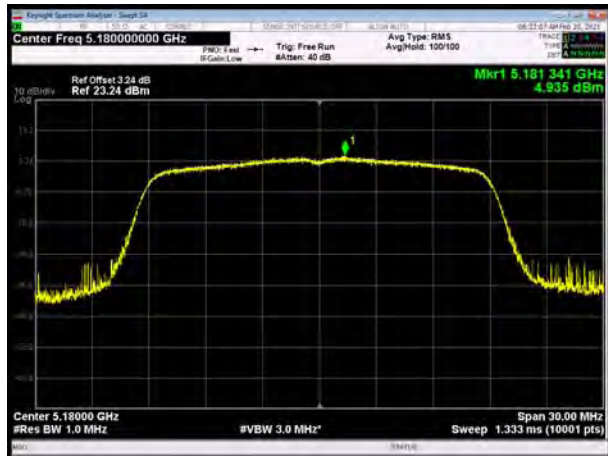

U-NII-1, 802.11a, Channel No.: 40

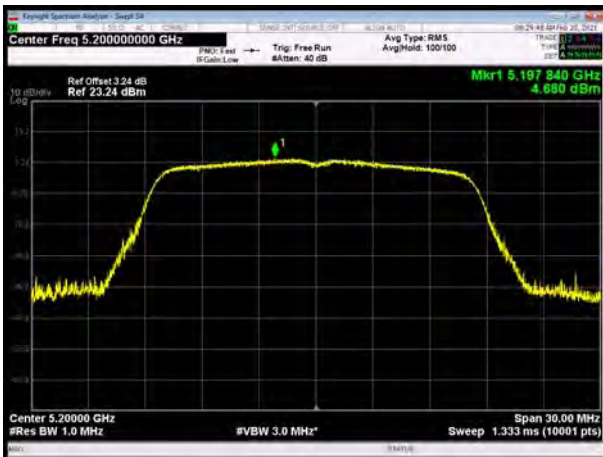

U-NII-1, 802.11n HT20, Channel No.: 40

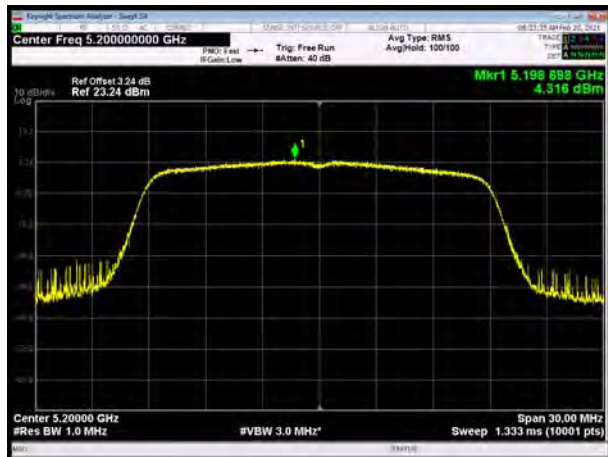

U-NII-1, 802.11a, Channel No.: 48

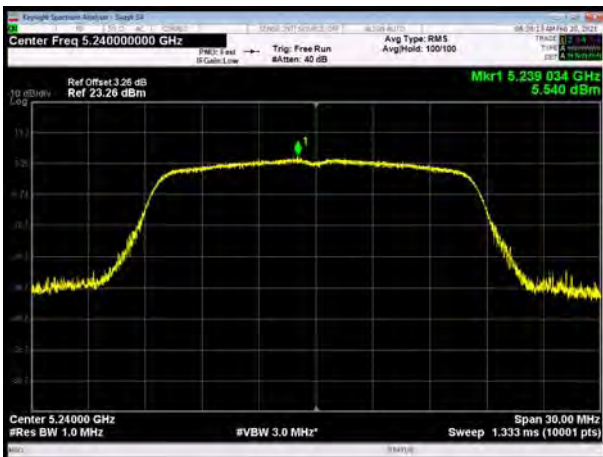

U-NII-1, 802.11n HT20, Channel No.: 48

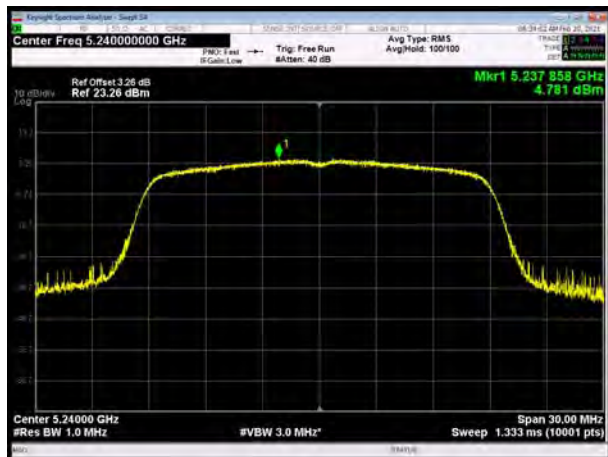

U-NII-1, 802.11n HT40, Channel No.: 38

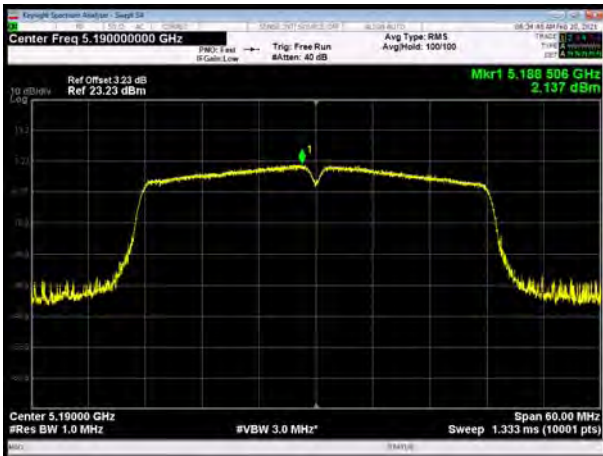

U-NII-1, 802.11ac VHT20, Channel No.: 36

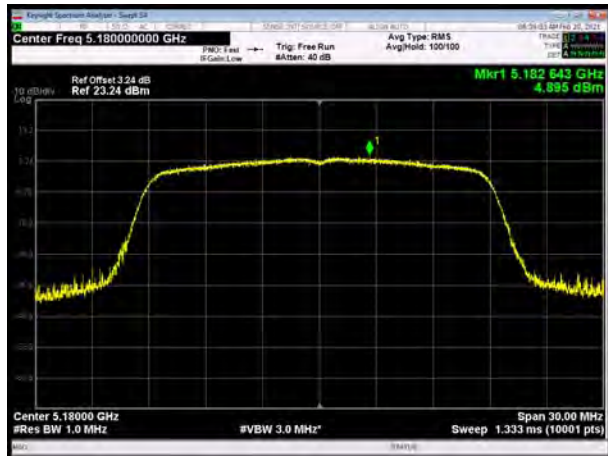

U-NII-1, 802.11n HT40, Channel No.: 46

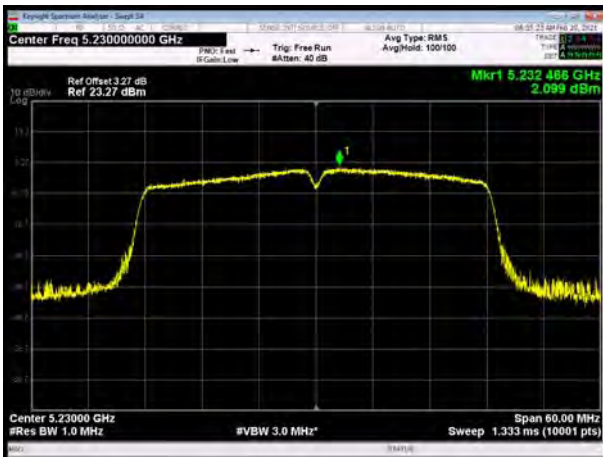

U-NII-1, 802.11ac VHT20, Channel No.: 40

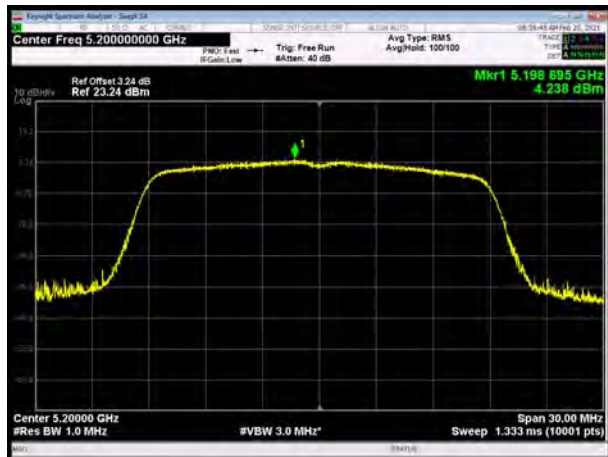

U-NII-1, 802.11ac VHT40, Channel No.: 38

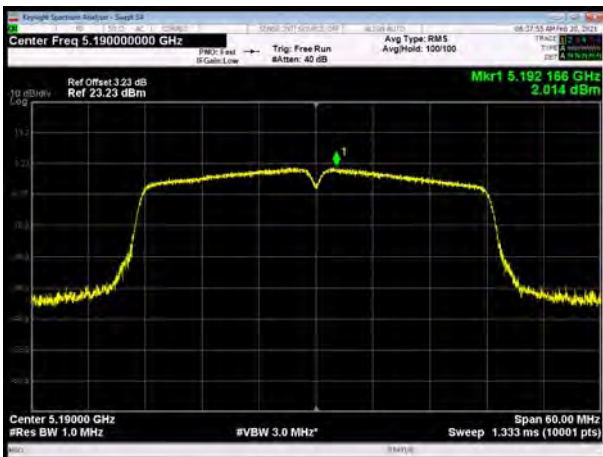

U-NII-1, 802.11ac VHT20, Channel No.: 48

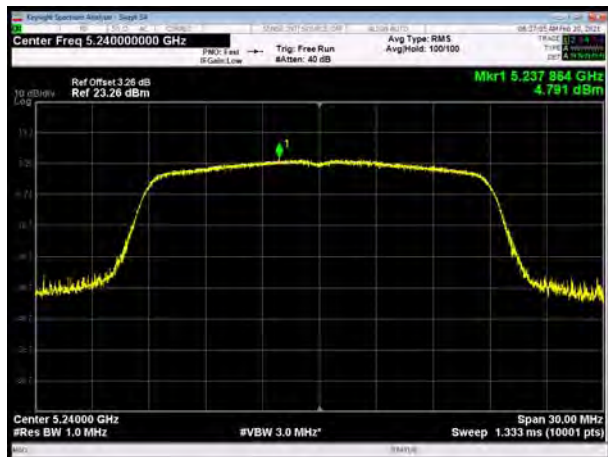



U-NII-1, 802.11ac VHT40, Channel No.: 46

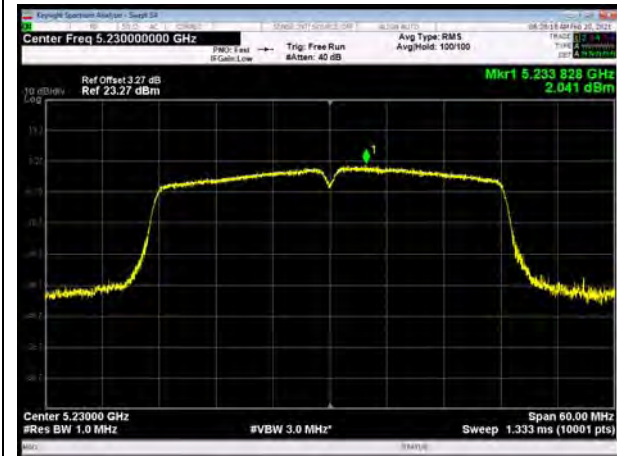

U-NII-1, 802.11ac VHT80, Channel No.: 42



U-NII-2A, 802.11a, Channel No.: 52

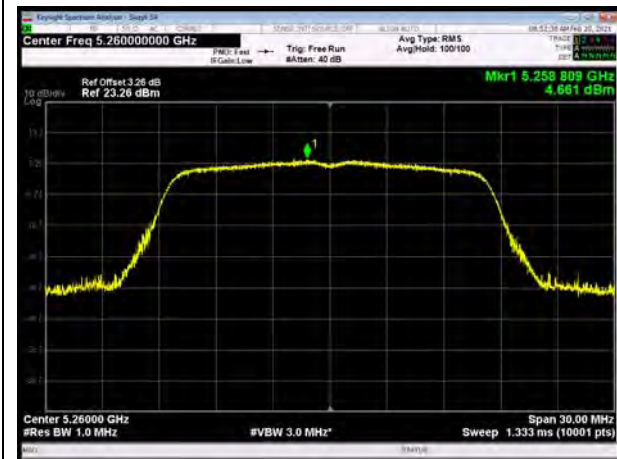

U-NII-2A, 802.11n HT20, Channel No.: 52

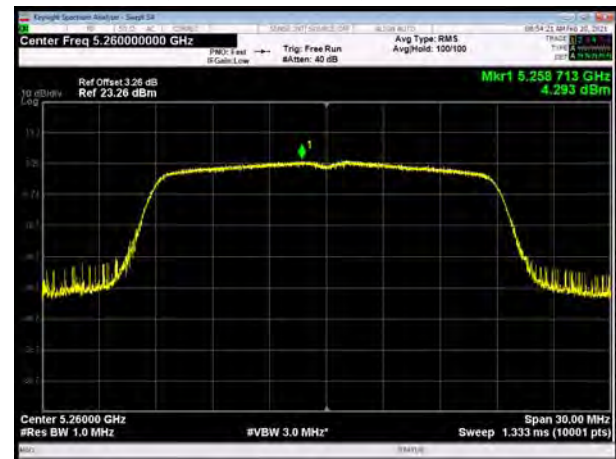

U-NII-2A, 802.11a, Channel No.: 60

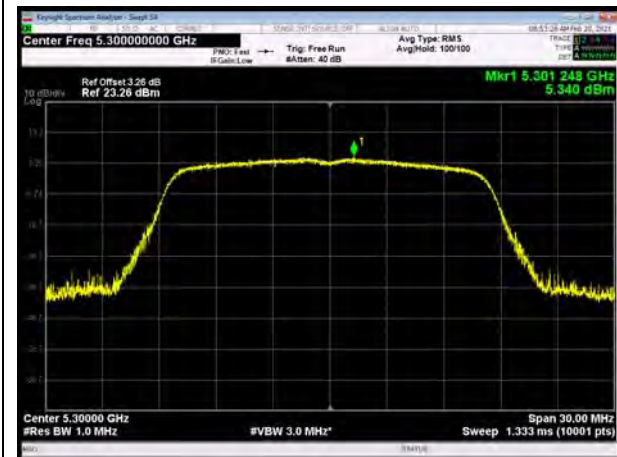

U-NII-2A, 802.11n HT20, Channel No.: 60

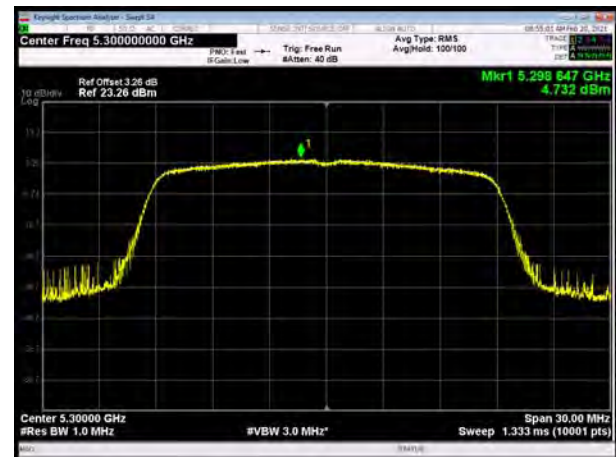



U-NII-2A, 802.11a, Channel No.: 64

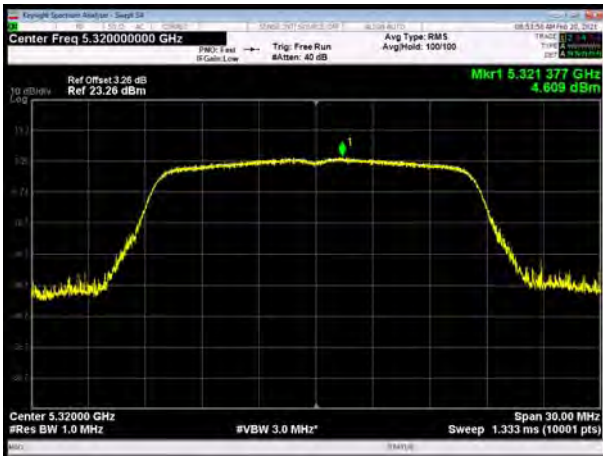

U-NII-2A, 802.11n HT20, Channel No.: 64

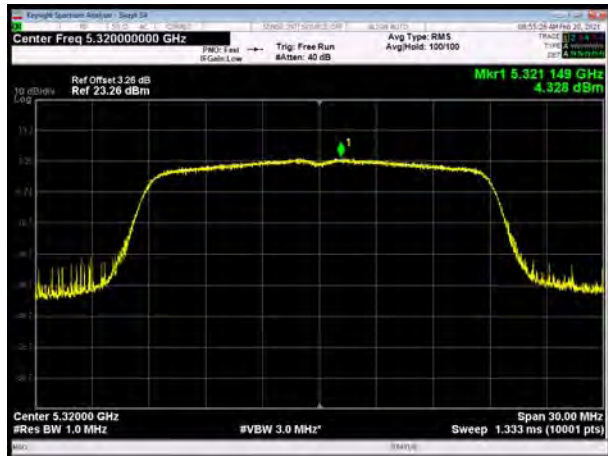

U-NII-2A, 802.11n HT40, Channel No.: 54

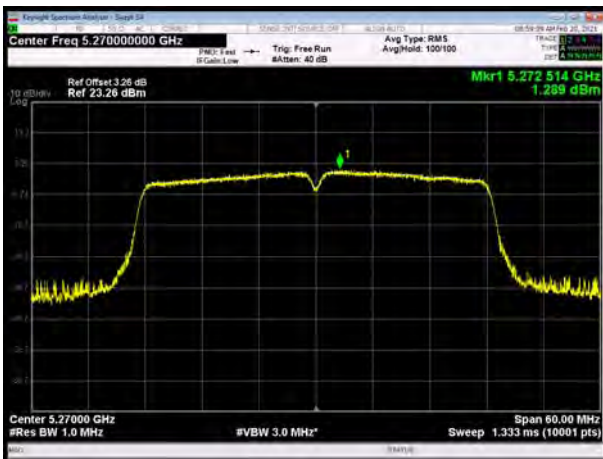

U-NII-2A, 802.11ac VHT20, Channel No.: 52

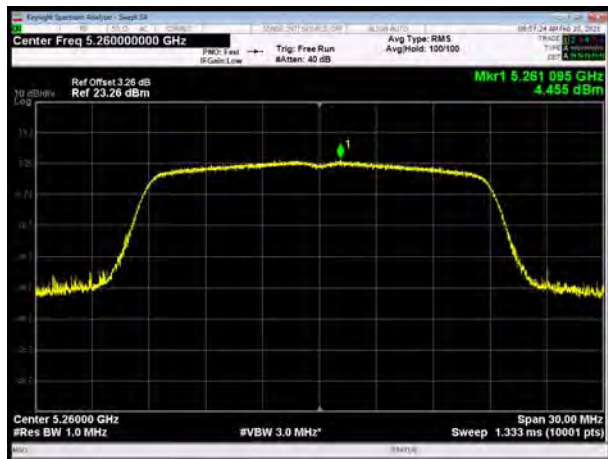

U-NII-2A, 802.11n HT40, Channel No.: 62

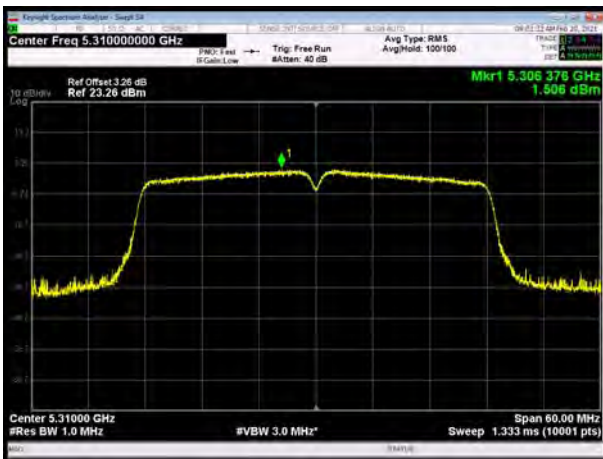

U-NII-2A, 802.11ac VHT20, Channel No.: 60

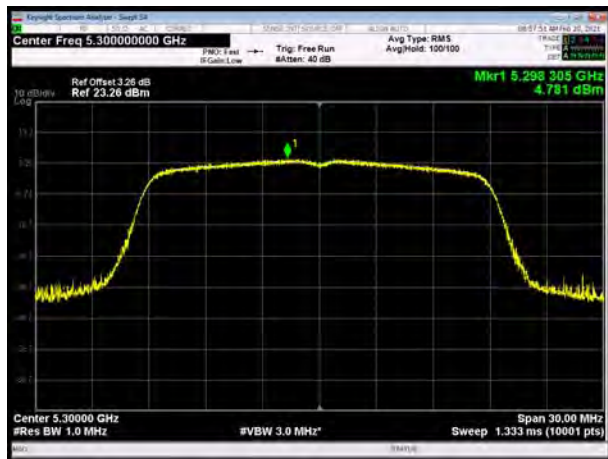

U-NII-2A, 802.11ac VHT40, Channel No.: 54

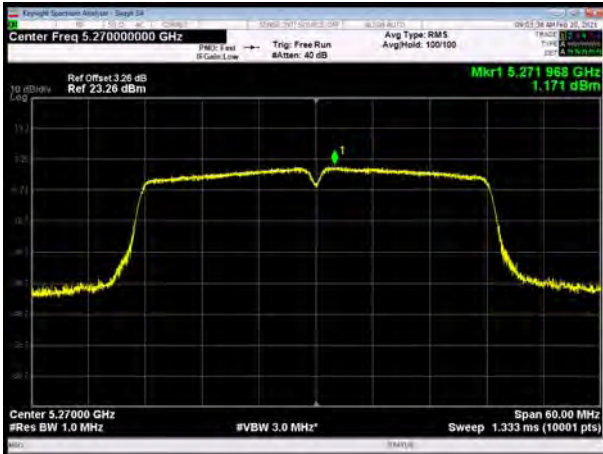

U-NII-2A, 802.11ac VHT20, Channel No.: 64

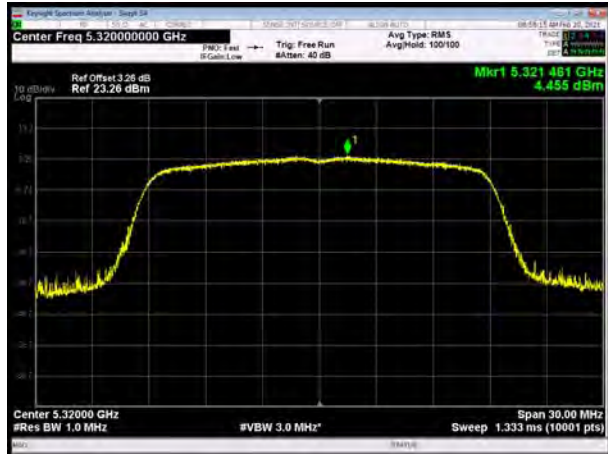

U-NII-2A, 802.11ac VHT40, Channel No.: 62

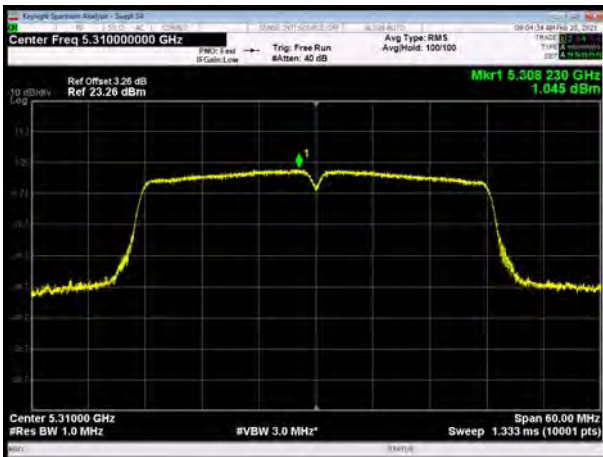

U-NII-2A, 802.11ac VHT80, Channel No.: 58

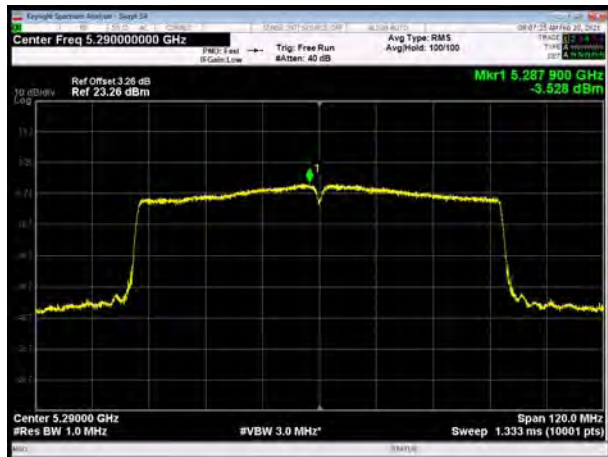

U-NII-2C, 802.11a, Channel No.: 100

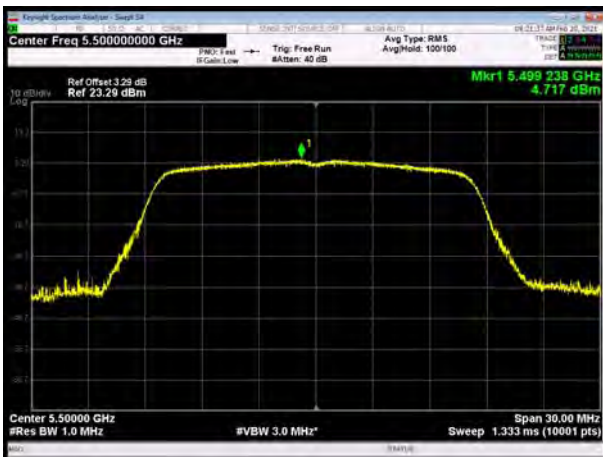

U-NII-2C, 802.11n HT20, Channel No.: 100

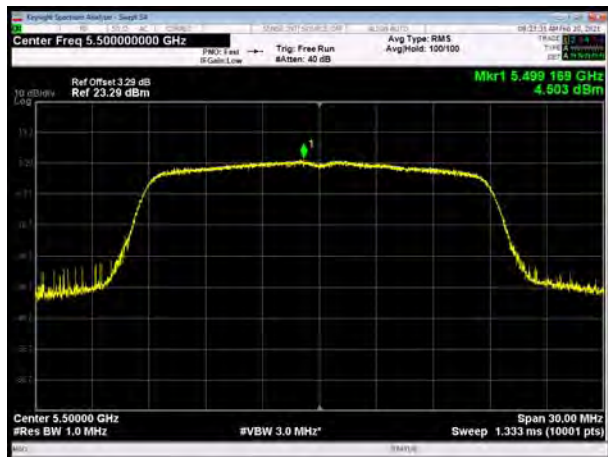



U-NII-2C, 802.11a, Channel No.: 120

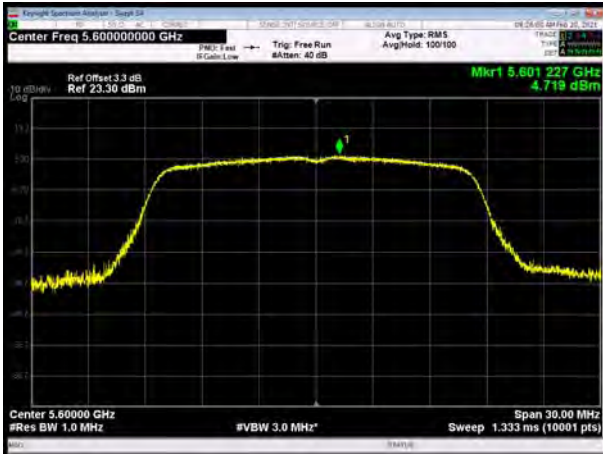

U-NII-2C, 802.11n HT20, Channel No.: 120

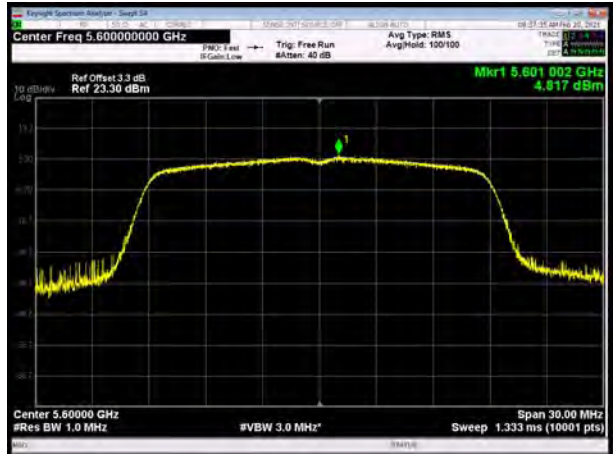

U-NII-2C, 802.11a, Channel No.: 140

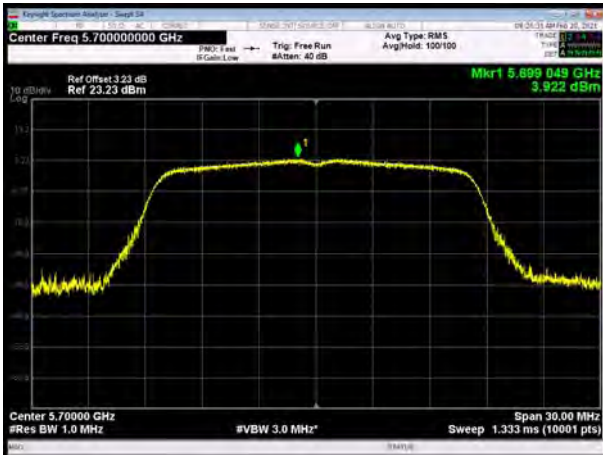

U-NII-2C, 802.11n HT20, Channel No.: 140

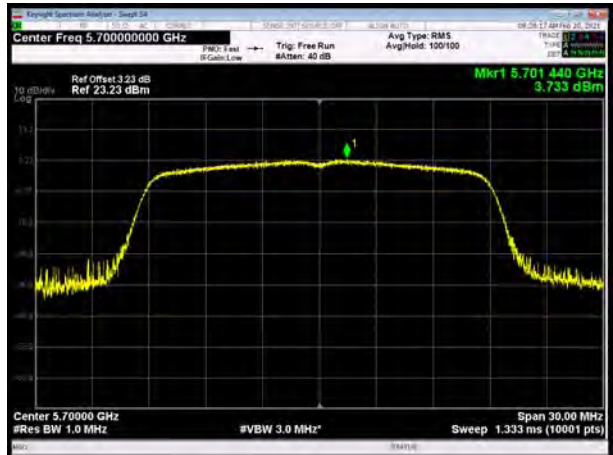

U-NII-2C, 802.11a, Channel No.: 144

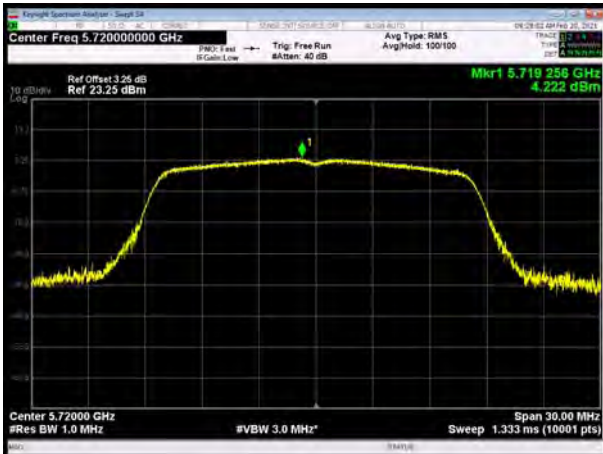

U-NII-2C, 802.11n HT20, Channel No.: 144

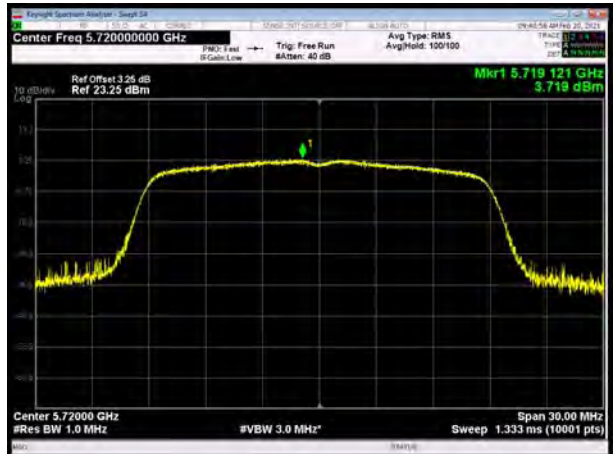

U-NII-2C, 802.11n HT40, Channel No.: 102

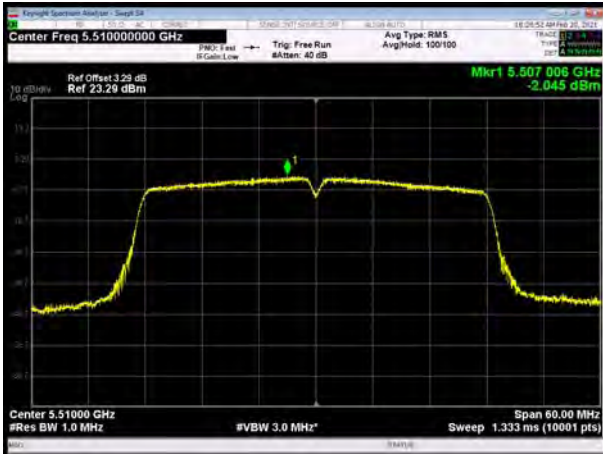

U-NII-2C, 802.11ac VHT20, Channel No.: 100

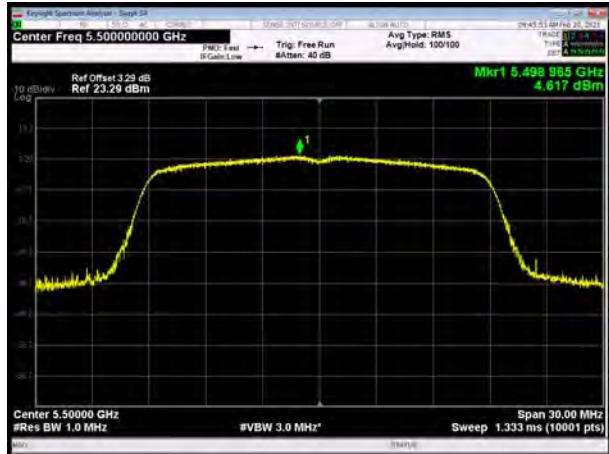

U-NII-2C, 802.11n HT40, Channel No.: 118

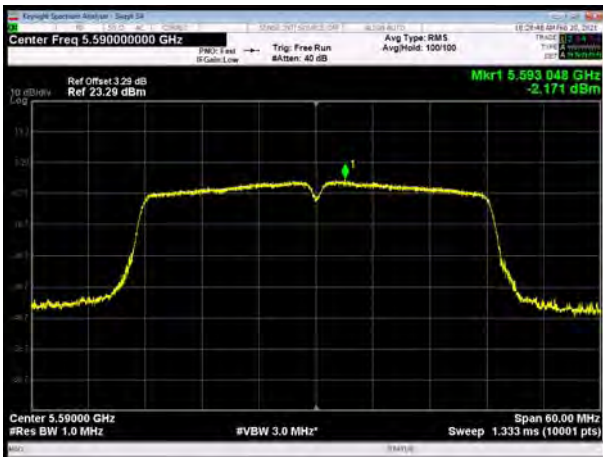

U-NII-2C, 802.11ac VHT20, Channel No.: 120

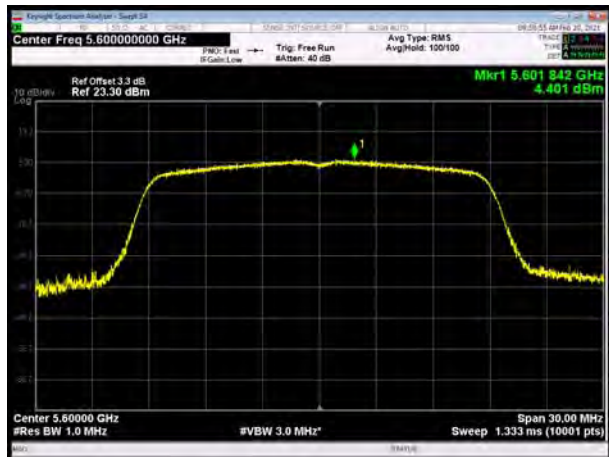

U-NII-2C, 802.11n HT40, Channel No.: 134

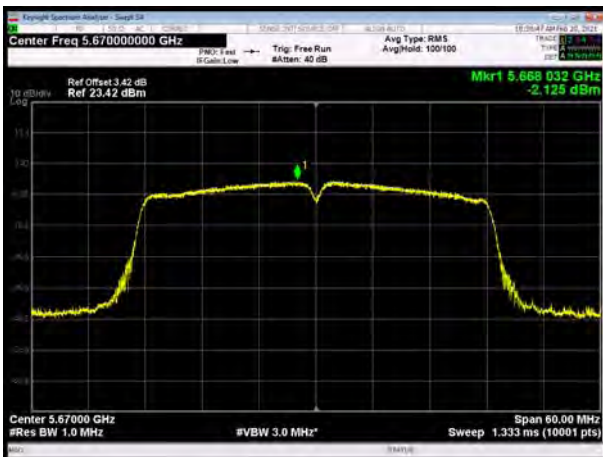

U-NII-2C, 802.11ac VHT20, Channel No.: 140

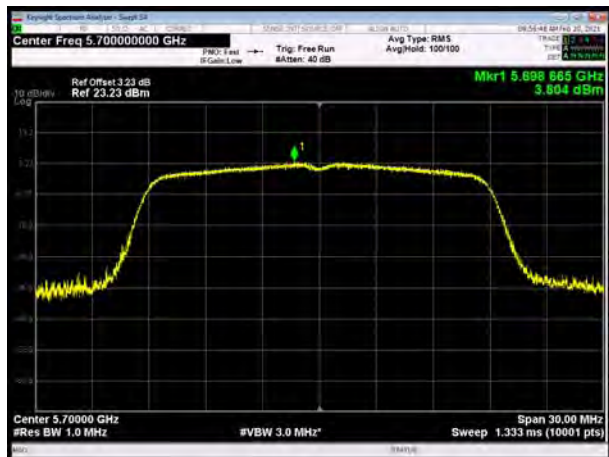

U-NII-2C, 802.11n HT40, Channel No.: 142

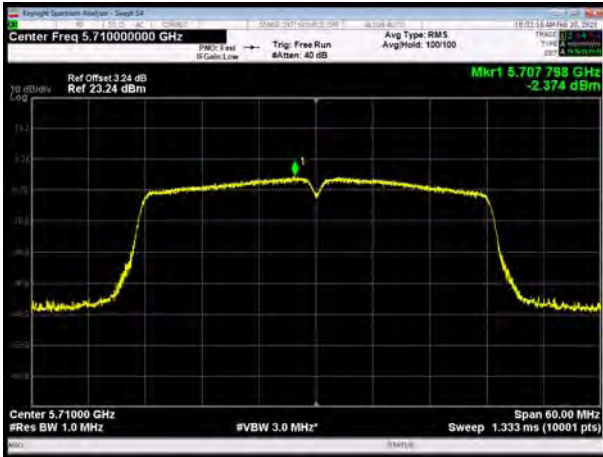

U-NII-2C, 802.11ac VHT20, Channel No.: 144

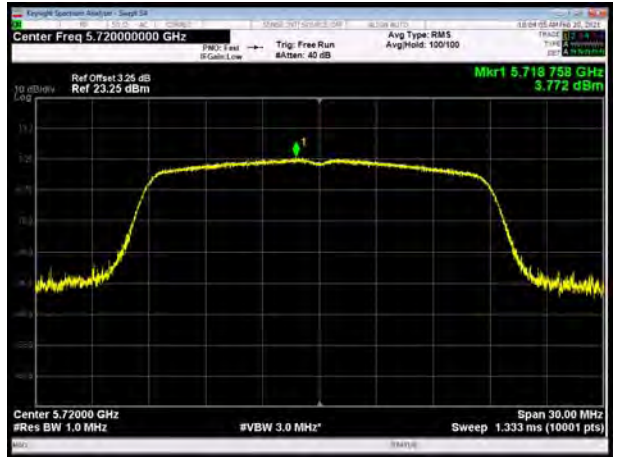

U-NII-2C, 802.11ac VHT40, Channel No.: 102



U-NII-2C, 802.11ac VHT80, Channel No.: 106

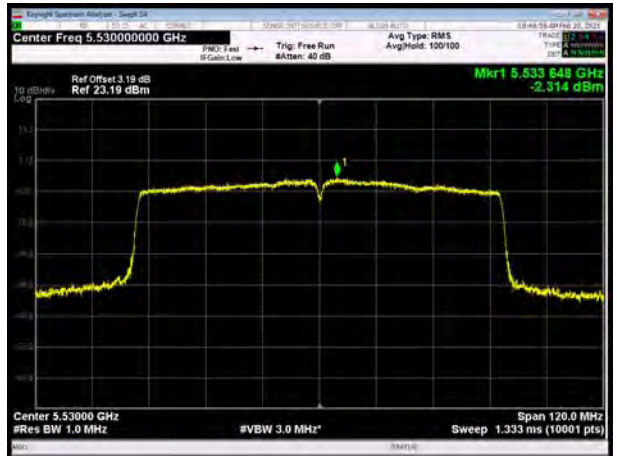

U-NII-2C, 802.11ac VHT40, Channel No.: 118

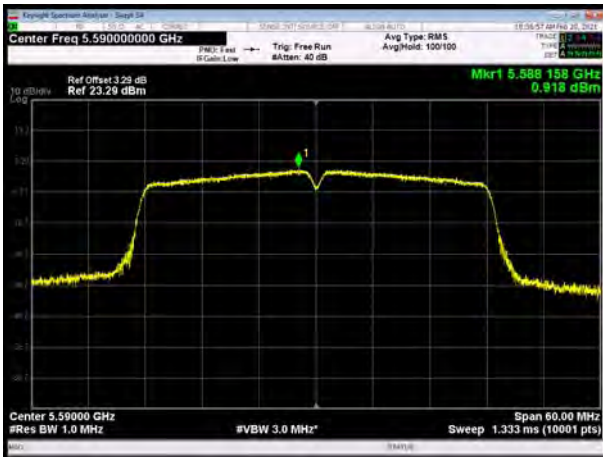

U-NII-2C, 802.11ac VHT80, Channel No.: 122

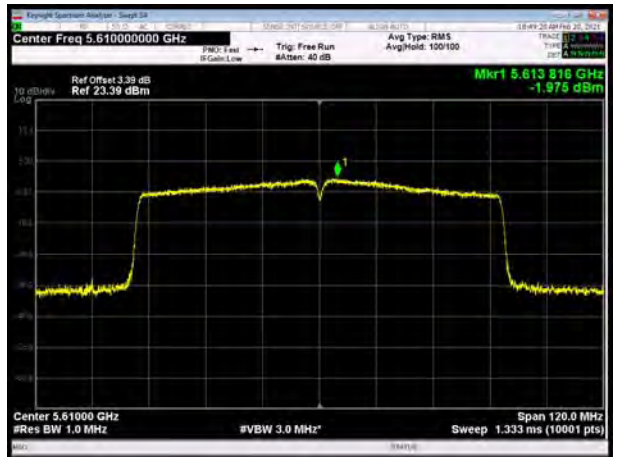

U-NII-2C, 802.11ac VHT40, Channel No.: 134

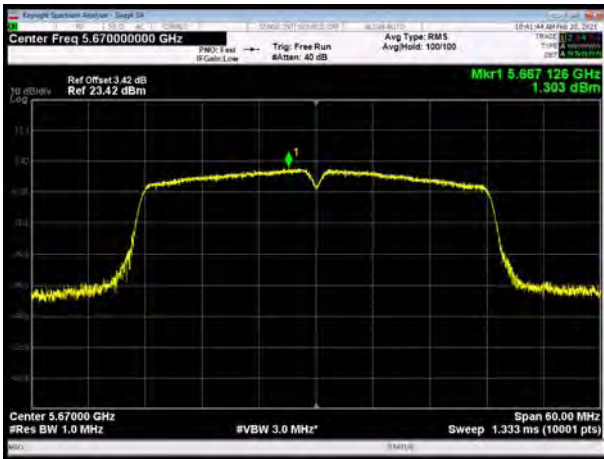

U-NII-2C, 802.11ac VHT80, Channel No.: 138

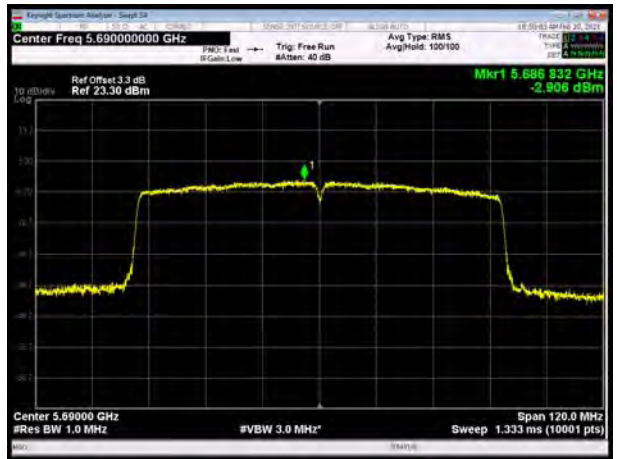

U-NII-2C, 802.11ac VHT40, Channel No.: 142

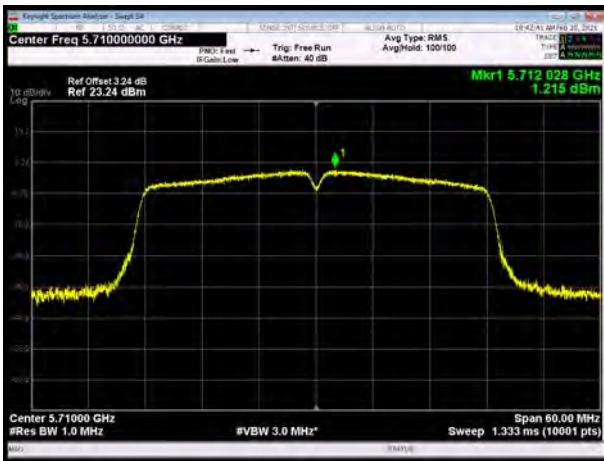

U-NII-3, 802.11a, Channel No.: 149



U-NII-3, 802.11n HT20, Channel No.: 149

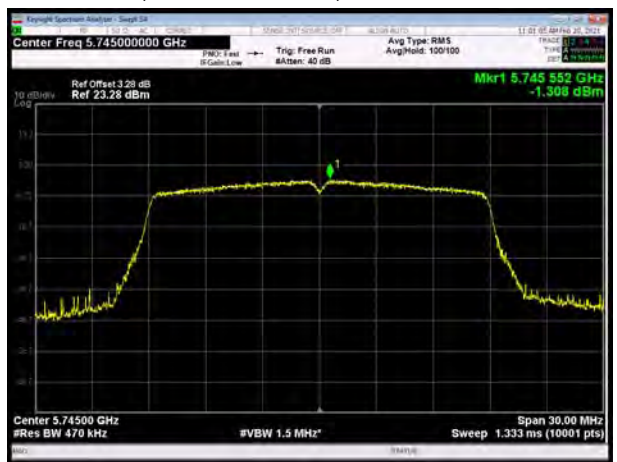

U-NII-3, 802.11a, Channel No.: 157

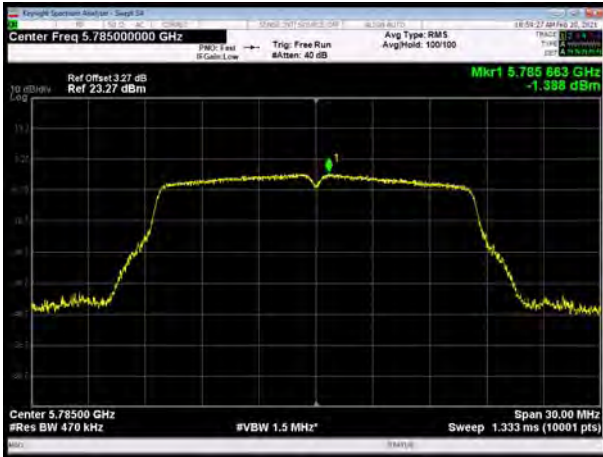

U-NII-3, 802.11n HT20, Channel No.: 157

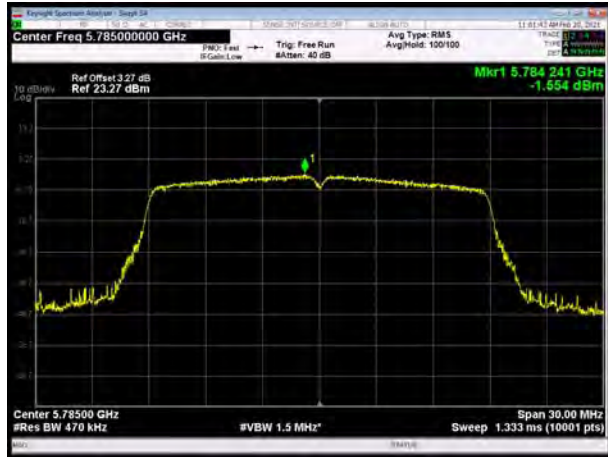

U-NII-3, 802.11a, Channel No.: 165

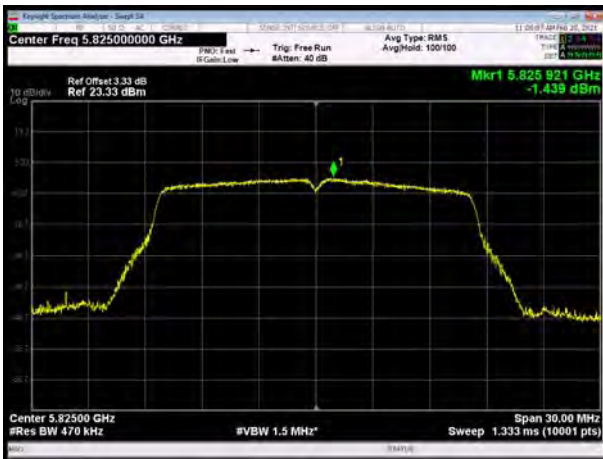

U-NII-3, 802.11n HT20, Channel No.: 165



U-NII-3, 802.11n HT40, Channel No.: 151

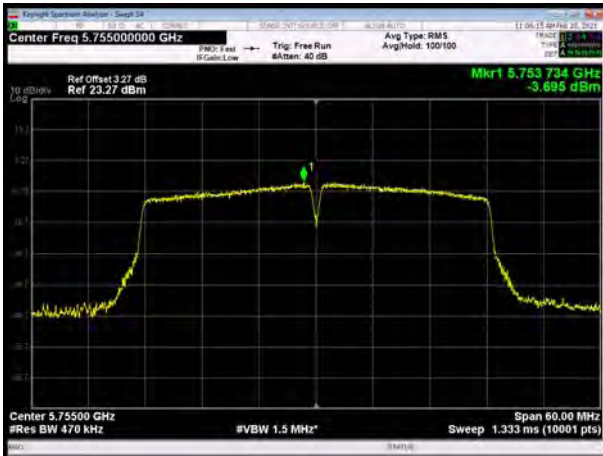

U-NII-3, 802.11ac VHT20, Channel No.: 149

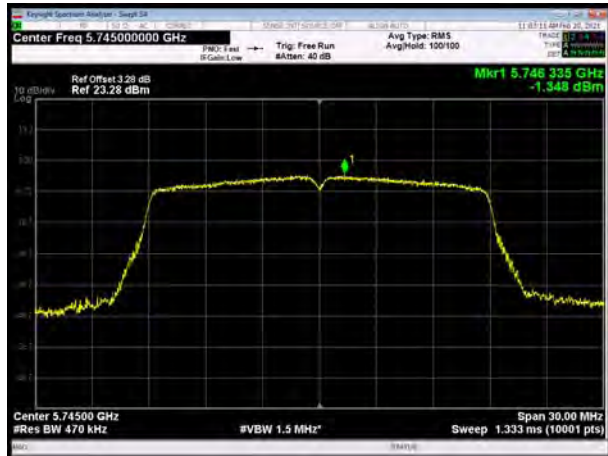

U-NII-3, 802.11n HT40, Channel No.: 159

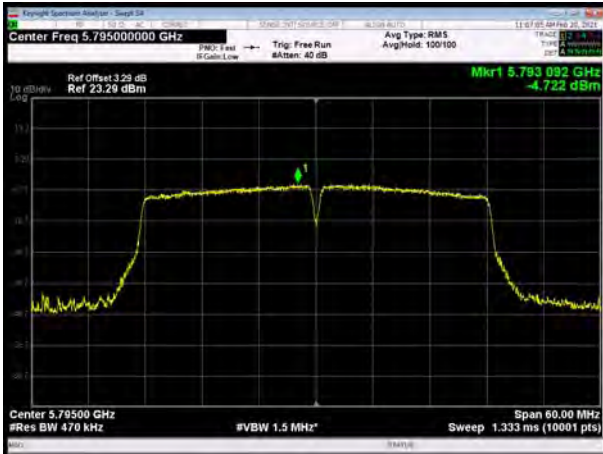

U-NII-3, 802.11ac VHT20, Channel No.: 157

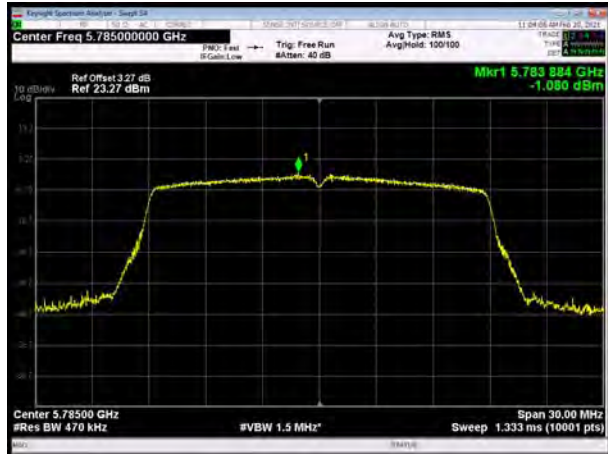

U-NII-3, 802.11ac VHT40, Channel No.: 151

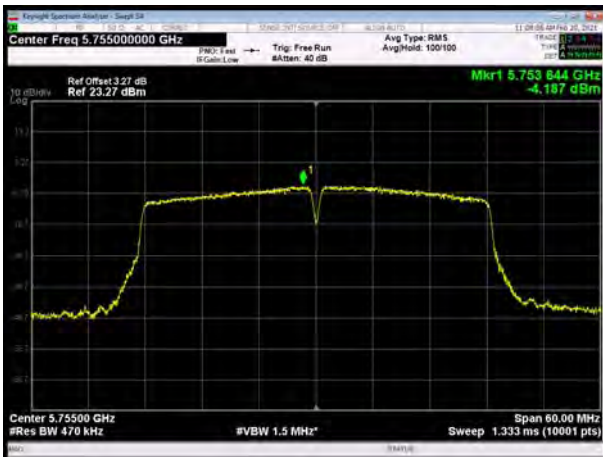

U-NII-3, 802.11ac VHT20, Channel No.: 165

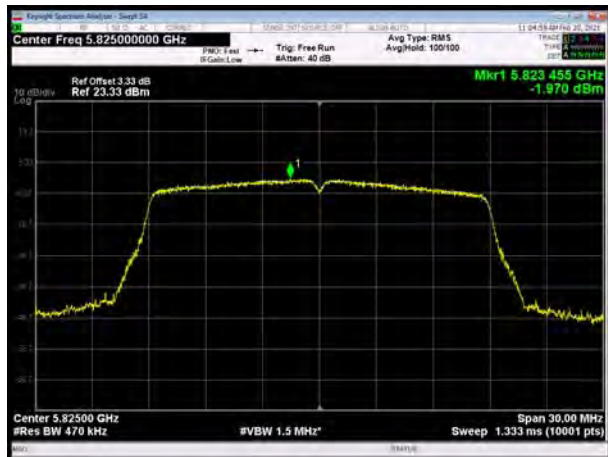

U-NII-3, 802.11ac VHT40, Channel No.: 159

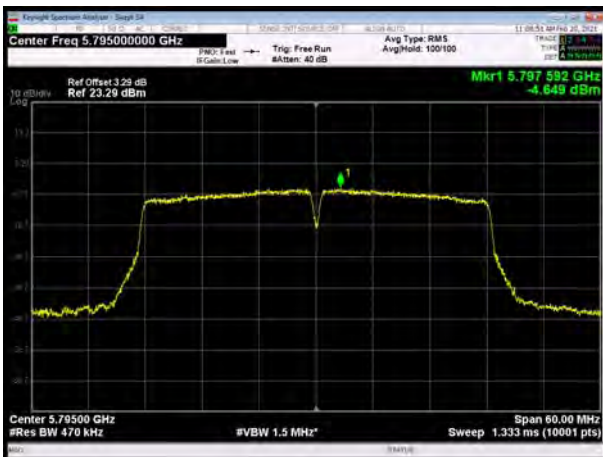

U-NII-3, 802.11ac VHT80, Channel No.: 155

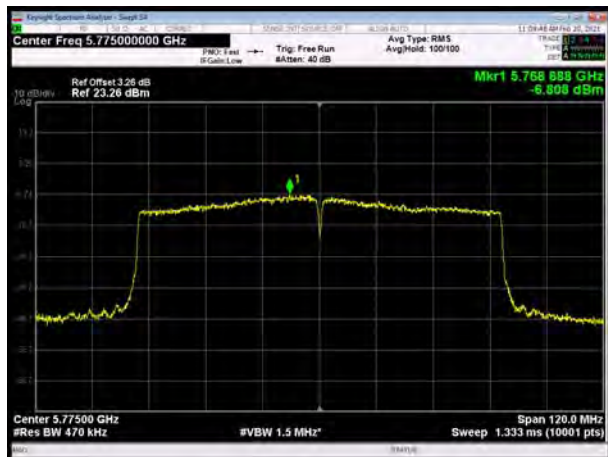

5.5. Unwanted Emission

Ambient condition

Temperature	Relative humidity	Pressure
23°C ~25°C	45%~50%	101.5kPa

Method of Measurement

The test set-up was made in accordance to the general provisions of ANSI C63.10-2013. The Equipment Under Test (EUT) was set up on a non-conductive table in the semi-anechoic chamber. The test was performed at the distance of 3 m between the EUT and the receiving antenna. The radiated emissions measurements were made in a typical installation configuration. Sweep the whole frequency band range from 9kHz to the 10th harmonic of the carrier, and the emissions less than 20 dB below the permissible value are reported.

During the test, the height of receive antenna shall be moved from 1 to 4 meters, and the antenna shall be performed under horizontal and vertical polarization. The turntable shall be rotated from 0 to 360 degrees for detecting the maximum of radiated spurious signal level. The measurements shall be repeated with orthogonal polarization of the test antenna. The data of cable loss and antenna factor has been calibrated in full testing frequency range before the testing.

Set the spectrum analyzer in the following:

9kHz~150 kHz

RBW=200Hz, VBW=1kHz/ Sweep=AUTO

150 kHz~30MHz

RBW=9KHz, VBW=30KHz,/ Sweep=AUTO

Below 1GHz

RBW=100kHz / VBW=300kHz / Sweep=AUTO

a) Peak emission levels are measured by setting the instrument as follows:

Above 1GHz

PEAK: RBW=1MHz VBW=3MHz/ Sweep=AUTO

b) Average emission levels are measured by setting the instrument as follows:

Above 1GHz

AVERAGE: RBW=1MHz / VBW=3MHz / Sweep=AUTO

c) Detector: The measurements employing a CISPR quasi-peak detector except for the frequency bands 9-90 kHz, 110-490 kHz and above 1000 MHz. Radiated emission limits in these three bands are based on measurements employing an average detector.

d) Averaging type = power (i.e., rms) (As an alternative, the detector and averaging type may be set for linear voltage averaging. Some instruments require linear display mode to use linear voltage averaging. Log or dB averaging shall not be used.)

e) Sweep time = auto.

f) Perform a trace average of at least 100 traces if the transmission is continuous. If the transmission is not continuous, then the number of traces shall be increased by a factor of $1 / D$, where D is the duty cycle. For example, with 50% duty cycle, at least 200 traces shall be averaged. (If a specific



emission is demonstrated to be continuous—i.e., 100% duty cycle—then rather than turning ON and OFF with the transmit cycle, at least 100 traces shall be averaged.)

g) If tests are performed with the EUT transmitting at a duty cycle less than 98%, then a correction factor shall be added to the measurement results prior to comparing with the emission limit, to compute the emission level that would have been measured had the test been performed at 100% duty cycle. The correction factor is computed as follows:

1) If power averaging (rms) mode was used in the preceding step e), then the correction factor is $[10 \log (1 / D)]$, where D is the duty cycle. For example, if the transmit duty cycle was 50%, then 3 dB shall be added to the measured emission levels.

2) If linear voltage averaging mode was used in the preceding step e), then the correction factor is $[20 \log (1 / D)]$, where D is the duty cycle. For example, if the transmit duty cycle was 50%, then 6 dB shall be added to the measured emission levels.

3) If a specific emission is demonstrated to be continuous (100% duty cycle) rather than turning ON and OFF with the transmit cycle, then no duty cycle correction is required for that emission.

Reduce the video bandwidth until no significant variations in the displayed signal are observed in subsequent traces, provided the video bandwidth is no less than 1 Hz. For regulatory requirements that specify averaging only over the transmit duration (e.g., digital transmission system [DTS] and Unlicensed National Information Infrastructure [U-NII]), the video bandwidth shall be greater than $[1 / (\text{minimum transmitter on time})]$ and no less than 1 Hz.

The field strength of spurious emission was measured in the following position: EUT stand-up position (Z axis), lie-down position (X, Y axis). The worst emission was found in stand-up position (Z axis) and the loop antenna is vertical, others antenna are vertical and horizontal.

The test is in transmitting mode.

9KHz~~~30MHz

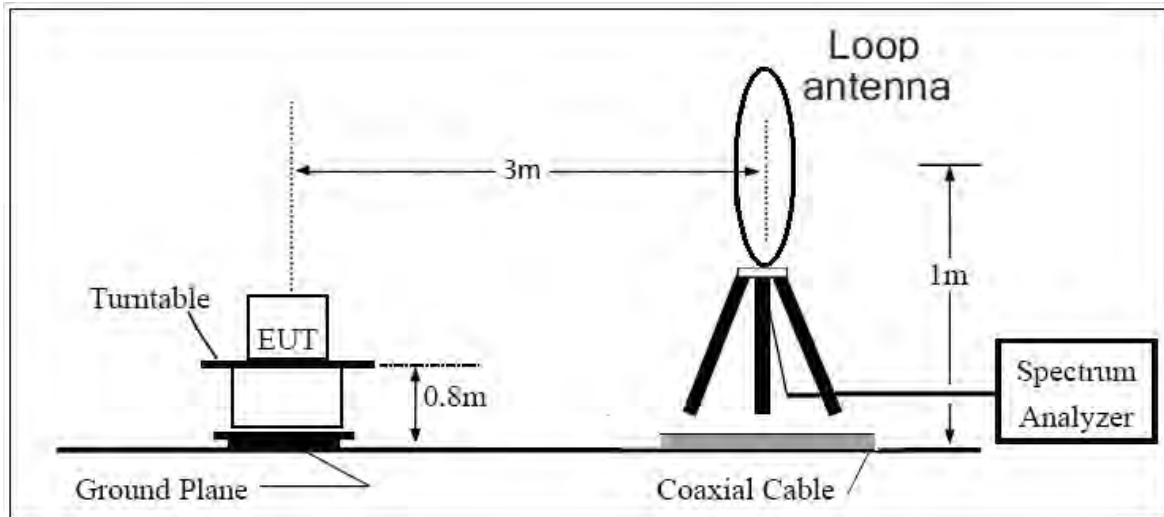

30MHz~~~ 1GHz

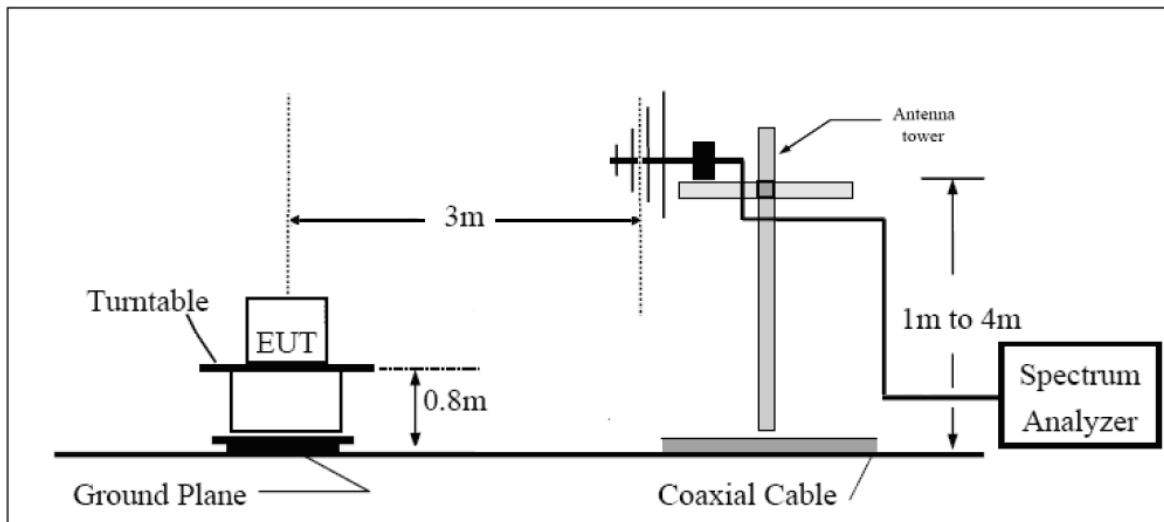

Above 1GHz

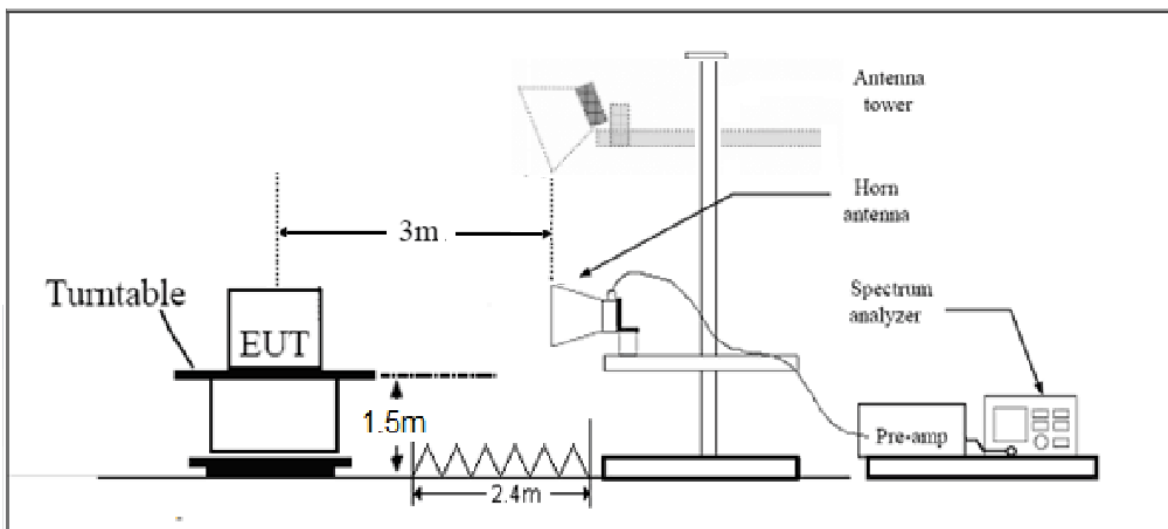

Note: Area side:2.4mX3.6m

**Limits**

- (1) For transmitters operating in the 5725-5850 MHz band: All emissions shall be limited to a level of -27 dBm/MHz at 75 MHz or more above or below the band edge increasing linearly to 10 dBm/MHz at 25 MHz above or below the band edge, and from 25 MHz above or below the band edge increasing linearly to a level of 15.6 dBm/MHz at 5 MHz above or below the band edge, and from 5 MHz above or below the band edge increasing linearly to a level of 27 dBm/MHz at the band edge.
- (2) For transmitters operating in the 5.15-5.25 GHz band: All emissions outside of the 5.15-5.35 GHz band shall not exceed an e.i.r.p. of -27 dBm/MHz(68.2dBμV/m).
- (3) For transmitters operating in the 5.25-5.35 GHz band: All emissions outside of the 5.15-5.35 GHz band shall not exceed an e.i.r.p. of -27 dBm/MHz(68.2dBμV/m).
- (4) For transmitters operating in the 5.47-5.725 GHz band: All emissions outside of the 5.47-5.725 GHz band shall not exceed an e.i.r.p. of -27 dBm/MHz(68.2dBμV/m).

Note: the following formula is used to convert the EIRP to field strength

§1、 $E[\text{dB}\mu\text{V}/\text{m}] = \text{EIRP}[\text{dBm}] - 20 \log(d[\text{meters}]) + 104.77$, where E = field strength and

d = distance at which field strength limit is specified in the rules;

§2、 $E[\text{dB}\mu\text{V}/\text{m}] = \text{EIRP}[\text{dBm}] + 95.2$, for d = 3 meters

- (5) Unwanted spurious emissions fallen in restricted bands per FCC Part15.205 shall comply with the general field strength limits set forth in § 15.209 as below table.

Frequency of emission (MHz)	Field strength(uV/m)	Field strength(dBuV/m)
0.009–0.490	2400/F(kHz)	/
0.490–1.705	24000/F(kHz)	/
1.705–30.0	30	/
30-88	100	40
88-216	150	43.5
216-960	200	46
Above960	500	54



MHz	MHz	MHz	GHz
0.090 - 0.110	16.42 - 16.423	399.9 - 410	4.5 - 5.15
0.495 - 0.505	16.69475 - 16.69525	608 - 614	5.35 - 5.46
2.1735 - 2.1905	16.80425 - 16.80475	960 - 1240	7.25 - 7.75
4.125 - 4.128	25.5 - 25.67	1300 - 1427	8.025 - 8.5
4.17725 - 4.17775	37.5 - 38.25	1435 - 1626.5	9.0 - 9.2
4.20725 - 4.20775	73 - 74.6	1645.5 - 1646.5	9.3 - 9.5
6.215 - 6.218	74.8 - 75.2	1660 - 1710	10.6 - 12.7
6.26775 - 6.26825	108 - 121.94	1718.8 - 1722.2	13.25 - 13.4
6.31175 - 6.31225	123 - 138	2200 - 2300	14.47 - 14.5
8.291 - 8.294	149.9 - 150.05	2310 - 2390	15.35 - 16.2
8.362 - 8.366	156.52475 - 156.52525	2483.5 - 2500	17.7 - 21.4
8.37625 - 8.38675	156.7 - 156.9	2690 - 2900	22.01 - 23.12
8.41425 - 8.41475	162.0125 - 167.17	3260 - 3267	23.6 - 24.0
12.29 - 12.293	167.72 - 173.2	3332 - 3339	31.2 - 31.8
12.51975 - 12.52025	240 - 285	3345.8 - 3358	36.43 - 36.5
12.57675 - 12.57725	322 - 335.4	3600 - 4400	(²)
13.36 - 13.41			

Measurement Uncertainty

The assessed measurement uncertainty to ensure 95% confidence level for the normal distribution is with the coverage factor $k = 1.96$.

Frequency	Uncertainty
9KHz-30MHz	3.55 dB
30MHz-200MHz	4.17 dB
200MHz-1GHz	4.84 dB
1-18GHz	4.35 dB
18-26.5GHz	5.90 dB
26.5GHz~40GHz	5.92 dB



Test Results:

The modulation and bandwidth are similar for 802.11n mode for 20MHz/40MHz and 802.11ac mode for V20MHz/V40MHz, therefore investigated worst case to representative mode in test report.

The signal beyond the limit is carrier.

U-NII-1

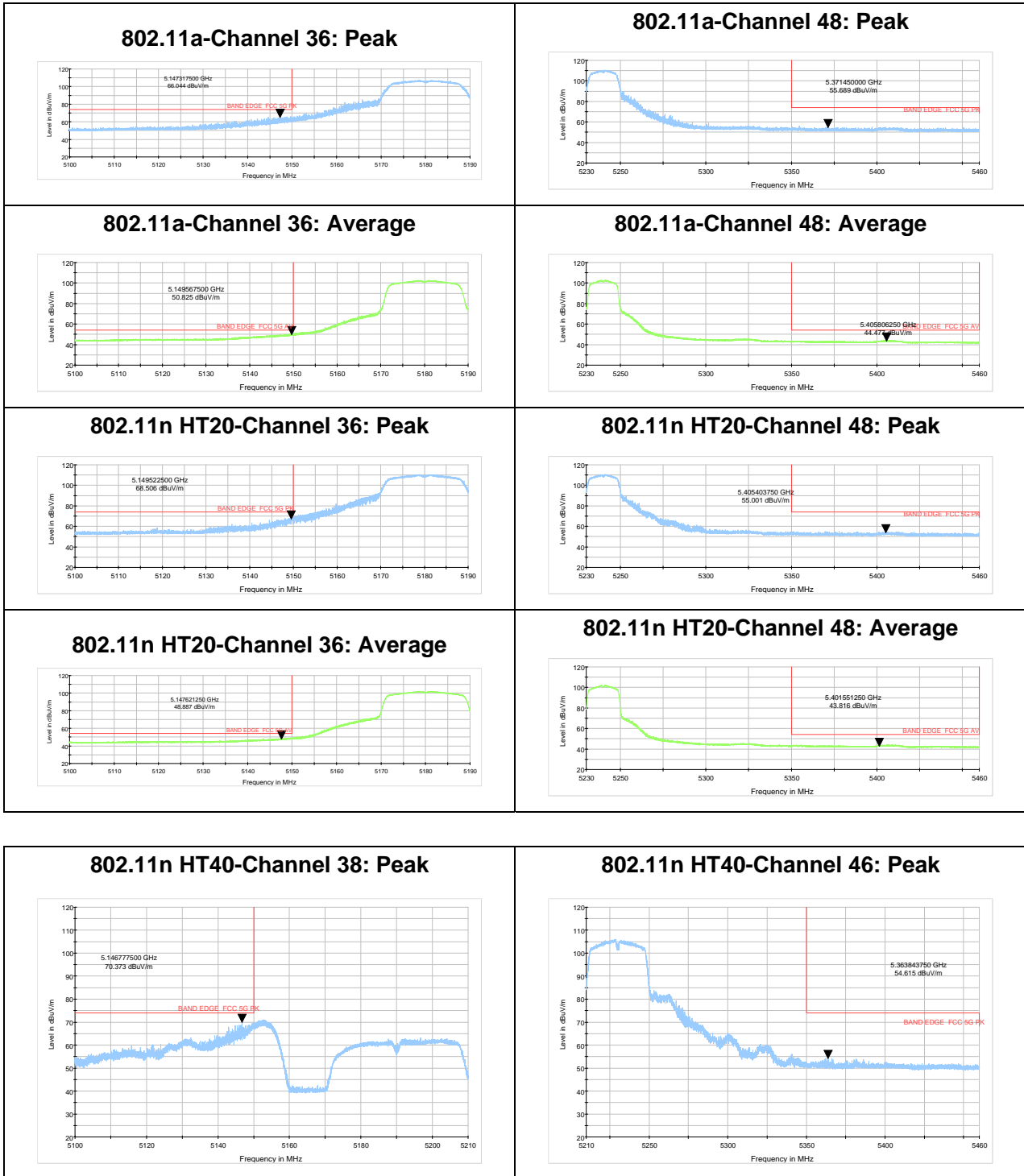



802.11n HT40-Channel 38: Average

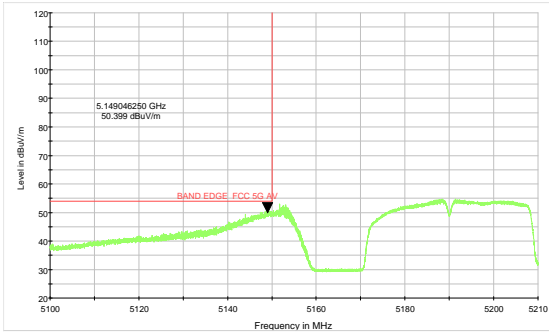

802.11n HT40-Channel 46: Average

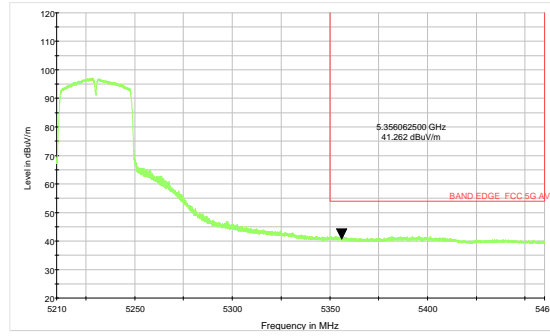

802.11ac VHT80 -Channel 42: Peak

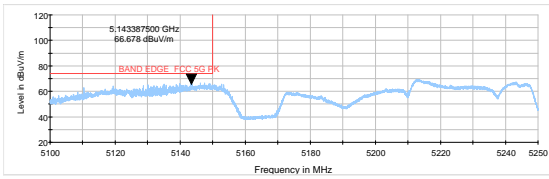

802.11ac VHT80- Channel 42: Average

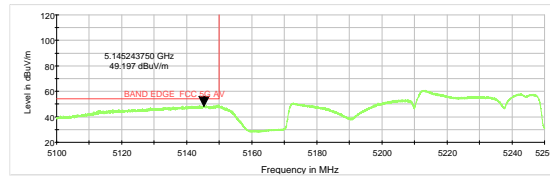

U-NII-2A

802.11a-Channel 52: Peak

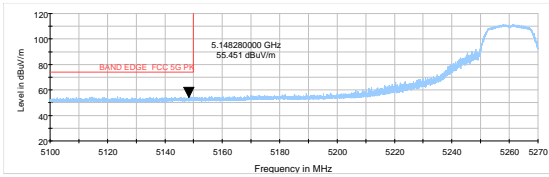

802.11a-Channel 64: Peak

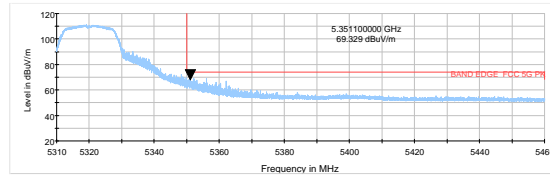

802.11a-Channel 52: Average

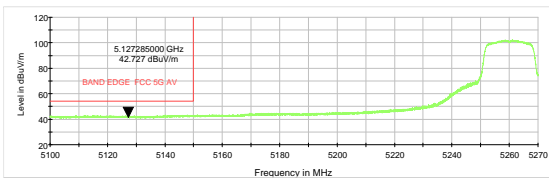

802.11a-Channel 64: Average

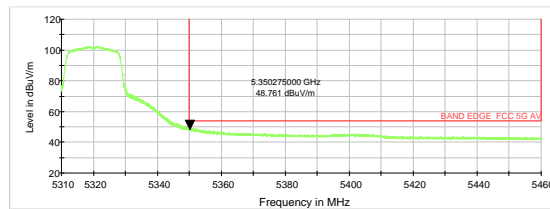

802.11n HT20-Channel 52: Peak

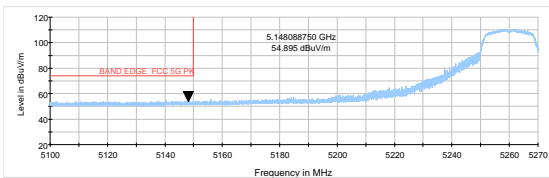

802.11n HT20-Channel 64: Peak

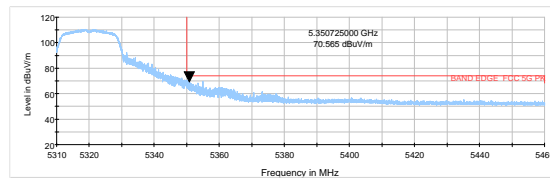

802.11n HT20-Channel 52: Average

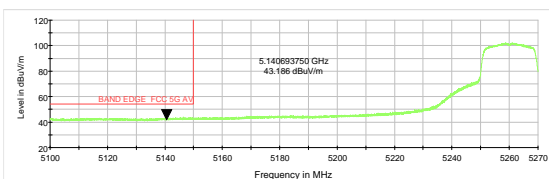

802.11n HT20-Channel 64: Average

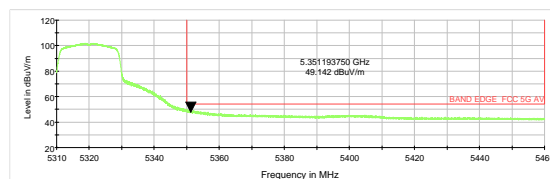



802.11n HT40-Channel 54: Peak

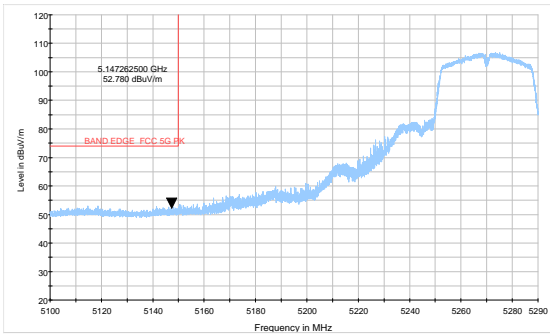

802.11n HT40-Channel 62: Peak

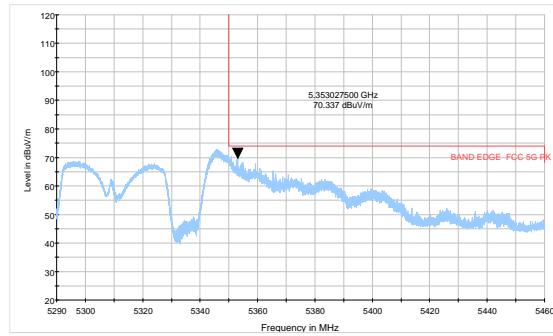

802.11n HT40-Channel 54: Average

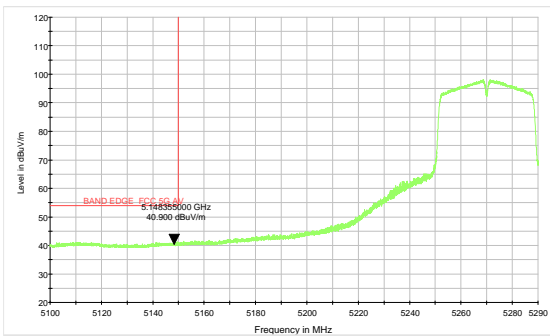

802.11n HT40-Channel 62: Average

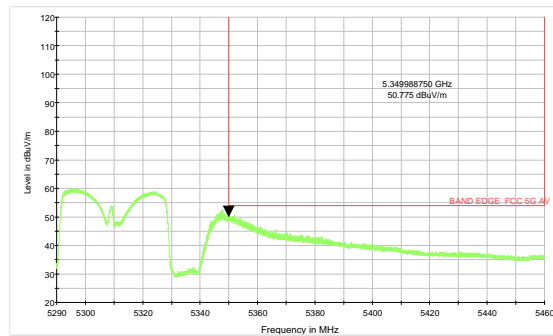

802.11ac VHT80 -Channel 58: Peak

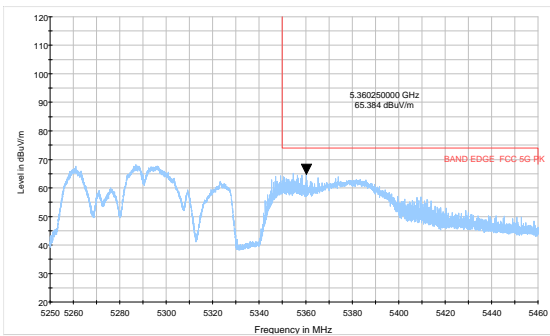

802.11ac VHT80- Channel 58: Average

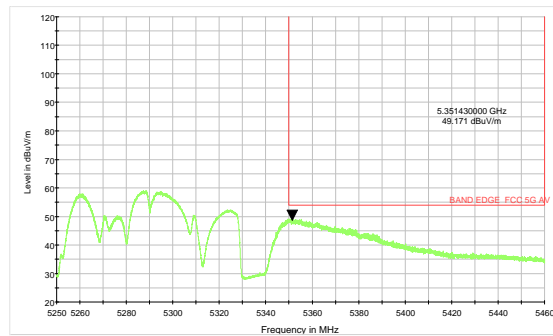

U-NII-2C

802.11a-Channel 100: Peak

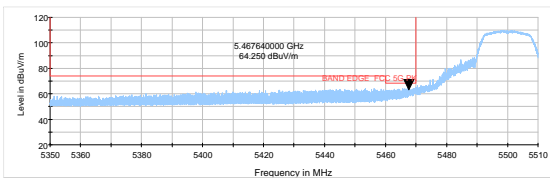

802.11n HT20-Channel 100: Peak

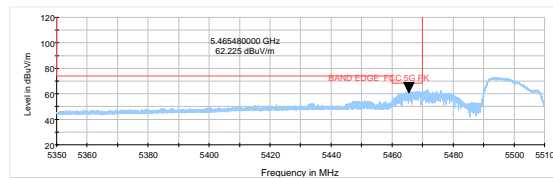



802.11a-Channel 100: Average

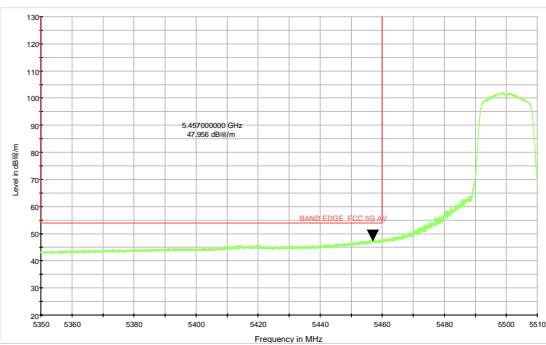

802.11n HT20-Channel 100: Average

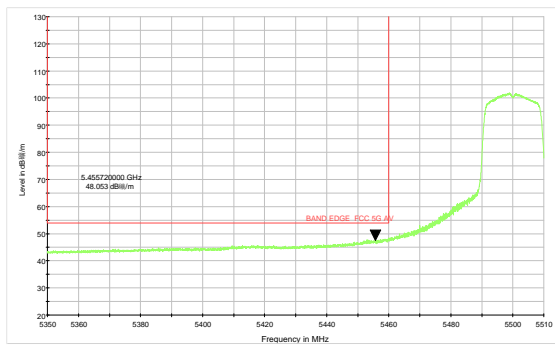

802.11a-Channel 140: Peak

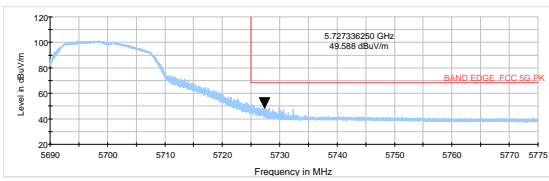

802.11n HT20-Channel 140: Peak

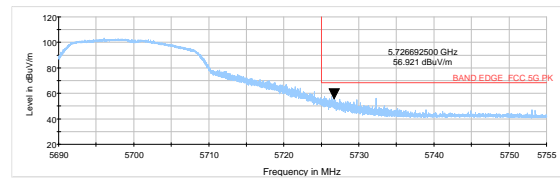

802.11n HT40-Channel 102: Peak

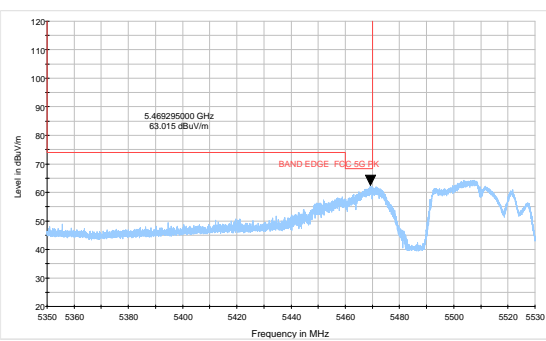

802.11ac VHT80 -Channel 106: Peak

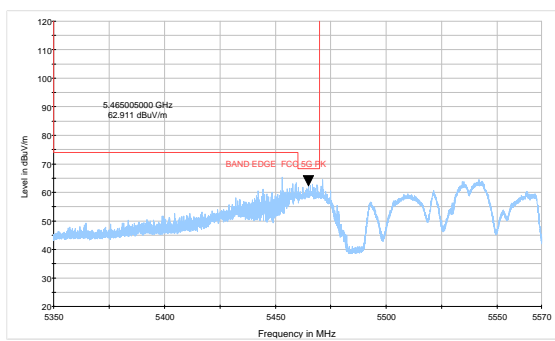

802.11n HT40-Channel 102: Average

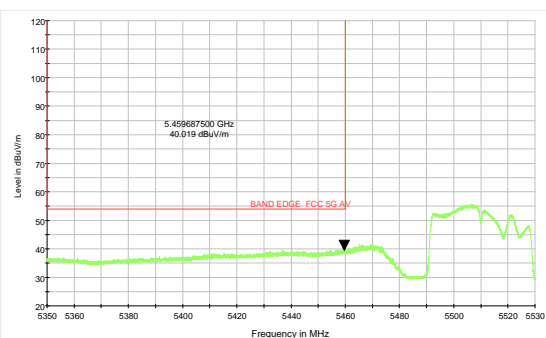

802.11ac VHT80- Channel 106: Average

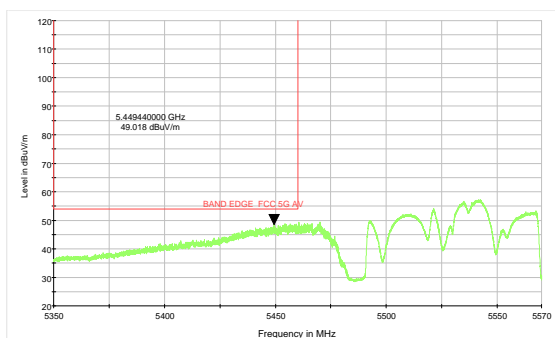

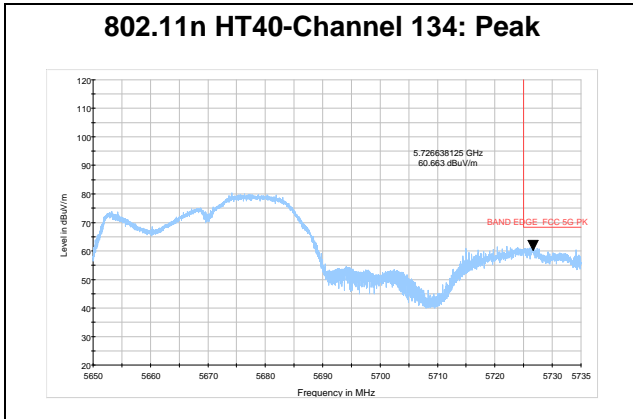

U-NII-3

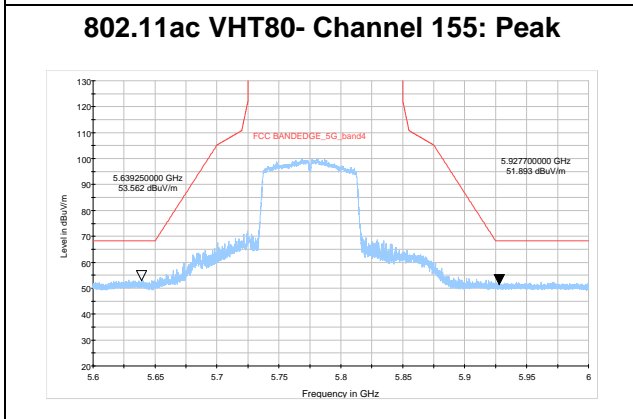
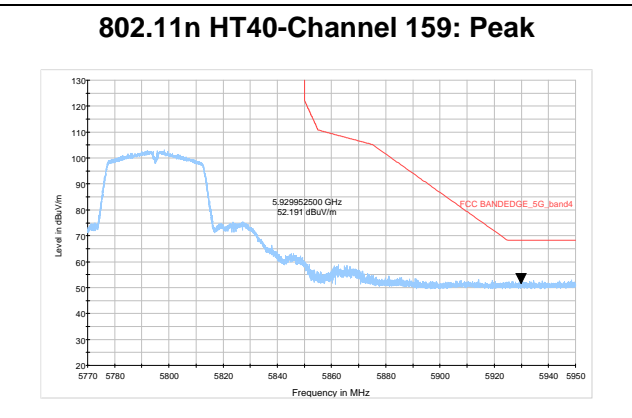
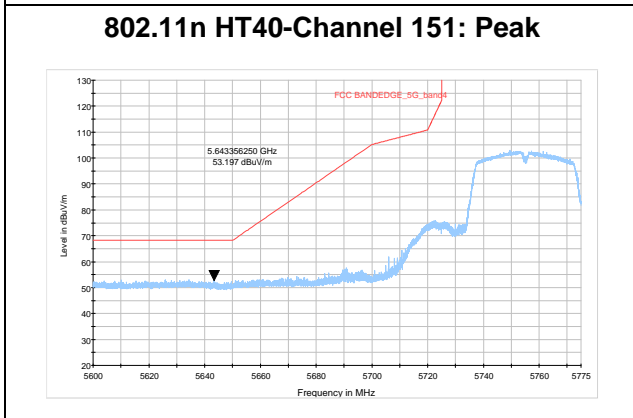
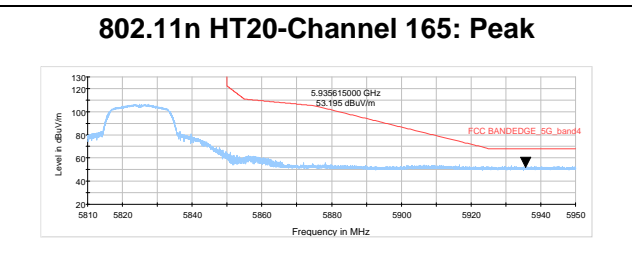
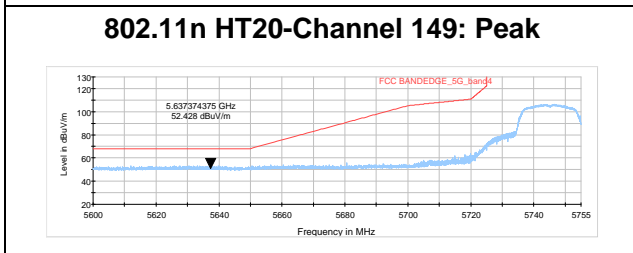
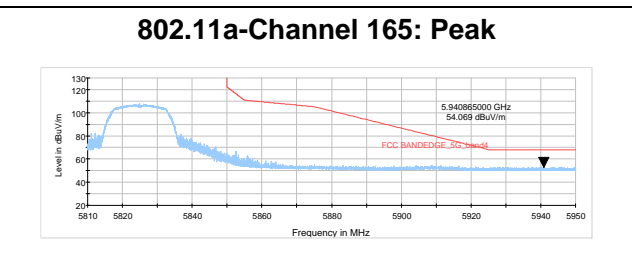
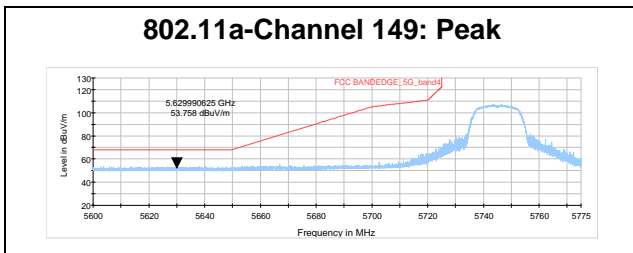



Result of RE

Test result

Sweep the whole frequency band through the range from 9kHz to the 10th harmonic of the carrier, the Emissions in the frequency band 9kHz-30MHz and 26.5GHz-40GHz are more than 20dB below the limit are not reported.

During the test, the Radiates Emission from 30MHz to 1GHz was performed in all modes with all channels, 802.11a, Channel 36 are selected as the worst condition. The test data of the worst-case condition was recorded in this report.

Continuous TX mode:

FCC RE 9K-90KHz AV

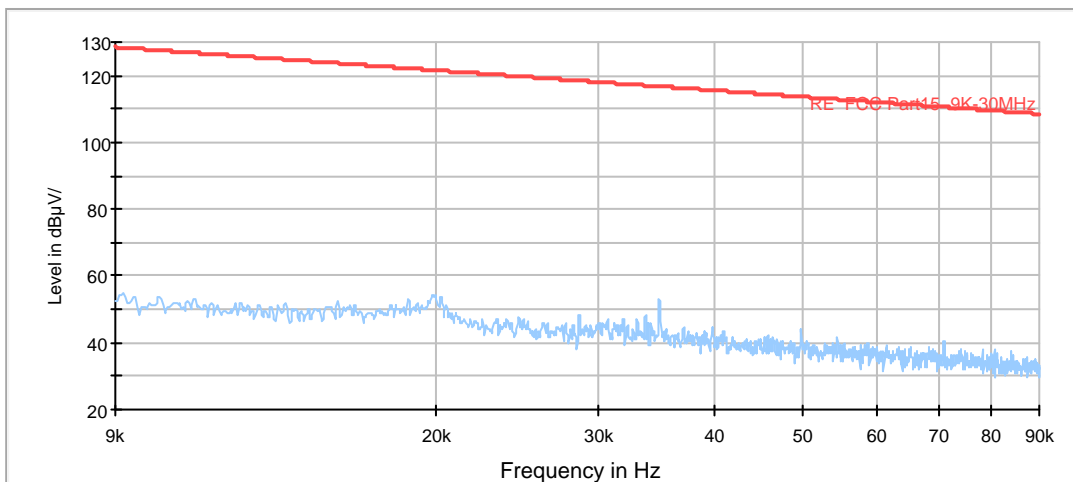

Radiates Emission from 9KHz to 90KHz

FCC RE 90K-110KHz QP

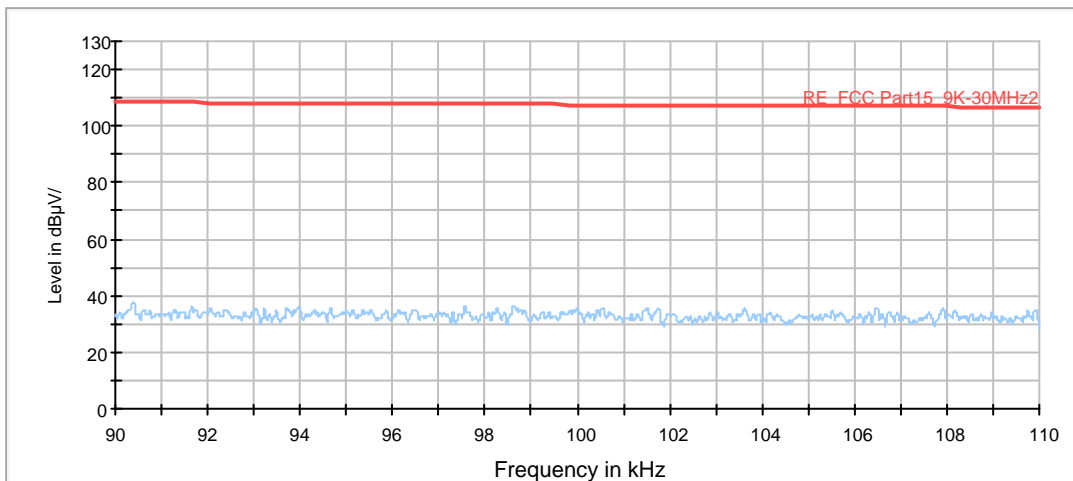

Radiates Emission from 90KHz to 110KHz



FCC RE 110K-490KHz AV

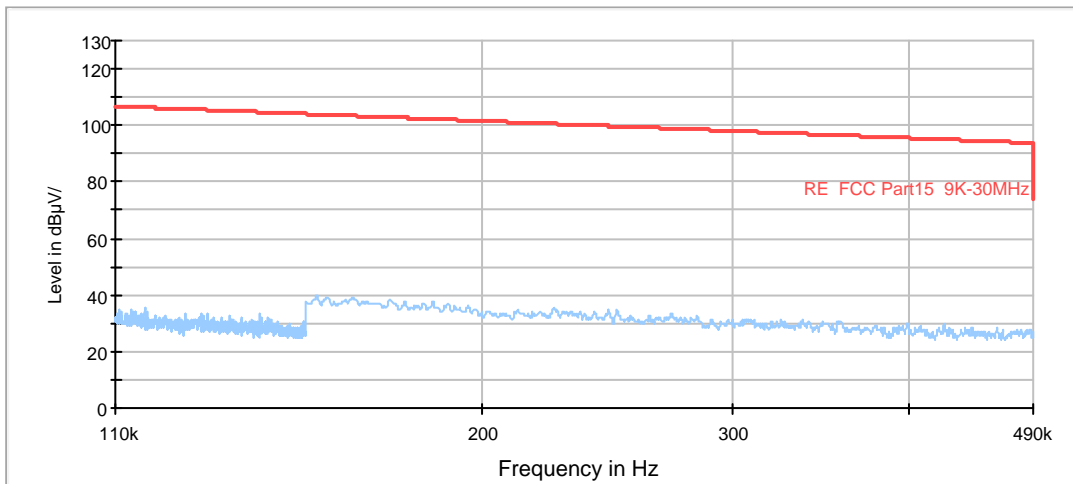

Radiates Emission from 110KHz to 490KHz

FCC RE 490K-30MHz QP

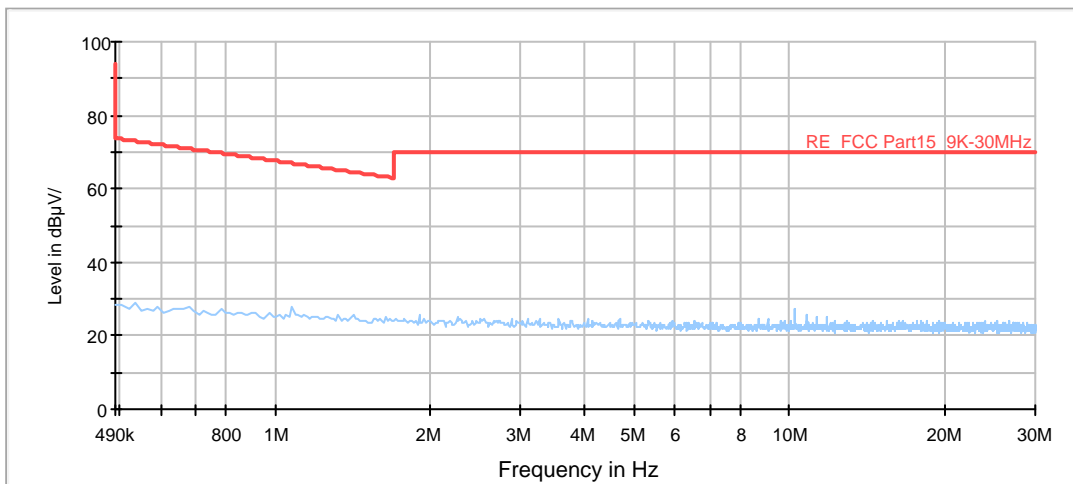

Radiates Emission from 490KHz to 30MHz

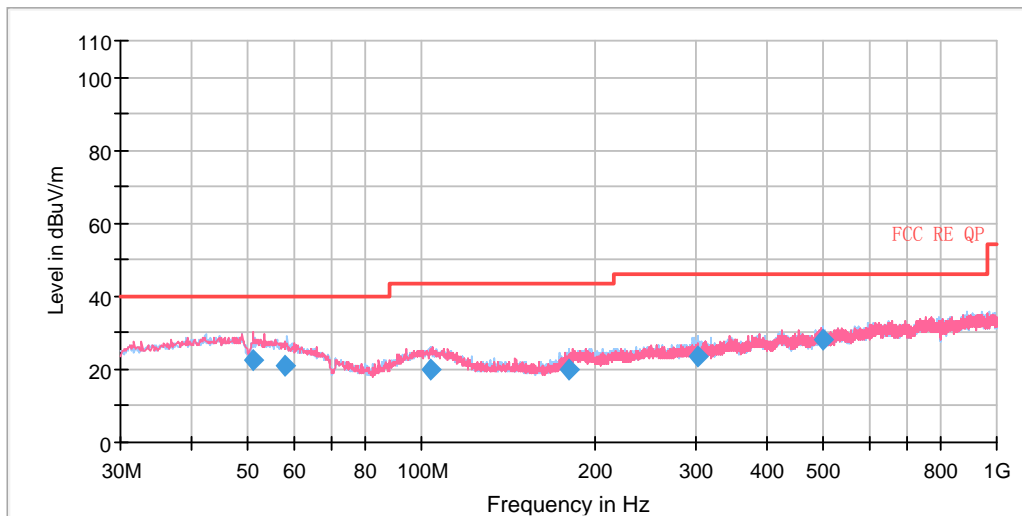

Radiates Emission from 30MHz to 1GHz

Frequency (MHz)	Quasi-Peak (dBuV/m)	Height (cm)	Polarization	Azimuth (deg)	Correct Factor (dB)	Margin (dB)	Limit (dBuV/m)
51.056250	22.71	175.0	V	1.0	-1.0	17.29	40.00
58.093750	21.04	175.0	H	94.0	-2.6	18.96	40.00
104.002500	20.04	125.0	H	309.0	-5.0	23.46	43.50
180.635000	20.04	175.0	H	242.0	-8.3	23.46	43.50
302.523750	23.56	100.0	H	245.0	-4.4	22.44	46.00
497.423750	27.93	225.0	H	182.0	-0.3	18.07	46.00

Remark: 1. Correction Factor = Antenna factor+ Insertion loss(cable loss+amplifier gain)

2. Margin = Limit – Quasi-Peak

802.11a CH36

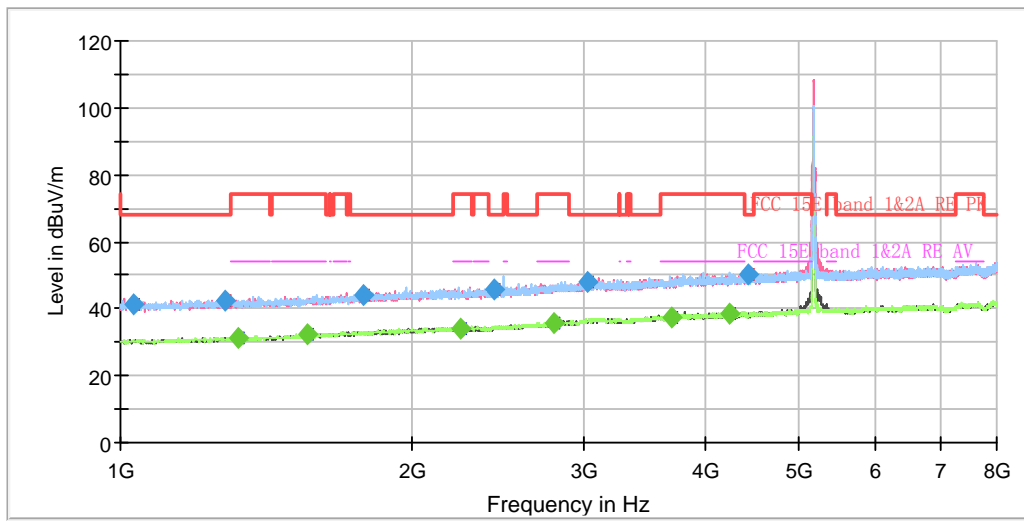

Note: The signal beyond the limit is carrier.
Radiates Emission from 1GHz to 8GHz

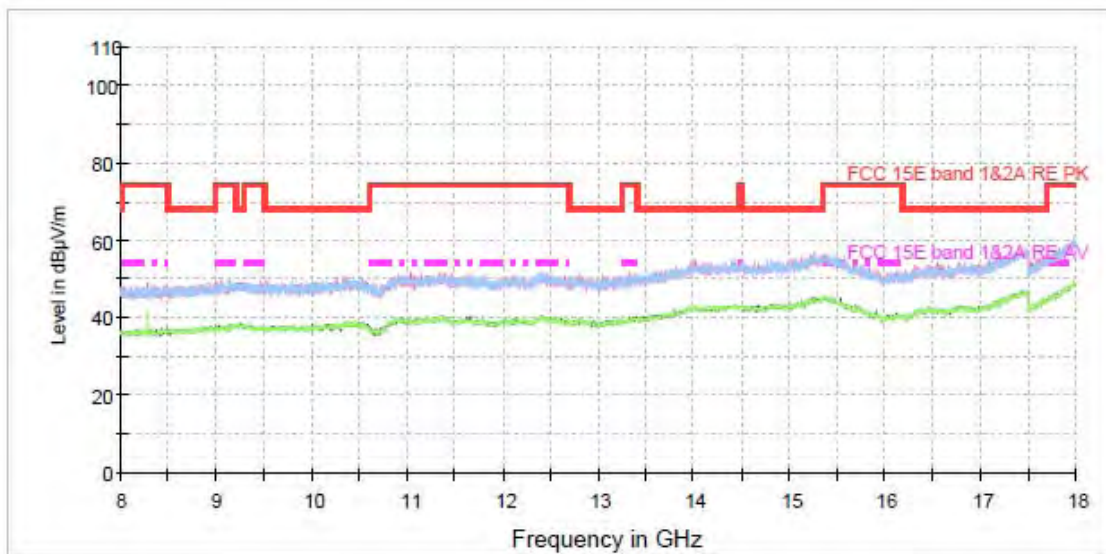

Radiates Emission from 8GHz to 18GHz



Frequency (MHz)	Peak (dBuV/m)	Average (dBuV/m)	Limit (dBuV/m)	Margin (dB)	Height (cm)	Polarization	Azimuth (deg)	Correct Factor (dB)
1033.250000	41.29	---	68.20	26.91	200.0	V	135.0	-8.7
1281.750000	42.32	---	68.20	25.88	100.0	H	301.0	-7.3
1781.375000	44.33	---	68.20	23.87	200.0	H	0.0	-4.6
1324.625000	---	31.04	54.00	22.96	200.0	V	12.0	-7.1
2424.500000	45.69	---	68.20	22.51	200.0	V	103.0	-1.9
1555.625000	---	32.32	54.00	21.68	100.0	V	341.0	-5.9
3025.625000	48.12	---	68.20	20.08	100.0	H	207.0	1.3
2240.750000	---	33.96	54.00	20.04	100.0	V	247.0	-2.5
2800.750000	---	35.72	54.00	18.28	200.0	H	63.0	0.1
4444.875000	49.95	---	68.20	18.25	100.0	V	42.0	4.9
3703.750000	---	37.50	54.00	16.50	200.0	V	207.0	3.1
4239.250000	---	38.28	54.00	15.72	100.0	V	264.0	4.5

Remark: 1. Correction Factor = Antenna factor+ Insertion loss (cable loss + amplifier gain)

802.11a CH40

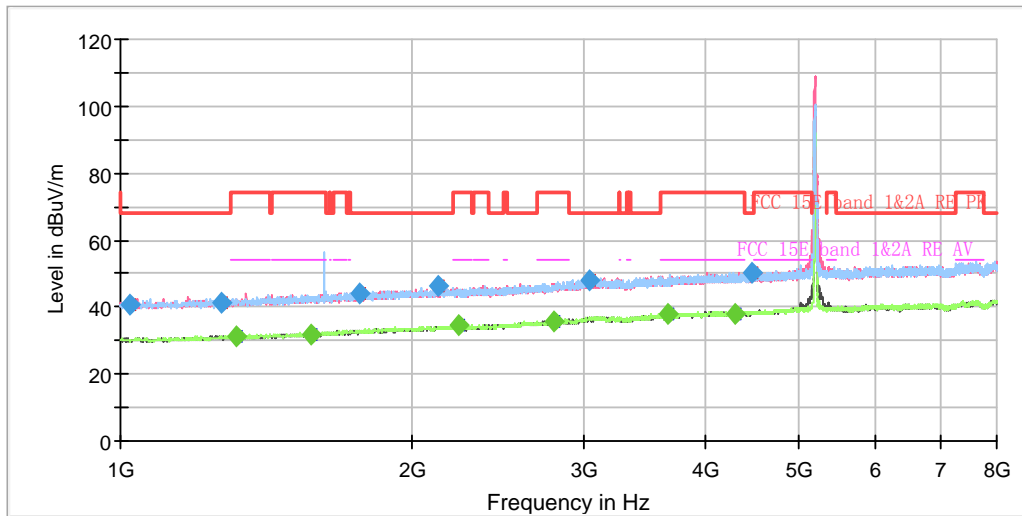

Note: The signal beyond the limit is carrier.
Radiates Emission from 1GHz to 8GHz

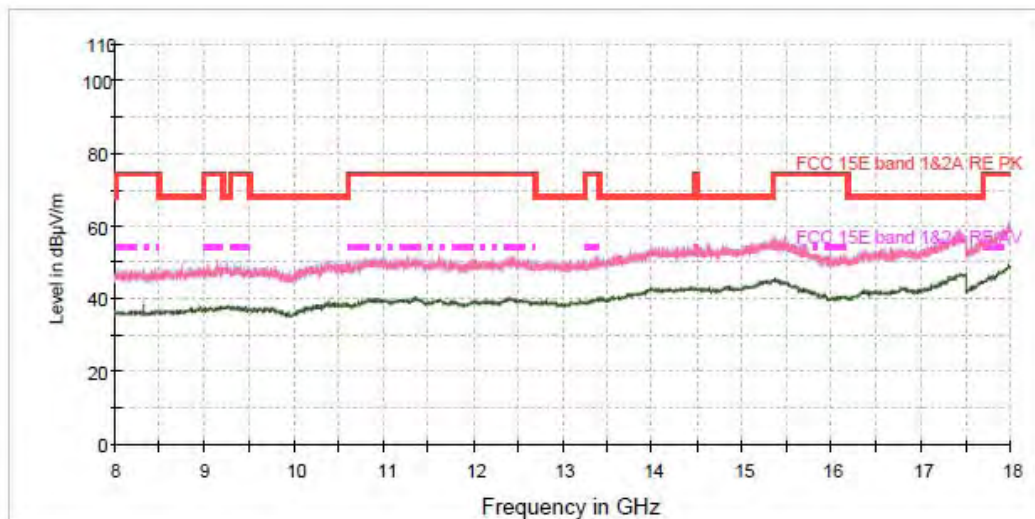

Radiates Emission from 8GHz to 18GHz



Frequency (MHz)	Peak (dBuV/m)	Average (dBuV/m)	Limit (dBuV/m)	Margin (dB)	Height (cm)	Polarization	Azimuth (deg)	Correct Factor (dB)
1024.500000	40.77	---	68.20	27.43	100.0	V	313.0	-8.8
1273.000000	41.41	---	68.20	26.79	100.0	V	11.0	-7.4
1315.875000	---	31.08	54.00	22.92	100.0	H	15.0	-7.2
1574.875000	---	31.89	54.00	22.11	100.0	V	214.0	-5.7
1765.625000	44.18	---	68.20	24.02	100.0	V	346.0	-4.7
2127.875000	46.25	---	68.20	21.95	200.0	V	265.0	-2.8
2226.750000	---	34.34	54.00	19.66	100.0	H	244.0	-2.6
2796.375000	---	35.60	54.00	18.40	100.0	H	211.0	0.1
3049.250000	47.97	---	68.20	20.23	200.0	V	243.0	1.4
3672.250000	---	37.71	54.00	16.29	100.0	V	357.0	3.0
4303.125000	---	38.18	54.00	15.82	200.0	V	2.0	4.5
4479.875000	50.20	---	68.20	18.00	200.0	V	0.0	4.9

Remark: 1. Correction Factor = Antenna factor+ Insertion loss (cable loss + amplifier gain)



802.11a CH48

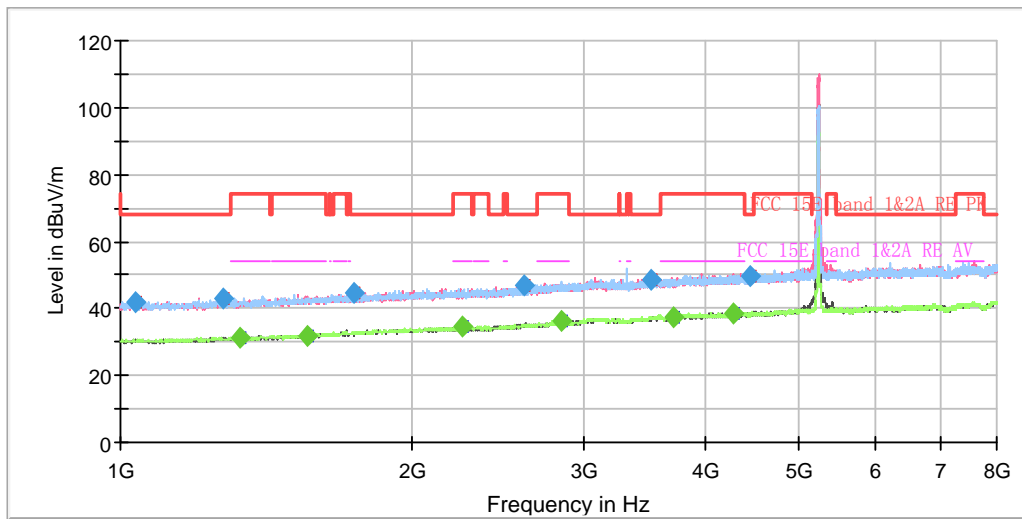

Note: The signal beyond the limit is carrier.
Radiates Emission from 1GHz to 8GHz

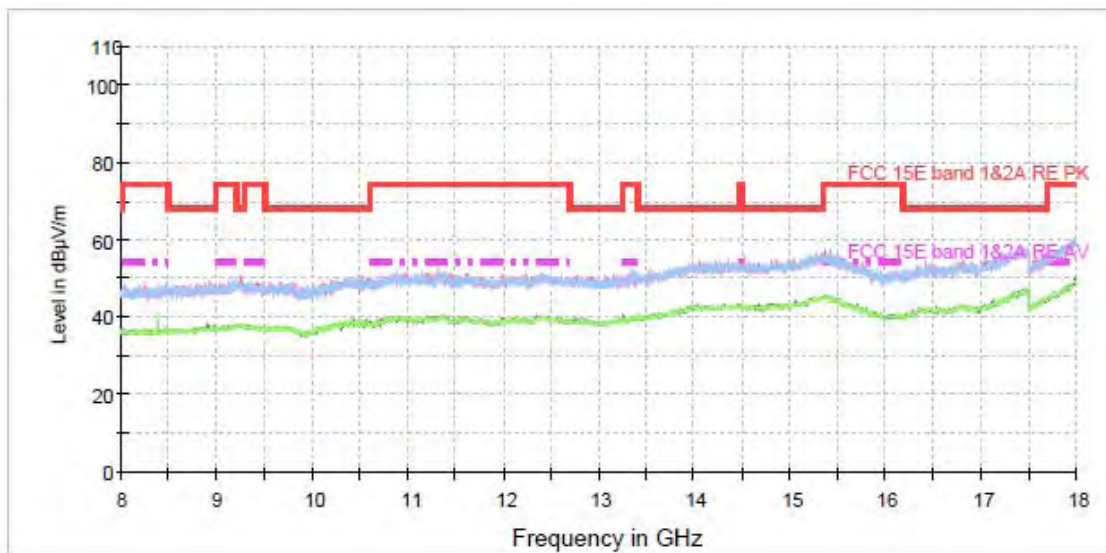

Radiates Emission from 8GHz to 18GHz



Frequency (MHz)	Peak (dBuV/m)	Average (dBuV/m)	Limit (dBuV/m)	Margin (dB)	Height (cm)	Polarization	Azimuth (deg)	Correct Factor (dB)
1034.125000	41.84	---	68.20	26.36	200.0	V	133.0	-8.7
1274.750000	42.89	---	68.20	25.31	100.0	H	0.0	-7.4
1329.000000	---	31.07	54.00	22.93	100.0	V	260.0	-7.1
1560.000000	---	31.65	54.00	22.35	100.0	V	308.0	-5.8
1742.875000	44.76	---	68.20	23.44	200.0	H	332.0	-4.8
2254.750000	---	34.38	54.00	19.62	200.0	V	12.0	-2.4
2601.250000	46.69	---	68.20	21.51	200.0	V	0.0	-1.0
2851.500000	---	36.15	54.00	17.85	100.0	H	182.0	0.4
3515.625000	48.47	---	68.20	19.73	100.0	H	305.0	2.4
3708.125000	---	37.31	54.00	16.69	100.0	V	354.0	3.1
4287.375000	---	38.44	54.00	15.56	200.0	H	195.0	4.5
4456.250000	49.79	---	68.20	18.41	100.0	V	359.0	4.9

Remark: 1. Correction Factor = Antenna factor+ Insertion loss (cable loss + amplifier gain)

802.11a CH52

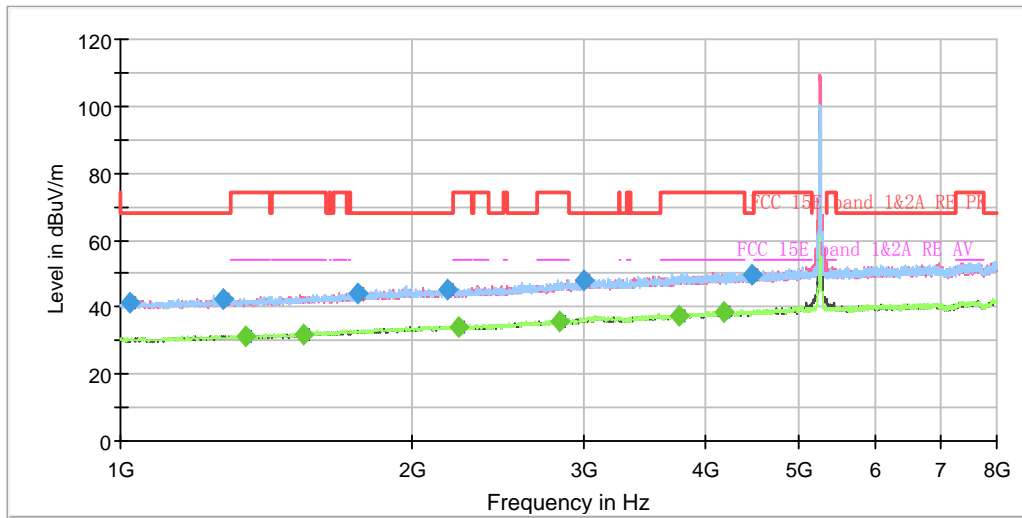

Note: The signal beyond the limit is carrier.
Radiates Emission from 1GHz to 8GHz

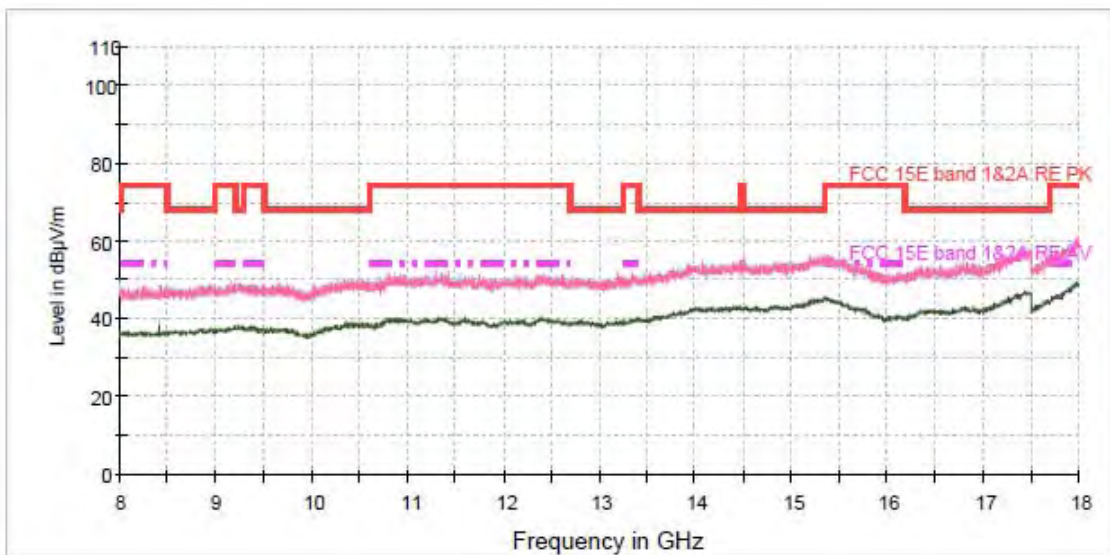

Radiates Emission from 8GHz to 18GHz



Frequency (MHz)	Peak (dBuV/m)	Average (dBuV/m)	Limit (dBuV/m)	Margin (dB)	Height (cm)	Polarization	Azimuth (deg)	Correct Factor (dB)
1021.000000	41.48	---	68.20	26.72	100.0	H	198.0	-8.8
1275.625000	42.23	---	68.20	25.97	100.0	V	128.0	-7.4
1347.375000	---	31.03	54.00	22.97	200.0	V	226.0	-7.0
1546.875000	---	31.58	54.00	22.42	100.0	V	271.0	-6.0
1758.625000	44.24	---	68.20	23.96	200.0	V	231.0	-4.7
2176.000000	45.01	---	68.20	23.19	200.0	H	344.0	-2.7
2229.375000	---	34.06	54.00	19.94	100.0	V	339.0	-2.6
2833.125000	---	35.85	54.00	18.15	100.0	H	87.0	0.3
2996.750000	48.22	---	68.20	19.98	100.0	H	33.0	1.1
3772.000000	---	37.66	54.00	16.34	200.0	H	322.0	3.4
4187.625000	---	38.39	54.00	15.61	200.0	H	135.0	4.4
4483.375000	49.94	---	68.20	18.26	200.0	H	355.0	4.9

Remark: 1. Correction Factor = Antenna factor+ Insertion loss (cable loss + amplifier gain)

802.11a CH60

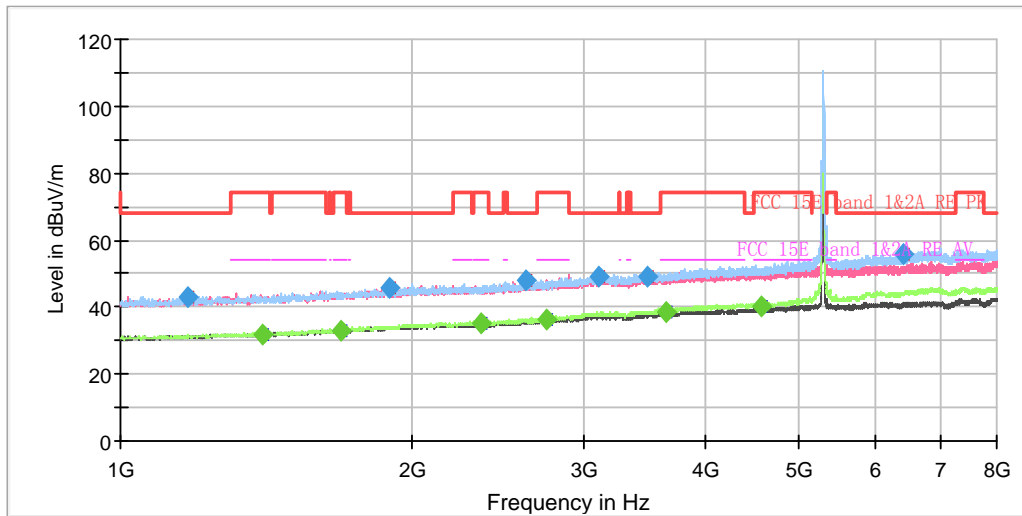

Note: The signal beyond the limit is carrier.
Radiates Emission from 1GHz to 8GHz



Radiates Emission from 8GHz to 18GHz



Frequency (MHz)	Peak (dBuV/m)	Average (dBuV/m)	Limit (dBuV/m)	Margin (dB)	Height (cm)	Polarization	Azimuth (deg)	Correct Factor (dB)
1175.000000	43.23	---	68.20	24.97	200.0	V	330.0	-7.9
1398.125000	---	31.99	54.00	22.01	200.0	V	109.0	-6.7
1687.750000	---	33.03	54.00	20.97	200.0	V	0.0	-5.1
1897.750000	46.00	---	68.20	22.20	100.0	V	301.0	-3.9
2351.000000	---	34.97	54.00	19.03	100.0	V	318.0	-2.1
2621.375000	48.06	---	68.20	20.14	100.0	H	81.0	-0.9
2746.500000	---	36.51	54.00	17.49	200.0	H	289.0	-0.2
3112.250000	49.12	---	68.20	19.08	100.0	V	149.0	1.6
3494.625000	49.39	---	68.20	18.81	200.0	V	210.0	2.3
3651.250000	---	38.63	54.00	15.37	200.0	H	306.0	2.8
4583.125000	---	40.32	54.00	13.68	200.0	H	283.0	5.2
6396.125000	55.56	---	68.20	12.64	100.0	H	57.0	8.4

Remark: 1. Correction Factor = Antenna factor+ Insertion loss (cable loss + amplifier gain)

802.11a CH64

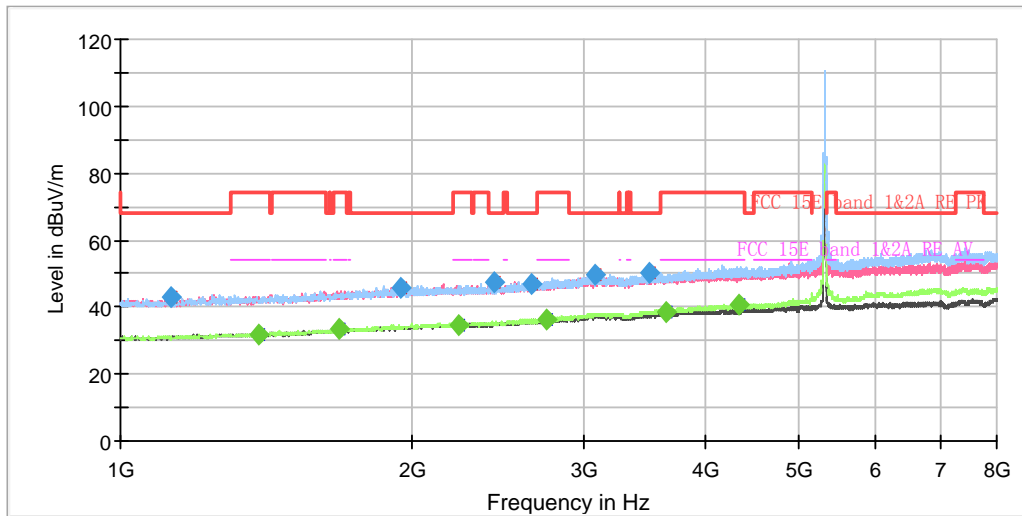

Note: The signal beyond the limit is carrier.
Radiates Emission from 1GHz to 8GHz

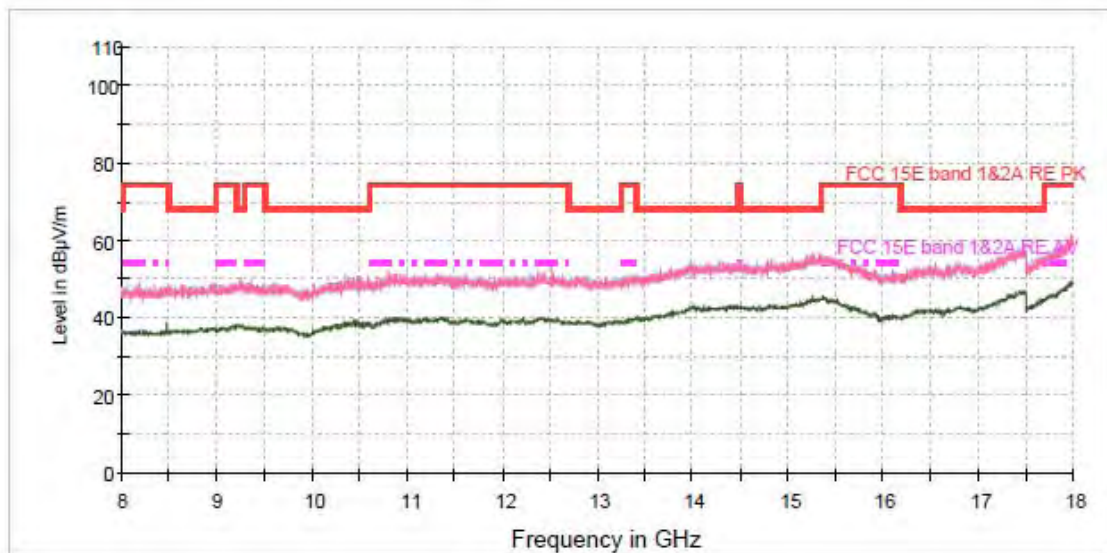

Radiates Emission from 8GHz to 18GHz



Frequency (MHz)	Peak (dBuV/m)	Average (dBuV/m)	Limit (dBuV/m)	Margin (dB)	Height (cm)	Polarization	Azimuth (deg)	Correct Factor (dB)
1129.500000	42.88	---	68.20	25.32	200.0	H	135.0	-8.2
1391.125000	---	31.84	54.00	22.16	200.0	V	210.0	-6.7
1679.875000	---	33.53	54.00	20.47	100.0	H	31.0	-5.1
1946.750000	45.68	---	68.20	22.52	100.0	V	349.0	-3.7
2232.875000	---	34.76	54.00	19.24	100.0	H	31.0	-2.6
2432.375000	47.24	---	68.20	20.96	100.0	H	54.0	-1.8
2650.250000	46.91	---	68.20	21.29	200.0	H	302.0	-0.8
2750.000000	---	36.42	54.00	17.58	100.0	H	9.0	-0.2
3078.125000	49.74	---	68.20	18.46	100.0	H	3.0	1.5
3506.875000	49.97	---	68.20	18.23	100.0	H	9.0	2.3
3647.750000	---	38.67	54.00	15.33	100.0	H	49.0	2.8
4342.500000	---	40.92	54.00	13.08	100.0	H	99.0	4.7

Remark: 1. Correction Factor = Antenna factor+ Insertion loss (cable loss + amplifier gain)

802.11a CH100

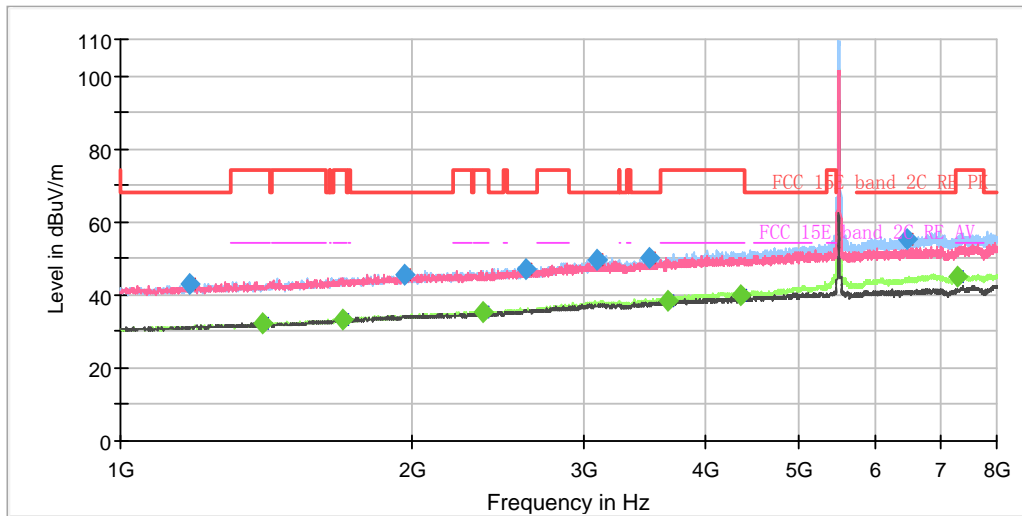

Note: The signal beyond the limit is carrier.
Radiates Emission from 1GHz to 8GHz

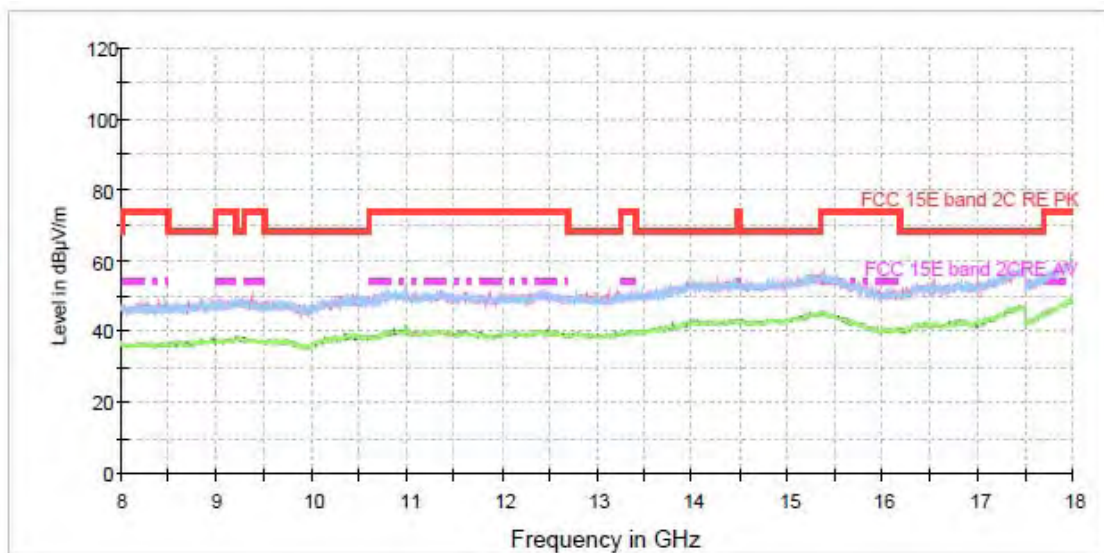

Radiates Emission from 8GHz to 18GHz



Frequency (MHz)	Peak (dBuV/m)	Average (dBuV/m)	Limit (dBuV/m)	Margin (dB)	Height (cm)	Polarization	Azimuth (deg)	Correct Factor (dB)
1175.875000	42.89	---	68.20	25.31	200.0	V	298.0	-7.9
1399.875000	---	32.29	54.00	21.71	100.0	H	306.0	-6.7
1693.875000	---	33.31	54.00	20.69	100.0	H	266.0	-5.1
1965.125000	45.72	---	68.20	22.48	100.0	V	281.0	-3.5
2368.500000	---	35.16	54.00	18.84	100.0	H	266.0	-2.1
2618.750000	46.97	---	68.20	21.23	100.0	H	300.0	-0.9
3091.250000	49.64	---	68.20	18.56	100.0	H	278.0	1.5
3511.250000	50.07	---	68.20	18.13	100.0	H	284.0	2.4
3660.000000	---	38.50	54.00	15.50	100.0	H	289.0	2.9
4351.250000	---	40.16	54.00	13.84	100.0	H	357.0	4.7
6470.500000	55.46	---	68.20	12.74	100.0	H	255.0	8.5
7277.250000	---	44.83	54.00	9.17	100.0	H	266.0	9.6

Remark: 1. Correction Factor = Antenna factor+ Insertion loss (cable loss + amplifier gain)

802.11a CH116

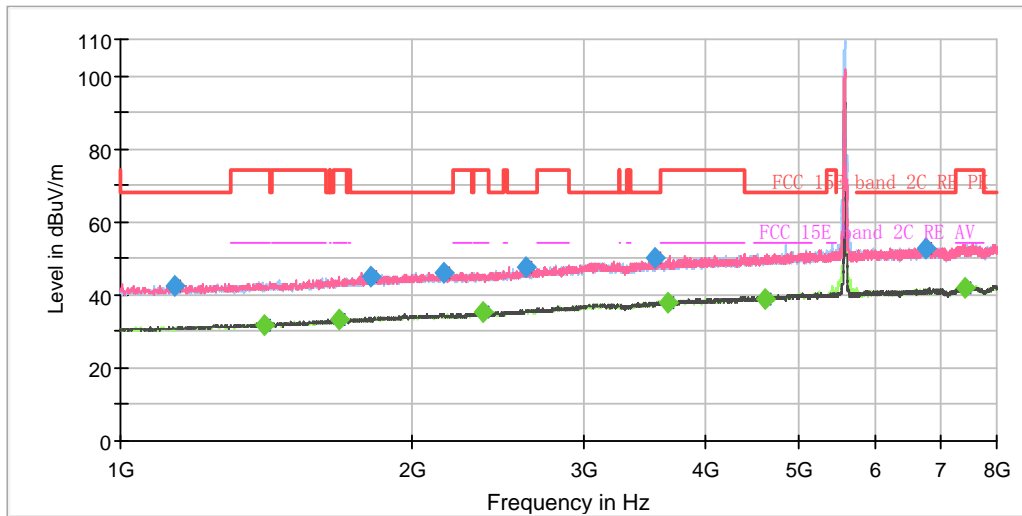

Note: The signal beyond the limit is carrier.
Radiates Emission from 1GHz to 8GHz

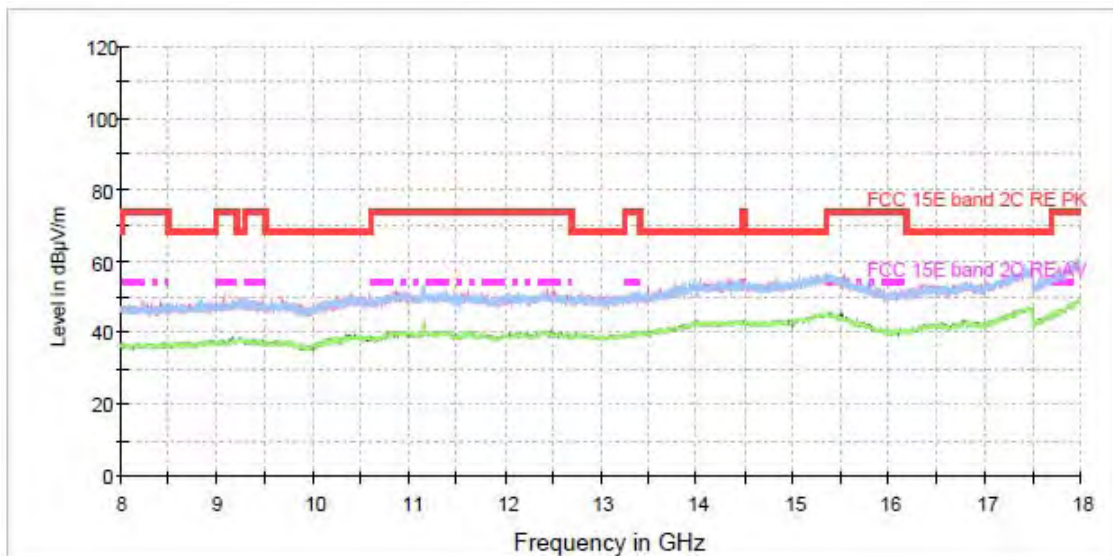

Radiates Emission from 8GHz to 18GHz



Frequency (MHz)	Peak (dBuV/m)	Average (dBuV/m)	Limit (dBuV/m)	Margin (dB)	Height (cm)	Polarization	Azimuth (deg)	Correct Factor (dB)
1136.500000	42.53	---	68.20	25.67	100.0	H	63.0	-8.2
1404.250000	---	31.80	54.00	22.20	200.0	H	346.0	-6.7
1681.625000	---	33.34	54.00	20.66	100.0	H	183.0	-5.1
1811.125000	45.12	---	68.20	23.08	200.0	H	275.0	-4.4
2150.625000	46.09	---	68.20	22.11	100.0	H	96.0	-2.7
2367.625000	---	35.11	54.00	18.89	200.0	V	58.0	-2.1
2617.875000	47.50	---	68.20	20.70	100.0	V	62.0	-0.9
3554.125000	50.11	---	68.20	18.09	200.0	H	85.0	2.6
3667.000000	---	38.06	54.00	15.94	100.0	V	251.0	3.0
4606.750000	---	39.12	54.00	14.88	100.0	H	329.0	5.2
6760.125000	52.52	---	68.20	15.68	100.0	V	51.0	8.9
7412.875000	---	41.75	54.00	12.25	100.0	V	134.0	9.8

Remark: 1. Correction Factor = Antenna factor+ Insertion loss (cable loss + amplifier gain)

802.11a CH140

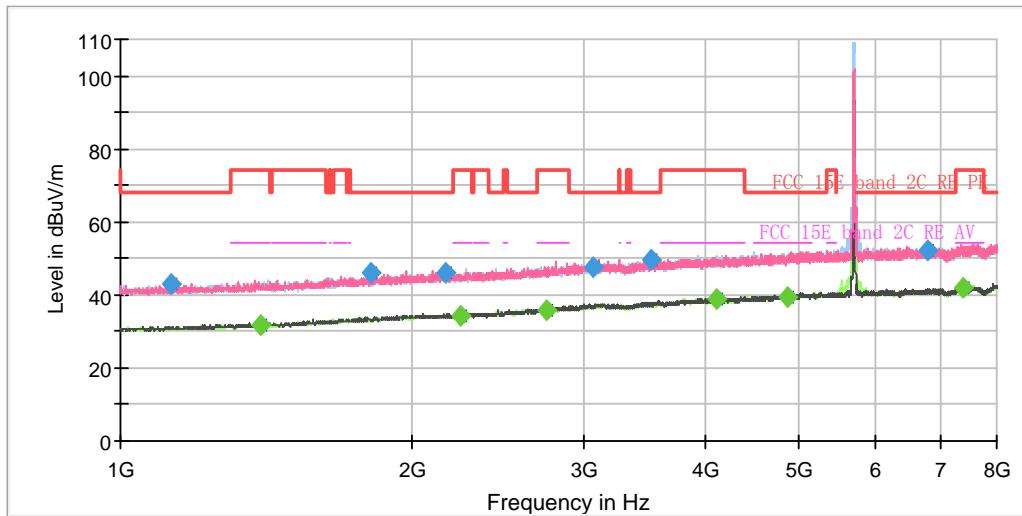

Note: The signal beyond the limit is carrier.
Radiates Emission from 1GHz to 8GHz

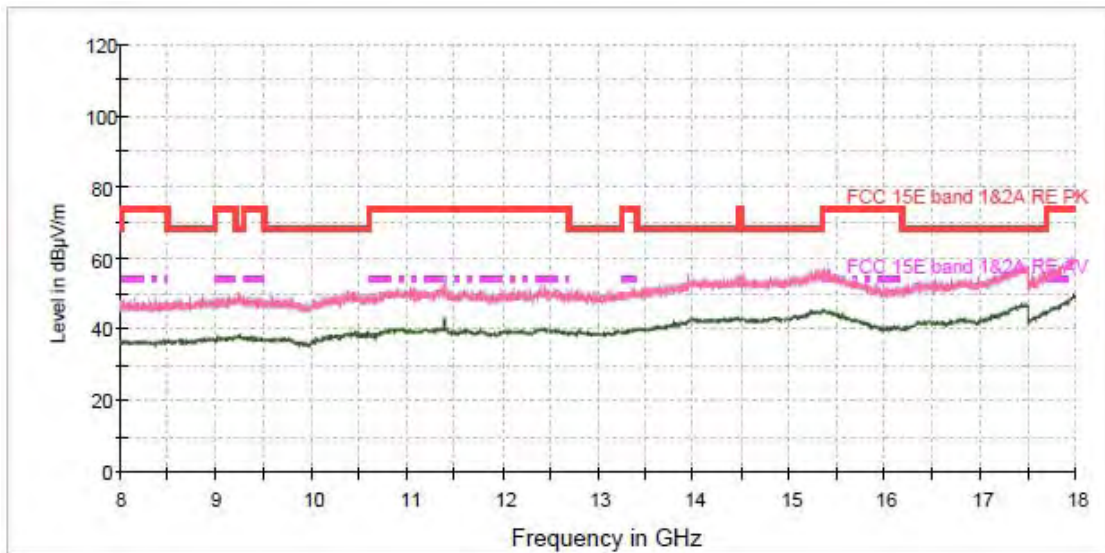

Radiates Emission from 8GHz to 18GHz



Frequency (MHz)	Peak (dBuV/m)	Average (dBuV/m)	Limit (dBuV/m)	Margin (dB)	Height (cm)	Polarization	Azimuth (deg)	Correct Factor (dB)
1127.750000	43.03	---	68.20	25.17	100.0	V	101.0	-8.2
1396.375000	---	31.76	54.00	22.24	100.0	H	354.0	-6.7
1812.000000	45.87	---	68.20	22.33	200.0	V	200.0	-4.4
2167.250000	45.93	---	68.20	22.27	200.0	H	28.0	-2.7
2241.625000	---	34.51	54.00	19.49	200.0	V	297.0	-2.5
2753.500000	---	35.92	54.00	18.08	200.0	H	44.0	-0.2
3069.375000	47.60	---	68.20	20.60	200.0	H	234.0	1.5
3523.500000	49.43	---	68.20	18.77	200.0	V	347.0	2.4
4116.750000	---	38.66	54.00	15.34	200.0	H	256.0	4.2
4865.750000	---	39.64	54.00	14.36	100.0	H	203.0	6.2
6789.875000	52.43	---	68.20	15.77	100.0	V	145.0	9.0
7377.875000	---	41.85	54.00	12.15	200.0	H	60.0	9.8

Remark: 1. Correction Factor = Antenna factor+ Insertion loss (cable loss + amplifier gain)

802.11a CH149

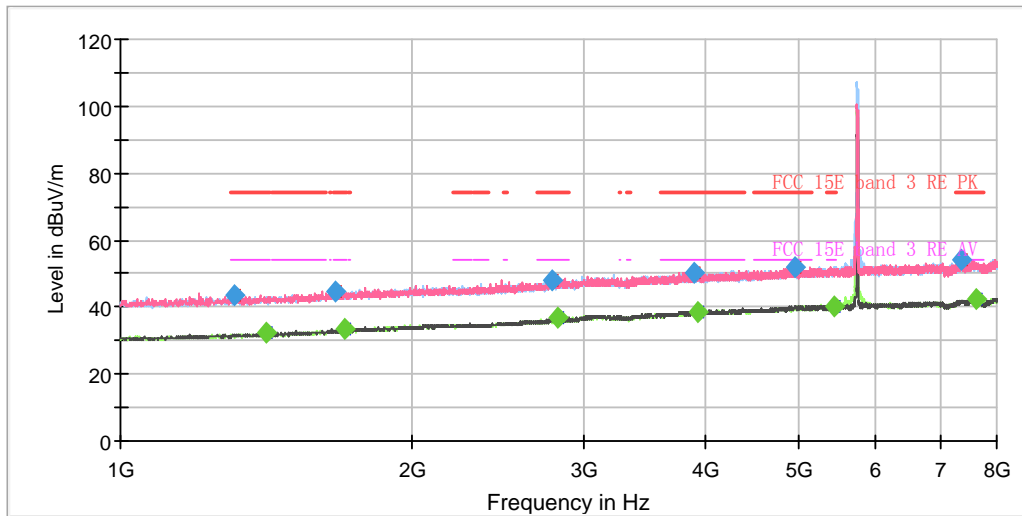

Note: The signal beyond the limit is carrier.
Radiates Emission from 1GHz to 8GHz

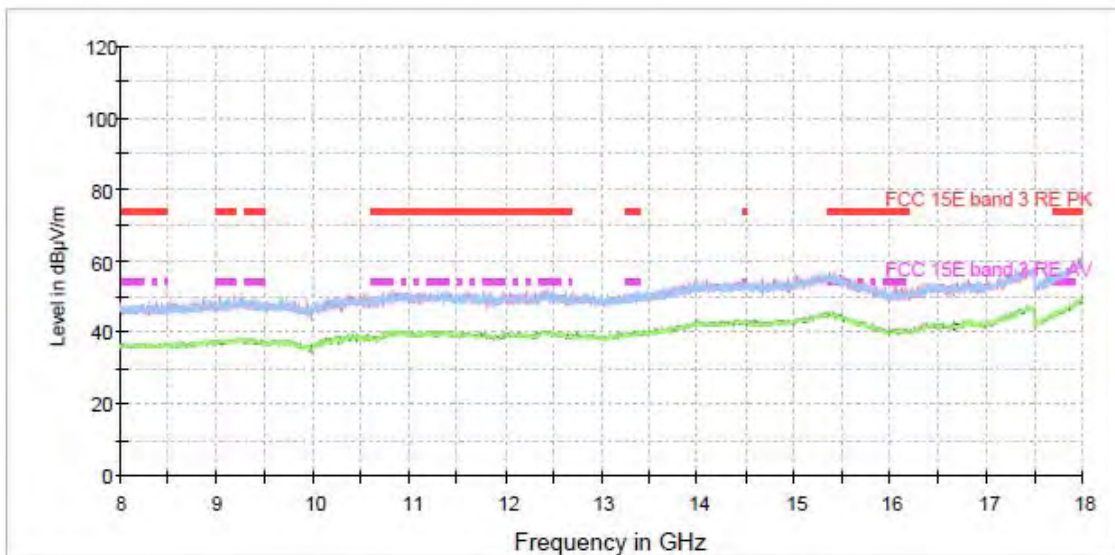

Radiates Emission from 8GHz to 18GHz



Frequency (MHz)	Peak (dBuV/m)	Average (dBuV/m)	Limit (dBuV/m)	Margin (dB)	Height (cm)	Polarization	Azimuth (deg)	Correct Factor (dB)
1308.000000	43.71	---	74.00	30.29	200.0	V	222.0	-7.2
1410.375000	---	32.16	54.00	21.84	200.0	H	0.0	-6.7
1666.750000	44.75	---	74.00	29.25	100.0	H	349.0	-5.2
1701.750000	---	33.48	54.00	20.52	200.0	H	12.0	-5.0
2785.875000	47.94	---	74.00	26.06	100.0	V	2.0	0.0
2827.875000	---	36.63	54.00	17.37	100.0	H	271.0	0.2
3902.375000	50.48	---	74.00	23.52	100.0	H	349.0	3.8
3942.625000	---	38.79	54.00	15.21	100.0	H	305.0	3.9
4955.875000	51.91	---	74.00	22.09	200.0	V	30.0	6.5
5433.625000	---	40.37	54.00	13.63	100.0	H	244.0	7.2
7343.750000	54.22	---	74.00	19.78	100.0	V	358.0	9.8
7625.500000	---	42.18	54.00	11.82	100.0	H	294.0	10.2

Remark: 1. Correction Factor = Antenna factor+ Insertion loss (cable loss + amplifier gain)

802.11a CH157

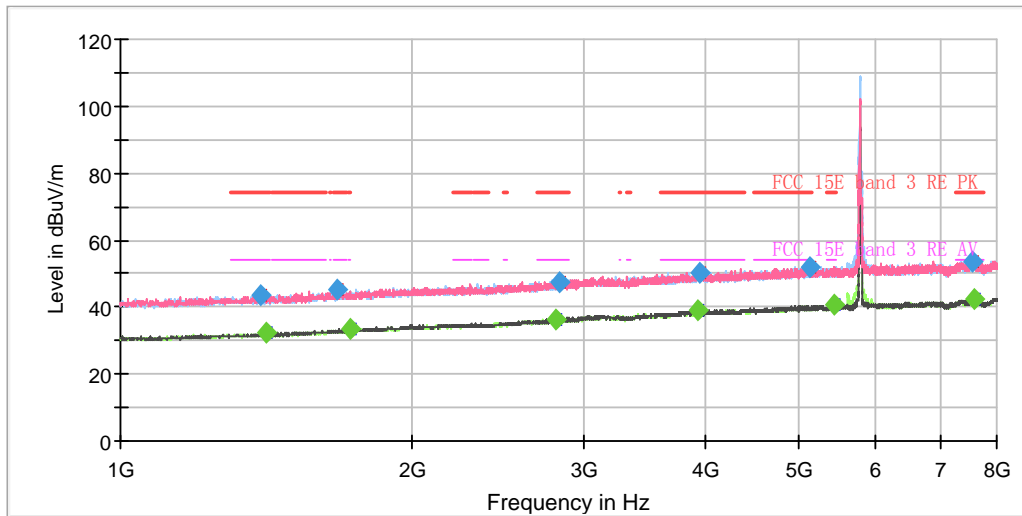

Note: The signal beyond the limit is carrier.
Radiates Emission from 1GHz to 8GHz

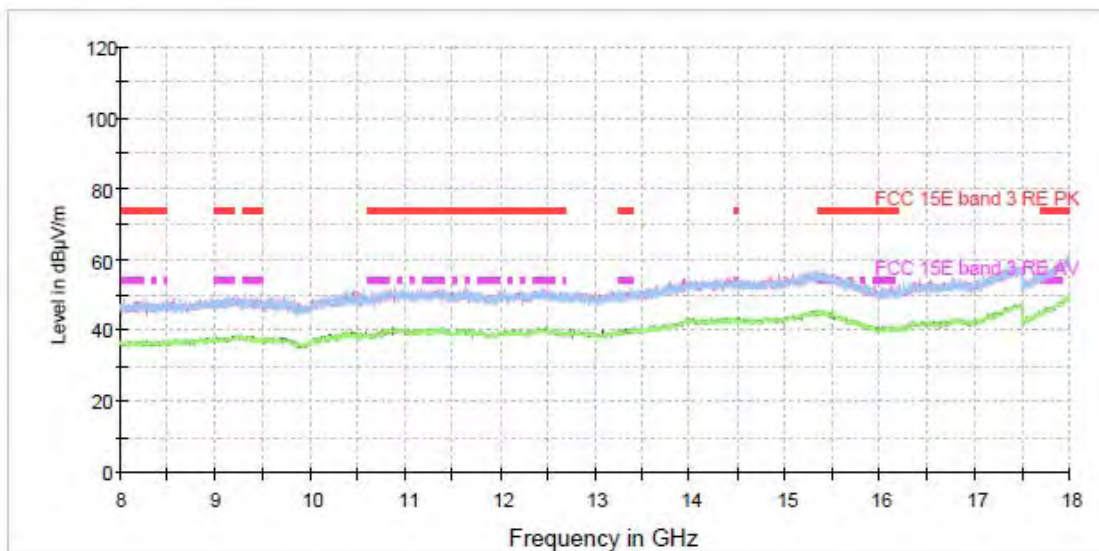

Radiates Emission from 8GHz to 18GHz



Frequency (MHz)	Peak (dBuV/m)	Average (dBuV/m)	Limit (dBuV/m)	Margin (dB)	Height (cm)	Polarization	Azimuth (deg)	Correct Factor (dB)
1395.500000	43.30	---	74.00	30.70	200.0	H	98.0	-6.7
1410.375000	---	32.17	54.00	21.83	100.0	V	99.0	-6.7
1673.750000	44.94	---	74.00	29.07	200.0	H	273.0	-5.1
1721.875000	---	33.30	54.00	20.70	200.0	V	182.0	-4.9
2808.625000	---	36.53	54.00	17.47	200.0	V	316.0	0.1
2839.250000	47.33	---	74.00	26.67	200.0	H	117.0	0.3
3937.375000	---	38.82	54.00	15.18	100.0	V	352.0	3.9
3948.750000	50.26	---	74.00	23.74	200.0	V	288.0	3.9
5137.000000	52.02	---	74.00	21.98	100.0	V	188.0	6.7
5434.500000	---	40.50	54.00	13.50	200.0	V	237.0	7.2
7541.500000	53.56	---	74.00	20.44	100.0	H	297.0	10.0
7582.625000	---	42.44	54.00	11.56	100.0	V	116.0	10.1

Remark: 1. Correction Factor = Antenna factor+ Insertion loss (cable loss + amplifier gain)



802.11a CH165

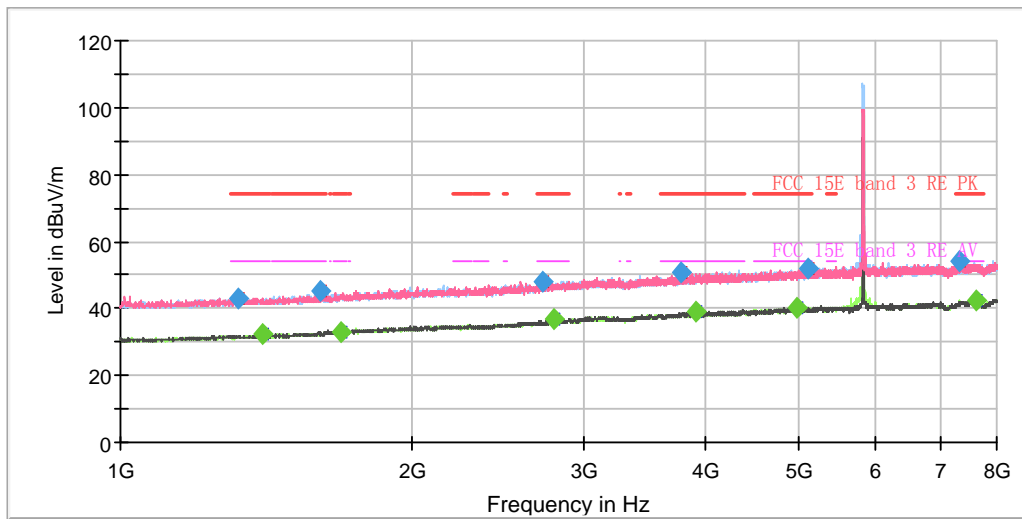

Note: The signal beyond the limit is carrier.
Radiates Emission from 1GHz to 8GHz

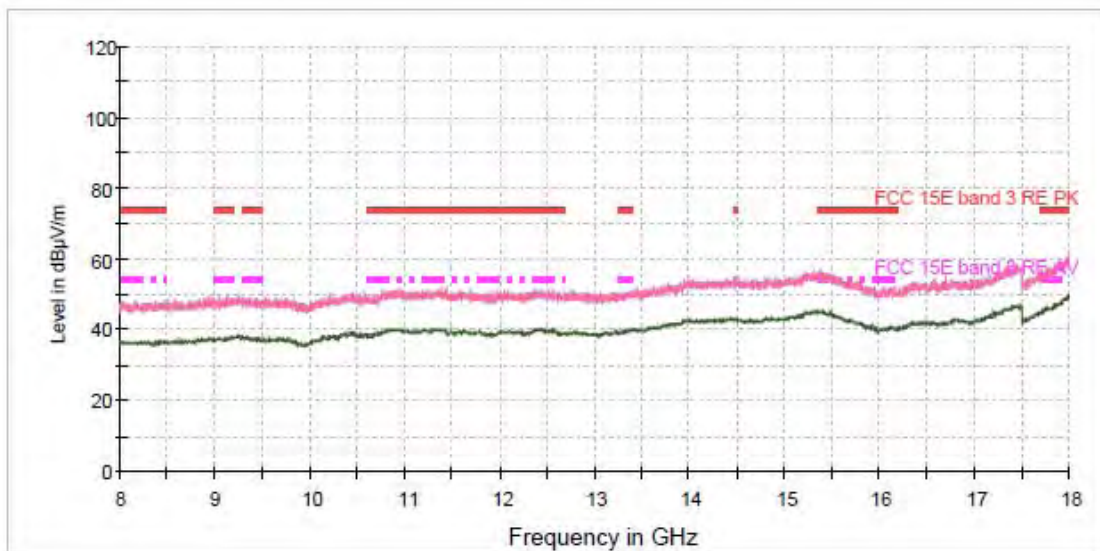

Radiates Emission from 8GHz to 18GHz



Frequency (MHz)	Peak (dBuV/m)	Average (dBuV/m)	Limit (dBuV/m)	Margin (dB)	Height (cm)	Polarization	Azimuth (deg)	Correct Factor (dB)
1320.250000	43.20	---	74.00	30.80	100.0	V	341.0	-7.1
1400.750000	---	32.13	54.00	21.87	100.0	V	330.0	-6.7
1609.000000	45.16	---	74.00	28.84	100.0	H	57.0	-5.5
1686.000000	---	33.17	54.00	20.83	200.0	V	303.0	-5.1
2729.000000	47.85	---	74.00	26.15	100.0	V	286.0	-0.3
2794.625000	---	36.77	54.00	17.23	200.0	H	87.0	0.0
3774.625000	50.69	---	74.00	23.31	100.0	H	125.0	3.4
3920.750000	---	38.96	54.00	15.04	200.0	H	9.0	3.8
4984.750000	---	40.36	54.00	13.64	200.0	V	0.0	6.6
5113.375000	51.92	---	74.00	22.08	200.0	V	67.0	6.6
7322.750000	53.89	---	74.00	20.11	200.0	V	297.0	9.7
7621.125000	---	42.41	54.00	11.59	100.0	V	124.0	10.2

Remark: 1. Correction Factor = Antenna factor+ Insertion loss (cable loss + amplifier gain)

802.11n (HT20) CH36

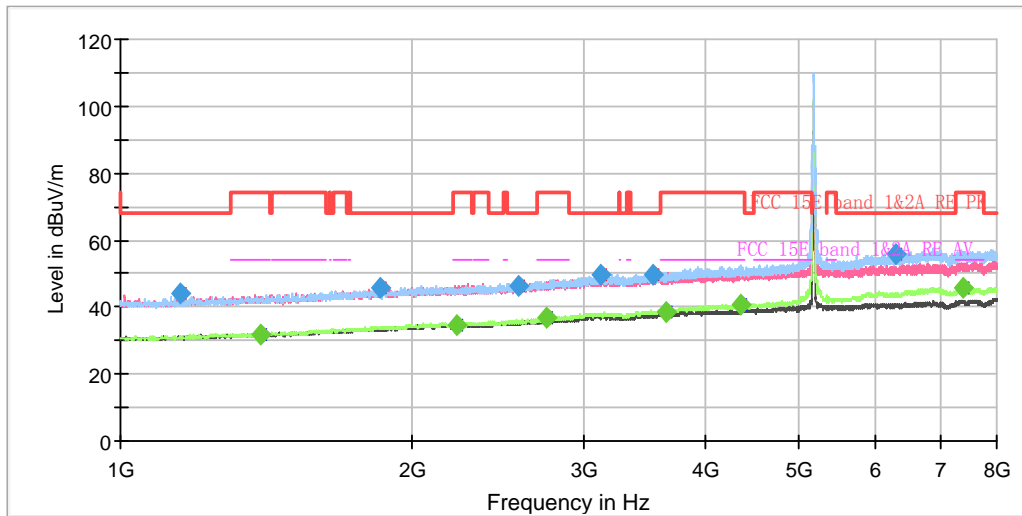

Note: The signal beyond the limit is carrier.
Radiates Emission from 1GHz to 8GHz

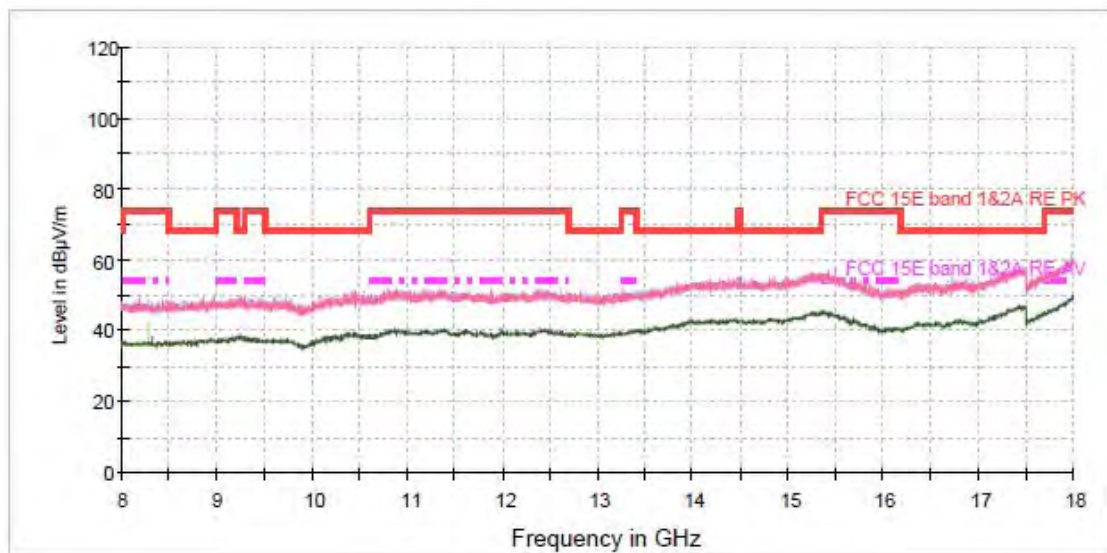

Radiates Emission from 8GHz to 18GHz



Frequency (MHz)	Peak (dBuV/m)	Average (dBuV/m)	Limit (dBuV/m)	Margin (dB)	Height (cm)	Polarization	Azimuth (deg)	Correct Factor (dB)
1154.000000	44.04	---	68.20	24.16	200.0	V	107.0	-8.1
1393.750000	---	31.84	54.00	22.16	200.0	V	107.0	-6.7
1850.500000	45.92	---	68.20	22.28	200.0	H	268.0	-4.2
2225.875000	---	34.80	54.00	19.20	200.0	H	356.0	-2.6
2576.750000	46.60	---	68.20	21.60	200.0	H	350.0	-1.1
2752.625000	---	36.76	54.00	17.24	100.0	H	28.0	-0.2
3121.000000	49.59	---	68.20	18.61	100.0	H	0.0	1.6
3536.625000	49.88	---	68.20	18.32	200.0	H	0.0	2.5
3650.375000	---	38.72	54.00	15.28	100.0	H	58.0	2.8
4348.625000	---	40.95	54.00	13.05	100.0	H	99.0	4.7
6293.750000	55.97	---	68.20	12.23	200.0	H	237.0	8.2
7374.375000	---	46.04	54.00	7.96	200.0	H	321.0	9.8

Remark: 1. Correction Factor = Antenna factor+ Insertion loss (cable loss + amplifier gain)

802.11n (HT20) CH40

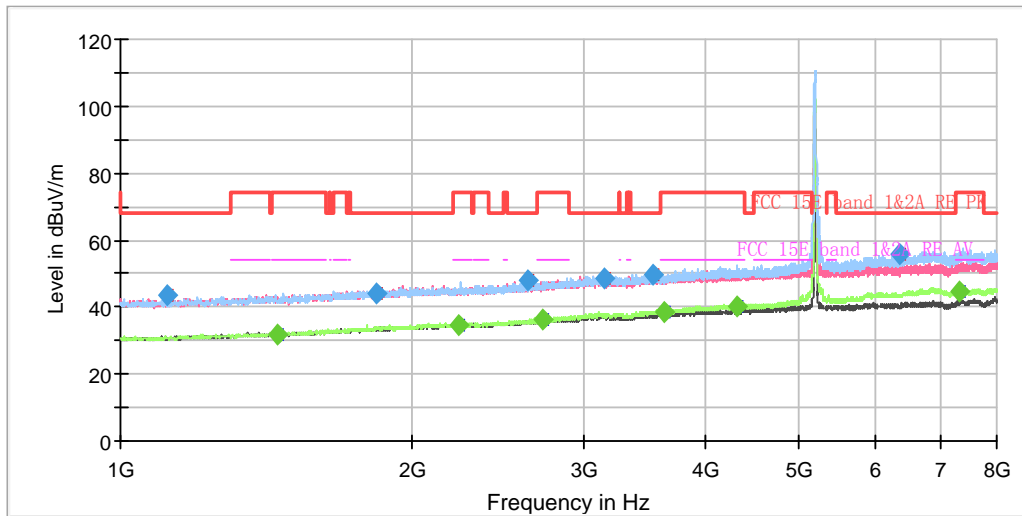

Note: The signal beyond the limit is carrier.
Radiates Emission from 1GHz to 8GHz

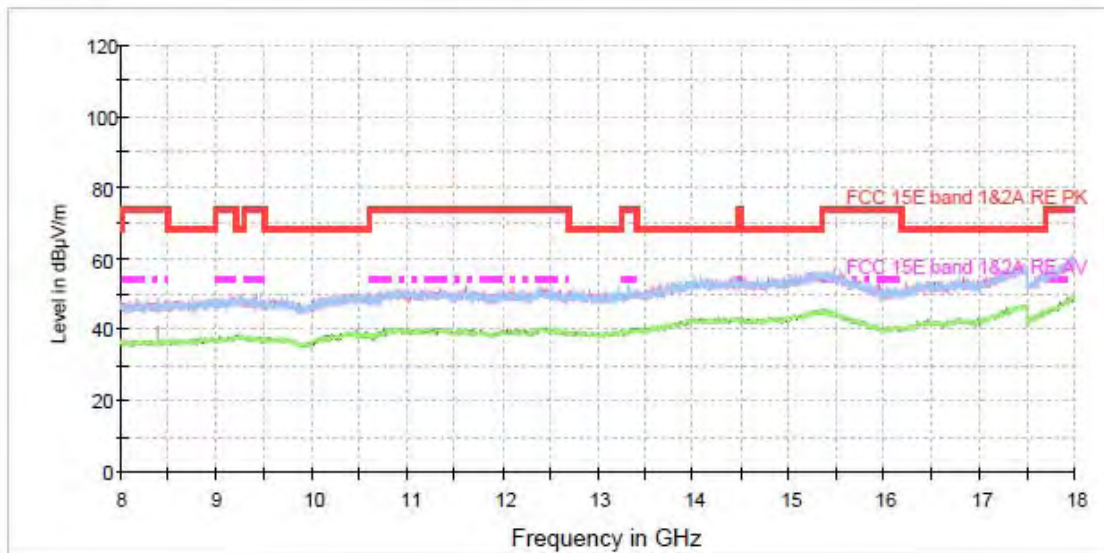

Radiates Emission from 8GHz to 18GHz



Frequency (MHz)	Peak (dBuV/m)	Average (dBuV/m)	Limit (dBuV/m)	Margin (dB)	Height (cm)	Polarization	Azimuth (deg)	Correct Factor (dB)
1117.250000	43.34	---	68.20	24.86	100.0	V	101.0	-8.2
1453.250000	---	32.02	54.00	21.99	200.0	V	210.0	-6.4
1835.625000	44.28	---	68.20	23.92	100.0	H	48.0	-4.2
2226.750000	---	34.70	54.00	19.30	100.0	H	118.0	-2.6
2633.625000	48.23	---	68.20	19.97	200.0	H	297.0	-0.8
2729.000000	---	36.38	54.00	17.62	100.0	H	42.0	-0.3
3156.875000	48.50	---	68.20	19.70	100.0	V	0.0	1.6
3537.500000	49.52	---	68.20	18.68	100.0	H	65.0	2.5
3639.875000	---	38.67	54.00	15.33	100.0	H	37.0	2.8
4311.000000	---	40.42	54.00	13.58	100.0	H	48.0	4.6
6342.750000	55.59	---	68.20	12.61	100.0	H	59.0	8.2
7315.750000	---	44.75	54.00	9.25	100.0	H	19.0	9.7

Remark: 1. Correction Factor = Antenna factor+ Insertion loss (cable loss + amplifier gain)

802.11n (HT20) CH48

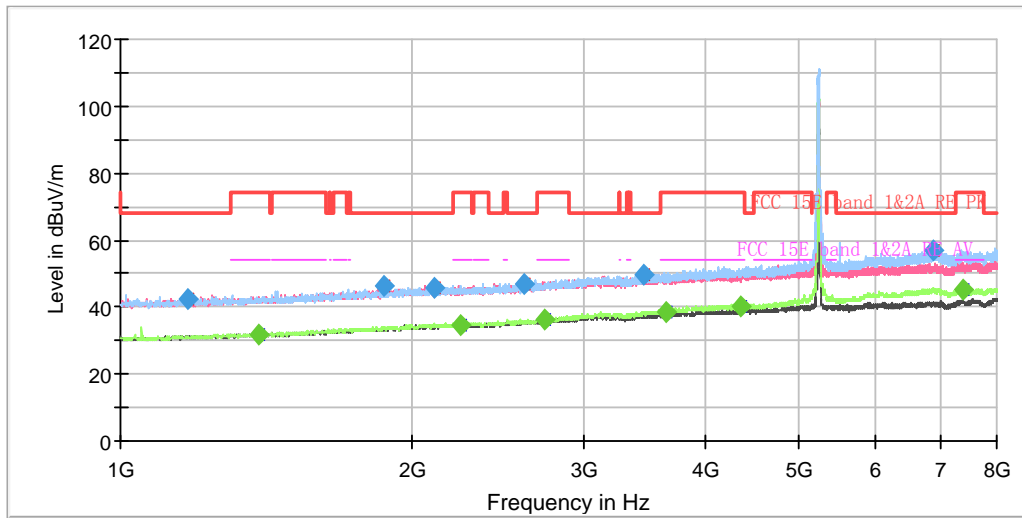

Note: The signal beyond the limit is carrier.
Radiates Emission from 1GHz to 8GHz

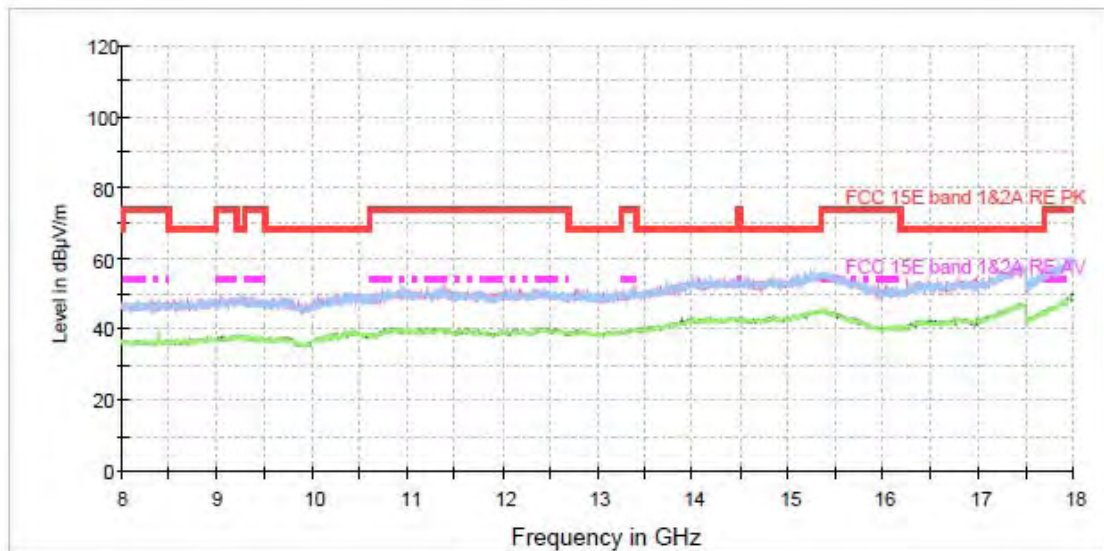

Radiates Emission from 8GHz to 18GHz



Frequency (MHz)	Peak (dBuV/m)	Average (dBuV/m)	Limit (dBuV/m)	Margin (dB)	Height (cm)	Polarization	Azimuth (deg)	Correct Factor (dB)
1174.125000	42.62	---	68.20	25.58	100.0	H	331.0	-7.9
1387.625000	---	31.84	54.00	22.16	100.0	H	331.0	-6.8
1866.250000	46.21	---	68.20	21.99	100.0	V	13.0	-4.1
2104.250000	45.50	---	68.20	22.70	200.0	H	52.0	-2.9
2236.375000	---	34.68	54.00	19.32	100.0	H	326.0	-2.5
2602.125000	46.93	---	68.20	21.27	100.0	H	285.0	-1.0
2735.125000	---	36.36	54.00	17.64	100.0	H	342.0	-0.3
3457.875000	49.47	---	68.20	18.73	100.0	V	107.0	2.2
3651.250000	---	38.76	54.00	15.24	100.0	H	262.0	2.8
4353.000000	---	40.38	54.00	13.62	100.0	H	274.0	4.7
6880.875000	56.92	---	68.20	11.28	100.0	H	285.0	9.1
7395.375000	---	45.43	54.00	8.57	100.0	H	303.0	9.8

Remark: 1. Correction Factor = Antenna factor+ Insertion loss (cable loss + amplifier gain)

802.11n (HT20) CH52

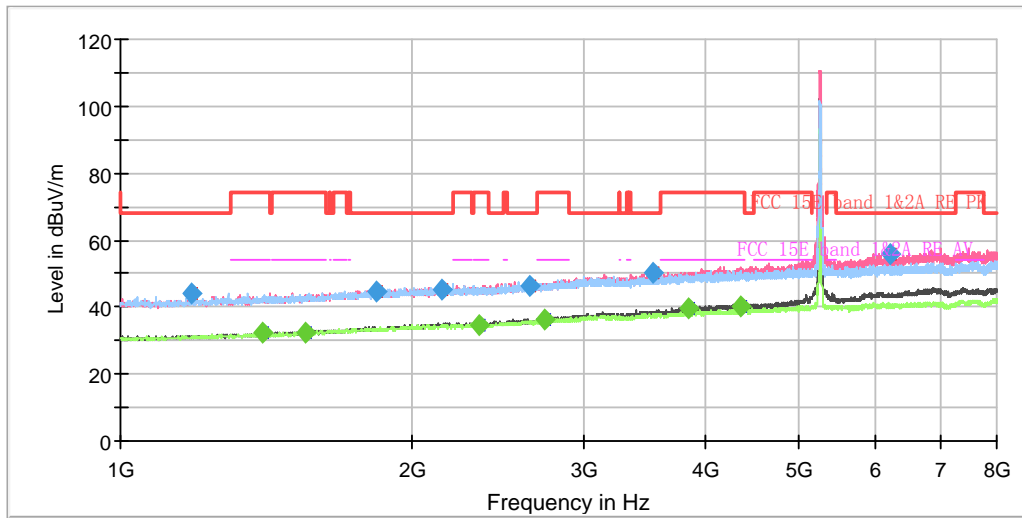

Note: The signal beyond the limit is carrier.
Radiates Emission from 1GHz to 8GHz

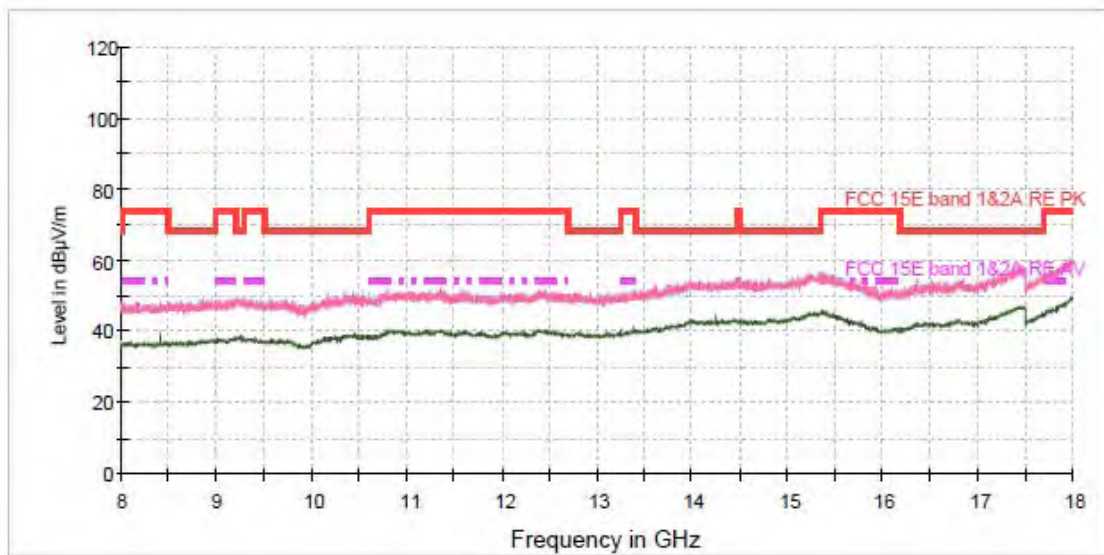

Radiates Emission from 8GHz to 18GHz



Frequency (MHz)	Peak (dBuV/m)	Average (dBuV/m)	Limit (dBuV/m)	Margin (dB)	Height (cm)	Polarization	Azimuth (deg)	Correct Factor (dB)
1184.625000	44.09	---	68.20	24.11	100.0	H	227.0	-7.8
1398.125000	---	32.20	54.00	21.80	200.0	V	331.0	-6.7
1547.750000	---	32.43	54.00	21.57	100.0	V	221.0	-5.9
1837.375000	44.92	---	68.20	23.28	200.0	V	287.0	-4.2
2142.750000	45.45	---	68.20	22.75	200.0	V	222.0	-2.8
2347.500000	---	34.83	54.00	19.17	200.0	V	258.0	-2.1
2642.375000	46.59	---	68.20	21.61	200.0	V	308.0	-0.8
2733.375000	---	36.43	54.00	17.57	200.0	V	281.0	-0.3
3535.750000	50.45	---	68.20	17.75	200.0	V	358.0	2.5
3857.750000	---	39.61	54.00	14.39	200.0	V	281.0	3.7
4354.750000	---	40.29	54.00	13.71	200.0	V	342.0	4.7
6216.750000	55.73	---	68.20	12.47	200.0	V	308.0	8.1

Remark: 1. Correction Factor = Antenna factor+ Insertion loss (cable loss + amplifier gain)

802.11n (HT20) CH60

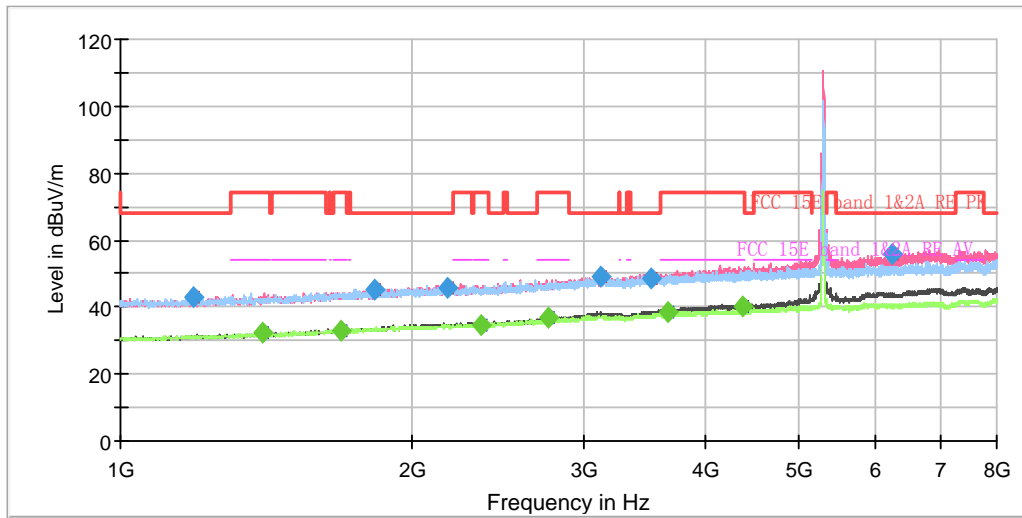

Note: The signal beyond the limit is carrier.
Radiates Emission from 1GHz to 8GHz

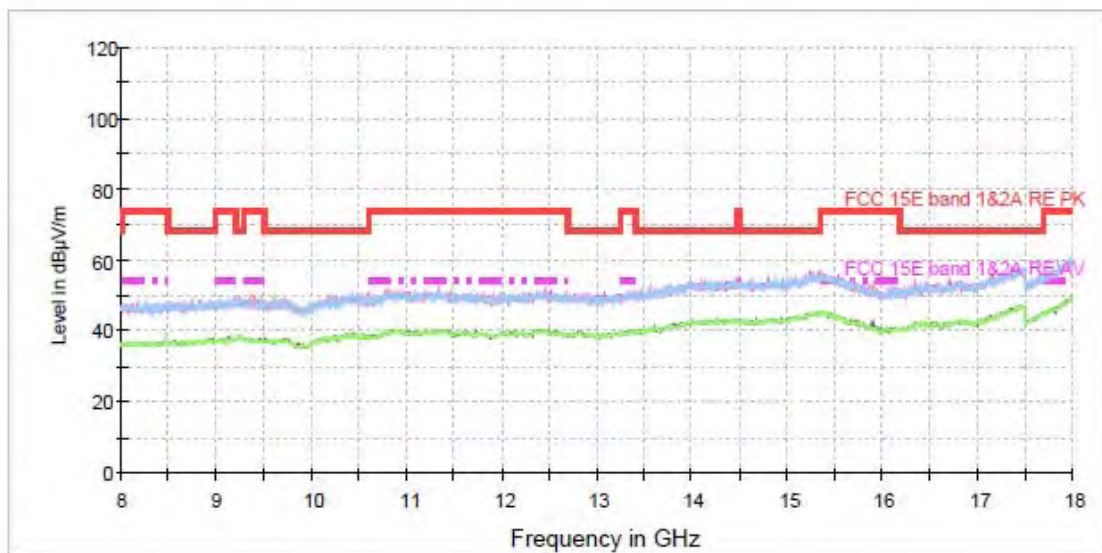

Radiates Emission from 8GHz to 18GHz



Frequency (MHz)	Peak (dBuV/m)	Average (dBuV/m)	Limit (dBuV/m)	Margin (dB)	Height (cm)	Polarization	Azimuth (deg)	Correct Factor (dB)
1188.125000	43.17	---	68.20	25.03	100.0	V	22.0	-7.8
1399.875000	---	32.16	54.00	21.84	200.0	V	271.0	-6.7
1684.250000	---	32.97	54.00	21.03	200.0	V	337.0	-5.1
1830.375000	45.25	---	68.20	22.95	200.0	V	293.0	-4.2
2169.875000	45.93	---	68.20	22.27	200.0	V	0.0	-2.7
2351.875000	---	34.67	54.00	19.33	200.0	V	337.0	-2.1
2758.750000	---	36.70	54.00	17.30	200.0	V	354.0	-0.2
3121.000000	48.89	---	68.20	19.31	100.0	V	33.0	1.6
3522.625000	48.80	---	68.20	19.40	200.0	V	0.0	2.4
3661.750000	---	38.60	54.00	15.40	200.0	V	265.0	2.9
4367.875000	---	40.32	54.00	13.68	200.0	V	287.0	4.8
6238.625000	55.66	---	68.20	12.54	200.0	V	343.0	8.1

Remark: 1. Correction Factor = Antenna factor+ Insertion loss (cable loss + amplifier gain)

802.11n (HT20) CH64

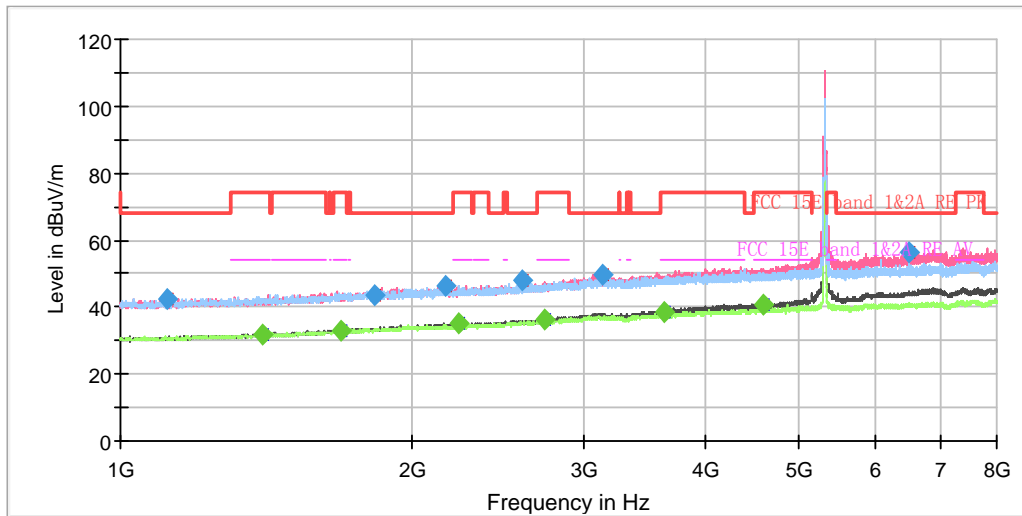

Note: The signal beyond the limit is carrier.
Radiates Emission from 1GHz to 8GHz

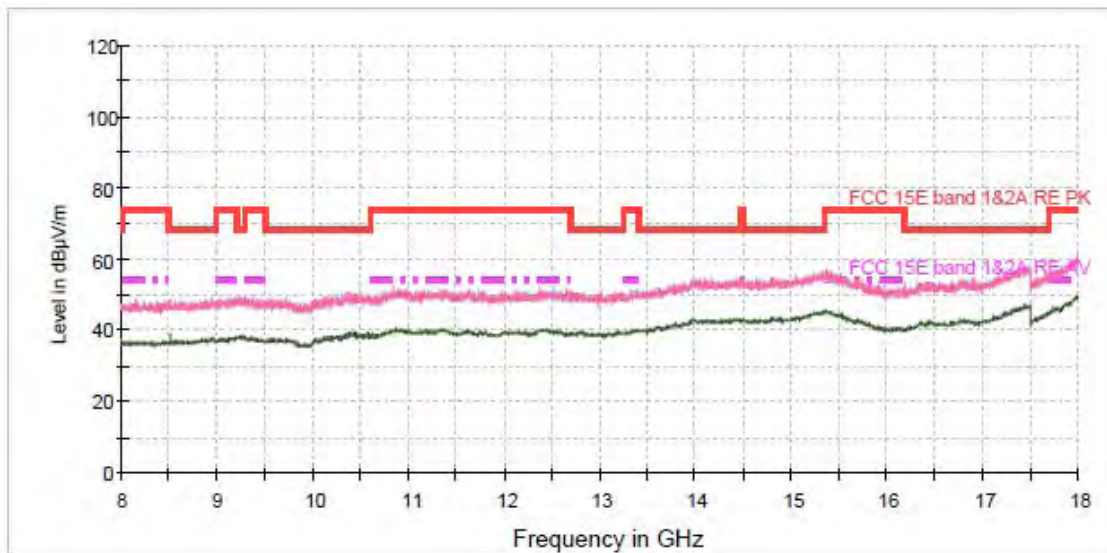

Radiates Emission from 8GHz to 18GHz



Frequency (MHz)	Peak (dBuV/m)	Average (dBuV/m)	Limit (dBuV/m)	Margin (dB)	Height (cm)	Polarization	Azimuth (deg)	Correct Factor (dB)
1117.250000	42.21	---	68.20	25.99	200.0	H	195.0	-8.2
1399.875000	---	32.05	54.00	21.95	100.0	H	14.0	-6.7
1686.875000	---	33.16	54.00	20.84	200.0	H	163.0	-5.1
1830.375000	43.81	---	68.20	24.39	200.0	V	7.0	-4.2
2158.500000	46.37	---	68.20	21.83	100.0	V	24.0	-2.7
2231.125000	---	34.91	54.00	19.09	200.0	V	30.0	-2.6
2594.250000	48.06	---	68.20	20.14	200.0	H	0.0	-1.0
2735.125000	---	36.38	54.00	17.62	100.0	V	0.0	-0.3
3140.250000	49.88	---	68.20	18.32	200.0	V	35.0	1.6
3630.250000	---	38.59	54.00	15.41	100.0	V	24.0	2.7
4605.875000	---	40.57	54.00	13.43	200.0	V	63.0	5.2
6505.500000	56.40	---	68.20	11.80	200.0	V	30.0	8.6

Remark: 1. Correction Factor = Antenna factor+ Insertion loss (cable loss + amplifier gain)

802.11n (HT20) CH100

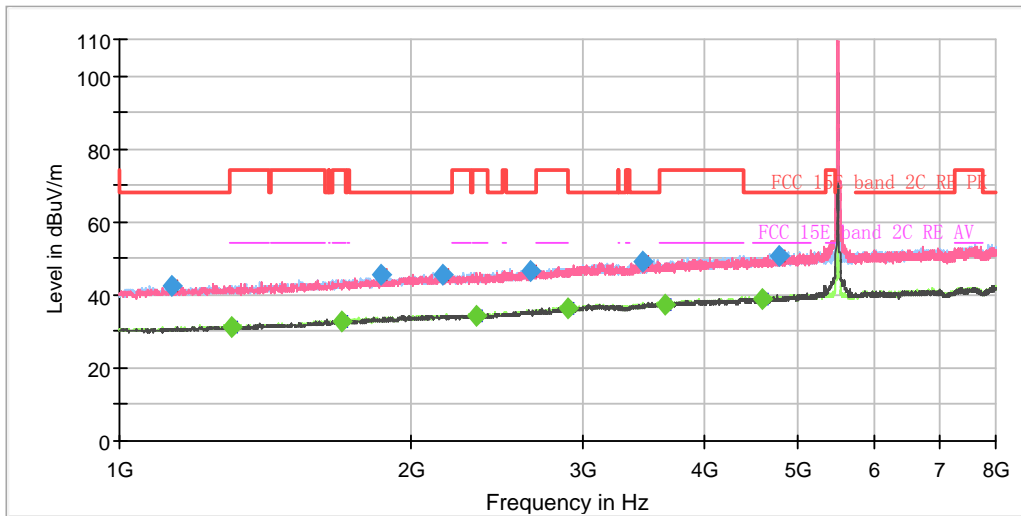

Note: The signal beyond the limit is carrier.
Radiates Emission from 1GHz to 8GHz

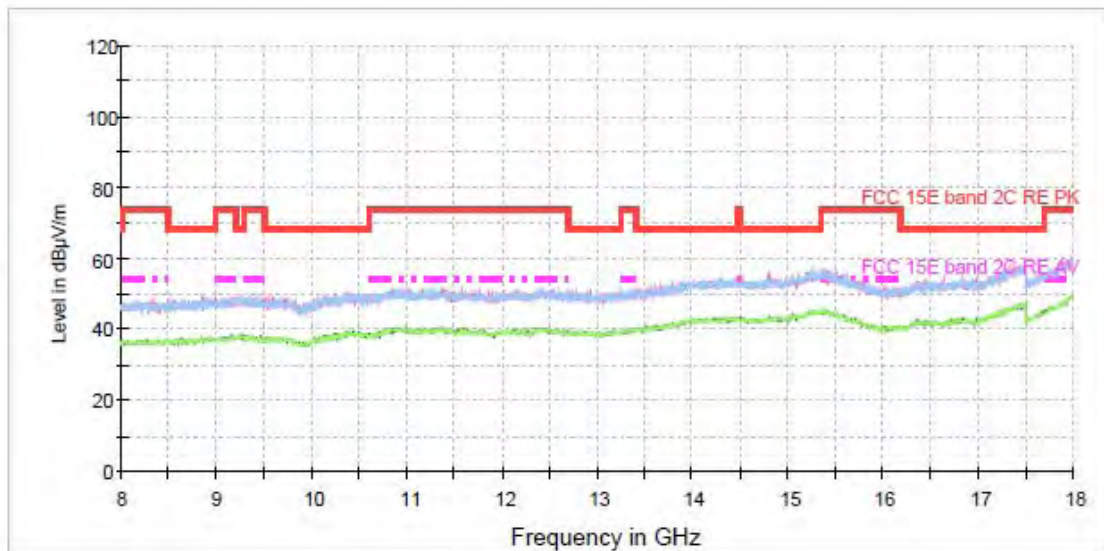

Radiates Emission from 8GHz to 18GHz



Frequency (MHz)	Peak (dBuV/m)	Average (dBuV/m)	Limit (dBuV/m)	Margin (dB)	Height (cm)	Polarization	Azimuth (deg)	Correct Factor (dB)
1131.250000	42.40	---	68.20	25.80	200.0	V	272.0	-8.2
1307.125000	---	31.29	54.00	22.71	200.0	H	11.0	-7.2
1693.875000	---	32.96	54.00	21.04	100.0	H	0.0	-5.1
1859.250000	45.32	---	68.20	22.88	200.0	V	29.0	-4.2
2151.500000	45.77	---	68.20	22.43	100.0	V	338.0	-2.7
2334.375000	---	34.49	54.00	19.51	200.0	H	231.0	-2.2
2646.750000	46.33	---	68.20	21.87	200.0	H	119.0	-0.8
2902.250000	---	36.57	54.00	17.43	100.0	H	70.0	0.5
3454.375000	49.20	---	68.20	19.00	200.0	H	299.0	2.2
3646.875000	---	37.51	54.00	16.49	100.0	H	248.0	2.8
4603.250000	---	39.06	54.00	14.94	200.0	H	114.0	5.2
4786.125000	50.84	---	68.20	17.36	100.0	H	288.0	5.8

Remark: 1. Correction Factor = Antenna factor+ Insertion loss (cable loss + amplifier gain)

802.11n (HT20) CH116

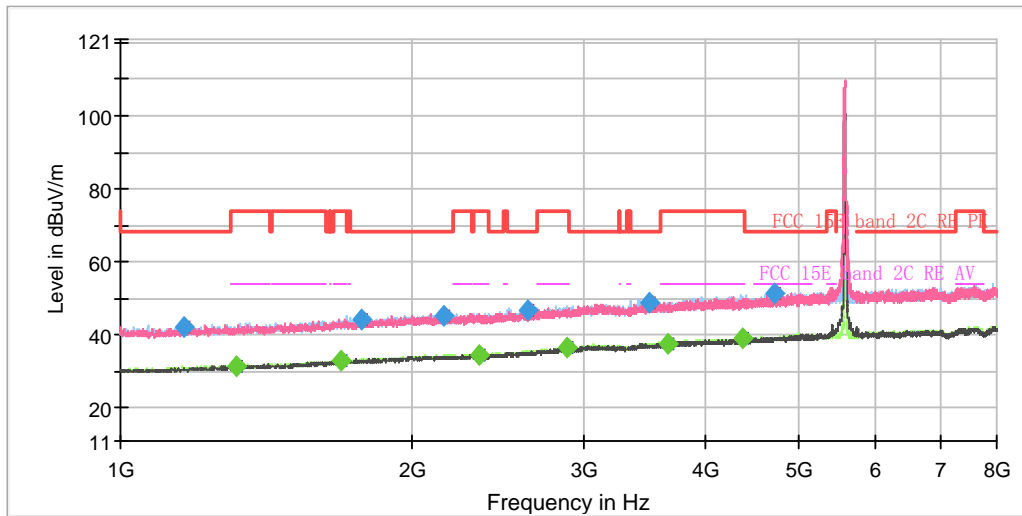

Note: The signal beyond the limit is carrier.
Radiates Emission from 1GHz to 8GHz

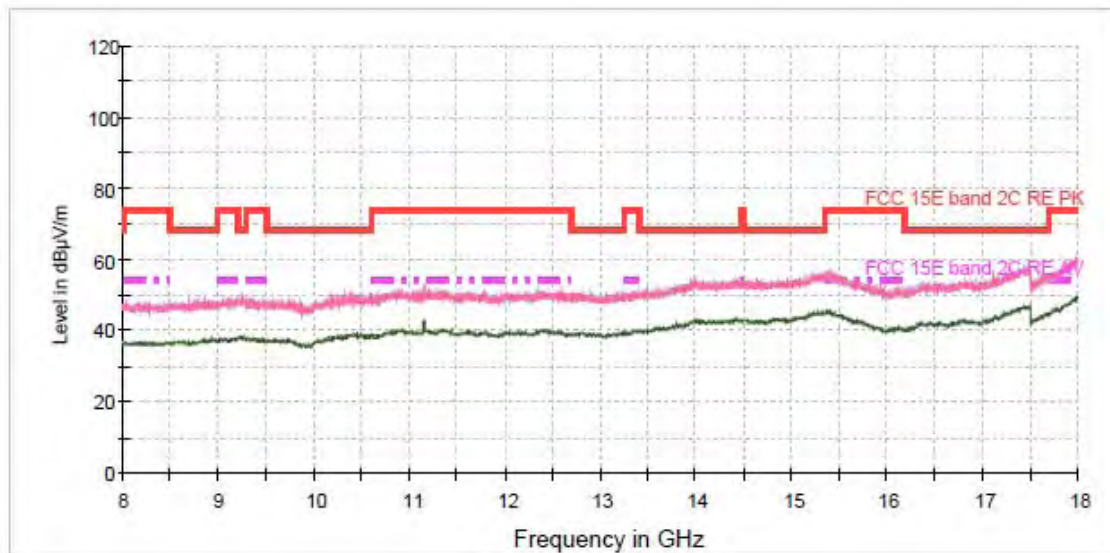

Radiates Emission from 8GHz to 18GHz



Frequency (MHz)	Peak (dBuV/m)	Average (dBuV/m)	Limit (dBuV/m)	Margin (dB)	Height (cm)	Polarization	Azimuth (deg)	Correct Factor (dB)
1162.750000	42.14	---	68.20	26.06	200.0	V	30.0	-8.0
1314.125000	---	31.28	54.00	22.72	200.0	H	50.0	-7.2
1690.375000	---	32.82	54.00	21.18	100.0	H	148.0	-5.1
1775.250000	44.20	---	68.20	24.00	200.0	H	148.0	-4.6
2148.875000	45.20	---	68.20	23.00	100.0	H	170.0	-2.7
2345.750000	---	34.36	54.00	19.64	200.0	H	6.0	-2.1
2634.500000	47.03	---	68.20	21.17	200.0	H	73.0	-0.8
2887.375000	---	36.44	54.00	17.56	100.0	H	95.0	0.5
3503.375000	48.99	---	68.20	19.21	200.0	V	301.0	2.3
3662.625000	---	37.74	54.00	16.26	200.0	H	33.0	2.9
4375.750000	---	39.29	54.00	14.71	100.0	H	50.0	4.8
4713.500000	51.19	---	68.20	17.01	200.0	V	178.0	5.6

Remark: 1. Correction Factor = Antenna factor+ Insertion loss (cable loss + amplifier gain)

802.11n (HT20) CH140

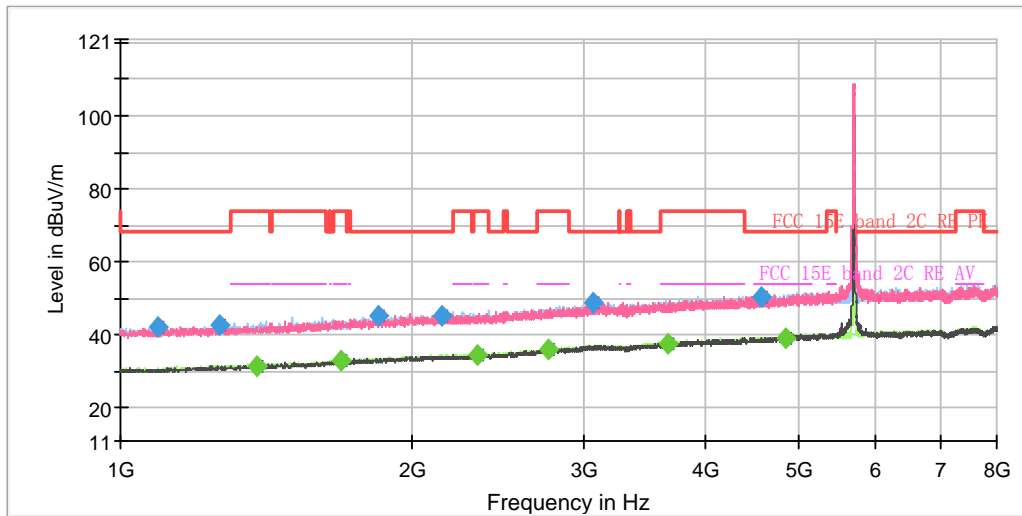

Note: The signal beyond the limit is carrier.
Radiates Emission from 1GHz to 8GHz

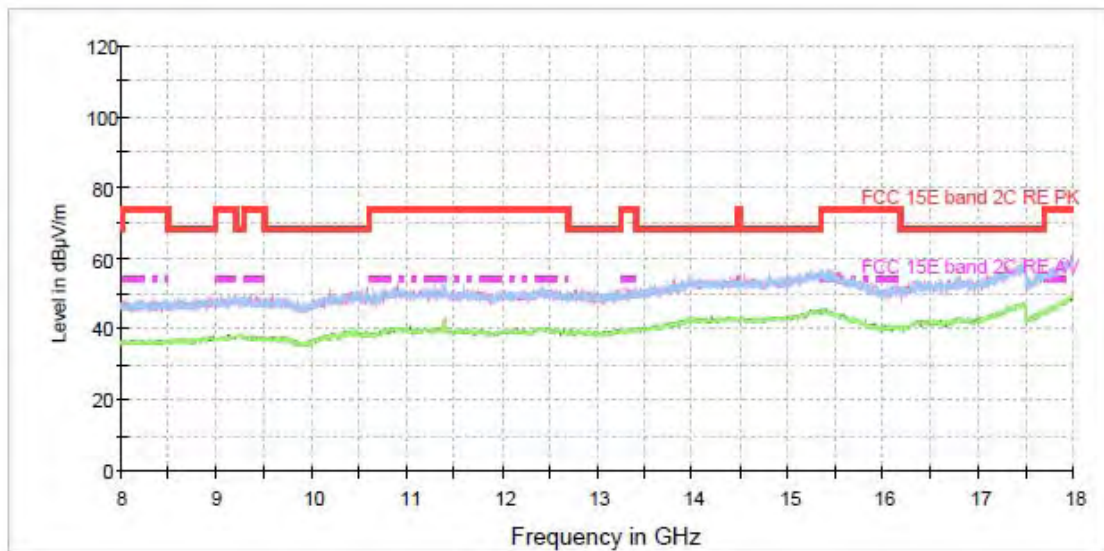

Radiates Emission from 8GHz to 18GHz



Frequency (MHz)	Peak (dBuV/m)	Average (dBuV/m)	Limit (dBuV/m)	Margin (dB)	Height (cm)	Polarization	Azimuth (deg)	Correct Factor (dB)
1092.750000	42.37	---	68.20	25.83	200.0	V	325.0	-8.4
1266.000000	42.79	---	68.20	25.41	200.0	V	95.0	-7.4
1380.625000	---	31.45	54.00	22.55	200.0	H	0.0	-6.8
1687.750000	---	33.07	54.00	20.93	100.0	H	84.0	-5.1
1840.875000	45.03	---	68.20	23.17	200.0	H	18.0	-4.3
2139.250000	45.18	---	68.20	23.02	100.0	H	0.0	-2.8
2336.125000	---	34.57	54.00	19.43	200.0	H	95.0	-2.2
2759.625000	---	36.14	54.00	17.86	200.0	H	324.0	-0.2
3076.375000	48.85	---	68.20	19.35	100.0	H	56.0	1.5
3672.250000	---	37.60	54.00	16.40	200.0	H	324.0	3.0
4572.625000	50.33	---	68.20	17.87	100.0	V	308.0	5.2
4854.375000	---	39.29	54.00	14.71	200.0	H	156.0	6.1

Remark: 1. Correction Factor = Antenna factor+ Insertion loss (cable loss + amplifier gain)

802.11n (HT20) CH149

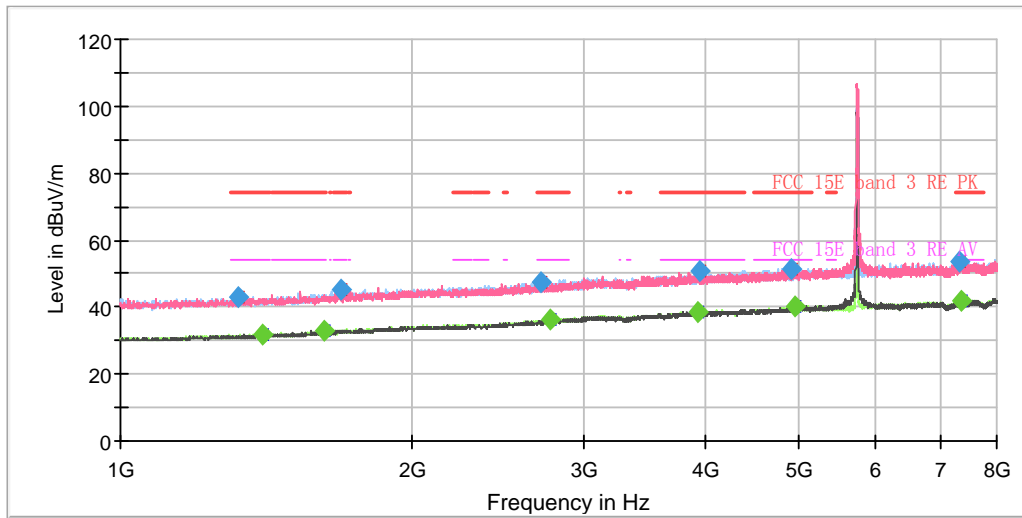

Note: The signal beyond the limit is carrier.
Radiates Emission from 1GHz to 8GHz

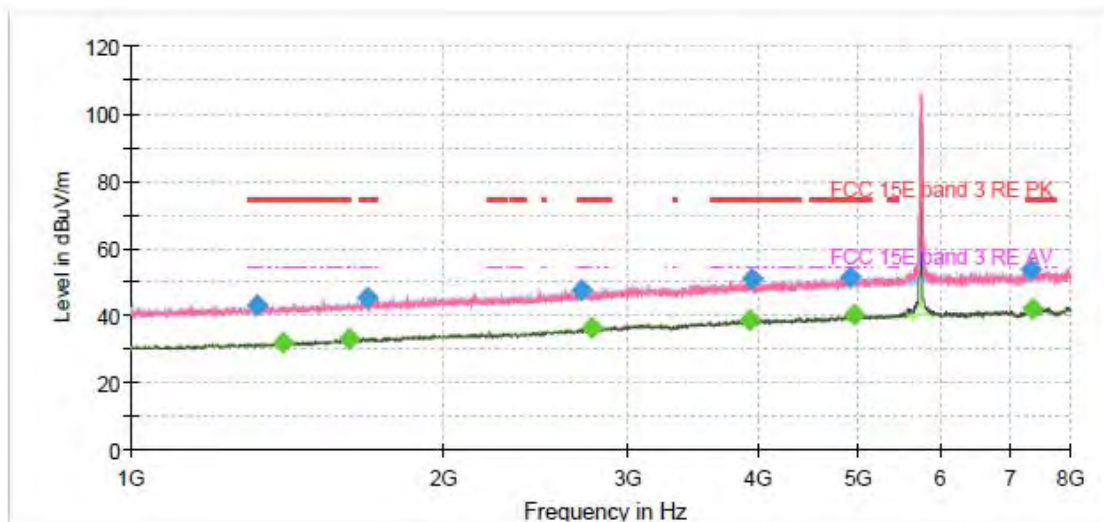

Radiates Emission from 8GHz to 18GHz



Frequency (MHz)	Peak (dBuV/m)	Average (dBuV/m)	Limit (dBuV/m)	Margin (dB)	Height (cm)	Polarization	Azimuth (deg)	Correct Factor (dB)
1323.750000	42.73	---	74.00	31.27	200.0	V	330.0	-7.1
1399.875000	---	31.91	54.00	22.09	100.0	H	60.0	-6.7
1619.500000	---	33.01	54.00	20.99	200.0	H	160.0	-5.5
1689.500000	45.09	---	74.00	28.91	200.0	V	34.0	-5.1
2711.500000	47.46	---	74.00	26.54	100.0	H	303.0	-0.4
2775.375000	---	36.12	54.00	17.88	200.0	H	11.0	-0.1
3939.125000	---	38.50	54.00	15.50	100.0	H	303.0	3.9
3948.750000	50.67	---	74.00	23.33	200.0	H	33.0	3.9
4904.250000	51.55	---	74.00	22.45	100.0	H	149.0	6.4
4949.750000	---	40.13	54.00	13.87	200.0	H	22.0	6.5
7329.750000	53.44	---	74.00	20.56	100.0	V	146.0	9.7
7340.250000	---	42.01	54.00	11.99	200.0	H	186.0	9.8

Remark: 1. Correction Factor = Antenna factor+ Insertion loss (cable loss + amplifier gain)

802.11n (HT20) CH157

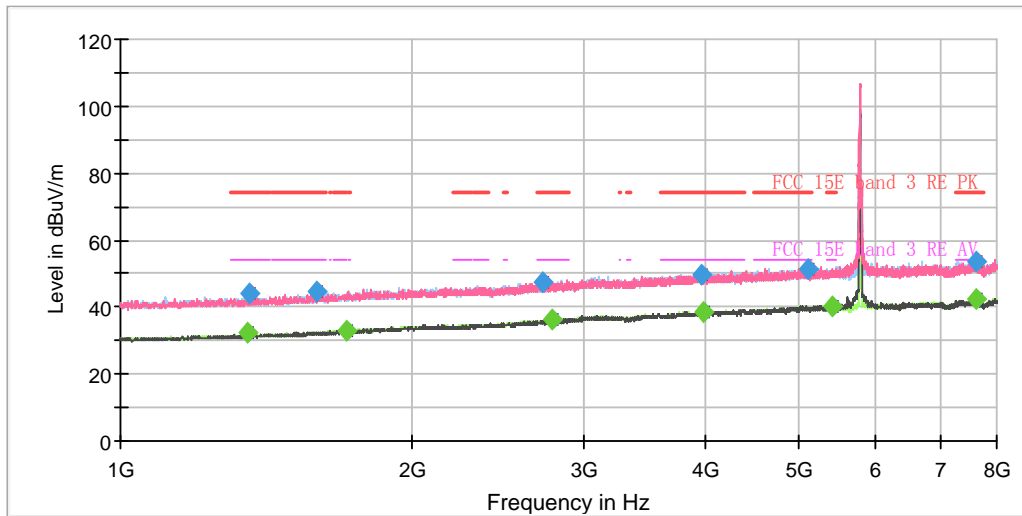

Note: The signal beyond the limit is carrier.
Radiates Emission from 1GHz to 8GHz

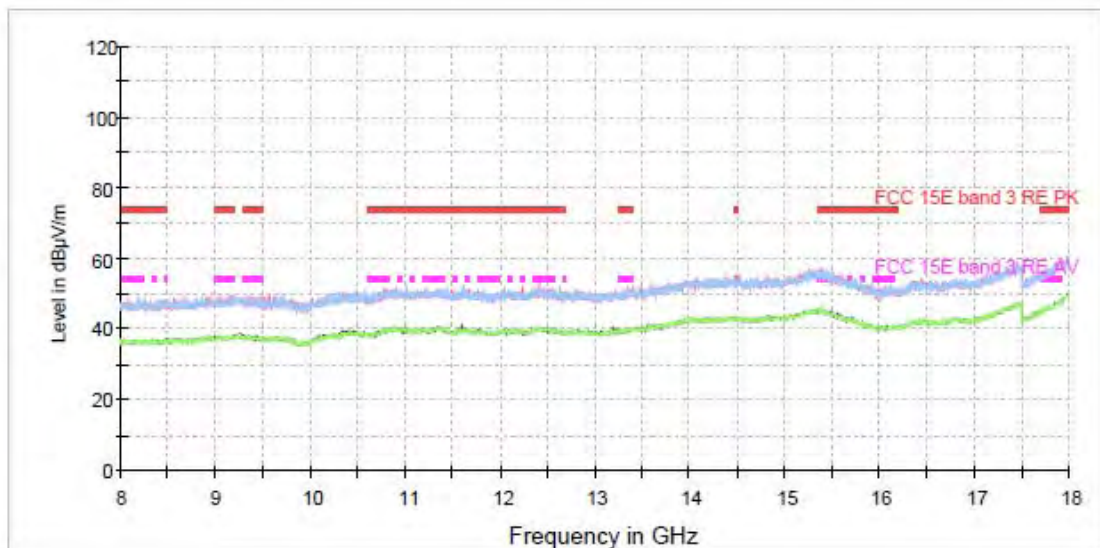

Radiates Emission from 8GHz to 18GHz



Frequency (MHz)	Peak (dBuV/m)	Average (dBuV/m)	Limit (dBuV/m)	Margin (dB)	Height (cm)	Polarization	Azimuth (deg)	Correct Factor (dB)
1352.625000	---	32.12	54.00	21.88	200.0	H	255.0	-7.0
1355.250000	43.94	---	74.00	30.06	100.0	H	138.0	-6.9
1594.125000	44.71	---	74.00	29.29	200.0	V	7.0	-5.6
1708.750000	---	33.04	54.00	20.96	200.0	H	126.0	-5.0
2728.125000	47.58	---	74.00	26.42	100.0	H	138.0	-0.4
2782.375000	---	36.24	54.00	17.76	200.0	H	121.0	0.0
3971.500000	49.48	---	74.00	24.52	100.0	H	87.0	3.9
3980.250000	---	38.55	54.00	15.45	200.0	V	356.0	4.0
5109.000000	51.53	---	74.00	22.47	200.0	H	213.0	6.6
5403.875000	---	40.24	54.00	13.76	100.0	V	299.0	7.0
7620.250000	53.66	---	74.00	20.34	200.0	V	243.0	10.2
7629.000000	---	42.18	54.00	11.82	200.0	H	126.0	10.2

Remark: 1. Correction Factor = Antenna factor+ Insertion loss (cable loss + amplifier gain)



802.11n (HT20) CH165

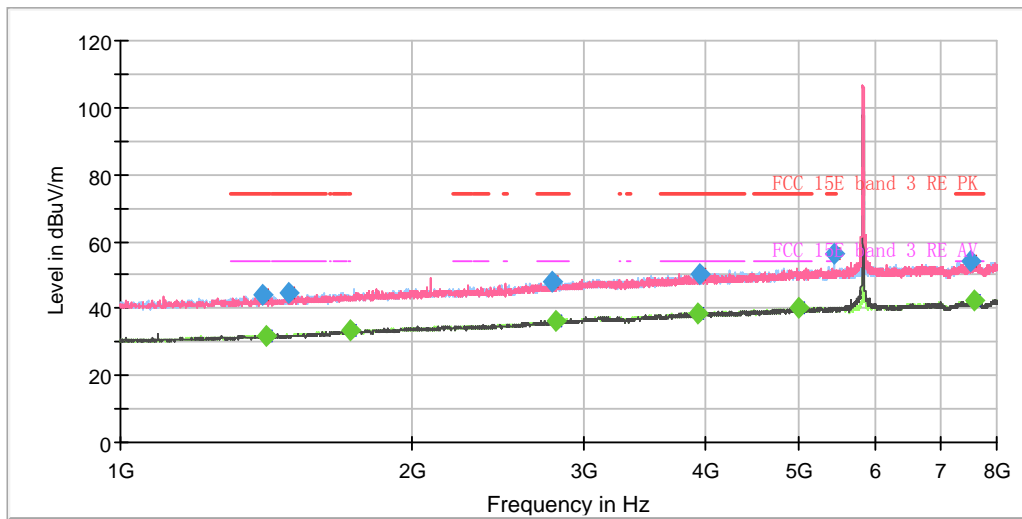

Note: The signal beyond the limit is carrier.
Radiates Emission from 1GHz to 8GHz

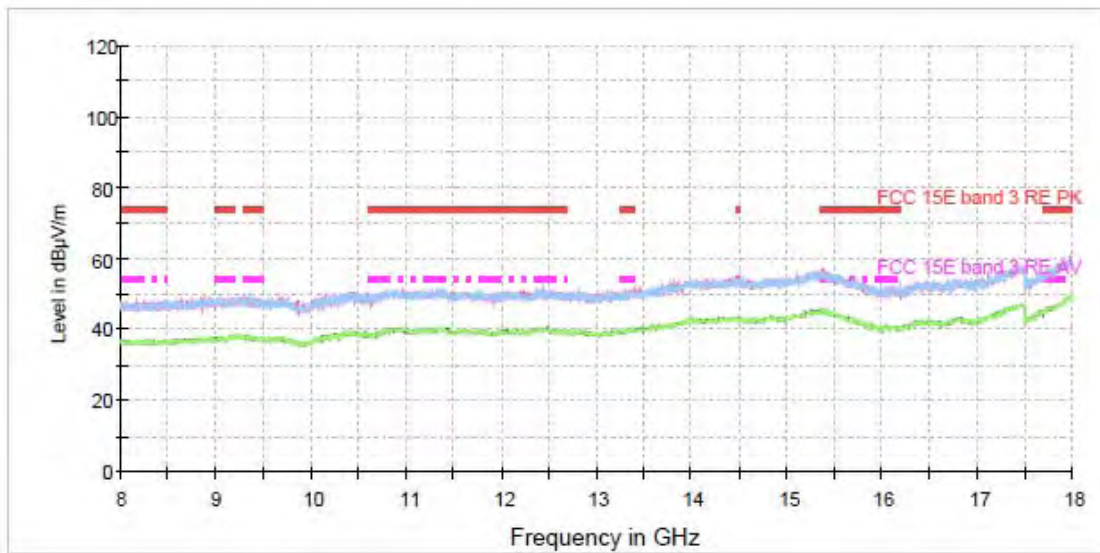

Radiates Emission from 8GHz to 18GHz



Frequency (MHz)	Peak (dBuV/m)	Average (dBuV/m)	Limit (dBuV/m)	Margin (dB)	Height (cm)	Polarization	Azimuth (deg)	Correct Factor (dB)
1398.125000	44.26	---	74.00	29.75	200.0	H	338.0	-6.7
1413.875000	---	32.05	54.00	21.95	100.0	H	48.0	-6.6
1490.000000	44.73	---	74.00	29.27	100.0	V	238.0	-6.2
1721.875000	---	33.44	54.00	20.56	200.0	H	272.0	-4.9
2786.750000	48.18	---	74.00	25.82	200.0	H	338.0	0.0
2806.000000	---	36.37	54.00	17.63	100.0	V	254.0	0.1
3942.625000	---	38.70	54.00	15.30	200.0	V	225.0	3.9
3946.125000	50.20	---	74.00	23.80	200.0	V	354.0	3.9
4990.875000	---	40.31	54.00	13.69	200.0	H	322.0	6.6
5430.125000	56.56	---	74.00	17.44	200.0	H	272.0	7.1
7503.875000	54.00	---	74.00	20.00	200.0	V	201.0	9.9
7569.500000	---	42.32	54.00	11.68	100.0	V	74.0	10.1

Remark: 1. Correction Factor = Antenna factor+ Insertion loss (cable loss + amplifier gain)

802.11n (HT40) CH38

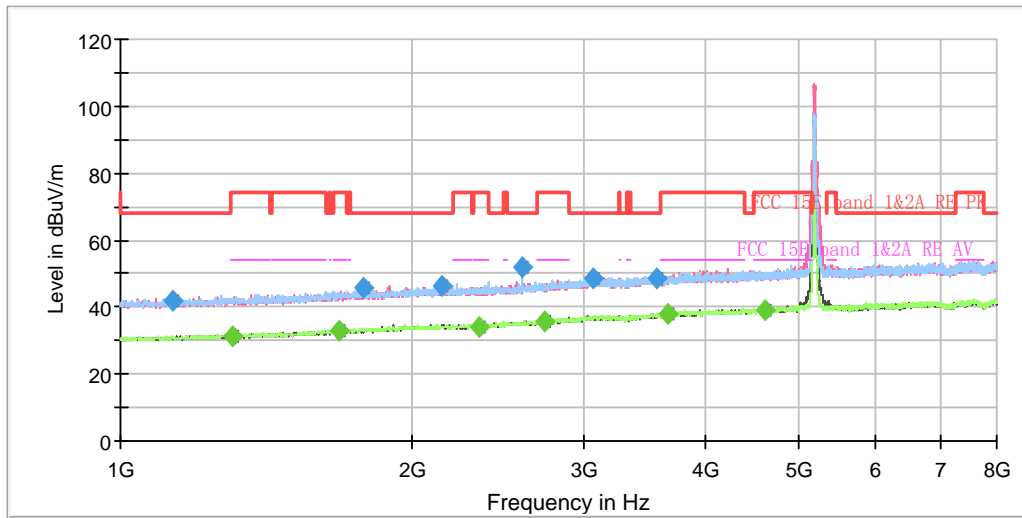

Note: The signal beyond the limit is carrier.
Radiates Emission from 1GHz to 8GHz

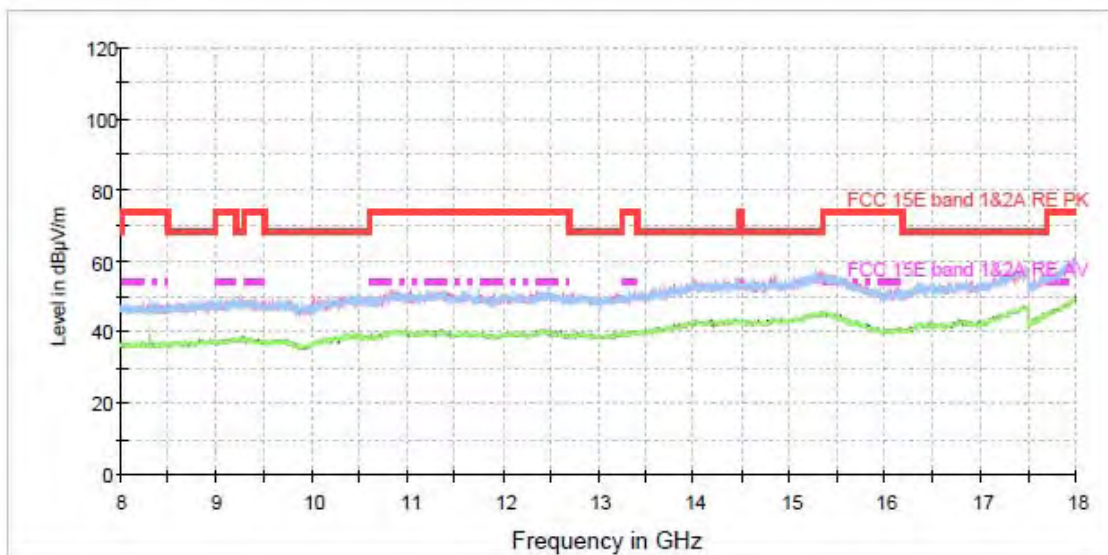

Radiates Emission from 8GHz to 18GHz



Frequency (MHz)	Peak (dBuV/m)	Average (dBuV/m)	Limit (dBuV/m)	Margin (dB)	Height (cm)	Polarization	Azimuth (deg)	Correct Factor (dB)
1130.375000	41.66	---	68.20	26.54	200.0	V	203.0	-8.2
1307.125000	---	31.46	54.00	22.54	100.0	V	307.0	-7.2
1681.625000	---	33.10	54.00	20.90	100.0	V	145.0	-5.1
1782.250000	45.52	---	68.20	22.68	100.0	V	347.0	-4.6
2147.125000	46.22	---	68.20	21.98	200.0	V	41.0	-2.7
2344.875000	---	34.29	54.00	19.71	200.0	V	86.0	-2.1
2597.750000	52.07	---	68.20	16.13	200.0	H	328.0	-1.0
2732.500000	---	35.78	54.00	18.22	200.0	H	0.0	-0.3
3076.375000	48.82	---	68.20	19.38	200.0	H	275.0	1.5
3562.875000	48.75	---	68.20	19.45	100.0	V	183.0	2.7
3673.125000	---	38.09	54.00	15.91	100.0	H	20.0	3.0
4613.750000	---	39.33	54.00	14.67	100.0	V	278.0	5.2

Remark: 1. Correction Factor = Antenna factor+ Insertion loss (cable loss + amplifier gain)

802.11n (HT40) CH46

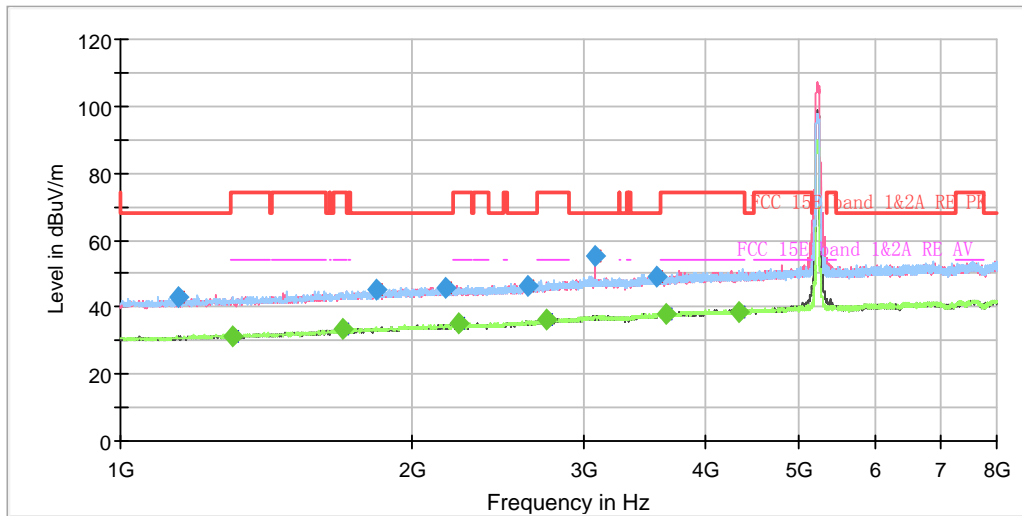

Note: The signal beyond the limit is carrier.
Radiates Emission from 1GHz to 8GHz

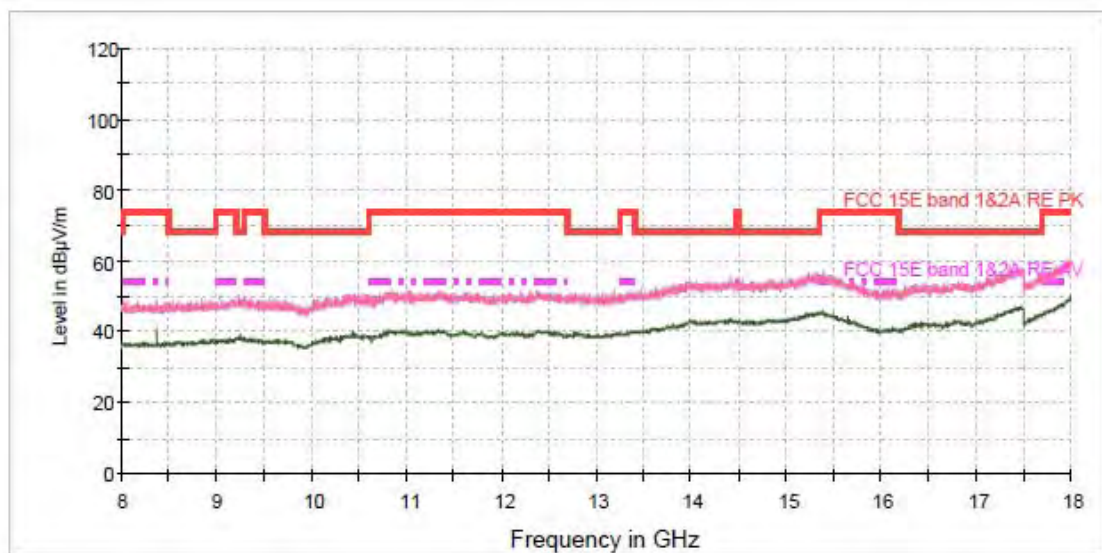

Radiates Emission from 8GHz to 18GHz



Frequency (MHz)	Peak (dBuV/m)	Average (dBuV/m)	Limit (dBuV/m)	Margin (dB)	Height (cm)	Polarization	Azimuth (deg)	Correct Factor (dB)
1146.125000	42.88	---	68.20	25.32	100.0	V	222.0	-8.1
1305.375000	---	31.42	54.00	22.58	200.0	V	21.0	-7.2
1693.875000	---	33.23	54.00	20.77	100.0	H	7.0	-5.1
1836.500000	45.45	---	68.20	22.75	200.0	H	341.0	-4.2
2164.625000	45.94	---	68.20	22.26	200.0	H	112.0	-2.7
2233.750000	---	34.92	54.00	19.08	200.0	V	27.0	-2.6
2631.000000	46.52	---	68.20	21.68	200.0	H	201.0	-0.8
2747.375000	---	36.13	54.00	17.87	100.0	V	244.0	-0.2
3085.125000	55.18	---	68.20	13.02	200.0	V	10.0	1.5
3567.250000	48.94	---	68.20	19.26	100.0	H	114.0	2.7
3645.125000	---	38.09	54.00	15.91	100.0	V	28.0	2.8
4345.125000	---	38.79	54.00	15.21	100.0	H	69.0	4.7

Remark: 1. Correction Factor = Antenna factor+ Insertion loss (cable loss + amplifier gain)

802.11n (HT40) CH54

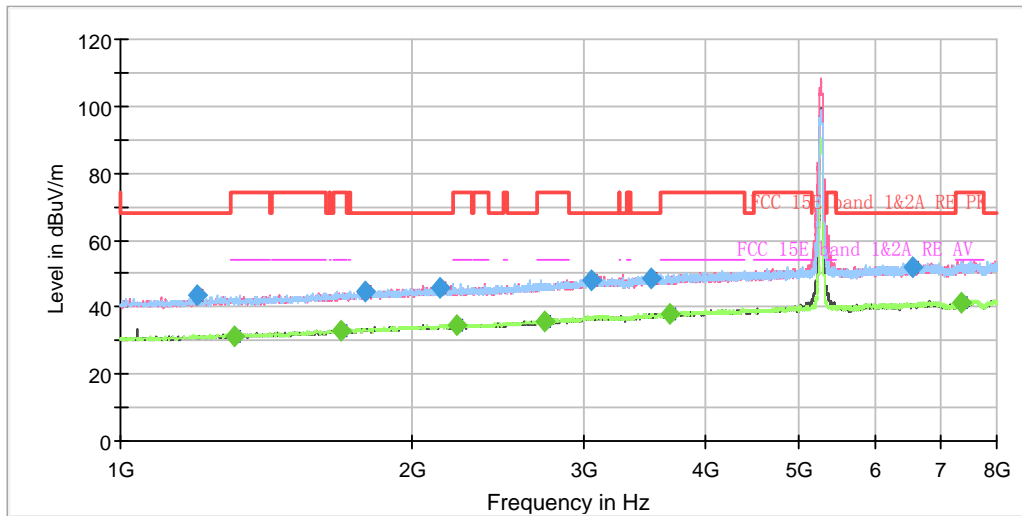

Note: The signal beyond the limit is carrier.
Radiates Emission from 1GHz to 8GHz

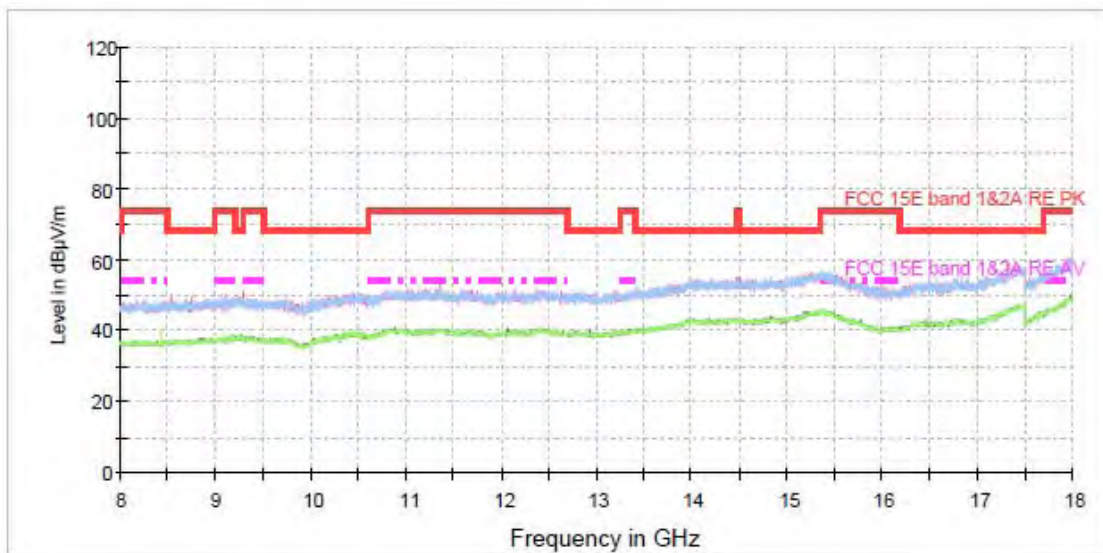

Radiates Emission from 8GHz to 18GHz



Frequency (MHz)	Peak (dBuV/m)	Average (dBuV/m)	Limit (dBuV/m)	Margin (dB)	Height (cm)	Polarization	Azimuth (deg)	Correct Factor (dB)
1197.750000	43.26	---	68.20	24.94	100.0	V	328.0	-7.8
1313.250000	---	31.44	54.00	22.56	200.0	H	311.0	-7.2
1686.000000	---	33.18	54.00	20.82	200.0	H	182.0	-5.1
1791.000000	44.44	---	68.20	23.76	200.0	V	27.0	-4.5
2132.250000	45.93	---	68.20	22.27	100.0	V	353.0	-2.8
2222.375000	---	34.33	54.00	19.67	200.0	V	27.0	-2.6
2736.875000	---	35.82	54.00	18.18	200.0	H	117.0	-0.3
3058.000000	48.19	---	68.20	20.01	100.0	H	22.0	1.4
3525.250000	48.75	---	68.20	19.45	100.0	V	306.0	2.4
3676.625000	---	38.05	54.00	15.95	200.0	V	27.0	3.0
6548.375000	52.16	---	68.20	16.04	100.0	V	92.0	8.6
7363.875000	---	41.47	54.00	12.53	200.0	V	288.0	9.8

Remark: 1. Correction Factor = Antenna factor+ Insertion loss (cable loss + amplifier gain)

802.11n (HT40) CH62

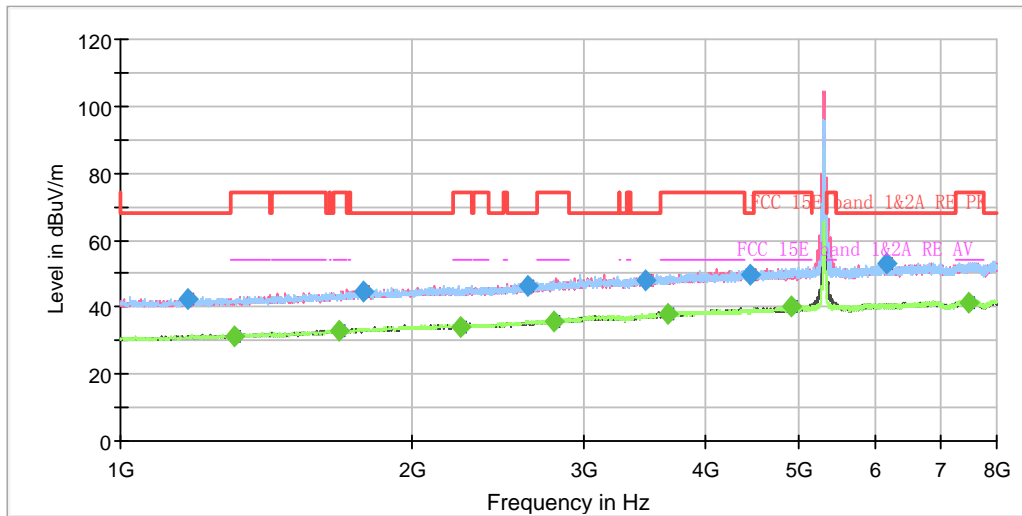

Note: The signal beyond the limit is carrier.
Radiates Emission from 1GHz to 8GHz

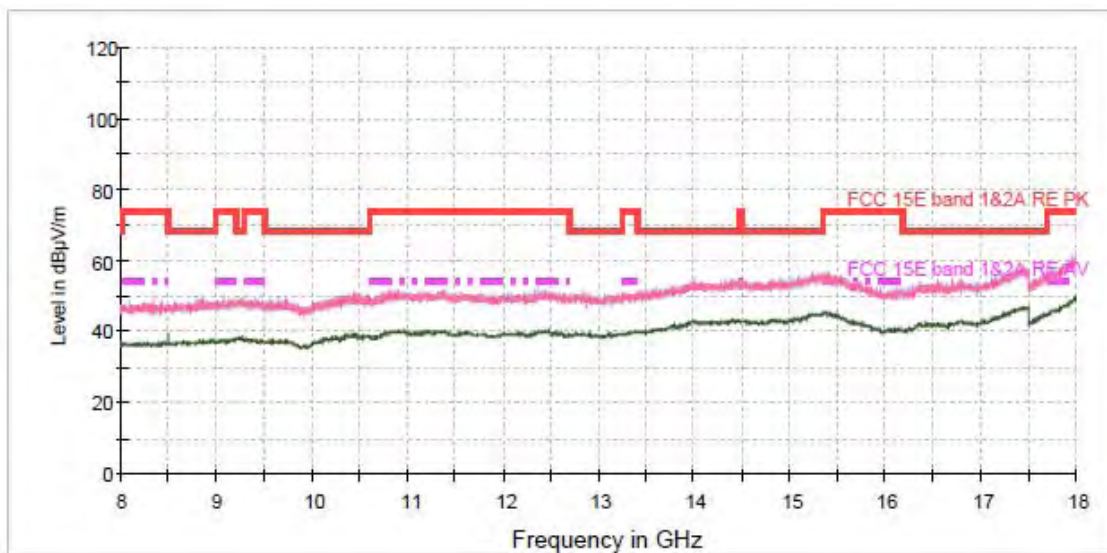

Radiates Emission from 8GHz to 18GHz



Frequency (MHz)	Peak (dBuV/m)	Average (dBuV/m)	Limit (dBuV/m)	Margin (dB)	Height (cm)	Polarization	Azimuth (deg)	Correct Factor (dB)
1175.000000	42.57	---	68.20	25.63	200.0	H	347.0	-7.9
1308.000000	---	31.36	54.00	22.64	200.0	H	178.0	-7.2
1677.250000	---	33.07	54.00	20.93	100.0	V	359.0	-5.1
1782.250000	44.44	---	68.20	23.76	200.0	H	35.0	-4.6
2239.000000	---	34.17	54.00	19.83	100.0	V	262.0	-2.5
2631.000000	46.40	---	68.20	21.80	100.0	V	50.0	-0.8
2803.375000	---	35.78	54.00	18.22	200.0	V	60.0	0.1
3483.250000	47.74	---	68.20	20.46	100.0	V	146.0	2.2
3664.375000	---	38.05	54.00	15.95	200.0	V	111.0	2.9
4452.750000	49.90	---	68.20	18.30	100.0	V	353.0	4.9
4912.125000	---	39.92	54.00	14.08	200.0	H	214.0	6.4
6162.500000	53.03	---	68.20	15.17	100.0	H	35.0	8.1
7483.750000	---	41.52	54.00	12.48	200.0	V	304.0	9.9

Remark: 1. Correction Factor = Antenna factor+ Insertion loss (cable loss + amplifier gain)

802.11n (HT40) CH102

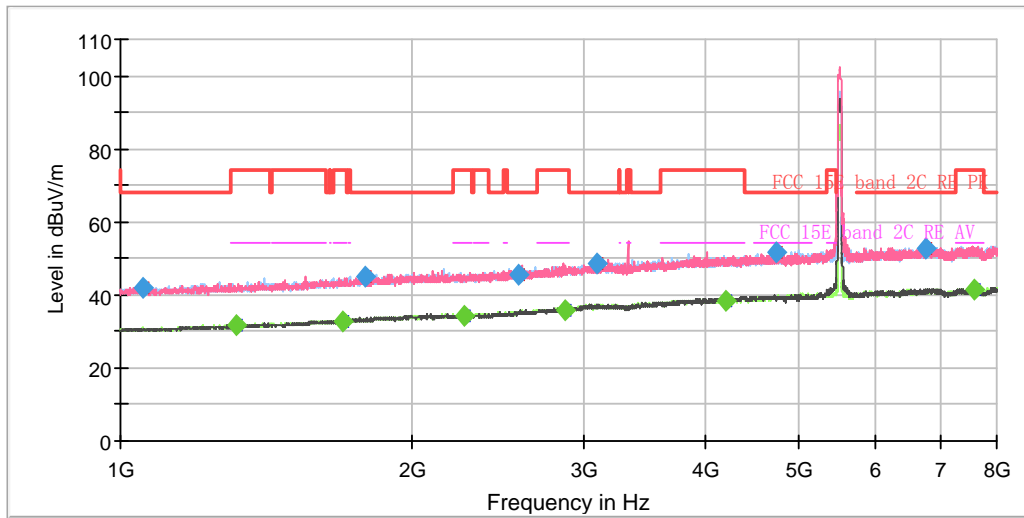

Note: The signal beyond the limit is carrier.
Radiates Emission from 1GHz to 8GHz

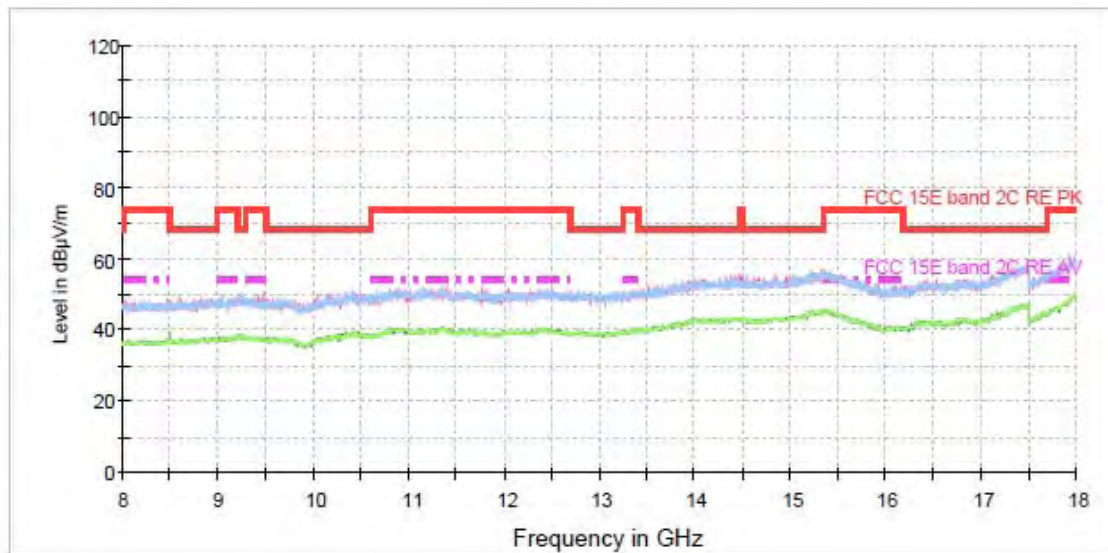

Radiates Emission from 8GHz to 18GHz



Frequency (MHz)	Peak (dBuV/m)	Average (dBuV/m)	Limit (dBuV/m)	Margin (dB)	Height (cm)	Polarization	Azimuth (deg)	Correct Factor (dB)
1055.125000	41.75	---	68.20	26.45	200.0	V	0.0	-8.5
1315.000000	---	31.59	54.00	22.41	200.0	H	281.0	-7.2
1698.250000	---	32.89	54.00	21.11	100.0	V	220.0	-5.0
1785.750000	44.88	---	68.20	23.32	100.0	V	1.0	-4.6
2265.250000	---	34.47	54.00	19.53	100.0	V	12.0	-2.3
2567.125000	45.42	---	68.20	22.78	200.0	H	297.0	-1.1
2869.000000	---	36.01	54.00	17.99	200.0	H	0.0	0.5
3103.500000	48.61	---	68.20	19.59	100.0	V	232.0	1.5
4207.750000	---	38.61	54.00	15.39	100.0	H	241.0	4.4
4739.750000	51.92	---	68.20	16.28	200.0	H	114.0	5.7
6761.000000	52.58	---	68.20	15.62	100.0	V	154.0	8.9
7587.875000	---	41.64	54.00	12.36	100.0	H	308.0	10.1

Remark: 1. Correction Factor = Antenna factor+ Insertion loss (cable loss + amplifier gain)

802.11n (HT40) CH118

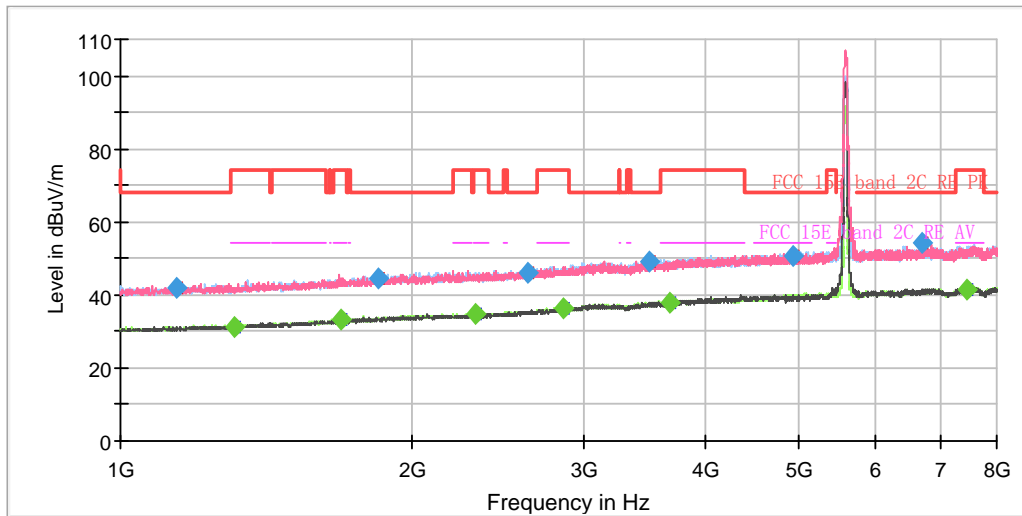

Note: The signal beyond the limit is carrier.
Radiates Emission from 1GHz to 8GHz

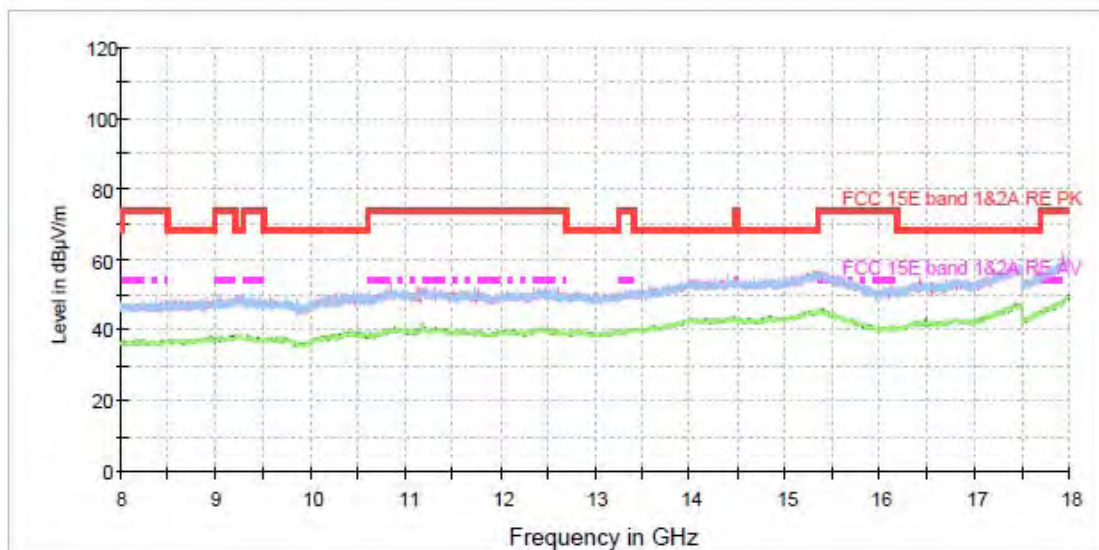

Radiates Emission from 8GHz to 18GHz



Frequency (MHz)	Peak (dBuV/m)	Average (dBuV/m)	Limit (dBuV/m)	Margin (dB)	Height (cm)	Polarization	Azimuth (deg)	Correct Factor (dB)
1140.875000	42.14	---	68.20	26.06	100.0	V	245.0	-8.2
1310.625000	---	31.27	54.00	22.73	100.0	H	265.0	-7.2
1684.250000	---	33.32	54.00	20.68	200.0	H	174.0	-5.1
1846.125000	44.56	---	68.20	23.64	100.0	H	320.0	-4.3
2318.625000	---	34.72	54.00	19.28	100.0	V	82.0	-2.2
2627.500000	46.16	---	68.20	22.04	200.0	H	103.0	-0.8
2862.000000	---	36.50	54.00	17.50	200.0	H	344.0	0.5
3502.500000	48.91	---	68.20	19.29	100.0	H	152.0	2.3
3687.125000	---	37.68	54.00	16.32	200.0	H	21.0	3.1
4929.625000	50.44	---	68.20	17.76	200.0	H	191.0	6.4
6705.875000	54.21	---	68.20	13.99	100.0	H	347.0	8.8
7459.250000	---	41.59	54.00	12.41	100.0	H	315.0	9.8

Remark: 1. Correction Factor = Antenna factor+ Insertion loss (cable loss + amplifier gain)

802.11n (HT40) CH134

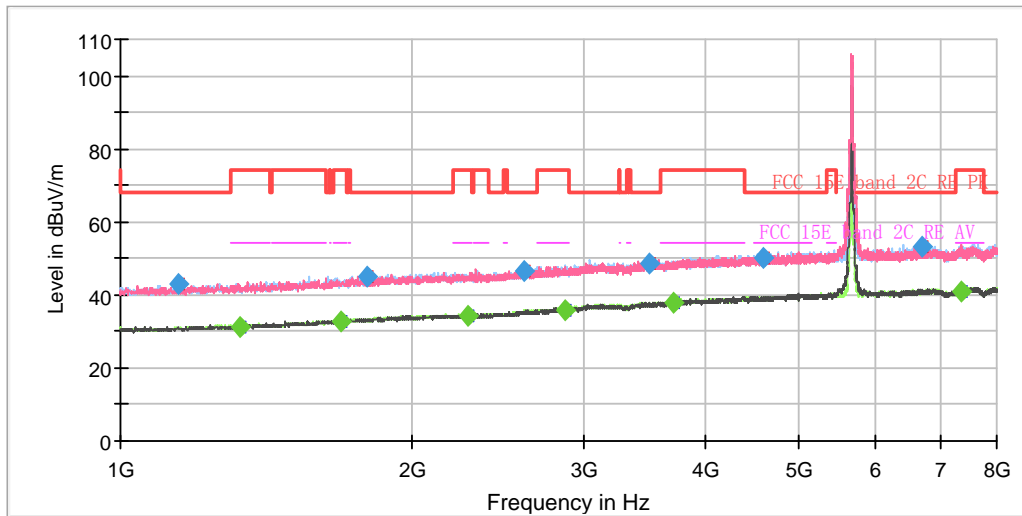

Note: The signal beyond the limit is carrier.
Radiates Emission from 1GHz to 8GHz

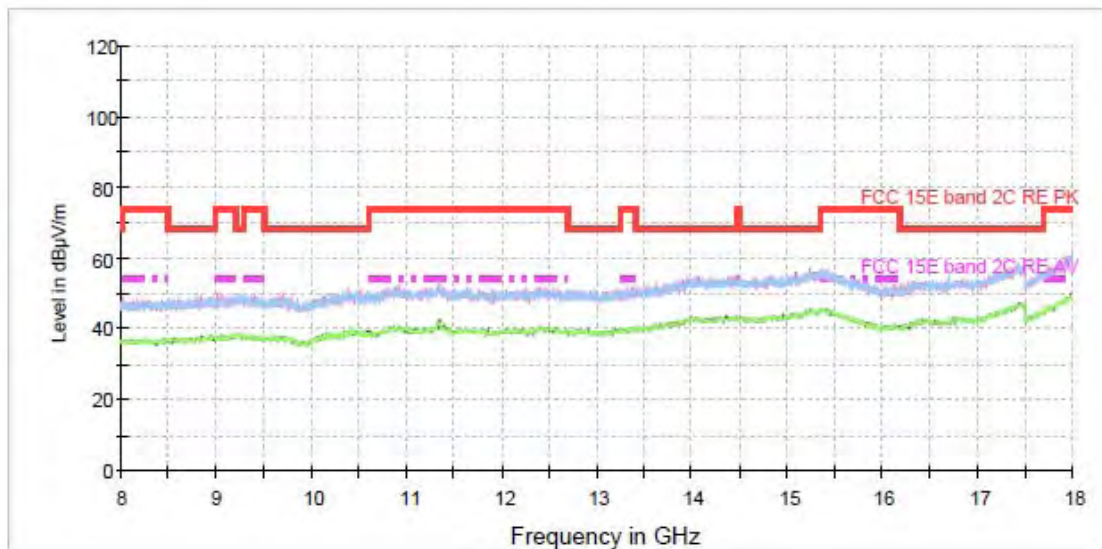

Radiates Emission from 8GHz to 18GHz



Frequency (MHz)	Peak (dBuV/m)	Average (dBuV/m)	Limit (dBuV/m)	Margin (dB)	Height (cm)	Polarization	Azimuth (deg)	Correct Factor (dB)
1147.875000	43.03	---	68.20	25.17	200.0	V	353.0	-8.1
1325.500000	---	31.29	54.00	22.71	200.0	H	287.0	-7.1
1684.250000	---	32.88	54.00	21.12	100.0	H	348.0	-5.1
1798.000000	44.80	---	68.20	23.40	200.0	V	337.0	-4.5
2280.125000	---	34.40	54.00	19.60	100.0	V	356.0	-2.3
2607.375000	46.32	---	68.20	21.88	100.0	H	238.0	-0.9
2869.000000	---	35.91	54.00	18.09	100.0	H	78.0	0.5
3507.750000	48.59	---	68.20	19.61	200.0	H	0.0	2.3
3710.750000	---	37.98	54.00	16.02	100.0	H	320.0	3.1
4599.750000	50.16	---	68.20	18.04	200.0	H	141.0	5.2
6687.500000	53.20	---	68.20	15.00	100.0	H	151.0	8.8
7355.125000	---	41.13	54.00	12.87	100.0	H	293.0	9.8

Remark: 1. Correction Factor = Antenna factor+ Insertion loss (cable loss + amplifier gain)

802.11n (HT40) CH151

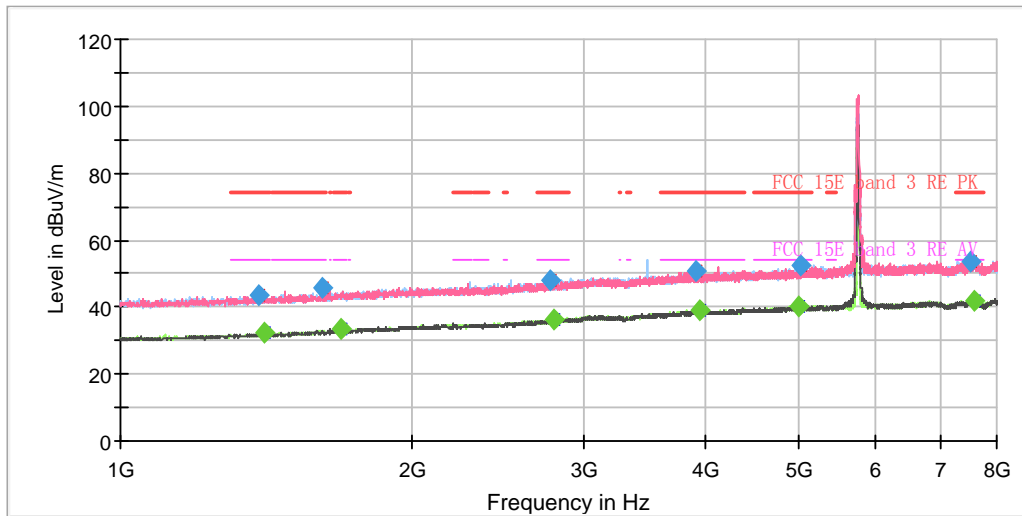

Note: The signal beyond the limit is carrier.
Radiates Emission from 1GHz to 8GHz

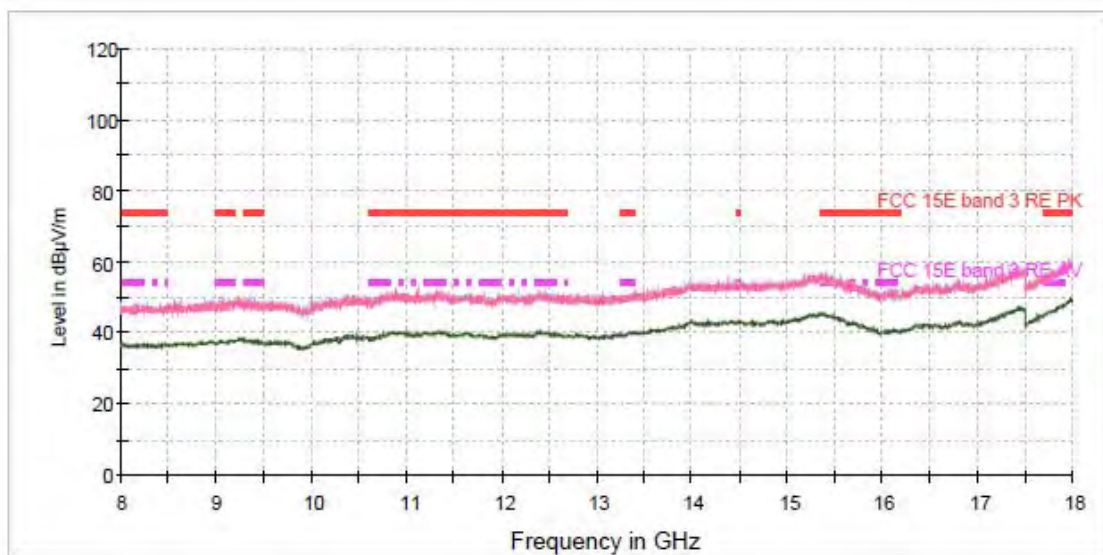

Radiates Emission from 8GHz to 18GHz



Frequency (MHz)	Peak (dBuV/m)	Average (dBuV/m)	Limit (dBuV/m)	Margin (dB)	Height (cm)	Polarization	Azimuth (deg)	Correct Factor (dB)
1389.375000	43.64	---	74.00	30.36	200.0	H	31.0	-6.8
1407.750000	---	32.18	54.00	21.82	200.0	H	192.0	-6.7
1614.250000	45.63	---	74.00	28.37	100.0	V	0.0	-5.5
1685.125000	---	33.23	54.00	20.77	100.0	V	10.0	-5.1
2768.375000	47.74	---	74.00	26.26	100.0	H	147.0	-0.1
2795.500000	---	36.28	54.00	17.72	200.0	H	93.0	0.1
3912.000000	50.90	---	74.00	23.10	200.0	V	293.0	3.8
3947.875000	---	38.86	54.00	15.14	100.0	H	0.0	3.9
4989.125000	---	40.28	54.00	13.72	200.0	H	55.0	6.6
5022.375000	52.49	---	74.00	21.51	100.0	V	0.0	6.6
7516.125000	53.70	---	74.00	20.30	200.0	V	349.0	9.9
7592.250000	---	42.09	54.00	11.91	100.0	H	0.0	10.1

Remark: 1. Correction Factor = Antenna factor+ Insertion loss (cable loss + amplifier gain)

802.11n (HT40) CH159

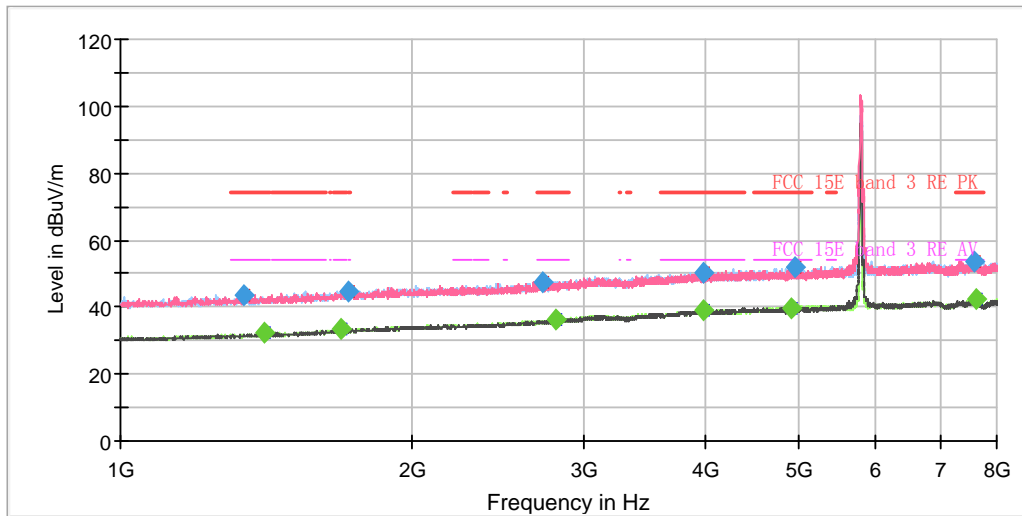

Note: The signal beyond the limit is carrier.
Radiates Emission from 1GHz to 8GHz

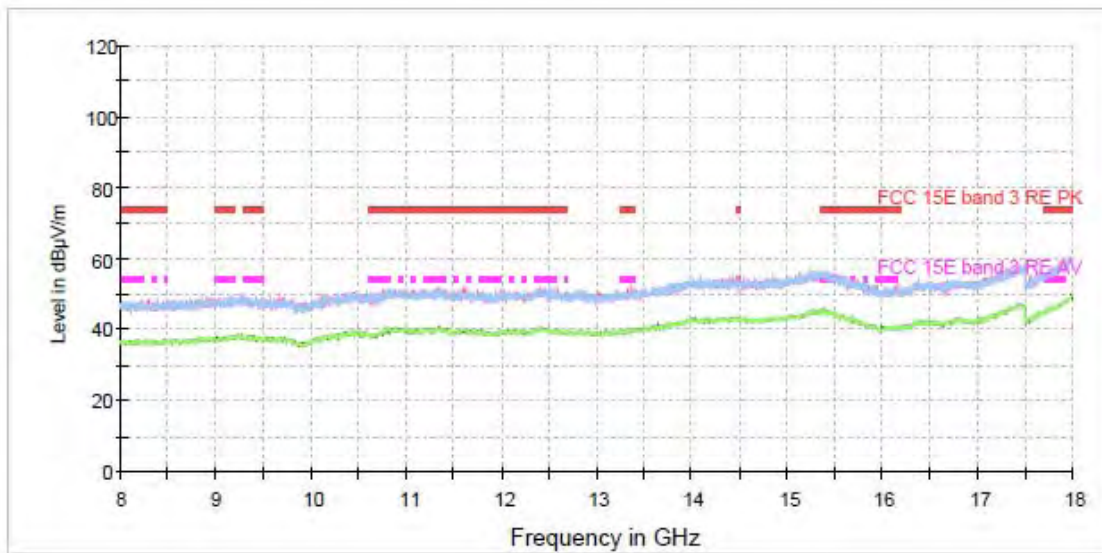

Radiates Emission from 8GHz to 18GHz



Frequency (MHz)	Peak (dBuV/m)	Average (dBuV/m)	Limit (dBuV/m)	Margin (dB)	Height (cm)	Polarization	Azimuth (deg)	Correct Factor (dB)
1341.250000	43.76	---	74.00	30.24	100.0	V	118.0	-7.0
1404.250000	---	32.10	54.00	21.90	100.0	H	320.0	-6.7
1686.875000	---	33.56	54.00	20.44	200.0	H	254.0	-5.1
1719.250000	44.65	---	74.00	29.35	200.0	V	72.0	-4.9
2729.000000	47.64	---	74.00	26.36	100.0	H	104.0	-0.3
2805.125000	---	36.35	54.00	17.65	200.0	H	160.0	0.1
3980.250000	---	38.95	54.00	15.05	100.0	H	227.0	4.0
3996.875000	50.02	---	74.00	23.98	200.0	H	100.0	4.0
4913.875000	---	39.80	54.00	14.20	100.0	H	303.0	6.4
4948.000000	51.97	---	74.00	22.03	200.0	V	304.0	6.5
7569.500000	53.70	---	74.00	20.30	200.0	V	276.0	10.1
7606.250000	---	42.30	54.00	11.70	200.0	H	249.0	10.1

Remark: 1. Correction Factor = Antenna factor+ Insertion loss (cable loss + amplifier gain)

802.11ac (HT80) CH42

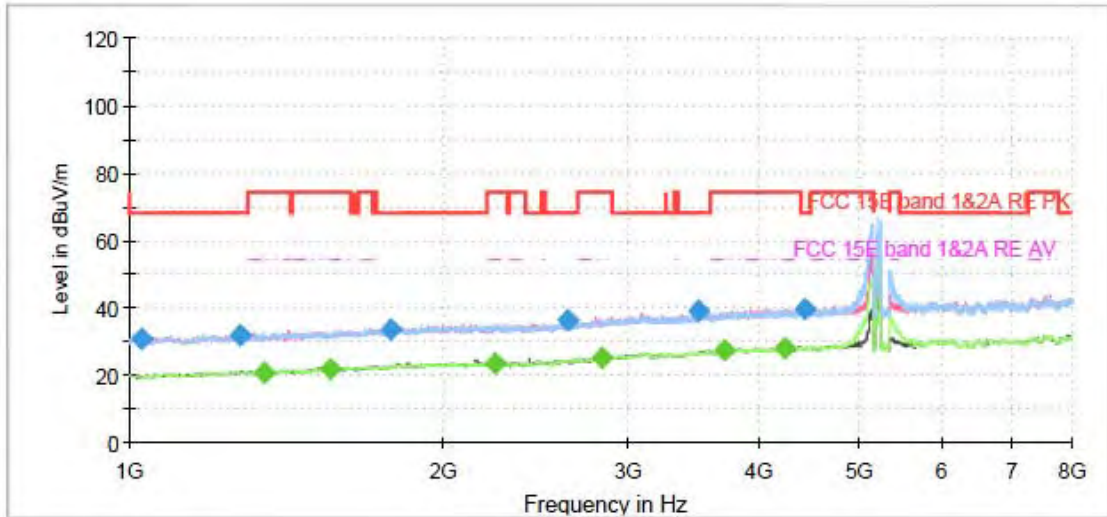

Note: The signal beyond the limit is carrier.
Radiates Emission from 1GHz to 8GHz

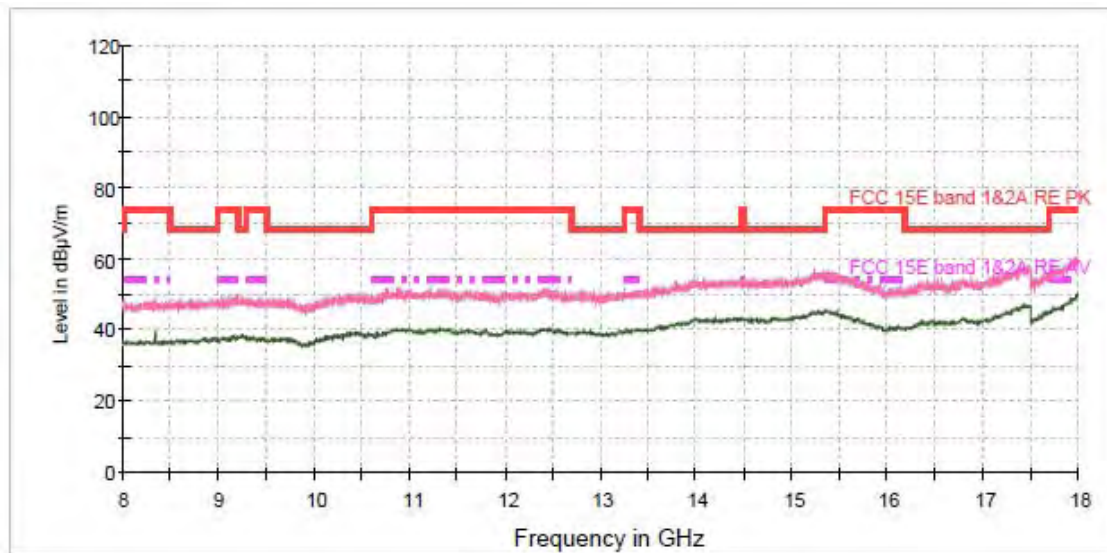

Radiates Emission from 8GHz to 18GHz



Frequency (MHz)	Peak (dBuV/m)	Average (dBuV/m)	Limit (dBuV/m)	Margin (dB)	Height (cm)	Polarization	Azimuth (deg)	Correct Factor (dB)
1028.875000	30.83	---	68.20	37.37	200.0	H	317.0	-18.8
1274.750000	31.79	---	68.20	36.41	200.0	H	57.0	-17.4
1343.875000	---	20.88	54.00	33.12	200.0	V	59.0	-17.0
1557.375000	---	21.65	54.00	32.35	200.0	V	70.0	-15.8
1779.625000	33.50	---	68.20	34.70	200.0	H	256.0	-14.6
2241.625000	---	23.51	54.00	30.49	200.0	V	180.0	-12.5
2624.000000	36.02	---	68.20	32.18	100.0	V	189.0	-10.9
2834.000000	---	25.15	54.00	28.85	100.0	H	71.0	-9.7
3504.250000	38.82	---	68.20	29.38	200.0	V	0.0	-7.7
3716.000000	---	27.17	54.00	26.83	200.0	V	116.0	-6.9
4239.250000	---	28.15	54.00	25.85	200.0	V	70.0	-5.5
4443.125000	39.60	---	68.20	28.60	100.0	V	149.0	-5.1

Remark: 1. Correction Factor = Antenna factor+ Insertion loss (cable loss + amplifier gain)

802.11ac (HT80) CH58

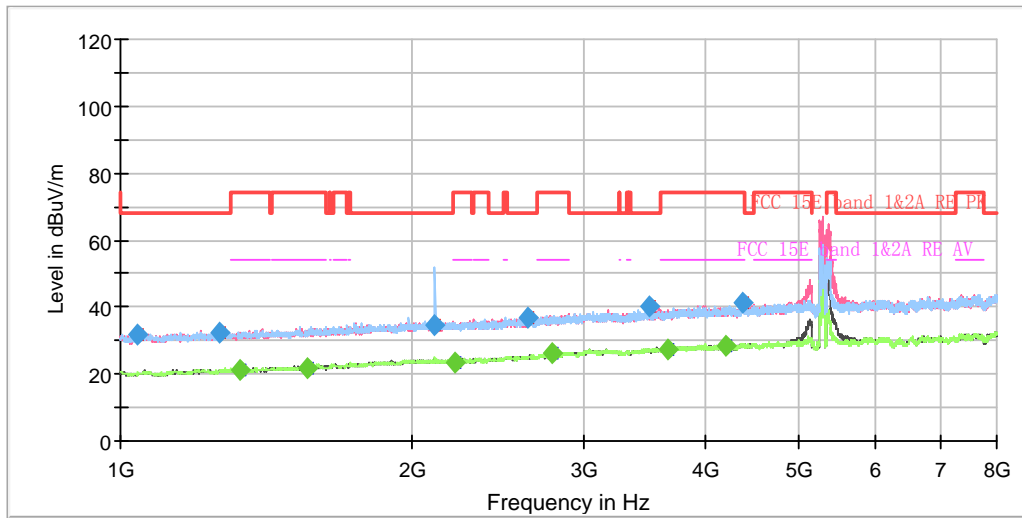

Note: The signal beyond the limit is carrier.
Radiates Emission from 1GHz to 8GHz

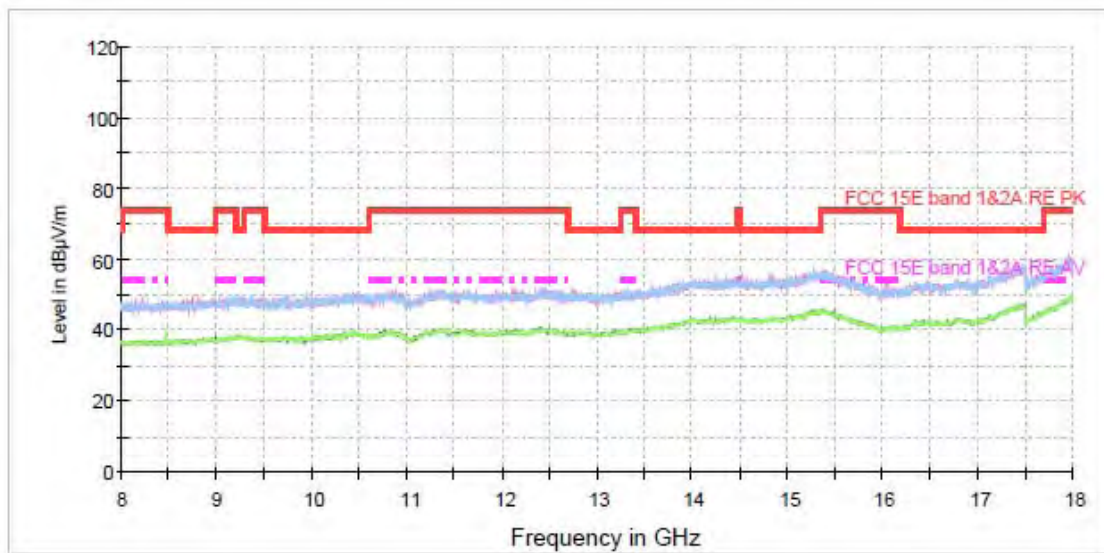

Radiates Emission from 8GHz to 18GHz



Frequency (MHz)	Peak (dBuV/m)	Average (dBuV/m)	Limit (dBuV/m)	Margin (dB)	Height (cm)	Polarization	Azimuth (deg)	Correct Factor (dB)
1039.375000	31.57	---	68.20	36.63	100.0	V	327.0	-18.6
1262.500000	32.49	---	68.20	35.71	100.0	V	210.0	-17.5
1329.000000	---	21.47	54.00	32.53	200.0	H	140.0	-17.1
1557.375000	---	21.98	54.00	32.02	200.0	H	86.0	-15.8
2109.500000	34.84	---	68.20	33.36	200.0	V	105.0	-12.9
2211.000000	---	23.72	54.00	30.28	100.0	V	284.0	-12.6
2633.625000	36.60	---	68.20	31.60	100.0	V	205.0	-10.8
2778.875000	---	26.10	54.00	27.90	200.0	H	11.0	-10.1
3505.125000	39.97	---	68.20	28.23	100.0	V	59.0	-7.7
3670.500000	---	27.41	54.00	26.59	100.0	V	49.0	-7.0
4199.000000	---	28.58	54.00	25.42	200.0	V	184.0	-5.6
4381.000000	41.17	---	74.00	32.83	100.0	V	317.0	-5.2

Remark: 1. Correction Factor = Antenna factor+ Insertion loss (cable loss + amplifier gain)

802.11ac (HT80) CH106

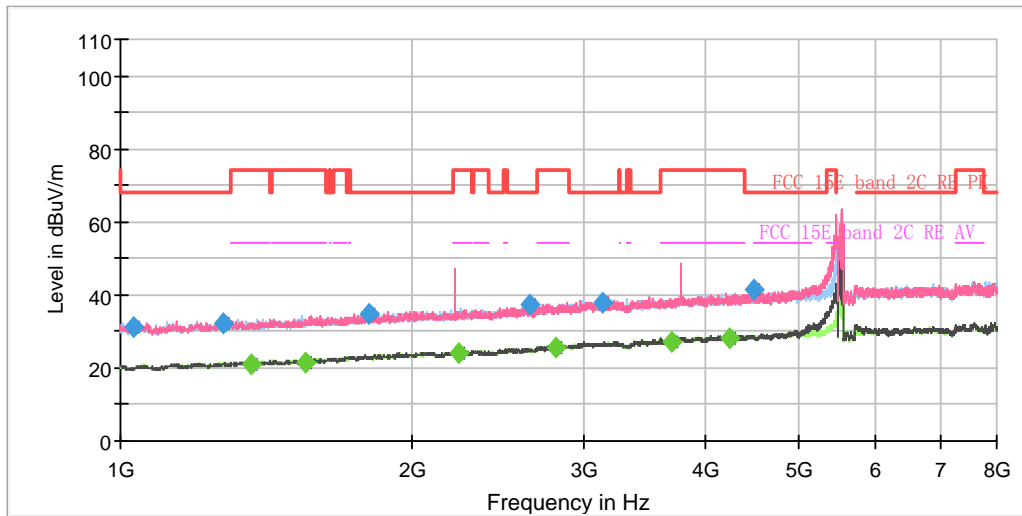

Note: The signal beyond the limit is carrier.
Radiates Emission from 1GHz to 8GHz

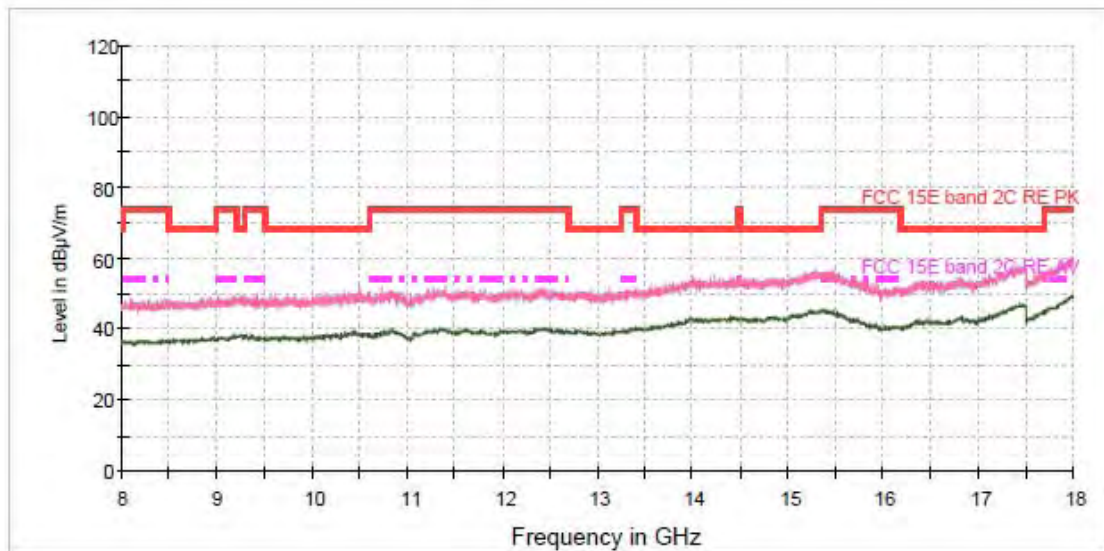

Radiates Emission from 8GHz to 18GHz



Frequency (MHz)	Peak (dBuV/m)	Average (dBuV/m)	Limit (dBuV/m)	Margin (dB)	Height (cm)	Polarization	Azimuth (deg)	Correct Factor (dB)
1031.500000	31.40	---	68.20	36.80	200.0	V	120.0	-18.7
1274.750000	32.43	---	68.20	35.77	200.0	H	151.0	-17.4
1361.375000	---	21.18	54.00	32.82	200.0	H	56.0	-16.9
1548.625000	---	21.74	54.00	32.26	200.0	H	146.0	-15.9
1800.625000	34.62	---	68.20	33.58	200.0	H	267.0	-14.5
2235.500000	---	24.09	54.00	29.91	100.0	H	76.0	-12.6
2637.125000	37.10	---	68.20	31.10	200.0	V	218.0	-10.8
2807.750000	---	25.73	54.00	28.27	200.0	H	169.0	-9.9
3140.250000	37.74	---	68.20	30.46	200.0	H	228.0	-8.4
3704.625000	---	27.25	54.00	26.75	200.0	H	349.0	-6.9
4237.500000	---	28.34	54.00	25.66	200.0	H	0.0	-5.5
4491.250000	41.32	---	68.20	26.88	200.0	V	20.0	-5.0

Remark: 1. Correction Factor = Antenna factor+ Insertion loss (cable loss + amplifier gain)

802.11ac (HT80) CH122

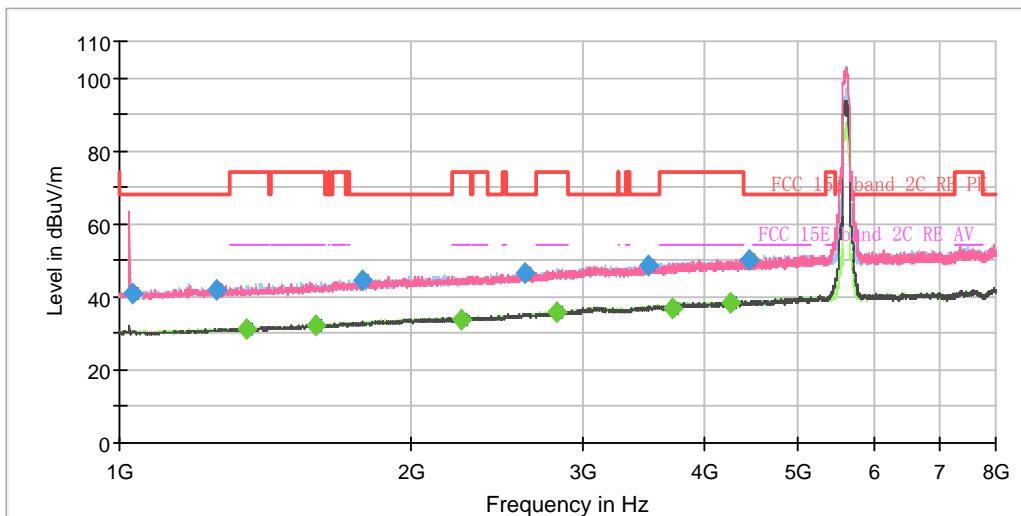

Note: The signal beyond the limit is carrier.
Radiates Emission from 1GHz to 8GHz

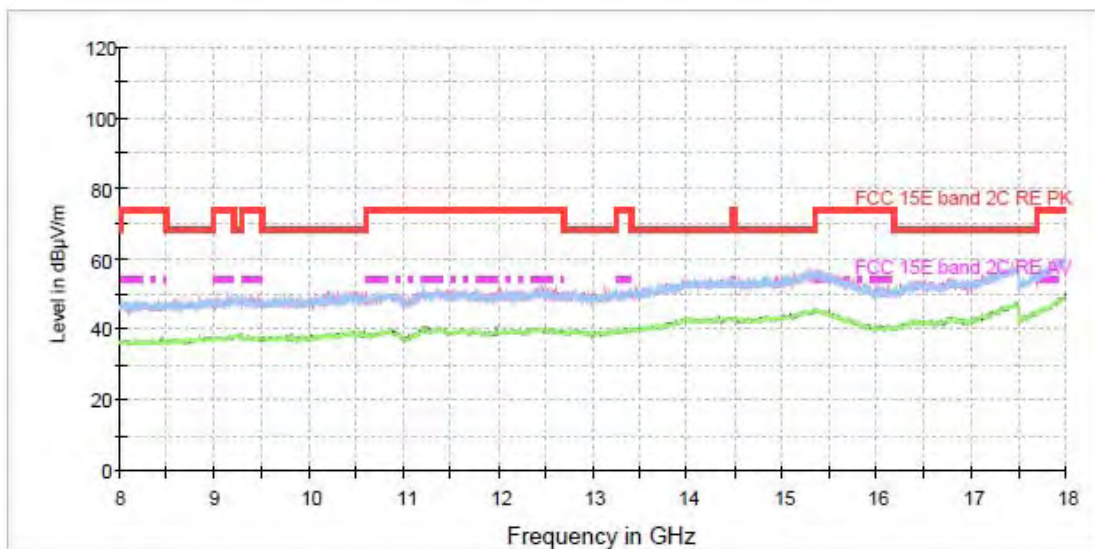

Radiates Emission from 8GHz to 18GHz



Frequency (MHz)	Peak (dBuV/m)	Average (dBuV/m)	Limit (dBuV/m)	Margin (dB)	Height (cm)	Polarization	Azimuth (deg)	Correct Factor (dB)
1029.750000	41.07	---	68.20	27.13	200.0	H	236.0	-8.7
1259.875000	42.01	---	68.20	26.19	200.0	V	284.0	-7.5
1351.750000	---	31.08	54.00	22.92	200.0	H	32.0	-7.0
1592.375000	---	32.23	54.00	21.77	200.0	H	101.0	-5.6
1777.000000	44.32	---	68.20	23.88	200.0	V	22.0	-4.6
2255.625000	---	33.88	54.00	20.12	200.0	H	170.0	-2.4
2619.625000	46.31	---	68.20	21.89	100.0	V	52.0	-0.9
2818.250000	---	35.59	54.00	18.41	100.0	H	278.0	0.2
3502.500000	48.46	---	68.20	19.74	100.0	H	350.0	2.3
3708.125000	---	37.07	54.00	16.93	200.0	H	95.0	3.1
4267.250000	---	38.23	54.00	15.77	100.0	H	333.0	4.5
4458.875000	50.19	---	68.20	18.01	200.0	H	49.0	4.9

Remark: 1. Correction Factor = Antenna factor+ Insertion loss (cable loss + amplifier gain)

802.11ac (HT80) CH138

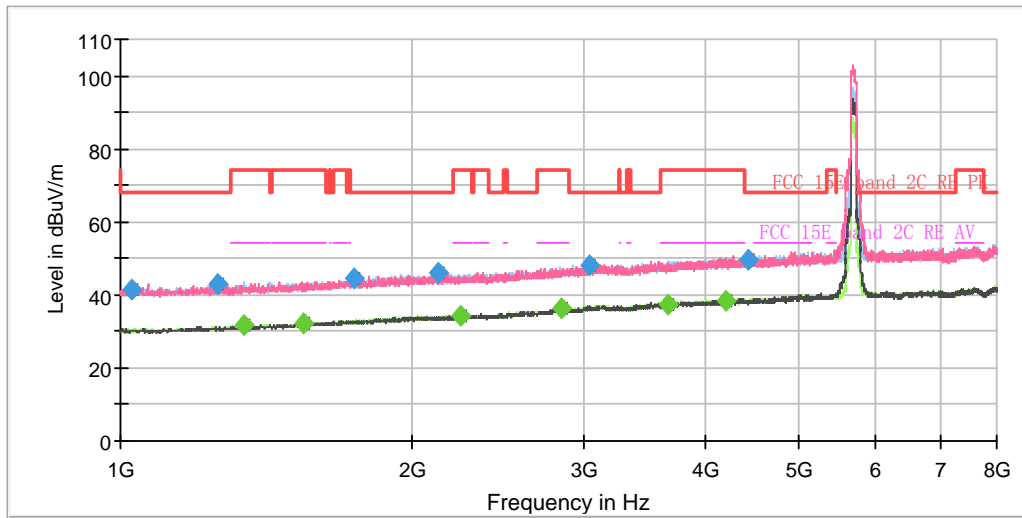

Note: The signal beyond the limit is carrier.
Radiates Emission from 1GHz to 8GHz

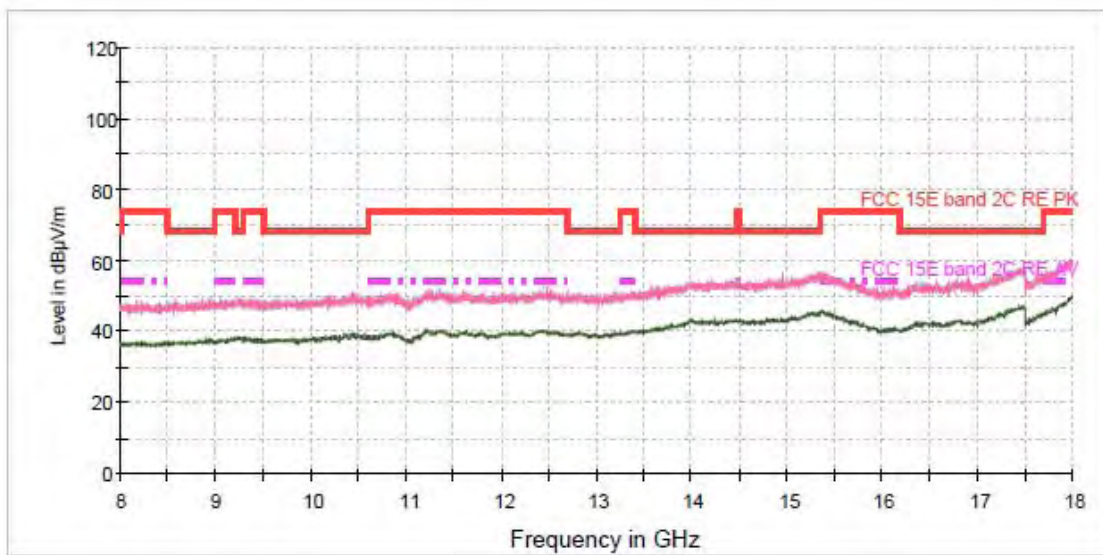

Radiates Emission from 8GHz to 18GHz



Frequency (MHz)	Peak (dBuV/m)	Average (dBuV/m)	Limit (dBuV/m)	Margin (dB)	Height (cm)	Polarization	Azimuth (deg)	Correct Factor (dB)
1027.125000	41.69	---	68.20	26.51	200.0	V	315.0	-8.8
1261.625000	42.81	---	68.20	25.39	200.0	H	0.0	-7.5
1341.250000	---	31.47	54.00	22.53	200.0	H	324.0	-7.0
1546.875000	---	32.04	54.00	21.96	100.0	H	168.0	-6.0
1743.750000	44.37	---	68.20	23.83	200.0	H	65.0	-4.8
2125.250000	46.11	---	68.20	22.09	100.0	H	191.0	-2.9
2239.875000	---	34.45	54.00	19.56	100.0	V	30.0	-2.5
2841.000000	---	36.09	54.00	17.91	100.0	H	258.0	0.3
3041.375000	48.31	---	68.20	19.89	100.0	H	146.0	1.4
3672.250000	---	37.20	54.00	16.80	100.0	H	325.0	3.0
4200.750000	---	38.23	54.00	15.77	100.0	H	51.0	4.4
4436.125000	49.81	---	68.20	18.39	100.0	H	335.0	4.9

Remark: 1. Correction Factor = Antenna factor+ Insertion loss (cable loss + amplifier gain)

802.11ac (HT80) CH155

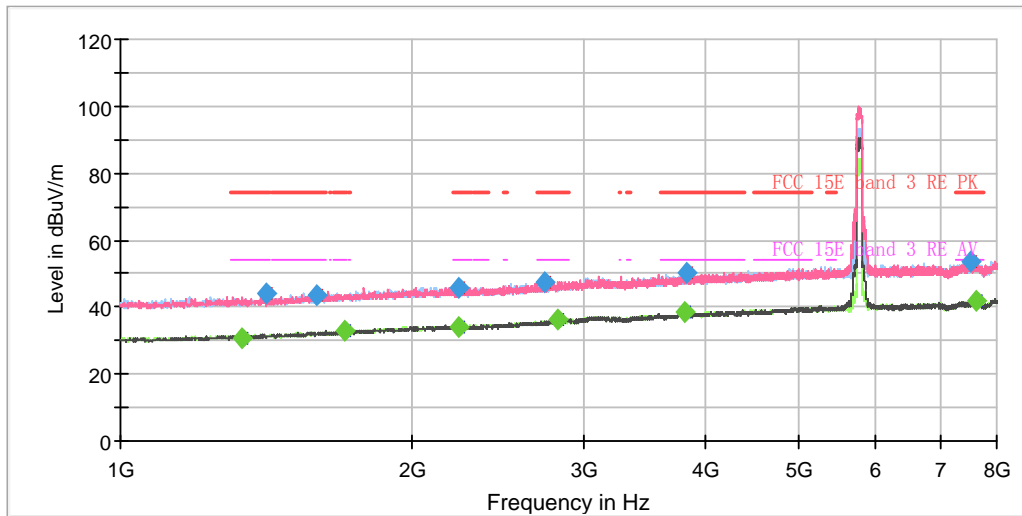

Note: The signal beyond the limit is carrier.
Radiates Emission from 1GHz to 8GHz

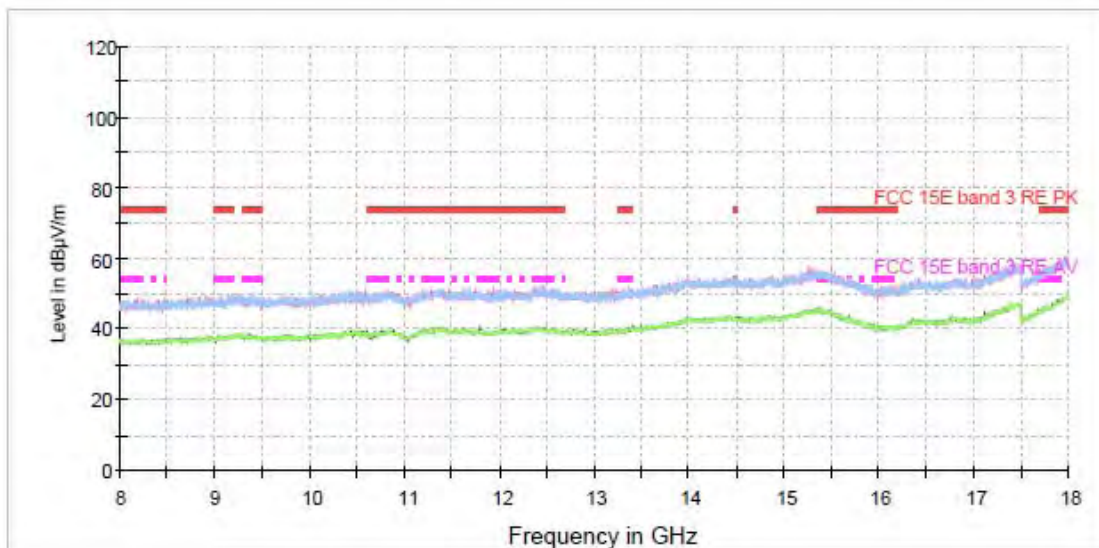

Radiates Emission from 8GHz to 18GHz



Frequency (MHz)	Peak (dBuV/m)	Average (dBuV/m)	Limit (dBuV/m)	Margin (dB)	Height (cm)	Polarization	Azimuth (deg)	Correct Factor (dB)
1331.625000	---	30.91	54.00	23.09	100.0	H	253.0	-7.1
1414.750000	44.02	---	74.00	29.98	100.0	V	243.0	-6.6
1594.125000	43.53	---	74.00	30.47	200.0	H	298.0	-5.6
1704.375000	---	33.01	54.00	20.99	100.0	V	209.0	-5.0
2232.875000	---	34.29	54.00	19.71	200.0	H	101.0	-2.6
2234.625000	46.02	---	74.00	27.98	100.0	H	41.0	-2.6
2730.750000	47.70	---	74.00	26.30	100.0	V	266.0	-0.3
2822.625000	---	36.21	54.00	17.79	100.0	V	323.0	0.2
3815.750000	---	38.57	54.00	15.43	200.0	V	289.0	3.5
3835.000000	49.99	---	74.00	24.01	200.0	H	18.0	3.6
7527.500000	53.30	---	74.00	20.70	100.0	V	115.0	9.9
7609.750000	---	41.92	54.00	12.08	200.0	H	35.0	10.1

Remark: 1. Correction Factor = Antenna factor+ Insertion loss (cable loss + amplifier gain)



During the test, the Radiates Emission from 18GHz to 40GHz was performed in all modes with all channels, 802.11n (HT40), Channel 102 are selected as the worst condition. The test data of the worst-case condition was recorded in this report.

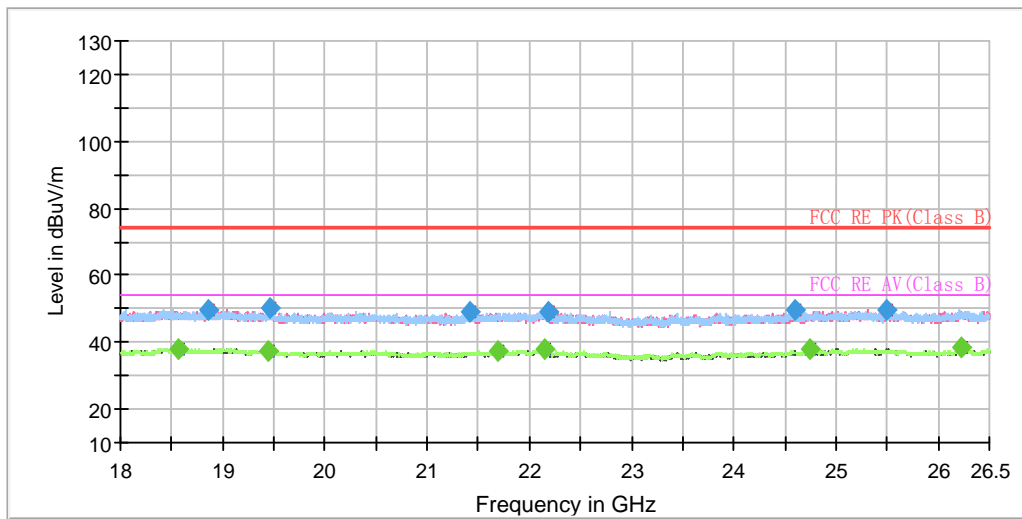

Radiates Emission from 18GHz to 26.5GHz

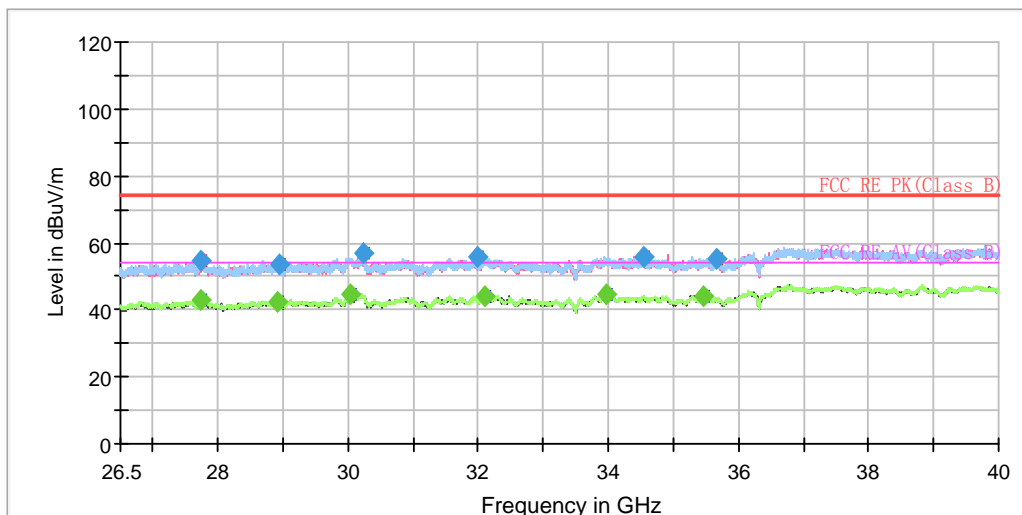

Radiates Emission from 26.5GHz to 40GHz



Frequency (MHz)	Peak (dBuV/m)	Average (dBuV/m)	Limit (dBuV/m)	Margin (dB)	Height (cm)	Polarization	Azimuth (deg)	Correct Factor (dB)
18568.437500	---	38.11	54.00	15.89	200.0	V	15.0	-4.9
18859.562500	49.74	---	74.00	24.26	200.0	H	26.0	-4.6
19447.125000	---	37.62	54.00	16.38	100.0	H	48.0	-4.4
19456.687500	50.27	---	74.00	23.73	100.0	V	237.0	-4.4
21411.687500	48.96	---	74.00	25.04	200.0	H	228.0	-2.9
21700.687500	---	37.35	54.00	16.65	200.0	H	155.0	-2.4
22151.187500	---	37.78	54.00	16.22	100.0	H	277.0	-2.1
22178.812500	49.34	---	74.00	24.66	200.0	H	83.0	-2.1
24602.375000	49.45	---	74.00	24.55	100.0	H	188.0	-0.8
24737.312500	---	37.64	54.00	16.36	200.0	V	110.0	-0.6
25498.062500	49.75	---	74.00	24.25	200.0	H	260.0	-0.6
26224.812500	---	38.29	54.00	15.71	100.0	H	211.0	-0.6

Remark: 1. Correction Factor = Antenna factor+ Insertion loss (cable loss + amplifier gain)

5.6. Conducted Emission

Ambient condition

Temperature	Relative humidity	Pressure
23°C ~25°C	45%~50%	101.5kPa

Methods of Measurement

The EUT IS placed on a non-metallic table of 80cm height above the horizontal metal reference ground plane. During the test, the EUT was operating in its typical mode. The test method is according to ANSI C63.10-2013. Connect the AC power line of the EUT to the LISN Use EMI receiver to detect the average and Quasi-peak value. RBW is set to 9kHz, VBW is set to 30kHz The measurement result should include both L line and N line.

The test is in transmitting mode.

Test Setup

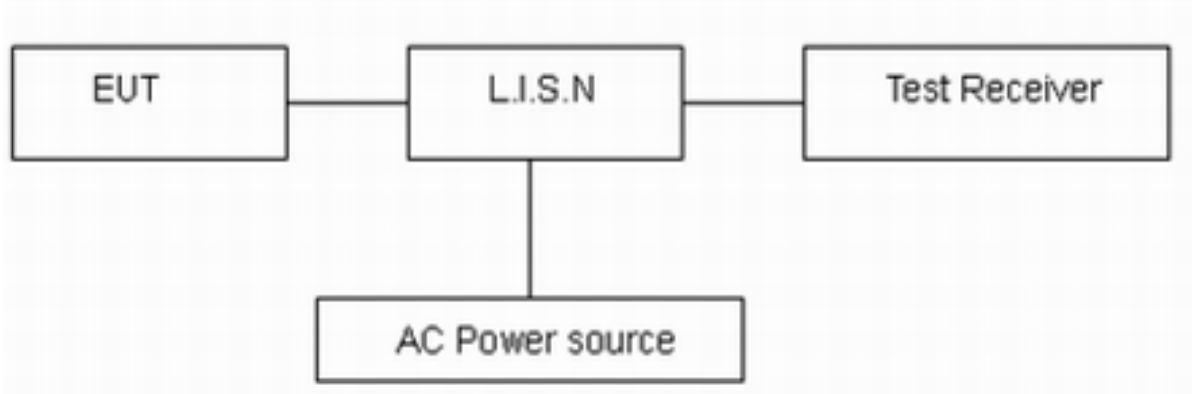

Note: AC Power source is used to change the voltage 110V/60Hz.

Limits

Frequency (MHz)	Conducted Limits(dBμV)	
	Quasi-peak	Average
0.15 - 0.5	66 to 56 *	56 to 46 *
0.5 - 5	56	46
5 - 30	60	50

*: Decreases with the logarithm of the frequency.

Measurement Uncertainty

The assessed measurement uncertainty to ensure 95% confidence level for the normal distribution is with the coverage factor $k = 1.96$, $U = 2.69$ dB.

Test Results:

Following plots, Blue trace uses the peak detection and Green trace uses the average detection. During the test, the Conducted Emission was performed in all modes with all channels, 802.11a, Channel 36 are selected as the worst condition. The test data of the worst-case condition was recorded in this report.

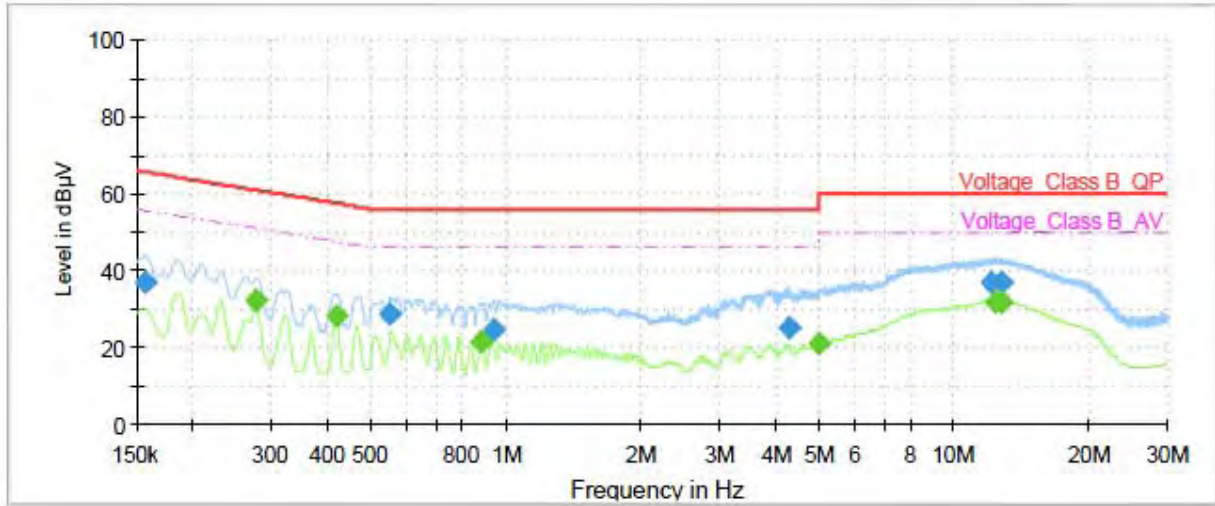

Frequency (MHz)	QuasiPeak (dBµV)	Average (dBµV)	Limit (dBµV)	Margin (dB)	Meas. Time (ms)	Bandwidth (kHz)	Line	Filter	Corr. (dB)
0.16	36.78	---	65.63	28.85	70.0	9.000	L1	ON	21
0.28	---	32.25	50.94	18.69	70.0	9.000	L1	ON	21
0.42	---	28.39	47.49	19.10	70.0	9.000	L1	ON	20
0.55	28.53	---	56.00	27.47	70.0	9.000	L1	ON	20
0.88	---	21.62	46.00	24.38	70.0	9.000	L1	ON	20
0.94	24.60	---	56.00	31.40	70.0	9.000	L1	ON	20
4.27	25.22	---	56.00	30.78	70.0	9.000	L1	ON	19
5.00	---	20.77	46.00	25.23	70.0	9.000	L1	ON	19
12.12	36.97	---	60.00	23.03	70.0	9.000	L1	ON	20
12.37	---	31.82	50.00	18.18	70.0	9.000	L1	ON	20
12.73	---	31.80	50.00	18.20	70.0	9.000	L1	ON	20
12.85	37.00	---	60.00	23.00	70.0	9.000	L1	ON	20

Remark: Correct factor=cable loss + LISN factor

L line Conducted Emission from 150 KHz to 30 MHz

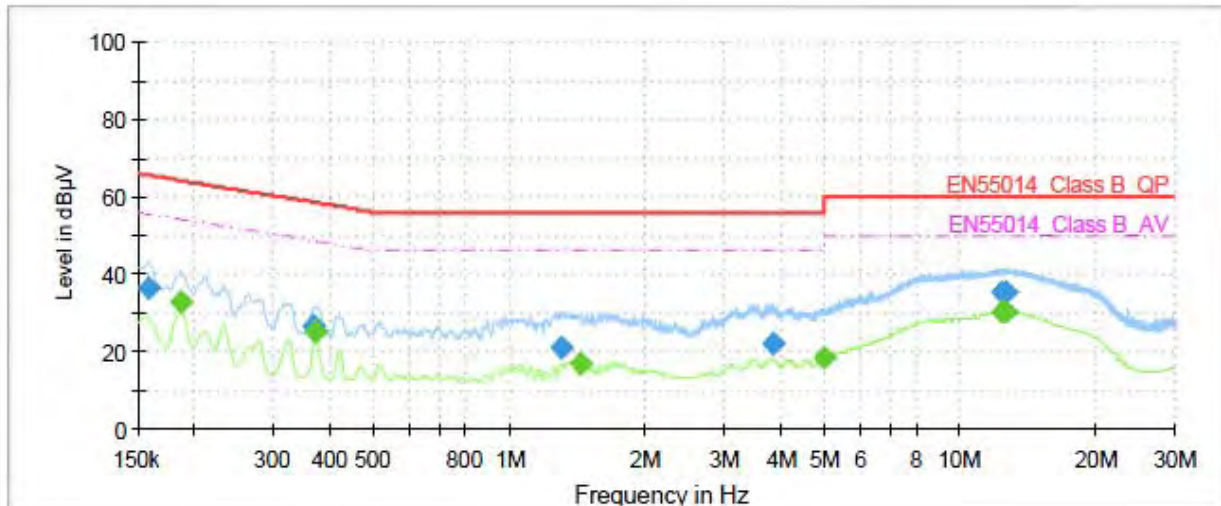

Frequency (MHz)	QuasiPeak (dBµV)	Average (dBµV)	Limit (dBµV)	Margin (dB)	Meas. Time (ms)	Bandwidth (kHz)	Line	Filter	Corr. (dB)
0.16	36.61	---	65.52	28.91	70.0	9.000	N	ON	21
0.19	---	33.07	54.21	21.14	70.0	9.000	N	ON	21
0.37	26.69	---	58.54	31.85	70.0	9.000	N	ON	21
0.37	---	25.16	48.49	23.33	70.0	9.000	N	ON	21
1.31	21.01	---	56.00	34.99	70.0	9.000	N	ON	20
1.43	---	17.15	46.00	28.85	70.0	9.000	N	ON	20
3.84	22.00	---	56.00	34.00	70.0	9.000	N	ON	19
4.99	---	18.51	46.00	27.49	70.0	9.000	N	ON	19
12.34	35.19	---	60.00	24.81	70.0	9.000	N	ON	20
12.36	---	30.29	50.00	19.71	70.0	9.000	N	ON	20
12.68	---	30.15	50.00	19.85	70.0	9.000	N	ON	20
12.70	35.31	---	60.00	24.69	70.0	9.000	N	ON	20

Remark: Correct factor=cable loss + LISN factor

N line Conducted Emission from 150 KHz to 30 MHz



6. Main Test Instruments

Name	Manufacturer	Type	Serial Number	Calibration Date	Expiration Date
Spectrum Analyzer	R&S	FSV40	15195-01-00	2020-05-18	2021-05-17
EMI Test Receiver	R&S	ESCI	100948	2020-05-18	2021-05-17
Loop Antenna	SCHWARZBECK	FMZB1519	1519-047	2020-04-02	2023-04-01
TRILOG Broadband Antenna	SCHWARZBECK	VULB 9163	391	2019-12-16	2021-12-15
Horn Antenna	R&S	HF907	102723	2018-08-11	2021-08-10
Horn Antenna	ETS-Lindgren	3160-09	00102643	2018-06-20	2021-06-19
Standard Gain Horn	STEATITE	QSH-SL-26-40 -K-15	16779	2019-12-24	2022-12-23
Broadband Horn Antenna	SCHWARZBECK	BBHA 9120D	430	2018-07-07	2021-07-06
EMI Test Receiver	R&S	ESR	101667	2020-05-18	2021-05-17
LISN	R&S	ENV216	101171	2018-12-15	2021-12-14
Spectrum Analyzer	KEYSIGHT	N9020A	MY54420163	2020-12-13	2021-12-12
RF Cable	Agilent	SMA 15cm	0001	2020-12-11	2022-06-10
TEMPERATURE CHAMBER	WEISS	VT4002	582261194500 10	2020-05-18	2021-05-17
WLAN AP	Cisco	Air-AP1262N- A-K9	LDK102073 (FCC ID)	/	/
Power Meter	R&S	NRP2	104306	2020-05-18	2021-05-17
Power Sensor	R&S	NRP-Z21	104799	2020-05-18	2021-05-17
DC Power Supply	GWINSTEK	GPS-3030D	GEP882653	2020-05-18	2021-05-17
Software	R&S	EMC32	9.26.0	/	/

*****END OF REPORT *****



ANNEX A: The EUT Appearance

The EUT Appearance are submitted separately.



ANNEX B: Test Setup Photos

The Test Setup Photos are submitted separately.