

FCC SAR Test Report

APPLICANT : Xiaomi Communications Co., Ltd.
EQUIPMENT : Mobile Phone
BRAND NAME : Redmi
MODEL NAME : XIG02
FCC ID : 2AFZZK19JR
STANDARD : FCC 47 CFR Part 2 (2.1093)

We, Sporton International (Kunshan) Inc, would like to declare that the tested sample has been evaluated in accordance with the procedures and had been in compliance with the applicable technical standards.

The test results in this report apply exclusively to the tested model / sample. Without written approval of Sporton International (Kunshan) Inc., the test report shall not be reproduced except in full.



Reviewed by: Nick Hu / Supervisor



Approved by: Kat Yin / Manager



Sporton International (Kunshan) Inc.

No. 1098, Pengxi North Road, Kunshan Economic Development Zone Jiangsu Province 215300
People's Republic of China



Table of Contents

1. Statement of Compliance 4
2. Administration Data 5
3. Guidance Applied 5
4. Equipment Under Test (EUT) Information 6
4.1 General Information 6
4.2 General LTE SAR Test and Reporting Considerations 7
5. Proximity Sensor Triggering Test 9
5.1 Proximity sensor triggering distances(Per KDB616217§6.2) 9
6. RF Exposure Limits 11
6.1 Uncontrolled Environment 11
6.2 Controlled Environment 11
7. Specific Absorption Rate (SAR) 12
7.1 Introduction 12
7.2 SAR Definition 12
8. System Description and Setup 13
8.1 E-Field Probe 14
8.2 Data Acquisition Electronics (DAE) 14
8.3 Phantom 15
8.4 Device Holder 16
9. Measurement Procedures 17
9.1 Spatial Peak SAR Evaluation 17
9.2 Power Reference Measurement 18
9.3 Area Scan 18
9.4 Zoom Scan 19
9.5 Volume Scan Procedures 19
9.6 Power Drift Monitoring 19
10. Test Equipment List 20
11. System Verification 21
11.1 Tissue Simulating Liquids 21
11.2 Tissue Verification 22
11.3 System Performance Check Results 23
12. RF Exposure Positions 24
12.1 Ear and handset reference point 24
12.2 Definition of the cheek position 25
12.3 Definition of the tilt position 26
12.4 Body Worn Accessory 27
12.5 Product Specific 10g SAR Exposure 28
12.6 Wireless Router 28
13. Conducted RF Output Power (Unit: dBm) 29
14. Antenna Location 42
15. SAR Test Results 43
15.1 Head SAR 46
15.2 Hotspot SAR 51
15.3 Body Worn Accessory SAR 58
15.4 Product specific 10g SAR 62
15.5 Repeated SAR Measurement 63
16. Simultaneous Transmission Analysis 64
16.1 Head Exposure Conditions 65
16.2 Hotspot Exposure Conditions 66
16.3 Body-Worn Accessory Exposure Conditions 67
17. Uncertainty Assessment 68
18. References 69
Appendix A. Plots of System Performance Check
Appendix B. Plots of High SAR Measurement
Appendix C. DASy Calibration Certificate
Appendix D. Test Setup Photos
Appendix E. Conducted RF Output Power Table



1. Statement of Compliance

The maximum results of Specific Absorption Rate (SAR) found during testing for **Xiaomi Communications Co., Ltd., Mobile Phone, XIG02**, are as follows.

Highest 1g SAR Summary						
Equipment Class	Frequency Band		Head (Separation 0mm)	Hotspot (Separation 10mm)	Body-worn (Separation 10mm)	Highest Simultaneous Transmission 1g SAR (W/kg)
			1g SAR (W/kg)			
Licensed	GSM	GSM850	1.06	0.37	0.37	1.59
		GSM1900	0.78	0.97	0.42	
	WCDMA	Band II	0.92	1.05	0.52	
		Band IV	0.80	1.00	0.68	
		Band V	0.80	0.68	0.68	
	LTE	Band 4	0.80	1.09	0.79	
		Band 7	1.09	1.09	0.60	
		Band 12/Band 17	0.73	0.25	0.25	
		Band 13	1.06	0.36	0.36	
		Band 26/ Band 5	0.93	0.52	0.52	
	Band 38	1.04	1.07	0.49		
DTS	WLAN	2.4GHz WLAN	0.51	0.21	0.16	1.57
NII		5GHz WLAN	0.41	0.25	0.36	1.59
DSS	Bluetooth	2.4GHz Bluetooth	<0.10	<0.10	<0.10	1.59

Highest 10g SAR Summary			
Equipment Class	Frequency Band		Product Specific 10g SAR (W/kg) (Separation 0mm)
NII	WLAN	5GHz WLAN	0.62

Date of Testing: 2021/5/10 ~ 2021/5/25

Remark: This device supports LTE B17 / B5 and B12 / B26. Since the supported frequency span for LTE B17 / B5 falls completely within the supports frequency span for LTE B12 / B26, both LTE bands have the same target power, and both LTE bands share the same transmission path; therefore, SAR was only assessed for LTE B12 / B26.

Declaration of Conformity:

The test results with all measurement uncertainty excluded are presented in accordance with the regulation limits or requirements declared by manufacturers.

Comments and Explanations:

The declared of product specification for EUT presented in the report are provided by the manufacturer, and the manufacturer takes all the responsibilities for the accuracy of product specification.

This device is in compliance with Specific Absorption Rate (SAR) for general population/uncontrolled exposure limits (1.6 W/kg for Partial-Body 1g SAR, 4.0 W/kg for Product Specific 10g SAR) specified in FCC 47 CFR part 2 (2.1093) and ANSI/IEEE C95.1-1992, and had been tested in accordance with the measurement methods and procedures specified in IEEE 1528-2013 and FCC KDB publications.



2. Administration Data

Sporton International (Kunshan) Inc. is accredited to ISO/IEC 17025:2017 by American Association for Laboratory Accreditation with Certificate Number 5145.02.

Testing Laboratory		
Test Firm	Sporton International (Kunshan) Inc.	
Test Site Location	No. 1098, Pengxi North Road, Kunshan Economic Development Zone Jiangsu Province 215300 People's Republic of China TEL : +86-512-57900158 FAX : +86-512-57900958	
Test Site No.	FCC Designation No.	FCC Test Firm Registration No.
	CN1257	314309

Applicant	
Company Name	Xiaomi Communications Co., Ltd.
Address	#019, 9th Floor, Building 6, 33 Xi'erqi Middle Road, Haidian District, Beijing, China, 100085

Manufacturer	
Company Name	Xiaomi Communications Co., Ltd.
Address	#019, 9th Floor, Building 6, 33 Xi'erqi Middle Road, Haidian District, Beijing, China, 100085

3. Guidance Applied

The Specific Absorption Rate (SAR) testing specification, method, and procedure for this device is in accordance with the following standards:

- FCC 47 CFR Part 2 (2.1093)
- ANSI/IEEE C95.1-1992
- IEEE 1528-2013
- FCC KDB 865664 D01 SAR Measurement 100 MHz to 6 GHz v01r04
- FCC KDB 865664 D02 SAR Reporting v01r02
- FCC KDB 447498 D01 General RF Exposure Guidance v06
- FCC KDB 648474 D04 SAR Evaluation Considerations for Wireless Handsets v01r03
- FCC KDB 248227 D01 802.11 Wi-Fi SAR v02r02
- FCC KDB 616217 D04 SAR for laptop and tablets v01r02
- FCC KDB 941225 D01 3G SAR Procedures v03r01
- FCC KDB 941225 D05 SAR for LTE Devices v02r05
- FCC KDB 941225 D05A Rel.10 LTE SAR Test Guidance v01r02
- FCC KDB 941225 D06 Hotspot Mode SAR v02r01

4. Equipment Under Test (EUT) Information

4.1 General Information

Product Feature & Specification	
Equipment Name	Mobile Phone
Brand Name	Redmi
Model Name	XIG02
FCC ID	2AFZZK19JR
IMEI Code	868096050017051
Wireless Technology and Frequency Range	GSM850: 824 MHz ~ 849 MHz GSM1900: 1850 MHz ~ 1910 MHz WCDMA Band II: 1850 MHz ~ 1910 MHz WCDMA Band IV: 1710 MHz ~ 1755 MHz WCDMA Band V: 824 MHz ~ 849 MHz LTE Band 4: 1710 MHz ~ 1755 MHz LTE Band 5: 824 MHz ~ 849 MHz LTE Band 7: 2500 MHz ~ 2570 MHz LTE Band 12: 699 MHz ~ 716 MHz LTE Band 13: 777 MHz ~ 787 MHz LTE Band 17: 704 MHz ~ 716 MHz LTE Band 26: 814 MHz ~ 849 MHz LTE Band 38: 2570 MHz ~ 2620 MHz WLAN 2.4GHz Band: 2412 MHz ~ 2462 MHz WLAN 5.2GHz Band: 5180 MHz ~ 5240 MHz WLAN 5.3GHz Band: 5260 MHz ~ 5320 MHz WLAN 5.5GHz Band: 5500 MHz ~ 5720 MHz WLAN 5.8GHz Band: 5745 MHz ~ 5825 MHz Bluetooth: 2402 MHz ~ 2480 MHz NFC: 13.56 MHz
Mode	GSM/GPRS/EGPRS RMC/AMR 12.2Kbps HSDPA HSUPA DC-HSDPA HSPA+(16QAM uplink is not supported) LTE: QPSK, 16QAM, 64QAM, 256QAM(Downlink only) WLAN 2.4GHz 802.11b/g/n HT20/HT40 WLAN 5GHz 802.11a/n HT20/HT40 WLAN 5GHz 802.11ac VHT20/VHT40/VHT80 Bluetooth BR/EDR/LE NFC:ASK
HW Version	P1.1
SW Version	MIUI12.5
GSM / (E)GPRS Transfer mode	Class B – EUT cannot support Packet Switched and Circuit Switched Network simultaneously but can automatically switch between Packet and Circuit Switched Network.
EUT Stage	Identical Prototype
Remark:	
<ol style="list-style-type: none"> 1. This device supports VoIP in GPRS, EGPRS, WCDMA and LTE (e.g. for 3rd-party VoIP), LTE supports VoLTE operation. 2. This device 2.4GHz WLAN support hotspot operation and Bluetooth support tethering applications. 3. This device 2.4GHz WLAN/5.2GHz WLAN/5.8GHz WLAN support hotspot operation, and 5.2GHz WLAN/5.8GHz WLAN supports WiFi Direct (GC/GO), and 5.3GHz / 5.5GHz supports WiFi Direct (GC only). 4. This device does not support DTM operation and supports GPRS/EGPRS mode up to multi-slot class 33. 5. The device implements Proximity sensors/receiver detect mechanism reduced power for the power management for SAR compliance at different exposure conditions (head, body-worn, hotspot, extremity). The device will invoke corresponding work scenarios power level base on frequency bands/antennas, which can refer to appendix E. power table. (DSI 1: receiver on head power; DSI 3/4: P-sensor on for hotspot/body-worn; DSI 2: receiver off /P-sensor off for hotspot/body-worn). 	



4.2 General LTE SAR Test and Reporting Considerations

Summarized necessary items addressed in KDB 941225 D05 v02r05																																																															
FCC ID	2AFZZK19JR																																																														
Equipment Name	Mobile Phone																																																														
Operating Frequency Range of each LTE transmission band	LTE Band 4: 1710 MHz ~ 1755 MHz LTE Band 5: 824 MHz ~ 849 MHz LTE Band 7: 2500 MHz ~ 2570 MHz LTE Band 12: 699 MHz ~ 716 MHz LTE Band 13: 777 MHz ~ 787 MHz LTE Band 17: 704 MHz ~ 716 MHz LTE Band 26: 814 MHz ~ 849 MHz LTE Band 38: 2570 MHz ~ 2620 MHz																																																														
Channel Bandwidth	LTE Band 4: 1.4MHz, 3MHz, 5MHz, 10MHz, 15MHz, 20MHz LTE Band 5: 1.4MHz, 3MHz, 5MHz, 10MHz LTE Band 7: 5MHz, 10MHz, 15MHz, 20MHz LTE Band 12: 1.4MHz, 3MHz, 5MHz, 10MHz LTE Band 13: 5MHz, 10MHz LTE Band 17: 5MHz, 10MHz LTE Band 26: 1.4MHz, 3MHz, 5MHz, 10MHz, 15MHz LTE Band 38: 5MHz, 10MHz, 15MHz, 20MHz																																																														
uplink modulations used	QPSK / 16QAM / 64QAM																																																														
LTE Voice / Data requirements	Voice and Data																																																														
LTE Release Version	R15, Cat13																																																														
CA Support	Supported, Uplink and Downlink																																																														
LTE MPR permanently built-in by design	<p>Table 6.2.3-1: Maximum Power Reduction (MPR) for Power Class 1, 2 and 3</p> <table border="1"> <thead> <tr> <th rowspan="2">Modulation</th> <th colspan="6">Channel bandwidth / Transmission bandwidth (N_{RB})</th> <th rowspan="2">MPR (dB)</th> </tr> <tr> <th>1.4 MHz</th> <th>3.0 MHz</th> <th>5 MHz</th> <th>10 MHz</th> <th>15 MHz</th> <th>20 MHz</th> </tr> </thead> <tbody> <tr> <td>QPSK</td> <td>> 5</td> <td>> 4</td> <td>> 8</td> <td>> 12</td> <td>> 16</td> <td>> 18</td> <td>≤ 1</td> </tr> <tr> <td>16 QAM</td> <td>≤ 5</td> <td>≤ 4</td> <td>≤ 8</td> <td>≤ 12</td> <td>≤ 16</td> <td>≤ 18</td> <td>≤ 1</td> </tr> <tr> <td>16 QAM</td> <td>> 5</td> <td>> 4</td> <td>> 8</td> <td>> 12</td> <td>> 16</td> <td>> 18</td> <td>≤ 2</td> </tr> <tr> <td>64 QAM</td> <td>≤ 5</td> <td>≤ 4</td> <td>≤ 8</td> <td>≤ 12</td> <td>≤ 16</td> <td>≤ 18</td> <td>≤ 2</td> </tr> <tr> <td>64 QAM</td> <td>> 5</td> <td>> 4</td> <td>> 8</td> <td>> 12</td> <td>> 16</td> <td>> 18</td> <td>≤ 3</td> </tr> <tr> <td>256 QAM</td> <td colspan="6">≥ 1</td> <td>≤ 5</td> </tr> </tbody> </table>	Modulation	Channel bandwidth / Transmission bandwidth (N _{RB})						MPR (dB)	1.4 MHz	3.0 MHz	5 MHz	10 MHz	15 MHz	20 MHz	QPSK	> 5	> 4	> 8	> 12	> 16	> 18	≤ 1	16 QAM	≤ 5	≤ 4	≤ 8	≤ 12	≤ 16	≤ 18	≤ 1	16 QAM	> 5	> 4	> 8	> 12	> 16	> 18	≤ 2	64 QAM	≤ 5	≤ 4	≤ 8	≤ 12	≤ 16	≤ 18	≤ 2	64 QAM	> 5	> 4	> 8	> 12	> 16	> 18	≤ 3	256 QAM	≥ 1						≤ 5
Modulation	Channel bandwidth / Transmission bandwidth (N _{RB})						MPR (dB)																																																								
	1.4 MHz	3.0 MHz	5 MHz	10 MHz	15 MHz	20 MHz																																																									
QPSK	> 5	> 4	> 8	> 12	> 16	> 18	≤ 1																																																								
16 QAM	≤ 5	≤ 4	≤ 8	≤ 12	≤ 16	≤ 18	≤ 1																																																								
16 QAM	> 5	> 4	> 8	> 12	> 16	> 18	≤ 2																																																								
64 QAM	≤ 5	≤ 4	≤ 8	≤ 12	≤ 16	≤ 18	≤ 2																																																								
64 QAM	> 5	> 4	> 8	> 12	> 16	> 18	≤ 3																																																								
256 QAM	≥ 1						≤ 5																																																								
LTE A-MPR	In the base station simulator configuration, Network Setting value is set to NS_01 to disable A-MPR during SAR testing and the LTE SAR tests was transmitting on all TTI frames (Maximum TTI)																																																														
Spectrum plots for RB configuration	A properly configured base station simulator was used for the SAR and power measurement; therefore, spectrum plots for each RB allocation and offset configuration are not included in the SAR report.																																																														
Power reduction applied to satisfy SAR compliance	Yes, head/body-worn/ hotspot/extremity will trigger reduced power for some LTE bands, the detail please referred to section 13.																																																														
LTE Carrier Aggregation Combinations	Intra-Band possible combinations and the detail power verification please referred to section 13.																																																														
LTE Carrier Aggregation Additional Information	1. This device supports LTE Carrier Aggregation (CA) in the uplink for 7C/38C with two component carriers in the uplink. SAR Measurements and conducted powers were evaluated per FCC Guidance. 2. This device supports maximum of 2 carriers in the downlink and 2 carriers in the uplink.																																																														



Transmission (H, M, L) channel numbers and frequencies in each LTE band												
LTE Band 4												
	Bandwidth 1.4 MHz		Bandwidth 3 MHz		Bandwidth 5 MHz		Bandwidth 10 MHz		Bandwidth 15 MHz		Bandwidth 20 MHz	
	Ch. #	Freq. (MHz)	Ch. #	Freq. (MHz)	Ch. #	Freq. (MHz)	Ch. #	Freq. (MHz)	Ch. #	Freq. (MHz)	Ch. #	Freq. (MHz)
L	19957	1710.7	19965	1711.5	19975	1712.5	20000	1715	20025	1717.5	20050	1720
M	20175	1732.5	20175	1732.5	20175	1732.5	20175	1732.5	20175	1732.5	20175	1732.5
H	20393	1754.3	20385	1753.5	20375	1752.5	20350	1750	20325	1747.5	20300	1745
LTE Band 5												
	Bandwidth 1.4 MHz		Bandwidth 3 MHz		Bandwidth 5 MHz		Bandwidth 10 MHz					
	Ch. #	Freq. (MHz)	Ch. #	Freq. (MHz)	Ch. #	Freq. (MHz)	Ch. #	Freq. (MHz)	Ch. #	Freq. (MHz)		
L	20407	824.7	20415	825.5	20425	826.5	20450	829				
M	20525	836.5	20525	836.5	20525	836.5	20525	836.5	20525	836.5		
H	20643	848.3	20635	847.5	20625	846.5	20600	844				
LTE Band 7												
	Bandwidth 5 MHz		Bandwidth 10 MHz		Bandwidth 15 MHz		Bandwidth 20 MHz					
	Ch. #	Freq. (MHz)	Ch. #	Freq. (MHz)	Ch. #	Freq. (MHz)	Ch. #	Freq. (MHz)	Ch. #	Freq. (MHz)		
L	20775	2502.5	20800	2505	20825	2507.5	20850	2510				
M	21100	2535	21100	2535	21100	2535	21100	2535	21100	2535		
H	21425	2567.5	21400	2565	21375	2562.5	21350	2560				
LTE Band 12												
	Bandwidth 1.4 MHz		Bandwidth 3 MHz		Bandwidth 5 MHz		Bandwidth 10 MHz					
	Ch. #	Freq. (MHz)	Ch. #	Freq. (MHz)	Ch. #	Freq. (MHz)	Ch. #	Freq. (MHz)	Ch. #	Freq. (MHz)		
L	23017	699.7	23025	700.5	23035	701.5	23060	704				
M	23095	707.5	23095	707.5	23095	707.5	23095	707.5	23095	707.5		
H	23173	715.3	23165	714.5	23155	713.5	23130	711				
LTE Band 13												
	Bandwidth 5 MHz				Bandwidth 10 MHz							
	Channel #		Freq.(MHz)		Channel #		Freq.(MHz)					
L	23205		779.5		23230		782					
M	23230		782									
H	23255		784.5									
LTE Band 17												
	Bandwidth 5 MHz				Bandwidth 10 MHz							
	Channel #		Freq.(MHz)		Channel #		Freq. (MHz)					
L	23755		706.5		23780		709					
M	23790		710		23790		710					
H	23825		713.5		23800		711					
LTE Band 26												
	Bandwidth 1.4 MHz		Bandwidth 3 MHz		Bandwidth 5 MHz		Bandwidth 10 MHz		Bandwidth 15 MHz			
	Ch. #	Freq. (MHz)	Ch. #	Freq. (MHz)	Ch. #	Freq. (MHz)	Ch. #	Freq. (MHz)	Ch. #	Freq. (MHz)		
L	26697	814.7	26705	815.5	26715	816.5	26740	819	26765	821.5		
M	26865	831.5	26865	831.5	26865	831.5	26865	831.5	26865	831.5		
H	27033	848.3	27025	847.5	27015	846.5	26990	844	26965	841.5		
LTE Band 38												
	Bandwidth 5 MHz		Bandwidth 10 MHz		Bandwidth 15 MHz		Bandwidth 20 MHz					
	Ch. #	Freq. (MHz)	Ch. #	Freq. (MHz)	Ch. #	Freq. (MHz)	Ch. #	Freq. (MHz)	Ch. #	Freq. (MHz)		
L	37775	2572.5	37800	2575	37825	2577.5	37850	2580				
M	38000	2595	38000	2595	38000	2595	38000	2595	38000	2595		
H	38225	2617.5	38200	2615	38175	2612.5	38150	2610				

5. Proximity Sensor Triggering Test

5.1 Proximity sensor triggering distances(Per KDB616217§6.2)

- Proximity sensor triggering distance testing was performed according to the procedures outlined in KDB 616217 D04 section 6.2, and EUT moving further away from the flat phantom and EUT moving toward the flat phantom were both assessed and the tissue-equivalent medium for highest frequency (2600 MHz) and lowest (750MHz) frequency was used for proximity sensor triggering testing.
- Capacitive proximity sensor placed coincident with antenna elements at the top/bottom end of the phone are utilized to determine when the device comes in proximity of the user's body at the front or back or bottom or top or left side surface of the device. There is no need to do sensor coverage testing for the proximity sensor is designed to support sufficient detection range and sensitivity to cover regions of the sensors in all applicable directions since the proximity sensor entirely covers the antenna.
- When the proximity sensor is active, GSM1900, WCDMA band II/IV, LTE band 4/7/38 reduced power will be active for front/ back/bottom/top/left body worn SAR.
- The proximity sensors used to detect the proximity of the user's body at the front or back or bottom or top or left side surface of the device use a detection threshold distance. The data shown in the sections below shows the distance(s).
- The detailed proximity sensor trigger diagram plot can refer to proximity sensor operation description.
- For verification of compliance of power reduction scheme, additional SAR testing with EUT transmitting at full RF power at a conservative trigger distance was performed for body worn:
 ANT1:
 Front: 15 mm
 Back: 15 mm
 Bottom side: 15 mm
 ANT4:
 Front: 15 mm
 Back: 15 mm
 Left side: 15 mm
 Top side: 15 mm

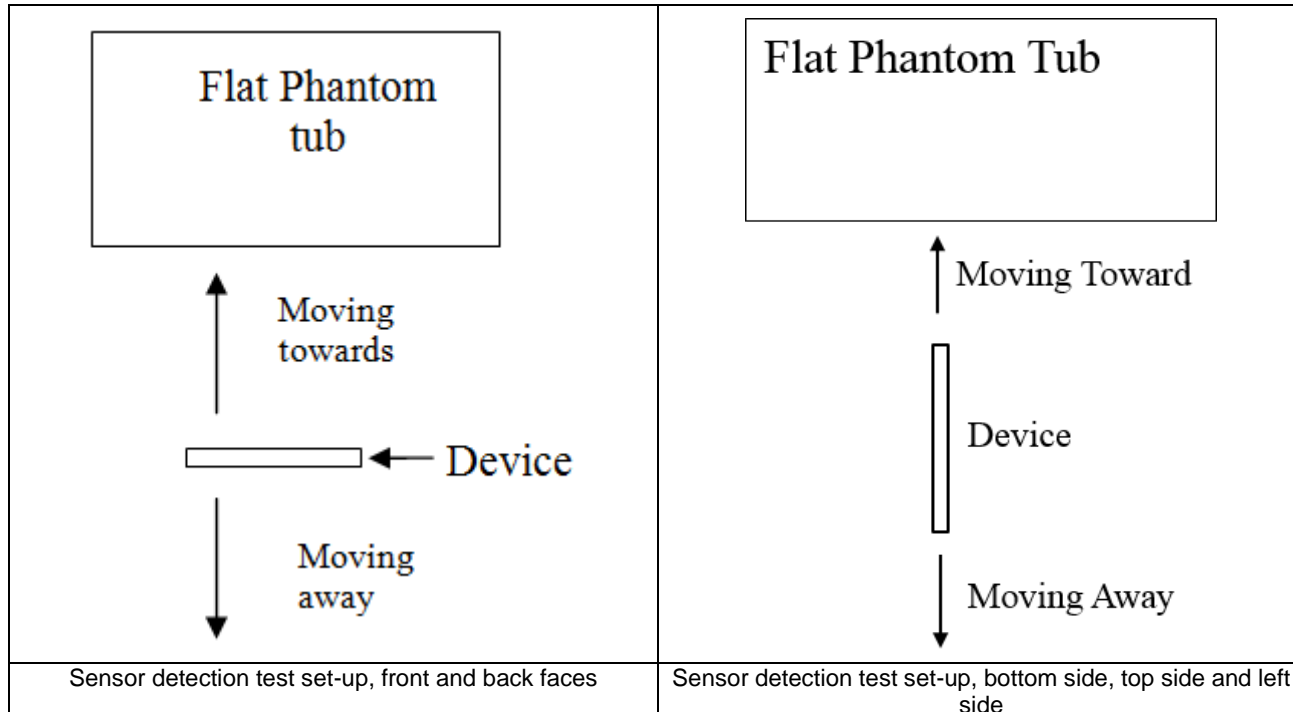



<P-Sensor>

Antenna 1:

Position	Front		Back		Bottom Side	
	Moving towards	Moving away	Moving towards	Moving towards	Moving towards	Moving away
Minimum	16	16	16	16	16	16

Antenna 4:

Position	Front		Back		Top Side		Left Side	
	Moving towards	Moving away	Moving towards	Moving towards	Moving towards	Moving away	Moving towards	Moving away
Minimum	16	16	16	16	16	16	16	16

6. RF Exposure Limits

6.1 Uncontrolled Environment

Uncontrolled Environments are defined as locations where there is the exposure of individuals who have no knowledge or control of their exposure. The general population/uncontrolled exposure limits are applicable to situations in which the general public may be exposed or in which persons who are exposed as a consequence of their employment may not be made fully aware of the potential for exposure or cannot exercise control over their exposure. Members of the general public would come under this category when exposure is not employment-related; for example, in the case of a wireless transmitter that exposes persons in its vicinity.

6.2 Controlled Environment

Controlled Environments are defined as locations where there is exposure that may be incurred by persons who are aware of the potential for exposure, (i.e. as a result of employment or occupation). In general, occupational/controlled exposure limits are applicable to situations in which persons are exposed as a consequence of their employment, who have been made fully aware of the potential for exposure and can exercise control over their exposure. The exposure category is also applicable when the exposure is of a transient nature due to incidental passage through a location where the exposure levels may be higher than the general population/uncontrolled limits, but the exposed person is fully aware of the potential for exposure and can exercise control over his or her exposure by leaving the area or by some other appropriate means.

Limits for Occupational/Controlled Exposure (W/kg)

Whole-Body	Partial-Body	Hands, Wrists, Feet and Ankles
0.4	8.0	20.0

Limits for General Population/Uncontrolled Exposure (W/kg)

Whole-Body	Partial-Body	Hands, Wrists, Feet and Ankles
0.08	1.6	4.0

Whole-Body SAR is averaged over the entire body, partial-body SAR is averaged over any 1gram of tissue defined as a tissue volume in the shape of a cube. SAR for hands, wrists, feet and ankles is averaged over any 10 grams of tissue defined as a tissue volume in the shape of a cube.

7. Specific Absorption Rate (SAR)

7.1 Introduction

SAR is related to the rate at which energy is absorbed per unit mass in an object exposed to a radio field. The SAR distribution in a biological body is complicated and is usually carried out by experimental techniques or numerical modeling. The standard recommends limits for two tiers of groups, occupational/controlled and general population/uncontrolled, based on a person's awareness and ability to exercise control over his or her exposure. In general, occupational/controlled exposure limits are higher than the limits for general population/uncontrolled.

7.2 SAR Definition

The SAR definition is the time derivative (rate) of the incremental energy (dW) absorbed by (dissipated in) an incremental mass (dm) contained in a volume element (dv) of a given density (ρ). The equation description is as below:

$$\text{SAR} = \frac{d}{dt} \left(\frac{dW}{dm} \right) = \frac{d}{dt} \left(\frac{dW}{\rho dv} \right)$$

SAR is expressed in units of Watts per kilogram (W/kg)

$$\text{SAR} = \frac{\sigma |E|^2}{\rho}$$

Where: σ is the conductivity of the tissue, ρ is the mass density of the tissue and E is the RMS electrical field strength.

8. System Description and Setup

The DASY system used for performing compliance tests consists of the following items:

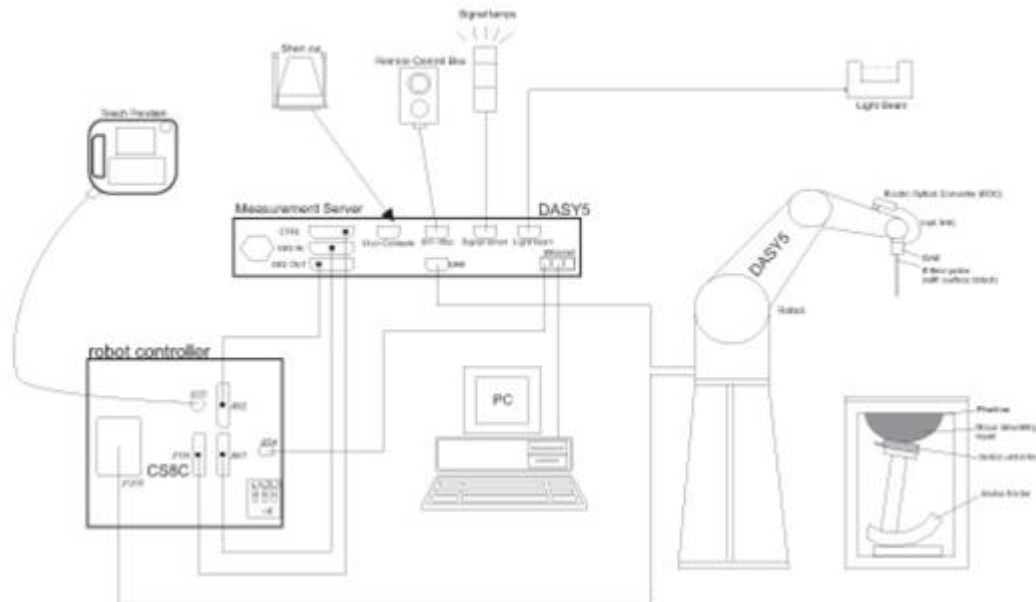

- A standard high precision 6-axis robot with controller, teach pendant and software. An arm extension for accommodating the data acquisition electronics (DAE).
- An isotropic Field probe optimized and calibrated for the targeted measurement.
- A data acquisition electronics (DAE) which performs the signal amplification, signal multiplexing, AD-conversion, offset measurements, mechanical surface detection, collision detection, etc. The unit is battery powered with standard or rechargeable batteries. The signal is optically transmitted to the EOC.
- The Electro-optical converter (EOC) performs the conversion from optical to electrical signals for the digital communication to the DAE. To use optical surface detection, a special version of the EOC is required. The EOC signal is transmitted to the measurement server.
- The function of the measurement server is to perform the time critical tasks such as signal filtering, control of the robot operation and fast movement interrupts.
- The Light Beam used is for probe alignment. This improves the (absolute) accuracy of the probe positioning.
- A computer running WinXP or Win7 and the DASY5 software.
- Remote control and teach pendant as well as additional circuitry for robot safety such as warning lamps, etc.
- The phantom, the device holder and other accessories according to the targeted measurement.

8.1 E-Field Probe

The SAR measurement is conducted with the dosimetric probe (manufactured by SPEAG).The probe is specially designed and calibrated for use in liquid with high permittivity. The dosimetric probe has special calibration in liquid at different frequency. This probe has a built in optical surface detection system to prevent from collision with phantom.

<EX3DV4 Probe>

Construction	Symmetric design with triangular core Built-in shielding against static charges PEEK enclosure material (resistant to organic solvents, e.g., DGBE)	
Frequency	10 MHz – >6 GHz Linearity: ±0.2 dB (30 MHz – 6 GHz)	
Directivity	±0.3 dB in TSL (rotation around probe axis) ±0.5 dB in TSL (rotation normal to probe axis)	
Dynamic Range	10 µW/g – >100 mW/g Linearity: ±0.2 dB (noise: typically <1 µW/g)	
Dimensions	Overall length: 337 mm (tip: 20 mm) Tip diameter: 2.5 mm (body: 12 mm) Typical distance from probe tip to dipole centers: 1 mm	

8.2 Data Acquisition Electronics (DAE)

The data acquisition electronics (DAE) consists of a highly sensitive electrometer-grade preamplifier with auto-zeroing, a channel and gain-switching multiplexer, a fast 16 bit AD-converter and a command decoder and control logic unit. Transmission to the measurement server is accomplished through an optical downlink for data and status information as well as an optical uplink for commands and the clock.

The input impedance of the DAE is 200 MOhm; the inputs are symmetrical and floating. Common mode rejection is above 80 dB.



Photo of DAE

8.3 Phantom

<SAM Twin Phantom>

Shell Thickness	2 ± 0.2 mm; Center ear point: 6 ± 0.2 mm	
Filling Volume	Approx. 25 liters	
Dimensions	Length: 1000 mm; Width: 500 mm; Height: adjustable feet	
Measurement Areas	Left Hand, Right Hand, Flat Phantom	

The bottom plate contains three pair of bolts for locking the device holder. The device holder positions are adjusted to the standard measurement positions in the three sections. A white cover is provided to tap the phantom during off-periods to prevent water evaporation and changes in the liquid parameters. On the phantom top, three reference markers are provided to identify the phantom position with respect to the robot.

<ELI Phantom>

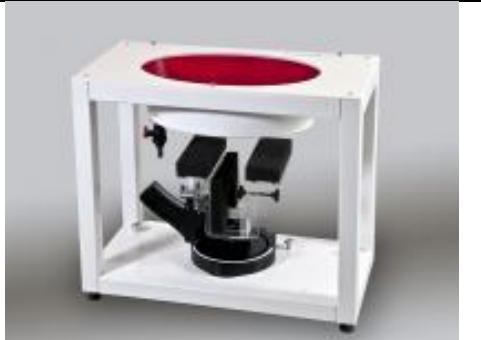
Shell Thickness	2 ± 0.2 mm (sagging: <1%)	
Filling Volume	Approx. 30 liters	
Dimensions	Major ellipse axis: 600 mm Minor axis: 400 mm	

The ELI phantom is intended for compliance testing of handheld and body-mounted wireless devices in the frequency range of 30 MHz to 6 GHz. ELI4 is fully compatible with standard and all known tissue simulating liquids.

8.4 Device Holder

<Mounting Device for Hand-Held Transmitter>

In combination with the Twin SAM V5.0/V5.0c or ELI phantoms, the Mounting Device for Hand-Held Transmitters enables rotation of the mounted transmitter device to specified spherical coordinates. At the heads, the rotation axis is at the ear opening. Transmitter devices can be easily and accurately positioned according to IEC 62209-1, IEEE 1528, FCC, or other specifications. The device holder can be locked for positioning at different phantom sections (left head, right head, flat). And upgrade kit to Mounting Device to enable easy mounting of wider devices like big smart-phones, e-books, small tablets, etc. It holds devices with width up to 140 mm.



Mounting Device for Hand-Held Transmitters



Mounting Device Adaptor for Wide-Phones

<Mounting Device for Laptops and other Body-Worn Transmitters>

The extension is lightweight and made of POM, acrylic glass and foam. It fits easily on the upper part of the mounting device in place of the phone positioned. The extension is fully compatible with the SAM Twin and ELI phantoms.



Mounting Device for Laptops

9. Measurement Procedures

The measurement procedures are as follows:

<Conducted power measurement>

- (a) For WWAN power measurement, use base station simulator to configure EUT WWAN transmission in conducted connection with RF cable, at maximum power in each supported wireless interface and frequency band.
- (b) Read the WWAN RF power level from the base station simulator.
- (c) For WLAN/BT power measurement, use engineering software to configure EUT WLAN/BT continuously transmission, at maximum RF power in each supported wireless interface and frequency band
- (d) Connect EUT RF port through RF cable to the power meter, and measure WLAN/BT output power

<SAR measurement>

- (a) Use base station simulator to configure EUT WWAN transmission in radiated connection, and engineering software to configure EUT WLAN/BT continuously transmission, at maximum RF power, in the highest power channel.
- (b) Place the EUT in the positions as Appendix D demonstrates.
- (c) Set scan area, grid size and other setting on the DASY software.
- (d) Measure SAR results for the highest power channel on each testing position.
- (e) Find out the largest SAR result on these testing positions of each band
- (f) Measure SAR results for other channels in worst SAR testing position if the reported SAR of highest power channel is larger than 0.8 W/kg

According to the test standard, the recommended procedure for assessing the peak spatial-average SAR value consists of the following steps:

- (a) Power reference measurement
- (b) Area scan
- (c) Zoom scan
- (d) Power drift measurement

9.1 Spatial Peak SAR Evaluation

The procedure for spatial peak SAR evaluation has been implemented according to the test standard. It can be conducted for 1g and 10g, as well as for user-specific masses. The DASY software includes all numerical procedures necessary to evaluate the spatial peak SAR value.

The base for the evaluation is a "cube" measurement. The measured volume must include the 1g and 10g cubes with the highest averaged SAR values. For that purpose, the center of the measured volume is aligned to the interpolated peak SAR value of a previously performed area scan.

The entire evaluation of the spatial peak values is performed within the post-processing engine (SEMCAD). The system always gives the maximum values for the 1g and 10g cubes. The algorithm to find the cube with highest averaged SAR is divided into the following stages:

- (a) Extraction of the measured data (grid and values) from the Zoom Scan
- (b) Calculation of the SAR value at every measurement point based on all stored data (A/D values and measurement parameters)
- (c) Generation of a high-resolution mesh within the measured volume
- (d) Interpolation of all measured values from the measurement grid to the high-resolution grid
- (e) Extrapolation of the entire 3-D field distribution to the phantom surface over the distance from sensor to surface
- (f) Calculation of the averaged SAR within masses of 1g and 10g

9.2 Power Reference Measurement

The Power Reference Measurement and Power Drift Measurements are for monitoring the power drift of the device under test in the batch process. The minimum distance of probe sensors to surface determines the closest measurement point to phantom surface. This distance cannot be smaller than the distance of sensor calibration points to probe tip as defined in the probe properties.

9.3 Area Scan

The area scan is used as a fast scan in two dimensions to find the area of high field values, before doing a fine measurement around the hot spot. The sophisticated interpolation routines implemented in DASY software can find the maximum found in the scanned area, within a range of the global maximum. The range (in dB0 is specified in the standards for compliance testing. For example, a 2 dB range is required in IEEE standard 1528 and IEC 62209 standards, whereby 3 dB is a requirement when compliance is assessed in accordance with the ARIB standard (Japan), if only one zoom scan follows the area scan, then only the absolute maximum will be taken as reference. For cases where multiple maximums are detected, the number of zoom scans has to be increased accordingly.

Area scan parameters extracted from FCC KDB 865664 D01v01r04 SAR measurement 100 MHz to 6 GHz.

	≤ 3 GHz	> 3 GHz
Maximum distance from closest measurement point (geometric center of probe sensors) to phantom surface	5 ± 1 mm	$\frac{1}{2} \cdot \delta \cdot \ln(2) \pm 0.5$ mm
Maximum probe angle from probe axis to phantom surface normal at the measurement location	30° ± 1°	20° ± 1°
Maximum area scan spatial resolution: Δx_{Area} , Δy_{Area}	≤ 2 GHz: ≤ 15 mm 2 – 3 GHz: ≤ 12 mm	3 – 4 GHz: ≤ 12 mm 4 – 6 GHz: ≤ 10 mm
	When the x or y dimension of the test device, in the measurement plane orientation, is smaller than the above, the measurement resolution must be ≤ the corresponding x or y dimension of the test device with at least one measurement point on the test device.	

9.4 Zoom Scan

Zoom scans are used to assess the peak spatial SAR values within a cubic averaging volume containing 1 gram and 10 gram of simulated tissue. The zoom scan measures points (refer to table below) within a cube whose base faces are centered on the maxima found in a preceding area scan job within the same procedure. When the measurement is done, the zoom scan evaluates the averaged SAR for 1 gram and 10 gram and displays these values next to the job's label.

Zoom scan parameters extracted from FCC KDB 865664 D01v01r04 SAR measurement 100 MHz to 6 GHz.

		≤ 3 GHz	> 3 GHz	
Maximum zoom scan spatial resolution: Δx_{Zoom} , Δy_{Zoom}		≤ 2 GHz: ≤ 8 mm 2 – 3 GHz: ≤ 5 mm*	3 – 4 GHz: ≤ 5 mm* 4 – 6 GHz: ≤ 4 mm*	
Maximum zoom scan spatial resolution, normal to phantom surface	uniform grid: $\Delta z_{Zoom}(n)$	≤ 5 mm	3 – 4 GHz: ≤ 4 mm 4 – 5 GHz: ≤ 3 mm 5 – 6 GHz: ≤ 2 mm	
	graded grid	$\Delta z_{Zoom}(1)$: between 1 st two points closest to phantom surface	≤ 4 mm	3 – 4 GHz: ≤ 3 mm 4 – 5 GHz: ≤ 2.5 mm 5 – 6 GHz: ≤ 2 mm
		$\Delta z_{Zoom}(n>1)$: between subsequent points	$\leq 1.5 \cdot \Delta z_{Zoom}(n-1)$	
Minimum zoom scan volume	x, y, z	≥ 30 mm	3 – 4 GHz: ≥ 28 mm 4 – 5 GHz: ≥ 25 mm 5 – 6 GHz: ≥ 22 mm	
Note: δ is the penetration depth of a plane-wave at normal incidence to the tissue medium; see draft standard IEEE P1528-2011 for details. * When zoom scan is required and the <i>reported</i> SAR from the <i>area scan based 1-g SAR estimation</i> procedures of KDB 447498 is ≤ 1.4 W/kg, ≤ 8 mm, ≤ 7 mm and ≤ 5 mm zoom scan resolution may be applied, respectively, for 2 GHz to 3 GHz, 3 GHz to 4 GHz and 4 GHz to 6 GHz.				

9.5 Volume Scan Procedures

The volume scan is used to assess overlapping SAR distributions for antennas transmitting in different frequency bands. It is equivalent to an oversized zoom scan used in standalone measurements. The measurement volume will be used to enclose all the simultaneous transmitting antennas. For antennas transmitting simultaneously in different frequency bands, the volume scan is measured separately in each frequency band. In order to sum correctly to compute the 1g aggregate SAR, the EUT remain in the same test position for all measurements and all volume scan use the same spatial resolution and grid spacing. When all volume scan were completed, the software, SEMCAD postprocessor can combine and subsequently superpose these measurement data to calculating the multiband SAR.

9.6 Power Drift Monitoring

All SAR testing is under the EUT install full charged battery and transmit maximum output power. In DASy measurement software, the power reference measurement and power drift measurement procedures are used for monitoring the power drift of EUT during SAR test. Both these procedures measure the field at a specified reference position before and after the SAR testing. The software will calculate the field difference in dB. If the power drifts more than 5%, the SAR will be retested.



10. Test Equipment List

Manufacturer	Name of Equipment	Type/Model	Serial Number	Calibration	
				Last Cal.	Due Date
SPEAG	750MHz System Validation Kit	D750V3	1087	2019/3/27	2022/3/24
SPEAG	835MHz System Validation Kit	D835V2	4d258	2020/5/7	2023/5/6
SPEAG	1750MHz System Validation Kit	D1750V2	1090	2019/3/27	2022/3/25
SPEAG	1900MHz System Validation Kit	D1900V2	5d170	2019/3/26	2022/3/25
SPEAG	2450MHz System Validation Kit	D2450V2	908	2019/3/25	2022/3/23
SPEAG	2600MHz System Validation Kit	D2600V2	1061	2020/11/26	2021/11/25
SPEAG	5000MHz System Validation Kit	D5GHZV2	1113	2019/9/24	2022/9/23
SPEAG	Data Acquisition Electronics	DAE4	799	2021/3/26	2022/3/25
SPEAG	Dosimetric E-Field Probe	EX3DV4	3843	2020/9/23	2021/9/22
SPEAG	SAM Twin Phantom	SAM Twin	TP-1754	NCR	NCR
SPEAG	Phone Positioner	N/A	N/A	NCR	NCR
Anritsu	Radio Communication Analyzer	MT8821C	6201432831	2021/4/13	2022/4/12
Agilent	ENA Series Network Analyzer	E5071C	MY46106933	2020/8/1	2021/7/31
SPEAG	Dielectric Probe Kit	DAK-3.5	1144	2020/12/2	2021/12/1
Anritsu	Vector Signal Generator	MG3710A	6201682672	2021/1/7	2022/1/6
Rohde & Schwarz	Power Meter	NRVD	102081	2020/8/13	2021/8/12
Rohde & Schwarz	Power Sensor	NRV-Z5	100538	2020/8/13	2021/8/12
Rohde & Schwarz	Power Sensor	NRV-Z5	100539	2020/8/13	2021/8/12
R&S	CBT BLUETOOTH TESTER	CBT	101246	2021/4/12	2022/4/11
EXA	Spectrum Analyzer	FSV7	101632	2021/1/7	2022/1/6
Testo	Hygrometer	608-H1	1241332088	2021/1/7	2022/1/6
FLUKE	DIGITAC THERMOMETER	51II	97240029	2020/8/14	2021/8/13
ARRA	Power Divider	A3200-2	N/A	Note 1	
MCL	Attenuation1	BW-S10W5+	N/A	Note 1	
MCL	Attenuation2	BW-S10W5+	N/A	Note 1	
MCL	Attenuation3	BW-S10W5+	N/A	Note 1	
BONN	POWER AMPLIFIER	BLMA 0830-3	087193A	Note 1	
BONN	POWER AMPLIFIER	BLMA 2060-2	087193B	Note 1	
Agilent	Dual Directional Coupler	778D	20500	Note 1	
Agilent	Dual Directional Coupler	11691D	MY48151020	Note 1	

Note:

1. Prior to system verification and validation, the path loss from the signal generator to the system check source and the power meter, which includes the amplifier, cable, attenuator and directional coupler, was measured by the network analyzer. The reading of the power meter was offset by the path loss difference between the path to the power meter and the path to the system check source to monitor the actual power level fed to the system check
2. Referring to KDB 865664 D01v01r04, the dipole calibration interval can be extended to 3 years with justification. The dipoles are also not physically damaged, or repaired during the interval.
3. The justification data of dipole can be found in appendix C. The return loss is < -20dB, within 20% of prior calibration, the impedance is within 5 ohm of prior calibration.

11. System Verification

11.1 Tissue Simulating Liquids

For the measurement of the field distribution inside the SAM phantom with DASY, the phantom must be filled with around 25 liters of homogeneous body tissue simulating liquid. For head SAR testing, the liquid height from the ear reference point (ERP) of the phantom to the liquid top surface is larger than 15 cm, which is shown in Fig. 11.1. For body SAR testing, the liquid height from the center of the flat phantom to the liquid top surface is larger than 15 cm, which is shown in Fig. 11.2.

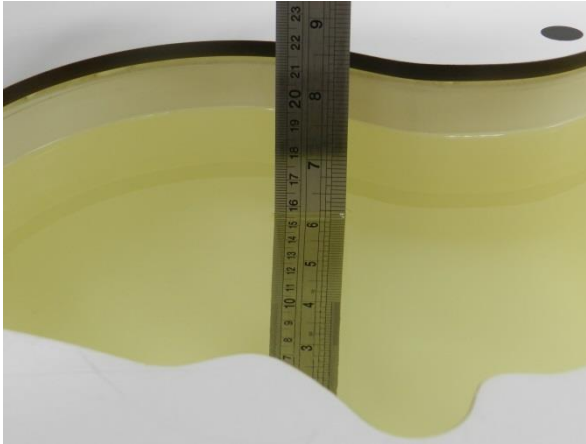

Fig 11.1 Photo of Liquid Height for Head SAR

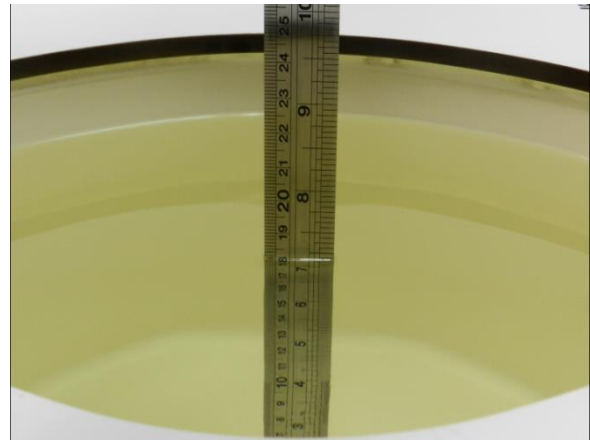

Fig 11.2 Photo of Liquid Height for Body SAR



11.2 Tissue Verification

The following tissue formulations are provided for reference only as some of the parameters have not been thoroughly verified. The composition of ingredients may be modified accordingly to achieve the desired target tissue parameters required for routine SAR evaluation.

Frequency (MHz)	Water (%)	Sugar (%)	Cellulose (%)	Salt (%)	Preventol (%)	DGBE (%)	Conductivity (σ)	Permittivity (ε _r)
For Head								
750	41.1	57.0	0.2	1.4	0.2	0	0.89	41.9
835	40.3	57.9	0.2	1.4	0.2	0	0.90	41.5
1800, 1900, 2000	55.2	0	0	0.3	0	44.5	1.40	40.0
2450	55.0	0	0	0	0	45.0	1.80	39.2
2600	54.8	0	0	0.1	0	45.1	1.96	39.0

Simulating Liquid for 5GHz, Manufactured by SPEAG

Ingredients	(% by weight)
Water	64~78%
Mineral oil	11~18%
Emulsifiers	9~15%
Additives and Salt	2~3%

<Tissue Dielectric Parameter Check Results>

Frequency (MHz)	Tissue Type	Liquid Temp. (°C)	Conductivity (σ)	Permittivity (ε _r)	Conductivity Target (σ)	Permittivity Target (ε _r)	Delta (σ) (%)	Delta (ε _r) (%)	Limit (%)	Date
750	Head	22.6	0.919	43.619	0.89	41.90	3.26	4.10	±5	2021/5/10
835	Head	22.8	0.929	42.215	0.90	41.50	3.22	1.72	±5	2021/5/12
1750	Head	22.9	1.340	40.374	1.37	40.10	-2.19	0.68	±5	2021/5/14
1900	Head	22.7	1.436	40.147	1.40	40.00	2.57	0.37	±5	2021/5/16
2450	Head	22.7	1.872	40.812	1.80	39.20	4.00	4.11	±5	2021/5/18
2600	Head	22.6	1.982	40.590	1.96	39.00	1.12	4.08	±5	2021/5/20
5250	Head	22.8	4.593	36.254	4.71	35.90	-2.48	0.99	±5	2021/5/22
5600	Head	22.7	4.985	35.584	5.07	35.50	-1.68	0.24	±5	2021/5/24
5750	Head	22.8	5.144	35.542	5.22	35.40	-1.46	0.40	±5	2021/5/25

11.3 System Performance Check Results

Comparing to the original SAR value provided by SPEAG, the verification data should be within its specification of 10 %. Below table shows the target SAR and measured SAR after normalized to 1W input power. The table below indicates the system performance check can meet the variation criterion and the plots can be referred to Appendix A of this report.

<1g SAR>

Date	Frequency (MHz)	Tissue Type	Input Power (mW)	Dipole S/N	Probe S/N	DAE S/N	Measured 1g SAR (W/kg)	Targeted 1g SAR (W/kg)	Normalized 1g SAR (W/kg)	Deviation (%)
2021/5/10	750	Head	50	1087	3843	799	0.446	8.36	8.92	6.70
2021/5/12	835	Head	50	d258	3843	799	0.512	9.44	10.24	8.47
2021/5/14	1750	Head	50	1090	3843	799	1.930	36.40	38.6	6.04
2021/5/16	1900	Head	50	5d170	3843	799	2.120	39.00	42.4	8.72
2021/5/18	2450	Head	50	908	3843	799	2.770	52.80	55.4	4.92
2021/5/20	2600	Head	50	1061	3843	799	3.040	56.60	60.8	7.42
2021/5/22	5250	Head	50	1113	3843	799	4.320	80.50	86.4	7.33
2021/5/24	5600	Head	50	1113	3843	799	4.490	83.40	89.8	7.67
2021/5/25	5750	Head	50	1113	3843	799	4.230	80.00	84.6	5.75

<10g SAR>

Date	Frequency (MHz)	Tissue Type	Input Power (mW)	Dipole S/N	Probe S/N	DAE S/N	Measured 10g SAR (W/kg)	Targeted 10g SAR (W/kg)	Normalized 10g SAR (W/kg)	Deviation (%)
2021/5/22	5250	Head	50	1113	3843	799	1.240	23.10	24.8	7.36
2021/5/24	5600	Head	50	1113	3843	799	1.270	23.80	25.4	6.72

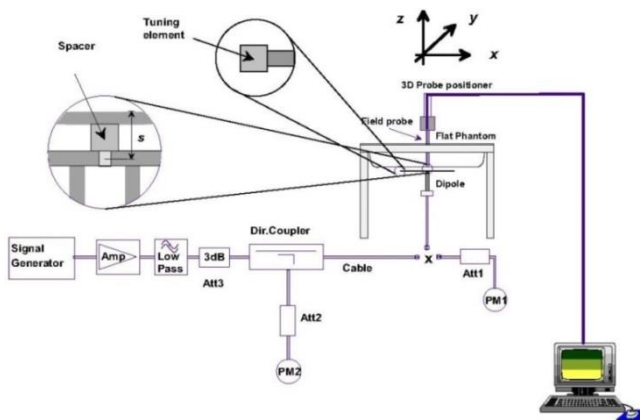

Fig 11.3.1 System Performance Check Setup



Fig 11.3.2 Setup Photo

12. RF Exposure Positions

12.1 Ear and handset reference point

Figure 12.1.1 shows the front, back, and side views of the SAM phantom. The center-of-mouth reference point is labeled “M,” the left ear reference point (ERP) is marked “LE,” and the right ERP is marked “RE.” Each ERP is 15 mm along the B-M (back-mouth) line behind the entrance-to-ear-canal (EEC) point, as shown in Figure 12.1.2 The Reference Plane is defined as passing through the two ear reference points and point M. The line N-F (neck-front), also called the reference pivoting line, is normal to the Reference Plane and perpendicular to both a line passing through RE and LE and the B-M line (see Figure 12.1.3). Both N-F and B-M lines should be marked on the exterior of the phantom shell to facilitate handset positioning. Posterior to the N-F line the ear shape is a flat surface with 6 mm thickness at each ERP, and forward of the N-F line the ear is truncated, as illustrated in Figure 12.1.2. The ear truncation is introduced to preclude the ear lobe from interfering with handset tilt, which could lead to unstable positioning at the cheek.

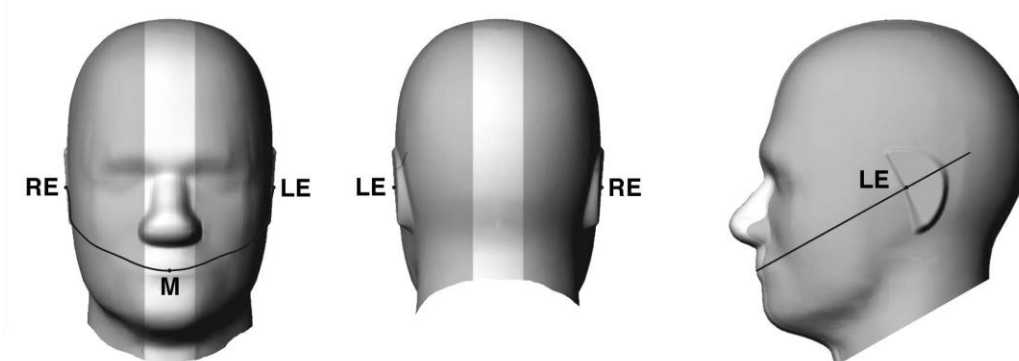

Fig 12.1.1 Front, back, and side views of SAM twin phantom

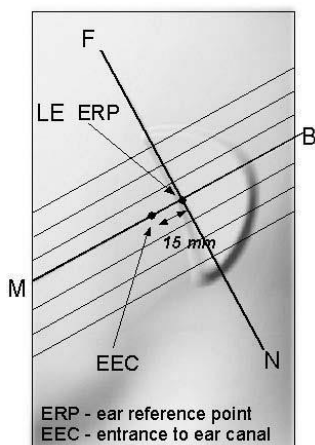

Fig 12.1.2 Close-up side view of phantom showing the ear region.

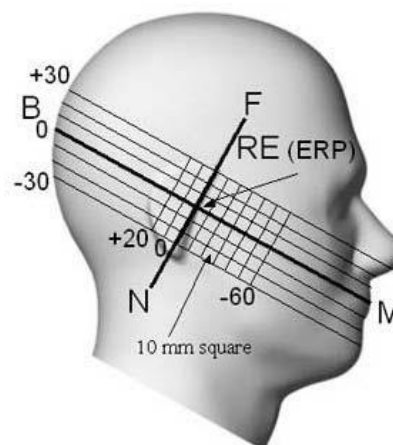

Fig 12.1.3 Side view of the phantom showing relevant markings and seven cross-sectional plane locations

12.2 Definition of the cheek position

1. Ready the handset for talk operation, if necessary. For example, for handsets with a cover piece (flip cover), open the cover. If the handset can transmit with the cover closed, both configurations must be tested.
2. Define two imaginary lines on the handset—the vertical centerline and the horizontal line. The vertical centerline passes through two points on the front side of the handset—the midpoint of the width w_t of the handset at the level of the acoustic output (point A in Figure 12.2.1 and Figure 12.2.2), and the midpoint of the width w_b of the bottom of the handset (point B). The horizontal line is perpendicular to the vertical centerline and passes through the center of the acoustic output (see Figure 12.2.1). The two lines intersect at point A. Note that for many handsets, point A coincides with the center of the acoustic output; however, the acoustic output may be located elsewhere on the horizontal line. Also note that the vertical centerline is not necessarily parallel to the front face of the handset (see Figure 12.2.2), especially for clamshell handsets, handsets with flip covers, and other irregularly-shaped handsets.
3. Position the handset close to the surface of the phantom such that point A is on the (virtual) extension of the line passing through points RE and LE on the phantom (see Figure 12.2.3), such that the plane defined by the vertical centerline and the horizontal line of the handset is approximately parallel to the sagittal plane of the phantom.
4. Translate the handset towards the phantom along the line passing through RE and LE until handset point A touches the pinna at the ERP.
5. While maintaining the handset in this plane, rotate it around the LE-RE line until the vertical centerline is in the plane normal to the plane containing B-M and N-F lines, i.e., the Reference Plane.
6. Rotate the handset around the vertical centerline until the handset (horizontal line) is parallel to the N-F line.
7. While maintaining the vertical centerline in the Reference Plane, keeping point A on the line passing through RE and LE, and maintaining the handset contact with the pinna, rotate the handset about the N-F line until any point on the handset is in contact with a phantom point below the pinna on the cheek. See Figure 12.2.3. The actual rotation angles should be documented in the test report.

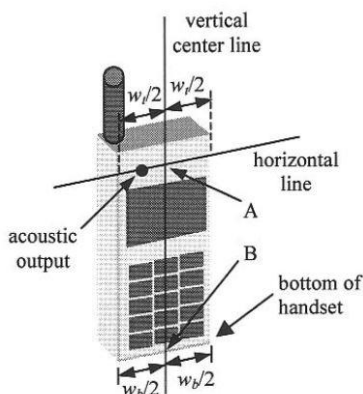

Fig 12.2.1 Handset vertical and horizontal reference lines—“fixed case”

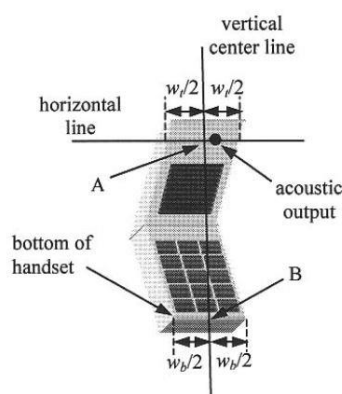

Fig 12.2.2 Handset vertical and horizontal reference lines—“clam-shell case”

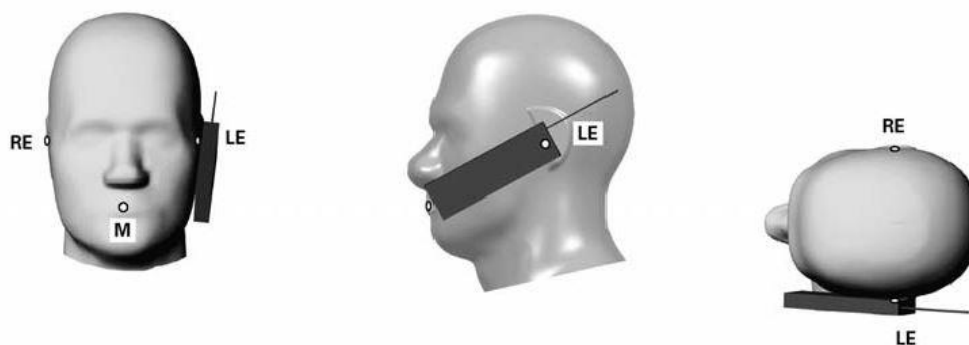

Fig 12.2.3 cheek or touch position. The reference points for the right ear (RE), left ear (LE), and mouth (M), which establish the Reference Plane for handset positioning, are indicated.

12.3 Definition of the tilt position

1. Ready the handset for talk operation, if necessary. For example, for handsets with a cover piece (flip cover), open the cover. If the handset can transmit with the cover closed, both configurations must be tested.
2. While maintaining the orientation of the handset, move the handset away from the pinna along the line passing through RE and LE far enough to allow a rotation of the handset away from the cheek by 15°.
3. Rotate the handset around the horizontal line by 15°.
4. While maintaining the orientation of the handset, move the handset towards the phantom on the line passing through RE and LE until any part of the handset touches the ear. The tilt position is obtained when the contact point is on the pinna. See Figure 12.3.1. If contact occurs at any location other than the pinna, e.g., the antenna at the back of the phantom head, the angle of the handset should be reduced. In this case, the tilt position is obtained if any point on the handset is in contact with the pinna and a second point

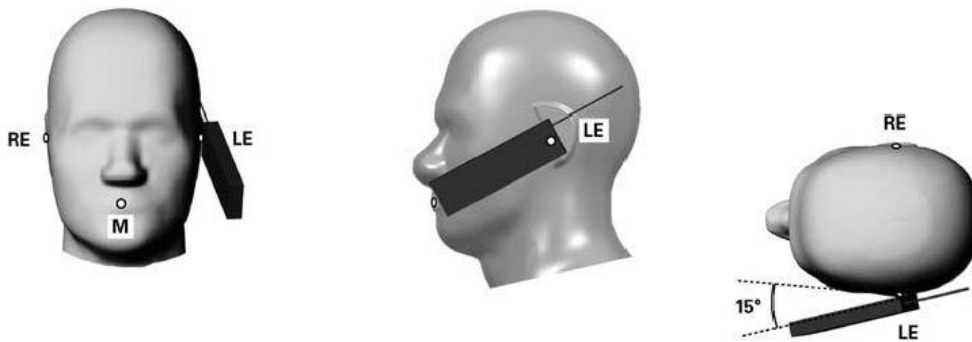

Fig 12.3.1 Tilt position. The reference points for the right ear (RE), left ear (LE), and mouth (M), which define the Reference Plane for handset positioning, are indicated.

12.4 Body Worn Accessory

Body-worn operating configurations are tested with the belt-clips and holsters attached to the device and positioned against a flat phantom in a normal use configuration (see Figure 12.4). Per KDB648474 D04v01r03, body-worn accessory exposure is typically related to voice mode operations when handsets are carried in body-worn accessories. The body-worn accessory procedures in FCC KDB 447498 D01v06 should be used to test for body-worn accessory SAR compliance, without a headset connected to it. This enables the test results for such configuration to be compatible with that required for hotspot mode when the body-worn accessory test separation distance is greater than or equal to that required for hotspot mode, when applicable. When the reported SAR for body-worn accessory, measured without a headset connected to the handset is $> 1.2 \text{ W/kg}$, the highest reported SAR configuration for that wireless mode and frequency band should be repeated for that body-worn accessory with a headset attached to the handset.

Accessories for body-worn operation configurations are divided into two categories: those that do not contain metallic components and those that do contain metallic components. When multiple accessories that do not contain metallic components are supplied with the device, the device is tested with only the accessory that dictates the closest spacing to the body. Then multiple accessories that contain metallic components are tested with the device with each accessory. If multiple accessories share an identical metallic component (i.e. the same metallic belt-clip used with different holsters with no other metallic components) only the accessory that dictates the closest spacing to the body is tested.

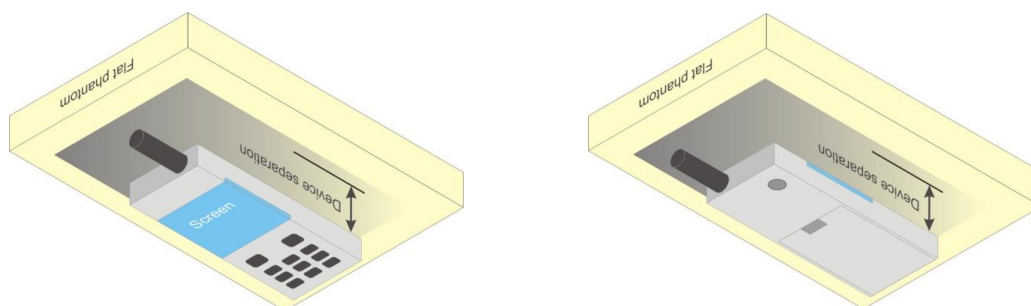

Fig 12.4 Body Worn Position

12.5 Product Specific 10g SAR Exposure

For smart phones with a display diagonal dimension > 15.0 cm or an overall diagonal dimension > 16.0 cm that provide similar mobile web access and multimedia support found in mini-tablets or UMPC mini-tablets that support voice calls next to the ear, According to KDB648474 D04v01r03, the following phablet procedures should be applied to evaluate SAR compliance for each applicable wireless modes and frequency band. Devices marketed as phablets, regardless of form factors and operating characteristics must be tested as a phablet to determine SAR compliance

1. The normally required head and body-worn accessory SAR test procedures for handsets, including hotspot mode, must be applied.
2. The UMPC mini-tablet procedures must also be applied to test the SAR of all surfaces and edges with an antenna located at ≤ 25 mm from that surface or edge, in direct contact with a flat phantom, for 10-g extremity SAR according to the body-equivalent tissue dielectric parameters in KDB 865664 to address interactive hand use exposure conditions.6 The UMPC mini-tablet 1-g SAR at 5 mm is not required. When hotspot mode applies, 10-g extremity SAR is required only for the surfaces and edges with hotspot mode 1-g reported SAR > 1.2 W/kg.

12.6 Wireless Router

Some battery-operated handsets have the capability to transmit and receive user through simultaneous transmission of WIFI simultaneously with a separate licensed transmitter. The FCC has provided guidance in FCC KDB Publication 941225 D06 v02r01 where SAR test considerations for handsets ($L \times W \geq 9$ cm x 5 cm) are based on a composite test separation distance of 10mm from the front, back and edges of the device containing transmitting antennas within 2.5cm of their edges, determined from general mixed use conditions for this type of devices. Since the hotspot SAR results may overlap with the body-worn accessory SAR requirements, the more conservative configurations can be considered, thus excluding some body-worn accessory SAR tests.

When the user enables the personal wireless router functions for the handset, actual operations include simultaneous transmission of both the WIFI transmitter and another licensed transmitter. Both transmitters often do not transmit at the same transmitting frequency and thus cannot be evaluated for SAR under actual use conditions due to the limitations of the SAR assessment probes. Therefore, SAR must be evaluated for each frequency transmission and mode separately and spatially summed with the WIFI transmitter according to FCC KDB Publication 447498 D01v06 publication procedures. The "Portable Hotspot" feature on the handset was NOT activated during SAR assessments, to ensure the SAR measurements were evaluated for a single transmission frequency RF signal at a time.

13. Conducted RF Output Power (Unit: dBm)

The detailed conducted power table can refer to Appendix E.

<GSM Conducted Power>

1. Per KDB 447498 D01v06, the maximum output power channel is used for SAR testing and for further SAR test reduction.
2. Per KDB 941225 D01v03r01, for SAR test reduction for GSM / GPRS / EDGE modes is determined by the source-based time-averaged output power including tune-up tolerance. The mode with highest specified time-averaged output power should be tested for SAR compliance in the applicable exposure conditions. For modes with the same specified maximum output power and tolerance, the higher number time-slot configuration should be tested. Therefore, the GPRS 4Tx slots for GSM850 /GSM1900 are considered as the primary mode.
3. Other configurations of GSM / GPRS / EDGE are considered as secondary modes. The 3G SAR test reduction procedure is applied, when the maximum output power and tune-up tolerance specified for production units in a secondary mode is $\leq \frac{1}{4}$ dB higher than the primary mode, SAR measurement is not required for the secondary mode.

<WCDMA Conducted Power>

1. The following tests were conducted according to the test requirements outlines in 3GPP TS 34.121 specification.
2. The procedures in KDB 941225 D01v03r01 are applied for 3GPP Rel. 6 HSPA to configure the device in the required sub-test mode(s) to determine SAR test exclusion.
3. For DC-HSDPA, the device was configured according to the H-Set 12, Fixed Reference Channel (FRC) configuration in Table C.8.1.12 of 3GPP TS 34.121-1, with the primary and the secondary serving HS-DSCH Cell enabled during the power measurement.

A summary of these settings are illustrated below:

HSDPA Setup Configuration:

- a. The EUT was connected to Base Station Agilent E5515C referred to the Setup Configuration.
- b. The RF path losses were compensated into the measurements.
- c. A call was established between EUT and Base Station with following setting:
 - i. Set Gain Factors (β_c and β_d) and parameters were set according to each
 - ii. Specific sub-test in the following table, C10.1.4, quoted from the TS 34.121
 - iii. Set RMC 12.2Kbps + HSDPA mode.
 - iv. Set Cell Power = -86 dBm
 - v. Set HS-DSCH Configuration Type to FRC (H-set 1, QPSK)
 - vi. Select HSDPA Uplink Parameters
 - vii. Set Delta ACK, Delta NACK and Delta CQI = 8
 - viii. Set Ack-Nack Repetition Factor to 3
 - ix. Set CQI Feedback Cycle (k) to 4 ms
 - x. Set CQI Repetition Factor to 2
 - xi. Power Ctrl Mode = All Up bits
- d. The transmitted maximum output power was recorded.

Table C.10.1.4: β values for transmitter characteristics tests with HS-DPCCH

Sub-test	β_c	β_d	β_d (SF)	β_o/β_d	β_{HS} (Note 1, Note 2)	CM (dB) (Note 3)	MPR (dB) (Note 3)
1	2/15	15/15	64	2/15	4/15	0.0	0.0
2	12/15 (Note 4)	15/15 (Note 4)	64	12/15 (Note 4)	24/15	1.0	0.0
3	15/15	8/15	64	15/8	30/15	1.5	0.5
4	15/15	4/15	64	15/4	30/15	1.5	0.5

Note 1: Δ_{ACK} , Δ_{NACK} and $\Delta_{CQI} = 30/15$ with $\beta_{HS} = 30/15 * \beta_c$.

Note 2: For the HS-DPCCH power mask requirement test in clause 5.2C, 5.7A, and the Error Vector Magnitude (EVM) with HS-DPCCH test in clause 5.13.1A, and HSDPA EVM with phase discontinuity in clause 5.13.1AA, Δ_{ACK} and $\Delta_{NACK} = 30/15$ with $\beta_{HS} = 30/15 * \beta_c$, and $\Delta_{CQI} = 24/15$ with $\beta_{HS} = 24/15 * \beta_c$.

Note 3: CM = 1 for $\beta_o/\beta_d = 12/15$, $\beta_{HS}/\beta_c = 24/15$. For all other combinations of DPDCH, DPCCH and HS-DPCCH the MPR is based on the relative CM difference. This is applicable for only UEs that support HSDPA in release 6 and later releases.

Note 4: For subtest 2 the β_o/β_d ratio of 12/15 for the TFC during the measurement period (TF1, TF0) is achieved by setting the signalled gain factors for the reference TFC (TF1, TF1) to $\beta_c = 11/15$ and $\beta_d = 15/15$.

Setup Configuration

HSUPA Setup Configuration:

- a. The EUT was connected to Base Station Agilent E5515C referred to the Setup Configuration.
- b. The RF path losses were compensated into the measurements.
- c. A call was established between EUT and Base Station with following setting * :
 - i. Call Configs = 5.2B, 5.9B, 5.10B, and 5.13.2B with QPSK
 - ii. Set the Gain Factors (β_c and β_d) and parameters (AG Index) were set according to each specific sub-test in the following table, C11.1.3, quoted from the TS 34.121
 - iii. Set Cell Power = -86 dBm
 - iv. Set Channel Type = 12.2k + HSPA
 - v. Set UE Target Power
 - vi. Power Ctrl Mode= Alternating bits
 - vii. Set and observe the E-TFCI
 - viii. Confirm that E-TFCI is equal to the target E-TFCI of 75 for sub-test 1, and other subtest's E-TFCI
- d. The transmitted maximum output power was recorded.

Table C.11.1.3: β values for transmitter characteristics tests with HS-DPCCH and E-DCH

Sub-test	β_c	β_d	β_d (SF)	β_c/β_d	β_{HS} (Note1)	β_{ec}	β_{ed} (Note 4) (Note 5)	β_{ed} (SF)	β_{ed} (Codes)	CM (dB) (Note 2)	MPR (dB) (Note 2) (Note 6)	AG Index (Note 5)	E-TFCI
1	11/15 (Note 3)	15/15 (Note 3)	64	11/15 (Note 3)	22/15	209/25	1309/225	4	1	1.0	0.0	20	75
2	6/15	15/15	64	6/15	12/15	12/15	94/75	4	1	3.0	2.0	12	67
3	15/15	9/15	64	15/9	30/15	30/15	β_{ed1} : 47/15 β_{ed2} : 47/15	4 4	2	2.0	1.0	15	92
4	2/15	15/15	64	2/15	4/15	2/15	56/75	4	1	3.0	2.0	17	71
5	15/15	0	-	-	5/15	5/15	47/15	4	1	1.0	0.0	12	67

Note 1: For sub-test 1 to 4, Δ_{ACK} , Δ_{NACK} and $\Delta_{CQI} = 30/15$ with $\beta_{hs} = 30/15 * \beta_c$. For sub-test 5, Δ_{ACK} , Δ_{NACK} and $\Delta_{CQI} = 5/15$ with $\beta_{hs} = 5/15 * \beta_c$.

Note 2: CM = 1 for $\beta_c/\beta_d = 12/15$, $\beta_{hs}/\beta_c = 24/15$. For all other combinations of DPDCH, DPCCH, HS-DPCCH, E-DPDCH and E-DPCCH the MPR is based on the relative CM difference.

Note 3: For subtest 1 the β_c/β_d ratio of 11/15 for the TFC during the measurement period (TF1, TF0) is achieved by setting the signalled gain factors for the reference TFC (TF1, TF0) to $\beta_c = 10/15$ and $\beta_d = 15/15$.

Note 4: In case of testing by UE using E-DPDCH Physical Layer category 1, Sub-test 3 is omitted according to TS25.306 Table 5.1g.

Note 5: β_{ed} can not be set directly; it is set by Absolute Grant Value.

Note 6: For subtests 2, 3 and 4, UE may perform E-DPDCH power scaling at max power which could results in slightly smaller MPR values.

Setup Configuration

DC-HSDPA 3GPP release 8 Setup Configuration:

- a. The EUT was connected to Base Station referred to the Setup Configuration below
- b. The RF path losses were compensated into the measurements.
- c. A call was established between EUT and Base Station with following setting:
 - i. Set RMC 12.2Kbps + HSDPA mode.
 - ii. Set Cell Power = -25 dBm
 - iii. Set HS-DSCH Configuration Type to FRC (H-set 12, QPSK)
 - iv. Select HSDPA Uplink Parameters
 - v. Set Gain Factors (β_c and β_d) and parameters were set according to each Specific sub-test in the following table, C10.1.4, quoted from the TS 34.121
 - a). Subtest 1: $\beta_c/\beta_d=2/15$
 - b). Subtest 2: $\beta_c/\beta_d=12/15$
 - c). Subtest 3: $\beta_c/\beta_d=15/8$
 - d). Subtest 4: $\beta_c/\beta_d=15/4$
 - vi. Set Delta ACK, Delta NACK and Delta CQI = 8
 - vii. Set Ack-Nack Repetition Factor to 3
 - viii. Set CQI Feedback Cycle (k) to 4 ms
 - ix. Set CQI Repetition Factor to 2
 - x. Power Ctrl Mode = All Up bits
- d. The transmitted maximum output power was recorded.

The following tests were conducted according to the test requirements outlines in 3GPP TS 34.121 specification. A summary of these settings are illustrated below:

C.8.1.12 Fixed Reference Channel Definition H-Set 12

Table C.8.1.12: Fixed Reference Channel H-Set 12

Parameter	Unit	Value
Nominal Avg. Inf. Bit Rate	kbps	60
Inter-TTI Distance	TTI's	1
Number of HARQ Processes	Processes	6
Information Bit Payload (N_{INF})	Bits	120
Number Code Blocks	Blocks	1
Binary Channel Bits Per TTI	Bits	960
Total Available SML's in UE	SML's	19200
Number of SML's per HARQ Proc.	SML's	3200
Coding Rate		0.15
Number of Physical Channel Codes	Codes	1
Modulation		QPSK
Note 1: The RMC is intended to be used for DC-HSDPA mode and both cells shall transmit with identical parameters as listed in the table. Note 2: Maximum number of transmission is limited to 1, i.e., retransmission is not allowed. The redundancy and constellation version 0 shall be used.		

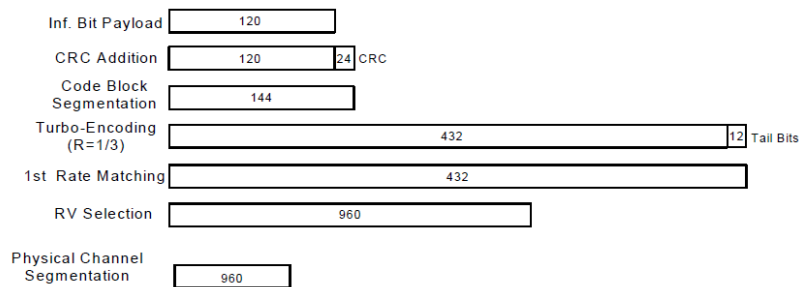

Figure C.8.19: Coding rate for Fixed reference Channel H-Set 12 (QPSK)

Setup Configuration



<WCDMA Conducted Power>

General Note:

1. Per KDB 941225 D01v03r01, for SAR testing is measured using a 12.2 kbps RMC with TPC bits configured to all "1's".
2. Per KDB 941225 D01v03r01, RMC 12.2kbps setting is used to evaluate SAR. The maximum output power and tune-up tolerance specified for production units in HSDPA / HSUPA / DC-HSDPA is $\leq \frac{1}{4}$ dB higher than RMC 12.2Kbps or when the highest reported SAR of the RMC12.2Kbps is scaled by the ratio of specified maximum output power and tune-up tolerance of HSDPA / HSUPA / DC-HSDPA to RMC12.2Kbps and the adjusted SAR is ≤ 1.2 W/kg, SAR measurement is not required for HSDPA / HSUPA / DC-HSDPA, and according to the following RF output power, the output power results of the secondary modes (HSDPA / HSUPA / DC-HSDPA) are less than $\frac{1}{4}$ dB higher than the primary modes; therefore, SAR measurement is not required for HSDPA / HSUPA / DC-HSDPA

<LTE Conducted Power>

General Note:

1. Anritsu MT8820C base station simulator was used to setup the connection with EUT; the frequency band, channel bandwidth, RB allocation configuration, modulation type are set in the base station simulator to configure EUT transmitting at maximum power and at different configurations which are requested to be reported to FCC, for conducted power measurement and SAR testing.
2. Per KDB 941225 D05v02r05, when a properly configured base station simulator is used for the SAR and power measurements, spectrum plots for each RB allocation and offset configuration is not required.
3. Per KDB 941225 D05v02r05, start with the largest channel bandwidth and measure SAR for QPSK with 1 RB allocation, using the RB offset and required test channel combination with the highest maximum output power for RB offsets at the upper edge, middle and lower edge of each required test channel.
4. Per KDB 941225 D05v02r05, 50% RB allocation for QPSK SAR testing follows 1RB QPSK allocation procedure.
5. Per KDB 941225 D05v02r05, for QPSK with 100% RB allocation, SAR is not required when the highest maximum output power for 100 % RB allocation is less than the highest maximum output power in 50% and 1 RB allocations and the highest reported SAR for 1 RB and 50% RB allocation are ≤ 0.8 W/kg. Otherwise, SAR is measured for the highest output power channel; and if the reported SAR is > 1.45 W/kg, the remaining required test channels must also be tested.
6. Per KDB 941225 D05v02r05, 16QAM/64QAM output power for each RB allocation configuration is $>$ not $\frac{1}{2}$ dB higher than the same configuration in QPSK and the reported SAR for the QPSK configuration is ≤ 1.45 W/kg; Per KDB 941225 D05v02r05, 16QAM/64QAM SAR testing is not required.
7. Per KDB 941225 D05v02r05, smaller bandwidth output power for each RB allocation configuration is $>$ not $\frac{1}{2}$ dB higher than the same configuration in the largest supported bandwidth, and the reported SAR for the largest supported bandwidth is ≤ 1.45 W/kg; Per KDB 941225 D05v02r05, smaller bandwidth SAR testing is not required.
8. For LTE B4 / B5 / B12 / B17 / B26 / B38 the maximum bandwidth does not support three non-overlapping channels, per KDB 941225 D05v02r05, when a device supports overlapping channel assignment in a channel bandwidth configuration, the middle channel of the group of overlapping channels should be selected for testing.
9. LTE B5 / B17 SAR test was covered by B26 / B12; according to April 2015 TCB workshop, SAR test for overlapping LTE bands can be reduced if
 - a. the maximum output power, including tolerance, for the smaller band is \leq the larger band to qualify for the SAR test exclusion
 - b. the channel bandwidth and other operating parameters for the smaller band are fully supported by the larger band
10. According to 2017 TCB workshop, for 64 QAM and 16 QAM should be verified by checking the signal constellation with a call box to avoid incorrect maximum power levels due to MPR and other requirements associated with signal modulation, and the following figure is taken from the "Fundamental Measurement >> Modulation Analysis >> constellation" mode of the device connect to the MT8821C base station, therefore, the device 64QAM and 16QAM signal modulation are correct.

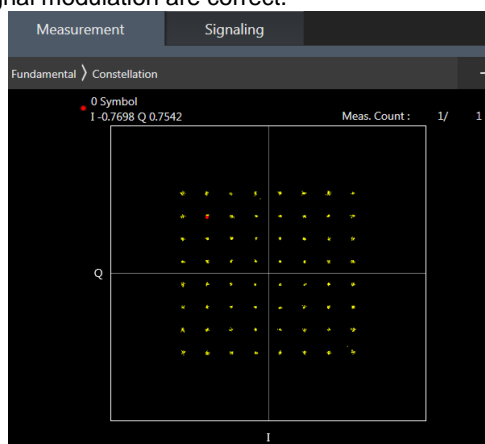

64QAM

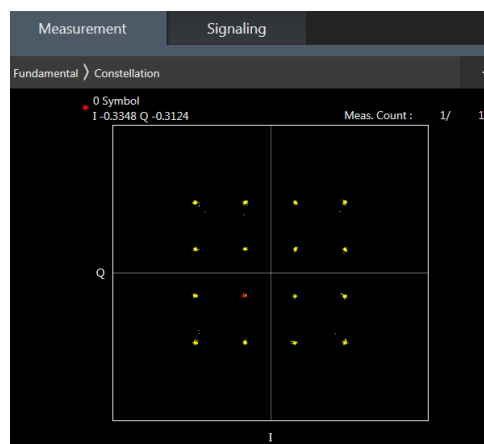

16QAM

<TDD LTE SAR Measurement>

TDD LTE configuration setup for SAR measurement

SAR was tested with a fixed periodic duty factor according to the highest transmission duty factor implemented for the device and supported by 3GPP.

- a. 3GPP TS 36.211 section 4.2 for Type 2 Frame Structure and Table 4.2-2 for uplink-downlink configurations
- b. "special subframe S" contains both uplink and downlink transmissions, it has been taken into consideration to determine the transmission duty factor according to the worst case uplink and downlink cyclic prefix requirements for UpPTS
- c. Establishing connections with base station simulators ensure a consistent means for testing SAR and recommended for evaluating SAR. The Anritsu MT8820C (firmware: #22.52#004) was used for LTE output power measurements and SAR testing.

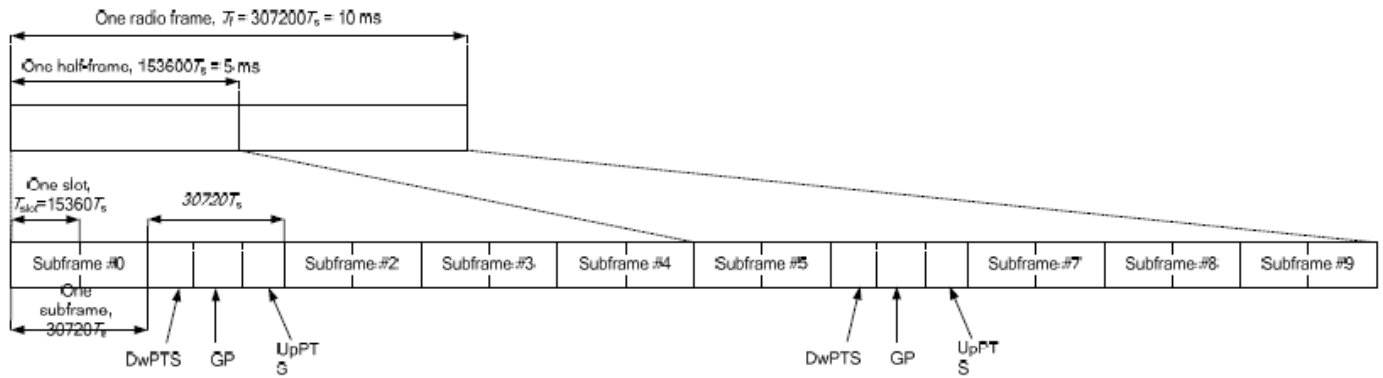

Figure 4.2-1: Frame structure type 2 (for 5 ms switch-point periodicity).

Table 4.2-2: Uplink-downlink configurations.

Uplink-downlink configuration	Downlink-to-Uplink Switch-point periodicity	Subframe number									
		0	1	2	3	4	5	6	7	8	9
0	5 ms	D	S	U	U	U	D	S	U	U	U
1	5 ms	D	S	U	U	D	D	S	U	U	D
2	5 ms	D	S	U	D	D	D	S	U	D	D
3	10 ms	D	S	U	U	U	D	D	D	D	D
4	10 ms	D	S	U	U	D	D	D	D	D	D
5	10 ms	D	S	U	D	D	D	D	D	D	D
6	5 ms	D	S	U	U	U	D	S	U	U	D

Table 4.2-1: Configuration of special subframe (lengths of DwPTS/GP/UpPTS).

Special subframe configuration	Normal cyclic prefix in downlink			Extended cyclic prefix in downlink		
	DwPTS	UpPTS		DwPTS	UpPTS	
		Normal cyclic prefix in uplink	Extended cyclic prefix in uplink		Normal cyclic prefix in uplink	Extended cyclic prefix in uplink
0	$6592 \cdot T_s$	$2192 \cdot T_s$	$2560 \cdot T_s$	$7680 \cdot T_s$	$2192 \cdot T_s$	$2560 \cdot T_s$
1	$19760 \cdot T_s$			$20480 \cdot T_s$		
2	$21952 \cdot T_s$			$23040 \cdot T_s$		
3	$24144 \cdot T_s$			$25600 \cdot T_s$		
4	$26336 \cdot T_s$	$4384 \cdot T_s$	$5120 \cdot T_s$	$7680 \cdot T_s$	$4384 \cdot T_s$	$5120 \cdot T_s$
5	$6592 \cdot T_s$			$20480 \cdot T_s$		
6	$19760 \cdot T_s$			$23040 \cdot T_s$		
7	$21952 \cdot T_s$			$12800 \cdot T_s$		
8	$24144 \cdot T_s$	-	-	-	-	-
9	$13168 \cdot T_s$	-	-	-	-	-

Special subframe (30720·T _s): Normal cyclic prefix in downlink (UpPTS)			
	Special subframe configuration	Normal cyclic prefix in uplink	Extended cyclic prefix in uplink
Uplink duty factor in one special subframe	0~4	7.13%	8.33%
	5~9	14.3%	16.7%

Special subframe(30720·T _s): Extended cyclic prefix in downlink (UpPTS)			
	Special subframe configuration	Normal cyclic prefix in uplink	Extended cyclic prefix in uplink
Uplink duty factor in one special subframe	0~3	7.13%	8.33%
	4~7	14.3%	16.7%

The highest duty factor is resulted from:

- i. Uplink-downlink configuration: 0. In a half-frame consisted of 5 subframes, uplink operation is in 3 uplink subframes and 1 special subframe.
- ii. special subframe configuration: 5-9 for normal cyclic prefix in downlink, 4-7 for extended cyclic prefix in downlink
- iii. for special subframe with extended cyclic prefix in uplink, the total uplink duty factor in one half-frame is: $(3+0.167)/5 = 63.3\%$
- iv. for special subframe with normal cyclic prefix in uplink, the total uplink duty factor in one half-frame is: $(3+0.143)/5 = 62.9\%$
- v. For TDD LTE SAR measurement, the duty cycle 1:1.59 (62.9 %) was used perform testing and considering the theoretical duty cycle of 63.3% for extended cyclic prefix in the uplink, and the theoretical duty cycle of 62.9% for normal cyclic prefix in uplink, a scaling factor of extended cyclic prefix $63.3\%/62.9\% = 1.006$ is applied to scale-up the measured SAR result. The scaled TDD LTE SAR = measured SAR (W/kg)* Tune-up Scaling Factor* scaling factor for extended cyclic prefix.



<LTE Carrier Aggregation>

General Note:

- 1. This device supports Carrier Aggregation on downlink for intra band. For the device supports bands and bandwidths and configurations are provided as follow table was according to 3GPP.
- 2. In applying the existing power measurement procedures of KDB 941225 D05A for DL CA SAR test exclusion, only the subset with the largest number of combinations of frequency bands and CCs in each row need combination, and for this device that all the configurations were choose to power measurement.
- 3. The gray color table is covered by other combinations and no need to verify power.

2CC Downlink Carrier Aggregation		
Number	Combination	Covered by Measurement Superset
2CC #1	CA_7C	
2CC #2	CA_38C	

LTE Carrier Aggregation Conducted Power (Downlink)

- i. According to KDB941225 D05A v01r02, Uplink maximum output power measurement with downlink carrier aggregation active should be measured, using the highest output channel measured without downlink carrier aggregation, to confirm that uplink maximum output power with downlink carrier aggregation active remains within the specified tune-up tolerance limits and not more than ¼ dB higher than the maximum output measured without downlink carrier aggregation active.
- ii. Uplink maximum output power with downlink carrier aggregation active does not show more than ¼ dB higher than the maximum output power without downlink carrier aggregation active, therefore SAR evaluation with downlink carrier aggregation active can be excluded.
- iii. The device supports downlink two carrier aggregation. For power measurement were control and acknowledge data is sent on uplink channels that operate identical to specifications when downlink carrier aggregation is inactive.
- iv. Selected highest measured power when downlink carrier aggregation is inactive for conducted power comparison with downlink carrier aggregation is active, to confirm that when downlink carrier aggregation is active uplink maximum output power remains within the specified tune-up tolerance limits and not more than ¼ dB higher than the maximum output power measured when downlink carrier aggregation inactive.
- v. For Intra-band, contiguous CA, the downlink channels selected to perform the uplink power measurement must satisfy 3GPP channel spacing (5.4.1A of 3GPP TS 36.521 or equivalent) and channel bandwidth (5.4.2A) requirements.

$$\text{Nominal channel spacing} = \left\lceil \frac{BW_{\text{Channel}(1)} + BW_{\text{Channel}(2)} - 0.1|BW_{\text{Channel}(1)} - BW_{\text{Channel}(2)}|}{0.6} \right\rceil 0.3 \text{ [MHz]}$$

LTE Carrier Aggregation Conducted Power (Uplink)

1. This device supports uplink carrier aggregation for LTE CA_7C, LTE CA_38C with a maximum of two 20MHz component carriers. For intra band contiguous carrier aggregation scenarios, 3GPP 36.101 Table 6.2.2A-1 specifies that the aggregate maximum allowed output power is equivalent to the single carrier scenario. For the non-contiguously allocated resource blocks which the MPR level is determined by various RB separation and RB sizes requirement, and the allowed MPR levels, settings and the conducted powers are permanently implemented in this device per the 3GPP 36.36.101 section 6.2.3A.1.3 requirements.
2. According to FCC guidance, the output power with uplink CA active was measured for the high / middle / low channel configuration with the highest reported SAR for each exposure condition, the power was measured with wideband signal integration over both component carriers.
3. In applying the power measurement procedures of KDB 941225 D05A for DL CA to qualify for UL SAR test exclusion, power measurement is required only for the subset in each row with the largest combination of frequency bands and CCs
4. Maximum output power measurement is required for each UL CA configuration for the required test channels described in KDB 941225 D05. The required test channel should be associated with the UL PCC. For channels at the ends of a frequency band, the SCC and subsequent CCs are added to the side within the transmission band. Otherwise, the CCs should be added alternatively to either side of the PCC.



<WLAN Conducted Power>

General Note:

1. Per KDB 248227 D01v02r02, SAR test reduction is determined according to 802.11 transmission mode configurations and certain exposure conditions with multiple test positions. In the 2.4 GHz band, separate SAR procedures are applied to DSSS and OFDM configurations to simplify DSSS test requirements. For OFDM, in both 2.4 and 5 GHz bands, an initial test configuration must be determined for each standalone and aggregated frequency band, according to the transmission mode configuration with the highest maximum output power specified for production units to perform SAR measurements. If the same highest maximum output power applies to different combinations of channel bandwidths, modulations and data rates, additional procedures are applied to determine which test configurations require SAR measurement. When applicable, an initial test position may be applied to reduce the number of SAR measurements required for next to the ear, UMPC mini-tablet or hotspot mode configurations with multiple test positions.
2. For 2.4 GHz 802.11b DSSS, either the initial test position procedure for multiple exposure test positions or the DSSS procedure for fixed exposure position is applied; these are mutually exclusive. For 2.4 GHz and 5 GHz OFDM configurations, the initial test configuration is applied to measure SAR using either the initial test position procedure for multiple exposure test position configurations or the initial test configuration procedures for fixed exposure test conditions. Based on the reported SAR of the measured configurations and maximum output power of the transmission mode configurations that are not included in the initial test configuration, the subsequent test configuration and initial test position procedures are applied to determine if SAR measurements are required for the remaining OFDM transmission configurations. In general, the number of test channels that require SAR measurement is minimized based on maximum output power measured for the test sample(s).
3. For OFDM transmission configurations in the 2.4 GHz and 5 GHz bands, When the same maximum power is specified for multiple transmission modes in a frequency band, the largest channel bandwidth, lowest order modulation, lowest data rate and lowest order 802.11a/g/n/ac mode is used for SAR measurement, on the highest measured output power channel for each frequency band.
4. DSSS and OFDM configurations are considered separately according to the required SAR procedures. SAR is measured in the initial test position using the 802.11 transmission mode configuration required by the DSSS procedure or initial test configuration and subsequent test configuration(s) according to the OFDM procedures.18 The initial test position procedure is described in the following:
 - a. When the reported SAR of the initial test position is ≤ 0.4 W/kg, further SAR measurement is not required for the other test positions in that exposure configuration and 802.11 transmission mode combinations within the frequency band or aggregated band.
 - b. When the reported SAR of the test position is > 0.4 W/kg, SAR is repeated for the 802.11 transmission mode configuration tested in the initial test position to measure the subsequent next closet/smallest test separation distance and maximum coupling test position on the highest maximum output power channel, until the report SAR is ≤ 0.8 W/kg or all required test position are tested.
 - c. For all positions/configurations, when the reported SAR is > 0.8 W/kg, SAR is measured for these test positions/configurations on the subsequent next highest measured output power channel(s) until the reported SAR is ≤ 1.2 W/kg or all required channels are tested.



<2.4GHz Bluetooth>

General Note:

1. For 2.4GHz Bluetooth SAR testing was selected 1Mbps, due to its highest average power.
2. The Bluetooth duty cycle is 76.63 % as following figure, according to 2016 Oct. TCB workshop for Bluetooth SAR scaling need further consideration and the maximum duty cycle is 100%, therefore the actual duty cycle will be scaled up to100% for Bluetooth reported SAR calculation

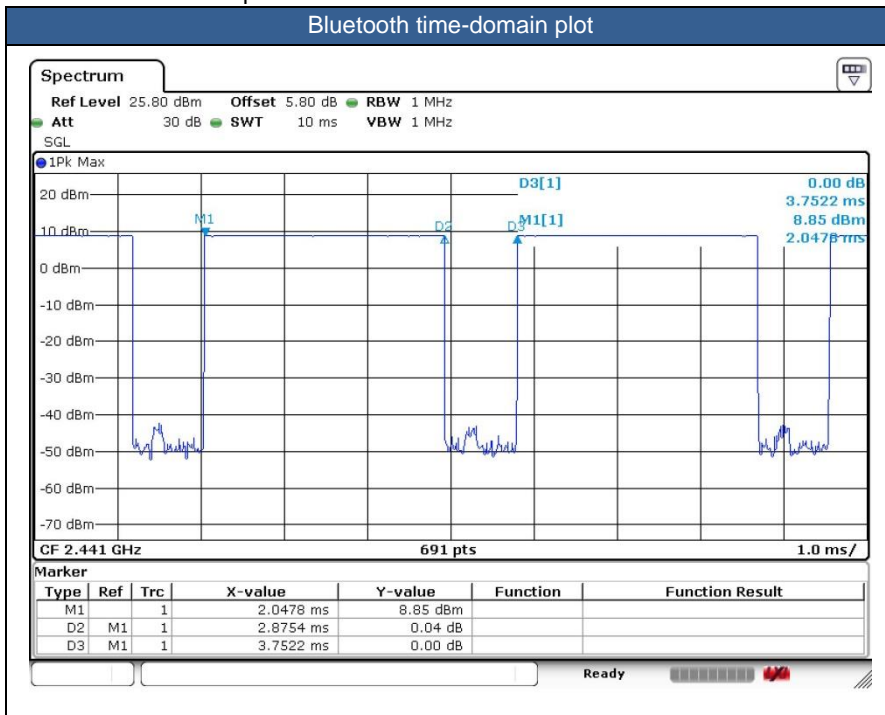



14. Antenna Location

The detailed antenna location information can refer to SAR Test Setup Photos.

15. SAR Test Results

General Note:

1. Per KDB 447498 D01v06, the reported SAR is the measured SAR value adjusted for maximum tune-up tolerance.
 - a. Tune-up scaling Factor = tune-up limit power (mW) / EUT RF power (mW), where tune-up limit is the maximum rated power among all production units.
 - b. For SAR testing of WLAN signal with non-100% duty cycle, the measured SAR is scaled-up by the duty cycle scaling factor which is equal to "1/(duty cycle)"
 - c. For WWAN: Reported SAR(W/kg)= Measured SAR(W/kg)*Tune-up Scaling Factor
 - d. For BT/WLAN: Reported SAR(W/kg)= Measured SAR(W/kg)* Duty Cycle scaling factor * Tune-up scaling factor
 - e. For TDD LTE SAR measurement, the duty cycle 1:1.59 (62.9 %) was used perform testing and considering the theoretical duty cycle of 63.3% for extended cyclic prefix in the uplink, and the theoretical duty cycle of 62.9% for normal cyclic prefix in uplink, a scaling factor of extended cyclic prefix $63.3\%/62.9\% = 1.006$ is applied to scale-up the measured SAR result. The Reported TDD LTE SAR = measured SAR (W/kg)* Tune-up Scaling Factor* scaling factor for extended cyclic prefix.
2. Per KDB 447498 D01v06, for each exposure position, testing of other required channels within the operating mode of a frequency band is not required when the *reported* 1-g or 10-g SAR for the mid-band or highest output power channel is:
 - ≤ 0.8 W/kg or 2.0 W/kg, for 1-g or 10-g respectively, when the transmission band is ≤ 100 MHz
 - ≤ 0.6 W/kg or 1.5 W/kg, for 1-g or 10-g respectively, when the transmission band is between 100 MHz and 200 MHz
 - ≤ 0.4 W/kg or 1.0 W/kg, for 1-g or 10-g respectively, when the transmission band is ≥ 200 MHz
3. Per KDB 865664 D01v01r04, for each frequency band, repeated SAR measurement is required when the measured SAR is ≥ 0.8 W/kg. Per KDB 865664 D01v01r04, if the extremity repeated SAR is necessary, the same procedures should be adapted for measurements according to extremity and occupational exposure limits by applying a factor of 2.5 for extremity exposure and a factor of 5 for occupational exposure to the corresponding SAR thresholds.
4. The device implements Proximity sensors/receiver detect mechanism reduced power for the power management for SAR compliance at different exposure conditions (head, body-worn, hotspot, extremity). The device will invoke corresponding work scenarios power level base on frequency bands/antennas, which can refer to appendix E. power table. (DSI 1: receiver on head power; DSI 3/4: P-sensor on for hotspot/body-worn; DSI 2: receiver off /P-sensor off for hotspot/body-worn).
5. Per KDB648474 D04v01r03, for smart phones with a display diagonal dimension > 15 cm or an overall diagonal dimension > 16 cm, when hotspot mode applies, 10-g product specific SAR is required only for the surfaces and edges with hotspot mode 1-g reported SAR > 1.2 W/kg, in this report all the hotspot mode results are < 1.2 W/kg.
6. For 5.3GHz / 5.5GHz WLAN product specific SAR is necessary too, due to an overall diagonal dimension is > 16 cm.

GSM Note:

1. Per KDB 941225 D01v03r01, for SAR test reduction for GSM / GPRS / EDGE modes is determined by the source-based time-averaged output power including tune-up tolerance. The mode with highest specified time-averaged output power should be tested for SAR compliance in the applicable exposure conditions. For modes with the same specified maximum output power and tolerance, the higher number time-slot configuration should be tested. Therefore, the GPRS 4Tx slots for GSM850/GSM1900 are considered as the primary mode.
2. Other configurations of GSM / GPRS / EDGE are considered as secondary modes. The 3G SAR test reduction procedure is applied, when the maximum output power and tune-up tolerance specified for production units in a secondary mode is \leq ¼ dB higher than the primary mode, SAR measurement is not required for the secondary mode.

WCDMA Note:

1. Per KDB 941225 D01v03r01, for SAR testing is measured using a 12.2 kbps RMC with TPC bits configured to all "1's".
2. Per KDB 941225 D01v03r01, RMC 12.2kbps setting is used to evaluate SAR. The maximum output power and tune-up tolerance specified for production units in HSDPA / HSUPA / DC-HSDPA is \leq ¼ dB higher than RMC 12.2Kbps or when the highest reported SAR of the RMC12.2Kbps is scaled by the ratio of specified maximum output power and tune-up tolerance of HSDPA / HSUPA / DC-HSDPA to RMC12.2Kbps and the adjusted SAR is \leq 1.2 W/kg, SAR measurement is not required for HSDPA / HSUPA / DC-HSDPA, and according to the following RF output power, the output power results of the secondary modes (HSDPA / HSUPA / DC-HSDPA) are less than ¼ dB higher than the primary modes; therefore, SAR measurement is not required for HSDPA / HSUPA / DC-HSDPA.

LTE Note:

1. Per KDB 941225 D05v02r05, start with the largest channel bandwidth and measure SAR for QPSK with 1 RB allocation, using the RB offset and required test channel combination with the highest maximum output power for RB offsets at the upper edge, middle and lower edge of each required test channel.
2. Per KDB 941225 D05v02r05, 50% RB allocation for QPSK SAR testing follows 1RB QPSK allocation procedure.
3. Per KDB 941225 D05v02r05, for QPSK with 100% RB allocation, SAR is not required when the highest maximum output power for 100 % RB allocation is less than the highest maximum output power in 50% and 1 RB allocations and the highest reported SAR for 1 RB and 50% RB allocation are \leq 0.8 W/kg. Otherwise, SAR is measured for the highest output power channel; and if the reported SAR is $>$ 1.45 W/kg, the remaining required test channels must also be tested.
4. Per KDB 941225 D05v02r05, 16QAM/64QAM output power for each RB allocation configuration is $>$ not ½ dB higher than the same configuration in QPSK and the reported SAR for the QPSK configuration is \leq 1.45 W/kg; Per KDB 941225 D05v02r05, 16QAM/64QAM SAR testing is not required.
5. Per KDB 941225 D05v02r05, smaller bandwidth output power for each RB allocation configuration is $>$ not ½ dB higher than the same configuration in the largest supported bandwidth, and the reported SAR for the largest supported bandwidth is \leq 1.45 W/kg; Per KDB 941225 D05v02r05, smaller bandwidth SAR testing is not required.
6. For LTE B4 / B5 / B12 / B17/ B26 / B38 the maximum bandwidth does not support three non-overlapping channels, per KDB 941225 D05v02r05, when a device supports overlapping channel assignment in a channel bandwidth configuration, the middle channel of the group of overlapping channels should be selected for testing.
7. LTE B5 / B17 SAR test was covered by LTE B26 / B12; according to April 2015 TCB workshop, SAR test for overlapping LTE bands can be reduced if
 - a. the maximum output power, including tolerance, for the smaller band is \leq the larger band to qualify for the SAR test exclusion
 - b. the channel bandwidth and other operating parameters for the smaller band are fully supported by the larger band



WLAN/Bluetooth Note:

1. Per KDB 248227 D01v02r02, for 2.4GHz 802.11g/n SAR testing is not required when the highest reported SAR for DSSS is adjusted by the ratio of OFDM to DSSS specified maximum output power and the adjusted SAR is ≤ 1.2 W/kg.
2. Per KDB 248227 D01v02r02, U-NII-1 SAR testing is not required when the U-NII-2A band highest reported SAR for a test configuration is ≤ 1.2 W/kg, SAR is not required for U-NII-1 band.
3. When the reported SAR of the test position is > 0.4 W/kg, SAR is repeated for the 802.11 transmission mode configuration tested in the initial test position to measure the subsequent next closet/smallest test separation distance and maximum coupling test position on the highest maximum output power channel, until the report SAR is ≤ 0.8 W/kg or all required test position are tested.
4. For all positions / configurations, when the reported SAR is > 0.8 W/kg, SAR is measured for these test positions / configurations on the subsequent next highest measured output power channel(s) until the reported SAR is ≤ 1.2 W/kg or all required channels are tested.
5. During SAR testing the WLAN transmission was verified using a spectrum analyzer.



15.1 Head SAR

<GSM SAR>

Plot No.	Band	Mode	Test Position	Gap (mm)	Antenna	Power State	Ch.	Freq. (MHz)	Average Power (dBm)	Tune-Up Limit (dBm)	Tune-up Scaling Factor	Power Drift (dB)	Measured 1g SAR (W/kg)	Reported 1g SAR (W/kg)
	GSM850	GPRS (4 Tx slots)	Right Cheek	0mm	Ant 1	DSI 1	189	836.4	26.96	28.00	1.271	-0.01	0.227	0.288
	GSM850	GPRS (4 Tx slots)	Right Tilted	0mm	Ant 1	DSI 1	189	836.4	26.96	28.00	1.271	0.06	0.122	0.155
	GSM850	GPRS (4 Tx slots)	Left Cheek	0mm	Ant 1	DSI 1	189	836.4	26.96	28.00	1.271	0.13	0.152	0.193
	GSM850	GPRS (4 Tx slots)	Left Tilted	0mm	Ant 1	DSI 1	189	836.4	26.96	28.00	1.271	-0.17	0.103	0.131
	GSM850	GPRS (4 Tx slots)	Right Cheek	0mm	Ant 4	DSI 1	189	836.4	27.22	28.00	1.197	-0.12	0.739	0.884
01	GSM850	GPRS (4 Tx slots)	Right Cheek	0mm	Ant 4	DSI 1	128	824.2	27.16	28.00	1.213	-0.07	0.871	1.057
	GSM850	GPRS (4 Tx slots)	Right Cheek	0mm	Ant 4	DSI 1	251	848.8	27.14	28.00	1.219	-0.15	0.748	0.912
	GSM850	GPRS (4 Tx slots)	Right Tilted	0mm	Ant 4	DSI 1	189	836.4	27.22	28.00	1.197	-0.14	0.557	0.667
	GSM850	GPRS (4 Tx slots)	Left Cheek	0mm	Ant 4	DSI 1	189	836.4	27.22	28.00	1.197	0.03	0.623	0.746
	GSM850	GPRS (4 Tx slots)	Left Tilted	0mm	Ant 4	DSI 1	189	836.4	27.22	28.00	1.197	0.09	0.553	0.662
	GSM1900	GPRS (4 Tx slots)	Right Cheek	0mm	Ant 1	DSI 1	661	1880	24.33	25.00	1.167	0.03	0.036	0.042
	GSM1900	GPRS (4 Tx slots)	Right Tilted	0mm	Ant 1	DSI 1	661	1880	24.33	25.00	1.167	0.08	0.021	0.025
	GSM1900	GPRS (4 Tx slots)	Left Cheek	0mm	Ant 1	DSI 1	661	1880	24.33	25.00	1.167	0.04	0.036	0.042
	GSM1900	GPRS (4 Tx slots)	Left Tilted	0mm	Ant 1	DSI 1	661	1880	24.33	25.00	1.167	0.05	0.023	0.027
	GSM1900	GPRS (4 Tx slots)	Right Cheek	0mm	Ant 4	DSI 1	661	1880	19.35	20.00	1.161	-0.07	0.439	0.510
	GSM1900	GPRS (4 Tx slots)	Right Tilted	0mm	Ant 4	DSI 1	661	1880	19.35	20.00	1.161	0.07	0.597	0.693
	GSM1900	GPRS (4 Tx slots)	Left Cheek	0mm	Ant 4	DSI 1	661	1880	19.35	20.00	1.161	-0.09	0.576	0.669
02	GSM1900	GPRS (4 Tx slots)	Left Tilted	0mm	Ant 4	DSI 1	661	1880	19.35	20.00	1.161	0.05	0.674	0.783

<WCDMA SAR>

Plot No.	Band	Mode	Test Position	Gap (mm)	Antenna	Power State	Ch.	Freq. (MHz)	Average Power (dBm)	Tune-Up Limit (dBm)	Tune-up Scaling Factor	Power Drift (dB)	Measured 1g SAR (W/kg)	Reported 1g SAR (W/kg)
	WCDMA II	RMC 12.2Kbps	Right Cheek	0mm	Ant 1	DSI 1	9400	1880	24.55	25.50	1.245	-0.06	0.040	0.050
	WCDMA II	RMC 12.2Kbps	Right Tilted	0mm	Ant 1	DSI 1	9400	1880	24.55	25.50	1.245	0.06	0.038	0.047
	WCDMA II	RMC 12.2Kbps	Left Cheek	0mm	Ant 1	DSI 1	9400	1880	24.55	25.50	1.245	-0.05	0.101	0.126
	WCDMA II	RMC 12.2Kbps	Left Tilted	0mm	Ant 1	DSI 1	9400	1880	24.55	25.50	1.245	-0.18	0.000	0.000
	WCDMA II	RMC 12.2Kbps	Right Cheek	0mm	Ant 4	DSI 1	9400	1880	16.70	17.50	1.202	0.06	0.460	0.553
	WCDMA II	RMC 12.2Kbps	Right Tilted	0mm	Ant 4	DSI 1	9400	1880	16.70	17.50	1.202	0.08	0.588	0.707
	WCDMA II	RMC 12.2Kbps	Left Cheek	0mm	Ant 4	DSI 1	9400	1880	16.70	17.50	1.202	0.18	0.540	0.649
	WCDMA II	RMC 12.2Kbps	Left Tilted	0mm	Ant 4	DSI 1	9400	1880	16.70	17.50	1.202	0.02	0.685	0.824
03	WCDMA II	RMC 12.2Kbps	Left Tilted	0mm	Ant 4	DSI 1	9262	1852.4	16.49	17.50	1.262	0.02	0.729	0.920
	WCDMA II	RMC 12.2Kbps	Left Tilted	0mm	Ant 4	DSI 1	9538	1907.6	16.61	17.50	1.227	0.02	0.703	0.863
	WCDMA IV	RMC 12.2Kbps	Right Cheek	0mm	Ant 1	DSI 1	1413	1732.6	24.68	25.50	1.208	-0.07	0.000	0.000
	WCDMA IV	RMC 12.2Kbps	Right Tilted	0mm	Ant 1	DSI 1	1413	1732.6	24.68	25.50	1.208	0.08	0.000	0.000
	WCDMA IV	RMC 12.2Kbps	Left Cheek	0mm	Ant 1	DSI 1	1413	1732.6	24.68	25.50	1.208	-0.02	0.039	0.047
	WCDMA IV	RMC 12.2Kbps	Left Tilted	0mm	Ant 1	DSI 1	1413	1732.6	24.68	25.50	1.208	0.02	0.000	0.000
	WCDMA IV	RMC 12.2Kbps	Right Cheek	0mm	Ant 4	DSI 1	1413	1732.6	16.88	17.50	1.153	0.03	0.478	0.551
	WCDMA IV	RMC 12.2Kbps	Right Tilted	0mm	Ant 4	DSI 1	1413	1732.6	16.88	17.50	1.153	0.13	0.625	0.721
	WCDMA IV	RMC 12.2Kbps	Left Cheek	0mm	Ant 4	DSI 1	1413	1732.6	16.88	17.50	1.153	0.12	0.549	0.633
	WCDMA IV	RMC 12.2Kbps	Left Tilted	0mm	Ant 4	DSI 1	1413	1732.6	16.88	17.50	1.153	0.13	0.694	0.800
	WCDMA IV	RMC 12.2Kbps	Left Tilted	0mm	Ant 4	DSI 1	1312	1712.4	16.87	17.50	1.156	0.05	0.591	0.683
04	WCDMA IV	RMC 12.2Kbps	Left Tilted	0mm	Ant 4	DSI 1	1513	1752.6	16.87	17.50	1.156	-0.01	0.694	0.802
	WCDMA V	RMC 12.2Kbps	Right Cheek	0mm	Ant 1	DSI 1	4182	836.4	24.85	25.50	1.161	-0.04	0.151	0.175
	WCDMA V	RMC 12.2Kbps	Right Tilted	0mm	Ant 1	DSI 1	4182	836.4	24.85	25.50	1.161	0.11	0.086	0.100
	WCDMA V	RMC 12.2Kbps	Left Cheek	0mm	Ant 1	DSI 1	4182	836.4	24.85	25.50	1.161	0.01	0.000	0.000
	WCDMA V	RMC 12.2Kbps	Left Tilted	0mm	Ant 1	DSI 1	4182	836.4	24.85	25.50	1.161	0.18	0.000	0.000
	WCDMA V	RMC 12.2Kbps	Right Cheek	0mm	Ant 4	DSI 1	4182	836.4	22.27	23.00	1.183	0.02	0.647	0.765
	WCDMA V	RMC 12.2Kbps	Right Tilted	0mm	Ant 4	DSI 1	4182	836.4	22.27	23.00	1.183	0.19	0.547	0.647
05	WCDMA V	RMC 12.2Kbps	Left Cheek	0mm	Ant 4	DSI 1	4182	836.4	22.27	23.00	1.183	-0.1	0.674	0.797
	WCDMA V	RMC 12.2Kbps	Left Tilted	0mm	Ant 4	DSI 1	4182	836.4	22.27	23.00	1.183	0.14	0.610	0.722



<FDD LTE SAR>

Plot No.	Band	BW (MHz)	Modulation	RB Size	RB offset	Test Position	Gap (mm)	Antenna	Power State	Ch.	Freq. (MHz)	Average Power (dBm)	Tune-Up Limit (dBm)	Tune-up Scaling Factor	Power Drift (dB)	Measured 1g SAR (W/kg)	Reported 1g SAR (W/kg)
	LTE Band 4	20M	QPSK	1	0	Right Cheek	0mm	Ant 1	DSI 1	20175	1732.5	24.97	25.50	1.130	0.05	0.054	0.061
	LTE Band 4	20M	QPSK	50	0	Right Cheek	0mm	Ant 1	DSI 1	20175	1732.5	23.94	24.50	1.138	0.04	0.044	0.050
	LTE Band 4	20M	QPSK	1	0	Right Tilted	0mm	Ant 1	DSI 1	20175	1732.5	24.97	25.50	1.130	-0.09	0.027	0.031
	LTE Band 4	20M	QPSK	50	0	Right Tilted	0mm	Ant 1	DSI 1	20175	1732.5	23.94	24.50	1.138	0.08	0.030	0.034
	LTE Band 4	20M	QPSK	1	0	Left Cheek	0mm	Ant 1	DSI 1	20175	1732.5	24.97	25.50	1.130	0.09	0.031	0.035
	LTE Band 4	20M	QPSK	50	0	Left Cheek	0mm	Ant 1	DSI 1	20175	1732.5	23.94	24.50	1.138	0.05	0.033	0.038
	LTE Band 4	20M	QPSK	1	0	Left Tilted	0mm	Ant 1	DSI 1	20175	1732.5	24.97	25.50	1.130	-0.07	0.024	0.027
	LTE Band 4	20M	QPSK	50	0	Left Tilted	0mm	Ant 1	DSI 1	20175	1732.5	23.94	24.50	1.138	0.04	0.020	0.023
	LTE Band 4	20M	QPSK	1	0	Right Cheek	0mm	Ant 4	DSI 1	20175	1732.5	17.52	18.50	1.253	-0.09	0.431	0.540
	LTE Band 4	20M	QPSK	50	0	Right Cheek	0mm	Ant 4	DSI 1	20175	1732.5	17.50	18.50	1.259	0.04	0.466	0.587
	LTE Band 4	20M	QPSK	1	0	Right Tilted	0mm	Ant 4	DSI 1	20175	1732.5	17.52	18.50	1.253	0.04	0.513	0.643
	LTE Band 4	20M	QPSK	50	0	Right Tilted	0mm	Ant 4	DSI 1	20175	1732.5	17.50	18.50	1.259	0.08	0.522	0.657
	LTE Band 4	20M	QPSK	1	0	Left Cheek	0mm	Ant 4	DSI 1	20175	1732.5	17.52	18.50	1.253	0.11	0.541	0.678
	LTE Band 4	20M	QPSK	50	0	Left Cheek	0mm	Ant 4	DSI 1	20175	1732.5	17.50	18.50	1.259	-0.04	0.548	0.690
06	LTE Band 4	20M	QPSK	1	0	Left Tilted	0mm	Ant 4	DSI 1	20175	1732.5	17.52	18.50	1.253	-0.01	0.641	0.803
	LTE Band 4	20M	QPSK	50	0	Left Tilted	0mm	Ant 4	DSI 1	20175	1732.5	17.50	18.50	1.259	0.04	0.637	0.802
	LTE Band 4	20M	QPSK	100	0	Left Tilted	0mm	Ant 4	DSI 1	20175	1732.5	17.49	18.50	1.262	-0.07	0.557	0.703
	LTE Band 7	20M	QPSK	1	0	Right Cheek	0mm	Ant 1	DSI 1	21100	2535	25.02	25.50	1.117	0.01	0.078	0.087
	LTE Band 7_UL CA	20M	QPSK	1	0	Right Cheek	0mm	Ant 1	DSI 1	21100+20902	2535+2515.2	24.92	25.50	1.143	-0.02	0.063	0.072
	LTE Band 7	20M	QPSK	50	0	Right Cheek	0mm	Ant 1	DSI 1	21100	2535	24.01	24.50	1.119	0.06	0.066	0.074
	LTE Band 7	20M	QPSK	1	0	Right Tilted	0mm	Ant 1	DSI 1	21100	2535	25.02	25.50	1.117	-0.12	0.000	0.000
	LTE Band 7	20M	QPSK	50	0	Right Tilted	0mm	Ant 1	DSI 1	21100	2535	24.01	24.50	1.119	-0.01	0.000	0.000
	LTE Band 7	20M	QPSK	1	0	Left Cheek	0mm	Ant 1	DSI 1	21100	2535	25.02	25.50	1.117	-0.01	0.042	0.047
	LTE Band 7	20M	QPSK	50	0	Left Cheek	0mm	Ant 1	DSI 1	21100	2535	24.01	24.50	1.119	0.08	0.000	0.000
	LTE Band 7	20M	QPSK	1	0	Left Tilted	0mm	Ant 1	DSI 1	21100	2535	25.02	25.50	1.117	0.12	0.000	0.000
	LTE Band 7	20M	QPSK	50	0	Left Tilted	0mm	Ant 1	DSI 1	21100	2535	24.01	24.50	1.119	0.04	0.000	0.000
	LTE Band 7	20M	QPSK	1	0	Right Cheek	0mm	Ant 4	DSI 1	21100	2535	18.52	19.00	1.117	0.03	0.459	0.513
	LTE Band 7	20M	QPSK	50	0	Right Cheek	0mm	Ant 4	DSI 1	21100	2535	18.48	19.00	1.127	0.06	0.533	0.601
	LTE Band 7	20M	QPSK	1	0	Right Tilted	0mm	Ant 4	DSI 1	21100	2535	18.52	19.00	1.117	0.02	0.557	0.622
	LTE Band 7	20M	QPSK	50	0	Right Tilted	0mm	Ant 4	DSI 1	21100	2535	18.48	19.00	1.127	0.05	0.563	0.635
	LTE Band 7	20M	QPSK	1	0	Left Cheek	0mm	Ant 4	DSI 1	21100	2535	18.52	19.00	1.117	0.15	0.545	0.609
	LTE Band 7	20M	QPSK	50	0	Left Cheek	0mm	Ant 4	DSI 1	21100	2535	18.48	19.00	1.127	0.02	0.560	0.631
	LTE Band 7	20M	QPSK	1	0	Left Tilted	0mm	Ant 4	DSI 1	21100	2535	18.52	19.00	1.117	0.09	0.793	0.886
07	LTE Band 7	20M	QPSK	1	0	Left Tilted	0mm	Ant 4	DSI 1	20850	2510	18.49	19.00	1.125	-0.16	0.969	1.090
	LTE Band 7_UL CA	20M	QPSK	1	0	Left Tilted	0mm	Ant 4	DSI 1	20850+21048	2510+2529.8	18.43	19.00	1.140	0.12	0.943	1.075
	LTE Band 7	20M	QPSK	1	0	Left Tilted	0mm	Ant 4	DSI 1	21350	2560	18.47	19.00	1.130	0.05	0.687	0.776
	LTE Band 7	20M	QPSK	50	0	Left Tilted	0mm	Ant 4	DSI 1	21100	2535	18.48	19.00	1.127	-0.17	0.819	0.923
	LTE Band 7	20M	QPSK	50	0	Left Tilted	0mm	Ant 4	DSI 1	20850	2510	18.46	19.00	1.132	-0.04	0.953	1.079
	LTE Band 7	20M	QPSK	50	0	Left Tilted	0mm	Ant 4	DSI 1	21350	2560	18.42	19.00	1.143	-0.18	0.706	0.807
	LTE Band 7	20M	QPSK	100	0	Left Tilted	0mm	Ant 4	DSI 1	21100	2535	18.44	19.00	1.138	0.06	0.811	0.923
	LTE Band 12	10M	QPSK	1	0	Right Cheek	0mm	Ant 1	DSI 1	23095	707.5	24.79	25.50	1.178	0.08	0.085	0.100
	LTE Band 12	10M	QPSK	25	0	Right Cheek	0mm	Ant 1	DSI 1	23095	707.5	23.97	24.50	1.130	-0.15	0.071	0.080
	LTE Band 12	10M	QPSK	1	0	Right Tilted	0mm	Ant 1	DSI 1	23095	707.5	24.79	25.50	1.178	0.03	0.000	0.000
	LTE Band 12	10M	QPSK	25	0	Right Tilted	0mm	Ant 1	DSI 1	23095	707.5	23.97	24.50	1.130	0.05	0.000	0.000
	LTE Band 12	10M	QPSK	1	0	Left Cheek	0mm	Ant 1	DSI 1	23095	707.5	24.79	25.50	1.178	-0.02	0.077	0.091
	LTE Band 12	10M	QPSK	25	0	Left Cheek	0mm	Ant 1	DSI 1	23095	707.5	23.97	24.50	1.130	-0.17	0.000	0.000
	LTE Band 12	10M	QPSK	1	0	Left Tilted	0mm	Ant 1	DSI 1	23095	707.5	24.79	25.50	1.178	0.02	0.000	0.000
	LTE Band 12	10M	QPSK	25	0	Left Tilted	0mm	Ant 1	DSI 1	23095	707.5	23.97	24.50	1.130	-0.13	0.000	0.000
08	LTE Band 12	10M	QPSK	1	0	Right Cheek	0mm	Ant 4	DSI 1	23095	707.5	24.17	25.50	1.358	-0.01	0.537	0.729
	LTE Band 12	10M	QPSK	25	0	Right Cheek	0mm	Ant 4	DSI 1	23095	707.5	23.16	24.50	1.361	0.03	0.453	0.617
	LTE Band 12	10M	QPSK	1	0	Right Tilted	0mm	Ant 4	DSI 1	23095	707.5	24.17	25.50	1.358	0.08	0.314	0.427
	LTE Band 12	10M	QPSK	25	0	Right Tilted	0mm	Ant 4	DSI 1	23095	707.5	23.16	24.50	1.361	0.08	0.258	0.351
	LTE Band 12	10M	QPSK	1	0	Left Cheek	0mm	Ant 4	DSI 1	23095	707.5	24.17	25.50	1.358	0.08	0.510	0.693



FCC SAR Test Report

Report No. : FA122708

	LTE Band 12	10M	QPSK	25	0	Left Cheek	0mm	Ant 4	DSI 1	23095	707.5	23.16	24.50	1.361	-0.16	0.416	0.566
	LTE Band 12	10M	QPSK	1	0	Left Tilted	0mm	Ant 4	DSI 1	23095	707.5	24.17	25.50	1.358	0.09	0.444	0.603
	LTE Band 12	10M	QPSK	25	0	Left Tilted	0mm	Ant 4	DSI 1	23095	707.5	23.16	24.50	1.361	0.06	0.357	0.486
	LTE Band 13	10M	QPSK	1	0	Right Cheek	0mm	Ant 1	DSI 1	23230	782	24.89	25.50	1.151	0.05	0.093	0.107
	LTE Band 13	10M	QPSK	25	0	Right Cheek	0mm	Ant 1	DSI 1	23230	782	23.77	24.50	1.183	0.15	0.078	0.092
	LTE Band 13	10M	QPSK	1	0	Right Tilted	0mm	Ant 1	DSI 1	23230	782	24.89	25.50	1.151	0.08	0.056	0.064
	LTE Band 13	10M	QPSK	25	0	Right Tilted	0mm	Ant 1	DSI 1	23230	782	23.77	24.50	1.183	-0.09	0.046	0.054
	LTE Band 13	10M	QPSK	1	0	Left Cheek	0mm	Ant 1	DSI 1	23230	782	24.89	25.50	1.151	0.09	0.070	0.081
	LTE Band 13	10M	QPSK	25	0	Left Cheek	0mm	Ant 1	DSI 1	23230	782	23.77	24.50	1.183	-0.11	0.058	0.069
	LTE Band 13	10M	QPSK	1	0	Left Tilted	0mm	Ant 1	DSI 1	23230	782	24.89	25.50	1.151	-0.04	0.049	0.056
	LTE Band 13	10M	QPSK	25	0	Left Tilted	0mm	Ant 1	DSI 1	23230	782	23.77	24.50	1.183	-0.17	0.042	0.050
	LTE Band 13	10M	QPSK	1	0	Right Cheek	0mm	Ant 4	DSI 1	23230	782	24.52	25.50	1.253	0.07	0.797	0.999
	LTE Band 13	10M	QPSK	25	0	Right Cheek	0mm	Ant 4	DSI 1	23230	782	23.33	24.50	1.309	0.08	0.683	0.894
	LTE Band 13	10M	QPSK	50	0	Right Cheek	0mm	Ant 4	DSI 1	23230	782	23.39	24.50	1.291	0.02	0.699	0.903
	LTE Band 13	10M	QPSK	1	0	Right Tilted	0mm	Ant 4	DSI 1	23230	782	24.52	25.50	1.253	0.06	0.472	0.591
	LTE Band 13	10M	QPSK	25	0	Right Tilted	0mm	Ant 4	DSI 1	23230	782	23.33	24.50	1.309	0.04	0.405	0.530
09	LTE Band 13	10M	QPSK	1	0	Left Cheek	0mm	Ant 4	DSI 1	23230	782	24.52	25.50	1.253	-0.05	0.843	1.056
	LTE Band 13	10M	QPSK	25	0	Left Cheek	0mm	Ant 4	DSI 1	23230	782	23.33	24.50	1.309	0.1	0.586	0.767
	LTE Band 13	10M	QPSK	50	0	Left Cheek	0mm	Ant 4	DSI 1	23230	782	23.39	24.50	1.291	-0.03	0.611	0.789
	LTE Band 13	10M	QPSK	1	0	Left Tilted	0mm	Ant 4	DSI 1	23230	782	24.52	25.50	1.253	0.09	0.631	0.791
	LTE Band 13	10M	QPSK	25	0	Left Tilted	0mm	Ant 4	DSI 1	23230	782	23.33	24.50	1.309	0.09	0.529	0.693
	LTE Band 26	15M	QPSK	1	0	Right Cheek	0mm	Ant 1	DSI 1	26865	831.5	24.83	25.50	1.167	-0.1	0.147	0.172
	LTE Band 26	15M	QPSK	36	0	Right Cheek	0mm	Ant 1	DSI 1	26865	831.5	23.67	24.50	1.211	0.01	0.119	0.144
	LTE Band 26	15M	QPSK	1	0	Right Tilted	0mm	Ant 1	DSI 1	26865	831.5	24.83	25.50	1.167	0.03	0.085	0.099
	LTE Band 26	15M	QPSK	36	0	Right Tilted	0mm	Ant 1	DSI 1	26865	831.5	23.67	24.50	1.211	0.03	0.067	0.081
	LTE Band 26	15M	QPSK	1	0	Left Cheek	0mm	Ant 1	DSI 1	26865	831.5	24.83	25.50	1.167	0.02	0.000	0.000
	LTE Band 26	15M	QPSK	36	0	Left Cheek	0mm	Ant 1	DSI 1	26865	831.5	23.67	24.50	1.211	-0.13	0.084	0.102
	LTE Band 26	15M	QPSK	1	0	Left Tilted	0mm	Ant 1	DSI 1	26865	831.5	24.83	25.50	1.167	0.03	0.066	0.077
	LTE Band 26	15M	QPSK	36	0	Left Tilted	0mm	Ant 1	DSI 1	26865	831.5	23.67	24.50	1.211	0.08	0.056	0.068
	LTE Band 26	15M	QPSK	1	0	Right Cheek	0mm	Ant 4	DSI 1	26865	831.5	22.57	23.50	1.239	0.05	0.637	0.789
	LTE Band 26	15M	QPSK	36	0	Right Cheek	0mm	Ant 4	DSI 1	26865	831.5	22.47	23.50	1.268	-0.11	0.514	0.652
	LTE Band 26	15M	QPSK	1	0	Right Tilted	0mm	Ant 4	DSI 1	26865	831.5	22.57	23.50	1.239	0.07	0.527	0.653
	LTE Band 26	15M	QPSK	36	0	Right Tilted	0mm	Ant 4	DSI 1	26865	831.5	22.47	23.50	1.268	0.02	0.435	0.551
10	LTE Band 26	15M	QPSK	1	0	Left Cheek	0mm	Ant 4	DSI 1	26865	831.5	22.57	23.50	1.239	-0.07	0.751	0.930
	LTE Band 26	15M	QPSK	36	0	Left Cheek	0mm	Ant 4	DSI 1	26865	831.5	22.47	23.50	1.268	0.02	0.607	0.769
	LTE Band 26	15M	QPSK	75	0	Left Cheek	0mm	Ant 4	DSI 1	26865	831.5	22.44	23.50	1.276	0.03	0.512	0.654
	LTE Band 26	15M	QPSK	1	0	Left Tilted	0mm	Ant 4	DSI 1	26865	831.5	22.57	23.50	1.239	0.02	0.635	0.787
	LTE Band 26	15M	QPSK	36	0	Left Tilted	0mm	Ant 4	DSI 1	26865	831.5	22.47	23.50	1.268	0.02	0.503	0.638



<TDD LTE SAR>

Plot No.	Band	BW (MHz)	Modulation	RB Size	RB offset	Test Position	Gap (mm)	Antenna	Power State	Ch.	Freq. (MHz)	Average Power (dBm)	Tune-Up Limit (dBm)	Tune-up Scaling Factor	Duty Cycle %	Duty Cycle Scaling Factor	Power Drift (dB)	Measured 1g SAR (W/kg)	Reported 1g SAR (W/kg)
	LTE Band 38	20M	QPSK	1	0	Right Cheek	0mm	Ant 1	DSI 1	38000	2595	25.19	25.50	1.074	62.9	1.006	0.1	0.040	0.043
	LTE Band 38_UL CA	20M	QPSK	1	0	Right Cheek	0mm	Ant 1	DSI 1	38000+38198	2595+2614.8	25.05	25.50	1.109	62.9	1.006	-0.02	0.033	0.037
	LTE Band 38	20M	QPSK	50	0	Right Cheek	0mm	Ant 1	DSI 1	38000	2595	24.05	24.50	1.109	62.9	1.006	0.02	0.031	0.035
	LTE Band 38	20M	QPSK	1	0	Right Tilted	0mm	Ant 1	DSI 1	38000	2595	25.19	25.50	1.074	62.9	1.006	-0.04	0.033	0.036
	LTE Band 38	20M	QPSK	50	0	Right Tilted	0mm	Ant 1	DSI 1	38000	2595	24.05	24.50	1.109	62.9	1.006	-0.05	0.026	0.029
	LTE Band 38	20M	QPSK	1	0	Left Cheek	0mm	Ant 1	DSI 1	38000	2595	25.19	25.50	1.074	62.9	1.006	0.16	0.015	0.016
	LTE Band 38	20M	QPSK	50	0	Left Cheek	0mm	Ant 1	DSI 1	38000	2595	24.05	24.50	1.109	62.9	1.006	-0.13	0.012	0.013
	LTE Band 38	20M	QPSK	1	0	Left Tilted	0mm	Ant 1	DSI 1	38000	2595	25.19	25.50	1.074	62.9	1.006	0.07	0.013	0.014
	LTE Band 38	20M	QPSK	50	0	Left Tilted	0mm	Ant 1	DSI 1	38000	2595	24.05	24.50	1.109	62.9	1.006	0.06	0.011	0.012
	LTE Band 38	20M	QPSK	1	0	Right Cheek	0mm	Ant 4	DSI 1	38000	2595	23.57	24.00	1.104	62.9	1.006	0.07	0.540	0.600
	LTE Band 38	20M	QPSK	50	0	Right Cheek	0mm	Ant 4	DSI 1	38000	2595	23.55	24.00	1.109	62.9	1.006	0.02	0.545	0.608
	LTE Band 38	20M	QPSK	1	0	Right Tilted	0mm	Ant 4	DSI 1	38000	2595	23.57	24.00	1.104	62.9	1.006	-0.14	0.644	0.715
	LTE Band 38	20M	QPSK	50	0	Right Tilted	0mm	Ant 4	DSI 1	38000	2595	23.55	24.00	1.109	62.9	1.006	0.01	0.642	0.716
	LTE Band 38	20M	QPSK	1	0	Left Cheek	0mm	Ant 4	DSI 1	38000	2595	23.57	24.00	1.104	62.9	1.006	0.04	0.730	0.811
	LTE Band 38	20M	QPSK	50	0	Left Cheek	0mm	Ant 4	DSI 1	38000	2595	23.55	24.00	1.109	62.9	1.006	0.02	0.746	0.832
	LTE Band 38	20M	QPSK	100	0	Left Cheek	0mm	Ant 4	DSI 1	38000	2595	23.48	24.00	1.127	62.9	1.006	0.1	0.764	0.866
11	LTE Band 38	20M	QPSK	1	0	Left Tilted	0mm	Ant 4	DSI 1	38000	2595	23.57	24.00	1.104	62.9	1.006	0.09	0.935	1.039
	LTE Band 38_UL CA	20M	QPSK	1	0	Left Tilted	0mm	Ant 4	DSI 1	38000+38198	2595+2614.8	23.52	24.00	1.117	62.9	1.006	0.03	0.899	1.010
	LTE Band 38	20M	QPSK	50	0	Left Tilted	0mm	Ant 4	DSI 1	38000	2595	23.55	24.00	1.109	62.9	1.006	0.01	0.865	0.965
	LTE Band 38	20M	QPSK	100	0	Left Tilted	0mm	Ant 4	DSI 1	38000	2595	23.48	24.00	1.127	62.9	1.006	-0.04	0.827	0.938



<WLAN2.4G SAR>

Plot No.	Band	Mode	Test Position	Gap (mm)	Antenna	Power State	Ch.	Freq. (MHz)	Average Power (dBm)	Tune-Up Limit (dBm)	Tune-up Scaling Factor	Duty Cycle %	Duty Cycle Scaling Factor	Power Drift (dB)	Measured 1g SAR (W/kg)	Reported 1g SAR (W/kg)
	WLAN2.4GHz	802.11b 1Mbps	Right Cheek	0mm	Ant 7	Receiver On	1	2412	17.50	18.50	1.259	100	1.000	0.07	0.097	0.122
	WLAN2.4GHz	802.11b 1Mbps	Right Tilted	0mm	Ant 7	Receiver On	1	2412	17.50	18.50	1.259	100	1.000	-0.02	0.108	0.136
12	WLAN2.4GHz	802.11b 1Mbps	Left Cheek	0mm	Ant 7	Receiver On	1	2412	17.50	18.50	1.259	100	1.000	0.07	0.408	0.514
	WLAN2.4GHz	802.11b 1Mbps	Left Tilted	0mm	Ant 7	Receiver On	1	2412	17.50	18.50	1.259	100	1.000	0.03	0.361	0.454

<WLAN5G SAR>

Plot No.	Band	Mode	Test Position	Gap (mm)	Antenna	Power State	Ch.	Freq. (MHz)	Average Power (dBm)	Tune-Up Limit (dBm)	Tune-up Scaling Factor	Duty Cycle %	Duty Cycle Scaling Factor	Power Drift (dB)	Measured 1g SAR (W/kg)	Reported 1g SAR (W/kg)
	WLAN5.3GHz	802.11ac-VHT80 MCS0	Right Cheek	0mm	Ant 7	Receiver On	58	5290	14.02	15.00	1.254	92.77	1.078	0.02	0.216	0.292
	WLAN5.3GHz	802.11ac-VHT80 MCS0	Right Tilted	0mm	Ant 7	Receiver On	58	5290	14.02	15.00	1.254	92.77	1.078	-0.11	0.221	0.299
	WLAN5.3GHz	802.11ac-VHT80 MCS0	Left Cheek	0mm	Ant 7	Receiver On	58	5290	14.02	15.00	1.254	92.77	1.078	0.07	0.300	0.406
13	WLAN5.3GHz	802.11ac-VHT80 MCS0	Left Tilted	0mm	Ant 7	Receiver On	58	5290	14.02	15.00	1.254	92.77	1.078	-0.06	0.301	0.407
	WLAN5.5GHz	802.11ac-VHT80 MCS0	Right Cheek	0mm	Ant 7	Receiver On	106	5530	12.22	13.50	1.343	92.77	1.078	0.18	0.127	0.184
	WLAN5.5GHz	802.11ac-VHT80 MCS0	Right Tilted	0mm	Ant 7	Receiver On	106	5530	12.22	13.50	1.343	92.77	1.078	-0.04	0.140	0.203
14	WLAN5.5GHz	802.11ac-VHT80 MCS0	Left Cheek	0mm	Ant 7	Receiver On	106	5530	12.22	13.50	1.343	92.77	1.078	-0.08	0.223	0.323
	WLAN5.5GHz	802.11ac-VHT80 MCS0	Left Tilted	0mm	Ant 7	Receiver On	106	5530	12.22	13.50	1.343	92.77	1.078	-0.18	0.193	0.279
	WLAN5.8GHz	802.11ac-VHT80 MCS0	Right Cheek	0mm	Ant 7	Receiver On	155	5775	12.10	13.00	1.231	92.77	1.078	-0.15	0.107	0.142
	WLAN5.8GHz	802.11ac-VHT80 MCS0	Right Tilted	0mm	Ant 7	Receiver On	155	5775	12.10	13.00	1.231	92.77	1.078	-0.07	0.133	0.177
15	WLAN5.8GHz	802.11ac-VHT80 MCS0	Left Cheek	0mm	Ant 7	Receiver On	155	5775	12.10	13.00	1.231	92.77	1.078	-0.07	0.241	0.320
	WLAN5.8GHz	802.11ac-VHT80 MCS0	Left Tilted	0mm	Ant 7	Receiver On	155	5775	12.10	13.00	1.231	92.77	1.078	0.05	0.227	0.301

<Bluetooth SAR>

Plot No.	Band	Mode	Test Position	Gap (mm)	Antenna	Ch.	Freq. (MHz)	Average Power (dBm)	Tune-Up Limit (dBm)	Tune-up Scaling Factor	Duty Cycle %	Duty Cycle Scaling Factor	Power Drift (dB)	Measured 1g SAR (W/kg)	Reported 1g SAR (W/kg)
	Bluetooth	1Mbps	Right Cheek	0mm	Ant 7	39	2441	8.99	10.50	1.416	76.63	1.305	0.02	0.018	0.033
	Bluetooth	1Mbps	Right Tilted	0mm	Ant 7	39	2441	8.99	10.50	1.416	76.63	1.305	0.17	0.012	0.023
	Bluetooth	1Mbps	Left Cheek	0mm	Ant 7	39	2441	8.99	10.50	1.416	76.63	1.305	-0.15	0.048	0.089
16	Bluetooth	1Mbps	Left Tilted	0mm	Ant 7	39	2441	8.99	10.50	1.416	76.63	1.305	-0.03	0.051	0.094



15.2 Hotspot SAR

<GSM SAR>

Plot No.	Band	Mode	Test Position	Gap (mm)	Antenna	Power State	Ch.	Freq. (MHz)	Average Power (dBm)	Tune-Up Limit (dBm)	Tune-up Scaling Factor	Power Drift (dB)	Measured 1g SAR (W/kg)	Reported 1g SAR (W/kg)
	GSM850	GPRS (4 Tx slots)	Front	10mm	Ant 1	DSI 3	189	836.4	26.96	28.00	1.271	-0.11	0.206	0.262
	GSM850	GPRS (4 Tx slots)	Back	10mm	Ant 1	DSI 3	189	836.4	26.96	28.00	1.271	-0.1	0.234	0.297
	GSM850	GPRS (4 Tx slots)	Left Side	10mm	Ant 1	DSI 2	189	836.4	26.96	28.00	1.271	0.02	0.062	0.079
	GSM850	GPRS (4 Tx slots)	Right Side	10mm	Ant 1	DSI 2	189	836.4	26.96	28.00	1.271	0.01	0.151	0.192
	GSM850	GPRS (4 Tx slots)	Bottom Side	10mm	Ant 1	DSI 3	189	836.4	26.96	28.00	1.271	-0.04	0.175	0.222
	GSM850	GPRS (4 Tx slots)	Front	10mm	Ant 4	DSI 4	189	836.4	27.22	28.00	1.197	0.03	0.262	0.314
17	GSM850	GPRS (4 Tx slots)	Back	10mm	Ant 4	DSI 4	189	836.4	27.22	28.00	1.197	-0.09	0.312	0.373
	GSM850	GPRS (4 Tx slots)	Left Side	10mm	Ant 4	DSI 4	189	836.4	27.22	28.00	1.197	0.12	0.066	0.079
	GSM850	GPRS (4 Tx slots)	Right Side	10mm	Ant 4	DSI 2	189	836.4	27.22	28.00	1.197	-0.08	0.211	0.253
	GSM850	GPRS (4 Tx slots)	Top Side	10mm	Ant 4	DSI 4	189	836.4	27.22	28.00	1.197	-0.19	0.212	0.254
	GSM1900	GPRS (4 Tx slots)	Front	10mm	Ant 1	DSI 3	661	1880	19.12	20.00	1.225	-0.14	0.106	0.130
	GSM1900	GPRS (4 Tx slots)	Back	10mm	Ant 1	DSI 3	661	1880	19.12	20.00	1.225	0.05	0.148	0.181
	GSM1900	GPRS (4 Tx slots)	Left side	10mm	Ant 1	DSI 2	661	1880	24.33	25.00	1.167	-0.12	0.031	0.036
	GSM1900	GPRS (4 Tx slots)	Right side	10mm	Ant 1	DSI 2	661	1880	24.33	25.00	1.167	0.09	0.072	0.084
	GSM1900	GPRS (4 Tx slots)	Bottom Side	10mm	Ant 1	DSI 3	661	1880	19.12	20.00	1.225	-0.09	0.298	0.365
	GSM1900	GPRS (4 Tx slots)	Front	15mm	Ant 1	DSI 2	661	1880	24.33	25.00	1.167	-0.09	0.162	0.189
	GSM1900	GPRS (4 Tx slots)	Back	15mm	Ant 1	DSI 2	661	1880	24.33	25.00	1.167	-0.02	0.212	0.247
	GSM1900	GPRS (4 Tx slots)	Bottom Side	15mm	Ant 1	DSI 2	661	1880	24.33	25.00	1.167	-0.01	0.443	0.517
	GSM1900	GPRS (4 Tx slots)	Front	10mm	Ant 4	DSI 4	661	1880	23.57	24.00	1.104	-0.03	0.269	0.297
	GSM1900	GPRS (4 Tx slots)	Back	10mm	Ant 4	DSI 4	661	1880	23.57	24.00	1.104	0.01	0.380	0.420
	GSM1900	GPRS (4 Tx slots)	Left Side	10mm	Ant 4	DSI 4	661	1880	23.57	24.00	1.104	0.09	0.023	0.025
	GSM1900	GPRS (4 Tx slots)	Right Side	10mm	Ant 4	DSI 2	661	1880	24.35	25.00	1.161	-0.16	0.046	0.053
18	GSM1900	GPRS (4 Tx slots)	Top Side	10mm	Ant 4	DSI 4	661	1880	23.57	24.00	1.104	-0.14	0.875	0.966
	GSM1900	GPRS (4 Tx slots)	Top Side	10mm	Ant 4	DSI 4	512	1850.2	23.56	24.00	1.107	0.08	0.773	0.855
	GSM1900	GPRS (4 Tx slots)	Top Side	10mm	Ant 4	DSI 4	810	1909.8	23.46	24.00	1.132	0.04	0.798	0.904
	GSM1900	GPRS (4 Tx slots)	Front	15mm	Ant 4	DSI 2	661	1880	24.35	25.00	1.161	0.17	0.175	0.203
	GSM1900	GPRS (4 Tx slots)	Back	15mm	Ant 4	DSI 2	661	1880	24.35	25.00	1.161	0.08	0.250	0.290
	GSM1900	GPRS (4 Tx slots)	Left Side	15mm	Ant 4	DSI 2	661	1880	24.35	25.00	1.161	-0.1	0.000	0.000
	GSM1900	GPRS (4 Tx slots)	Top Side	15mm	Ant 4	DSI 2	661	1880	24.35	25.00	1.161	-0.04	0.447	0.519



<WCDMA SAR>

Plot No.	Band	Mode	Test Position	Gap (mm)	Antenna	Power State	Ch.	Freq. (MHz)	Average Power (dBm)	Tune-Up Limit (dBm)	Tune-up Scaling Factor	Power Drift (dB)	Measured 1g SAR (W/kg)	Reported 1g SAR (W/kg)
	WCDMA II	RMC 12.2Kbps	Front	10mm	Ant 1	DSI 3	9400	1880	19.12	20.00	1.225	-0.07	0.249	0.305
	WCDMA II	RMC 12.2Kbps	Back	10mm	Ant 1	DSI 3	9400	1880	19.12	20.00	1.225	-0.04	0.319	0.391
	WCDMA II	RMC 12.2Kbps	Left Side	10mm	Ant 1	DSI 2	9400	1880	22.13	23.00	1.222	0.08	0.013	0.016
	WCDMA II	RMC 12.2Kbps	Right Side	10mm	Ant 1	DSI 2	9400	1880	22.13	23.00	1.222	-0.13	0.042	0.051
	WCDMA II	RMC 12.2Kbps	Bottom Side	10mm	Ant 1	DSI 3	9400	1880	19.12	20.00	1.225	-0.11	0.715	0.876
	WCDMA II	RMC 12.2Kbps	Bottom Side	10mm	Ant 1	DSI 3	9262	1852.4	19.01	20.00	1.256	-0.07	0.694	0.872
	WCDMA II	RMC 12.2Kbps	Bottom Side	10mm	Ant 1	DSI 3	9538	1907.6	19.05	20.00	1.245	-0.06	0.711	0.885
	WCDMA II	RMC 12.2Kbps	Front	15mm	Ant 1	DSI 2	9400	1880	22.13	23.00	1.222	0.11	0.291	0.356
	WCDMA II	RMC 12.2Kbps	Back	15mm	Ant 1	DSI 2	9400	1880	22.13	23.00	1.222	-0.03	0.334	0.408
	WCDMA II	RMC 12.2Kbps	Bottom Side	15mm	Ant 1	DSI 2	9400	1880	22.13	23.00	1.222	-0.09	0.770	0.941
	WCDMA II	RMC 12.2Kbps	Bottom Side	15mm	Ant 1	DSI 2	9262	1852.4	22.03	23.00	1.250	0.01	0.648	0.810
	WCDMA II	RMC 12.2Kbps	Bottom Side	15mm	Ant 1	DSI 2	9538	1907.6	22.07	23.00	1.239	-0.07	0.725	0.898
	WCDMA II	RMC 12.2Kbps	Front	10mm	Ant 4	DSI 4	9400	1880	19.11	20.00	1.227	-0.13	0.270	0.331
	WCDMA II	RMC 12.2Kbps	Back	10mm	Ant 4	DSI 4	9400	1880	19.11	20.00	1.227	-0.02	0.364	0.447
	WCDMA II	RMC 12.2Kbps	Left Side	10mm	Ant 4	DSI 4	9400	1880	19.11	20.00	1.227	0.11	0.000	0.000
	WCDMA II	RMC 12.2Kbps	Right Side	10mm	Ant 4	DSI 2	9400	1880	23.27	23.50	1.054	0.07	0.057	0.060
	WCDMA II	RMC 12.2Kbps	Top Side	10mm	Ant 4	DSI 4	9400	1880	19.11	20.00	1.227	0.12	0.677	0.831
	WCDMA II	RMC 12.2Kbps	Top Side	10mm	Ant 4	DSI 4	9262	1852.4	19.00	20.00	1.259	-0.16	0.782	0.984
	WCDMA II	RMC 12.2Kbps	Top Side	10mm	Ant 4	DSI 4	9538	1907.6	19.10	20.00	1.230	-0.14	0.788	0.969
	WCDMA II	RMC 12.2Kbps	Front	15mm	Ant 4	DSI 2	9400	1880	23.27	23.50	1.054	0.06	0.345	0.364
	WCDMA II	RMC 12.2Kbps	Back	15mm	Ant 4	DSI 2	9400	1880	23.27	23.50	1.054	-0.03	0.493	0.520
	WCDMA II	RMC 12.2Kbps	Left Side	15mm	Ant 4	DSI 2	9400	1880	23.27	23.50	1.054	0.03	0.000	0.000
	WCDMA II	RMC 12.2Kbps	Top Side	15mm	Ant 4	DSI 2	9400	1880	23.27	23.50	1.054	0.02	0.858	0.905
19	WCDMA II	RMC 12.2Kbps	Top Side	15mm	Ant 4	DSI 2	9262	1852.4	23.16	23.50	1.081	-0.05	0.971	1.050
	WCDMA II	RMC 12.2Kbps	Top Side	15mm	Ant 4	DSI 2	9538	1907.6	23.25	23.50	1.059	-0.1	0.943	0.999
	WCDMA IV	RMC 12.2Kbps	Front	10mm	Ant 1	DSI 3	1413	1732.6	21.68	22.50	1.208	0.03	0.310	0.374
	WCDMA IV	RMC 12.2Kbps	Back	10mm	Ant 1	DSI 3	1413	1732.6	21.68	22.50	1.208	-0.05	0.405	0.489
	WCDMA IV	RMC 12.2Kbps	Left Side	10mm	Ant 1	DSI 2	1413	1732.6	24.68	25.50	1.208	0.1	0.048	0.058
	WCDMA IV	RMC 12.2Kbps	Right Side	10mm	Ant 1	DSI 2	1413	1732.6	24.68	25.50	1.208	0.15	0.062	0.075
	WCDMA IV	RMC 12.2Kbps	Bottom Side	10mm	Ant 1	DSI 3	1413	1732.6	21.68	22.50	1.208	-0.13	0.739	0.893
	WCDMA IV	RMC 12.2Kbps	Bottom Side	10mm	Ant 1	DSI 3	1312	1712.4	21.66	22.50	1.213	-0.1	0.583	0.707
	WCDMA IV	RMC 12.2Kbps	Bottom Side	10mm	Ant 1	DSI 3	1513	1752.6	21.62	22.50	1.225	-0.14	0.601	0.736
	WCDMA IV	RMC 12.2Kbps	Front	15mm	Ant 1	DSI 2	1413	1732.6	24.68	25.50	1.208	0.03	0.334	0.403
	WCDMA IV	RMC 12.2Kbps	Back	15mm	Ant 1	DSI 2	1413	1732.6	24.68	25.50	1.208	-0.05	0.433	0.523
	WCDMA IV	RMC 12.2Kbps	Bottom Side	15mm	Ant 1	DSI 2	1413	1732.6	24.68	25.50	1.208	-0.06	0.599	0.723
	WCDMA IV	RMC 12.2Kbps	Front	10mm	Ant 4	DSI 4	1413	1732.6	19.57	20.50	1.239	0.03	0.259	0.321
	WCDMA IV	RMC 12.2Kbps	Back	10mm	Ant 4	DSI 4	1413	1732.6	19.57	20.50	1.239	0.01	0.351	0.435
	WCDMA IV	RMC 12.2Kbps	Left Side	10mm	Ant 4	DSI 4	1413	1732.6	19.57	20.50	1.239	0.02	0.033	0.041
	WCDMA IV	RMC 12.2Kbps	Right Side	10mm	Ant 4	DSI 2	1413	1732.6	24.29	24.50	1.050	-0.17	0.079	0.083
	WCDMA IV	RMC 12.2Kbps	Top Side	10mm	Ant 4	DSI 4	1413	1732.6	19.57	20.50	1.239	-0.15	0.645	0.799
	WCDMA IV	RMC 12.2Kbps	Front	15mm	Ant 4	DSI 2	1413	1732.6	24.29	24.50	1.050	-0.05	0.465	0.488
	WCDMA IV	RMC 12.2Kbps	Back	15mm	Ant 4	DSI 2	1413	1732.6	24.29	24.50	1.050	-0.01	0.649	0.681
	WCDMA IV	RMC 12.2Kbps	Left Side	15mm	Ant 4	DSI 2	1413	1732.6	24.29	24.50	1.050	0.09	0.000	0.000
20	WCDMA IV	RMC 12.2Kbps	Top Side	15mm	Ant 4	DSI 2	1413	1732.6	24.29	24.50	1.050	-0.01	0.952	0.999
	WCDMA IV	RMC 12.2Kbps	Top Side	15mm	Ant 4	DSI 2	1312	1712.4	24.05	24.50	1.109	0.06	0.716	0.794
	WCDMA IV	RMC 12.2Kbps	Top Side	15mm	Ant 4	DSI 2	1513	1752.6	24.11	24.50	1.094	-0.15	0.89	0.974
	WCDMA V	RMC 12.2Kbps	Front	10mm	Ant 1	DSI 3	4182	836.4	24.85	25.50	1.161	-0.08	0.276	0.321
	WCDMA V	RMC 12.2Kbps	Back	10mm	Ant 1	DSI 3	4182	836.4	24.85	25.50	1.161	-0.14	0.330	0.383
	WCDMA V	RMC 12.2Kbps	Left Side	10mm	Ant 1	DSI 2	4182	836.4	24.85	25.50	1.161	0.11	0.082	0.095
	WCDMA V	RMC 12.2Kbps	Right Side	10mm	Ant 1	DSI 2	4182	836.4	24.85	25.50	1.161	0.03	0.186	0.216
	WCDMA V	RMC 12.2Kbps	Bottom Side	10mm	Ant 1	DSI 3	4182	836.4	24.85	25.50	1.161	0.02	0.257	0.298
	WCDMA V	RMC 12.2Kbps	Front	10mm	Ant 4	DSI 4	4182	836.4	24.41	25.50	1.285	0.13	0.407	0.523
21	WCDMA V	RMC 12.2Kbps	Back	10mm	Ant 4	DSI 4	4182	836.4	24.41	25.50	1.285	-0.03	0.528	0.679
	WCDMA V	RMC 12.2Kbps	Left Side	10mm	Ant 4	DSI 4	4182	836.4	24.41	25.50	1.285	-0.18	0.091	0.117
	WCDMA V	RMC 12.2Kbps	Right Side	10mm	Ant 4	DSI 2	4182	836.4	24.41	25.50	1.285	0.16	0.196	0.252
	WCDMA V	RMC 12.2Kbps	Top Side	10mm	Ant 4	DSI 4	4182	836.4	24.41	25.50	1.285	0.16	0.373	0.479



<FDD LTE SAR>

Plot No.	Band	BW (MHz)	Modulation	RB Size	RB offset	Test Position	Gap (mm)	Antenna	Power State	Ch.	Freq. (MHz)	Average Power (dBm)	Tune-Up Limit (dBm)	Tune-up Scaling Factor	Power Drift (dB)	Measured 1g SAR (W/kg)	Reported 1g SAR (W/kg)
	LTE Band 4	20M	QPSK	1	0	Front	10mm	Ant 1	DSI 3	20175	1732.5	22.75	23.00	1.059	0.02	0.378	0.400
	LTE Band 4	20M	QPSK	50	0	Front	10mm	Ant 1	DSI 3	20175	1732.5	22.72	23.00	1.067	-0.12	0.378	0.403
	LTE Band 4	20M	QPSK	1	0	Back	10mm	Ant 1	DSI 3	20175	1732.5	22.75	23.00	1.059	-0.1	0.478	0.506
	LTE Band 4	20M	QPSK	50	0	Back	10mm	Ant 1	DSI 3	20175	1732.5	22.72	23.00	1.067	0.02	0.480	0.512
	LTE Band 4	20M	QPSK	1	0	Left Side	10mm	Ant 1	DSI 2	20175	1732.5	24.97	25.50	1.130	0.17	0.038	0.043
	LTE Band 4	20M	QPSK	50	0	Left Side	10mm	Ant 1	DSI 2	20175	1732.5	23.94	24.50	1.138	-0.14	0.035	0.040
	LTE Band 4	20M	QPSK	1	0	Right Side	10mm	Ant 1	DSI 2	20175	1732.5	24.97	25.50	1.130	0.03	0.049	0.055
	LTE Band 4	20M	QPSK	50	0	Right Side	10mm	Ant 1	DSI 2	20175	1732.5	23.94	24.50	1.138	0.03	0.040	0.046
	LTE Band 4	20M	QPSK	1	0	Bottom Side	10mm	Ant 1	DSI 3	20175	1732.5	22.75	23.00	1.059	-0.11	1.003	1.062
22	LTE Band 4	20M	QPSK	50	0	Bottom Side	10mm	Ant 1	DSI 3	20175	1732.5	22.72	23.00	1.067	-0.11	1.020	1.088
	LTE Band 4	20M	QPSK	100	0	Bottom Side	10mm	Ant 1	DSI 3	20175	1732.5	22.65	23.00	1.084	-0.11	0.872	0.945
	LTE Band 4	20M	QPSK	1	0	Front	15mm	Ant 1	DSI 2	20175	1732.5	24.97	25.50	1.130	0.01	0.245	0.277
	LTE Band 4	20M	QPSK	50	0	Front	15mm	Ant 1	DSI 2	20175	1732.5	23.94	24.50	1.138	0.03	0.257	0.292
	LTE Band 4	20M	QPSK	1	0	Back	15mm	Ant 1	DSI 2	20175	1732.5	24.97	25.50	1.130	0.07	0.325	0.367
	LTE Band 4	20M	QPSK	50	0	Back	15mm	Ant 1	DSI 2	20175	1732.5	23.94	24.50	1.138	0.04	0.337	0.383
	LTE Band 4	20M	QPSK	1	0	Bottom Side	15mm	Ant 1	DSI 2	20175	1732.5	24.97	25.50	1.130	-0.06	0.531	0.600
	LTE Band 4	20M	QPSK	50	0	Bottom Side	15mm	Ant 1	DSI 2	20175	1732.5	23.94	24.50	1.138	0.01	0.569	0.647
	LTE Band 4	20M	QPSK	1	0	Front	10mm	Ant 4	DSI 4	20175	1732.5	21.30	22.50	1.318	0.08	0.407	0.537
	LTE Band 4	20M	QPSK	50	0	Front	10mm	Ant 4	DSI 4	20175	1732.5	21.24	22.50	1.337	0.12	0.414	0.553
	LTE Band 4	20M	QPSK	1	0	Back	10mm	Ant 4	DSI 4	20175	1732.5	21.30	22.50	1.318	-0.07	0.585	0.771
	LTE Band 4	20M	QPSK	50	0	Back	10mm	Ant 4	DSI 4	20175	1732.5	21.24	22.50	1.337	-0.02	0.591	0.790
	LTE Band 4	20M	QPSK	1	0	Left Side	10mm	Ant 4	DSI 4	20175	1732.5	21.30	22.50	1.318	0.06	0.034	0.045
	LTE Band 4	20M	QPSK	50	0	Left Side	10mm	Ant 4	DSI 4	20175	1732.5	21.24	22.50	1.337	0.12	0.026	0.035
	LTE Band 4	20M	QPSK	1	0	Right Side	10mm	Ant 4	DSI 2	20175	1732.5	24.39	25.50	1.291	0.06	0.072	0.093
	LTE Band 4	20M	QPSK	50	0	Right Side	10mm	Ant 4	DSI 2	20175	1732.5	23.34	24.50	1.306	-0.08	0.061	0.080
	LTE Band 4	20M	QPSK	1	0	Top Side	10mm	Ant 4	DSI 4	20175	1732.5	21.30	22.50	1.318	-0.05	0.819	1.080
	LTE Band 4	20M	QPSK	50	0	Top Side	10mm	Ant 4	DSI 4	20175	1732.5	21.24	22.50	1.337	-0.09	0.805	1.076
	LTE Band 4	20M	QPSK	100	0	Top Side	10mm	Ant 4	DSI 4	20175	1732.5	21.22	22.50	1.343	0.01	0.777	1.043
	LTE Band 4	20M	QPSK	1	0	Front	15mm	Ant 4	DSI 2	20175	1732.5	24.39	25.50	1.291	0.02	0.395	0.510
	LTE Band 4	20M	QPSK	50	0	Front	15mm	Ant 4	DSI 2	20175	1732.5	23.34	24.50	1.306	0.03	0.399	0.521
	LTE Band 4	20M	QPSK	1	0	Back	15mm	Ant 4	DSI 2	20175	1732.5	24.39	25.50	1.291	0.07	0.561	0.724
	LTE Band 4	20M	QPSK	50	0	Back	15mm	Ant 4	DSI 2	20175	1732.5	23.34	24.50	1.306	-0.08	0.577	0.754
	LTE Band 4	20M	QPSK	1	0	Left Side	15mm	Ant 4	DSI 2	20175	1732.5	24.39	25.50	1.291	-0.17	0.000	0.000
	LTE Band 4	20M	QPSK	1	0	Top Side	15mm	Ant 4	DSI 2	20175	1732.5	24.39	25.50	1.291	0.03	0.794	1.025
	LTE Band 4	20M	QPSK	50	0	Top Side	15mm	Ant 4	DSI 2	20175	1732.5	23.34	24.50	1.306	0.07	0.663	0.866
	LTE Band 4	20M	QPSK	100	0	Top Side	15mm	Ant 4	DSI 2	20175	1732.5	23.21	24.50	1.346	-0.06	0.652	0.878
	LTE Band 7	20M	QPSK	1	0	Front	10mm	Ant 1	DSI 3	21100	2535	18.68	19.50	1.208	-0.05	0.173	0.209
	LTE Band 7	20M	QPSK	50	0	Front	10mm	Ant 1	DSI 3	21100	2535	18.59	19.50	1.233	-0.12	0.174	0.215
	LTE Band 7	20M	QPSK	1	0	Back	10mm	Ant 1	DSI 3	21100	2535	18.68	19.50	1.208	0.03	0.232	0.280
	LTE Band 7	20M	QPSK	50	0	Back	10mm	Ant 1	DSI 3	21100	2535	18.59	19.50	1.233	-0.03	0.213	0.263
	LTE Band 7	20M	QPSK	1	0	Left Side	10mm	Ant 1	DSI 2	21100	2535	25.02	25.50	1.117	0.04	0.082	0.092
	LTE Band 7	20M	QPSK	50	0	Left Side	10mm	Ant 1	DSI 2	21100	2535	24.01	24.50	1.119	0.06	0.066	0.074
	LTE Band 7	20M	QPSK	1	0	Right Side	10mm	Ant 1	DSI 2	21100	2535	25.02	25.50	1.117	-0.02	0.044	0.049
	LTE Band 7	20M	QPSK	50	0	Right Side	10mm	Ant 1	DSI 2	21100	2535	24.01	24.50	1.119	0.07	0.040	0.045
	LTE Band 7	20M	QPSK	1	0	Bottom Side	10mm	Ant 1	DSI 3	21100	2535	18.68	19.50	1.208	0.01	0.461	0.557
	LTE Band 7_UL CA	20M	QPSK	1	0	Bottom Side	10mm	Ant 1	DSI 3	21100+20902	2535+2515.2	18.63	19.50	1.222	0.05	0.433	0.529
	LTE Band 7	20M	QPSK	50	0	Bottom Side	10mm	Ant 1	DSI 3	21100	2535	18.59	19.50	1.233	-0.16	0.451	0.556
	LTE Band 7	20M	QPSK	1	0	Front	15mm	Ant 1	DSI 2	21100	2535	25.02	25.50	1.117	0.02	0.355	0.396
	LTE Band 7	20M	QPSK	50	0	Front	15mm	Ant 1	DSI 2	21100	2535	24.01	24.50	1.119	0.18	0.363	0.406
	LTE Band 7	20M	QPSK	1	0	Back	15mm	Ant 1	DSI 2	21100	2535	25.02	25.50	1.117	0.01	0.467	0.522
	LTE Band 7	20M	QPSK	1	0	Bottom Side	15mm	Ant 1	DSI 2	21100	2535	25.02	25.50	1.117	-0.06	0.974	1.088
	LTE Band 7_UL CA	20M	QPSK	1	0	Bottom Side	15mm	Ant 1	DSI 2	21100+20902	2535+2515.2	24.92	25.50	1.143	0.03	0.934	1.067
	LTE Band 7	20M	QPSK	1	0	Bottom Side	15mm	Ant 1	DSI 2	20850	2510	24.87	25.50	1.156	0.05	0.936	1.082



FCC SAR Test Report

Report No. : FA122708

Table with columns: Band, Power, Modulation, Duty Cycle, Frequency, Distance, Antenna, DSI, Power Density, etc. Includes rows for LTE Bands 7, 12, and 13 with various test configurations and results.



FCC SAR Test Report

Report No. : FA122708

	LTE Band 13	10M	QPSK	25	0	Bottom Side	10mm	Ant 1	DSI 3	23230	782	23.77	24.50	1.183	0.13	0.125	0.148
	LTE Band 13	10M	QPSK	1	0	Front	10mm	Ant 4	DSI 4	23230	782	24.52	25.50	1.253	0.03	0.218	0.273
	LTE Band 13	10M	QPSK	25	0	Front	10mm	Ant 4	DSI 4	23230	782	23.33	24.50	1.309	0.07	0.182	0.238
25	LTE Band 13	10M	QPSK	1	0	Back	10mm	Ant 4	DSI 4	23230	782	24.52	25.50	1.253	-0.05	0.286	0.358
	LTE Band 13	10M	QPSK	25	0	Back	10mm	Ant 4	DSI 4	23230	782	23.33	24.50	1.309	-0.18	0.233	0.305
	LTE Band 13	10M	QPSK	1	0	Left Side	10mm	Ant 4	DSI 4	23230	782	24.52	25.50	1.253	0.06	0.092	0.115
	LTE Band 13	10M	QPSK	25	0	Left Side	10mm	Ant 4	DSI 4	23230	782	23.33	24.50	1.309	0.02	0.072	0.094
	LTE Band 13	10M	QPSK	1	0	Right Side	10mm	Ant 4	DSI 2	23230	782	24.52	25.50	1.253	0.05	0.154	0.193
	LTE Band 13	10M	QPSK	25	0	Right Side	10mm	Ant 4	DSI 2	23230	782	23.33	24.50	1.309	-0.18	0.124	0.162
	LTE Band 13	10M	QPSK	1	0	Top Side	10mm	Ant 4	DSI 4	23230	782	24.52	25.50	1.253	0.07	0.218	0.273
	LTE Band 13	10M	QPSK	25	0	Top Side	10mm	Ant 4	DSI 4	23230	782	23.33	24.50	1.309	0.15	0.175	0.229
	LTE Band 26	15M	QPSK	1	0	Front	10mm	Ant 1	DSI 3	26865	831.5	24.83	25.50	1.167	-0.07	0.228	0.266
	LTE Band 26	15M	QPSK	36	0	Front	10mm	Ant 1	DSI 3	26865	831.5	23.67	24.50	1.211	0.1	0.183	0.222
	LTE Band 26	15M	QPSK	1	0	Back	10mm	Ant 1	DSI 3	26865	831.5	24.83	25.50	1.167	-0.07	0.267	0.312
	LTE Band 26	15M	QPSK	36	0	Back	10mm	Ant 1	DSI 3	26865	831.5	23.67	24.50	1.211	0.09	0.210	0.254
	LTE Band 26	15M	QPSK	1	0	Left Side	10mm	Ant 1	DSI 2	26865	831.5	24.83	25.50	1.167	0.05	0.071	0.083
	LTE Band 26	15M	QPSK	36	0	Left Side	10mm	Ant 1	DSI 2	26865	831.5	23.67	24.50	1.211	-0.13	0.057	0.069
	LTE Band 26	15M	QPSK	1	0	Right Side	10mm	Ant 1	DSI 2	26865	831.5	24.83	25.50	1.167	0.04	0.160	0.187
	LTE Band 26	15M	QPSK	36	0	Right Side	10mm	Ant 1	DSI 2	26865	831.5	23.67	24.50	1.211	-0.09	0.128	0.155
	LTE Band 26	15M	QPSK	1	0	Bottom Side	10mm	Ant 1	DSI 3	26865	831.5	24.83	25.50	1.167	-0.14	0.226	0.264
	LTE Band 26	15M	QPSK	36	0	Bottom Side	10mm	Ant 1	DSI 3	26865	831.5	23.67	24.50	1.211	-0.06	0.183	0.222
	LTE Band 26	15M	QPSK	1	0	Front	10mm	Ant 4	DSI 4	26865	831.5	24.64	25.50	1.219	0.04	0.348	0.424
	LTE Band 26	15M	QPSK	36	0	Front	10mm	Ant 4	DSI 4	26865	831.5	23.57	24.50	1.239	0.1	0.276	0.342
26	LTE Band 26	15M	QPSK	1	0	Back	10mm	Ant 4	DSI 4	26865	831.5	24.64	25.50	1.219	-0.01	0.425	0.518
	LTE Band 26	15M	QPSK	36	0	Back	10mm	Ant 4	DSI 4	26865	831.5	23.57	24.50	1.239	-0.18	0.342	0.424
	LTE Band 26	15M	QPSK	1	0	Left Side	10mm	Ant 4	DSI 4	26865	831.5	24.64	25.50	1.219	0.09	0.089	0.108
	LTE Band 26	15M	QPSK	36	0	Left Side	10mm	Ant 4	DSI 4	26865	831.5	23.57	24.50	1.239	0.06	0.071	0.088
	LTE Band 26	15M	QPSK	1	0	Right Side	10mm	Ant 4	DSI 2	26865	831.5	24.64	25.50	1.219	-0.13	0.211	0.257
	LTE Band 26	15M	QPSK	36	0	Right Side	10mm	Ant 4	DSI 2	26865	831.5	23.57	24.50	1.239	0.08	0.168	0.208
	LTE Band 26	15M	QPSK	1	0	Top Side	10mm	Ant 4	DSI 4	26865	831.5	24.64	25.50	1.219	0.07	0.294	0.358
	LTE Band 26	15M	QPSK	36	0	Top Side	10mm	Ant 4	DSI 4	26865	831.5	23.57	24.50	1.239	0.02	0.233	0.289



<TDD LTE SAR>

Plot No.	Band	BW (MHz)	Modulation	RB Size	RB offset	Test Position	Gap (mm)	Antenna	Power State	Ch.	Freq. (MHz)	Average Power (dBm)	Tune-Up Limit (dBm)	Tune-up Scaling Factor	Duty Cycle %	Duty Cycle Scaling Factor	Power Drift (dB)	Measured 1g SAR (W/kg)	Reported 1g SAR (W/kg)
	LTE Band 38	20M	QPSK	1	0	Front	10mm	Ant 1	DSI 3	38000	2595	22.27	23.00	1.183	62.9	1.006	-0.15	0.214	0.255
	LTE Band 38	20M	QPSK	50	0	Front	10mm	Ant 1	DSI 3	38000	2595	22.17	23.00	1.211	62.9	1.006	0.07	0.210	0.256
	LTE Band 38	20M	QPSK	1	0	Back	10mm	Ant 1	DSI 3	38000	2595	22.27	23.00	1.183	62.9	1.006	-0.05	0.269	0.320
	LTE Band 38	20M	QPSK	50	0	Back	10mm	Ant 1	DSI 3	38000	2595	22.17	23.00	1.211	62.9	1.006	0.07	0.261	0.318
	LTE Band 38	20M	QPSK	1	0	Left Side	10mm	Ant 1	DSI 2	38000	2595	25.19	25.50	1.074	62.9	1.006	0.18	0.054	0.058
	LTE Band 38	20M	QPSK	50	0	Left Side	10mm	Ant 1	DSI 2	38000	2595	24.05	24.50	1.109	62.9	1.006	-0.18	0.045	0.050
	LTE Band 38	20M	QPSK	1	0	Right Side	10mm	Ant 1	DSI 2	38000	2595	25.19	25.50	1.074	62.9	1.006	0.08	0.036	0.039
	LTE Band 38	20M	QPSK	50	0	Right Side	10mm	Ant 1	DSI 2	38000	2595	24.05	24.50	1.109	62.9	1.006	-0.04	0.024	0.027
	LTE Band 38	20M	QPSK	1	0	Bottom Side	10mm	Ant 1	DSI 3	38000	2595	22.27	23.00	1.183	62.9	1.006	-0.14	0.592	0.705
	LTE Band 38_UL CA	20M	QPSK	1	0	Bottom Side	10mm	Ant 1	DSI 3	38000+2595+38198	2595+2614.8	22.17	23.00	1.211	62.9	1.006	-0.14	0.562	0.684
	LTE Band 38	20M	QPSK	50	0	Bottom Side	10mm	Ant 1	DSI 3	38000	2595	22.17	23.00	1.211	62.9	1.006	-0.01	0.531	0.647
	LTE Band 38	20M	QPSK	1	0	Front	15mm	Ant 1	DSI 2	38000	2595	25.19	25.50	1.074	62.9	1.006	-0.06	0.216	0.233
	LTE Band 38	20M	QPSK	50	0	Front	15mm	Ant 1	DSI 2	38000	2595	24.05	24.50	1.109	62.9	1.006	-0.11	0.219	0.244
	LTE Band 38	20M	QPSK	1	0	Back	15mm	Ant 1	DSI 2	38000	2595	25.19	25.50	1.074	62.9	1.006	0.01	0.278	0.300
	LTE Band 38	20M	QPSK	1	0	Bottom Side	15mm	Ant 1	DSI 2	38000	2595	25.19	25.50	1.074	62.9	1.006	-0.05	0.486	0.525
	LTE Band 38_UL CA	20M	QPSK	1	0	Bottom Side	15mm	Ant 1	DSI 2	38000+38198	2595+2614.8	25.05	25.50	1.109	62.9	1.006	-0.05	0.435	0.485
	LTE Band 38	20M	QPSK	1	0	Front	10mm	Ant 4	DSI 4	38000	2595	24.34	25.00	1.164	62.9	1.006	-0.1	0.241	0.282
	LTE Band 38	20M	QPSK	50	0	Front	10mm	Ant 4	DSI 4	38000	2595	23.78	24.50	1.180	62.9	1.006	0.05	0.245	0.291
	LTE Band 38	20M	QPSK	1	0	Back	10mm	Ant 4	DSI 4	38000	2595	24.34	25.00	1.164	62.9	1.006	0.18	0.414	0.485
	LTE Band 38	20M	QPSK	50	0	Back	10mm	Ant 4	DSI 4	38000	2595	23.78	24.50	1.180	62.9	1.006	0.05	0.385	0.457
	LTE Band 38	20M	QPSK	1	0	Left Side	10mm	Ant 4	DSI 4	38000	2595	24.34	25.00	1.164	62.9	1.006	0.03	0.036	0.042
	LTE Band 38	20M	QPSK	50	0	Left Side	10mm	Ant 4	DSI 4	38000	2595	23.78	24.50	1.180	62.9	1.006	0.17	0.021	0.025
	LTE Band 38	20M	QPSK	1	0	Right Side	10mm	Ant 4	DSI 2	38000	2595	24.79	25.50	1.178	62.9	1.006	0.03	0.068	0.081
	LTE Band 38	20M	QPSK	50	0	Right Side	10mm	Ant 4	DSI 2	38000	2595	23.72	24.50	1.197	62.9	1.006	0.14	0.055	0.066
27	LTE Band 38	20M	QPSK	1	0	Top Side	10mm	Ant 4	DSI 4	38000	2595	24.34	25.00	1.164	62.9	1.006	-0.13	0.916	1.073
	LTE Band 38_UL CA	20M	QPSK	1	0	Top Side	10mm	Ant 4	DSI 4	38000+38198	2595+2614.8	24.27	25.00	1.183	62.9	1.006	-0.13	0.884	1.052
	LTE Band 38	20M	QPSK	1	0	Top Side	10mm	Ant 4	DSI 4	37850	2580	24.32	25.00	1.169	62.9	1.006	-0.14	0.835	0.982
	LTE Band 38	20M	QPSK	1	0	Top Side	10mm	Ant 4	DSI 4	38150	2610	24.26	25.00	1.186	62.9	1.006	-0.16	0.780	0.930
	LTE Band 38	20M	QPSK	50	0	Top Side	10mm	Ant 4	DSI 4	38000	2595	23.78	24.50	1.180	62.9	1.006	-0.1	0.877	1.041
	LTE Band 38	20M	QPSK	50	0	Top Side	10mm	Ant 4	DSI 4	37850	2580	23.70	24.50	1.202	62.9	1.006	-0.12	0.651	0.787
	LTE Band 38	20M	QPSK	50	0	Top Side	10mm	Ant 4	DSI 4	38150	2610	23.69	24.50	1.205	62.9	1.006	-0.1	0.644	0.781
	LTE Band 38	20M	QPSK	100	0	Top Side	10mm	Ant 4	DSI 4	38000	2595	23.68	24.50	1.208	62.9	1.006	-0.03	0.641	0.779
	LTE Band 38	20M	QPSK	1	0	Front	15mm	Ant 4	DSI 2	38000	2595	24.79	25.50	1.178	62.9	1.006	0.03	0.108	0.128
	LTE Band 38	20M	QPSK	50	0	Front	15mm	Ant 4	DSI 2	38000	2595	23.72	24.50	1.197	62.9	1.006	-0.02	0.089	0.107
	LTE Band 38	20M	QPSK	1	0	Back	15mm	Ant 4	DSI 2	38000	2595	24.79	25.50	1.178	62.9	1.006	0.09	0.187	0.222
	LTE Band 38	20M	QPSK	1	0	Top Side	15mm	Ant 4	DSI 2	38000	2595	24.79	25.50	1.178	62.9	1.006	-0.02	0.346	0.410



<WLAN2.4G SAR>

Plot No.	Band	Mode	Test Position	Gap (mm)	Antenna	Power State	Ch.	Freq. (MHz)	Average Power (dBm)	Tune-Up Limit (dBm)	Tune-up Scaling Factor	Duty Cycle %	Duty Cycle Scaling Factor	Power Drift (dB)	Measured 1g SAR (W/kg)	Reported 1g SAR (W/kg)
	WLAN2.4GHz	802.11b 1Mbps	Front	10mm	Ant 7	Receiver Off	1	2412	17.50	18.50	1.259	100	1.000	-0.07	0.108	0.136
	WLAN2.4GHz	802.11b 1Mbps	Back	10mm	Ant 7	Receiver Off	1	2412	17.50	18.50	1.259	100	1.000	0.06	0.124	0.156
28	WLAN2.4GHz	802.11b 1Mbps	Right Side	10mm	Ant 7	Receiver Off	1	2412	17.50	18.50	1.259	100	1.000	-0.06	0.166	0.209
	WLAN2.4GHz	802.11b 1Mbps	Top Side	10mm	Ant 7	Receiver Off	1	2412	17.50	18.50	1.259	100	1.000	-0.16	0.133	0.167

<WLAN5G SAR>

Plot No.	Band	Mode	Test Position	Gap (mm)	Antenna	Power State	Ch.	Freq. (MHz)	Average Power (dBm)	Tune-Up Limit (dBm)	Tune-up Scaling Factor	Duty Cycle %	Duty Cycle Scaling Factor	Power Drift (dB)	Measured 1g SAR (W/kg)	Reported 1g SAR (W/kg)
	WLAN5.2GHz	802.11n-HT40 MCS0	Front	10mm	Ant 7	Receiver Off	38	5190	15.36	16.50	1.299	96.32	1.038	0.05	0.054	0.073
	WLAN5.2GHz	802.11n-HT40 MCS0	Back	10mm	Ant 7	Receiver Off	38	5190	15.36	16.50	1.299	96.32	1.038	-0.02	0.177	0.239
	WLAN5.2GHz	802.11n-HT40 MCS0	Right Side	10mm	Ant 7	Receiver Off	38	5190	15.36	16.50	1.299	96.32	1.038	0.05	0.103	0.139
29	WLAN5.2GHz	802.11n-HT40 MCS0	Top Side	10mm	Ant 7	Receiver Off	38	5190	15.36	16.50	1.299	96.32	1.038	0.09	0.184	0.248
	WLAN5.8GHz	802.11ac-VHT80 MCS0	Front	10mm	Ant 7	Receiver Off	155	5775	12.10	13.00	1.231	92.77	1.078	0.09	0.029	0.038
	WLAN5.8GHz	802.11ac-VHT80 MCS0	Back	10mm	Ant 7	Receiver Off	155	5775	12.10	13.00	1.231	92.77	1.078	-0.03	0.117	0.155
	WLAN5.8GHz	802.11ac-VHT80 MCS0	Right Side	10mm	Ant 7	Receiver Off	155	5775	12.10	13.00	1.231	92.77	1.078	0.08	0.092	0.122
30	WLAN5.8GHz	802.11ac-VHT80 MCS0	Top Side	10mm	Ant 7	Receiver Off	155	5775	12.10	13.00	1.231	92.77	1.078	-0.06	0.159	0.211

<Bluetooth SAR>

Plot No.	Band	Mode	Test Position	Gap (mm)	Antenna	Ch.	Freq. (MHz)	Average Power (dBm)	Tune-Up Limit (dBm)	Tune-up Scaling Factor	Duty Cycle %	Duty Cycle Scaling Factor	Power Drift (dB)	Measured 1g SAR (W/kg)	Reported 1g SAR (W/kg)
	Bluetooth	1Mbps	Front	10mm	Ant 7	39	2441	8.99	10.50	1.417	76.63	1.305	0.02	0.006	0.011
31	Bluetooth	1Mbps	Back	10mm	Ant 7	39	2441	8.99	10.50	1.417	76.63	1.305	-0.01	0.013	0.024
	Bluetooth	1Mbps	Right Side	10mm	Ant 7	39	2441	8.99	10.50	1.417	76.63	1.305	0.19	0.010	0.018
	Bluetooth	1Mbps	Top Side	10mm	Ant 7	39	2441	8.99	10.50	1.417	76.63	1.305	-0.14	0.009	0.017



15.3 Body Worn Accessory SAR

<GSM SAR>

Plot No.	Band	Mode	Test Position	Gap (mm)	Antenna	Power State	Ch.	Freq. (MHz)	Average Power (dBm)	Tune-Up Limit (dBm)	Tune-up Scaling Factor	Power Drift (dB)	Measured 1g SAR (W/kg)	Reported 1g SAR (W/kg)
	GSM850	GPRS (4 Tx slots)	Front	10mm	Ant 1	DSI 3	189	836.4	26.96	28.00	1.271	-0.11	0.206	0.262
	GSM850	GPRS (4 Tx slots)	Back	10mm	Ant 1	DSI 3	189	836.4	26.96	28.00	1.271	-0.1	0.234	0.297
	GSM850	GPRS (4 Tx slots)	Front	10mm	Ant 4	DSI 4	189	836.4	27.22	28.00	1.197	0.03	0.262	0.314
32	GSM850	GPRS (4 Tx slots)	Back	10mm	Ant 4	DSI 4	189	836.4	27.22	28.00	1.197	-0.09	0.312	0.373
	GSM1900	GPRS (4 Tx slots)	Front	10mm	Ant 1	DSI 3	661	1880	19.12	20.00	1.225	-0.14	0.106	0.130
	GSM1900	GPRS (4 Tx slots)	Back	10mm	Ant 1	DSI 3	661	1880	19.12	20.00	1.225	0.05	0.148	0.181
	GSM1900	GPRS (4 Tx slots)	Front	15mm	Ant 1	DSI 2	661	1880	24.33	25.00	1.167	-0.09	0.162	0.189
	GSM1900	GPRS (4 Tx slots)	Back	15mm	Ant 1	DSI 2	661	1880	24.33	25.00	1.167	-0.02	0.212	0.247
	GSM1900	GPRS (4 Tx slots)	Front	10mm	Ant 4	DSI 4	661	1880	23.57	24.00	1.104	-0.03	0.269	0.297
33	GSM1900	GPRS (4 Tx slots)	Back	10mm	Ant 4	DSI 4	661	1880	23.57	24.00	1.104	0.01	0.380	0.420
	GSM1900	GPRS (4 Tx slots)	Front	15mm	Ant 4	DSI 2	661	1880	24.35	25.00	1.161	0.17	0.175	0.203
	GSM1900	GPRS (4 Tx slots)	Back	15mm	Ant 4	DSI 2	661	1880	24.35	25.00	1.161	0.08	0.250	0.290

<WCDMA SAR>

Plot No.	Band	Mode	Test Position	Gap (mm)	Antenna	Power State	Ch.	Freq. (MHz)	Average Power (dBm)	Tune-Up Limit (dBm)	Tune-up Scaling Factor	Power Drift (dB)	Measured 1g SAR (W/kg)	Reported 1g SAR (W/kg)
	WCDMA II	RMC 12.2Kbps	Front	10mm	Ant 1	DSI 3	9400	1880	19.12	20.00	1.225	-0.07	0.249	0.305
	WCDMA II	RMC 12.2Kbps	Back	10mm	Ant 1	DSI 3	9400	1880	19.12	20.00	1.225	-0.04	0.319	0.391
	WCDMA II	RMC 12.2Kbps	Front	15mm	Ant 1	DSI 2	9400	1880	22.13	23.00	1.222	0.11	0.291	0.356
	WCDMA II	RMC 12.2Kbps	Back	15mm	Ant 1	DSI 2	9400	1880	22.13	23.00	1.222	-0.03	0.334	0.408
	WCDMA II	RMC 12.2Kbps	Front	10mm	Ant 4	DSI 4	9400	1880	19.11	20.00	1.227	-0.13	0.270	0.331
	WCDMA II	RMC 12.2Kbps	Back	10mm	Ant 4	DSI 4	9400	1880	19.11	20.00	1.227	-0.02	0.364	0.447
	WCDMA II	RMC 12.2Kbps	Front	15mm	Ant 4	DSI 2	9400	1880	23.27	23.50	1.054	0.06	0.345	0.364
34	WCDMA II	RMC 12.2Kbps	Back	15mm	Ant 4	DSI 2	9400	1880	23.27	23.50	1.054	-0.03	0.493	0.520
	WCDMA IV	RMC 12.2Kbps	Front	10mm	Ant 1	DSI 3	1413	1732.6	21.68	22.50	1.208	0.03	0.310	0.374
	WCDMA IV	RMC 12.2Kbps	Back	10mm	Ant 1	DSI 3	1413	1732.6	21.68	22.50	1.208	-0.05	0.405	0.489
	WCDMA IV	RMC 12.2Kbps	Front	15mm	Ant 1	DSI 2	1413	1732.6	24.68	25.50	1.208	0.03	0.334	0.403
	WCDMA IV	RMC 12.2Kbps	Back	15mm	Ant 1	DSI 2	1413	1732.6	24.68	25.50	1.208	-0.05	0.433	0.523
	WCDMA IV	RMC 12.2Kbps	Front	10mm	Ant 4	DSI 4	1413	1732.6	19.57	20.50	1.239	0.03	0.259	0.321
	WCDMA IV	RMC 12.2Kbps	Back	10mm	Ant 4	DSI 4	1413	1732.6	19.57	20.50	1.239	0.01	0.351	0.435
	WCDMA IV	RMC 12.2Kbps	Front	15mm	Ant 4	DSI 2	1413	1732.6	24.29	24.50	1.050	-0.05	0.465	0.488
35	WCDMA IV	RMC 12.2Kbps	Back	15mm	Ant 4	DSI 2	1413	1732.6	24.29	24.50	1.050	-0.01	0.649	0.681
	WCDMA V	RMC 12.2Kbps	Front	10mm	Ant 1	DSI 3	4182	836.4	24.85	25.50	1.161	-0.08	0.276	0.321
	WCDMA V	RMC 12.2Kbps	Back	10mm	Ant 1	DSI 3	4182	836.4	24.85	25.50	1.161	-0.14	0.330	0.383
	WCDMA V	RMC 12.2Kbps	Front	10mm	Ant 4	DSI 4	4182	836.4	24.41	25.50	1.285	0.13	0.407	0.523
36	WCDMA V	RMC 12.2Kbps	Back	10mm	Ant 4	DSI 4	4182	836.4	24.41	25.50	1.285	-0.03	0.528	0.679



<FDD LTE SAR>

Plot No.	Band	BW (MHz)	Modulation	RB Size	RB offset	Test Position	Gap (mm)	Antenna	Power State	Ch.	Freq. (MHz)	Average Power (dBm)	Tune-Up Limit (dBm)	Tune-up Scaling Factor	Power Drift (dB)	Measured 1g SAR (W/kg)	Reported 1g SAR (W/kg)
	LTE Band 4	20M	QPSK	1	0	Front	10mm	Ant 1	DSI 3	20175	1732.5	22.75	23.00	1.059	0.02	0.378	0.400
	LTE Band 4	20M	QPSK	50	0	Front	10mm	Ant 1	DSI 3	20175	1732.5	22.72	23.00	1.067	-0.12	0.378	0.403
	LTE Band 4	20M	QPSK	1	0	Back	10mm	Ant 1	DSI 3	20175	1732.5	22.75	23.00	1.059	-0.1	0.478	0.506
	LTE Band 4	20M	QPSK	50	0	Back	10mm	Ant 1	DSI 3	20175	1732.5	22.72	23.00	1.067	0.02	0.480	0.512
	LTE Band 4	20M	QPSK	1	0	Front	15mm	Ant 1	DSI 2	20175	1732.5	24.97	25.50	1.130	0.01	0.245	0.277
	LTE Band 4	20M	QPSK	50	0	Front	15mm	Ant 1	DSI 2	20175	1732.5	23.94	24.50	1.138	0.03	0.257	0.292
	LTE Band 4	20M	QPSK	1	0	Back	15mm	Ant 1	DSI 2	20175	1732.5	24.97	25.50	1.130	0.07	0.325	0.367
	LTE Band 4	20M	QPSK	50	0	Back	15mm	Ant 1	DSI 2	20175	1732.5	23.94	24.50	1.138	0.04	0.337	0.383
	LTE Band 4	20M	QPSK	1	0	Front	10mm	Ant 4	DSI 4	20175	1732.5	21.30	22.50	1.318	0.08	0.407	0.537
	LTE Band 4	20M	QPSK	50	0	Front	10mm	Ant 4	DSI 4	20175	1732.5	21.24	22.50	1.337	0.12	0.414	0.553
	LTE Band 4	20M	QPSK	1	0	Back	10mm	Ant 4	DSI 4	20175	1732.5	21.30	22.50	1.318	-0.07	0.585	0.771
37	LTE Band 4	20M	QPSK	50	0	Back	10mm	Ant 4	DSI 4	20175	1732.5	21.24	22.50	1.337	-0.02	0.591	0.790
	LTE Band 4	20M	QPSK	1	0	Front	15mm	Ant 4	DSI 2	20175	1732.5	24.39	25.50	1.291	0.02	0.395	0.510
	LTE Band 4	20M	QPSK	50	0	Front	15mm	Ant 4	DSI 2	20175	1732.5	23.34	24.50	1.306	0.03	0.399	0.521
	LTE Band 4	20M	QPSK	1	0	Back	15mm	Ant 4	DSI 2	20175	1732.5	24.39	25.50	1.291	0.07	0.561	0.724
	LTE Band 4	20M	QPSK	50	0	Back	15mm	Ant 4	DSI 2	20175	1732.5	23.34	24.50	1.306	-0.08	0.577	0.754
	LTE Band 7	20M	QPSK	1	0	Front	10mm	Ant 1	DSI 3	21100	2535	18.68	19.50	1.208	-0.05	0.173	0.209
	LTE Band 7	20M	QPSK	50	0	Front	10mm	Ant 1	DSI 3	21100	2535	18.59	19.50	1.233	-0.12	0.174	0.215
	LTE Band 7	20M	QPSK	1	0	Back	10mm	Ant 1	DSI 3	21100	2535	18.68	19.50	1.208	0.03	0.232	0.280
	LTE Band 7_UL CA	20M	QPSK	1	0	Back	10mm	Ant 1	DSI 3	21100+20902	2535+2515.2	18.63	19.50	1.222	0.02	0.216	0.264
	LTE Band 7	20M	QPSK	50	0	Back	10mm	Ant 1	DSI 3	21100	2535	18.59	19.50	1.233	-0.03	0.213	0.263
	LTE Band 7	20M	QPSK	1	0	Front	15mm	Ant 1	DSI 2	21100	2535	25.02	25.50	1.117	0.02	0.355	0.396
	LTE Band 7	20M	QPSK	50	0	Front	15mm	Ant 1	DSI 2	21100	2535	24.01	24.50	1.119	0.18	0.363	0.406
	LTE Band 7	20M	QPSK	1	0	Back	15mm	Ant 1	DSI 2	21100	2535	25.02	25.50	1.117	0.01	0.467	0.522
	LTE Band 7_UL CA	20M	QPSK	1	0	Back	15mm	Ant 1	DSI 2	21100+20902	2535+2515.2	24.92	25.50	1.143	0.06	0.435	0.497
	LTE Band 7	20M	QPSK	1	0	Front	10mm	Ant 4	DSI 4	21100	2535	19.46	20.50	1.271	-0.06	0.230	0.292
	LTE Band 7	20M	QPSK	50	0	Front	10mm	Ant 4	DSI 4	21100	2535	19.44	20.50	1.276	0.05	0.234	0.299
	LTE Band 7	20M	QPSK	1	0	Back	10mm	Ant 4	DSI 4	21100	2535	19.46	20.50	1.271	-0.15	0.392	0.498
	LTE Band 7_UL CA	20M	QPSK	1	0	Back	10mm	Ant 4	DSI 4	21100+20902	2535+2515.2	19.43	20.50	1.279	0.01	0.361	0.462
	LTE Band 7	20M	QPSK	50	0	Back	10mm	Ant 4	DSI 4	21100	2535	19.44	20.50	1.276	-0.01	0.322	0.411
	LTE Band 7	20M	QPSK	1	0	Front	15mm	Ant 4	DSI 2	21100	2535	22.71	24.00	1.346	0.09	0.271	0.365
	LTE Band 7	20M	QPSK	50	0	Front	15mm	Ant 4	DSI 2	21100	2535	22.65	24.00	1.365	0.03	0.293	0.400
38	LTE Band 7	20M	QPSK	1	0	Back	15mm	Ant 4	DSI 2	21100	2535	22.71	24.00	1.346	-0.07	0.446	0.600
	LTE Band 7_UL CA	20M	QPSK	1	0	Back	15mm	Ant 4	DSI 2	21100+20902	2535+2515.2	22.65	24.00	1.365	0.06	0.419	0.572
	LTE Band 12	10M	QPSK	1	0	Front	10mm	Ant 1	DSI 3	23095	707.5	24.79	25.50	1.178	-0.04	0.110	0.130
	LTE Band 12	10M	QPSK	25	0	Front	10mm	Ant 1	DSI 3	23095	707.5	23.97	24.50	1.130	0.16	0.091	0.103
	LTE Band 12	10M	QPSK	1	0	Back	10mm	Ant 1	DSI 3	23095	707.5	24.79	25.50	1.178	-0.09	0.141	0.166
	LTE Band 12	10M	QPSK	25	0	Back	10mm	Ant 1	DSI 3	23095	707.5	23.97	24.50	1.130	0.07	0.118	0.133
	LTE Band 12	10M	QPSK	1	0	Front	10mm	Ant 4	DSI 4	23095	707.5	24.17	25.50	1.358	0.01	0.143	0.194
	LTE Band 12	10M	QPSK	25	0	Front	10mm	Ant 4	DSI 4	23095	707.5	23.16	24.50	1.361	0.17	0.116	0.158
39	LTE Band 12	10M	QPSK	1	0	Back	10mm	Ant 4	DSI 4	23095	707.5	24.17	25.50	1.358	-0.09	0.181	0.246
	LTE Band 12	10M	QPSK	25	0	Back	10mm	Ant 4	DSI 4	23095	707.5	23.16	24.50	1.361	0.03	0.145	0.197
	LTE Band 13	10M	QPSK	1	0	Front	10mm	Ant 1	DSI 3	23230	782	24.89	25.50	1.151	-0.16	0.106	0.122
	LTE Band 13	10M	QPSK	25	0	Front	10mm	Ant 1	DSI 3	23230	782	23.77	24.50	1.183	-0.15	0.084	0.099
	LTE Band 13	10M	QPSK	1	0	Back	10mm	Ant 1	DSI 3	23230	782	24.89	25.50	1.151	-0.06	0.136	0.157
	LTE Band 13	10M	QPSK	25	0	Back	10mm	Ant 1	DSI 3	23230	782	23.77	24.50	1.183	0.07	0.110	0.130
	LTE Band 13	10M	QPSK	1	0	Front	10mm	Ant 4	DSI 4	23230	782	24.52	25.50	1.253	0.03	0.218	0.273
	LTE Band 13	10M	QPSK	25	0	Front	10mm	Ant 4	DSI 4	23230	782	23.33	24.50	1.309	0.07	0.182	0.238
40	LTE Band 13	10M	QPSK	1	0	Back	10mm	Ant 4	DSI 4	23230	782	24.52	25.50	1.253	-0.05	0.286	0.358
	LTE Band 13	10M	QPSK	25	0	Back	10mm	Ant 4	DSI 4	23230	782	23.33	24.50	1.309	-0.18	0.233	0.305
	LTE Band 26	15M	QPSK	1	0	Front	10mm	Ant 1	DSI 3	26865	831.5	24.83	25.50	1.167	-0.07	0.228	0.266
	LTE Band 26	15M	QPSK	36	0	Front	10mm	Ant 1	DSI 3	26865	831.5	23.67	24.50	1.211	0.1	0.183	0.222



FCC SAR Test Report

Report No. : FA122708

	LTE Band 26	15M	QPSK	1	0	Back	10mm	Ant 1	DSI 3	26865	831.5	24.83	25.50	1.167	-0.07	0.267	0.312
	LTE Band 26	15M	QPSK	36	0	Back	10mm	Ant 1	DSI 3	26865	831.5	23.67	24.50	1.211	0.09	0.210	0.254
	LTE Band 26	15M	QPSK	1	0	Front	10mm	Ant 4	DSI 4	26865	831.5	24.64	25.50	1.219	0.04	0.348	0.424
	LTE Band 26	15M	QPSK	36	0	Front	10mm	Ant 4	DSI 4	26865	831.5	23.57	24.50	1.239	0.1	0.276	0.342
41	LTE Band 26	15M	QPSK	1	0	Back	10mm	Ant 4	DSI 4	26865	831.5	24.64	25.50	1.219	-0.01	0.425	0.518
	LTE Band 26	15M	QPSK	36	0	Back	10mm	Ant 4	DSI 4	26865	831.5	23.57	24.50	1.239	-0.18	0.342	0.424

<TDD LTE SAR>

Plot No.	Band	BW (MHz)	Modulation	RB Size	RB offset	Test Position	Gap (mm)	Antenna	Power State	Ch.	Freq. (MHz)	Average Power (dBm)	Tune-Up Limit (dBm)	Tune-up Scaling Factor	Duty Cycle %	Duty Cycle Scaling Factor	Power Drift (dB)	Measured 1g SAR (W/kg)	Reported 1g SAR (W/kg)
	LTE Band 38	20M	QPSK	1	0	Front	10mm	Ant 1	DSI 3	38000	2595	22.27	23.00	1.183	62.9	1.006	-0.15	0.214	0.255
	LTE Band 38	20M	QPSK	50	0	Front	10mm	Ant 1	DSI 3	38000	2595	22.17	23.00	1.211	62.9	1.006	0.07	0.210	0.256
	LTE Band 38	20M	QPSK	1	0	Back	10mm	Ant 1	DSI 3	38000	2595	22.27	23.00	1.183	62.9	1.006	-0.05	0.269	0.320
	LTE Band 38_UL CA	20M	QPSK	1	0	Back	10mm	Ant 1	DSI 3	38000+2595+38198	2595+2614.8	22.17	23.00	1.211	62.9	1.006	0.13	0.255	0.311
	LTE Band 38	20M	QPSK	50	0	Back	10mm	Ant 1	DSI 3	38000	2595	22.17	23.00	1.211	62.9	1.006	0.07	0.261	0.318
	LTE Band 38	20M	QPSK	1	0	Front	15mm	Ant 1	DSI 2	38000	2595	25.19	25.50	1.074	62.9	1.006	-0.06	0.216	0.233
	LTE Band 38	20M	QPSK	50	0	Front	15mm	Ant 1	DSI 2	38000	2595	24.05	24.50	1.109	62.9	1.006	-0.11	0.219	0.244
	LTE Band 38	20M	QPSK	1	0	Back	15mm	Ant 1	DSI 2	38000	2595	25.19	25.50	1.074	62.9	1.006	0.01	0.278	0.300
	LTE Band 38_UL CA	20M	QPSK	1	0	Back	15mm	Ant 1	DSI 2	38000+2595+38198	2595+2614.8	25.05	25.50	1.109	62.9	1.006	0.03	0.211	0.235
	LTE Band 38	20M	QPSK	1	0	Front	10mm	Ant 4	DSI 4	38000	2595	24.34	25.00	1.164	62.9	1.006	-0.1	0.241	0.282
	LTE Band 38	20M	QPSK	50	0	Front	10mm	Ant 4	DSI 4	38000	2595	23.78	24.50	1.180	62.9	1.006	0.05	0.245	0.291
42	LTE Band 38	20M	QPSK	1	0	Back	10mm	Ant 4	DSI 4	38000	2595	24.34	25.00	1.164	62.9	1.006	0.18	0.414	0.485
	LTE Band 38_UL CA	20M	QPSK	1	0	Back	10mm	Ant 4	DSI 4	38000+2595+38198	2595+2614.8	24.27	25.00	1.183	62.9	1.006	-0.02	0.399	0.475
	LTE Band 38	20M	QPSK	50	0	Back	10mm	Ant 4	DSI 4	38000	2595	23.78	24.50	1.180	62.9	1.006	0.05	0.385	0.457
	LTE Band 38	20M	QPSK	1	0	Front	15mm	Ant 4	DSI 2	38000	2595	24.79	25.50	1.178	62.9	1.006	0.03	0.108	0.128
	LTE Band 38	20M	QPSK	50	0	Front	15mm	Ant 4	DSI 2	38000	2595	23.72	24.50	1.197	62.9	1.006	-0.02	0.089	0.107
	LTE Band 38	20M	QPSK	1	0	Back	15mm	Ant 4	DSI 2	38000	2595	24.79	25.50	1.178	62.9	1.006	0.09	0.187	0.222



<WLAN2.4G SAR>

Plot No.	Band	Mode	Test Position	Gap (mm)	Antenna	Power State	Ch.	Freq. (MHz)	Average Power (dBm)	Tune-Up Limit (dBm)	Tune-up Scaling Factor	Duty Cycle %	Duty Cycle Scaling Factor	Power Drift (dB)	Measured 1g SAR (W/kg)	Reported 1g SAR (W/kg)
	WLAN2.4GHz	802.11b 1Mbps	Front	10mm	Ant 7	Receiver Off	1	2412	17.50	18.50	1.259	100	1.000	-0.07	0.108	0.136
43	WLAN2.4GHz	802.11b 1Mbps	Back	10mm	Ant 7	Receiver Off	1	2412	17.50	18.50	1.259	100	1.000	0.06	0.124	0.156

<WLAN5G SAR>

Plot No.	Band	Mode	Test Position	Gap (mm)	Antenna	Power State	Ch.	Freq. (MHz)	Average Power (dBm)	Tune-Up Limit (dBm)	Tune-up Scaling Factor	Duty Cycle %	Duty Cycle Scaling Factor	Power Drift (dB)	Measured 1g SAR (W/kg)	Reported 1g SAR (W/kg)
	WLAN5.2GHz	802.11n-HT40 MCS0	Front	10mm	Ant 7	Receiver Off	38	5190	15.36	16.50	1.299	96.32	1.038	0.05	0.054	0.073
44	WLAN5.2GHz	802.11n-HT40 MCS0	Back	10mm	Ant 7	Receiver Off	38	5190	15.36	16.50	1.299	96.32	1.038	-0.02	0.177	0.239
	WLAN5.3GHz	802.11n-HT40 MCS0	Front	10mm	Ant 7	Receiver Off	54	5270	15.25	16.50	1.333	96.32	1.038	0.01	0.054	0.075
45	WLAN5.3GHz	802.11n-HT40 MCS0	Back	10mm	Ant 7	Receiver Off	54	5270	15.25	16.50	1.333	96.32	1.038	0.02	0.195	0.270
	WLAN5.5GHz	802.11n-HT40 MCS0	Front	10mm	Ant 7	Receiver Off	134	5670	15.17	16.00	1.210	96.32	1.038	0.12	0.051	0.064
46	WLAN5.5GHz	802.11n-HT40 MCS0	Back	10mm	Ant 7	Receiver Off	134	5670	15.17	16.00	1.210	96.32	1.038	-0.02	0.284	0.357
	WLAN5.8GHz	802.11ac-VHT80 MCS0	Front	10mm	Ant 7	Receiver Off	155	5775	12.10	13.00	1.231	92.77	1.078	0.09	0.029	0.038
47	WLAN5.8GHz	802.11ac-VHT80 MCS0	Back	10mm	Ant 7	Receiver Off	155	5775	12.10	13.00	1.231	92.77	1.078	-0.03	0.117	0.155

<Bluetooth SAR>

Plot No.	Band	Mode	Test Position	Gap (mm)	Antenna	Ch.	Freq. (MHz)	Average Power (dBm)	Tune-Up Limit (dBm)	Tune-up Scaling Factor	Duty Cycle %	Duty Cycle Scaling Factor	Power Drift (dB)	Measured 1g SAR (W/kg)	Reported 1g SAR (W/kg)
	Bluetooth	1Mbps	Front	10mm	Ant 7	39	2441	8.99	10.50	1.417	76.63	1.305	0.02	0.006	0.011
48	Bluetooth	1Mbps	Back	10mm	Ant 7	39	2441	8.99	10.50	1.417	76.63	1.305	-0.01	0.013	0.024



15.4 Product specific 10g SAR

<WLAN5G SAR>

Plot No.	Band	Mode	Test Position	Gap (mm)	Antenna	Power State	Ch.	Freq. (MHz)	Average Power (dBm)	Tune-Up Limit (dBm)	Tune-up Scaling Factor	Duty Cycle %	Duty Cycle Scaling Factor	Power Drift (dB)	Measured 10g SAR (W/kg)	Reported 10g SAR (W/kg)
	WLAN5.3GHz	802.11n-HT40 MCS0	Front	0mm	Ant 7	Receiver Off	54	5270	15.25	16.50	1.333	96.32	1.038	-0.15	0.244	0.338
	WLAN5.3GHz	802.11n-HT40 MCS0	Back	0mm	Ant 7	Receiver Off	54	5270	15.25	16.50	1.333	96.32	1.038	-0.14	0.392	0.542
	WLAN5.3GHz	802.11n-HT40 MCS0	Right Side	0mm	Ant 7	Receiver Off	54	5270	15.25	16.50	1.333	96.32	1.038	0.04	0.328	0.454
49	WLAN5.3GHz	802.11n-HT40 MCS0	Top Side	0mm	Ant 7	Receiver Off	54	5270	15.25	16.50	1.333	96.32	1.038	-0.06	0.445	0.616
	WLAN5.5GHz	802.11n-HT40 MCS0	Front	0mm	Ant 7	Receiver Off	134	5670	15.17	16.00	1.210	96.32	1.038	0.11	0.143	0.180
50	WLAN5.5GHz	802.11n-HT40 MCS0	Back	0mm	Ant 7	Receiver Off	134	5670	15.17	16.00	1.210	96.32	1.038	-0.01	0.491	0.617
	WLAN5.5GHz	802.11n-HT40 MCS0	Right Side	0mm	Ant 7	Receiver Off	134	5670	15.17	16.00	1.210	96.32	1.038	-0.14	0.350	0.440
	WLAN5.5GHz	802.11n-HT40 MCS0	Top Side	0mm	Ant 7	Receiver Off	134	5670	15.17	16.00	1.210	96.32	1.038	-0.09	0.438	0.550

15.5 Repeated SAR Measurement

<1g>

No.	Band	BW (MHz)	Modulation	RB Size	RB offset	Mode	Test Position	Gap (cm)	Antenna	Power State	Ch.	Freq. (MHz)	Average Power (dBm)	Tune-Up Limit (dBm)	Tune-up Scaling Factor	Power Drift (dB)	Measured 1g SAR (W/kg)	Ratio	Reported 1g SAR (W/kg)
1st	GSM850	-	-	-	-	GPRS (4 Tx slots)	Right Cheek	0mm	Ant 4	DSI 1	128	824.2	27.16	28.00	1.213	-0.07	0.871	1	1.057
2nd	GSM850	-	-	-	-	GPRS (4 Tx slots)	Right Cheek	0mm	Ant 4	DSI 1	128	824.2	27.16	28.00	1.213	0.02	0.866	1.006	1.051
1st	LTE Band 7	20M	QPSK	1	0	-	Left Tilted	0mm	Ant 4	DSI 1	20850	2510	18.49	19.00	1.125	-0.16	0.969	1	1.090
2nd	LTE Band 7	20M	QPSK	1	0	-	Left Tilted	0mm	Ant 4	DSI 1	20850	2510	18.49	19.00	1.125	-0.05	0.954	1.016	1.073
1st	LTE Band 13	10M	QPSK	1	0	-	Left Cheek	0mm	Ant 4	DSI 1	23230	782	24.52	25.50	1.253	-0.05	0.843	1	1.056
2nd	LTE Band 13	10M	QPSK	1	0	-	Left Cheek	0mm	Ant 4	DSI 1	23230	782	24.52	25.50	1.253	0.02	0.825	1.022	1.034
1st	WCDMA II	-	-	-	-	RMC 12.2Kbps	Top Side	15mm	Ant 4	DSI 2	9262	1852.4	23.16	23.50	1.081	-0.05	0.971	1	1.050
2nd	WCDMA II	-	-	-	-	RMC 12.2Kbps	Top Side	15mm	Ant 4	DSI 2	9262	1852.4	23.16	23.50	1.081	-0.05	0.965	1.006	1.044
1st	LTE Band 4	20M	QPSK	50	0	-	Bottom Side	10mm	Ant 1	DSI 3	20175	1732.5	22.72	23.00	1.067	-0.11	1.020	1	1.088
2nd	LTE Band 4	20M	QPSK	50	0	-	Bottom Side	10mm	Ant 1	DSI 3	20175	1732.5	22.72	23.00	1.067	-0.11	1.011	1.009	1.078

General Note:

1. Per KDB 865664 D01v01r04, for each frequency band, repeated SAR measurement is required only when the measured SAR is $\geq 0.8W/kg$.
2. Per KDB 865664 D01v01r04, if the ratio among the repeated measurement is ≤ 1.2 and the measured SAR $< 1.45W/kg$, only one repeated measurement is required.
3. Per KDB 865664 D01v01r04, if the extremity repeated SAR is necessary, the same procedures should be adapted for measurements according to extremity and occupational exposure limits by applying a factor of 2.5 for extremity exposure and a factor of 5 for occupational exposure to the corresponding SAR thresholds.
4. The ratio is the difference in percentage between original and repeated *measured SAR*.
5. All measurement SAR result is scaled-up to account for tune-up tolerance and is compliant.

16. Simultaneous Transmission Analysis

No.	Simultaneous Transmission Configurations	Portable Handset			
		Head	Body-worn	Hotspot	Product specific 10g SAR
1.	WWAN + 2.4GHz WLAN	Yes	Yes	Yes	Yes
2.	WWAN + 5GHz WLAN	Yes	Yes	Yes	Yes
3.	WWAN + Bluetooth	Yes	Yes	Yes	Yes
4.	5GHz WLAN + Bluetooth	Yes	Yes	Yes	Yes
5.	WWAN + 5GHz WLAN + Bluetooth	Yes	Yes	Yes	Yes

General Note:

- This device supports VoIP in GPRS, EGPRS, WCDMA and LTE (e.g. for 3rd-party VoIP), LTE supports VoLTE operation.
- EUT will choose each GSM, WCDMA, and LTE according to the network signal condition; therefore, they will not operate simultaneously at any moment.
- This device 2.4GHz WLAN support hotspot operation and Bluetooth support tethering applications.
- This device 2.4GHz WLAN/ 5.2GHz WLAN/5.8GHz WLAN support hotspot operation, and 5.2GHz WLAN/5.8GHz WLAN supports WLAN Direct (GC/GO), and 5.3GHz / 5.5GHz supports WLAN Direct (GC only).
- EUT will choose either WLAN 2.4GHz or WLAN 5GHz according to the network signal condition; therefore, 2.4GHz WLAN and 5GHz WLAN will not operate simultaneously at any moment though they have independent antenna.
- WLAN2.4GHz and Bluetooth share the same antenna, so can't transmit simultaneously.
- According to the character of EUT, WLAN5GHz and Bluetooth can transmit simultaneously.
- For simultaneously analysis, since the SAR summation of 3 transmitters can cover others combination of 2 transmitters, therefore in this section did not additional to evaluate 2TX combination of simultaneously transmission.
- The worst case 5 GHz WLAN SAR for each configuration was used for SAR summation.
- Chose the worst zoom scan SAR of WLAN correspondingly for co-located with WWAN analysis.
- The reported SAR summation is calculated based on the same configuration and test position.
- Per KDB 447498 D01v06, simultaneous transmission SAR is compliant if,
 - 1g Scalar SAR summation < 1.6W/kg and 10g Scalar SAR summation < 4.0W/kg.
 - $SPLSR = (SAR1 + SAR2)^{1.5} / (\text{min. separation distance, mm})$, and the peak separation distance is determined from the square root of $[(x1-x2)^2 + (y1-y2)^2 + (z1-z2)^2]$, where (x1, y1, z1) and (x2, y2, z2) are the coordinates of the extrapolated peak SAR locations in the zoom scan.
 - If $SPLSR \leq 0.04$ for 1g SAR and $SPLSR \leq 0.10$ for 10g SAR, simultaneously transmission SAR measurement is not necessary.
 - Simultaneously transmission SAR measurement, and the reported multi-band 1g SAR < 1.6W/kg and 10g SAR < 4.0W/kg.
- The following chapter 16.1 to 16.3 for transmission simultaneously analysis, always chose the worst SAR among all WWAN bands to do co-located with WLAN and Bluetooth per each test position. For each position, the most conservatively highest SAR among all WWAN bands used to do co-located analysis and they can represent each position, each band SAR scenario.
- Chose WLAN /Bluetooth Front/Back at 10mm as Front/Back at 15 mm SAR to do co-located with WWAN analysis.



16.1 Head Exposure Conditions

WWAN Band	Exposure Position	1	3	6	9	1+2	1+3+4
		WWAN	2.4GHz WLAN Ant 7	5GHz WLAN Ant 7	Bluetooth Ant 7	Summed	Summed
		1g SAR (W/kg)	1g SAR (W/kg)	1g SAR (W/kg)	1g SAR (W/kg)	1g SAR (W/kg)	1g SAR (W/kg)
WWAN All Band	Right Cheek	1.057	0.122	0.292	0.033	1.18	1.38
	Right Tilted	0.721	0.136	0.299	0.023	0.86	1.04
	Left Cheek	1.056	0.514	0.406	0.089	1.57	1.55
	Left Tilted	1.090	0.454	0.407	0.094	1.54	1.59



16.2 Hotspot Exposure Conditions

WWAN Band	Exposure Position	1	2	3	4	1+2	1+3+4
		WWAN	2.4GHz WLAN Ant 7	5GHz WLAN Ant 7	Bluetooth Ant 7	Summed	Summed
		1g SAR (W/kg)	1g SAR (W/kg)	1g SAR (W/kg)	1g SAR (W/kg)	1g SAR (W/kg)	1g SAR (W/kg)
WWAN All Band	Front at 10mm	0.553	0.136	0.073	0.011	0.69	0.64
	Back at 10mm	0.790	0.156	0.239	0.024	0.95	1.05
	Left side at 10mm	0.139				0.14	0.14
	Right side at 10mm	0.257	0.209	0.139	0.018	0.47	0.41
	Top side at 10mm	1.090	0.167	0.248	0.017	1.26	1.36
	Bottom side at 10mm	1.088				1.09	1.09

WWAN Band	Exposure Position	1	2	3	4	1+2	1+3+4
		WWAN	2.4GHz WLAN Ant 7	5GHz WLAN Ant 7	Bluetooth Ant 7	Summed	Summed
		1g SAR (W/kg)	1g SAR (W/kg)	1g SAR (W/kg)	1g SAR (W/kg)	1g SAR (W/kg)	1g SAR (W/kg)
WWAN All Band	Front at 15mm	0.521	0.136	0.073	0.011	0.66	0.61
	Back at 15mm	0.754	0.156	0.239	0.024	0.91	1.02
	Left side at 15mm					0.00	0.00
	Right side at 15mm		0.209	0.139	0.018	0.21	0.16
	Top side at 15mm	1.050	0.167	0.248	0.017	1.22	1.32
	Bottom side at 15mm	1.088				1.09	1.09



16.3 Body-Worn Accessory Exposure Conditions

WWAN Band	Exposure Position	1	2	3	4	1+2	1+3+4
		WWAN	2.4GHz WLAN Ant 7	5GHz WLAN Ant 7	Bluetooth Ant 7	Summed	Summed
		1g SAR (W/kg)	1g SAR (W/kg)	1g SAR (W/kg)	1g SAR (W/kg)	1g SAR (W/kg)	1g SAR (W/kg)
WWAN All Band	Front at 10mm	0.553	0.136	0.075	0.011	0.69	0.64
	Back at 10mm	0.790	0.156	0.357	0.024	0.95	1.17

WWAN Band	Exposure Position	1	2	3	4	1+2	1+3+4
		WWAN	2.4GHz WLAN Ant 7	5GHz WLAN Ant 7	Bluetooth Ant 7	Summed	Summed
		1g SAR (W/kg)	1g SAR (W/kg)	1g SAR (W/kg)	1g SAR (W/kg)	1g SAR (W/kg)	1g SAR (W/kg)
WWAN All Band	Front at 15mm	0.521	0.136	0.075	0.011	0.66	0.61
	Back at 15mm	0.754	0.156	0.357	0.024	0.91	1.14

Test Engineer : Nick Hu, Seven Xu, Hank Chang, Yuankai Kong



17. Uncertainty Assessment

Per KDB 865664 D01 SAR measurement 100MHz to 6GHz, when the highest measured 1-g SAR within a frequency band is < 1.5 W/kg and the measured 10-g SAR within a frequency band is < 3.75 W/kg. The expanded SAR measurement uncertainty must be $\leq 30\%$, for a confidence interval of $k = 2$. If these conditions are met, extensive SAR measurement uncertainty analysis described in IEEE Std 1528-2013 is not required in SAR reports submitted for equipment approval. For this device, the highest measured 1-g SAR is less 1.5W/kg and highest measured 10-g SAR is less 3.75W/kg. Therefore, the measurement uncertainty table is not required in this report.

18. References

- [1] FCC 47 CFR Part 2 "Frequency Allocations and Radio Treaty Matters; General Rules and Regulations"
- [2] ANSI/IEEE Std. C95.1-1992, "IEEE Standard for Safety Levels with Respect to Human Exposure to Radio Frequency Electromagnetic Fields, 3 kHz to 300 GHz", September 1992
- [3] IEEE Std. 1528-2013, "IEEE Recommended Practice for Determining the Peak Spatial-Average Specific Absorption Rate (SAR) in the Human Head from Wireless Communications Devices: Measurement Techniques", Sep 2013
- [4] SPEAG DASY System Handbook
- [5] FCC KDB 865664 D01 v01r04, "SAR Measurement Requirements for 100 MHz to 6 GHz", Aug 2015.
- [6] FCC KDB 865664 D02 v01r02, "RF Exposure Compliance Reporting and Documentation Considerations" Oct 2015.
- [7] FCC KDB 447498 D01 v06, "Mobile and Portable Device RF Exposure Procedures and Equipment Authorization Policies", Oct 2015
- [8] FCC KDB 648474 D04 v01r03, "SAR Evaluation Considerations for Wireless Handsets", Oct 2015.
- [9] FCC KDB 248227 D01 v02r02, "SAR Guidance for IEEE 802.11 (WiFi) Transmitters", Oct 2015.
- [10] FCC KDB 616217 D04 v01r02, "SAR Evaluation Considerations for Laptop, Notebook, Netbook and Tablet Computers", Oct 2015
- [11] FCC KDB 941225 D01 v03r01, "3G SAR MEAUREMENT PROCEDURES", Oct 2015
- [12] FCC KDB 941225 D05 v02r05, "SAR Evaluation Considerations for LTE Devices", Dec 2015
- [13] FCC KDB 941225 D05A v01r02, "Rel. 10 LTE SAR Test Guidance and KDB Inquiries", Oct 2015
- [14] FCC KDB 941225 D06 v02r01, "SAR Evaluation Procedures for Portable Devices with Wireless Router Capabilities", Oct 2015.

-----THE END-----



Appendix A. Plots of System Performance Check

The plots are shown as follows.

System Check_Head_750MHz

DUT: D750V3 - SN:1087

Communication System: UID 0, CW (0); Frequency: 750 MHz; Duty Cycle: 1:1

Medium: HSL_750 Medium parameters used: $f = 750$ MHz; $\sigma = 0.919$ S/m; $\epsilon_r = 43.619$; $\rho = 1000$ kg/m³

Ambient Temperature : 23.2 °C; Liquid Temperature : 22.6 °C

DASY5 Configuration:

- Probe: EX3DV4 - SN3843; ConvF(9.06, 9.06, 9.06); Calibrated: 2020.9.23
- Sensor-Surface: 1.4mm (Mechanical Surface Detection)
- Electronics: DAE4 Sn799; Calibrated: 2021.3.26
- Phantom: SAM Twin Phantom; Type: SAM Twin; Serial: TP-1754
- Measurement SW: DASY52, Version 52.10 (4); SEMCAD X Version 14.6.14 (7483)

Pin=50mW/Area Scan (61x61x1): Interpolated grid: dx=1.500 mm, dy=1.500 mm
Maximum value of SAR (interpolated) = 0.591 W/kg

Pin=50mW/Zoom Scan (5x5x7)/Cube 0: Measurement grid: dx=8mm, dy=8mm, dz=5mm

Reference Value = 26.45 V/m; Power Drift = -0.01 dB

Peak SAR (extrapolated) = 0.671 W/kg

SAR(1 g) = 0.446 W/kg; SAR(10 g) = 0.296 W/kg

Maximum value of SAR (measured) = 0.596 W/kg

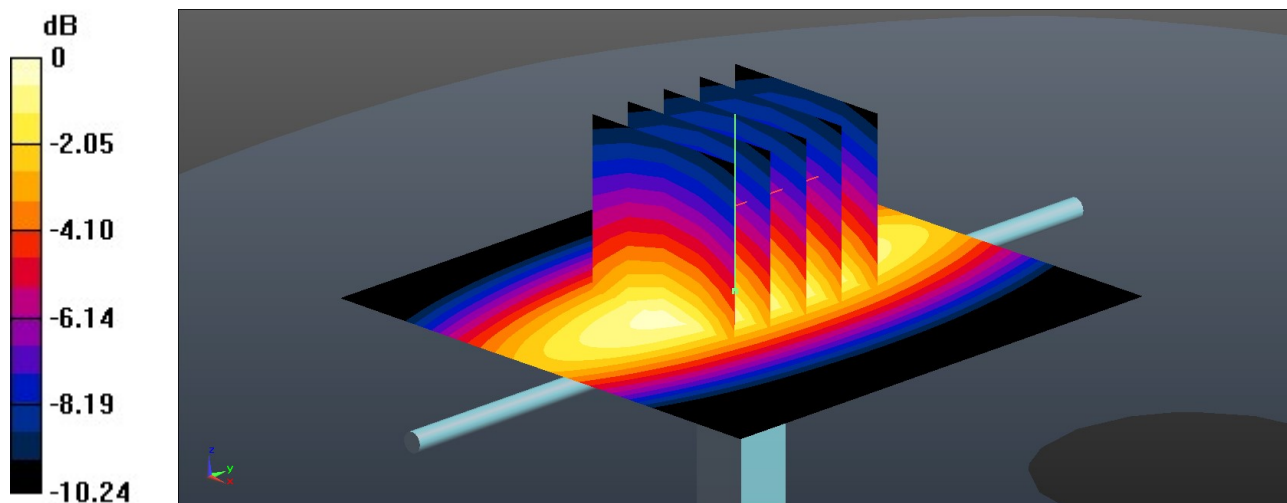

0 dB = 0.596 W/kg = -2.25 dBW/kg

System Check_Head_835MHz

DUT: D835V2 - SN:4d258

Communication System: UID 0, CW (0); Frequency: 835 MHz; Duty Cycle: 1:1

Medium: HSL_835 Medium parameters used: $f = 835$ MHz; $\sigma = 0.929$ S/m; $\epsilon_r = 42.215$; $\rho = 1000$ kg/m³

Ambient Temperature : 23.2 °C; Liquid Temperature : 22.8 °C

DASY5 Configuration:

- Probe: EX3DV4 - SN3843; ConvF(8.69, 8.69, 8.69); Calibrated: 2020.9.23
- Sensor-Surface: 1.4mm (Mechanical Surface Detection)
- Electronics: DAE4 Sn799; Calibrated: 2021.3.26
- Phantom: SAM Twin Phantom; Type: SAM Twin; Serial: TP-1754
- Measurement SW: DASY52, Version 52.10 (4); SEMCAD X Version 14.6.14 (7483)

Pin=50mW/Area Scan (51x51x1): Interpolated grid: dx=1.500 mm, dy=1.500 mm
Maximum value of SAR (interpolated) = 0.745 W/kg

Pin=50mW/Zoom Scan (5x5x7)/Cube 0: Measurement grid: dx=8mm, dy=8mm, dz=5mm

Reference Value = 29.11 V/m; Power Drift = -0.01 dB

Peak SAR (extrapolated) = 0.845 W/kg

SAR(1 g) = 0.512 W/kg; SAR(10 g) = 0.334 W/kg

Maximum value of SAR (measured) = 0.745 W/kg

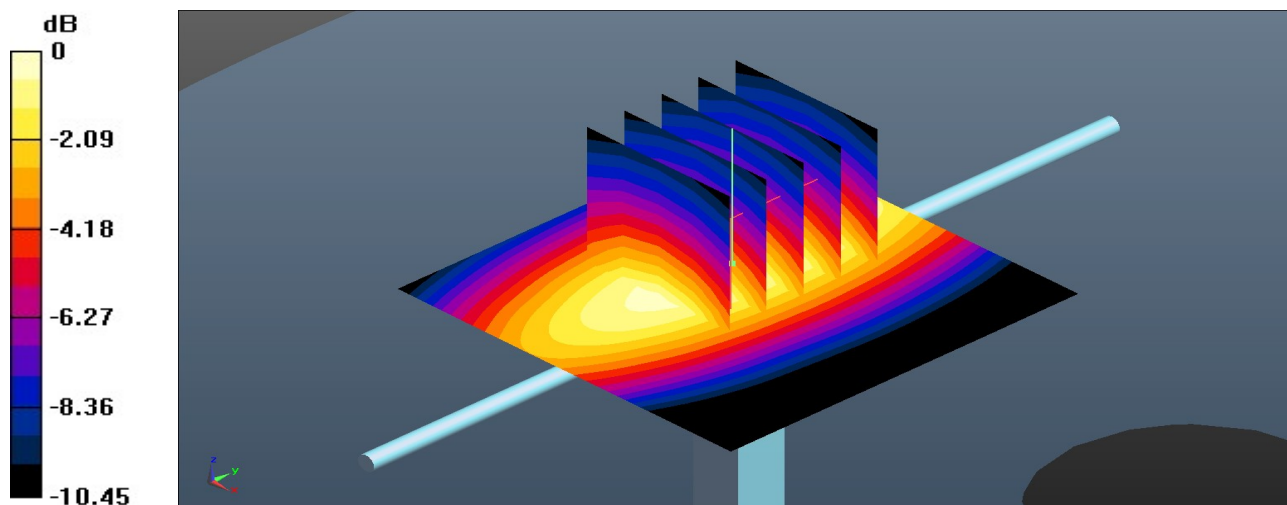

0 dB = 0.745 W/kg = -1.28 dBW/kg

System Check_Head_1750MHz

DUT: D1750V2 - SN:1090

Communication System: UID 0, CW (0); Frequency: 1750 MHz; Duty Cycle: 1:1
Medium: HSL_1750 Medium parameters used: $f = 1750$ MHz; $\sigma = 1.34$ S/m; $\epsilon_r = 40.374$; $\rho = 1000$ kg/m³

Ambient Temperature : 23.1 °C; Liquid Temperature : 22.9 °C

DASY5 Configuration:

- Probe: EX3DV4 - SN3843; ConvF(7.72, 7.72, 7.72); Calibrated: 2020.9.23
- Sensor-Surface: 1.4mm (Mechanical Surface Detection)
- Electronics: DAE4 Sn799; Calibrated: 2021.3.26
- Phantom: SAM Twin Phantom; Type: SAM Twin; Serial: TP-1754
- Measurement SW: DASY52, Version 52.10 (4); SEMCAD X Version 14.6.14 (7483)

Pin=50mW/Area Scan (61x61x1): Interpolated grid: dx=1.500 mm, dy=1.500 mm
Maximum value of SAR (interpolated) = 2.89 W/kg

Pin=50mW/Zoom Scan (5x5x7)/Cube 0: Measurement grid: dx=8mm, dy=8mm, dz=5mm
Reference Value = 44.67 V/m; Power Drift = 0.16 dB
Peak SAR (extrapolated) = 3.54 W/kg
SAR(1 g) = 1.93 W/kg; SAR(10 g) = 1.04 W/kg
Maximum value of SAR (measured) = 2.96 W/kg

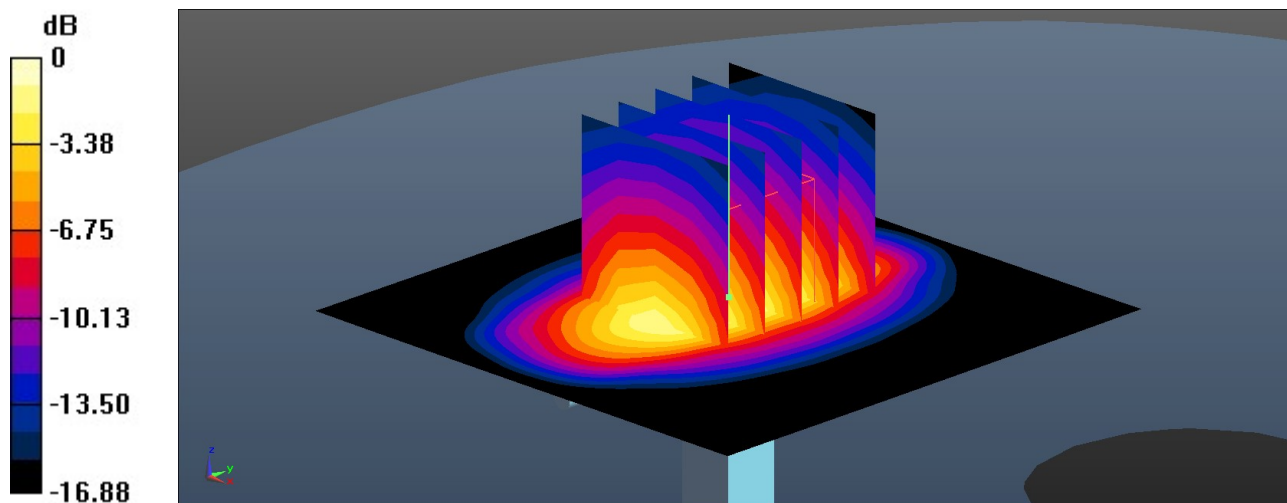

0 dB = 2.96 W/kg = 4.71 dBW/kg

System Check_Head_1900MHz

DUT: D1900V2 - SN:5d170

Communication System: UID 0, CW (0); Frequency: 1900 MHz; Duty Cycle: 1:1
Medium: HSL_1900 Medium parameters used: $f = 1900$ MHz; $\sigma = 1.436$ S/m; $\epsilon_r = 40.147$; $\rho = 1000$ kg/m³

Ambient Temperature : 23.3 °C; Liquid Temperature : 22.7 °C

DASY5 Configuration:

- Probe: EX3DV4 - SN3843; ConvF(7.41, 7.41, 7.41); Calibrated: 2020.9.23
- Sensor-Surface: 1.4mm (Mechanical Surface Detection)
- Electronics: DAE4 Sn799; Calibrated: 2021.3.26
- Phantom: SAM Twin Phantom; Type: SAM Twin; Serial: TP-1754
- Measurement SW: DASY52, Version 52.10 (4); SEMCAD X Version 14.6.14 (7483)

Pin=50mW/Area Scan (51x51x1): Interpolated grid: dx=1.500 mm, dy=1.500 mm
Maximum value of SAR (interpolated) = 3.58 W/kg

Pin=50mW/Zoom Scan (5x5x7)/Cube 0: Measurement grid: dx=8mm, dy=8mm, dz=5mm
Reference Value = 47.96 V/m; Power Drift = 0.12 dB
Peak SAR (extrapolated) = 4.20 W/kg
SAR(1 g) = 2.12 W/kg; SAR(10 g) = 1.11 W/kg
Maximum value of SAR (measured) = 3.52 W/kg

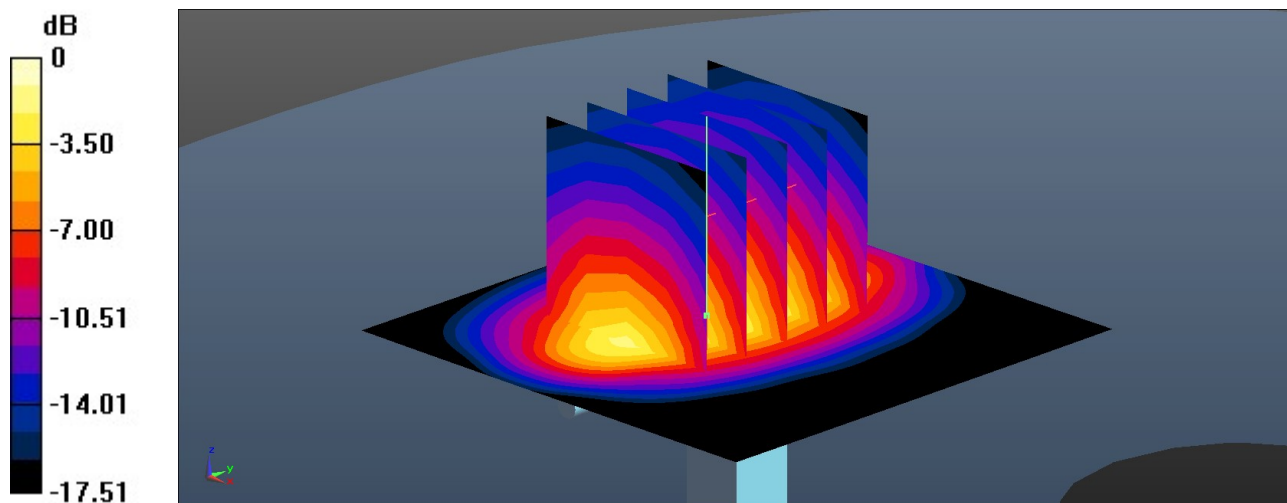

0 dB = 3.52 W/kg = 5.47 dBW/kg

System Check_Head_2450MHz

DUT: D2450V2 - SN:908

Communication System: UID 0, CW (0); Frequency: 2450 MHz; Duty Cycle: 1:1

Medium: HSL_2450 Medium parameters used: $f = 2450$ MHz; $\sigma = 1.872$ S/m; $\epsilon_r = 40.812$; $\rho = 1000$ kg/m³

Ambient Temperature : 23.3 °C; Liquid Temperature : 22.7 °C

DASY5 Configuration:

- Probe: EX3DV4 - SN3843; ConvF(6.85, 6.85, 6.85); Calibrated: 2020.9.23
- Sensor-Surface: 1.4mm (Mechanical Surface Detection)
- Electronics: DAE4 Sn799; Calibrated: 2021.3.26
- Phantom: SAM Twin Phantom; Type: SAM Twin; Serial: TP-1754
- Measurement SW: DASY52, Version 52.10 (4); SEMCAD X Version 14.6.14 (7483)

Pin=50mW/Area Scan (71x71x1): Interpolated grid: dx=1.200 mm, dy=1.200 mm
Maximum value of SAR (interpolated) = 4.74 W/kg

Pin=50mW/Zoom Scan (7x7x7)/Cube 0: Measurement grid: dx=5mm, dy=5mm, dz=5mm
Reference Value = 47.70 V/m; Power Drift = 0.08 dB
Peak SAR (extrapolated) = 5.84 W/kg
SAR(1 g) = 2.77 W/kg; SAR(10 g) = 1.29 W/kg
Maximum value of SAR (measured) = 4.65 W/kg

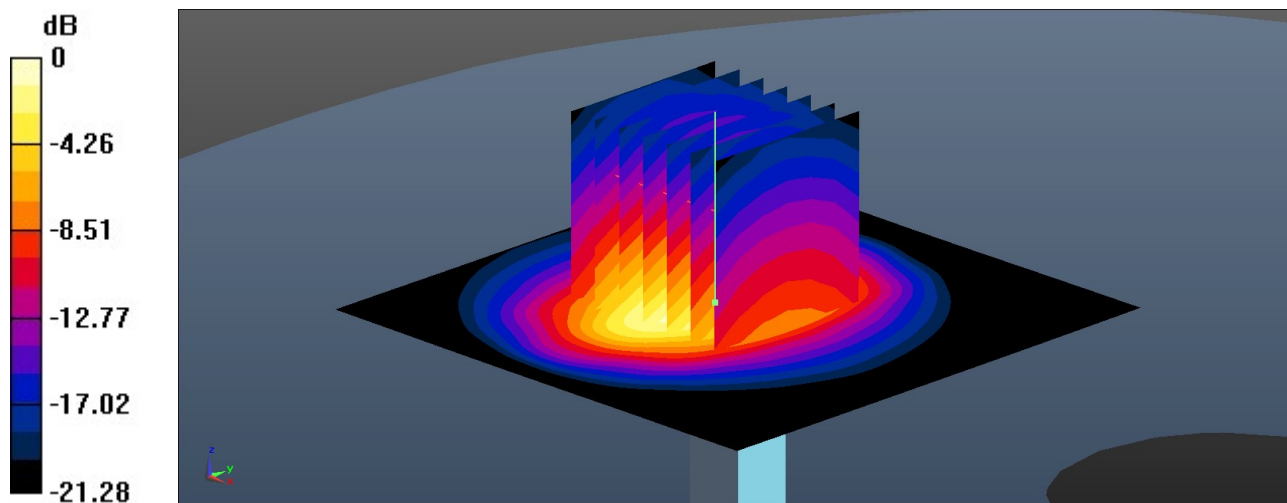

0 dB = 4.65 W/kg = 6.67 dBW/kg

System Check_Head_2600MHz

DUT: D2600V2 - SN:1061

Communication System: UID 0, CW (0); Frequency: 2600 MHz; Duty Cycle: 1:1
Medium: HSL_2600 Medium parameters used: $f = 2600$ MHz; $\sigma = 1.982$ S/m; $\epsilon_r = 40.59$; $\rho = 1000$ kg/m³

Ambient Temperature : 23.2 °C; Liquid Temperature : 22.6 °C

DASY5 Configuration:

- Probe: EX3DV4 - SN3843; ConvF(6.76, 6.76, 6.76); Calibrated: 2020.9.23
- Sensor-Surface: 1.4mm (Mechanical Surface Detection)
- Electronics: DAE4 Sn799; Calibrated: 2021.3.26
- Phantom: SAM Twin Phantom; Type: SAM Twin; Serial: TP-1754
- Measurement SW: DASY52, Version 52.10 (4); SEMCAD X Version 14.6.14 (7483)

Pin=50mW/Area Scan (71x71x1): Interpolated grid: dx=1.200 mm, dy=1.200 mm
Maximum value of SAR (interpolated) = 5.18 W/kg

Pin=50mW/Zoom Scan (7x7x7)/Cube 0: Measurement grid: dx=5mm, dy=5mm, dz=5mm
Reference Value = 43.22 V/m; Power Drift = 0.17 dB
Peak SAR (extrapolated) = 6.29 W/kg
SAR(1 g) = 3.04 W/kg; SAR(10 g) = 1.38 W/kg
Maximum value of SAR (measured) = 5.10 W/kg

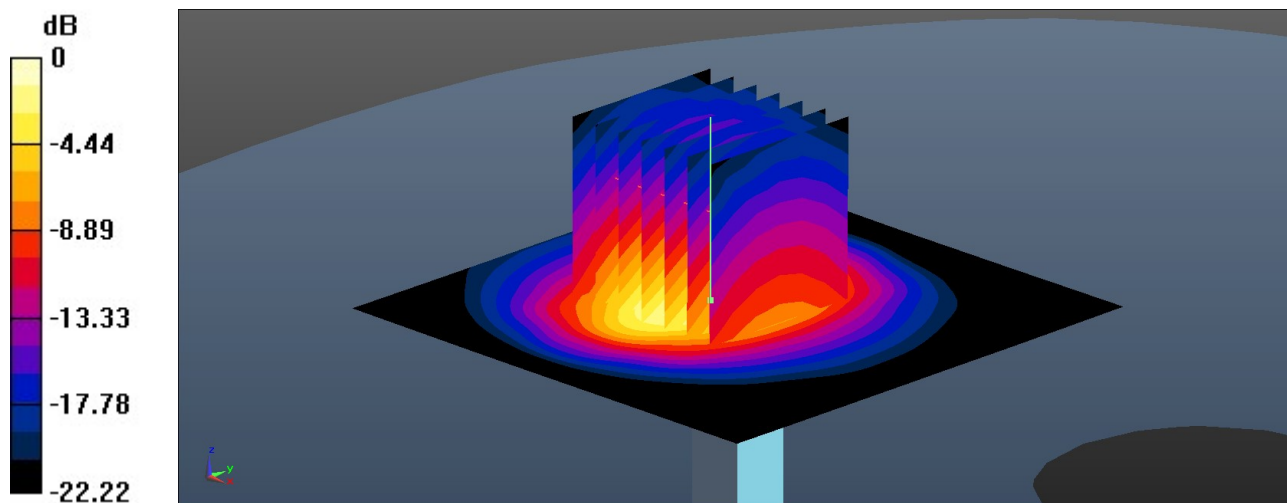

0 dB = 5.10 W/kg = 7.08 dBW/kg

System Check_Head_5250MHz

DUT: D5GHzV2 - SN:1113

Communication System: UID 0, CW (0); Frequency: 5250 MHz; Duty Cycle: 1:1

Medium: HSL_5000 Medium parameters used: $f = 5250$ MHz; $\sigma = 4.593$ S/m; $\epsilon_r = 36.254$; $\rho = 1000$ kg/m³

Ambient Temperature : 23.1 °C; Liquid Temperature : 22.8 °C

DASY5 Configuration:

- Probe: EX3DV4 - SN3843; ConvF(4.66, 4.66, 4.66); Calibrated: 2020.9.23
- Sensor-Surface: 1.4mm (Mechanical Surface Detection)
- Electronics: DAE4 Sn799; Calibrated: 2021.3.26
- Phantom: SAM Twin Phantom; Type: SAM Twin; Serial: TP-1754
- Measurement SW: DASY52, Version 52.10 (4); SEMCAD X Version 14.6.14 (7483)

Pin=50mW/Area Scan (81x81x1): Interpolated grid: dx=1.000 mm, dy=1.000 mm
Maximum value of SAR (interpolated) = 10.0 W/kg

Pin=50mW/Zoom Scan (7x7x7)/Cube 0: Measurement grid: dx=4mm, dy=4mm, dz=1.4mm
Reference Value = 51.32 V/m; Power Drift = 0.01 dB
Peak SAR (extrapolated) = 16.4 W/kg
SAR(1 g) = 4.32 W/kg; SAR(10 g) = 1.24 W/kg
Maximum value of SAR (measured) = 10.6 W/kg

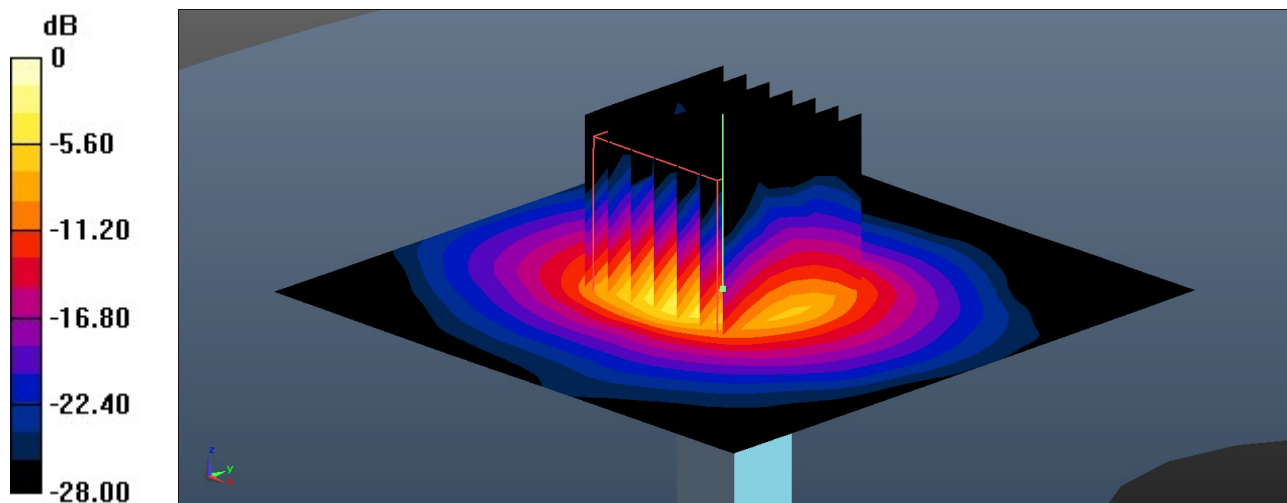

0 dB = 10.6 W/kg = 10.25 dBW/kg

System Check_Head_5600MHz

DUT: D5GHzV2 - SN:1113

Communication System: UID 0, CW (0); Frequency: 5600 MHz; Duty Cycle: 1:1

Medium: HSL_5000 Medium parameters used: $f = 5600$ MHz; $\sigma = 4.985$ S/m; $\epsilon_r = 35.584$; $\rho = 1000$ kg/m³

Ambient Temperature : 23.1 °C; Liquid Temperature : 22.7 °C

DASY5 Configuration:

- Probe: EX3DV4 - SN3843; ConvF(4.3, 4.3, 4.3); Calibrated: 2020.9.23
- Sensor-Surface: 1.4mm (Mechanical Surface Detection)
- Electronics: DAE4 Sn799; Calibrated: 2021.3.26
- Phantom: SAM Twin Phantom; Type: SAM Twin; Serial: TP-1754
- Measurement SW: DASY52, Version 52.10 (4); SEMCAD X Version 14.6.14 (7483)

Pin=50mW/Area Scan (81x81x1): Interpolated grid: dx=1.000 mm, dy=1.000 mm
Maximum value of SAR (interpolated) = 10.9 W/kg

Pin=50mW/Zoom Scan (7x7x7)/Cube 0: Measurement grid: dx=4mm, dy=4mm, dz=1.4mm
Reference Value = 50.75 V/m; Power Drift = 0.01 dB
Peak SAR (extrapolated) = 18.9 W/kg
SAR(1 g) = 4.49 W/kg; SAR(10 g) = 1.27 W/kg
Maximum value of SAR (measured) = 11.4 W/kg

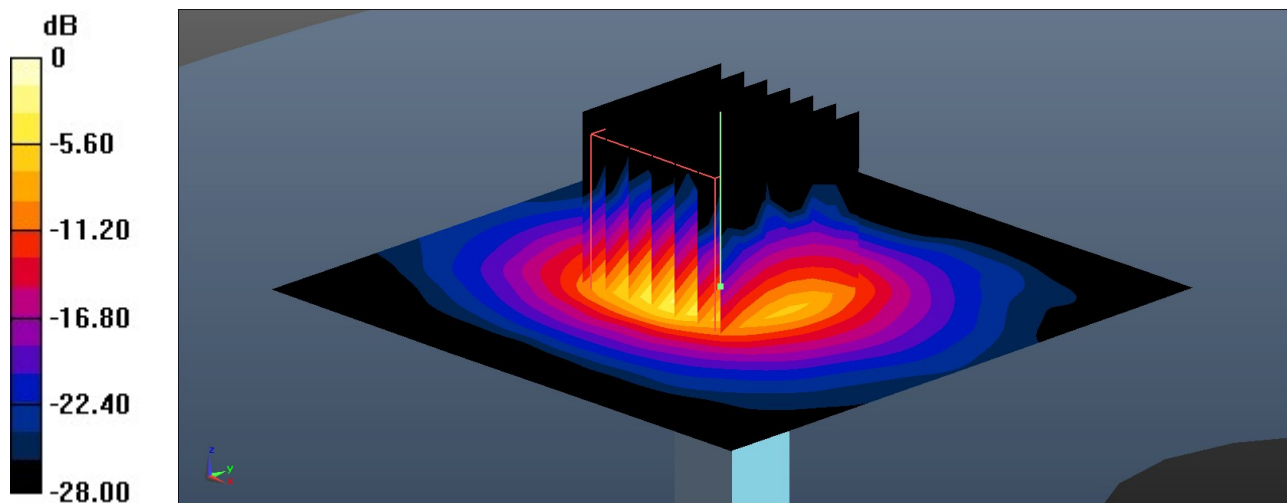

0 dB = 11.4 W/kg = 10.57 dBW/kg

System Check_Head_5750MHz

DUT: D5GHzV2 - SN:1113

Communication System: UID 0, CW (0); Frequency: 5750 MHz; Duty Cycle: 1:1

Medium: HSL_5000 Medium parameters used: $f = 5750$ MHz; $\sigma = 5.144$ S/m; $\epsilon_r = 35.542$; $\rho = 1000$ kg/m³

Ambient Temperature : 23.1 °C; Liquid Temperature : 22.8 °C

DASY5 Configuration:

- Probe: EX3DV4 - SN3843; ConvF(4.35, 4.35, 4.35); Calibrated: 2020.9.23
- Sensor-Surface: 1.4mm (Mechanical Surface Detection)
- Electronics: DAE4 Sn799; Calibrated: 2021.3.26
- Phantom: SAM Twin Phantom; Type: SAM Twin; Serial: TP-1754
- Measurement SW: DASY52, Version 52.10 (4); SEMCAD X Version 14.6.14 (7483)

Pin=50mW/Area Scan (81x81x1): Interpolated grid: dx=1.000 mm, dy=1.000 mm
Maximum value of SAR (interpolated) = 10.3 W/kg

Pin=50mW/Zoom Scan (7x7x7)/Cube 0: Measurement grid: dx=4mm, dy=4mm, dz=1.4mm

Reference Value = 48.06 V/m; Power Drift = 0.02 dB

Peak SAR (extrapolated) = 18.3 W/kg

SAR(1 g) = 4.23 W/kg; SAR(10 g) = 1.19 W/kg

Maximum value of SAR (measured) = 10.9 W/kg

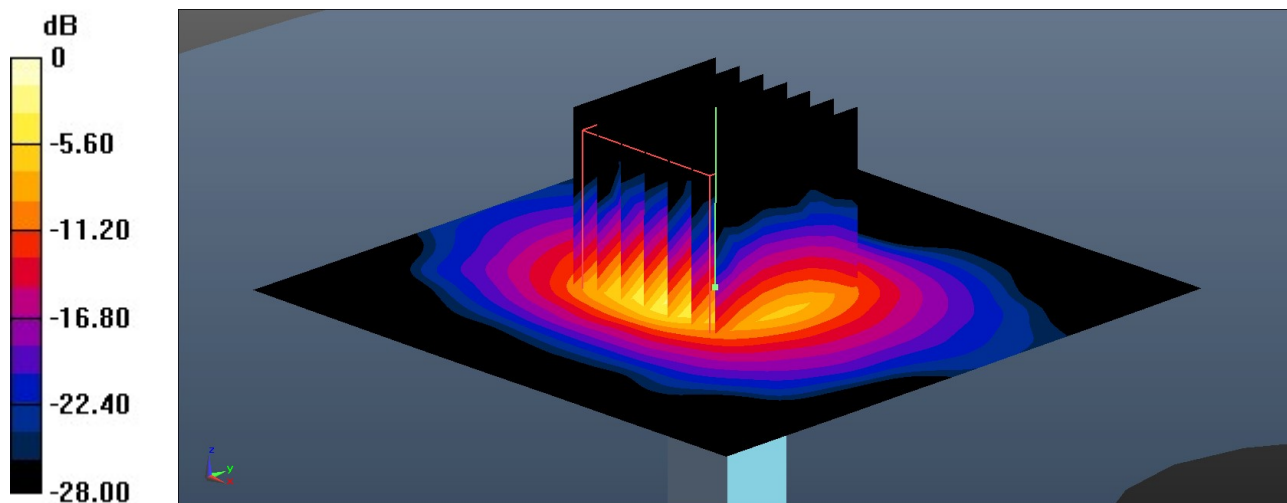

0 dB = 10.9 W/kg = 10.37 dBW/kg



Appendix B. Plots of High SAR Measurement

The plots are shown as follows.

01_GSM 850_GPRS 4 Tx slots_Right Cheek_0mm_Ch128

Communication System: UID 0, GSM850 (0); Frequency: 824.2 MHz; Duty Cycle: 1:2.08
Medium: HSL_835 Medium parameters used: $f = 824.2$ MHz; $\sigma = 0.918$ S/m; $\epsilon_r = 42.334$; $\rho = 1000$ kg/m³
Ambient Temperature : 23.2 °C; Liquid Temperature : 22.8 °C

DASY5 Configuration:

- Probe: EX3DV4 - SN3843; ConvF(8.69, 8.69, 8.69); Calibrated: 2020.9.23
- Sensor-Surface: 1.4mm (Mechanical Surface Detection)
- Electronics: DAE4 Sn799; Calibrated: 2021.3.26
- Phantom: SAM Twin Phantom; Type: SAM Twin; Serial: TP-1754
- Measurement SW: DASY52, Version 52.10 (4); SEMCAD X Version 14.6.14 (7483)

Area Scan (81x101x1): Interpolated grid: dx=1.500 mm, dy=1.500 mm
Maximum value of SAR (interpolated) = 1.21 W/kg

Zoom Scan (5x5x7)/Cube 0: Measurement grid: dx=8mm, dy=8mm, dz=5mm
Reference Value = 36.21 V/m; Power Drift = -0.07 dB
Peak SAR (extrapolated) = 1.88 W/kg
SAR(1 g) = 0.871 W/kg; SAR(10 g) = 0.515 W/kg
Maximum value of SAR (measured) = 1.49 W/kg

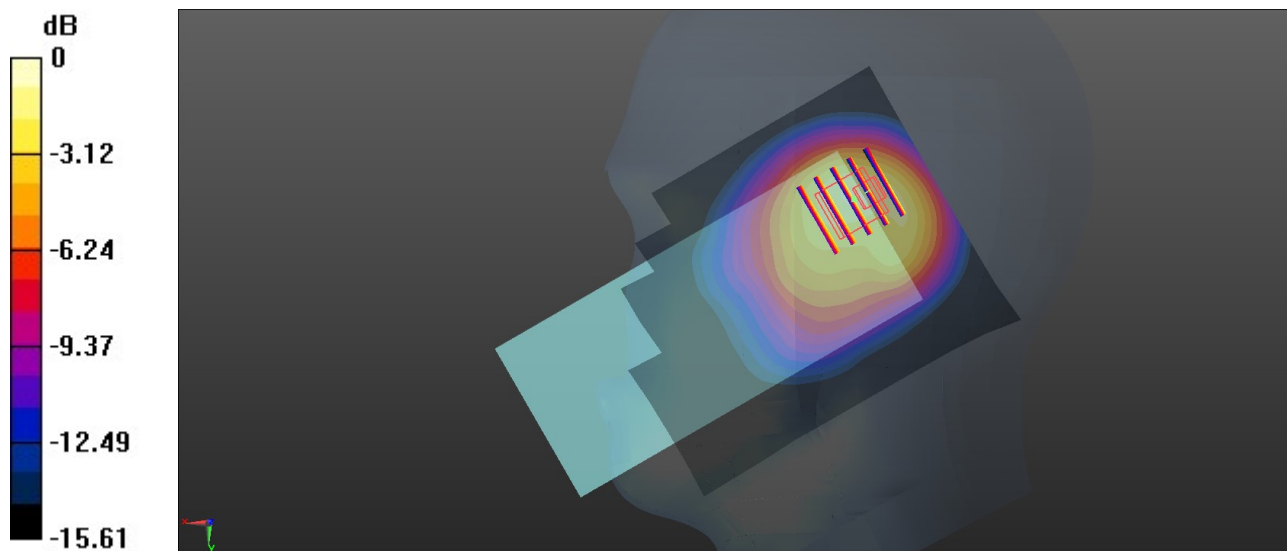

0 dB = 1.49 W/kg = 1.73 dBW/kg