



FCC RF Test Report

APPLICANT : Xiaomi Communications Co., Ltd.
EQUIPMENT : Mobile Phone
BRAND NAME : Redmi
MODEL NAME : XIG02
FCC ID : 2AFZZK19JR
STANDARD : FCC Part 15 Subpart E §15.407
CLASSIFICATION : (NII) Unlicensed National Information Infrastructure
TEST DATE(S) : Apr. 15, 2021 ~ May 25, 2021

We, Sporton International (Kunshan) Inc., would like to declare that the tested sample has been evaluated in accordance with the test procedures and has been in compliance with the applicable technical standards.

The test results in this report apply exclusively to the tested model / sample. Without written approval of Sporton International (Kunshan) Inc., the test report shall not be reproduced except in full.

Jason Jia

Reviewed by: Jason Jia / Supervisor

Alex Wang

Approved by: Alex Wang / Manager



Sporton International (Kunshan) Inc.

**No. 1098, Pengxi North Road, Kunshan Economic Development Zone Jiangsu Province 215300
People's Republic of China**



TABLE OF CONTENTS

REVISION HISTORY..... 3

SUMMARY OF TEST RESULT 4

1 GENERAL DESCRIPTION 5

 1.1 Applicant 5

 1.2 Manufacturer 5

 1.3 Product Feature of Equipment Under Test 5

 1.4 Product Specification of Equipment Under Test 6

 1.5 Modification of EUT 7

 1.6 Testing Location 7

 1.7 Test Software 7

 1.8 Applicable Standards 7

2 TEST CONFIGURATION OF EQUIPMENT UNDER TEST 8

 2.1 Carrier Frequency and Channel 8

 2.2 Test Mode 10

 2.3 Connection Diagram of Test System 12

 2.4 Support Unit used in test configuration and system 12

 2.5 EUT Operation Test Setup 13

 2.6 Measurement Results Explanation Example 13

3 TEST RESULT 14

 3.1 26dB & 99% Occupied Bandwidth Measurement 14

 3.2 Maximum Conducted Output Power Measurement 16

 3.3 Power Spectral Density Measurement 18

 3.4 Unwanted Emissions Measurement 21

 3.5 AC Conducted Emission Measurement 26

 3.6 Automatically Discontinue Transmission 28

 3.7 Antenna Requirements 29

4 LIST OF MEASURING EQUIPMENT 30

5 UNCERTAINTY OF EVALUATION 31

APPENDIX A. CONDUCTED TEST RESULTS

APPENDIX B. AC CONDUCTED EMISSION TEST RESULT

APPENDIX C. RADIATED SPURIOUS EMISSION

APPENDIX D. DUTY CYCLE PLOTS

APPENDIX E. SETUP PHOTOGRAPHS



SUMMARY OF TEST RESULT

Report Section	FCC Rule	Description	Limit	Result	Remark
3.1	2.1049 & 15.403(i)	26dB & 99% Bandwidth	-	Report only	-
3.2	15.407(a)	Maximum Conducted Output Power	≤ 24 dBm	Pass	-
3.3	15.407(a)	Power Spectral Density	≤ 11 dBm	Pass	-
3.4	15.407(b)	Unwanted Emissions	15.407(b) & 15.209(a)	Pass	Under limit 3.13 dB at 10623.62 MHz
3.5	15.207	AC Conducted Emission	15.207(a)	Pass	Under limit 17.92 dB at 0.476 MHz
3.6	15.407(c)	Automatically Discontinue Transmission	Discontinue Transmission	Pass	-
3.7	15.203 & 15.407(a)	Antenna Requirement	15.203	Pass	-

Declaration of Conformity:
The test results with all measurement uncertainty excluded are presented in accordance with the regulation limits or requirements declared by manufacturers.
Comments and Explanations:
The declared of product specification for EUT presented in the report are provided by the manufacturer, and the manufacturer takes all the responsibilities for the accuracy of product specification.



1 General Description

1.1 Applicant

Xiaomi Communications Co., Ltd.

#019, 9th Floor, Building 6, 33 Xi'erqi Middle Road, Haidian District, Beijing, China, 100085

1.2 Manufacturer

Xiaomi Communications Co., Ltd.

#019, 9th Floor, Building 6, 33 Xi'erqi Middle Road, Haidian District, Beijing, China, 100085

1.3 Product Feature of Equipment Under Test

Product Feature	
Equipment	Mobile Phone
Brand Name	Redmi
Model Name	XIG02
FCC ID	2AFZZK19JR
EUT supports Radios application	GSM/WCDMA/LTE/5G NR WLAN 2.4GHz 802.11b/g/n HT20/HT40 WLAN 5GHz 802.11a/n HT20/HT40 WLAN 5GHz 802.11ac VHT20/VHT40/VHT80 Bluetooth BR/EDR/LE FM Receiver, NFC and GNSS
HW Version	P1.1
SW Version	MIUI12.5
EUT Stage	Identical Prototype

Remark: The above EUT's information was declared by manufacturer. Please refer to the specifications or user's manual for more detailed description.



1.4 Product Specification of Equipment Under Test

Standards-related Product Specification	
Tx/Rx Frequency Range	5180 MHz ~ 5240 MHz 5260 MHz ~ 5320 MHz 5500 MHz ~ 5720 MHz
Maximum Output Power to Antenna	<p><5180 MHz ~ 5240 MHz> 802.11a : 15.36 dBm / 0.0344 W 802.11n HT20 : 15.35 dBm / 0.0343 W 802.11n HT40 : 15.36 dBm / 0.0344 W 802.11ac VHT20 : 15.25 dBm / 0.0335 W 802.11ac VHT40 : 15.28 dBm / 0.0337 W 802.11ac VHT80 : 14.00 dBm / 0.0251 W</p> <p><5260 MHz ~ 5320 MHz> 802.11a : 15.07 dBm / 0.0321 W 802.11n HT20 : 15.35 dBm / 0.0343 W 802.11n HT40 : 15.25 dBm / 0.0335 W 802.11ac VHT20 : 15.25 dBm / 0.0335 W 802.11ac VHT40 : 15.17 dBm / 0.0329 W 802.11ac VHT80 : 14.02 dBm / 0.0252 W</p> <p><5500 MHz ~ 5720 MHz > 802.11a : 15.36 dBm / 0.0344 W 802.11n HT20 : 15.12 dBm / 0.0325 W 802.11n HT40 : 15.17 dBm / 0.0329 W 802.11ac VHT20 : 15.06 dBm / 0.0321 W 802.11ac VHT40 : 15.09 dBm / 0.0323 W 802.11ac VHT80 : 14.15 dBm / 0.0260 W</p>
99% Occupied Bandwidth	<p><5180 MHz ~ 5240 MHz> 802.11a : 16.73 MHz 802.11n HT20 : 18.03 MHz 802.11n HT40 : 36.66 MHz 802.11ac VHT80 : 76.36 MHz</p> <p><5260 MHz ~ 5320 MHz> 802.11a : 16.73 MHz 802.11n HT20 : 17.93 MHz 802.11n HT40 : 36.76 MHz 802.11ac VHT80 : 76.48 MHz</p> <p><5500 MHz ~ 5720 MHz > 802.11a : 16.83 MHz 802.11n HT20 : 17.98 MHz 802.11n HT40 : 36.66 MHz 802.11ac VHT80 : 76.36 MHz</p>
Antenna Type / Gain	<p><5150 MHz ~ 5250 MHz> PIFA Antenna with gain 0.74 dBi</p> <p><5250 MHz ~ 5350 MHz> PIFA Antenna with gain 0.74 dBi</p> <p><5470 MHz ~ 5725 MHz> PIFA Antenna with gain 0.82 dBi</p>
Type of Modulation	802.11a/n : OFDM (BPSK / QPSK / 16QAM / 64QAM) 802.11ac : OFDM (BPSK / QPSK / 16QAM / 64QAM / 256QAM)



1.5 Modification of EUT

No modifications are made to the EUT during all test items.

1.6 Testing Location

Sporton International (Kunshan) Inc. is accredited to ISO/IEC 17025:2017 by American Association for Laboratory Accreditation with Certificate Number 5145.02.

Test Firm	Sporton International (Kunshan) Inc.		
Test Site Location	No. 1098, Pengxi North Road, Kunshan Economic Development Zone Jiangsu Province 215300 People's Republic of China TEL : +86-512-57900158 FAX : +86-512-57900958		
Test Site No.	Sporton Site No.	FCC Designation No.	FCC Test Firm Registration No.
	CO01-KS 03CH05-KS TH01-KS	CN1257	314309

1.7 Test Software

Item	Site	Manufacturer	Name	Version
1.	03CH05-KS	AUDIX	E3	6.2009-8-24a1
2.	CO01-KS	AUDIX	E3	6.2009-8-24

1.8 Applicable Standards

According to the specifications of the manufacturer, the EUT must comply with the requirements of the following standards:

- 47 CFR Part 15 Subpart E
- FCC KDB 789033 D02 General UNII Test Procedures New Rules v02r01.
- ANSI C63.10-2013

Remark:

1. All test items were verified and recorded according to the standards and without any deviation during the test.
2. This EUT has also been tested and complied with the requirements of FCC Part 15, Subpart B, recorded in a separate test report.



2 Test Configuration of Equipment Under Test

- a. The EUT has been associated with peripherals and configuration operated in a manner tended to maximize its emission characteristics in a typical application. Frequency range investigated: conduction emission (150 kHz to 30 MHz), radiation emission (9 kHz to the 10th harmonic of the highest fundamental frequency or to 40 GHz, whichever is lower). For radiated measurement, pre-scanned in three orthogonal panels, X, Y, Z. The worst cases (X plane) were recorded in this report.
- b. AC power line Conducted Emission was tested under maximum output power.

2.1 Carrier Frequency and Channel

Frequency Band	Channel	Freq. (MHz)	Channel	Freq. (MHz)
5150-5250 MHz U-NII-1	36	5180	44	5220
	38*	5190	46*	5230
	40	5200	48	5240
	42 [#]	5210		

Frequency Band	Channel	Freq. (MHz)	Channel	Freq. (MHz)
5250-5350 MHz U-NII-2A	52	5260	60	5300
	54*	5270	62*	5310
	56	5280	64	5320
	58 [#]	5290		

Frequency Band	Channel	Freq. (MHz)	Channel	Freq. (MHz)
5470-5725 MHz U-NII-2C	100	5500	112	5560
	102*	5510	116	5580
	104	5520	132	5660
	106 [#]	5530	134*	5670
	108	5540	136	5680
	110*	5550	140	5700



Frequency Band	Channel	Freq. (MHz)	Channel	Freq. (MHz)
TDWR Channel	118*	5590	124	5620
	120	5600	126*	5630
	122 [#]	5610	128	5640

Frequency Band	Channel	Freq. (MHz)	Channel	Freq. (MHz)
Straddle Channel	138 [#]	5690	144	5720
	142*	5710		

Note:

- 1. The above Frequency and Channel in "*" were 802.11n HT40 and 802.11ac VHT40.
- 2. The above Frequency and Channel in "[#]" were 802.11ac VHT80.



2.2 Test Mode

Final test modes are considering the modulation and worse data rates as below table.

For 802.11n HT20 / ac VHT20 and 802.11n HT40 / ac VHT40 mode, the whole testing have assessed only 802.11n HT20/ HT40 by referring to the higher output power.

Single Mode

Modulation	Data Rate
802.11a	6 Mbps
802.11n HT20	MCS0
802.11n HT40	MCS0
802.11ac VHT20	MCS0
802.11ac VHT40	MCS0
802.11ac VHT80	MCS0

Test Cases	
AC Conducted Emission	Mode 1 : GSM 850 Idle + Bluetooth Link + WLAN Link(5G) + USB Cable(Charging from Adapter) + Earphone
Remark: 1. For Radiated Test Cases, The tests were performance with Adapter, Earphone, and USB Cable.	



Ch. #		U-NII-1 : 5150-5250 MHz	U-NII-2A : 5250-5350 MHz	U-NII-2C : 5470-5725MHz
		802.11a	802.11a	802.11a
L	Low	36	52	100
M	Middle	44	60	116
H	High	48	64	140
Straddle		-	-	144

Ch. #		U-NII-1 : 5150-5250 MHz	U-NII-2A : 5250-5350 MHz	U-NII-2C : 5470-5725MHz
		802.11n HT20	802.11n HT20	802.11n HT20
L	Low	36	52	100
M	Middle	44	60	116
H	High	48	64	140
Straddle		-	-	144

Ch. #		U-NII-1 : 5150-5250 MHz	U-NII-2A : 5250-5350 MHz	U-NII-2C : 5470-5725MHz
		802.11n HT40	802.11n HT40	802.11n HT40
L	Low	38	54	102
M	Middle	-	-	110
H	High	46	62	134
Straddle		-	-	142

Ch. #		U-NII-1 : 5150-5250 MHz	U-NII-2A : 5250-5350 MHz	U-NII-2C : 5470-5725MHz
		802.11ac VHT80	802.11ac VHT80	802.11ac VHT80
L	Low	-	-	106
M	Middle	42	58	-
H	High	-	-	122
Straddle		-	-	138

2.3 Connection Diagram of Test System

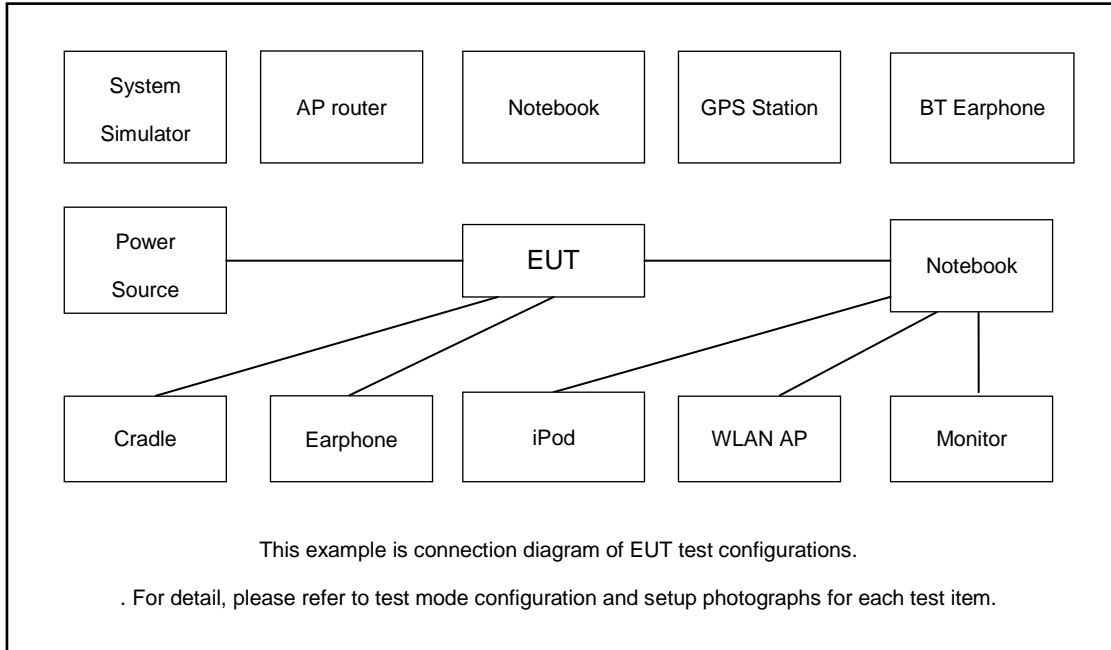

2.4 Support Unit used in test configuration and system

Item	Equipment	Trade Name	Model Name	FCC ID	Data Cable	Power Cord
1.	LTE Base Station	Anritus	MT8821C	N/A	N/A	Unshielded,1.8m
2.	WLAN AP	D-link	DIR-655	KA21R655B1	N/A	Unshielded,1.8m
3.	Notebook	Lenovo	G480	QDS-BRCM1050I	N/A	AC I/P: Unshielded, 1.8 m DC O/P: Shielded, 1.8 m
4.	Bluetooth Earphone	Xiaomi	LYEJ02LM	N/A	N/A	N/A
5.	SD Card	Kingston	8GB	N/A	N/A	N/A



2.5 EUT Operation Test Setup

For WLAN RF test items, an engineering test program was provided and enabled to make EUT continuous transmit/receive.

For AC power line conducted emissions, the EUT was set to connect with the WLAN AP under large package sizes transmission.

2.6 Measurement Results Explanation Example

For all conducted test items:

The offset level is set in the spectrum analyzer to compensate the RF cable loss and attenuator factor between EUT conducted output port and spectrum analyzer. With the offset compensation, the spectrum analyzer reading level is exactly the EUT RF output level.

Example :

The spectrum analyzer offset is derived from RF cable loss and attenuator factor.

Offset = RF cable loss + attenuator factor.

Following shows an offset computation example with cable loss 12.8 dB and 10dB attenuator.

$$\begin{aligned} \text{Offset(dB)} &= \text{RF cable loss(dB)} + \text{attenuator factor(dB)}. \\ &= 12.8 + 10 = 22.8 \text{ (dB)} \end{aligned}$$

3 Test Result

3.1 26dB & 99% Occupied Bandwidth Measurement

3.1.1 Description of 26dB & 99% Occupied Bandwidth

This section is for reporting purpose only.

There is no restriction limits for bandwidth.

For Straddle Channel, According to KDB 789033 D02 General UNII Test Procedures New Rules v02r01, If the power and PSD of the devices are uniform and comply with the lower limits specified for the U-NII-2 bands, a single measurement over the entire emission bandwidth can be performed to show compliance.

3.1.2 Measuring Instruments

The measuring equipment is listed in the section 4 of this test report.

3.1.3 Test Procedures

1. The testing follows FCC KDB 789033 D02 General UNII Test Procedures New Rules v02r01. Section C) Emission bandwidth
2. Set RBW = approximately 1% of the emission bandwidth.
3. Set the VBW > RBW.
4. Detector = Peak.
5. Trace mode = max hold
6. Measure the maximum width of the emission that is 26 dB down from the peak of the emission. Compare this with the RBW setting of the analyzer. Readjust RBW and repeat measurement as needed until the RBW/EBW ratio is approximately 1%.
7. For 99% Bandwidth Measurement, the spectrum analyzer's resolution bandwidth (RBW) is set 1MHz and set the Video bandwidth (VBW) $\geq 3 * RBW$.
8. Measure and record the results in the test report.

3.1.4 Test Setup

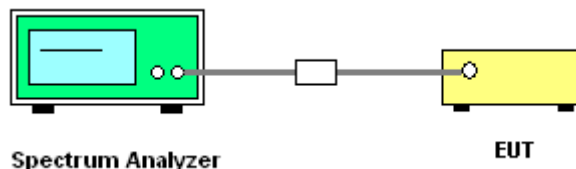

3.1.5 Test Result of 26dB & 99% Occupied Bandwidth

Please refer to Appendix A.

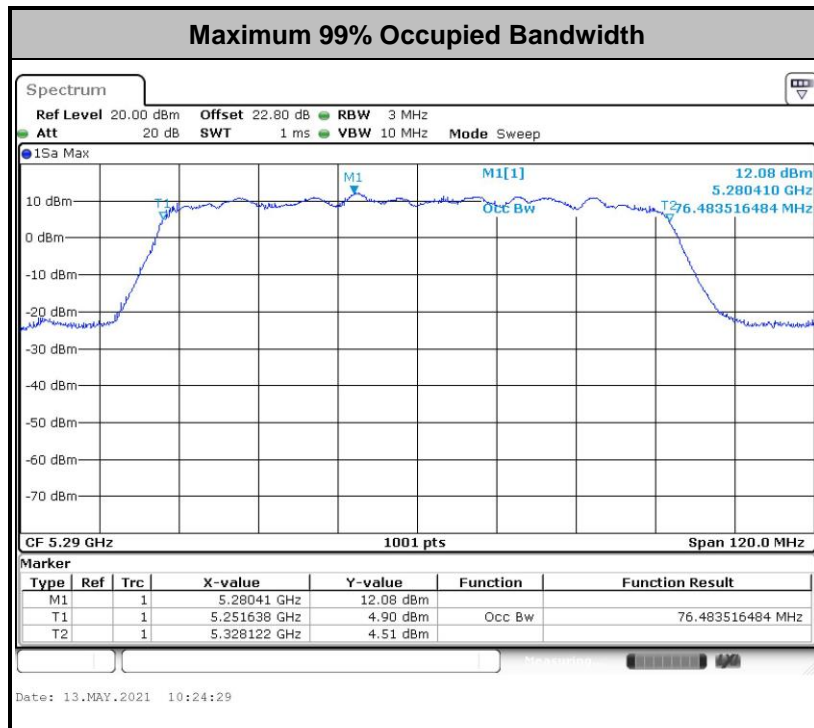
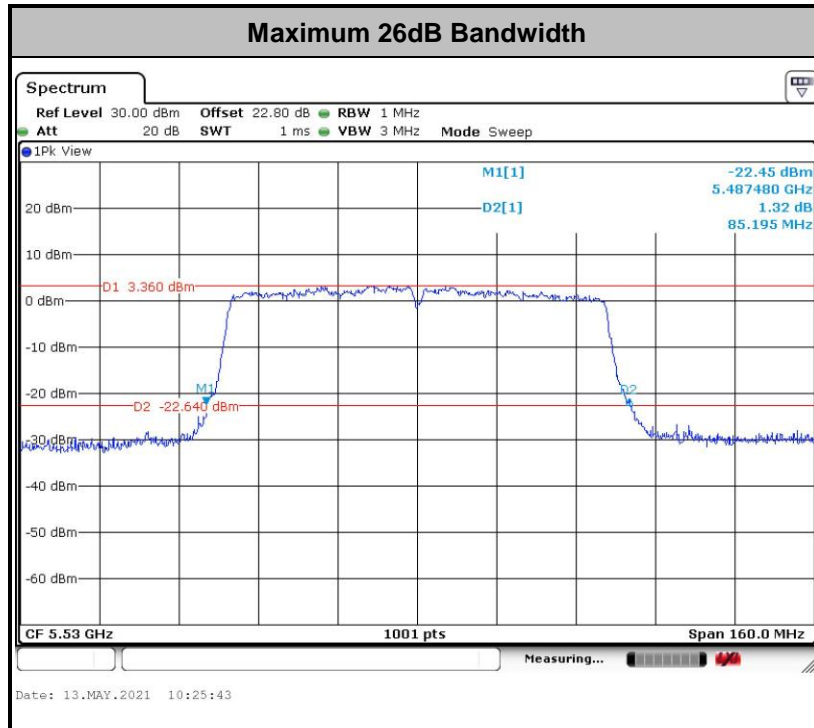

Note: The occupied channel bandwidth is maintained within the band of operation for all of the modulations.
 all of the modulations.



3.2 Maximum Conducted Output Power Measurement

3.2.1 Limit of Maximum Conducted Output Power

<FCC 14-30 CFR 15.407>

For mobile and portable client devices in the 5.15–5.25 GHz band, the maximum conducted output power over the frequency band of operation shall not exceed 250 mW.

For the 5.25–5.35 GHz bands, the maximum conducted output power over the frequency bands of operation shall not exceed the lesser of 250 mW or 11 dBm $10 \log B$, where B is the 26 dB emission bandwidth in megahertz.

For the 5.47–5.725 GHz band, the maximum conducted output power shall not exceed 250 mW or 11 + $10 \log_{10} B$, dBm, whichever power is less. The maximum e.i.r.p. shall not exceed 1.0 W or 17 + $10 \log_{10} B$, dBm, whichever is less. B is the 99% emission bandwidth in megahertz.

For Straddle Channel, According to KDB 789033 D02 General UNII Test Procedures New Rules v02r01, If the power and PSD of the devices are uniform and comply with the lower limits specified for the U-NII-2 bands, a single measurement over the entire emission bandwidth can be performed to show compliance.

If transmitting antennas of directional gain greater than 6 dBi are used, the peak output power shall be reduced by the amount in dB that the directional gain of the antenna exceeds 6 dBi.

Note that U-NII-2 band, devices with a maximum e.i.r.p. greater than 500 mW shall implement TPC in order to have the capability to operate at least 6 dB below the maximum permitted e.i.r.p. of 1 W.

3.2.2 Measuring Instruments

The measuring equipment is listed in the section 4 of this test report.

3.2.3 Test Procedures

The testing follows Method PM of FCC KDB 789033 D02 General UNII Test Procedures New Rules v02r01.

Method PM (Measurement using an RF average power meter):

1. Measurement is performed using a wideband RF power meter.
2. The EUT is configured to transmit continuously with a consistent duty cycle at its maximum power control level.
3. Measure the average power of the transmitter, and the average power is corrected with duty factor, $10 \log(1/x)$, where x is the duty cycle.

For Straddle Channel, According to KDB 789033 D02 General UNII Test Procedures New Rules v02r01, If the power and PSD of the devices are uniform and comply with the lower limits specified for the U-NII-2 bands, a single measurement over the entire emission bandwidth can be performed to show compliance.

3.2.4 Test Setup

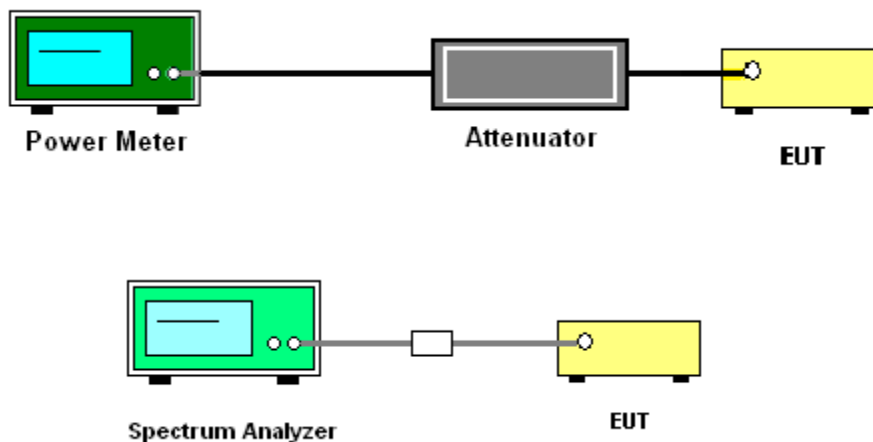

3.2.5 Test Result of Maximum Conducted Output Power

Please refer to Appendix A.



3.3 Power Spectral Density Measurement

3.3.1 Limit of Power Spectral Density

<FCC 14-30 CFR 15.407>

For mobile and portable client devices in the 5.15–5.25 GHz band, the maximum power spectral density shall not exceed 11dBm in any 1 megahertz band.

For the 5.25–5.725 GHz bands, the maximum power spectral density shall not exceed 11 dBm in any 1 megahertz band.

For Straddle Channel, According to KDB 789033 D02 General UNII Test Procedures New Rules v02r01, If the power and PSD of the devices are uniform and comply with the lower limits specified for the U-NII-2 bands, a single measurement over the entire emission bandwidth can be performed to show compliance.

If transmitting antennas of directional gain greater than 6 dBi are used, the peak output power shall be reduced by the amount in dB that the directional gain of the antenna exceeds 6 dBi.

3.3.2 Measuring Instruments

The measuring equipment is listed in the section 4 of this test report.

3.3.3 Test Procedures

The testing follows FCC KDB 789033 D02 General UNII Test Procedures New Rules v02r01.
Section F) Maximum power spectral density.

Method SA-2

(trace averaging across on and off times of the EUT transmissions, followed by duty cycle correction).

- Measure the duty cycle.
 - Set span to encompass the entire emission bandwidth (EBW) of the signal.
 - Set RBW = 1 MHz.
 - Set VBW \geq 3 MHz.
 - Number of points in sweep \geq 2 Span / RBW.
 - Sweep time = auto.
 - Detector = RMS
 - Trace average at least 100 traces in power averaging mode.
 - Add $10 \log(1/x)$, where x is the duty cycle, to the measured power in order to compute the average power during the actual transmission times. For example, add $10 \log(1/0.25) = 6$ dB if the duty cycle is 25 percent.
1. The RF output of EUT was connected to the spectrum analyzer by a low loss cable.
 2. Each plot has already offset with cable loss, and attenuator loss. Measure the PPSD and record it.

3.3.4 Test Setup

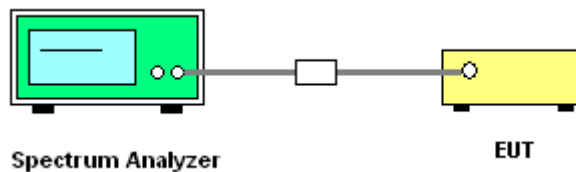

3.3.5 Test Result of Power Spectral Density

Please refer to Appendix A.

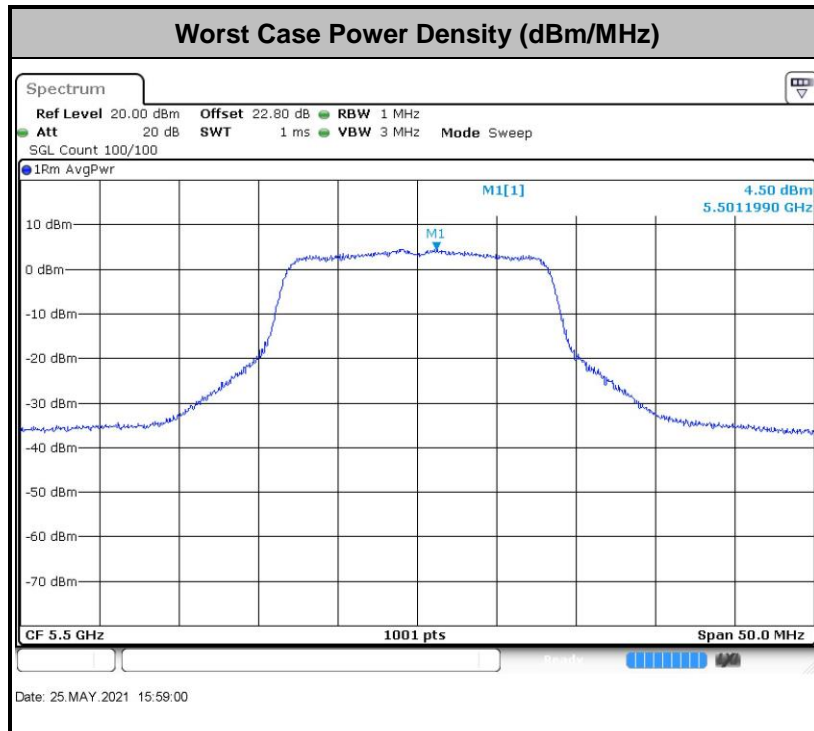

Note: Average Power Density (dB) = Measured value+ Duty Factor



3.4 Unwanted Emissions Measurement

This section is to measure unwanted emissions through radiated measurement for band edge spurious emissions and out of band emissions measurement.

3.4.1 Limit of Unwanted Emissions

- (1) For transmitters operating in the 5150-5250 MHz band: all emissions outside of the 5150-5350 MHz band shall not exceed an EIRP of -27dBm/MHz.

For transmitters operating in the 5250-5350 MHz band: all emissions outside of the 5150-5350 MHz band shall not exceed an EIRP of -27 dBm/MHz. Devices operating in the 5250-5350 MHz band that generate emissions in the 5150-5250 MHz band must meet all applicable technical requirements for operation in the 5150-5250 MHz band (including indoor use) or alternatively meet an out-of-band emission EIRP limit of -27 dBm/MHz in the 5150-5250 MHz band.

- (2) Unwanted spurious emissions fallen in restricted bands shall comply with the general field strength limits as below table,

Frequency (MHz)	Field Strength (microvolts/meter)	Measurement Distance (meters)
0.009 – 0.490	2400/F(kHz)	300
0.490 – 1.705	24000/F(kHz)	30
1.705 – 30.0	30	30
30 – 88	100	3
88 – 216	150	3
216 - 960	200	3
Above 960	500	3



EIRP (dBm)	Field Strength at 3m (dBµV/m)
- 27	68.2

Note: The following formula is used to convert the EIRP to field strength.

$$EIRP = E_{Meas} + 20\log (d_{Meas}) - 104.7$$

where

EIRP is the equivalent isotropically radiated power, in dBm

E_{Meas} is the field strength of the emission at the measurement distance, in dBµV/m

d_{Meas} is the measurement distance, in m

3.4.2 Measuring Instruments

The measuring equipment is listed in the section 4 of this test report.



3.4.3 Test Procedures

1. The testing follows FCC KDB 789033 D02 General UNII Test Procedures New Rules v02r01. Section G) Unwanted emissions measurement.
 - (1) Procedure for Unwanted Emissions Measurements Below 1000MHz
 - RBW = 120 kHz
 - VBW = 300 kHz
 - Detector = Peak
 - Trace mode = max hold
 - (2) Procedure for Peak Unwanted Emissions Measurements Above 1000 MHz
 - RBW = 1 MHz
 - VBW \geq 3 MHz
 - Detector = Peak
 - Sweep time = auto
 - Trace mode = max hold
 - (3) Procedures for Average Unwanted Emissions Measurements Above 1000MHz
 - RBW = 1 MHz
 - VBW = 10 Hz, when duty cycle is no less than 98 percent.
 - VBW \geq 1/T, when duty cycle is less than 98 percent where T is the minimum transmission duration over which the transmitter is on and is transmitting at its maximum power control level for the tested mode of operation.
2. The EUT was placed on a turntable with 0.8 meter for frequency below 1GHz and 1.5 meter for frequency above 1GHz respectively above ground.
3. The EUT was set 3 meters from the interference receiving antenna which was mounted on the top of a variable height antenna tower.
4. The antenna is a broadband antenna and its height is adjusted between one meter and four meters above ground to find the maximum value of the field strength for both horizontal polarization and vertical polarization of the antenna.
5. For each suspected emission, the EUT was arranged to its worst case and then adjust the antenna tower (from 1 m to 4 m) and turntable (from 0 degree to 360 degrees) to find the maximum reading.
6. For testing below 1GHz, if the emission level of the EUT in peak mode was 3 dB lower than the limit specified, then peak values of EUT will be reported, otherwise, the emissions will be repeated one by one using the CISPR quasi-peak method and reported.
7. For testing above 1GHz, the emission level of the EUT in peak mode was 20dB lower than peak limit (that means the emission level in average mode also complies with the limit in average mode), then peak values of EUT will be reported, otherwise, the emissions will be measured in average mode again and reported.

3.4.4 Test Setup

For radiated emissions below 30MHz

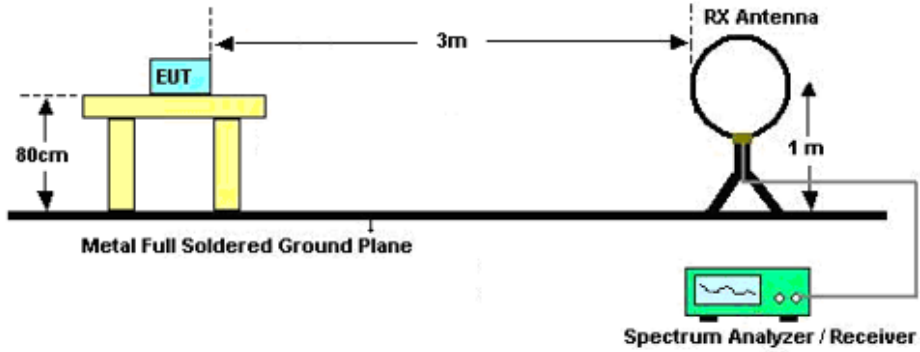

For radiated emissions from 30MHz to 1GHz

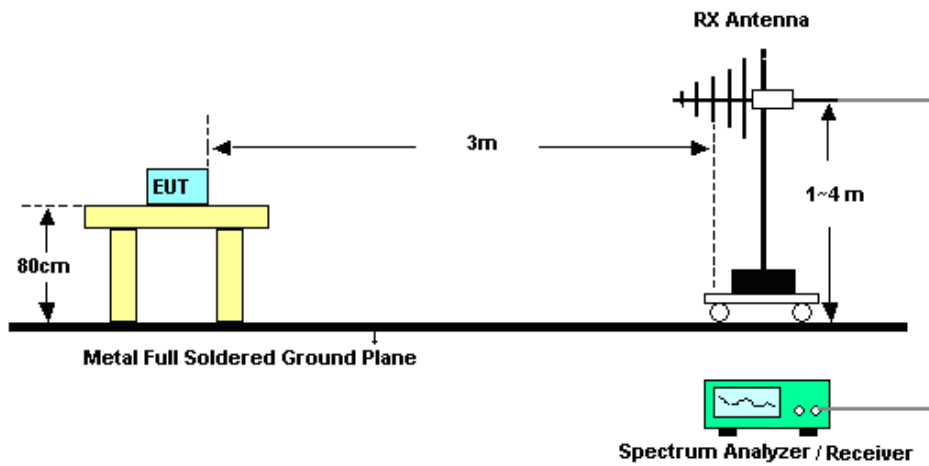

For radiated emissions above 1GHz

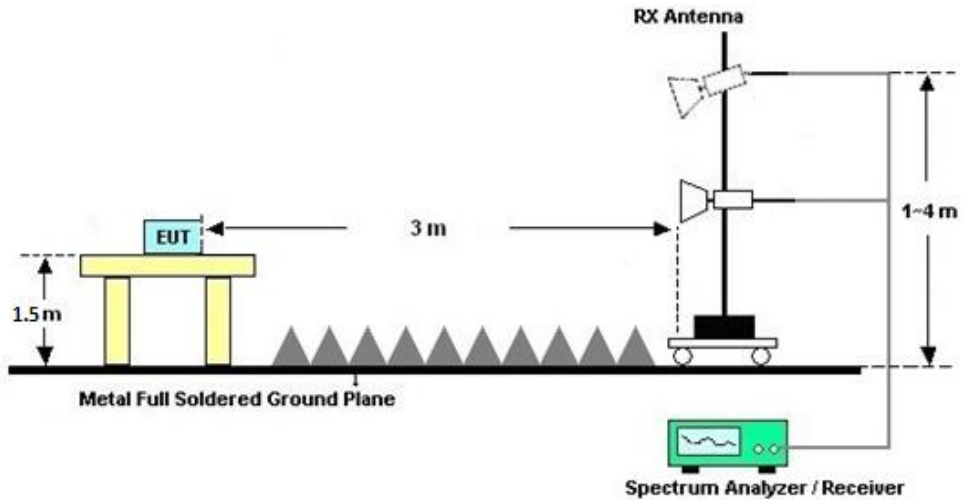

3.4.5 Test Results of Radiated Spurious Emissions (9 kHz ~ 30 MHz)

The low frequency, which started from 9 kHz to 30MHz, was pre-scanned and the result which was 20dB lower than the limit line was not reported.

There is a comparison data of both open-field test site and semi-Anechoic chamber, and the result came out very similar.

3.4.6 Test Result of Radiated Spurious at Band Edges

Please refer to Appendix C.

3.4.7 Duty Cycle

Please refer to Appendix D.

3.4.8 Test Result of Radiated Spurious Emissions (30MHz ~ 10th Harmonic or 40GHz, whichever is lower)

Please refer to Appendix C.



3.5 AC Conducted Emission Measurement

3.5.1 Limit of AC Conducted Emission

For equipment that is designed to be connected to the public utility (AC) power line, the radio frequency voltage that is conducted back onto the AC power line on any frequency or frequencies within the band 150 kHz to 30 MHz shall not exceed the limits in the following table.

Frequency of emission (MHz)	Conducted limit (dBµV)	
	Quasi-peak	Average
0.15-0.5	66 to 56*	56 to 46*
0.5-5	56	46
5-30	60	50

*Decreases with the logarithm of the frequency.

3.5.2 Measuring Instruments

The measuring equipment is listed in the section 4 of this test report.

3.5.3 Test Procedures

1. The EUT was placed 0.4 meter from the conducting wall of the shielding room was kept at least 80 centimeters from any other grounded conducting surface.
2. Connect EUT to the power mains through a line impedance stabilization network (LISN).
3. All the support units are connecting to the other LISN.
4. The LISN provides 50 ohm coupling impedance for the measuring instrument.
5. The FCC states that a 50 ohm, 50 microhenry LISN should be used.
6. Both sides of AC line were checked for maximum conducted interference.
7. The frequency range from 150 kHz to 30 MHz was searched.
8. Set the test-receiver system to Peak Detect Function and specified bandwidth with Maximum Hold Mode.

3.5.4 Test Setup

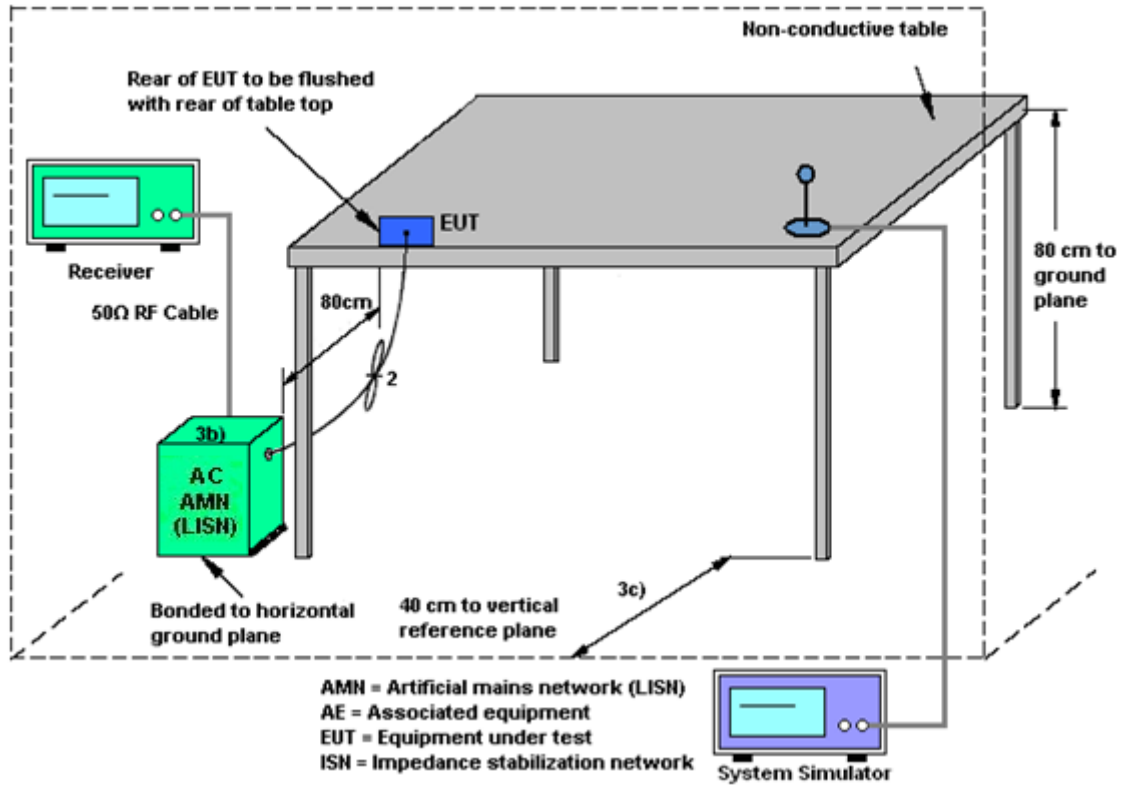

3.5.5 Test Result of AC Conducted Emission

Please refer to Appendix B.



3.6 Automatically Discontinue Transmission

3.6.1 Limit of Automatically Discontinue Transmission

The device shall automatically discontinue transmission in case of either absence of information to transmit or operational failure. These provisions are not intended to preclude the transmission of control or signaling information or the use of repetitive codes used by certain digital technologies to complete frame or burst intervals. Applicants shall include in their application for equipment authorization to describe how this requirement is met.

3.6.2 Measuring Instruments

The measuring equipment is listed in the section 4 of this test report.

3.6.3 Test Result of Automatically Discontinue Transmission

While the EUT is not transmitting any information, the EUT can automatically discontinue transmission and become standby mode for power saving. The EUT can detect the controlling signal of ACK message transmitting from remote device and verify whether it shall resend or discontinue transmission.



3.7 Antenna Requirements

3.7.1 Standard Applicable

If transmitting antenna directional gain is greater than 6 dBi, both the peak transmit power and the peak power spectral density shall be reduced by the amount in dB that the directional gain of the antenna exceeds 6 dBi.

3.7.2 Antenna Anti-Replacement Construction

An embedded-in antenna design is used.

3.7.3 Antenna Gain

The antenna peak gain of EUT is less than 6 dBi. Therefore, it is not necessary to reduce maximum peak output power limit.



4 List of Measuring Equipment

Instrument	Manufacturer	Model No.	Serial No.	Characteristics	Calibration Date	Test Date	Due Date	Remark
Spectrum Analyzer	R&S	FSV40	101040	10Hz~40GHz	Nov. 01, 2020	Apr. 15, 2021~ May 25, 2021	Oct. 31, 2021	Conducted (TH01-KS)
Pulse Power Sensor	Anritsu	MA2411B	0917070	300MHz~40GHz	Jan. 07, 2021	Apr. 15, 2021~ May 25, 2021	Jan. 06, 2022	Conducted (TH01-KS)
Power Meter	Anritsu	ML2495A	1005002	50MHz Bandwidth	Jan. 07, 2021	Apr. 15, 2021~ May 25, 2021	Jan. 06, 2022	Conducted (TH01-KS)
EMI Test Receiver	Keysight	N9038A	MY56400004	3Hz~8.5GHz;Max 30dBm	Oct. 17, 2020	May 12, 2021	Oct. 16, 2021	Radiation (03CH05-KS)
EXA Spectrum Analyzer	Keysight	N9010A	MY55150244	10Hz~44G,MAX 30dB	Apr.13, 2021	May 12, 2021	Apr. 12, 2022	Radiation (03CH05-KS)
Loop Antenna	R&S	HFH2-Z2	100321	9kHz~30MHz	Nov. 1, 2020	May 12, 2021	Oct. 31, 2021	Radiation (03CH05-KS)
Bilog Antenna	TeseQ	CBL6111D	49922	30MHz~1GHz	May. 30, 2020	May 12, 2021	May. 29, 2021	Radiation (03CH05-KS)
Double Ridge Horn Antenna	ETS-Lindgren	3117	00218652	1GHz~18GHz	Apr. 24, 2021	May 12, 2021	Apr. 23, 2022	Radiation (03CH05-KS)
SHF-EHF Horn	Com-power	AH-840	101115	18GHz~40GHz	Nov. 10, 2020	May 12, 2021	Nov. 09, 2021	Radiation (03CH05-KS)
Amplifier	SONOMA	310N	187289	9KHz~1GHz	Apr. 12, 2021	May 12, 2021	Apr. 11, 2022	Radiation (03CH05-KS)
high gain Amplifier	MITEQ	AMF-7D-0010 1800-30-10P	2012228	1Ghz~18Ghz	Oct. 17, 2020	May 12, 2021	Oct. 16, 2021	Radiation (03CH05-KS)
Amplifier	MITEQ	EM18G40GG A	060728	18~40GHz	Jan. 07, 2021	May 12, 2021	Jan. 06, 2022	Radiation (03CH05-KS)
Amplifier	Keysight	83017A	MY53270316	500MHz~26.5GHz	Oct. 17, 2020	May 12, 2021	Oct. 16, 2021	Radiation (03CH05-KS)
AC Power Source	Chroma	61601	F104090004	N/A	NCR	May 12, 2021	NCR	Radiation (03CH05-KS)
Turn Table	ChamPro	EM 1000-T	060762-T	0~360 degree	NCR	May 12, 2021	NCR	Radiation (03CH05-KS)
Antenna Mast	ChamPro	EM 1000-A	060762-A	1 m~4 m	NCR	May 12, 2021	NCR	Radiation (03CH05-KS)
EMI Receiver	R&S	ESCI7	100768	9kHz~7GHz;	Apr. 21, 2021	May 08, 2021	Apr. 20, 2022	Conduction (CO01-KS)
AC LISN (for auxiliary equipment)	MessTec	AN3016	060103	9kHz~30MHz	Oct. 17, 2020	May 08, 2021	Oct. 16, 2021	Conduction (CO01-KS)
AC LISN	MessTec	AN3016	060105	9kHz~30MHz	Oct. 27, 2020	May 08, 2021	Oct. 26, 2021	Conduction (CO01-KS)
AC Power Source	Chroma	61602	ABP000000811	AC 0V~300V, 45Hz~1000Hz	Oct. 17, 2020	May 08, 2021	Oct. 16, 2021	Conduction (CO01-KS)

NCR: No Calibration Required



5 Uncertainty of Evaluation

The measurement uncertainties shown below were calculated in accordance with the requirements of ANSI 63.10-2013. All the measurement uncertainty value were shown with a coverage K=2 to indicate 95% level of confidence. The measurement data show herein meets or exceeds the CISPR measurement uncertainty values specified in CISPR 16-4-2 and can be compared directly to specified limit to determine compliance.

Uncertainty of Conducted Emission Measurement (150kHz ~ 30MHz)

Measuring Uncertainty for a Level of Confidence of 95% (U = 2Uc(y))	2.9dB
---	-------

Uncertainty of Radiated Emission Measurement (30 MHz ~ 1000 MHz)

Measuring Uncertainty for a Level of Confidence of 95% (U = 2Uc(y))	5.0dB
---	-------

Uncertainty of Radiated Emission Measurement (1000 MHz ~ 18000 MHz)

Measuring Uncertainty for a Level of Confidence of 95% (U = 2Uc(y))	5.0dB
---	-------

Uncertainty of Radiated Emission Measurement (18000 MHz ~ 40000 MHz)

Measuring Uncertainty for a Level of Confidence of 95% (U = 2Uc(y))	5.0dB
---	-------



Appendix A. Conducted Test Results

Appendix A. Test Result of Conducted Test Items

Test Engineer:	Liu Qiu Qiu	Temperature:	21~25	°C
Test Date:	2021/04/15~2021/05/25	Relative Humidity:	51~54	%

TEST RESULTS DATA
26dB and 99% OBW

Band I										
Mod.	Data Rate	N _{TX}	CH.	Freq. (MHz)	99% Bandwidth (MHz)	26 dB Bandwidth (MHz)	IC 99% Bandwidth Power Limit (dBm)	IC 99% Bandwidth EIRP Limit (dBm)		
11a	6Mbps	1	36	5180	16.68	24.23	-	22.22		
11a	6Mbps	1	44	5220	16.73	23.88	-	22.24		
11a	6Mbps	1	48	5240	16.68	23.93	-	22.22		
HT20	MCS0	1	36	5180	17.93	25.77	-	22.54		
HT20	MCS0	1	44	5220	18.03	25.52	-	22.56		
HT20	MCS0	1	48	5240	17.88	25.77	-	22.52		
HT40	MCS0	1	38	5190	36.66	42.26	-	23.01		
HT40	MCS0	1	46	5230	36.66	42.17	-	23.01		
VHT80	MCS0	1	42	5210	76.36	81.84	-	23.01		

TEST RESULTS DATA
Average Power Table

FCC Band I										
Mod.	Data Rate	Ntx	CH.	Freq. (MHz)	Duty Factor (dB)	Average Conducted Power (dBm)	FCC Conducted Power Limit (dBm)	DG (dBi)		Pass/Fail
11a	6Mbps	1	36	5180	0.08	15.02	24.00	0.74		Pass
11a	6Mbps	1	44	5220	0.08	15.06	24.00	0.74		Pass
11a	6Mbps	1	48	5240	0.08	15.36	24.00	0.74		Pass
HT20	MCS0	1	36	5180	0.08	15.35	24.00	0.74		Pass
HT20	MCS0	1	44	5220	0.08	15.19	24.00	0.74		Pass
HT20	MCS0	1	48	5240	0.08	15.09	24.00	0.74		Pass
HT40	MCS0	1	38	5190	0.16	15.36	24.00	0.74		Pass
HT40	MCS0	1	46	5230	0.16	15.02	24.00	0.74		Pass
VHT20	MCS0	1	36	5180	0.08	15.25	24.00	0.74		Pass
VHT20	MCS0	1	44	5220	0.08	15.09	24.00	0.74		Pass
VHT20	MCS0	1	48	5240	0.08	14.99	24.00	0.74		Pass
VHT40	MCS0	1	38	5190	0.16	15.28	24.00	0.74		Pass
VHT40	MCS0	1	46	5230	0.16	14.94	24.00	0.74		Pass
VHT80	MCS0	1	42	5210	0.33	14.00	24.00	0.74		Pass

TEST RESULTS DATA
Power Spectral Density

FCC Band I										
Mod.	Data Rate	N _{TX}	CH.	Freq. (MHz)	Duty Factor (dB)	Average Power Density (dBm/MHz)	Average PSD Limit (dBm/MHz)	DG (dBi)	-	Pass/Fail
11a	6Mbps	1	36	5180	0.08	4.52	11.00	0.74		Pass
11a	6Mbps	1	44	5220	0.08	4.21	11.00	0.74		Pass
11a	6Mbps	1	48	5240	0.08	4.43	11.00	0.74		Pass
HT20	MCS0	1	36	5180	0.08	4.30	11.00	0.74		Pass
HT20	MCS0	1	44	5220	0.08	3.80	11.00	0.74		Pass
HT20	MCS0	1	48	5240	0.08	3.55	11.00	0.74		Pass
HT40	MCS0	1	38	5190	0.16	1.26	11.00	0.74		Pass
HT40	MCS0	1	46	5230	0.16	1.01	11.00	0.74		Pass
VHT80	MCS0	1	42	5210	0.33	-2.94	11.00	0.74		Pass

TEST RESULTS DATA
26dB and 99% OBW

Band II										
Mod.	Data Rate	N _{Tx}	CH.	Freq. (MHz)	99% Bandwidth (MHz)	26 dB Bandwidth (MHz)	IC 99% Bandwidth Power Limit (dBm)	IC 99% Bandwidth EIRP Limit (dBm)	FCC 26dB Bandwidth Power Limit (dBm)	Note
11a	6M bps	1	52	5260	16.73	23.93	23.24	29.24	23.98	
11a	6M bps	1	60	5300	16.73	24.18	23.24	29.24	23.98	
11a	6M bps	1	64	5320	16.73	24.53	23.24	29.24	23.98	
HT20	MCS 0	1	52	5260	17.93	25.77	23.54	29.54	23.98	
HT20	MCS 0	1	60	5300	17.93	25.52	23.54	29.54	23.98	
HT20	MCS 0	1	64	5320	17.93	25.67	23.54	29.54	23.98	
HT40	MCS 0	1	54	5270	36.66	42.17	23.98	30.00	23.98	
HT40	MCS 0	1	62	5310	36.76	42.35	23.98	30.00	23.98	
VHT80	MCS 0	1	58	5290	76.48	84.08	23.98	30.00	23.98	

TEST RESULTS DATA
Average Power Table

FCC Band II										
Mod.	Data Rate	N _{TX}	CH.	Freq. (MHz)	Duty Factor (dB)	Average Conducted Power (dBm)	FCC Conducted Power Limit (dBm)	DG (dBi)	EIRP Power Limit (dBm)	Pass/Fail
11a	6M bps	1	52	5260	0.08	15.01	23.98	0.74	26.99	Pass
11a	6M bps	1	60	5300	0.08	15.07	23.98	0.74	26.99	Pass
11a	6M bps	1	64	5320	0.08	15.06	23.98	0.74	26.99	Pass
HT20	MCS 0	1	52	5260	0.08	15.35	23.98	0.74	26.99	Pass
HT20	MCS 0	1	60	5300	0.08	15.02	23.98	0.74	26.99	Pass
HT20	MCS 0	1	64	5320	0.08	15.07	23.98	0.74	26.99	Pass
HT40	MCS 0	1	54	5270	0.16	15.25	23.98	0.74	26.99	Pass
HT40	MCS 0	1	62	5310	0.16	15.10	23.98	0.74	26.99	Pass
VHT20	MCS 0	1	52	5260	0.08	15.25	23.98	0.74	26.99	Pass
VHT20	MCS 0	1	60	5300	0.08	14.92	23.98	0.74	26.99	Pass
VHT20	MCS 0	1	64	5320	0.08	14.97	23.98	0.74	26.99	Pass
VHT40	MCS 0	1	54	5270	0.16	15.17	23.98	0.74	26.99	Pass
VHT40	MCS 0	1	62	5310	0.16	15.02	23.98	0.74	26.99	Pass
VHT80	MCS 0	1	58	5290	0.33	14.02	23.98	0.74	26.99	Pass

TEST RESULTS DATA
Power Spectral Density

Band II										
Mod.	Data Rate	N _{TX}	CH.	Freq. (MHz)	Duty Factor (dB)	Average Power Density (dBm/MHz)	Average PSD Limit (dBm/MHz)	DG (dBi)		Pass/Fail
11a	6M bps	1	52	5260	0.08	4.27	11.00	0.74		Pass
11a	6M bps	1	60	5300	0.08	4.30	11.00	0.74		Pass
11a	6M bps	1	64	5320	0.08	4.55	11.00	0.74		Pass
HT20	MCS 0	1	52	5260	0.08	3.57	11.00	0.74		Pass
HT20	MCS 0	1	60	5300	0.08	3.93	11.00	0.74		Pass
HT20	MCS 0	1	64	5320	0.08	3.97	11.00	0.74		Pass
HT40	MCS 0	1	54	5270	0.16	0.84	11.00	0.74		Pass
HT40	MCS 0	1	62	5310	0.16	1.15	11.00	0.74		Pass
VHT80	MCS 0	1	58	5290	0.33	-3.14	11.00	0.74		Pass

TEST RESULTS DATA
26dB and 99% OBW

Band III										
Mod.	Data Rate	N _{Tx}	CH.	Freq. (MHz)	99% Bandwidth (MHz)	26 dB Bandwidth (MHz)	IC 99% Bandwidth Power Limit (dBm)	IC 99% Bandwidth EIRP Limit (dBm)	FCC 26dB Bandwidth Power Limit (dBm)	Note
11a	6M bps	1	100	5500	16.73	23.98	23.24	29.24	23.98	
11a	6M bps	1	116	5580	16.68	23.88	23.22	29.22	23.98	
11a	6M bps	1	140	5700	16.83	23.83	23.26	29.26	23.98	
11a	6Mbps	1	144	5720	16.78	23.68	23.25	29.25	23.98	
HT20	MCS 0	1	100	5500	17.93	26.07	23.54	29.54	23.98	
HT20	MCS 0	1	116	5580	17.93	25.52	23.54	29.54	23.98	
HT20	MCS 0	1	140	5700	17.93	25.72	23.54	29.54	23.98	
HT20	MCS0	1	144	5720	17.98	25.87	23.55	29.55	23.98	
HT40	MCS 0	1	102	5510	36.66	42.62	23.98	30.00	23.98	
HT40	MCS 0	1	110	5550	36.66	42.17	23.98	30.00	23.98	
HT40	MCS 0	1	134	5670	36.66	41.99	23.98	30.00	23.98	
HT40	MCS0	1	142	5710	36.66	41.99	23.98	30.00	23.98	
VHT80	MCS 0	1	106	5530	76.36	85.20	23.98	30.00	23.98	
VHT80	MCS 0	1	122	5610	76.24	84.88	23.98	30.00	23.98	
VHT80	MCS0	1	138	5690	76.24	84.88	23.98	30.00	23.98	

TEST RESULTS DATA
Average Power Table

FCC Band III										
Mod.	Data Rate	N _{TX}	CH.	Freq. (MHz)	Duty Factor (dB)	Average Conducted Power (dBm)	FCC Conducted Power Limit (dBm)	DG (dBi)	EIRP Power Limit (dBm)	Pass/Fail
11a	6M bps	1	100	5500	0.08	15.06	23.98	0.82	26.99	Pass
11a	6M bps	1	116	5580	0.08	15.01	23.98	0.82	26.99	Pass
11a	6M bps	1	140	5700	0.08	15.36	23.98	0.82	26.99	Pass
11a	6M bps	1	144	5720	0.08	15.16	23.98	0.82	26.99	Pass
HT20	MCS 0	1	100	5500	0.08	15.10	23.98	0.82	26.99	Pass
HT20	MCS 0	1	116	5580	0.08	15.03	23.98	0.82	26.99	Pass
HT20	MCS 0	1	140	5700	0.08	15.12	23.98	0.82	26.99	Pass
HT20	MCS 0	1	144	5720	0.08	15.06	23.98	0.82	26.99	Pass
HT40	MCS 0	1	102	5510	0.16	15.13	23.98	0.82	26.99	Pass
HT40	MCS 0	1	110	5550	0.16	15.14	23.98	0.82	26.99	Pass
HT40	MCS 0	1	134	5670	0.16	15.17	23.98	0.82	26.99	Pass
HT40	MCS 0	1	142	5710	0.16	15.14	23.98	0.82	26.99	Pass
VHT20	MCS 0	1	100	5500	0.08	15.00	23.98	0.82	26.99	Pass
VHT20	MCS 0	1	116	5580	0.08	14.96	23.98	0.82	26.99	Pass
VHT20	MCS 0	1	140	5700	0.08	15.02	23.98	0.82	26.99	Pass
VHT20	MCS 0	1	144	5720	0.08	15.06	23.98	0.82	26.99	Pass
VHT40	MCS 0	1	102	5510	0.16	15.05	23.98	0.82	26.99	Pass
VHT40	MCS 0	1	110	5550	0.16	15.06	23.98	0.82	26.99	Pass
VHT40	MCS 0	1	134	5670	0.16	15.09	23.98	0.82	26.99	Pass
VHT40	MCS 0	1	142	5710	0.16	15.06	23.98	0.82	26.99	Pass
VHT80	MCS 0	1	106	5530	0.33	14.15	23.98	0.82	26.99	Pass
VHT80	MCS 0	1	122	5610	0.33	13.99	23.98	0.82	26.99	Pass
VHT80	MCS 0	1	138	5690	0.33	14.03	23.98	0.82	26.99	Pass

TEST RESULTS DATA
Power Spectral Density

Band III										
Mod.	Data Rate	N _{TX}	CH.	Freq. (MHz)	Duty Factor (dB)	Average Power Density (dBm/MHz)	Average PSD Limit (dBm/MHz)	DG (dBi)		Pass/Fail
11a	6M bps	1	100	5500	0.08	4.58	11.00	0.82		Pass
11a	6M bps	1	116	5580	0.08	4.29	11.00	0.82		Pass
11a	6M bps	1	140	5700	0.08	4.53	11.00	0.82		Pass
11a	6Mbps	1	144	5720	0.08	4.30	11.00	0.82		Pass
HT20	MCS 0	1	100	5500	0.08	3.64	11.00	0.82		Pass
HT20	MCS 0	1	116	5580	0.08	3.90	11.00	0.82		Pass
HT20	MCS 0	1	140	5700	0.08	4.14	11.00	0.82		Pass
HT20	MCS0	1	144	5720	0.08	4.08	11.00	0.82		Pass
HT40	MCS 0	1	102	5510	0.16	1.29	11.00	0.82		Pass
HT40	MCS 0	1	110	5550	0.16	1.40	11.00	0.82		Pass
HT40	MCS 0	1	134	5670	0.16	1.02	11.00	0.82		Pass
HT40	MCS0	1	142	5710	0.16	1.23	11.00	0.82		Pass
VHT80	MCS 0	1	106	5530	0.33	-2.77	11.00	0.82		Pass
VHT80	MCS 0	1	122	5610	0.33	-3.40	11.00	0.82		Pass
VHT80	MCS0	1	138	5690	0.33	-3.10	11.00	0.82		Pass



Appendix B. AC Conducted Emission Test Results

Test Engineer :	Amos Zhang	Temperature :	25.3~26.2°C
		Relative Humidity :	38~40%
Test Voltage :	120Vac / 60Hz	Phase :	Line
Remark :	All emissions not reported here are more than 10 dB below the prescribed limit.		

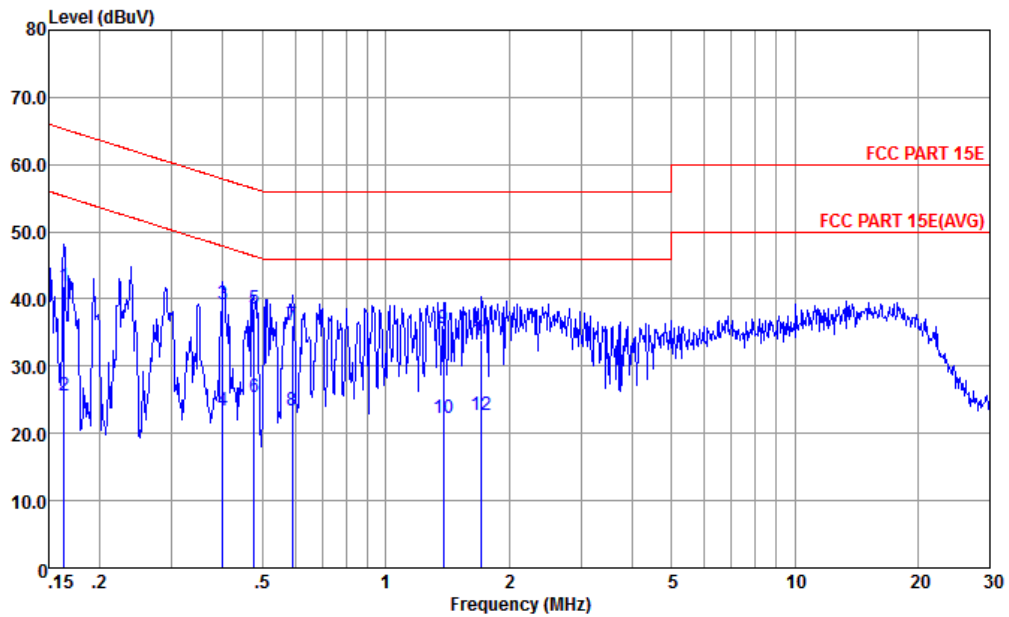

Site : CO01-KS
Condition : FCC PART 15E TWO-LISN-CN02-L LINE

	Freq	Level	Over Limit	Limit Line	Read Level	LISN Factor	Cable Loss	Remark
	MHz	dBuV	dB	dBuV	dBuV	dB	dB	
1	0.163	41.99	-23.31	65.30	21.90	9.64	10.45	QP
2	0.163	25.69	-29.61	55.30	5.60	9.64	10.45	Average
3	0.400	39.11	-18.75	57.86	19.19	9.65	10.27	QP
4	0.400	23.41	-24.45	47.86	3.49	9.65	10.27	Average
5 *	0.476	38.49	-17.92	56.41	18.60	9.65	10.24	QP
6	0.476	25.39	-21.02	46.41	5.50	9.65	10.24	Average
7	0.592	36.09	-19.91	56.00	16.20	9.65	10.24	QP
8	0.592	23.39	-22.61	46.00	3.50	9.65	10.24	Average
9	1.381	35.65	-20.35	56.00	15.60	9.82	10.23	QP
10	1.381	22.25	-23.75	46.00	2.20	9.82	10.23	Average
11	1.716	33.91	-22.09	56.00	13.79	9.89	10.23	QP
12	1.716	22.71	-23.29	46.00	2.59	9.89	10.23	Average



Test Engineer :	Amos Zhang	Temperature :	25.3~26.2°C
		Relative Humidity :	38~40%
Test Voltage :	120Vac / 60Hz	Phase :	Neutral
Remark :	All emissions not reported here are more than 10 dB below the prescribed limit.		

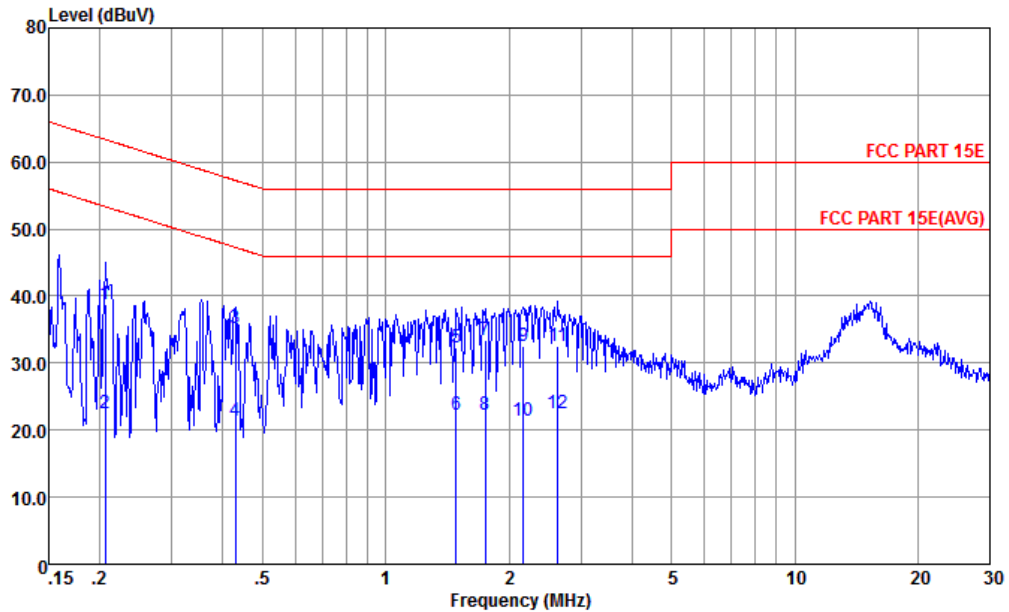

Site : CO01-KS
 Condition : FCC PART 15E TWO-LISN-CN02-N NEUTRAL

	Freq	Level	Over	Limit	Read	LISN	Cable	Remark
	MHz	dBuV	Limit	Line	Level	Factor	Loss	
			dB	dBuV	dBuV	dB	dB	
1	0.206	38.85	-24.51	63.36	18.61	9.88	10.36	QP
2	0.206	22.55	-30.81	53.36	2.31	9.88	10.36	Average
3 *	0.428	35.21	-22.08	57.29	15.20	9.75	10.26	QP
4	0.428	21.31	-25.98	47.29	1.30	9.75	10.26	Average
5	1.487	32.26	-23.74	56.00	12.20	9.83	10.23	QP
6	1.487	22.36	-23.64	46.00	2.30	9.83	10.23	Average
7	1.753	33.41	-22.59	56.00	13.30	9.88	10.23	QP
8	1.753	22.21	-23.79	46.00	2.10	9.88	10.23	Average
9	2.167	32.48	-23.52	56.00	12.30	9.95	10.23	QP
10	2.167	21.38	-24.62	46.00	1.20	9.95	10.23	Average
11	2.636	32.46	-23.54	56.00	12.19	10.03	10.24	QP
12	2.636	22.56	-23.44	46.00	2.29	10.03	10.24	Average

Note:

- Level(dBμV) = Read Level(dBμV) + LISN Factor(dB) + Cable Loss(dB)
- Over Limit(dB) = Level(dBμV) – Limit Line(dBμV)



Appendix C. Radiated Spurious Emission

UNII 1 - 5150~5250MHz

WIFI 802.11a (Band Edge @ 3m)

WIFI Ant.	Note	Frequency (MHz)	Level (dBμV/m)	Over Limit (dB)	Limit Line (dBμV/m)	Read Level (dBμV)	Antenna Factor (dB/m)	Cable Loss (dB)	Preamp Factor (dB)	Ant Pos (cm)	Table Pos (deg)	Peak Avg. (P/A)	Pol. (H/V)
802.11a CH 36 5180MHz		5144.64	61.17	-12.83	74	45.96	34.62	11.2	30.61	100	113	P	H
	!	5149.6	49.58	-4.42	54	34.37	34.62	11.2	30.61	100	113	A	H
	*	5182	107.75	-	-	92.46	34.67	11.24	30.62	100	113	P	H
		5182	100.83	-	-	85.54	34.67	11.24	30.62	100	113	A	H
		5115.84	57.77	-16.23	74	42.63	34.58	11.16	30.6	100	71	P	V
	!	5149.92	48.18	-5.82	54	32.97	34.62	11.2	30.61	100	71	A	V
	*	5182	104.9	-	-	89.61	34.67	11.24	30.62	100	71	P	V
		5182	97.41	-	-	82.12	34.67	11.24	30.62	100	71	A	V
Remark	1. No other spurious found. 2. All results are PASS against Peak and Average limit line.												

UNII 1 5150~5250MHz

WIFI 802.11a (Harmonic @ 3m)

WIFI Ant.	Note	Frequency (MHz)	Level (dBμV/m)	Over Limit (dB)	Limit Line (dBμV/m)	Read Level (dBμV)	Antenna Factor (dB/m)	Cable Loss (dB)	Preamp Factor (dB)	Ant Pos (cm)	Table Pos (deg)	Peak Avg. (P/A)	Pol. (H/V)
802.11a CH 36 5180MHz		10363.36	51.54	-16.76	68.3	58.38	37.59	16.25	60.68	300	0	P	H
		10363.36	56.08	-12.22	68.3	62.92	37.59	16.25	60.68	101	95	P	V
802.11a CH 44 5220MHz		10443.44	51.42	-16.88	68.3	58.13	37.65	16.3	60.66	300	0	P	H
		10448.45	59.51	-8.79	68.3	66.2	37.66	16.31	60.66	100	93	P	V
802.11a CH 48 5240MHz		10478.47	53.63	-14.67	68.3	60.25	37.69	16.34	60.65	300	0	P	H
		10483.48	58.74	-9.56	68.3	65.36	37.69	16.34	60.65	100	97	P	V
Remark	1. No other spurious found. 2. All results are PASS against Peak and Average limit line.												



UNII 1 5150~5250MHz
WIFI 802.11n HT20 (Band Edge @ 3m)

WIFI Ant. 1	Note	Frequency (MHz)	Level (dBµV/m)	Over Limit (dB)	Limit Line (dBµV/m)	Read Level (dBµV)	Antenna Factor (dB/m)	Cable Loss (dB)	Preamp Factor (dB)	Ant Pos (cm)	Table Pos (deg)	Peak Avg. (P/A)	Pol. (H/V)
802.11n HT20 CH 36 5180MHz		5143.04	61.47	-12.53	74	46.26	34.62	11.2	30.61	100	115	P	H
	!	5149.92	50.15	-3.85	54	34.94	34.62	11.2	30.61	100	115	A	H
	*	5182	108.4	-	-	93.11	34.67	11.24	30.62	100	115	P	H
		5182	100.17	-	-	84.88	34.67	11.24	30.62	100	115	A	H
		5147.68	58.15	-15.85	74	42.94	34.62	11.2	30.61	100	71	P	V
	!	5150	48.36	-5.64	54	33.15	34.62	11.2	30.61	100	71	A	V
	*	5182	104.63	-	-	89.34	34.67	11.24	30.62	100	71	P	V
	5182	97.11	-	-	81.82	34.67	11.24	30.62	100	71	A	V	
Remark	1. No other spurious found. 2. All results are PASS against Peak and Average limit line.												

UNII 1 5150~5250MHz
WIFI 802.11n HT20 (Harmonic @ 3m)

WIFI Ant. 1	Note	Frequency (MHz)	Level (dBµV/m)	Over Limit (dB)	Limit Line (dBµV/m)	Read Level (dBµV)	Antenna Factor (dB/m)	Cable Loss (dB)	Preamp Factor (dB)	Ant Pos (cm)	Table Pos (deg)	Peak Avg. (P/A)	Pol. (H/V)
802.11n HT20 CH 36 5180MHz		10360	51.72	-16.58	68.3	58.56	37.59	16.25	60.68	300	0	P	H
		10360	53.84	-14.46	68.3	60.68	37.59	16.25	60.68	300	0	P	V
802.11n HT20 CH 44 5220MHz		10440	53.3	-15	68.3	60.01	37.65	16.3	60.66	300	0	P	H
		10440	58.53	-9.77	68.3	65.24	37.65	16.3	60.66	300	0	P	V
802.11n HT20 CH 48 5240MHz		10480	53.78	-14.52	68.3	60.4	37.69	16.34	60.65	300	0	P	H
		10480	55.2	-13.1	68.3	61.82	37.69	16.34	60.65	300	0	P	V
Remark	1. No other spurious found. 2. All results are PASS against Peak and Average limit line.												



UNII 1 5150~5250MHz
WIFI 802.11n HT40 (Band Edge @ 3m)

WIFI Ant. 1	Note	Frequency (MHz)	Level (dBμV/m)	Over Limit (dB)	Limit Line (dBμV/m)	Read Level (dBμV)	Antenna Factor (dB/m)	Cable Loss (dB)	Preamp Factor (dB)	Ant Pos (cm)	Table Pos (deg)	Peak Avg. (P/A)	Pol. (H/V)
802.11n HT40 CH 38 5190MHz		5140.16	59.45	-14.55	74	44.24	34.62	11.2	30.61	100	115	P	H
	!	5149.92	50.13	-3.87	54	34.92	34.62	11.2	30.61	100	115	A	H
	*	5194	103.24	-	-	87.91	34.7	11.26	30.63	100	115	P	H
		5194	95.36	-	-	80.03	34.7	11.26	30.63	100	115	A	H
		5397.84	55.4	-18.6	74	39.9	34.7	11.49	30.69	100	115	P	H
		5398.74	46.36	-7.64	54	30.87	34.7	11.49	30.7	100	115	A	H
		5144.96	58.21	-15.79	74	43	34.62	11.2	30.61	103	72	P	V
	!	5133.92	48.52	-5.48	54	33.35	34.6	11.18	30.61	103	72	A	V
	*	5194	100.55	-	-	85.22	34.7	11.26	30.63	103	72	P	V
		5194	92.92	-	-	77.59	34.7	11.26	30.63	103	72	A	V
		5394.24	56.44	-17.56	74	40.96	34.7	11.47	30.69	103	72	P	V
		5397.84	46.44	-7.56	54	30.94	34.7	11.49	30.69	103	72	A	V
Remark	1. No other spurious found. 2. All results are PASS against Peak and Average limit line.												

UNII 1 5150~5250MHz
WIFI 802.11n HT40 (Harmonic @ 3m)

WIFI Ant. 1	Note	Frequency (MHz)	Level (dBμV/m)	Over Limit (dB)	Limit Line (dBμV/m)	Read Level (dBμV)	Antenna Factor (dB/m)	Cable Loss (dB)	Preamp Factor (dB)	Ant Pos (cm)	Table Pos (deg)	Peak Avg. (P/A)	Pol. (H/V)
802.11n HT40 CH 38 5190MHz		10378.38	46.84	-21.46	68.3	53.64	37.61	16.26	60.67	300	0	P	H
		10388.38	52.32	-15.98	68.3	59.12	37.61	16.26	60.67	300	0	P	V
802.11n HT40 CH 46 5230MHz		10473.47	48.87	-19.43	68.3	55.53	37.67	16.33	60.66	300	0	P	H
		10473.47	53.74	-14.56	68.3	60.4	37.67	16.33	60.66	300	0	P	V
Remark	1. No other spurious found. 2. All results are PASS against Peak and Average limit line.												



UNII 1 5150~5250MHz
WIFI 802.11ac VHT80 (Band Edge @ 3m)

WIFI Ant. 1	Note	Frequency (MHz)	Level (dBμV/m)	Over Limit (dB)	Limit Line (dBμV/m)	Read Level (dBμV)	Antenna Factor (dB/m)	Cable Loss (dB)	Preamp Factor (dB)	Ant Pos (cm)	Table Pos (deg)	Peak Avg. (P/A)	Pol. (H/V)
802.11ac VHT80 CH 42 5210MHz		5141.92	61.4	-12.6	74	46.19	34.62	11.2	30.61	100	114	P	H
	!	5147.84	50.79	-3.21	54	35.58	34.62	11.2	30.61	100	114	A	H
	*	5200	99.95	-	-	84.62	34.7	11.26	30.63	100	114	P	H
		5200	91.77	-	-	76.44	34.7	11.26	30.63	100	114	A	H
		5362.2	55.96	-18.04	74	40.5	34.7	11.45	30.69	100	114	P	H
		5385.06	47.03	-6.97	54	31.55	34.7	11.47	30.69	100	114	A	H
		5149.28	59.29	-14.71	74	44.08	34.62	11.2	30.61	100	73	P	V
	!	5146.08	49.32	-4.68	54	34.11	34.62	11.2	30.61	100	73	A	V
	*	5206	96.77	-	-	81.44	34.7	11.26	30.63	100	73	P	V
		5206	88.79	-	-	73.46	34.7	11.26	30.63	100	73	A	V
		5394.42	56.36	-17.64	74	40.88	34.7	11.47	30.69	100	73	P	V
		5355.36	46.77	-7.23	54	31.32	34.7	11.43	30.68	100	73	A	V
Remark	1. No other spurious found. 2. All results are PASS against Peak and Average limit line.												

UNII 1 5150~5250MHz
WIFI 802.11ac VHT80 (Harmonic @ 3m)

WIFI Ant. 1	Note	Frequency (MHz)	Level (dBμV/m)	Over Limit (dB)	Limit Line (dBμV/m)	Read Level (dBμV)	Antenna Factor (dB/m)	Cable Loss (dB)	Preamp Factor (dB)	Ant Pos (cm)	Table Pos (deg)	Peak Avg. (P/A)	Pol. (H/V)
802.11ac VHT80 CH 42 5210MHz		10418.42	46.58	-21.72	68.3	53.33	37.63	16.29	60.67	300	0	P	H
		10418.42	48.51	-19.79	68.3	55.26	37.63	16.29	60.67	300	0	P	V
Remark	1. No other spurious found. 2. All results are PASS against Peak and Average limit line.												



UNII 2A - 5250~5350MHz
WIFI 802.11a (Band Edge @ 3m)

WIFI	Note	Frequency	Level	Over	Limit	Read	Antenna	Cable	Preamp	Ant	Table	Peak	Pol.
Ant.				Limit	Line	Level	Factor	Loss	Factor	Pos	Pos	Avg.	
1		(MHz)	(dBμV/m)	(dB)	(dBμV/m)	(dBμV)	(dB/m)	(dB)	(dB)	(cm)	(deg)	(P/A)	(H/V)
802.11a CH 64 5320MHz		5363.7	59.64	-14.36	74	44.18	34.7	11.45	30.69	100	113	P	H
	!	5350	48.31	-5.69	54	32.86	34.7	11.43	30.68	100	113	A	H
	*	5320	107.6	-	-	92.18	34.7	11.39	30.67	100	113	P	H
		5320	99.65	-	-	84.23	34.7	11.39	30.67	100	113	A	H
		5351.3	59.55	-14.45	74	44.1	34.7	11.43	30.68	100	73	P	V
		5358.3	47.51	-6.49	54	32.06	34.7	11.43	30.68	100	73	A	V
	*	5320	104.3	-	-	88.88	34.7	11.39	30.67	100	73	P	V
		5320	97.32	-	-	81.9	34.7	11.39	30.67	100	73	A	V
Remark	1. No other spurious found. 2. All results are PASS against Peak and Average limit line.												

UNII 2A 5250~5350MHz
WIFI 802.11a (Harmonic @ 3m)

WIFI	Note	Frequency	Level	Over	Limit	Read	Antenna	Cable	Preamp	Ant	Table	Peak	Pol.
Ant.				Limit	Line	Level	Factor	Loss	Factor	Pos	Pos	Avg.	
1		(MHz)	(dBμV/m)	(dB)	(dBμV/m)	(dBμV)	(dB/m)	(dB)	(dB)	(cm)	(deg)	(P/A)	(H/V)
802.11a CH 52 5260MHz		10518.52	53.92	-14.38	68.3	60.5	37.71	16.36	60.65	300	0	P	H
		10523.52	61.75	-6.55	68.3	68.33	37.71	16.36	60.65	100	93	P	V
802.11a CH 60 5300MHz		10600	54.61	-19.39	74	61.07	37.74	16.43	60.63	100	300	P	H
		10600	44.54	-9.46	54	51	37.74	16.43	60.63	100	300	A	H
		10603.6	59.85	-14.15	74	66.31	37.74	16.43	60.63	100	94	P	V
	!	10603.6	50.2	-3.8	54	56.66	37.74	16.43	60.63	100	94	A	V
802.11a CH 64 5320MHz		10633.63	54.01	-19.99	74	60.42	37.76	16.45	60.62	100	300	P	H
		10633.63	44.96	-9.04	54	51.37	37.76	16.45	60.62	100	300	A	H
		10638.63	60.71	-13.29	74	67.12	37.76	16.45	60.62	104	94	P	V
	!	10638.63	50.22	-3.78	54	56.63	37.76	16.45	60.62	104	94	A	V
Remark	1. No other spurious found. 2. All results are PASS against Peak and Average limit line.												



UNII 2A 5250~5350MHz
WIFI 802.11n HT20 (Band Edge @ 3m)

WIFI Ant. 1	Note	Frequency (MHz)	Level (dBμV/m)	Over Limit (dB)	Limit Line (dBμV/m)	Read Level (dBμV)	Antenna Factor (dB/m)	Cable Loss (dB)	Preamp Factor (dB)	Ant Pos (cm)	Table Pos (deg)	Peak Avg. (P/A)	Pol. (H/V)
802.11n HT20 CH 64 5320MHz		5363.6	61.13	-12.87	74	45.67	34.7	11.45	30.69	106	116	P	H
		5358.4	47.66	-6.34	54	32.21	34.7	11.43	30.68	106	116	A	H
	*	5320	104.68	-	-	89.26	34.7	11.39	30.67	106	116	P	H
		5320	97.56	-	-	82.14	34.7	11.39	30.67	106	116	A	H
		5395.3	57.79	-16.21	74	42.29	34.7	11.49	30.69	101	73	P	V
		5351	46.99	-7.01	54	31.54	34.7	11.43	30.68	101	73	A	V
	*	5320	102.99	-	-	87.57	34.7	11.39	30.67	101	73	P	V
		5320	94.93	-	-	79.51	34.7	11.39	30.67	101	73	A	V
Remark	1. No other spurious found. 2. All results are PASS against Peak and Average limit line.												

UNII 2A 5250~5350MHz
WIFI 802.11n HT20 (Harmonic @ 3m)

WIFI Ant. 1	Note	Frequency (MHz)	Level (dBμV/m)	Over Limit (dB)	Limit Line (dBμV/m)	Read Level (dBμV)	Antenna Factor (dB/m)	Cable Loss (dB)	Preamp Factor (dB)	Ant Pos (cm)	Table Pos (deg)	Peak Avg. (P/A)	Pol. (H/V)
802.11n HT20 CH 52 5260MHz		10513.51	51.4	-16.9	68.3	57.98	37.71	16.36	60.65	300	0	P	H
		10523.52	56.57	-11.73	68.3	63.15	37.71	16.36	60.65	300	0	P	V
802.11n HT20 CH 60 5300MHz		10600.1	56.27	-17.73	74	62.73	37.74	16.43	60.63	100	125	P	H
		10600.1	45.34	-8.66	54	51.8	37.74	16.43	60.63	100	125	A	H
		10600.1	60.9	-13.1	74	67.36	37.74	16.43	60.63	100	93	P	V
	!	10600.1	50.53	-3.47	54	56.99	37.74	16.43	60.63	100	93	A	V
802.11n HT20 CH 64 5320MHz		10638.63	55.86	-18.14	74	62.27	37.76	16.45	60.62	100	69	P	H
		10638.63	45.22	-8.78	54	51.63	37.76	16.45	60.62	100	69	A	H
		10638.63	61.86	-12.14	74	68.27	37.76	16.45	60.62	100	92	P	V
	!	10638.63	50.83	-3.17	54	57.24	37.76	16.45	60.62	100	92	A	V
Remark	1. No other spurious found. 2. All results are PASS against Peak and Average limit line.												



**UNII 2A 5250~5350MHz
WIFI 802.11n HT40 (Band Edge @ 3m)**

WIFI Ant. 1	Note	Frequency (MHz)	Level (dBμV/m)	Over Limit (dB)	Limit Line (dBμV/m)	Read Level (dBμV)	Antenna Factor (dB/m)	Cable Loss (dB)	Preamp Factor (dB)	Ant Pos (cm)	Table Pos (deg)	Peak Avg. (P/A)	Pol. (H/V)
802.11n HT40 CH 62 5310MHz		5113.12	57.03	-16.97	74	41.89	34.58	11.16	30.6	100	115	P	H
		5100.32	47.56	-6.44	54	32.47	34.55	11.14	30.6	100	115	A	H
	*	5308	101.66	-	-	86.25	34.7	11.38	30.67	100	115	P	H
		5308	93.61	-	-	78.2	34.7	11.38	30.67	100	115	A	H
		5353.7	58.56	-15.44	74	43.11	34.7	11.43	30.68	100	115	P	H
	!	5350	50.22	-3.78	54	34.77	34.7	11.43	30.68	100	115	A	H
		5105.44	58.37	-15.63	74	43.28	34.55	11.14	30.6	100	73	P	V
	!	5109.92	48.16	-5.84	54	33.02	34.58	11.16	30.6	100	73	A	V
	*	5314	100.92	-	-	85.5	34.7	11.39	30.67	100	73	P	V
		5314	93.28	-	-	77.86	34.7	11.39	30.67	100	73	A	V
		5353.5	59.53	-14.47	74	44.08	34.7	11.43	30.68	100	73	P	V
!	5350.7	50.09	-3.91	54	34.64	34.7	11.43	30.68	100	73	A	V	
Remark	1. No other spurious found. 2. All results are PASS against Peak and Average limit line.												

**UNII 2A 5250~5350MHz
WIFI 802.11n HT40 (Harmonic @ 3m)**

WIFI Ant. 1	Note	Frequency (MHz)	Level (dBμV/m)	Over Limit (dB)	Limit Line (dBμV/m)	Read Level (dBμV)	Antenna Factor (dB/m)	Cable Loss (dB)	Preamp Factor (dB)	Ant Pos (cm)	Table Pos (deg)	Peak Avg. (P/A)	Pol. (H/V)
802.11n HT40 CH 54 5270MHz		10548.54	49.66	-18.64	68.3	56.19	37.72	16.39	60.64	300	0	P	H
		10528.53	54.52	-13.78	68.3	61.07	37.71	16.38	60.64	300	0	P	V
802.11n HT40 CH 62 5310MHz		10618.62	52.59	-21.41	74	59.02	37.75	16.44	60.62	101	341	P	H
		10618.62	45.03	-8.97	54	51.46	37.75	16.44	60.62	101	341	A	H
		10623.62	57.89	-16.11	74	64.32	37.75	16.44	60.62	100	92	P	V
	!	10623.62	50.87	-3.13	54	57.3	37.75	16.44	60.62	100	92	A	V
Remark	1. No other spurious found. 2. All results are PASS against Peak and Average limit line.												



UNII 2A 5250~5350MHz
WIFI 802.11ac VHT80 (Band Edge @ 3m)

WIFI Ant. 1	Note	Frequency (MHz)	Level (dBμV/m)	Over Limit (dB)	Limit Line (dBμV/m)	Read Level (dBμV)	Antenna Factor (dB/m)	Cable Loss (dB)	Preamp Factor (dB)	Ant Pos (cm)	Table Pos (deg)	Peak Avg. (P/A)	Pol. (H/V)
802.11ac VHT80 CH 58 5290MHz		5122.08	57.39	-16.61	74	42.25	34.58	11.16	30.6	100	115	P	H
		5111.84	47.84	-6.16	54	32.7	34.58	11.16	30.6	100	115	A	H
	*	5278	99.25	-	-	83.84	34.7	11.36	30.65	100	115	P	H
		5278	90.88	-	-	75.47	34.7	11.36	30.65	100	115	A	H
		5368.6	59.48	-14.52	74	44.02	34.7	11.45	30.69	100	115	P	H
	!	5363	50.54	-3.46	54	35.08	34.7	11.45	30.69	100	115	A	H
		5114.88	58.88	-15.12	74	43.74	34.58	11.16	30.6	100	70	P	V
		5104.96	47.93	-6.07	54	32.84	34.55	11.14	30.6	100	70	A	V
	*	5284	97.39	-	-	81.98	34.7	11.36	30.65	100	70	P	V
		5284	89.32	-	-	73.91	34.7	11.36	30.65	100	70	A	V
		5376.2	58.17	-15.83	74	42.71	34.7	11.45	30.69	100	70	P	V
	!	5361.3	49.65	-4.35	54	34.19	34.7	11.45	30.69	100	70	A	V
Remark	1. No other spurious found. 2. All results are PASS against Peak and Average limit line.												

UNII 2A 5250~5350MHz
WIFI 802.11ac VHT80 (Harmonic @ 3m)

WIFI Ant. 1	Note	Frequency (MHz)	Level (dBμV/m)	Over Limit (dB)	Limit Line (dBμV/m)	Read Level (dBμV)	Antenna Factor (dB/m)	Cable Loss (dB)	Preamp Factor (dB)	Ant Pos (cm)	Table Pos (deg)	Peak Avg. (P/A)	Pol. (H/V)
802.11ac VHT80 CH 58 5290MHz		10578.58	46.36	-21.94	68.3	52.86	37.73	16.4	60.63	300	0	P	H
		10578.58	50.57	-17.73	68.3	57.07	37.73	16.4	60.63	300	0	P	V
Remark	1. No other spurious found. 2. All results are PASS against Peak and Average limit line.												



UNII 2C - 5470~5725MHz
WIFI 802.11a (Band Edge @ 3m)

WIFI	Note	Frequency	Level	Over	Limit	Read	Antenna	Cable	Preamp	Ant	Table	Peak	Pol.
Ant.				Limit	Line	Level	Factor	Loss	Factor	Pos	Pos	Avg.	
1		(MHz)	(dBμV/m)	(dB)	(dBμV/m)	(dBμV)	(dB/m)	(dB)	(dB)	(cm)	(deg)	(P/A)	(H/V)
802.11a CH 100 5500MHz		5456.72	58.06	-15.94	74	42.55	34.7	11.53	30.72	101	115	P	H
		5464.72	58.9	-9.4	68.3	43.37	34.7	11.55	30.72	101	115	P	H
	!	5458.16	48.33	-5.67	54	32.82	34.7	11.53	30.72	101	115	A	H
	*	5500	107.99	-	-	92.44	34.7	11.58	30.73	101	115	P	H
		5500	100.12	-	-	84.57	34.7	11.58	30.73	101	115	A	H
		5451.6	57.49	-16.51	74	41.97	34.7	11.53	30.71	107	214	P	V
		5465.84	60.76	-7.54	68.3	45.23	34.7	11.55	30.72	107	214	P	V
	!	5460	48.22	-5.78	54	32.71	34.7	11.53	30.72	107	214	A	V
	*	5500	106.77	-	-	91.22	34.7	11.58	30.73	107	214	P	V
		5500	99.15	-	-	83.6	34.7	11.58	30.73	107	214	A	V
802.11a CH 140 5700MHz	!	5725.88	64.82	-3.48	68.3	48.72	35.08	11.84	30.82	100	114	P	H
	*	5698	110.2	-	-	94.24	34.97	11.79	30.8	100	114	P	H
		5698	102.54	-	-	86.58	34.97	11.79	30.8	100	114	A	H
		5735.08	60.32	-7.98	68.3	44.13	35.14	11.87	30.82	101	242	P	V
	*	5704	106.94	-	-	90.9	35.03	11.82	30.81	101	242	P	V
		5704	99.38	-	-	83.34	35.03	11.82	30.81	101	242	A	V
Remark	1. No other spurious found. 2. All results are PASS against Peak and Average limit line.												



UNII 2C - 5470~5725MHz
WIFI 802.11a (Harmonic @ 3m)

WIFI Ant. 1	Note	Frequency (MHz)	Level (dBμV/m)	Over Limit (dB)	Limit Line (dBμV/m)	Read Level (dBμV)	Antenna Factor (dB/m)	Cable Loss (dB)	Preamp Factor (dB)	Ant Pos (cm)	Table Pos (deg)	Peak Avg. (P/A)	Pol. (H/V)
802.11a CH 100 5500MHz		10999	50.56	-23.44	74	56.49	37.9	16.71	60.54	100	360	P	H
		16512	56.23	-12.07	68.3	52.48	42	20.66	58.91	100	0	P	H
		10999	57.74	-16.26	74	63.67	37.9	16.71	60.54	105	251	P	V
	!	10999	48.02	-5.98	54	53.95	37.9	16.71	60.54	105	251	A	V
		16506	55.27	-13.03	68.3	51.52	42	20.66	58.91	100	0	P	V
802.11a CH 116 5580MHz		11159.16	47.52	-26.48	74	53.19	38	16.83	60.5	300	0	P	H
		16734	61.1	-7.2	68.3	56.56	42.29	20.82	58.57	100	0	P	H
		11164.16	55.07	-18.93	74	60.74	38	16.83	60.5	100	308	P	V
		11164.16	45.59	-8.41	54	51.26	38	16.83	60.5	100	308	A	V
	!	16740	63.9	-4.4	68.3	59.36	42.29	20.82	58.57	111	114	P	V
802.11a CH 140 5700MHz		11404.4	48.97	-25.03	74	54.27	38.14	17.01	60.45	300	0	P	H
		17100	62.25	-6.05	68.3	56.83	42.42	21.08	58.08	100	0	P	H
		11404.4	56.81	-17.19	74	62.11	38.14	17.01	60.45	100	301	P	V
		11404.4	46.7	-7.3	54	52	38.14	17.01	60.45	100	301	A	V
	!	17106	65.11	-3.19	68.3	59.69	42.42	21.08	58.08	100	141	P	V
Remark	1. No other spurious found. 2. All results are PASS against Peak and Average limit line.												



UNII 2C - 5470~5725MHz
WIFI 802.11n HT20 (Band Edge @ 3m)

Table with 14 columns: WIFI Ant. 1, Note, Frequency (MHz), Level (dBµV/m), Over Limit (dB), Limit Line (dBµV/m), Read Level (dBµV), Antenna Factor (dB/m), Cable Loss (dB), Preamp Factor (dB), Ant Pos (cm), Table Pos (deg), Peak Avg. (P/A), Pol. (H/V). Rows include test data for 802.11n HT20 CH 100 (5500MHz) and CH 140 (5700MHz), and a Remark section.



UNII 2C - 5470~5725MHz
WIFI 802.11n HT20 (Harmonic @ 3m)

Table with 14 columns: WIFI Ant. 1, Note, Frequency (MHz), Level (dBµV/m), Over Limit (dB), Limit Line (dBµV/m), Read Level (dBµV), Antenna Factor (dB/m), Cable Loss (dB), Preamp Factor (dB), Ant Pos (cm), Table Pos (deg), Peak Avg. (P/A), Pol. (H/V). Rows include test data for 802.11n HT20 CH 100 (5500MHz) and CH 116 (5580MHz), and 802.11n HT20 CH 140 (5700MHz).



**UNII 2C - 5470~5725MHz
WIFI 802.11n HT40 (Band Edge @ 3m)**

WIFI Ant. 1	Note	Frequency (MHz)	Level (dBµV/m)	Over Limit (dB)	Limit Line (dBµV/m)	Read Level (dBµV)	Antenna Factor (dB/m)	Cable Loss (dB)	Preamp Factor (dB)	Ant Pos (cm)	Table Pos (deg)	Peak Avg. (P/A)	Pol. (H/V)
802.11n HT40 CH 102 5510MHz		5458.64	59.83	-14.17	74	44.32	34.7	11.53	30.72	100	118	P	H
		5468.24	59.19	-9.11	68.3	43.66	34.7	11.55	30.72	100	118	P	H
	!	5458.16	50.16	-3.84	54	34.65	34.7	11.53	30.72	100	118	A	H
	*	5512	102.71	-	-	87.16	34.7	11.58	30.73	100	118	P	H
		5512	94.94	-	-	79.39	34.7	11.58	30.73	100	118	A	H
		5747	56.59	-11.71	68.3	40.41	35.14	11.87	30.83	100	118	P	H
		5452.08	58.73	-15.27	74	43.21	34.7	11.53	30.71	100	215	P	V
		5470	59.26	-9.04	68.3	43.73	34.7	11.55	30.72	100	215	P	V
	!	5458.32	49.44	-4.56	54	33.93	34.7	11.53	30.72	100	215	A	V
	*	5512	101.63	-	-	86.08	34.7	11.58	30.73	100	215	P	V
		5512	93.5	-	-	77.95	34.7	11.58	30.73	100	215	A	V
		5757.88	56.53	-11.77	68.3	40.28	35.19	11.89	30.83	100	215	P	V
802.11n HT40 CH 134 5670MHz		5437.68	56.71	-17.29	74	41.2	34.7	11.52	30.71	100	116	P	H
		5469.04	55.75	-12.55	68.3	40.22	34.7	11.55	30.72	100	116	P	H
		5458	47.05	-6.95	54	31.54	34.7	11.53	30.72	100	116	A	H
	*	5674	105.3	-	-	89.4	34.92	11.77	30.79	100	116	P	H
		5674	96.83	-	-	80.93	34.92	11.77	30.79	100	116	A	H
		5729.72	62.26	-6.04	68.3	46.16	35.08	11.84	30.82	100	116	P	H
		5403.12	56.27	-17.73	74	40.78	34.7	11.49	30.7	106	244	P	V
		5462.32	55.53	-12.77	68.3	40.02	34.7	11.53	30.72	106	244	P	V
		5458.8	47.03	-6.97	54	31.52	34.7	11.53	30.72	106	244	A	V
	*	5674	103.5	-	-	87.6	34.92	11.77	30.79	106	244	P	V
	5674	94.91	-	-	79.01	34.92	11.77	30.79	106	244	A	V	
	5729.16	60.9	-7.4	68.3	44.8	35.08	11.84	30.82	106	244	P	V	

Remark	1. No other spurious found.
	2. All results are PASS against Peak and Average limit line.



**UNII 2C - 5470~5725MHz
WIFI 802.11n HT40 (Harmonic @ 3m)**

WIFI Ant. 1	Note	Frequency (MHz)	Level (dBμV/m)	Over Limit (dB)	Limit Line (dBμV/m)	Read Level (dBμV)	Antenna Factor (dB/m)	Cable Loss (dB)	Preamp Factor (dB)	Ant Pos (cm)	Table Pos (deg)	Peak Avg. (P/A)	Pol. (H/V)
802.11n HT40 CH 102 5510MHz		11019.02	46.44	-27.56	74	52.35	37.91	16.72	60.54	300	0	P	H
		11019.02	49.05	-24.95	74	54.96	37.91	16.72	60.54	300	0	P	V
802.11n HT40 CH 110 5550MHz		11099.1	45.52	-28.48	74	51.3	37.96	16.78	60.52	300	0	P	H
		16656	53.53	-14.77	68.3	49.27	42.19	20.76	58.69	100	0	P	H
		11099.1	49.92	-24.08	74	55.7	37.96	16.78	60.52	300	0	P	V
		16662	52.92	-15.38	68.3	48.66	42.19	20.76	58.69	100	0	P	V
802.11n HT40 CH 134 5670MHz		11339.33	44.89	-29.11	74	50.3	38.1	16.96	60.47	300	0	P	H
		17010	58.23	-10.07	68.3	52.84	42.57	21	58.18	100	0	P	H
		11339.33	48.41	-25.59	74	53.82	38.1	16.96	60.47	300	0	P	V
		17010	56.82	-11.48	68.3	51.43	42.57	21	58.18	100	0	P	V
Remark	1. No other spurious found. 2. All results are PASS against Peak and Average limit line.												



UNII 2C - 5470~5725MHz
WIFI 802.11ac VHT80 (Band Edge @ 3m)

WIFI Ant. 1	Note	Frequency (MHz)	Level (dBμV/m)	Over Limit (dB)	Limit Line (dBμV/m)	Read Level (dBμV)	Antenna Factor (dB/m)	Cable Loss (dB)	Preamp Factor (dB)	Ant Pos (cm)	Table Pos (deg)	Peak Avg. (P/A)	Pol. (H/V)
802.11ac VHT80 CH 106 5530MHz		5439.76	58.35	-15.65	74	42.84	34.7	11.52	30.71	102	116	P	H
		5470	60.26	-8.04	68.3	44.73	34.7	11.55	30.72	102	116	P	H
	!	5459.44	50.4	-3.6	54	34.89	34.7	11.53	30.72	102	116	A	H
	*	5524	99.29	-	-	83.73	34.7	11.6	30.74	102	116	P	H
		5524	91.24	-	-	75.68	34.7	11.6	30.74	102	116	A	H
		5741.96	57.55	-10.75	68.3	41.37	35.14	11.87	30.83	102	116	P	H
		5442.16	58.64	-15.36	74	43.13	34.7	11.52	30.71	100	69	P	V
		5468.4	57.6	-10.7	68.3	42.07	34.7	11.55	30.72	100	69	P	V
	!	5457.52	49.49	-4.51	54	33.98	34.7	11.53	30.72	100	69	A	V
	*	5536	97.84	-	-	82.27	34.7	11.61	30.74	100	69	P	V
		5536	90.21	-	-	74.64	34.7	11.61	30.74	100	69	A	V
		5752.2	56.92	-11.38	68.3	40.67	35.19	11.89	30.83	100	69	P	V
802.11ac VHT80 CH 122 5610MHz		5459.12	56.29	-17.71	74	40.78	34.7	11.53	30.72	101	116	P	H
		5470	55.76	-12.54	68.3	40.23	34.7	11.55	30.72	101	116	P	H
		5450.16	47.45	-6.55	54	31.93	34.7	11.53	30.71	101	116	A	H
	*	5602	99.58	-	-	83.97	34.7	11.67	30.76	101	116	P	H
		5602	91.32	-	-	75.71	34.7	11.67	30.76	101	116	A	H
		5725.32	57.27	-11.03	68.3	41.17	35.08	11.84	30.82	101	116	P	H
		5444.08	56.26	-17.74	74	40.75	34.7	11.52	30.71	100	72	P	V
		5460.72	55.71	-12.59	68.3	40.2	34.7	11.53	30.72	100	72	P	V
		5456.24	47.31	-6.69	54	31.8	34.7	11.53	30.72	100	72	A	V
	*	5602	97.46	-	-	81.85	34.7	11.67	30.76	100	72	P	V
	5602	89.78	-	-	74.17	34.7	11.67	30.76	100	72	A	V	
	5734.68	57.54	-10.76	68.3	41.35	35.14	11.87	30.82	100	72	P	V	

Remark	1. No other spurious found.
	2. All results are PASS against Peak and Average limit line.



UNII 2C 5470~5725MHz
WIFI 802.11ac VHT80 (Harmonic @ 3m)

Table with 14 columns: WIFI Ant., Note, Frequency (MHz), Level (dBµV/m), Over Limit (dB), Limit Line (dBµV/m), Read Level (dBµV), Antenna Factor (dB/m), Cable Loss (dB), Preamp Factor (dB), Ant Pos (cm), Table Pos (deg), Peak Avg. (P/A), Pol. (H/V). Rows include data for 802.11ac VHT80 CH 106 5530MHz and CH 122 5610MHz, plus a Remark section.



UNII 2C - Straddle Channel

WIFI 802.11a (Band Edge @ 3m)

WIFI	Note	Frequency	Level	Over	Limit	Read	Antenna	Cable	Preamp	Ant	Table	Peak	Pol.
Ant.				Limit	Line	Level	Factor	Loss	Factor	Pos	Pos	Avg.	
1		(MHz)	(dBμV/m)	(dB)	(dBμV/m)	(dBμV)	(dB/m)	(dB)	(dB)	(cm)	(deg)	(P/A)	(H/V)
802.11a CH 144 5720MHz	*	5722	107.39	-	-	91.29	35.08	11.84	30.82	400	0	P	H
		5722	99.85	-	-	83.75	35.08	11.84	30.82	400	0	A	H
	*	5722	105.48	-	-	89.38	35.08	11.84	30.82	100	0	P	V
		5722	97.48	-	-	81.38	35.08	11.84	30.82	100	0	A	V
Remark	1. No other spurious found. 2. All results are PASS against Peak and Average limit line.												

UNII 2C - Straddle Channel

WIFI 802.11a (Harmonic @ 3m)

WIFI	Note	Frequency	Level	Over	Limit	Read	Antenna	Cable	Preamp	Ant	Table	Peak	Pol.
Ant.				Limit	Line	Level	Factor	Loss	Factor	Pos	Pos	Avg.	
1		(MHz)	(dBμV/m)	(dB)	(dBμV/m)	(dBμV)	(dB/m)	(dB)	(dB)	(cm)	(deg)	(P/A)	(H/V)
802.11a CH 144 5720MHz		11439.44	48.3	-25.7	74	53.55	38.16	17.03	60.44	300	0	P	H
	!	17160	64.4	-3.9	68.3	58.96	42.3	21.13	57.99	100	222	P	H
		11439.44	55.7	-18.3	74	60.95	38.16	17.03	60.44	100	257	P	V
		11439.44	45.68	-8.32	54	50.93	38.16	17.03	60.44	100	257	A	V
		17160	57.88	-10.42	68.3	52.44	42.3	21.13	57.99	100	0	P	V
Remark	1. No other spurious found. 2. All results are PASS against Peak and Average limit line.												



UNII 2C - Straddle Channel
WIFI 802.11n HT20 (Band Edge @ 3m)

Table with 14 columns: WIFI Ant. 1, Note, Frequency (MHz), Level (dBµV/m), Over Limit (dB), Limit Line (dBµV/m), Read Level (dBµV), Antenna Factor (dB/m), Cable Loss (dB), Preamp Factor (dB), Ant Pos (cm), Table Pos (deg), Peak Avg. (P/A), Pol. (H/V). Rows include 802.11n HT20 and CH 144 5720MHz with various test results.

UNII 2C - Straddle Channel
WIFI 802.11n HT20 (Harmonic @ 3m)

Table with 14 columns: WIFI Ant. 1, Note, Frequency (MHz), Level (dBµV/m), Over Limit (dB), Limit Line (dBµV/m), Read Level (dBµV), Antenna Factor (dB/m), Cable Loss (dB), Preamp Factor (dB), Ant Pos (cm), Table Pos (deg), Peak Avg. (P/A), Pol. (H/V). Rows include 802.11n HT20 and CH 144 5720MHz with various test results.



**UNII 2C - Straddle Channel
WIFI 802.11n HT40 (Band Edge @ 3m)**

WIFI Ant. 1	Note	Frequency (MHz)	Level (dBμV/m)	Over Limit (dB)	Limit Line (dBμV/m)	Read Level (dBμV)	Antenna Factor (dB/m)	Cable Loss (dB)	Preamp Factor (dB)	Ant Pos (cm)	Table Pos (deg)	Peak Avg. (P/A)	Pol. (H/V)
802.11n	*	5716	104.46	-	-	88.42	35.03	11.82	30.81	400	0	P	H
HT40		5716	96.46	-	-	80.42	35.03	11.82	30.81	400	0	A	H
CH 142	*	5710	103.88	-	-	87.84	35.03	11.82	30.81	100	0	P	V
5710MHz		5710	95.88	-	-	79.84	35.03	11.82	30.81	100	0	A	V
Remark	1. No other spurious found. 2. All results are PASS against Peak and Average limit line.												

**UNII 2C - Straddle Channel
WIFI 802.11n HT40 (Harmonic @ 3m)**

WIFI Ant. 1	Note	Frequency (MHz)	Level (dBμV/m)	Over Limit (dB)	Limit Line (dBμV/m)	Read Level (dBμV)	Antenna Factor (dB/m)	Cable Loss (dB)	Preamp Factor (dB)	Ant Pos (cm)	Table Pos (deg)	Peak Avg. (P/A)	Pol. (H/V)
802.11n		11419.42	45	-29	74	50.28	38.15	17.02	60.45	300	0	P	H
HT40		17148	57.01	-11.29	68.3	51.57	42.33	21.12	58.01	100	0	P	H
CH 142		11424.42	50.38	-23.62	74	55.66	38.15	17.02	60.45	300	0	P	V
5710MHz		17124	56.24	-12.06	68.3	50.82	42.39	21.09	58.06	100	0	P	V
Remark	1. No other spurious found. 2. All results are PASS against Peak and Average limit line.												



UNII 2C - Straddle Channel
WIFI 802.11ac VHT80 (Band Edge @ 3m)

Table with 14 columns: WIFI Ant. 1, Note, Frequency (MHz), Level (dBµV/m), Over Limit (dB), Limit Line (dBµV/m), Read Level (dBµV), Antenna Factor (dB/m), Cable Loss (dB), Preamp Factor (dB), Ant Pos (cm), Table Pos (deg), Peak Avg. (P/A), Pol. (H/V). Rows include 802.11ac VHT80 and CH 138 5690MHz.

UNII 2C - Straddle Channel
WIFI 802.11ac VHT80 (Harmonic @ 3m)

Table with 14 columns: WIFI Ant. 1, Note, Frequency (MHz), Level (dBµV/m), Over Limit (dB), Limit Line (dBµV/m), Read Level (dBµV), Antenna Factor (dB/m), Cable Loss (dB), Preamp Factor (dB), Ant Pos (cm), Table Pos (deg), Peak Avg. (P/A), Pol. (H/V). Rows include 802.11ac VHT80 and CH 138 5690MHz.



Emission below 1GHz
WIFI 802.11n HT40 (LF @ 3m)

WIFI	Note	Frequency	Level	Over	Limit	Read	Antenna	Cable	Preamp	Ant	Table	Peak	Pol.
Ant.				Limit	Line	Level	Factor	Loss	Factor	Pos	Pos	Avg.	
1		(MHz)	(dBμV/m)	(dB)	(dBμV/m)	(dBμV)	(dB/m)	(dB)	(dB)	(cm)	(deg)	(P/A)	(H/V)
802.11n HT40 LF		30.97	18.93	-21.07	40	25.48	24.81	0.84	32.2	-	-	P	H
		154.16	24.53	-18.97	43.5	37.51	16.95	2.17	32.1	-	-	P	H
		171.62	24.42	-19.08	43.5	37.93	16.31	2.28	32.1	-	-	P	H
		225.94	22.28	-23.72	46	35.87	15.94	2.62	32.15	-	-	P	H
		319.06	32.18	-13.82	46	41.61	19.59	3.12	32.14	215	132	P	H
		442.25	23.83	-22.17	46	29.35	23.02	3.68	32.22	-	-	P	H
		46.49	28.06	-11.94	40	42.73	16.35	1.18	32.2	100	169	P	V
		152.22	23.77	-19.73	43.5	36.62	17.1	2.15	32.1	-	-	P	V
		174.53	23.6	-19.9	43.5	37.48	15.92	2.3	32.1	-	-	P	V
		206.54	23.52	-19.98	43.5	37.88	15.24	2.51	32.11	-	-	P	V
		299.66	23.29	-22.71	46	32.9	19.46	3.03	32.1	-	-	P	V
	449.04	24.08	-21.92	46	29.38	23.19	3.71	32.2	-	-	P	V	
Remark	1. No other spurious found. 2. All results are PASS against limit line.												



Note symbol

*	Fundamental Frequency which can be ignored. However, the level of any unwanted emissions shall not exceed the level of the fundamental frequency.
!	Test result is not under limit 6dB.
P/A	P eak or A verage
H/V	H orizontal or V ertical



A calculation example for radiated spurious emission is shown as below:

WIFI	Note	Frequency	Level	Over	Limit	Read	Antenna	Cable	Preamp	Ant	Table	Peak	Pol.
Ant.				Limit	Line	Level	Factor	Loss	Factor	Pos	Pos	Avg.	
1		(MHz)	(dBμV/m)	(dB)	(dBμV/m)	(dBμV)	(dB/m)	(dB)	(dB)	(cm)	(deg)	(P/A)	(H/V)
802.11b		2390	55.45	-18.55	74	54.51	32.22	4.58	35.86	103	308	P	H
CH 01													
2412MHz		2390	43.54	-10.46	54	42.6	32.22	4.58	35.86	103	308	A	H

- Level(dBμV/m) =
Antenna Factor(dB/m) + Cable Loss(dB) + Read Level(dBμV) - Preamp Factor(dB)
- Over Limit(dB) = Level(dBμV/m) – Limit Line(dBμV/m)

For Peak Limit @ 2390MHz:

- Level(dBμV/m)
= Antenna Factor(dB/m) + Cable Loss(dB) + Read Level(dBμV) - Preamp Factor(dB)
= 32.22(dB/m) + 4.58(dB) + 54.51(dBμV) – 35.86 (dB)
= 55.45 (dBμV/m)
- Over Limit(dB)
= Level(dBμV/m) – Limit Line(dBμV/m)
= 55.45(dBμV/m) – 74(dBμV/m)
= -18.55(dB)

For Average Limit @ 2390MHz:

- Level(dBμV/m)
= Antenna Factor(dB/m) + Cable Loss(dB) + Read Level(dBμV) - Preamp Factor(dB)
= 32.22(dB/m) + 4.58(dB) + 42.6(dBμV) – 35.86 (dB)
= 43.54 (dBμV/m)
- Over Limit(dB)
= Level(dBμV/m) – Limit Line(dBμV/m)
= 43.54(dBμV/m) – 54(dBμV/m)
= -10.46(dB)

Both peak and average measured complies with the limit line, so test result is “PASS”.



Appendix D. Duty Cycle Plots

Band	Duty Cycle(%)	T(ms)	1/T(kHz)	VBW Setting
802.11a	98.28	-	-	10Hz
802.11n HT20	98.16	-	-	10Hz
802.11n HT40	96.32	0.949	1.053	1.1KHz
802.11ac VHT80	92.77	0.465	2.150	2.2KHz

802.11a

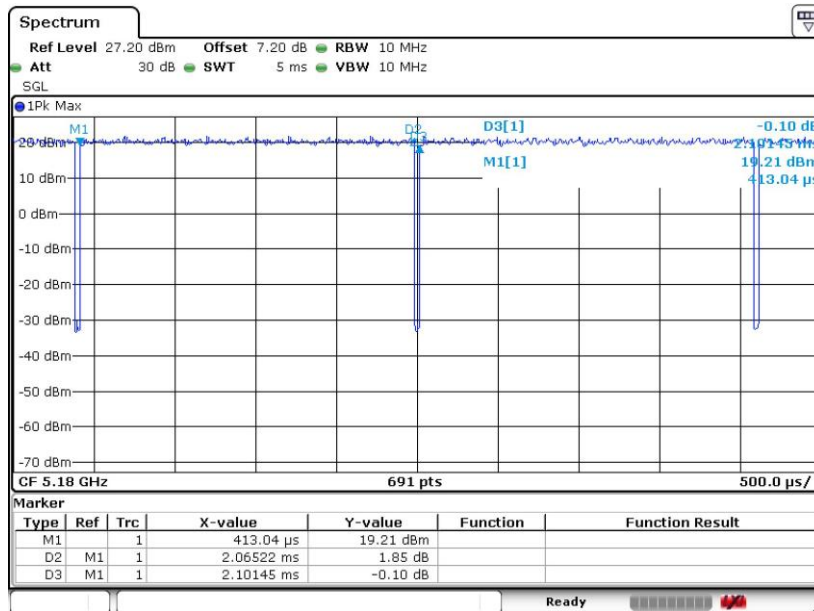

Date: 15.APR.2021 20:37:05



802.11n HT20

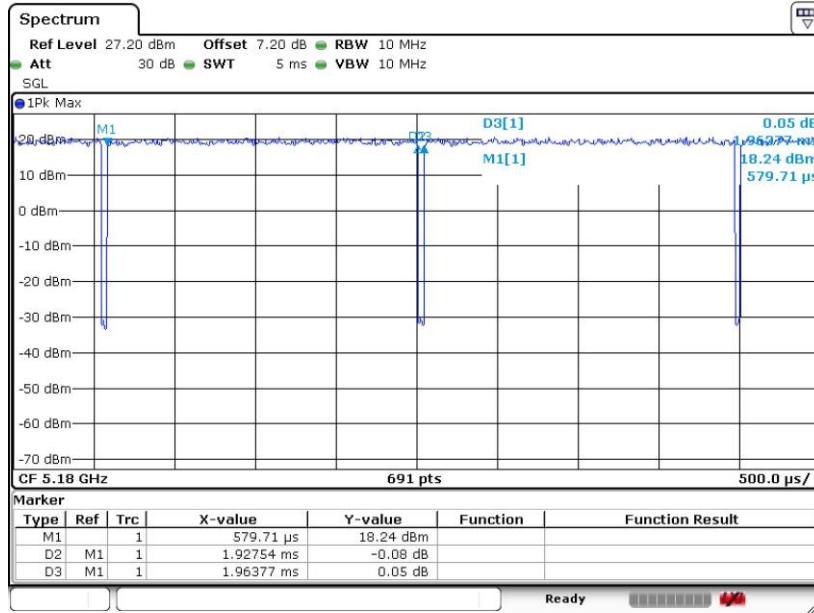

Date: 15.APR.2021 21:07:07

802.11n HT40

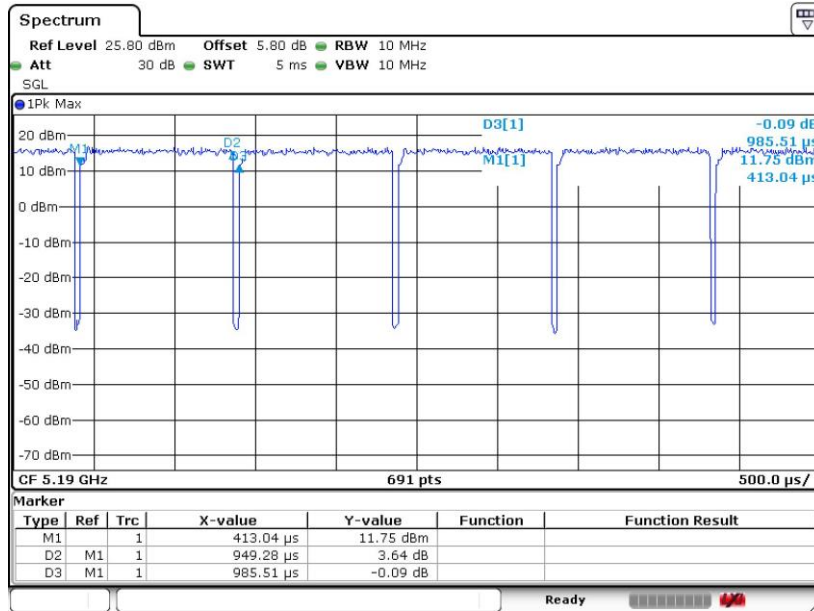

Date: 15.APR.2021 15:28:41



802.11ac VHT80

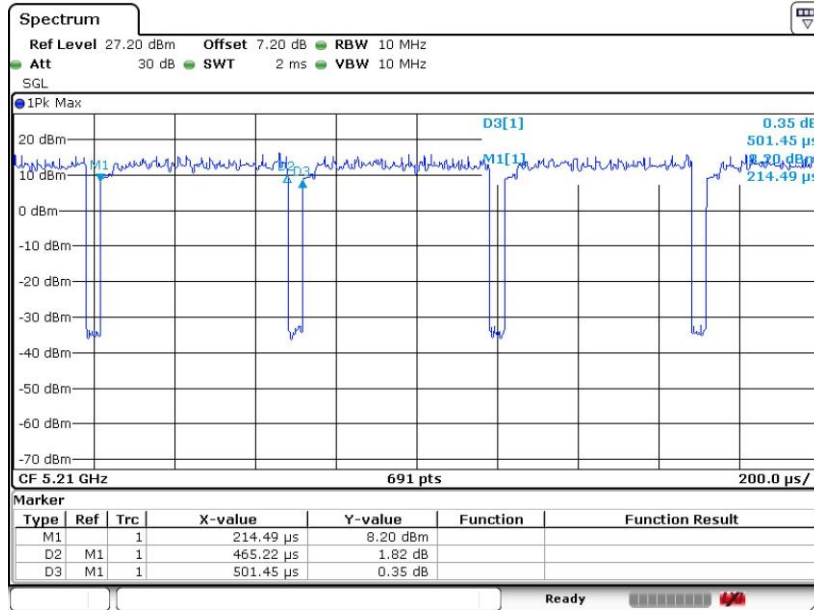

Date: 15.APR.2021 21:49:36