

FCC SAR Test Report

Report No. : SA200304W004
Applicant : Xiaomi Communications Co., Ltd.
Address : #019, 9th Floor, Building 6, 33 Xi'erqi Middle Road, Haidian District, Beijing, China,10085
Product : Mobile Phone
FCC ID : 2AFZZJ6B2G
Brand : Redmi
Model No. : M2003J6B2G
Standards : FCC 47 CFR Part 2 (2.1093) / IEEE C95.1:1992 / IEEE 1528:2013
KDB 865664 D01 v01r04 / KDB 865664 D02 v01r02 / KDB 248227 D01 v02r02
KDB 447498 D01 v06 / KDB 648474 D04 v01r03 / KDB 941225 D01 v03r01
KDB 941225 D05 v02r05 / KDB 941225 D05A v01r02 / KDB 941225 D06 v02r01
Sample Received Date : Mar. 09, 2020
Date of Testing : Mar. 17, 2020 ~ Mar. 28, 2020
FCC Designation No. : CN1171

CERTIFICATION: The above equipment have been tested by **BV 7LAYERS COMMUNICATIONS TECHNOLOGY (SHENZHEN) CO. LTD.**, and found compliance with the requirement of the above standards. The test record, data evaluation & Equipment Under Test (EUT) configurations represented herein are true and accurate accounts of the measurements of the sample's SAR characteristics under the conditions specified in this report. It should not be reproduced except in full, without the written approval of our laboratory. The client should not use it to claim product certification, approval, or endorsement by A2LA or any government agencies.

Prepared By : Wiky Zhang
Wiky Zhang / Engineer

Approved By : Luke Lu
Luke Lu / Manager



This report is governed by, and incorporates by reference, CPS Conditions of Service as posted at the date of issuance of this report at <http://www.bureauveritas.com/home/about-us/our-business/cps/about-us/terms-conditions/> and is intended for your exclusive use. Any copying or replication of this report to or for any other person or entity, or use of our name or trademark, is permitted only with our prior written permission. This report sets forth our findings solely with respect to the test samples identified herein. The results set forth in this report are not indicative or representative of the quality or characteristics of the lot from which a test sample was taken or any similar or identical product unless specifically and expressly noted. Our report includes all of the tests requested by you and the results thereof based upon the information that you provided to us. Measurement uncertainty is only provided upon request for accredited tests. You have 60 days from date of issuance of this report to notify us of any material error or omission caused by our negligence or if you require measurement uncertainty; provided, however, that such notice shall be in writing and shall specifically address the issue you wish to raise. A failure to raise such issue within the prescribed time shall constitute your unqualified acceptance of the completeness of this report, the tests conducted and the correctness of the report contents.

Table of Contents

Release Control Record	3
1. Summary of Maximum SAR Value	4
2. Description of Equipment Under Test	5
3. SAR Measurement System	6
3.1 Definition of Specific Absorption Rate (SAR)	6
3.2 SPEAG DASY System	6
3.2.1 Robot	7
3.2.2 Probes	8
3.2.3 Data Acquisition Electronics (DAE)	8
3.2.4 Phantoms	9
3.2.5 Device Holder	10
3.2.6 System Validation Dipoles	10
3.2.7 Tissue Simulating Liquids	11
3.3 SAR System Verification	13
3.4 SAR Measurement Procedure	14
3.4.1 Area & Zoom Scan Procedure	14
3.4.2 Volume Scan Procedure	14
3.4.3 Power Drift Monitoring	15
3.4.4 Spatial Peak SAR Evaluation	15
3.4.5 SAR Averaged Methods	15
4. SAR Measurement Evaluation	16
4.1 EUT Configuration and Setting	16
4.2 EUT Testing Position	25
4.2.1 Head Exposure Conditions	25
4.2.2 Body-worn Accessory Exposure Conditions	27
4.2.3 Hotspot Mode Exposure Conditions	28
4.2.4 Extremity Exposure Conditions	29
4.2.5 SAR Test Exclusion Evaluations	29
4.3 Tissue Verification	30
4.4 System Validation	30
4.5 System Verification	30
4.6 Maximum Output Power	31
4.6.1 Maximum Conducted Power	31
4.6.2 Measured Conducted Power Result	32
4.7 SAR Testing Results	63
4.7.1 SAR Test Reduction Considerations	63
4.7.2 SAR Results for Head Exposure Condition	67
4.7.3 SAR Results for Body-worn Exposure Condition (Separation Distance is 1.5 cm Gap)	70
4.7.4 SAR Results for Hotspot Exposure Condition (Separation Distance is 1.0 cm Gap)	72
4.7.5 SAR Results for Extremity Exposure Condition (Separation Distance is 0 cm Gap)	76
4.7.6 SAR Measurement Variability	78
5. Calibration of Test Equipment	91
6. Measurement Uncertainty	91
7. Information on the Testing Laboratories	92
Appendix A. SAR Plots of System Verification	
Appendix B. SAR Plots of SAR Measurement	
Appendix C. Calibration Certificate for Probe and Dipole	
Appendix D. Photographs of EUT and Setup	



Release Control Record

Report No.	Reason for Change	Date Issued
SA200304W004	Initial release	Mar. 31, 2020

1. Summary of Maximum SAR Value

Equipment Class	Mode	Highest Reported Head SAR _{1g} (W/kg)	Highest Reported Body-worn SAR _{1g} (1.5 cm Gap) (W/kg)	Highest Reported Hotspot SAR _{1g} (1.0 cm Gap) (W/kg)	Highest Reported Extremity SAR _{10g} (0 cm Gap) (W/kg)
PCE	GSM850	0.75	0.12	0.26	N/A
	GSM1900	0.03	0.23	0.72	N/A
	WCDMA II	0.08	0.71	0.97	2.49
	WCDMA IV	0.09	0.30	0.68	2.47
	WCDMA V	0.86	0.15	0.28	N/A
	LTE 2	0.07	0.34	1.04	2.63
	LTE 4	0.07	0.28	0.65	2.27
	LTE 5	0.87	0.15	0.24	N/A
	LTE 7	0.12	0.47	0.96	2.09
	LTE 38	0.07	0.35	0.97	0.83
LTE 41	0.07	0.38	0.93	0.87	
DTS	2.4G WLAN	0.74	0.11	0.20	N/A
NII	5.2G WLAN	N/A	N/A	0.19	N/A
	5.3G WLAN	0.54	0.08	N/A	0.41
	5.6G WLAN	0.58	0.09	N/A	0.38
	5.8G WLAN	0.58	0.09	0.18	N/A
DSS	Bluetooth	0.12	0.01	0.06	N/A
Highest Simultaneous Transmission SAR		Head (W/kg)	Body-worn (W/kg)	Hotspot (W/kg)	Extremity (W/kg)
		1.48	0.84	1.04	2.63

Note:

- The SAR limit (Head & Body: SAR_{1g} 1.6 W/kg, Extremity: SAR_{10g} 4.0 W/kg) for general population / uncontrolled exposure is specified in FCC 47 CFR part 2 (2.1093) and ANSI/IEEE C95.1-1992.

FCC SAR Test Report

2. Description of Equipment Under Test

EUT Type	Mobile Phone
FCC ID	2AFZZJ6B2G
Brand Name	Redmi
Model Name	M2003J6B2G
Tx Frequency Bands (Unit: MHz)	GSM850 : 824.2 ~ 848.8 GSM1900 : 1850.2 ~ 1909.8 WCDMA Band II : 1852.4 ~ 1907.6 WCDMA Band IV : 1712.4 ~ 1752.6 WCDMA Band V : 826.4 ~ 846.6 LTE Band 2 : 1850.7 ~ 1909.3 LTE Band 4 : 1710.7 ~ 1754.3 LTE Band 5 : 824.7 ~ 848.3 LTE Band 7 : 2502.5 ~ 2567.5 LTE Band 38 : 2572.5 ~ 2617.5 LTE Band 41 : 2535 ~ 2655 WLAN : 2412 ~ 2462, 5180 ~ 5240, 5260 ~ 5320, 5500 ~ 5700, 5745 ~ 5805 Bluetooth : 2402 ~ 2480 NFC : 13.56
Uplink Modulations	GSM & GPRS : GMSK EDGE : 8PSK WCDMA : QPSK , 16QAM LTE : QPSK, 16QAM, 64QAM 802.11b : DSSS 802.11a/g/n/ac : OFDM Bluetooth : GFSK, $\pi/4$ -DQPSK, 8-DPSK
Maximum Tune-up Conducted Power (Unit: dBm)	Please refer to section 4.6.1 of this report
Antenna Type	WLAN: Fixed Internal Antenna WWAN: Fixed Internal Antenna
EUT Stage	Identical Prototype

Note:

- The above EUT information is declared by manufacturer and for more detailed features description please refers to the manufacturer's specifications or User's Manual.
- Power reduction for RF exposure consideration

Position	Audio Receiver	SAR sensor	TX Power reduce
Body	Off	<=16mm	Yes
	Off	>16mm	No
Head	On	N/A	No

3. SAR Measurement System

3.1 Definition of Specific Absorption Rate (SAR)

SAR is related to the rate at which energy is absorbed per unit mass in an object exposed to a radio field. The SAR distribution in a biological body is complicated and is usually carried out by experimental techniques or numerical modeling. The standard recommends limits for two tiers of groups, occupational/controlled and general population/uncontrolled, based on a person’s awareness and ability to exercise control over his or her exposure. In general, occupational/controlled exposure limits are higher than the limits for general population/uncontrolled.

The SAR definition is the time derivative (rate) of the incremental energy (dW) absorbed by (dissipated in) an incremental mass (dm) contained in a volume element (dv) of a given density (ρ). The equation description is as below:

$$SAR = \frac{d}{dt} \left(\frac{dW}{dm} \right) = \frac{d}{dt} \left(\frac{dW}{\rho dv} \right)$$

SAR is expressed in units of Watts per kilogram (W/kg)

SAR measurement can be related to the electrical field in the tissue by

$$SAR = \frac{\sigma |E|^2}{\rho}$$

Where: σ is the conductivity of the tissue, ρ is the mass density of the tissue and E is the RMS electrical field strength.

3.2 SPEAG DASY System

DASY system consists of high precision robot, probe alignment sensor, phantom, robot controller, controlled measurement server and near-field probe. The robot includes six axes that can move to the precision position of the DASY5 software defined. The DASY software can define the area that is detected by the probe. The robot is connected to controlled box. Controlled measurement server is connected to the controlled robot box. The DAE includes amplifier, signal multiplexing, AD converter, offset measurement and surface detection. It is connected to the Electro-optical coupler (ECO). The ECO performs the conversion form the optical into digital electric signal of the DAE and transfers data to the PC.

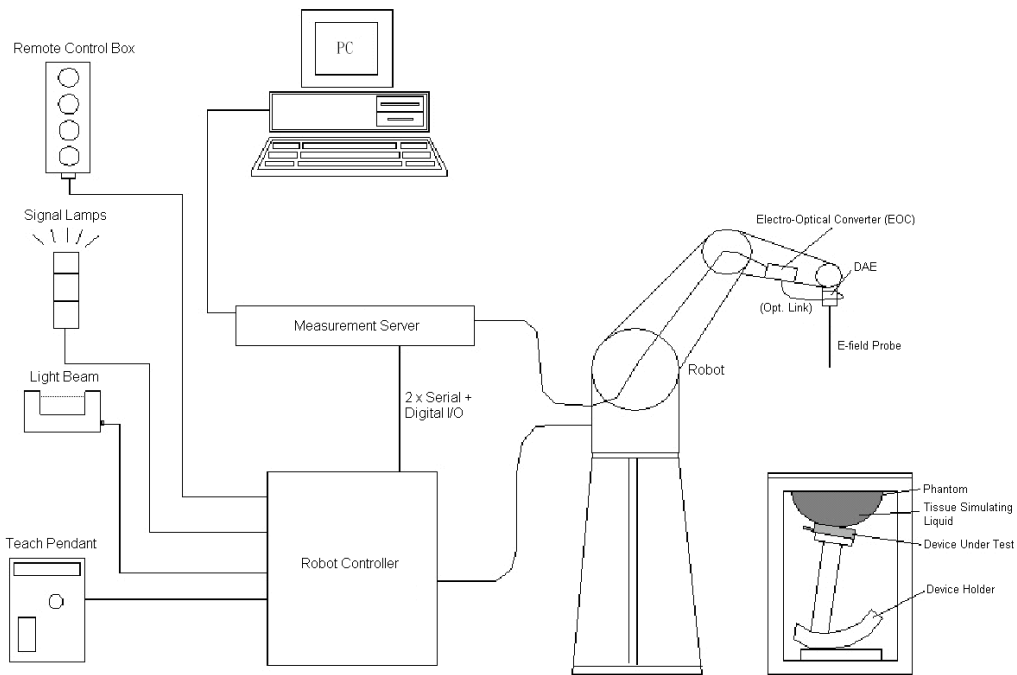

Fig-3.1 DASY System Setup

3.2.1 Robot

The DASY system uses the high precision robots from Stäubli SA (France). For the 6-axis controller system, the robot controller version (DASY5: CS8c) from Stäubli is used. The Stäubli robot series have many features that are important for our application:

- High precision (repeatability ± 0.035 mm)
- High reliability (industrial design)
- Jerk-free straight movements
- Low ELF interference (the closed metallic construction shields against motor control fields)

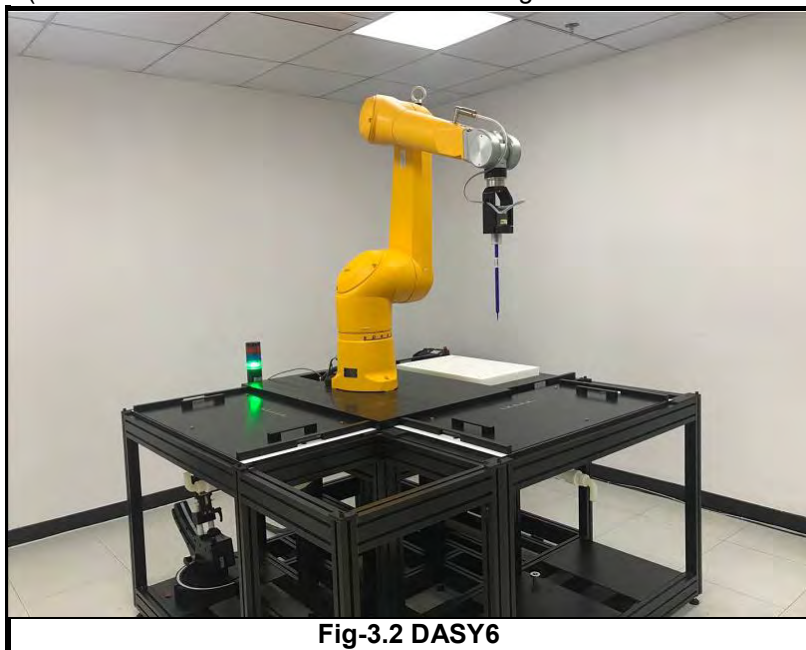



Fig-3.2 DASY6

FCC SAR Test Report

3.2.2 Probes

The SAR measurement is conducted with the dosimetric probe. The probe is specially designed and calibrated for use in liquid with high permittivity. The dosimetric probe has special calibration in liquid at different frequency.

Model	EX3DV4	
Construction	Symmetrical design with triangular core. Built-in shielding against static charges. PEEK enclosure material (resistant to organic solvents, e.g., DGBE).	
Frequency	10 MHz to 6 GHz Linearity: ± 0.2 dB	
Directivity	± 0.3 dB in HSL (rotation around probe axis) ± 0.5 dB in tissue material (rotation normal to probe axis)	
Dynamic Range	10 μ W/g to 100 mW/g Linearity: ± 0.2 dB (noise: typically < 1 μ W/g)	
Dimensions	Overall length: 337 mm (Tip: 20 mm) Tip diameter: 2.5 mm (Body: 12 mm) Typical distance from probe tip to dipole centers: 1 mm	

Model	ES3DV3	
Construction	Symmetrical design with triangular core. Interleaved sensors. Built-in shielding against static charges. PEEK enclosure material (resistant to organic solvents, e.g., DGBE).	
Frequency	10 MHz to 4 GHz Linearity: ± 0.2 dB	
Directivity	± 0.2 dB in HSL (rotation around probe axis) ± 0.3 dB in tissue material (rotation normal to probe axis)	
Dynamic Range	5 μ W/g to 100 mW/g Linearity: ± 0.2 dB	
Dimensions	Overall length: 337 mm (Tip: 20 mm) Tip diameter: 3.9 mm (Body: 12 mm) Distance from probe tip to dipole centers: 2.0 mm	

3.2.3 Data Acquisition Electronics (DAE)

Model	DAE3, DAE4	
Construction	Signal amplifier, multiplexer, A/D converter and control logic. Serial optical link for communication with DASY embedded system (fully remote controlled). Two step probe touch detector for mechanical surface detection and emergency robot stop.	
Measurement Range	-100 to +300 mV (16 bit resolution and two range settings: 4mV, 400mV)	
Input Offset Voltage	< 5 μ V (with auto zero)	
Input Bias Current	< 50 fA	
Dimensions	60 x 60 x 68 mm	

FCC SAR Test Report

3.2.4 Phantoms

Model	Twin SAM	
Construction	The shell corresponds to the specifications of the Specific Anthropomorphic Mannequin (SAM) phantom defined in IEEE 1528 and IEC 62209-1. It enables the dosimetric evaluation of left and right hand phone usage as well as body mounted usage at the flat phantom region. A cover prevents evaporation of the liquid. Reference markings on the phantom allow the complete setup of all predefined phantom positions and measurement grids by teaching three points with the robot.	
Material	Vinylester, glass fiber reinforced (VE-GF)	
Shell Thickness	2 ± 0.2 mm (6 ± 0.2 mm at ear point)	
Dimensions	Length: 1000 mm Width: 500 mm Height: adjustable feet	
Filling Volume	approx. 25 liters	

Model	ELI	
Construction	Phantom for compliance testing of handheld and body-mounted wireless devices in the frequency range of 30 MHz to 6 GHz. ELI is fully compatible with the IEC 62209-2 standard and all known tissue simulating liquids. ELI has been optimized regarding its performance and can be integrated into our standard phantom tables. A cover prevents evaporation of the liquid. Reference markings on the phantom allow installation of the complete setup, including all predefined phantom positions and measurement grids, by teaching three points. The phantom is compatible with all SPEAG dosimetric probes and dipoles.	
Material	Vinylester, glass fiber reinforced (VE-GF)	
Shell Thickness	2.0 ± 0.2 mm (bottom plate)	
Dimensions	Major axis: 600 mm Minor axis: 400 mm	
Filling Volume	approx. 30 liters	

FCC SAR Test Report

3.2.5 Device Holder

Model	Mounting Device	
Construction	In combination with the Twin SAM Phantom or ELI4, the Mounting Device enables the rotation of the mounted transmitter device in spherical coordinates. Rotation point is the ear opening point. Transmitter devices can be easily and accurately positioned according to IEC, IEEE, FCC or other specifications. The device holder can be locked for positioning at different phantom sections (left head, right head, flat).	
Material	POM	

Model	Laptop Extensions Kit	
Construction	Simple but effective and easy-to-use extension for Mounting Device that facilitates the testing of larger devices according to IEC 62209-2 (e.g., laptops, cameras, etc.). It is lightweight and fits easily on the upper part of the Mounting Device in place of the phone positioner.	
Material	POM, Acrylic glass, Foam	

3.2.6 System Validation Dipoles

Model	D-Serial	
Construction	Symmetrical dipole with 1/4 balun. Enables measurement of feed point impedance with NWA. Matched for use near flat phantoms filled with tissue simulating solutions.	
Frequency	750 MHz to 5800 MHz	
Return Loss	> 20 dB	
Power Capability	> 100 W (f < 1GHz), > 40 W (f > 1GHz)	

3.2.7 Tissue Simulating Liquids

For SAR measurement of the field distribution inside the phantom, the phantom must be filled with homogeneous tissue simulating liquid to a depth of at least 15 cm. For head SAR testing, the liquid height from the ear reference point (ERP) of the phantom to the liquid top surface is larger than 15 cm. For body SAR testing, the liquid height from the center of the flat phantom to the liquid top surface is larger than 15 cm. The nominal dielectric values of the tissue simulating liquids in the phantom and the tolerance of 5% are listed in Table-3.1.

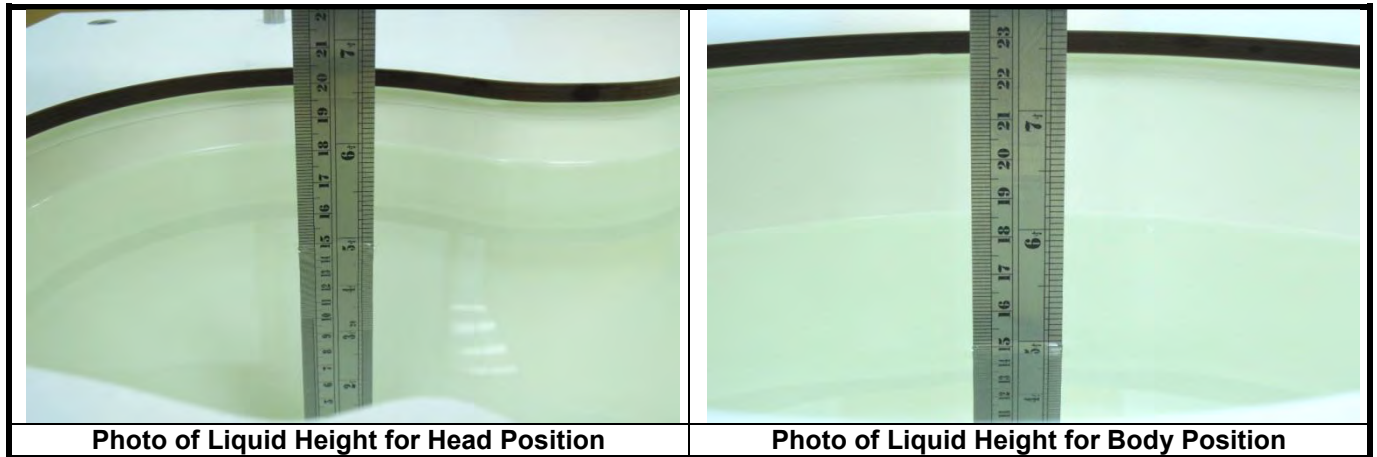

The dielectric properties of the head tissue simulating liquids are defined in IEEE 1528, and KDB 865664 D01 Appendix A. The dielectric properties of the tissue simulating liquids were verified prior to the SAR evaluation using a dielectric assessment kit and a network analyzer.

Table-3.1 Targets of Tissue Simulating Liquid

Frequency (MHz)	Target Permittivity	Range of $\pm 5\%$	Target Conductivity	Range of $\pm 5\%$
For Head				
750	41.9	39.8 ~ 44.0	0.89	0.85 ~ 0.93
835	41.5	39.4 ~ 43.6	0.90	0.86 ~ 0.95
900	41.5	39.4 ~ 43.6	0.97	0.92 ~ 1.02
1450	40.5	38.5 ~ 42.5	1.20	1.14 ~ 1.26
1640	40.3	38.3 ~ 42.3	1.29	1.23 ~ 1.35
1750	40.1	38.1 ~ 42.1	1.37	1.30 ~ 1.44
1800	40.0	38.0 ~ 42.0	1.40	1.33 ~ 1.47
1900	40.0	38.0 ~ 42.0	1.40	1.33 ~ 1.47
2000	40.0	38.0 ~ 42.0	1.40	1.33 ~ 1.47
2300	39.5	37.5 ~ 41.5	1.67	1.59 ~ 1.75
2450	39.2	37.2 ~ 41.2	1.80	1.71 ~ 1.89
2600	39.0	37.1 ~ 41.0	1.96	1.86 ~ 2.06
3500	37.9	36.0 ~ 39.8	2.91	2.76 ~ 3.06
5200	36.0	34.2 ~ 37.8	4.66	4.43 ~ 4.89
5300	35.9	34.1 ~ 37.7	4.76	4.52 ~ 5.00
5500	35.6	33.8 ~ 37.4	4.96	4.71 ~ 5.21
5600	35.5	33.7 ~ 37.3	5.07	4.82 ~ 5.32
5800	35.3	33.5 ~ 37.1	5.27	5.01 ~ 5.53

The following table gives the recipes for tissue simulating liquids.

Table-3.2 Recipes of Tissue Simulating Liquid

Tissue Type	Bactericide	DGBE	HEC	NaCl	Sucrose	Triton X-100	Water	Diethylene Glycol Mono-hexylether
H750	0.2	-	0.2	1.5	56.0	-	42.1	-
H835	0.2	-	0.2	1.5	57.0	-	41.1	-
H900	0.2	-	0.2	1.4	58.0	-	40.2	-
H1450	-	43.3	-	0.6	-	-	56.1	-
H1640	-	45.8	-	0.5	-	-	53.7	-
H1750	-	47.0	-	0.4	-	-	52.6	-
H1800	-	44.5	-	0.3	-	-	55.2	-
H1900	-	44.5	-	0.2	-	-	55.3	-
H2000	-	44.5	-	0.1	-	-	55.4	-
H2300	-	44.9	-	0.1	-	-	55.0	-
H2450	-	45.0	-	0.1	-	-	54.9	-
H2600	-	45.1	-	0.1	-	-	54.8	-
H3500	-	8.0	-	0.2	-	20.0	71.8	-
H5G	-	-	-	-	-	17.2	65.5	17.3

3.3 SAR System Verification

The system check verifies that the system operates within its specifications. It is performed daily or before every SAR measurement. The system check uses normal SAR measurements in the flat section of the phantom with a matched dipole at a specified distance. The system verification setup is shown as below.

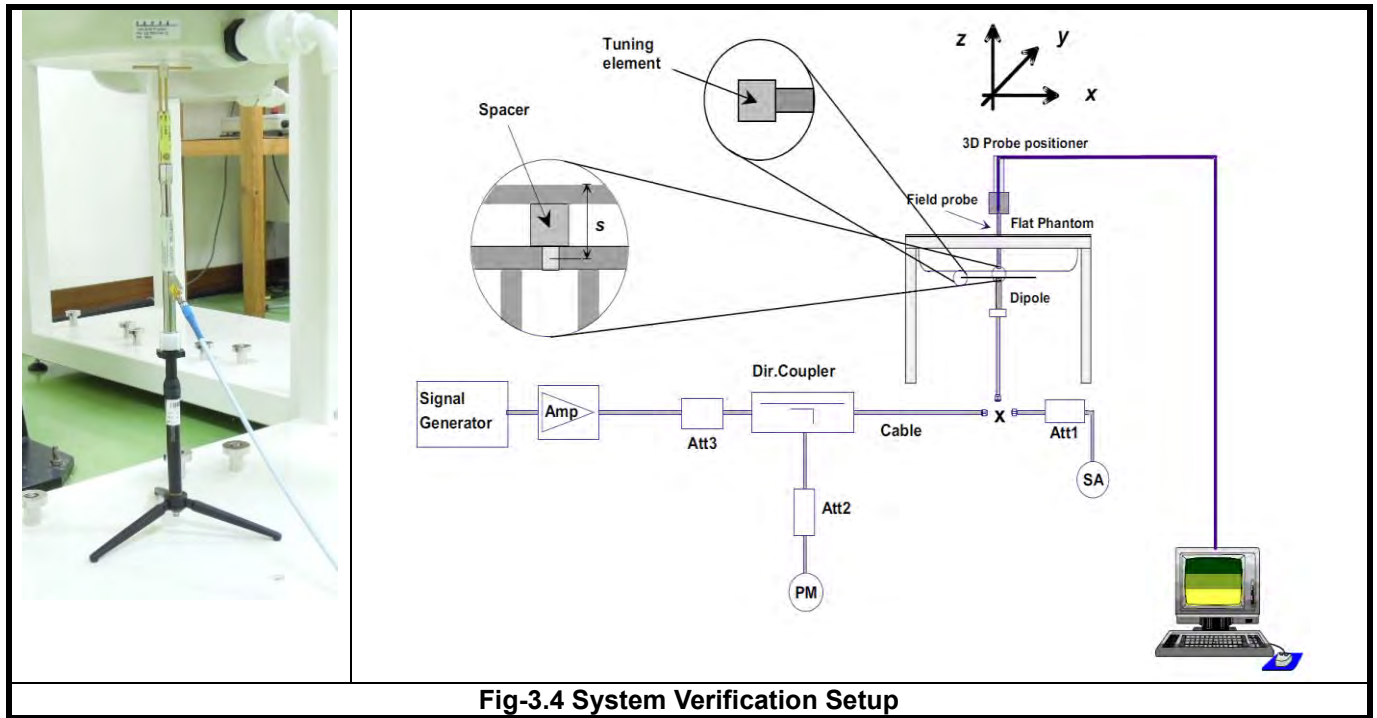

Fig-3.4 System Verification Setup

The validation dipole is placed beneath the flat phantom with the specific spacer in place. The distance spacer is touch the phantom surface with a light pressure at the reference marking and be oriented parallel to the long side of the phantom. The spectrum analyzer measures the forward power at the location of the system check dipole connector. The signal generator is adjusted for the desired forward power (250 mW is used for 700 MHz to 3 GHz, 100 mW is used for 3.5 GHz to 6 GHz) at the dipole connector and the power meter is read at that level. After connecting the cable to the dipole, the signal generator is readjusted for the same reading at power meter.

After system check testing, the SAR result will be normalized to 1W forward input power and compared with the reference SAR value derived from validation dipole certificate report. The deviation of system check should be within 10 %.

3.4 SAR Measurement Procedure

According to the SAR test standard, the recommended procedure for assessing the peak spatial-average SAR value consists of the following steps:

- (a) Power reference measurement
- (b) Area scan
- (c) Zoom scan
- (d) Power drift measurement

The SAR measurement procedures for each of test conditions are as follows:

- (a) Make EUT to transmit maximum output power
- (b) Measure conducted output power through RF cable
- (c) Place the EUT in the specific position of phantom
- (d) Perform SAR testing steps on the DASY system
- (e) Record the SAR value

3.4.1 Area & Zoom Scan Procedure

First Area Scan is used to locate the approximate location(s) of the local peak SAR value(s). The measurement grid within an Area Scan is defined by the grid extent, grid step size and grid offset. Next, in order to determine the EM field distribution in a three-dimensional spatial extension, Zoom Scan is required. The Zoom Scan is performed around the highest E-field value to determine the averaged SAR-distribution over 10 g. According to KDB 865664 D01, the resolution for Area and Zoom scan is specified in the table below.

Items	<= 2 GHz	2-3 GHz	3-4 GHz	4-5 GHz	5-6 GHz
Area Scan ($\Delta x, \Delta y$)	<= 15 mm	<= 12 mm	<= 12 mm	<= 10 mm	<= 10 mm
Zoom Scan ($\Delta x, \Delta y$)	<= 8 mm	<= 5 mm	<= 5 mm	<= 4 mm	<= 4 mm
Zoom Scan (Δz)	<= 5 mm	<= 5 mm	<= 4 mm	<= 3 mm	<= 2 mm
Zoom Scan Volume	>= 30 mm	>= 30 mm	>= 28 mm	>= 25 mm	>= 22 mm

Note:

When zoom scan is required and report SAR is <= 1.4 W/kg, the zoom scan resolution of $\Delta x / \Delta y$ (2-3GHz: <= 8 mm, 3-4GHz: <= 7 mm, 4-6GHz: <= 5 mm) may be applied.

3.4.2 Volume Scan Procedure

The volume scan is used for assess overlapping SAR distributions for antennas transmitting in different frequency bands. It is equivalent to an oversized zoom scan used in standalone measurements. The measurement volume will be used to enclose all the simultaneous transmitting antennas. For antennas transmitting simultaneously in different frequency bands, the volume scan is measured separately in each frequency band. In order to sum correctly to compute the 1g aggregate SAR, the EUT remain in the same test position for all measurements and all volume scan use the same spatial resolution and grid spacing. When all volume scan were completed, the software, SEMCAD postprocessor can combine and subsequently superpose these measurement data to calculating the multiband SAR.

3.4.3 Power Drift Monitoring

All SAR testing is under the EUT install full charged battery and transmit maximum output power. In DASY measurement software, the power reference measurement and power drift measurement procedures are used for monitoring the power drift of EUT during SAR test. Both these procedures measure the field at a specified reference position before and after the SAR testing. The software will calculate the field difference in dB. If the power drift more than 5%, the SAR will be retested.

3.4.4 Spatial Peak SAR Evaluation

The procedure for spatial peak SAR evaluation has been implemented according to the test standard. It can be conducted for 1g and 10g, as well as for user-specific masses. The DASY software includes all numerical procedures necessary to evaluate the spatial peak SAR value.

The base for the evaluation is a "cube" measurement. The measured volume must include the 1g and 10g cubes with the highest averaged SAR values. For that purpose, the center of the measured volume is aligned to the interpolated peak SAR value of a previously performed area scan.

The entire evaluation of the spatial peak values is performed within the post-processing engine (SEMCAD). The system always gives the maximum values for the 1g and 10g cubes. The algorithm to find the cube with highest averaged SAR is divided into the following stages:

- (a) Extraction of the measured data (grid and values) from the Zoom Scan
- (b) Calculation of the SAR value at every measurement point based on all stored data (A/D values and measurement parameters)
- (c) Generation of a high-resolution mesh within the measured volume
- (d) Interpolation of all measured values from the measurement grid to the high-resolution grid
- (e) Extrapolation of the entire 3-D field distribution to the phantom surface over the distance from sensor to surface
- (f) Calculation of the averaged SAR within masses of 1g and 10g

3.4.5 SAR Averaged Methods

In DASY, the interpolation and extrapolation are both based on the modified Quadratic Shepard's method. The interpolation scheme combines a least-square fitted function method and a weighted average method which are the two basic types of computational interpolation and approximation.

Extrapolation routines are used to obtain SAR values between the lowest measurement points and the inner phantom surface. The extrapolation distance is determined by the surface detection distance and the probe sensor offset. The uncertainty increases with the extrapolation distance. To keep the uncertainty within 1% for the 1 g and 10 g cubes, the extrapolation distance should not be larger than 5 mm.

4. SAR Measurement Evaluation

4.1 EUT Configuration and Setting

<Considerations Related to Proximity Sensor>

The device supports WWAN, WLAN, and Bluetooth capabilities. It is designed with a proximity sensor which can trigger/not trigger power reduction for GSM, WCDMA and LTE on Rear Face and Bottom Side of EUT for SAR compliance. Others RF capability (WLAN and Bluetooth) have no power reduction. The power levels for all wireless technologies and the power reduction please refer to section 4.6 of this report.

Proximity Sensor Triggering Distances (KDB 616217 D04 §6.2)

The proximity sensor triggering distance was determined per KDB 616217 for rear face and applicable edge. Summary for power verification per distance was tabulated in the below table.

Output Power Verification in dBm for EUT Rear Face											
Distance (mm)	13	14	15	16	17	18	19	20	21	22	23
GSM1900	27.50	27.50	27.50	27.50	27.50	27.50	30.50	30.50	30.50	30.50	30.50
WCDMA II	20.50	20.50	20.50	20.50	20.50	20.50	24.00	24.00	24.00	24.00	24.00
WCDMA IV	21.00	21.00	21.00	21.00	21.00	21.00	24.00	24.00	24.00	24.00	24.00
LTE 2	20.50	20.50	20.50	20.50	20.50	20.50	24.00	24.00	24.00	24.00	24.00
LTE 4	20.50	20.50	20.50	20.50	20.50	20.50	24.00	24.00	24.00	24.00	24.00
LTE 7	20.00	20.00	20.00	20.00	20.00	20.00	24.00	24.00	24.00	24.00	24.00
LTE 38	22.00	22.00	22.00	22.00	22.00	22.00	24.00	24.00	24.00	24.00	24.00
LTE 41	22.00	22.00	22.00	22.00	22.00	22.00	24.00	24.00	24.00	24.00	24.00

Output Power Verification in dBm for EUT Bottom Edge											
Distance (mm)	18	19	20	21	22	23	24	25	26	27	28
GSM1900	27.50	27.50	27.50	27.50	27.50	27.50	30.50	30.50	30.50	30.50	30.50
WCDMA II	20.50	20.50	20.50	20.50	20.50	20.50	24.00	24.00	24.00	24.00	24.00
WCDMA IV	21.00	21.00	21.00	21.00	21.00	21.00	24.00	24.00	24.00	24.00	24.00
LTE 2	20.50	20.50	20.50	20.50	20.50	20.50	24.00	24.00	24.00	24.00	24.00
LTE 4	20.50	20.50	20.50	20.50	20.50	20.50	24.00	24.00	24.00	24.00	24.00
LTE 7	20.00	20.00	20.00	20.00	20.00	20.00	24.00	24.00	24.00	24.00	24.00
LTE 38	22.00	22.00	22.00	22.00	22.00	22.00	24.00	24.00	24.00	24.00	24.00
LTE 41	22.00	22.00	22.00	22.00	22.00	22.00	24.00	24.00	24.00	24.00	24.00

Proximity Sensor Coverage (KDB 616217 D04 §6.3)

Since the proximity sensor is collocated with antenna in one component, the procedure for proximity sensor coverage is not required.

Proximity Sensor Tilt Angle Influences(KDB 616217 D04 §6.4)

The proximity sensor tilt angle influence was determined per KDB 616217 for applicable edge. Summary for proximity sensor tilt angle influence is shown in below.

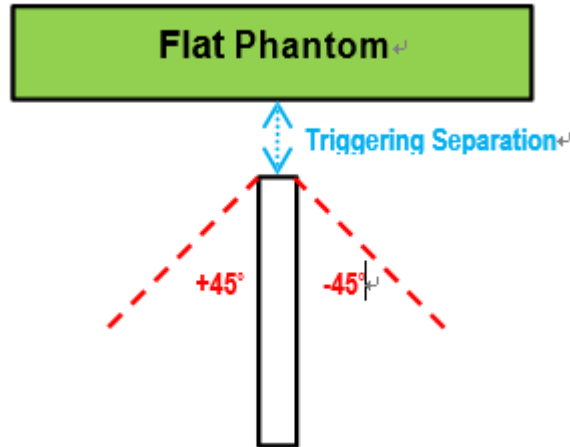

Orientation	Separation Distance (mm)	Tilt Angle										
		-45°	-40°	-30°	-20°	-10°	0°	10°	20°	30°	40°	45°
Bottom Edge	23	On	On	On	On	On	On	On	On	On	On	On

Summary for Proximity Sensor Triggering Test

According to the procedures noticed in KDB 616217 D04, the proximity sensor triggering distance is 18 mm for EUT Rear Face, and 23 mm for Bottom Side. The separation distance of 18 mm determined by the smallest triggering distance on Bottom Side is used to access the tilt angle influence and the sensor does not release during ± 45degree. Therefore, the smallest separation distance for tilt angle influence is 24 mm for the Bottom Side. The conservation triggering distances based on the separation distance for the sensor trigger / not triggered as EUT with power reduction at 0 mm.

The power reduction is depends on the proximity sensor input. For a steady SAR test, the power reduction was enabled or disabled manually by engineering software during SAR testing.

<Connections between EUT and System Simulator>

For WWAN SAR testing, the EUT was linked and controlled by base station emulator. Communication between the EUT and the emulator was established by air link. The distance between the EUT and the communicating antenna of the emulator is larger than 50 cm and the output power radiated from the emulator antenna is at least 30 dB smaller than the output power of EUT. The EUT was set from the emulator to radiate maximum output power during SAR testing.

<Considerations Related to GSM / GPRS / EDGE for Setup and Testing>

The maximum multi-slot capability supported by this device is as below.

1. This EUT is class B device
2. This EUT supports GPRS multi-slot class 33 (max. uplink: 4, max. downlink: 5, total timeslots: 6)
3. This EUT supports EDGE multi-slot class 33 (max. uplink: 4, max. downlink: 5, total timeslots: 6)

For GSM850 frequency band, the power control level is set to 5 for GSM mode and GPRS (GMSK: CS1), and set to 8 for EDGE (GMSK: MCS1, 8PSK: MCS9). For GSM1900 frequency band, the power control level is set to 0 for GSM mode and GPRS (GMSK: CS1), and set to 2 for EDGE (GMSK: MCS1, 8PSK: MCS9).

SAR test reduction for GPRS and EDGE modes is determined by the source-based time-averaged output power specified for production units, including tune-up tolerance. The data mode with highest specified time-averaged output power should be tested for SAR compliance in the applicable exposure conditions. For modes with the same specified maximum output power and tolerance, the higher number time-slot configuration should be tested.

<Considerations Related to WCDMA for Setup and Testing>

WCDMA Handsets Head SAR

SAR for next to the ear head exposure is measured using a 12.2 kbps RMC with TPC bits configured to all "1's". The 3G SAR test reduction procedure is applied to AMR configurations with 12.2 kbps RMC as the primary mode.

WCDMA Handsets Body-worn SAR

SAR for body-worn configurations is measured using a 12.2 kbps RMC with TPC bits configured to all "1's". The 3G SAR test reduction procedure is applied to other spreading codes and multiple DPDCH_n configurations supported by the handset with 12.2 kbps RMC as the primary mode.

Handsets with Release 5 HSDPA

The 3G SAR test reduction procedure is applied to HSDPA body-worn configurations with 12.2 kbps RMC as the primary mode. Otherwise, SAR is measured for HSDPA using the HSDPA body SAR procedures in the "Release 5 HSDPA Data Devices", for the highest reported SAR body-worn exposure configuration in 12.2 kbps RMC. Handsets with both HSDPA and HSUPA are tested according to Release 6 HSPA test procedures.

Handsets with Release 6 HSUPA

The 3G SAR test reduction procedure is applied to HSPA (HSUPA/HSDPA with RMC) body-worn configurations with 12.2 kbps RMC as the primary mode. Otherwise, SAR is measured for HSPA using the HSPA body SAR procedures in the “Release 6 HSPA Data Devices”, for the highest reported body-worn exposure SAR configuration in 12.2 kbps RMC. When VOIP is applicable for next to the ear head exposure in HSPA, the 3G SAR test reduction procedure is applied to HSPA with 12.2 kbps RMC as the primary mode; otherwise, the same HSPA configuration used for body-worn measurements is tested for next to the ear head exposure.

Release 5 HSDPA Data Devices

The 3G SAR test reduction procedure is applied to body SAR with 12.2 kbps RMC as the primary mode. Otherwise, body SAR for HSDPA is measured using an FRC with H-Set 1 in Sub-test 1 and a 12.2 kbps RMC configured in Test Loop Mode 1, for the highest reported SAR configuration in 12.2 kbps RMC without HSDPA. HSDPA is configured according to the applicable UE category of a test device. The number of HS-DSCH / HS-PDSCHs, HARQ processes, minimum inter-TTI interval, transport block sizes and RV coding sequence are defined by the H-set. To maintain a consistent test configuration and stable transmission conditions, QPSK is used in the H-set for SAR testing. HS-DPCCH should be configured with a CQI feedback cycle of 4 ms and a CQI repetition factor of 2 to maintain a constant rate of active CQI slots. DPCCH and DPDCH gain factors (β_c , β_d), and HS-DPCCH power offset parameters (Δ_{ACK} , Δ_{NACK} , Δ_{CQI}) are set according to values indicated in below. The CQI value is determined by the UE category, transport block size, number of HS-PDSCHs and modulation used in the H-set.

Sub-test	β_c	β_d	β_d (SF)	β_c / β_d	$\beta_{hs}^{(1)}$	CM (dB) ⁽²⁾	MPR
1	2 / 15	15 / 15	64	2 / 15	4 / 15	0.0	0
2	12 / 15 ⁽³⁾	15 / 15 ⁽³⁾	64	12 / 15 ⁽³⁾	24 / 15	1.0	0
3	15 / 15	8 / 15	64	15 / 8	30 / 15	1.5	0.5
4	15 / 15	4 / 15	64	15 / 4	30 / 15	1.5	0.5

Note 1: Δ_{ACK} , Δ_{NACK} and $\Delta_{CQI} = 8 \Leftrightarrow A_{hs} = \beta_{hs} / \beta_c = 30 / 15 \Leftrightarrow \beta_{hs} = 30 / 15 * \beta_c$.
 Note 2: CM = 1 for $\beta_c / \beta_d = 12 / 15$, $\beta_{hs} / \beta_c = 24 / 15$.
 Note 3: For subtest 2 the β_c / β_d ratio of 12 / 15 for the TFC during the measurement period (TF1, TF0) is achieved by setting the signaled gain factors for the reference TFC (TF1, TF1) to $\beta_c = 11 / 15$ and $\beta_d = 15 / 15$.

Release 6 HSUPA Data Devices

The 3G SAR test reduction procedure is applied to body SAR with 12.2 kbps RMC as the primary mode. Otherwise, body SAR for HSPA is measured with E-DCH Sub-test 5, using H-Set 1 and QPSK for FRC and a 12.2 kbps RMC configured in Test Loop Mode 1 and power control algorithm 2, according to the highest reported body SAR configuration in 12.2 kbps RMC without HSPA. When VOIP applies to head exposure, the 3G SAR test reduction procedure is applied with 12.2 kbps RMC as the primary mode. Otherwise, the same HSPA configuration used for body SAR measurements are applied to head exposure testing. Due to inner loop power control requirements in HSPA, a communication test set is required for output power and SAR tests. The 12.2 kbps RMC, FRC H-set 1 and E-DCH configurations for HSPA are configured according to the β values indicated in below.

FCC SAR Test Report

Sub-test	β_c	β_d	β_d (SF)	β_c / β_d	$\beta_{HS}^{(1)}$	β_{ac}	β_{ed}	β_{ed} (SF)	β_{ed} (codes)	CM ⁽²⁾ (dB)	MPR (dB)	AG ⁽⁴⁾ Index	E-TFCI
1	11 / 15 ⁽³⁾	15 / 15 ⁽³⁾	64	11 / 15 ⁽³⁾	22 / 15	209 / 225	1039 / 225	4	1	1.0	0.0	20	75
2	6 / 15	15 / 15	64	6 / 15	12 / 15	12 / 15	94 / 75	4	1	3.0	2.0	12	67
3	15 / 15	9 / 15	64	15 / 9	30 / 15	30 / 15	$\beta_{ed1}: 47/15$ $\beta_{ed2}: 47/15$	4	2	2.0	1.0	15	92
4	2 / 15	15 / 15	64	2 / 15	4 / 15	2 / 15	56 / 75	4	1	3.0	2.0	17	71
5	15 / 15 ⁽⁴⁾	15 / 15 ⁽⁴⁾	64	15 / 15 ⁽⁴⁾	30 / 15	24 / 15	134 / 15	4	1	1.0	0.0	21	81

Note 1: $\Delta_{ACK}, \Delta_{NACK}$ and $\Delta_{COI} = 8 \Leftrightarrow A_{HS} = \beta_{HS} / \beta_c = 30 / 15 \Leftrightarrow \beta_{HS} = 30 / 15 * \beta_c$
 Note 2: CM = 1 for $\beta_c / \beta_d = 12 / 15, \beta_{HS} / \beta_c = 24 / 15$. For all other combinations of DPDCH, DPCCH, HS-DPCCH, E-DPDCH and E-DPCCH the MPR is based on the relative CM difference.
 Note 3: For subtest 1 the β_c / β_d ratio of 11 / 15 for the TFC during the measurement period (TF1, TF0) is achieved by setting the signaled gain factors for the reference TFC (TF1, TF1) to $\beta_c = 10 / 15$ and $\beta_d = 15 / 15$.
 Note 4: For subtest 5 the β_c / β_d ratio of 15 / 15 for the TFC during the measurement period (TF1, TF0) is achieved by setting the signaled gain factors for the reference TFC (TF1, TF1) to $\beta_c = 14 / 15$ and $\beta_d = 15 / 15$.
 Note 5: Testing UE using E-DPDCH Physical Layer category 1 Sub-test 3 is not required according to TS 25.306 Table 5.1g.
 Note 6: β_{ed} cannot be set directly: it is set by Absolute Grant Value.

DC-HSDPA SAR Guidance

The 3G SAR test reduction procedure is applied to DC-HSDPA with 12.2 kbps RMC as the primary mode. Otherwise, when SAR is required for Rel. 5 HSDPA, SAR is required for Rel. 8 DC-HSDPA. Power is measured for DC-HSDPA according to the H-Set 12, FRC configuration in Table C.8.1.12 of 3GPP TS 34.121-1 to determine SAR test reduction. A primary and a secondary serving HS-DSCH Cell are required to perform the power measurement and for the results to be acceptable.

<Considerations Related to LTE for Setup and Testing>

This device contains LTE transmitter which follows 3GPP standards, is category 3, supports both QPSK and 16QAM modulations, and supported LTE band and channel bandwidth is listed in below. The output power was tested per 3GPP TS 36.521-1 maximum transmit procedures for both QPSK and 16QAM modulation. The results please refer to section 4.6 of this report.

EUT Supported LTE Band and Channel Bandwidth						
LTE Band	BW 1.4 MHz	BW 3 MHz	BW 5 MHz	BW 10 MHz	BW 15 MHz	BW 20 MHz
2	V	V	V	V	V	V
4	V	V	V	V	V	V
5	V	V	V	V		
7			V	V	V	V
38			V	V	V	V
41			V	V	V	V

The LTE maximum power reduction (MPR) in accordance with 3GPP TS 36.101 is active all times during LTE operation. The allowed MPR for the maximum output power is specified in below.

Modulation	Channel Bandwidth / RB Configurations						LTE MPR Setting (dB)
	BW 1.4 MHz	BW 3 MHz	BW 5 MHz	BW 10 MHz	BW 15 MHz	BW 20 MHz	
QPSK	> 5	> 4	> 8	> 12	> 16	> 18	1
16QAM	<= 5	<= 4	<= 8	<= 12	<= 16	<= 18	1
16QAM	> 5	> 4	> 8	> 12	> 16	> 18	2
64QAM	<= 5	<= 4	<= 8	<= 12	<= 16	<= 18	2
64QAM	> 5	> 4	> 8	> 12	> 16	> 18	3

Note: MPR is according to the standard and implemented in the circuit (mandatory).

FCC SAR Test Report

In addition, the device is compliant with additional maximum power reduction (A-MPR) requirements defined in 3GPP TS 36.101 section 6.2.4 that was disabled for all FCC compliance testing.

During LTE SAR testing, the related parameters of operating band, channel bandwidth, uplink channel number, modulation type, and RB was set in base station simulator. When the EUT has registered and communicated to base station simulator, the simulator set to make EUT transmitting the maximum radiated power.

TDD-LTE Setup Configurations

According to KDB 941225 D05, SAR testing for TDD-LTE device must be tested using a fixed periodic duty factor according to the highest transmission duty factor implemented for the device and supported by the defined 3GPP TDD-LTE configurations. The TDD-LTE of this device supports frame structure type 2 defined in 3GPP TS 36.211 section 4.2, and the frame structure configuration can be referred to below.

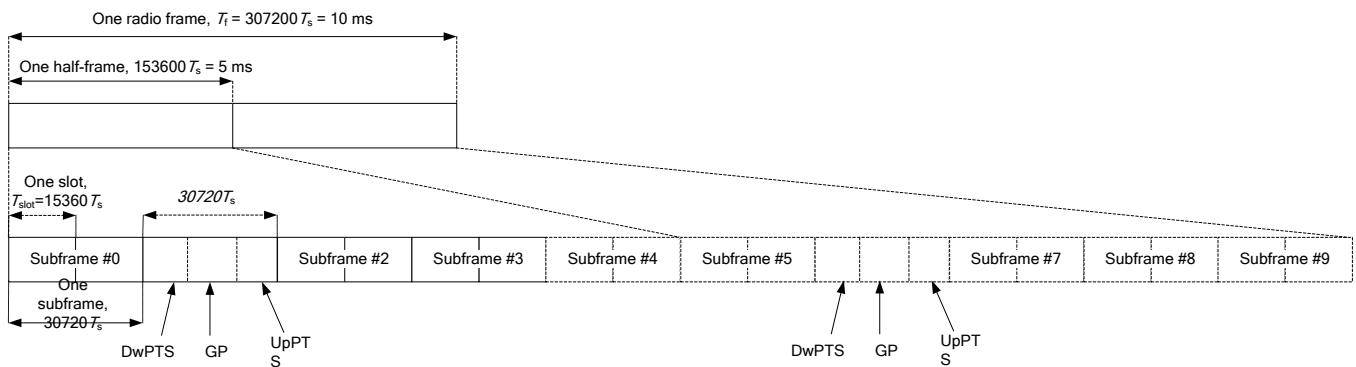

3GPP TS 36.211 Figure 4.2-1: Frame Structure Type 2

Special Subframe Configuration	Normal Cyclic Prefix in Downlink			Extended Cyclic Prefix in Downlink		
	DwPTS	UpPTS		DwPTS	UpPTS	
		Normal Cyclic Prefix in Uplink	Extended Cyclic Prefix in Uplink		Normal Cyclic Prefix in Uplink	Extended Cyclic Prefix in Uplink
0	6592·Ts	2192·Ts	2560·Ts	7680·Ts	2192·Ts	2560·Ts
1	19760·Ts			20480·Ts		
2	21952·Ts			23040·Ts		
3	24144·Ts			25600·Ts		
4	26336·Ts			7680·Ts		
5	6592·Ts	4384·Ts	5120·Ts	20480·Ts	4384·Ts	5120·Ts
6	19760·Ts			23040·Ts		
7	21952·Ts			12800·Ts		
8	24144·Ts			-		
9	13168·Ts	-	-	-	-	-

3GPP TS 36.211 Table 4.2-1: Configuration of Special Subframe

FCC SAR Test Report

Uplink-Downlink Configuration	Downlink-to-Uplink Switch-Point Periodicity	Subframe Number									
		0	1	2	3	4	5	6	7	8	9
0	5 ms	D	S	U	U	U	D	S	U	U	U
1	5 ms	D	S	U	U	D	D	S	U	U	D
2	5 ms	D	S	U	D	D	D	S	U	D	D
3	10 ms	D	S	U	U	U	D	D	D	D	D
4	10 ms	D	S	U	U	D	D	D	D	D	D
5	10 ms	D	S	U	D	D	D	D	D	D	D
6	5 ms	D	S	U	U	U	D	S	U	U	D

3GPP TS 36.211 Table 4.2-2: Uplink-Downlink Configurations

The variety of different TD-LTE uplink-downlink configurations allows a network operator to allocate the network's capacity between uplink and downlink traffic to meet the needs of the network. The uplink duty cycle of these seven configurations can readily be computed and shown in below.

UL-DL Configuration	0	1	2	3	4	5	6
Highest Duty-Cycle	63.33%	43.33%	23.33%	31.67%	21.67%	11.67%	53.33%

Considering the highest transmission duty cycle, TDD-LTE was tested using Uplink-Downlink Configuration 0 with 6 uplink subframe and 2 special subframe. The special subframe was set to special subframe configuration 7 using extended cyclic prefix uplink. Therefore, SAR testing for TDD-LTE was performed at the maximum output power with highest transmission duty cycle of 63.33%.

LTE Downlink Carrier Aggregation (CA) Setup Configurations

LTE Carrier Aggregation (CA) was defined in 3GPP release 10 and higher. The LTE device in CA mode has one Primary Component Carrier (PCC) and one or more Secondary Component Carriers (SCC). PCC acts as the anchor carrier and can optionally cross-schedule data transmission on SCC. The RRC connection is only handled by one cell, the PCC for downlink and uplink communications. After making a data connection to the PCC, the LTE device adds the SCC on the downlink only. All uplink communications and acknowledgements remain identical to release 8 specifications on the PCC. The combinations of downlink carrier aggregation supported by this device are listed in below.

LTE CA Configurations and Bandwidth Combination Sets defined for Intra-Band Contiguous CA

Downlink CA Configuration	Component carriers in order of increasing carrier frequency			Maximum Aggregated Bandwidth (MHz)	Bandwidth Combination Set
	Channel bandwidths for carrier-1 (MHz)	Channel bandwidths for carrier-2 (MHz)	Channel bandwidths for carrier-3 (MHz)		
CA_7C	15	15		40	0
	20	20			
	10	20		40	1
	15	15, 20			
	20	10, 15, 20		40	2
	15	10, 15			
CA_38C	20	15, 20		40	2
	15	15			
CA_38C	20	20		40	0
	15	15			

FCC SAR Test Report

LTE Uplink Carrier Aggregation (CA) Setup Configurations

This device supports LTE uplink CA for band 7C/38C only with a maximum of two 20 MHz carrier components in the uplink. The maximum output power for uplink intra-band contiguous CA specified in Table 6.2.2A-1 of 3GPP TS 36.101 is the same as single carrier specified in Table 6.2.2-1 of 3GPP TS 36.101. In Table 6.2.3A-1 of 3GPP TS 36.101, the MPR (maximum power reduction) for several dB is allowed due to modulation and contiguously aggregated transmit bandwidth configuration. All the RF parameters in this device have followed above 3GPP criteria.

Uplink CA Configuration	Component carriers in order of increasing carrier frequency			Maximum Aggregated Bandwidth (MHz)	Bandwidth Combination Set
	Channel bandwidths for carrier-1 (MHz)	Channel bandwidths for carrier-2 (MHz)	Channel bandwidths for carrier-3 (MHz)		
CA_7C	15	15		40	0
	20	20			
	10	20		40	1
	15	15, 20			
	20	10, 15, 20			
	15	10, 15		40	2
20	15, 20				
CA_38C	15	15		40	0
	20	20			

<Considerations Related to WLAN for Setup and Testing>

In general, various vendor specific external test software and chipset based internal test modes are typically used for SAR measurement. These chipset based test mode utilities are generally hardware and manufacturer dependent, and often include substantial flexibility to reconfigure or reprogram a device. A Wi-Fi device must be configured to transmit continuously at the required data rate, channel bandwidth and signal modulation, using the highest transmission duty factor supported by the test mode tools for SAR measurement. The test frequencies established using test mode must correspond to the actual channel frequencies. When 802.11 frame gaps are accounted for in the transmission, a maximum transmission duty factor of 92 - 96% is typically achievable in most test mode configurations. A minimum transmission duty factor of 85% is required to avoid certain hardware and device implementation issues related to wide range SAR scaling. In addition, a periodic transmission duty factor is required for current generation SAR systems to measure SAR correctly. The reported SAR must be scaled to 100% transmission duty factor to determine compliance at the maximum tune-up tolerance limit.

According to KDB 248227 D01, this device has installed WLAN engineering testing software which can provide continuous transmitting RF signal. During WLAN SAR testing, this device was operated to transmit continuously at the maximum transmission duty with specified transmission mode, operating frequency, lowest data rate, and maximum output power.

Initial Test Configuration

An initial test configuration is determined for OFDM transmission modes in 2.4 GHz and 5 GHz bands according to the channel bandwidth, modulation and data rate combination(s) with the highest maximum output power specified for production units in each standalone and aggregated frequency band. When the same maximum power is specified for multiple transmission modes in a frequency band, the largest channel bandwidth, lowest order modulation, lowest data rate and lowest order 802.11a/g/n/ac mode is used for SAR measurement, on the highest measured output power channel in the initial test configuration, for each frequency band.

Subsequent Test Configuration

SAR measurement requirements for the remaining 802.11 transmission mode configurations that have not been tested in the initial test configuration are determined separately for each standalone and aggregated frequency band, in each exposure condition, according to the maximum output power specified for production units. Additional power measurements may be required to determine if SAR measurements are required for subsequent highest output power channels in a subsequent test configuration. When the highest reported SAR for the initial test configuration according to the initial test position or fixed exposure position requirements, is adjusted by the ratio of the subsequent test configuration to initial test configuration specified maximum output power and the adjusted SAR is ≤ 1.2 W/kg, SAR is not required for that subsequent test configuration.

SAR Test Configuration and Channel Selection

When multiple channel bandwidth configurations in a frequency band have the same specified maximum output power, the initial test configuration is using largest channel bandwidth, lowest order modulation, lowest data rate, and lowest order 802.11 mode (i.e., 802.11a is chosen over 802.11n then 802.11ac or 802.11g is chosen over 802.11n). After an initial test configuration is determined, if multiple test channels have the same measured maximum output power, the channel chosen for SAR measurement is determined according to the following.

- 1) The channel closest to mid-band frequency is selected for SAR measurement.
- 2) For channels with equal separation from mid-band frequency; for example, high and low channels or two mid-band channels, the higher frequency (number) channel is selected for SAR measurement.

Test Reduction for U-NII-1 (5.2 GHz) and U-NII-2A (5.3 GHz) Bands

For devices that operate in both U-NII bands using the same transmitter and antenna(s), SAR test reduction is determined according to the following.

- 1) When the same maximum output power is specified for both bands, begin SAR measurement in U-NII-2A band by applying the OFDM SAR requirements. If the highest reported SAR for a test configuration is ≤ 1.2 W/kg, SAR is not required for U-NII-1 band for that configuration (802.11 mode and exposure condition).
- 2) When different maximum output power is specified for the bands, begin SAR measurement in the band with higher specified maximum output power. The highest reported SAR for the tested configuration is adjusted by the ratio of lower to higher specified maximum output power for the two bands. When the adjusted SAR is ≤ 1.2 W/kg, SAR is not required for the band with lower maximum output power in that test configuration.

<Considerations Related to Bluetooth for Setup and Testing>

This device has installed Bluetooth engineering testing software which can provide continuous transmitting RF signal. During Bluetooth SAR testing, this device was operated to transmit continuously at the maximum transmission duty with specified transmission mode, operating frequency, lowest data rate, and maximum output power.

4.2 EUT Testing Position

4.2.1 Head Exposure Conditions

Head exposure is limited to next to the ear voice mode operations. Head SAR compliance is tested according to the test positions defined in IEEE Std 1528-2003 using the SAM phantom illustrated as below.

1. Define two imaginary lines on the handset
 - (a) The vertical centerline passes through two points on the front side of the handset - the midpoint of the width w_t of the handset at the level of the acoustic output, and the midpoint of the width w_b of the bottom of the handset.
 - (b) The horizontal line is perpendicular to the vertical centerline and passes through the center of the acoustic output. The horizontal line is also tangential to the face of the handset at point A.
 - (c) The two lines intersect at point A. Note that for many handsets, point A coincides with the center of the acoustic output; however, the acoustic output may be located elsewhere on the horizontal line. Also note that the vertical centerline is not necessarily parallel to the front face of the handset, especially for clamshell handsets, handsets with flip covers, and other irregularly shaped handsets.

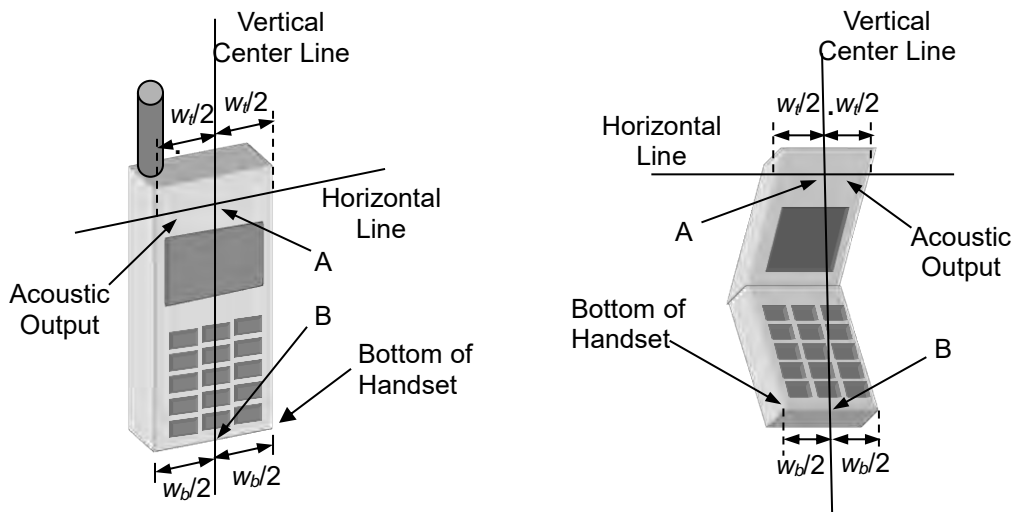

Fig-4.1 Illustration for Handset Vertical and Horizontal Reference Lines

2. Cheek Position

- (a) To position the device with the vertical center line of the body of the device and the horizontal line crossing the center piece in a plane parallel to the sagittal plane of the phantom. While maintaining the device in this plane, align the vertical center line with the reference plane containing the three ear and mouth reference point (M: Mouth, RE: Right Ear, and LE: Left Ear) and align the center of the ear piece with the line RE-LE.
- (b) To move the device towards the phantom with the ear piece aligned with the line LE-RE until the phone touched the ear. While maintaining the device in the reference plane and maintaining the phone contact with the ear, move the bottom of the phone until any point on the front side is in contact with the cheek of the phantom or until contact with the ear is lost (see Fig-4.2).

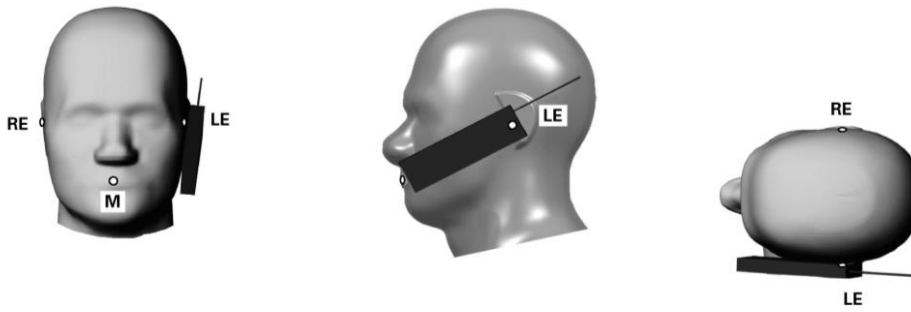

Fig-4.2 Illustration for Cheek Position

3. Tilted Position

(a) To position the device in the “cheek” position described above.

(b) While maintaining the device the reference plane described above and pivoting against the ear, moves it outward away from the mouth by an angle of 15 degrees or until contact with the ear is lost (see Fig-4.3).

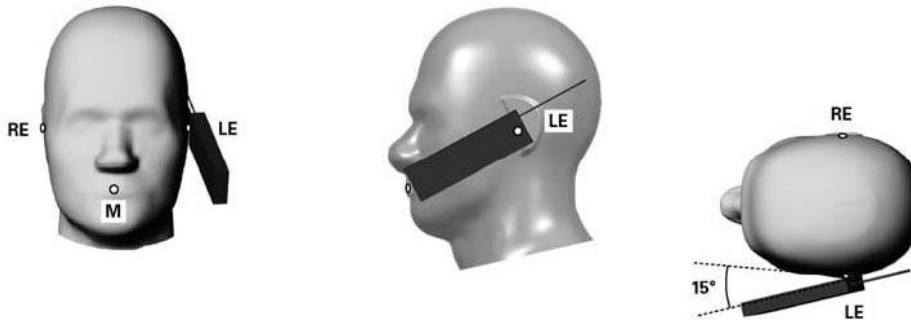

Fig-4.3 Illustration for Tilted Position

4.2.2 Body-worn Accessory Exposure Conditions

Body-worn accessory exposure is typically related to voice mode operations when handsets are carried in body-worn accessories. The body-worn accessory procedures in KDB 447498 D01 are used to test for body-worn accessory SAR compliance, without a headset connected to it. This enables the test results for such configuration to be compatible with that required for hotspot mode when the body-worn accessory test separation distance is greater than or equal to that required for hotspot mode. When the reported SAR for a body-worn accessory, measured without a headset connected to the handset, is $> 1.2 \text{ W/kg}$, the highest reported SAR configuration for that wireless mode and frequency band should be repeated for that body-worn accessory with a headset attached to the handset.

Body-worn accessories that do not contain metallic or conductive components may be tested according to worst-case exposure configurations, typically according to the smallest test separation distance required for the group of body-worn accessories with similar operating and exposure characteristics. All body-worn accessories containing metallic components are tested in conjunction with the host device.

Body-worn accessory SAR compliance is based on a single minimum test separation distance for all wireless and operating modes applicable to each body-worn accessory used by the host, and according to the relevant voice and/or data mode transmissions and operations. If a body-worn accessory supports voice only operations in its normal and expected use conditions, testing of data mode for body-worn compliance is not required.

A conservative minimum test separation distance for supporting off-the-shelf body-worn accessories that may be acquired by users of consumer handsets is used to test for body-worn accessory SAR compliance. This distance is determined by the handset manufacturer, according to the requirements of Supplement C 01-01. Devices that are designed to operate on the body of users using lanyards and straps, or without requiring additional body-worn accessories, will be tested using a conservative minimum test separation distance $\leq 5 \text{ mm}$ to support compliance.

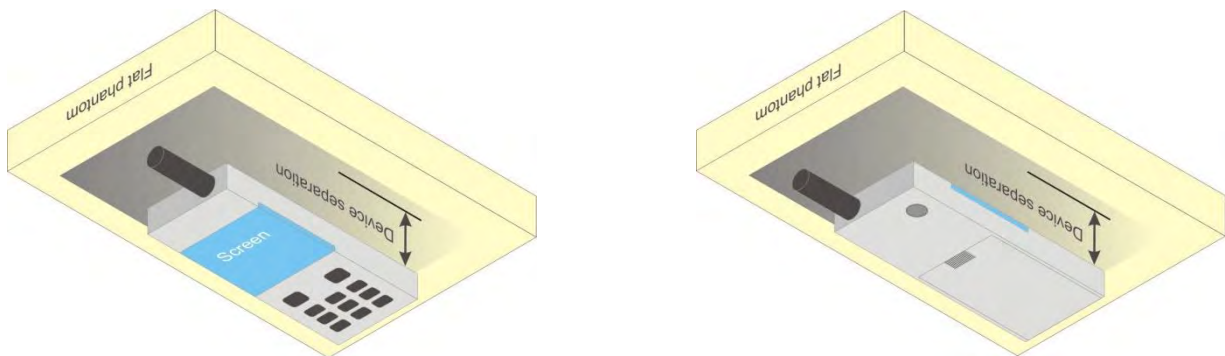
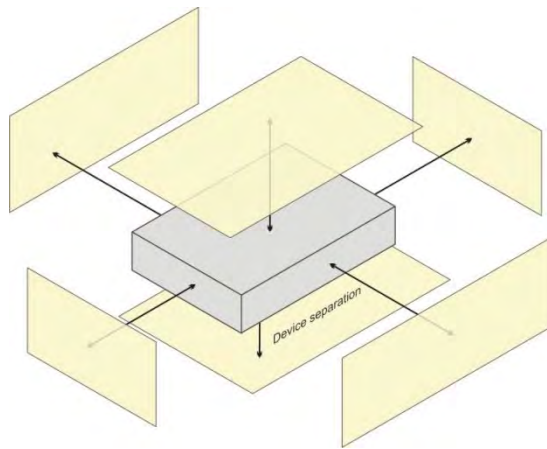

Fig-4.4 Illustration for Body Worn Position

4.2.3 Hotspot Mode Exposure Conditions

For handsets that support hotspot mode operations, with wireless router capabilities and various web browsing functions, the relevant hand and body exposure conditions are tested according to the hotspot SAR procedures in KDB 941225 D06. A test separation distance of 10 mm is required between the phantom and all surfaces and edges with a transmitting antenna located within 25 mm from that surface or edge. When the form factor of a handset is smaller than 9 cm x 5 cm, a test separation distance of 5 mm (instead of 10 mm) is required for testing hotspot mode. When the separation distance required for body-worn accessory testing is larger than or equal to that tested for hotspot mode, in the same wireless mode and for the same surface of the phone, the hotspot mode SAR data may be used to support body-worn accessory SAR compliance for that particular configuration (surface).



Based on the antenna location shown on appendix D of this report, the SAR testing required for hotspot mode is listed as below.

Antenna	Front Face	Rear Face	Left Side	Right Side	Top Side	Bottom Side
WWAN Ant-0	✓	✓	✓	✓		✓
WWAN Ant-1(1)	✓	✓	✓		✓	
WLAN Ant-0(2)	✓	✓		✓	✓	
Wi-Fi 2.4G Ant-1	✓	✓	✓		✓	
Wi-Fi 5G Ant-1	✓	✓		✓	✓	

Note:

1. WWAN Ant-1 only support GSM850 / WCDMA V / LTE B5;
2. WLAN Ant-0 support Wi-Fi 2.4G/ Wi-Fi 5G / BT;

FCC SAR Test Report

4.2.4 Extremity Exposure Conditions

For smart phones with a display diagonal dimension > 15 cm or an overall diagonal dimension > 16 cm that provide similar mobile web access and multimedia support found in mini-tablets or UMPC mini-tablets that support voice calls next to the ear, the following phablet procedures should be applied to evaluate SAR compliance for each applicable wireless modes and frequency band. Devices marketed as phablets, regardless of form factors and operating characteristics must be tested as a phablet to determine SAR compliance.

1. The normally required head and body-worn accessory SAR test procedures for handsets, including hotspot mode, must be applied.
2. The UMPC mini-tablet procedures must also be applied to test the SAR of all surfaces and edges with an antenna located at <= 25 mm from that surface or edge, in direct contact with a flat phantom, for 10-g extremity SAR according to the body-equivalent tissue dielectric parameters in KDB 865664 to address interactive hand use exposure conditions. The UMPC mini-tablet 1-g SAR at 5 mm is not required. When hotspot mode applies, 10-g extremity SAR is required only for the surfaces and edges with hotspot mode 1-g SAR > 1.2 W/kg. The normal tablet procedures in KDB 616217 are required when the over diagonal dimension of the device is > 20 cm. Hotspot mode SAR is not required when normal tablet procedures are applied. Extremity 10-g SAR is also not required for the front (top) surface of large form factor full size tablets. The more conservative tablet SAR results can be used to support the 10-g extremity SAR for phablet mode.
3. The simultaneous transmission operating configurations applicable to voice and data transmissions for both phone and mini-tablet modes must be taken into consideration separately for 1-g and 10-g SAR to determine the simultaneous transmission SAR test exclusion and measurement requirements for the relevant wireless modes and exposure conditions.

4.2.5 SAR Test Exclusion Evaluations

According to KDB 447498 D01, the SAR test exclusion condition is based on source-based time-averaged maximum conducted output power, adjusted for tune-up tolerance, and the minimum test separation distance required for the exposure conditions. The SAR exclusion threshold is determined by the following formula.

$$\frac{\text{Max. Tune up Power}_{(mW)}}{\text{Min. Test Separation Distance}_{(mm)}} \times \sqrt{f_{(GHz)}} \leq 3.0 \text{ for SAR-1g, } \leq 7.5 \text{ for SAR-10g}$$

When the minimum test separation distance is < 5 mm, a distance of 5 mm is applied to determine SAR test exclusion.

Mode	Max. Tune-up Power (dBm)	Max. Tune-up Power (mW)	Head			Hotspot		
			Ant. to Surface (mm)	Calculated Result	Require SAR Testing?	Ant. to Surface (mm)	Calculated Result	Require SAR Testing?
BT	10	10	5	3.1	Yes	10	1.6	No

Mode	Max. Tune-up Power (dBm)	Max. Tune-up Power (mW)	Body-Worn			Extremity		
			Ant. to Surface (mm)	Calculated Result	Require SAR Testing?	Ant. to Surface (mm)	Calculated Result	Require SAR Testing?
BT	10	10	15	1.0	No	0	3.1	No

Note:

1. When separation distance <= 50 mm and the calculated result shown in above table is <= 3.0 for SAR-1g exposure condition, or <= 7.5 for SAR-10g exposure condition, the SAR testing exclusion is applied.

FCC SAR Test Report

4.3 Tissue Verification

The measuring results for tissue simulating liquid are shown as below.

Test Date	Tissue Type	Frequency (MHz)	Liquid Temp. (°C)	Measured Conductivity (σ)	Measured Permittivity (ϵ_r)	Target Conductivity (σ)	Target Permittivity (ϵ_r)	Conductivity Deviation (%)	Permittivity Deviation (%)
Mar. 17, 2020	H835	835	22.3	0.900	40.574	0.90	41.50	0.00	-2.23
Mar. 19, 2020	H1750	1750	22.1	1.384	38.512	1.37	40.10	1.02	-3.96
Mar. 21, 2020	H1900	1900	22.2	1.443	40.230	1.40	40.00	3.07	0.57
Mar. 17, 2020	H2450	2450	22.5	1.845	39.406	1.80	39.20	2.50	0.53
Mar. 23, 2020	H2600	2600	22.5	2.039	38.932	1.96	39.00	4.03	-0.17
Mar. 21, 2020	H5G	5250	22.2	4.725	37.313	4.71	35.90	0.32	3.94
Mar. 26, 2020	H5G	5600	22.6	5.066	36.835	5.07	35.50	-0.08	3.76
Mar. 28, 2020	H5G	5800	22.3	5.270	36.569	5.27	35.30	0.00	3.59

Note:

The dielectric properties of the tissue simulating liquid must be measured within 24 hours before the SAR testing and within $\pm 5\%$ of the target values. Liquid temperature during the SAR testing must be within $\pm 2^\circ\text{C}$.

4.4 System Validation

The SAR measurement system was validated according to procedures in KDB 865664 D01. The validation status in tabulated summary is as below.

Test Date	Probe S/N	Calibration Point	Measured Conductivity (σ)	Measured Permittivity (ϵ_r)	Validation for CW			Validation for Modulation		
					Sensitivity Range	Probe Linearity	Probe Isotropy	Modulation Type	Duty Factor	PAR
Mar. 17, 2020	3873	835	0.900	40.574	Pass	Pass	Pass	GMSK	Pass	N/A
Mar. 17, 2020	3873	835	0.900	40.574	Pass	Pass	Pass	QPSK	Pass	N/A
Mar. 19, 2020	3873	1750	1.384	38.512	Pass	Pass	Pass	QPSK	Pass	N/A
Mar. 21, 2020	3873	1900	1.443	40.230	Pass	Pass	Pass	GMSK	Pass	N/A
Mar. 21, 2020	3873	1900	1.443	40.230	Pass	Pass	Pass	QPSK	Pass	N/A
Mar. 17, 2020	7554	2450	1.845	39.406	Pass	Pass	Pass	OFDM	N/A	Pass
Mar. 23, 2020	3873	2600	2.039	38.932	Pass	Pass	Pass	QPSK	Pass	N/A
Mar. 21, 2020	7554	5250	4.725	37.313	Pass	Pass	Pass	OFDM	N/A	Pass
Mar. 26, 2020	7554	5600	5.066	36.835	Pass	Pass	Pass	OFDM	N/A	Pass
Mar. 28, 2020	7554	5800	5.270	36.569	Pass	Pass	Pass	OFDM	N/A	Pass

4.5 System Verification

The measuring result for system verification is tabulated as below.

Test Date	Frequency (MHz)	1W Target SAR-1g (W/kg)	Measured SAR-1g (W/kg)	Normalized to 1W SAR-1g (W/kg)	Deviation (%)	Dipole S/N	Probe S/N	DAE S/N
Mar. 17, 2020	835	9.53	2.46	9.84	3.25	4d139	3873	1341
Mar. 19, 2020	1750	36.40	9.55	38.20	4.95	1071	3873	1341
Mar. 21, 2020	1900	39.00	10.20	40.80	4.62	5d159	3873	1341
Mar. 17, 2020	2450	52.20	13.10	52.40	0.38	893	7554	1589
Mar. 23, 2020	2600	56.30	14.00	56.00	-0.53	1110	3873	1341
Mar. 21, 2020	5250	80.70	8.34	83.40	3.35	1133	7554	1589
Mar. 26, 2020	5600	84.00	9.04	90.40	7.62	1133	7554	1589
Mar. 28, 2020	5800	83.00	7.96	79.60	-4.10	1133	7554	1589

Note:

Comparing to the reference SAR value provided by SPEAG, the validation data should be within its specification of 10 %. The result indicates the system check can meet the variation criterion and the plots can be referred to Appendix A of this report.

FCC SAR Test Report

4.6 Maximum Output Power

4.6.1 Maximum Conducted Power

The maximum conducted average power (Unit: dBm) including tune-up tolerance is shown as below.

Mode	GSM850		GSM1900	
	Full Power	Reduce Power	Full Power	Reduce Power
GSM (GMSK, 1Tx-slot)	33.50	--	30.50	27.50
GPRS (GMSK, 1Tx-slot)	33.50	--	30.50	27.50
GPRS (GMSK, 2Tx-slot)	30.50	--	27.50	25.50
GPRS (GMSK, 3Tx-slot)	28.00	--	25.50	24.00
GPRS (GMSK, 4Tx-slot)	27.00	--	24.50	23.00
EDGE (8PSK, 1Tx-slot)	28.00	--	27.00	25.00
EDGE (8PSK, 2Tx-slot)	25.00	--	23.50	22.00
EDGE (8PSK, 3Tx-slot)	23.00	--	22.00	20.00
EDGE (8PSK, 4Tx-slot)	22.50	--	21.50	19.50

Mode	WCDMA Band II		WCDMA Band IV		WCDMA Band V	
	Full Power	Reduce Power	Full Power	Reduce Power	Full Power	Reduce Power
RMC 12.2K	24.00	20.50	24.00	21.00	24.00	--
HSDPA	23.00	19.50	23.00	20.00	23.00	--
HSUPA	22.50	19.50	23.00	20.00	23.00	--
DC-HSDPA	23.00	19.50	23.00	20.00	23.00	--
HSPA+	21.00	17.00	21.00	17.50	21.00	--

Mode	LTE 2		LTE 4		LTE 5		LTE 7		LTE 38		LTE 41	
	Full Power	Reduce Power	Full Power	Reduce Power	Full Power	Reduce Power	Full Power	Reduce Power	Full Power	Reduce Power	Full Power	Reduce Power
QPSK	24	20.5	24	20.5	24.5	--	24	20	24	22	24	22
16QAM	23	20.5	23	20.5	23.5	--	23	20	23	22	23	22
64QAM	22	20.5	22	20.5	23.0	--	22	20	22	22	22	22

Mode	2.4G WLAN		5.2G WLAN		5.3G WLAN		5.6G WLAN		5.8G WLAN	
	Ant 0&1	MIMO	Ant 0&1	MIMO	Ant 0&1	MIMO	Ant 0&1	MIMO	Ant 0&1	MIMO
802.11b	17	19	N/A	N/A	N/A	N/A	N/A	N/A	N/A	N/A
802.11g	14	16	N/A	N/A	N/A	N/A	N/A	N/A	N/A	N/A
802.11a	N/A	N/A	16	18	16	18	15	18	16	18.5
802.11n HT20	12	14	14	16	14	16	14	16.5	14	16.5
802.11n HT40	12	14.5	14	16.5	14	16.5	14.5	17	14.5	17
802.11ac VHT80	N/A	N/A	12	14	12	14	12	14	12.5	14.5

Mode	2.4G Bluetooth
BR/EDR	10
LE	2

FCC SAR Test Report

4.6.2 Measured Conducted Power Result

The measuring conducted average power (Unit: dBm) is shown as below.

<Full Power>

Band	GSM850			GSM1900		
Channel	128	189	251	512	661	810
Frequency (MHz)	824.2	836.4	848.8	1850.2	1880.0	1909.8
Maximum Burst-Averaged Output Power						
GSM (GMSK, 1Tx-slot)	33.09	33.06	32.99	29.62	29.85	29.53
GPRS (GMSK, 1Tx-slot)	33.08	32.91	32.85	29.74	29.85	29.57
GPRS (GMSK, 2Tx-slot)	29.55	29.54	29.59	26.85	27.06	26.80
GPRS (GMSK, 3Tx-slot)	27.50	27.61	27.66	25.25	24.81	24.55
GPRS (GMSK, 4Tx-slot)	26.25	26.40	26.46	23.85	23.51	24.01
EDGE (8PSK, 1Tx-slot)	27.01	26.65	26.92	25.74	25.58	25.80
EDGE (8PSK, 2Tx-slot)	24.62	24.37	24.63	23.47	23.18	23.42
EDGE (8PSK, 3Tx-slot)	22.97	22.71	22.85	21.62	21.35	21.56
EDGE (8PSK, 4Tx-slot)	22.11	21.98	22.11	20.35	20.15	20.36
Maximum Frame-Averaged Output Power						
GSM (GMSK, 1Tx-slot)	24.09	24.06	23.99	20.62	20.85	20.53
GPRS (GMSK, 1Tx-slot)	24.08	23.91	23.85	20.74	20.85	20.57
GPRS (GMSK, 2Tx-slot)	23.55	23.54	23.59	20.85	21.06	20.80
GPRS (GMSK, 3Tx-slot)	23.24	23.35	23.40	20.99	20.55	20.29
GPRS (GMSK, 4Tx-slot)	23.25	23.40	23.46	20.85	20.51	21.01
EDGE (8PSK, 1Tx-slot)	18.01	17.65	17.92	16.74	16.58	16.80
EDGE (8PSK, 2Tx-slot)	18.62	18.37	18.63	17.47	17.18	17.42
EDGE (8PSK, 3Tx-slot)	18.71	18.45	18.59	17.36	17.09	17.30
EDGE (8PSK, 4Tx-slot)	19.11	18.98	19.11	17.35	17.15	17.36

Note:

- SAR testing was performed on the maximum frame-averaged power mode.
- The frame-averaged power is linearly proportion to the slot number configured and it is linearly scaled the maximum burst-averaged power based on time slots. The calculated method is shown as below:

$$\text{Frame-averaged power} = 10 \times \log (\text{Burst-averaged power mW} \times \text{Slot used} / 8)$$

Band	WCDMA Band II			WCDMA Band IV			WCDMA Band V			3GPP MPR (dB)
Channel	9262	9400	9538	1312	1413	1513	4132	4182	4233	
Frequency (MHz)	1852.4	1880.0	1907.6	1712.4	1732.6	1752.6	826.4	836.4	846.6	
RMC 12.2K	23.45	23.41	23.52	23.62	23.65	23.50	23.79	23.80	23.79	-
HSDPA Subtest-1	22.41	22.37	22.56	22.57	22.61	22.49	22.75	22.74	22.76	0
HSDPA Subtest-2	22.36	22.32	22.51	22.53	22.57	22.43	22.72	22.71	22.73	0
HSDPA Subtest-3	21.90	21.86	22.05	22.05	22.09	21.96	22.23	22.22	22.24	0.5
HSDPA Subtest-4	21.87	21.83	22.02	22.03	22.07	21.94	22.27	22.26	22.28	0.5
DC-HSDPA Subtest-1	22.43	22.39	22.58	22.59	22.63	22.45	22.78	22.77	22.79	0
DC-HSDPA Subtest-2	22.37	22.33	22.52	22.64	22.68	22.48	22.74	22.73	22.75	0
DC-HSDPA Subtest-3	21.94	21.90	22.09	22.06	22.10	21.89	22.32	22.31	22.33	0.5
DC-HSDPA Subtest-4	21.93	21.89	22.08	21.99	22.03	21.95	22.29	22.28	22.30	0.5
HSUPA Subtest-1	22.29	22.25	22.44	22.52	22.56	22.51	22.72	22.71	22.73	0
HSUPA Subtest-2	20.46	20.42	20.61	20.65	20.69	20.43	20.67	20.66	20.68	2
HSUPA Subtest-3	21.32	21.28	21.47	21.69	21.73	21.70	21.74	21.73	21.75	1
HSUPA Subtest-4	20.26	20.22	20.41	20.61	20.65	20.38	20.71	20.70	20.72	2
HSUPA Subtest-5	22.31	22.27	22.46	22.53	22.57	22.55	22.80	22.79	22.81	0
HSPA+ Subtest-1	19.91	19.88	20.03	20.11	20.16	19.89	20.24	20.21	20.27	2.5

FCC SAR Test Report

LTE Band 2							
BW	MCS Index	RB Size	RB Offset	Low	Mid	High	3GPP MPR (dB)
		Channel		18700	18900	19100	
		Frequency (MHz)		1860	1880	1900	
20M	QPSK	1	0	23.31	23.37	23.27	0
		1	50	23.29	23.35	23.25	0
		1	99	23.25	23.31	23.21	0
		50	0	22.45	22.51	22.41	1
		50	25	22.44	22.50	22.40	1
		50	50	22.42	22.48	22.38	1
		100	0	22.40	22.46	22.36	1
	16QAM	1	0	22.50	22.56	22.46	1
		1	50	22.55	22.61	22.51	1
		1	99	22.52	22.58	22.48	1
		50	0	21.34	21.40	21.30	2
		50	25	21.37	21.43	21.33	2
		50	50	21.35	21.41	21.31	2
		100	0	21.33	21.39	21.29	2
	64QAM	1	0	21.37	21.43	21.33	2
		1	50	21.42	21.48	21.38	2
		1	99	21.43	21.49	21.39	2
		50	0	20.47	20.53	20.43	3
		50	25	20.38	20.44	20.34	3
		50	50	20.35	20.41	20.31	3
		100	0	20.33	20.39	20.29	3
BW	MCS Index	Channel		18675	18900	19125	3GPP MPR
		Frequency (MHz)		1857.5	1880	1902.5	
15M	QPSK	1	0	23.30	23.33	23.19	0
		1	37	23.25	23.32	23.19	0
		1	74	23.23	23.30	23.17	0
		36	0	22.39	22.46	22.40	1
		36	19	22.43	22.48	22.35	1
		36	39	22.34	22.41	22.36	1
		75	0	22.39	22.42	22.33	1
	16QAM	1	0	22.47	22.55	22.40	1
		1	37	22.51	22.56	22.49	1
		1	74	22.46	22.56	22.45	1
		36	0	21.32	21.32	21.29	2
		36	19	21.29	21.39	21.28	2
		36	39	21.32	21.35	21.29	2
		75	0	21.32	21.34	21.21	2
	64QAM	1	0	21.31	21.40	21.29	2
		1	37	21.40	21.41	21.33	2
		1	74	21.37	21.41	21.37	2
		36	0	20.46	20.51	20.35	3
		36	19	20.31	20.36	20.28	3
		36	39	20.33	20.40	20.27	3
		75	0	20.31	20.31	20.28	3

FCC SAR Test Report

BW	MCS Index	RB Size	RB Offset	Low	Mid	High	3GPP MPR
		Channel		18650	18900	19150	
		Frequency (MHz)		1855	1880	1905	
10M	QPSK	1	0	23.23	23.33	23.22	0
		1	24	23.27	23.27	23.24	0
		1	49	23.17	23.27	23.16	0
		25	0	22.42	22.45	22.39	1
		25	12	22.42	22.43	22.35	1
		25	25	22.36	22.40	22.36	1
		50	0	22.39	22.44	22.28	1
	16QAM	1	0	22.43	22.48	22.40	1
		1	24	22.52	22.55	22.49	1
		1	49	22.50	22.51	22.43	1
		25	0	21.28	21.32	21.28	2
		25	12	21.35	21.35	21.32	2
		25	25	21.27	21.37	21.26	2
		50	0	21.31	21.31	21.28	2
	64QAM	1	0	21.29	21.39	21.28	2
		1	24	21.39	21.42	21.36	2
		1	49	21.41	21.42	21.34	2
		25	0	20.41	20.45	20.41	3
		25	12	20.37	20.42	20.26	3
		25	25	20.30	20.33	20.25	3
		50	0	20.32	20.33	20.27	3
BW	MCS Index	Channel		18625	18900	19175	3GPP MPR
		Frequency (MHz)		1852.5	1880	1907.5	
5M	QPSK	1	0	23.26	23.30	23.22	0
		1	12	23.27	23.27	23.23	0
		1	24	23.20	23.23	23.20	0
		12	0	22.41	22.46	22.36	1
		12	6	22.36	22.49	22.35	1
		12	13	22.38	22.43	22.37	1
		25	0	22.34	22.44	22.31	1
	16QAM	1	0	22.43	22.51	22.44	1
		1	12	22.47	22.59	22.46	1
		1	24	22.50	22.50	22.46	1
		12	0	21.26	21.34	21.22	2
		12	6	21.31	21.41	21.27	2
		12	13	21.28	21.36	21.29	2
		25	0	21.27	21.32	21.24	2
	64QAM	1	0	21.30	21.38	21.31	2
		1	12	21.34	21.46	21.32	2
		1	24	21.35	21.48	21.37	2
		12	0	20.43	20.48	20.35	3
		12	6	20.30	20.43	20.32	3
		12	13	20.31	20.36	20.23	3
		25	0	20.27	20.37	20.26	3

FCC SAR Test Report

BW	MCS Index	RB Size	RB Offset	Low	Mid	High	3GPP MPR
		Channel		18615	18900	19185	
		Frequency (MHz)		1851.5	1880	1908.5	
3M	QPSK	1	0	23.25	23.35	23.21	0
		1	12	23.22	23.30	23.23	0
		1	24	23.19	23.24	23.16	0
		12	0	22.38	22.46	22.39	1
		12	6	22.36	22.48	22.34	1
		12	13	22.34	22.47	22.36	1
		25	0	22.36	22.41	22.28	1
	16QAM	1	0	22.42	22.55	22.44	1
		1	12	22.50	22.56	22.47	1
		1	24	22.50	22.50	22.47	1
		12	0	21.26	21.36	21.25	2
		12	6	21.34	21.37	21.31	2
		12	13	21.33	21.34	21.26	2
		25	0	21.27	21.31	21.27	2
	64QAM	1	0	21.36	21.41	21.25	2
		1	12	21.37	21.40	21.32	2
		1	24	21.42	21.43	21.37	2
		12	0	20.42	20.51	20.36	3
		12	6	20.36	20.36	20.33	3
		12	13	20.27	20.37	20.26	3
		25	0	20.31	20.31	20.28	3
BW	MCS Index	Channel		18700	18900	19100	3GPP MPR
		Frequency (MHz)		1860	1880	1900	
1.4M	QPSK	1	0	23.23	23.33	23.22	0
		1	12	23.26	23.29	23.23	0
		1	24	23.23	23.24	23.16	0
		12	0	23.39	23.43	23.39	1
		12	6	23.43	23.48	23.32	1
		12	13	23.37	23.40	23.32	1
		25	0	22.39	22.40	22.34	1
	16QAM	1	0	22.45	22.49	22.41	1
		1	12	22.53	22.53	22.49	1
		1	24	22.47	22.50	22.47	1
		12	0	22.30	22.35	22.25	2
		12	6	22.29	22.42	22.28	2
		12	13	22.31	22.36	22.30	2
		25	0	21.27	21.37	21.24	2
	64QAM	1	0	21.30	21.38	21.31	2
		1	12	21.34	21.46	21.33	2
		1	24	21.41	21.41	21.37	2
		12	0	21.39	21.47	21.35	3
		12	6	21.32	21.42	21.28	3
		12	13	21.30	21.33	21.30	3
		25	0	20.29	20.34	20.24	3

FCC SAR Test Report

LTE Band 4							
BW	MCS Index	RB Size	RB Offset	Low	Mid	High	3GPP MPR (dB)
		Channel		20050	20175	20300	
		Frequency (MHz)		1720	1732.5	1745	
20M	QPSK	1	0	23.33	23.22	23.21	0
		1	50	23.38	23.27	23.26	0
		1	99	23.32	23.21	23.20	0
		50	0	22.54	22.43	22.42	1
		50	25	22.51	22.40	22.39	1
		50	50	22.53	22.42	22.41	1
	16QAM	100	0	22.47	22.36	22.35	1
		1	0	22.60	22.49	22.48	1
		1	50	22.62	22.51	22.50	1
		1	99	22.60	22.49	22.48	1
		50	0	21.55	21.44	21.43	2
		50	25	21.57	21.46	21.45	2
	64QAM	50	50	21.55	21.44	21.43	2
		100	0	21.49	21.38	21.37	2
		1	0	21.52	21.41	21.40	2
		1	50	21.56	21.45	21.44	2
		1	99	21.58	21.47	21.46	2
		50	0	20.53	20.42	20.41	3
15M	QPSK	50	25	20.55	20.44	20.43	3
		50	50	20.54	20.43	20.42	3
		100	0	20.50	20.39	20.38	3
		1	0	23.32	23.18	23.13	0
		1	37	23.34	23.24	23.20	0
		1	74	23.30	23.20	23.16	0
	16QAM	36	0	22.48	22.38	22.41	1
		36	19	22.50	22.38	22.34	1
		36	39	22.45	22.35	22.39	1
		75	0	22.46	22.32	22.32	1
		1	0	22.57	22.48	22.42	1
		1	37	22.58	22.46	22.48	1
	64QAM	1	74	22.54	22.47	22.45	1
		36	0	21.53	21.36	21.42	2
		36	19	21.49	21.42	21.40	2
		36	39	21.52	21.38	21.41	2
		75	0	21.48	21.33	21.29	2
		1	0	21.46	21.38	21.36	2
		1	37	21.54	21.38	21.39	2
		1	74	21.52	21.39	21.44	2
		36	0	20.52	20.40	20.33	3
		36	19	20.48	20.36	20.37	3
		36	39	20.52	20.42	20.38	3
		75	0	20.48	20.31	20.37	3

FCC SAR Test Report

BW	MCS Index	Channel		20000	20175	20350	3GPP MPR
		Frequency (MHz)		1715	1732.5	1750	
10M	QPSK	1	0	23.25	23.18	23.16	0
		1	24	23.36	23.19	23.25	0
		1	49	23.24	23.17	23.15	0
		25	0	22.51	22.37	22.40	1
		25	12	22.49	22.33	22.34	1
		25	25	22.47	22.34	22.39	1
		50	0	22.46	22.34	22.27	1
	16QAM	1	0	22.53	22.41	22.42	1
		1	24	22.59	22.45	22.48	1
		1	49	22.58	22.42	22.43	1
		25	0	21.49	21.36	21.41	2
		25	12	21.55	21.38	21.44	2
		25	25	21.47	21.40	21.38	2
		50	0	21.47	21.30	21.36	2
	64QAM	1	0	21.44	21.37	21.35	2
		1	24	21.53	21.39	21.42	2
		1	49	21.56	21.40	21.41	2
		25	0	20.47	20.34	20.39	3
		25	12	20.54	20.42	20.35	3
		25	25	20.49	20.35	20.36	3
		50	0	20.49	20.33	20.36	3
BW	MCS Index	Channel		19975	20175	20375	3GPP MPR
Frequency (MHz)		1712.5	1732.5	1752.5			
5M	QPSK	1	0	23.28	23.15	23.16	0
		1	12	23.36	23.19	23.24	0
		1	24	23.27	23.13	23.19	0
		12	0	22.50	22.38	22.37	1
		12	6	22.43	22.39	22.34	1
		12	13	22.49	22.37	22.40	1
		25	0	22.41	22.34	22.30	1
	16QAM	1	0	22.53	22.44	22.46	1
		1	12	22.54	22.49	22.45	1
		1	24	22.58	22.41	22.46	1
		12	0	21.47	21.38	21.35	2
		12	6	21.51	21.44	21.39	2
		12	13	21.48	21.39	21.41	2
		25	0	21.43	21.31	21.32	2
	64QAM	1	0	21.45	21.36	21.38	2
		1	12	21.48	21.43	21.38	2
		1	24	21.50	21.46	21.44	2
		12	0	20.49	20.37	20.33	3
		12	6	20.47	20.43	20.41	3
		12	13	20.50	20.38	20.34	3
		25	0	20.44	20.37	20.35	3

FCC SAR Test Report

BW	MCS Index	Channel		19965	20175	20385	3GPP MPR
		Frequency (MHz)		1711.5	1732.5	1753.5	
3M	QPSK	1	0	23.27	23.20	23.15	0
		1	7	23.31	23.22	23.24	0
		1	14	23.26	23.14	23.15	0
		8	0	22.47	22.38	22.40	1
		8	3	22.43	22.38	22.33	1
		8	7	22.45	22.41	22.39	1
		15	0	22.43	22.31	22.27	1
	16QAM	1	0	22.52	22.48	22.46	1
		1	7	22.57	22.46	22.46	1
		1	14	22.58	22.41	22.47	1
		8	0	21.47	21.40	21.38	2
		8	3	21.54	21.40	21.43	2
		8	7	21.53	21.37	21.38	2
		15	0	21.43	21.30	21.35	2
	64QAM	1	0	21.51	21.39	21.32	2
		1	7	21.51	21.37	21.38	2
		1	14	21.57	21.41	21.44	2
		8	0	20.48	20.40	20.34	3
		8	3	20.53	20.36	20.42	3
		8	7	20.46	20.39	20.37	3
		15	0	20.48	20.31	20.37	3
BW	MCS Index	Channel		19957	20175	20393	3GPP MPR
Frequency (MHz)		1710.7	1732.5	1754.3			
1.4M	QPSK	1	0	23.25	23.18	23.16	0
		1	2	23.35	23.21	23.24	0
		1	5	23.30	23.14	23.15	0
		3	0	23.28	23.15	23.20	0
		3	1	23.30	23.18	23.11	0
		3	3	23.28	23.14	23.15	0
		6	0	22.46	22.30	22.33	1
	16QAM	1	0	22.55	22.42	22.43	1
		1	2	22.60	22.43	22.48	1
		1	5	22.55	22.41	22.47	1
		3	0	22.51	22.39	22.38	1
		3	1	22.49	22.45	22.40	1
		3	3	22.51	22.39	22.42	1
		6	0	21.43	21.36	21.32	2
	64QAM	1	0	21.45	21.36	21.38	2
		1	2	21.48	21.43	21.39	2
		1	5	21.56	21.39	21.44	2
		3	0	21.45	20.36	20.33	2
		3	1	21.49	20.42	20.37	2
		3	3	21.49	20.35	20.41	2
		6	0	20.46	20.34	20.33	3

FCC SAR Test Report

LTE Band 5							
BW	MCS Index	RB Size	RB Offset	Low	Mid	High	3GPP MPR (dB)
		Channel		20450	20525	20600	
		Frequency (MHz)		829	836.5	844	
10M	QPSK	1	0	23.94	23.98	23.91	0
		1	24	23.92	23.96	23.89	0
		1	49	23.84	23.88	23.81	0
		25	0	22.98	23.02	22.95	1
		25	12	23.00	23.04	22.97	1
		25	25	22.94	22.98	22.91	1
		50	0	22.97	23.01	22.94	1
	16QAM	1	0	23.14	23.18	23.11	1
		1	24	23.09	23.13	23.06	1
		1	49	23.14	23.18	23.11	1
		25	0	22.04	22.08	22.01	2
		25	12	22.02	22.06	21.99	2
		25	25	21.97	22.01	21.94	2
		50	0	21.96	22.00	21.93	2
	64QAM	1	0	22.15	22.19	22.12	2
		1	24	22.09	22.13	22.06	2
		1	49	21.99	22.03	21.96	2
		25	0	20.97	21.01	20.94	3
25		12	20.98	21.02	20.95	3	
25		25	20.93	20.97	20.90	3	
50		0	20.96	21.00	20.93	3	
BW	MCS Index	Channel		20425	20525	20625	3GPP MPR
		Frequency (MHz)		826.5	836.5	846.5	
5M	QPSK	1	0	23.89	23.91	23.86	0
		1	12	23.90	23.88	23.87	0
		1	24	23.79	23.80	23.80	0
		12	0	22.94	22.97	22.90	1
		12	6	22.92	23.03	22.92	1
		12	13	22.90	22.93	22.90	1
		25	0	22.91	22.99	22.89	1
	16QAM	1	0	23.07	23.13	23.09	1
		1	12	23.01	23.11	23.01	1
		1	24	23.12	23.10	23.09	1
		12	0	21.96	22.02	21.93	2
		12	6	21.96	22.04	21.93	2
		12	13	21.90	21.96	21.92	2
		25	0	21.90	21.93	21.88	2
	64QAM	1	0	22.08	22.14	22.10	2
		1	12	22.01	22.11	22.00	2
		1	24	21.91	22.02	21.94	2
		12	0	20.93	20.96	20.86	3
		12	6	20.90	21.01	20.93	3
		12	13	20.89	20.92	20.82	3
		25	0	20.90	20.98	20.90	3

FCC SAR Test Report

BW	MCS Index	Channel		20415	20525	20635	3GPP MPR	
		Frequency (MHz)		825.5	836.5	847.5		
3M	QPSK	1	0	23.88	23.96	23.85	0	
		1	7	23.85	23.91	23.87	0	
		1	14	23.78	23.81	23.76	0	
		8	0	22.91	22.97	22.93	1	
		8	3	22.92	23.02	22.91	1	
		8	7	22.86	22.97	22.89	1	
	16QAM	15	0	22.93	22.96	22.86	1	
		1	0	23.06	23.17	23.09	1	
		1	7	23.04	23.08	23.02	1	
		1	14	23.12	23.10	23.10	1	
		8	0	21.96	22.04	21.96	2	
		8	3	21.99	22.00	21.97	2	
	64QAM	8	7	21.95	21.94	21.89	2	
		15	0	21.90	21.92	21.91	2	
		1	0	22.14	22.17	22.04	2	
		1	7	22.04	22.05	22.00	2	
		1	14	21.98	21.97	21.94	2	
		8	0	20.92	20.99	20.87	3	
	1.4M	QPSK	8	3	20.96	20.94	20.94	3
			8	7	20.85	20.93	20.85	3
			15	0	20.94	20.92	20.92	3
1			0	23.86	23.94	23.86	0	
1			2	23.89	23.90	23.87	0	
1			5	23.82	23.81	23.76	0	
16QAM		3	0	23.92	23.94	23.93	0	
		3	1	23.95	23.92	23.89	0	
		3	3	23.89	23.90	23.85	0	
		6	0	22.96	22.95	22.92	1	
		1	0	23.09	23.11	23.06	1	
		1	2	23.07	23.05	23.04	1	
64QAM		1	5	23.09	23.10	23.10	1	
		3	0	23.00	23.03	22.96	1	
		3	1	22.94	23.05	22.94	1	
		3	3	22.93	22.96	22.93	1	
		6	0	21.90	21.98	21.88	2	
		1	0	22.08	22.14	22.10	2	
QPSK		1	2	22.01	22.11	22.01	2	
		1	5	21.97	21.95	21.94	2	
		3	0	21.89	21.95	21.86	2	
	3	1	21.92	22.00	21.89	2		
	3	3	21.88	21.89	21.89	2		
	6	0	20.92	20.95	20.88	3		

FCC SAR Test Report

LTE Band 7							
BW	MCS Index	RB Size	RB Offset	Low	Mid	Mid	3GPP MPR (dB)
		Channel		20850	21100	21350	
		Frequency (MHz)		2510	2535	2560	
20M	QPSK	1	0	23.08	23.17	23.19	0
		1	50	23.05	23.14	23.16	0
		1	99	22.95	23.04	23.06	0
		50	0	22.15	22.24	22.26	1
		50	25	22.10	22.19	22.21	1
		50	50	22.16	22.25	22.27	1
	16QAM	100	0	22.09	22.18	22.20	1
		1	0	22.37	22.46	22.48	1
		1	50	22.30	22.39	22.41	1
		1	99	22.18	22.27	22.29	1
		50	0	21.21	21.30	21.32	2
		50	25	21.19	21.28	21.30	2
	64QAM	50	50	21.20	21.29	21.31	2
		100	0	21.15	21.24	21.26	2
		1	0	21.25	21.34	21.36	2
		1	50	21.17	21.26	21.28	2
		1	99	21.13	21.22	21.24	2
		50	0	20.20	20.29	20.31	3
15M	QPSK	50	25	20.16	20.25	20.27	3
		50	50	20.19	20.28	20.30	3
		100	0	20.14	20.23	20.25	3
		1	0	23.07	23.13	23.11	0
		1	37	23.01	23.11	23.10	0
		1	74	22.93	23.03	23.02	0
	16QAM	36	0	22.09	22.19	22.25	1
		36	19	22.09	22.17	22.16	1
		36	39	22.08	22.18	22.25	1
		75	0	22.08	22.14	22.17	1
		1	0	22.34	22.45	22.42	1
		1	37	22.26	22.34	22.39	1
	64QAM	1	74	22.12	22.25	22.26	1
		36	0	21.19	21.22	21.31	2
		36	19	21.11	21.24	21.25	2
		36	39	21.17	21.23	21.29	2
		75	0	21.14	21.19	21.18	2
		1	0	21.19	21.31	21.32	2
64QAM	1	37	21.15	21.19	21.23	2	
	1	74	21.07	21.14	21.22	2	
	36	0	20.19	20.27	20.23	3	
	36	19	20.09	20.17	20.21	3	
	36	39	20.17	20.27	20.26	3	
	75	0	20.12	20.15	20.24	3	

FCC SAR Test Report

BW	MCS Index	Channel		20800	21100	21400	3GPP MPR
		Frequency (MHz)		2505	2535	2565	
10M	QPSK	1	0	23.00	23.13	23.14	0
		1	24	23.03	23.06	23.15	0
		1	49	22.87	23.00	23.01	0
		25	0	22.12	22.18	22.24	1
		25	12	22.08	22.12	22.16	1
		25	25	22.10	22.17	22.25	1
		50	0	22.08	22.16	22.12	1
	16QAM	1	0	22.30	22.38	22.42	1
		1	24	22.27	22.33	22.39	1
		1	49	22.16	22.20	22.24	1
		25	0	21.15	21.22	21.30	2
		25	12	21.17	21.20	21.29	2
		25	25	21.12	21.25	21.26	2
		50	0	21.13	21.16	21.25	2
	64QAM	1	0	21.17	21.30	21.31	2
		1	24	21.14	21.20	21.26	2
		1	49	21.11	21.15	21.19	2
		25	0	20.14	20.21	20.29	3
		25	12	20.15	20.23	20.19	3
		25	25	20.14	20.20	20.24	3
		50	0	20.13	20.17	20.23	3
BW	MCS Index	Channel		20775	21100	21425	3GPP MPR
		Frequency (MHz)		2502.5	2535	2567.5	
5M	QPSK	1	0	23.03	23.10	23.14	0
		1	12	23.03	23.06	23.14	0
		1	24	22.90	22.96	23.05	0
		12	0	22.11	22.19	22.21	1
		12	6	22.02	22.18	22.16	1
		12	13	22.12	22.20	22.26	1
		25	0	22.03	22.16	22.15	1
	16QAM	1	0	22.30	22.41	22.46	1
		1	12	22.22	22.37	22.36	1
		1	24	22.16	22.19	22.27	1
		12	0	21.13	21.24	21.24	2
		12	6	21.13	21.26	21.24	2
		12	13	21.13	21.24	21.29	2
		25	0	21.09	21.17	21.21	2
	64QAM	1	0	21.18	21.29	21.34	2
		1	12	21.09	21.24	21.22	2
		1	24	21.05	21.21	21.22	2
		12	0	20.16	20.24	20.23	3
		12	6	20.08	20.24	20.25	3
		12	13	20.15	20.23	20.22	3
		25	0	20.08	20.21	20.22	3

FCC SAR Test Report

LTE Band 38							
BW	MCS Index	RB Size	RB Offset	Low	Mid	Mid	3GPP MPR (dB)
		Channel		37850	38000	38150	
		Frequency (MHz)		2580	2595	2610	
20M	QPSK	1	0	23.01	23.03	23.08	0
		1	50	23.00	23.02	23.07	0
		1	99	23.07	23.09	23.14	0
		50	0	22.20	22.22	22.27	1
		50	25	22.17	22.19	22.24	1
		50	50	22.18	22.20	22.25	1
	16QAM	100	0	22.21	22.23	22.28	1
		1	0	22.12	22.14	22.19	1
		1	50	22.13	22.15	22.20	1
		1	99	22.27	22.29	22.34	1
		50	0	21.28	21.30	21.35	2
		50	25	21.27	21.29	21.34	2
	64QAM	50	50	21.26	21.28	21.33	2
		100	0	21.28	21.30	21.35	2
		1	0	20.78	20.80	20.85	2
		1	50	20.76	20.78	20.83	2
		1	99	20.88	20.90	20.95	2
		50	0	20.27	20.29	20.34	3
15M	QPSK	50	25	20.30	20.32	20.37	3
		50	50	20.29	20.31	20.36	3
		100	0	20.27	20.29	20.34	3
		1	0	23.00	22.99	23.00	0
		1	37	22.96	22.99	23.01	0
		1	74	23.05	23.08	23.10	0
	16QAM	36	0	22.14	22.17	22.26	1
		36	19	22.16	22.17	22.19	1
		36	39	22.10	22.13	22.23	1
		75	0	22.20	22.19	22.25	1
		1	0	22.09	22.13	22.13	1
		1	37	22.09	22.10	22.18	1
	64QAM	1	74	22.21	22.27	22.31	1
		36	0	21.26	21.22	21.34	2
		36	19	21.19	21.25	21.29	2
		36	39	21.23	21.22	21.31	2
		75	0	21.27	21.25	21.27	2
		1	0	20.72	20.77	20.81	2
64QAM	1	37	20.74	20.71	20.78	2	
	1	74	20.82	20.82	20.93	2	
	36	0	20.26	20.27	20.26	3	
	36	19	20.23	20.24	20.31	3	
	36	39	20.27	20.30	20.32	3	
	75	0	20.25	20.21	20.33	3	

FCC SAR Test Report

BW	MCS Index	Channel		37800	38000	38200	3GPP MPR
		Frequency (MHz)		2575	2595	2615	
10M	QPSK	1	0	22.93	22.99	23.03	0
		1	24	22.98	22.94	23.06	0
		1	49	22.99	23.05	23.09	0
		25	0	22.17	22.16	22.25	1
		25	12	22.15	22.12	22.19	1
		25	25	22.12	22.12	22.23	1
		50	0	22.20	22.21	22.20	1
	16QAM	1	0	22.05	22.06	22.13	1
		1	24	22.10	22.09	22.18	1
		1	49	22.25	22.22	22.29	1
		25	0	21.22	21.22	21.33	2
		25	12	21.25	21.21	21.33	2
		25	25	21.18	21.24	21.28	2
		50	0	21.26	21.22	21.34	2
	64QAM	1	0	20.70	20.76	20.80	2
		1	24	20.73	20.72	20.81	2
		1	49	20.86	20.83	20.90	2
		25	0	20.21	20.21	20.32	3
		25	12	20.29	20.30	20.29	3
		25	25	20.24	20.23	20.30	3
		50	0	20.26	20.23	20.32	3
BW	MCS Index	Channel		37775	38000	38225	3GPP MPR
Frequency (MHz)		2572.5	2595	2617.5			
5M	QPSK	1	0	22.96	22.96	23.03	0
		1	12	22.98	22.94	23.05	0
		1	24	23.02	23.01	23.13	0
		12	0	22.16	22.17	22.22	1
		12	6	22.09	22.18	22.19	1
		12	13	22.14	22.15	22.24	1
		25	0	22.15	22.21	22.23	1
	16QAM	1	0	22.05	22.09	22.17	1
		1	12	22.05	22.13	22.15	1
		1	24	22.25	22.21	22.32	1
		12	0	21.20	21.24	21.27	2
		12	6	21.21	21.27	21.28	2
		12	13	21.19	21.23	21.31	2
		25	0	21.22	21.23	21.30	2
	64QAM	1	0	20.71	20.75	20.83	2
		1	12	20.68	20.76	20.77	2
		1	24	20.80	20.89	20.93	2
		12	0	20.23	20.24	20.26	3
		12	6	20.22	20.31	20.35	3
		12	13	20.25	20.26	20.28	3
		25	0	20.21	20.27	20.31	3

FCC SAR Test Report

LTE Band 41							
BW	MCS Index	RB Size	RB Offset	Low	Mid	Mid	3GPP MPR (dB)
		Channel		40140	40640	41140	
		Frequency (MHz)		2545	2595	2645	
20M	QPSK	1	0	23.03	23.11	23.38	0
		1	50	22.96	23.04	23.31	0
		1	99	22.87	22.95	23.22	0
		50	0	22.12	22.20	22.47	1
		50	25	22.09	22.17	22.44	1
		50	50	22.07	22.15	22.42	1
	16QAM	100	0	22.08	22.16	22.43	1
		1	0	22.16	22.24	22.51	1
		1	50	22.05	22.13	22.40	1
		1	99	22.00	22.08	22.35	1
		50	0	21.21	21.29	21.56	2
		50	25	21.16	21.24	21.51	2
	64QAM	50	50	21.13	21.21	21.48	2
		100	0	21.17	21.25	21.52	2
		1	0	20.81	20.89	21.16	2
		1	50	20.70	20.78	21.05	2
		1	99	20.68	20.76	21.03	2
		50	0	20.21	20.29	20.56	3
15M	QPSK	50	25	20.19	20.27	20.54	3
		50	50	20.13	20.21	20.48	3
		100	0	20.15	20.23	20.50	3
		1	0	23.02	23.07	23.30	0
		1	37	22.92	23.01	23.25	0
		1	74	22.85	22.94	23.18	0
	16QAM	36	0	22.06	22.15	22.46	1
		36	19	22.08	22.15	22.39	1
		36	39	21.99	22.08	22.40	1
		75	0	22.07	22.12	22.40	1
		1	0	22.13	22.23	22.45	1
		1	37	22.01	22.08	22.38	1
	64QAM	1	74	21.94	22.06	22.32	1
		36	0	21.19	21.21	21.55	2
		36	19	21.08	21.20	21.46	2
		36	39	21.10	21.15	21.46	2
		75	0	21.16	21.20	21.44	2
		1	0	20.75	20.86	21.12	2
64QAM	1	37	20.68	20.71	21.00	2	
	1	74	20.62	20.68	21.01	2	
	36	0	20.20	20.27	20.48	3	
	36	19	20.12	20.19	20.48	3	
	36	39	20.11	20.20	20.44	3	
	75	0	20.13	20.15	20.49	3	

FCC SAR Test Report

BW	MCS Index	Channel		40090	40640	41190	3GPP MPR
		Frequency (MHz)		2540	2595	2650	
10M	QPSK	1	0	22.95	23.07	23.33	0
		1	24	22.94	22.96	23.30	0
		1	49	22.79	22.91	23.17	0
		25	0	22.09	22.14	22.45	1
		25	12	22.07	22.10	22.39	1
		25	25	22.01	22.07	22.40	1
		50	0	22.07	22.14	22.35	1
	16QAM	1	0	22.09	22.16	22.45	1
		1	24	22.02	22.07	22.38	1
		1	49	21.98	22.01	22.30	1
		25	0	21.15	21.21	21.54	2
		25	12	21.14	21.16	21.50	2
		25	25	21.05	21.17	21.43	2
		50	0	21.15	21.17	21.51	2
	64QAM	1	0	20.73	20.85	21.11	2
		1	24	20.67	20.72	21.03	2
		1	49	20.66	20.69	20.98	2
		25	0	20.15	20.21	20.54	3
		25	12	20.18	20.25	20.46	3
		25	25	20.08	20.13	20.42	3
		50	0	20.14	20.17	20.48	3
BW	MCS Index	Channel		40065	40640	41215	3GPP MPR
		Frequency (MHz)		2537.5	2595	2652.5	
5M	QPSK	1	0	22.98	23.04	23.33	0
		1	12	22.94	22.96	23.29	0
		1	24	22.82	22.87	23.21	0
		12	0	22.08	22.15	22.42	1
		12	6	22.01	22.16	22.39	1
		12	13	22.03	22.10	22.41	1
		25	0	22.02	22.14	22.38	1
	16QAM	1	0	22.09	22.19	22.49	1
		1	12	21.97	22.11	22.35	1
		1	24	21.98	22.00	22.33	1
		12	0	21.13	21.23	21.48	2
		12	6	21.10	21.22	21.45	2
		12	13	21.06	21.16	21.46	2
		25	0	21.11	21.18	21.47	2
	64QAM	1	0	20.74	20.84	21.14	2
		1	12	20.62	20.76	20.99	2
		1	24	20.60	20.75	21.01	2
		12	0	20.17	20.24	20.48	3
		12	6	20.11	20.26	20.52	3
		12	13	20.09	20.16	20.40	3
		25	0	20.09	20.21	20.47	3

FCC SAR Test Report

<WLAN 2.4G>

Mode	Channel	Frequency	Avg. Power		
			Ant 0	Ant 1	MIMO
802.11b	1	2412	15.92	16.60	18.62
	6	2437	16.30	16.54	18.86
	11	2462	15.62	16.35	18.58
802.11g	1	2412	12.91	13.72	15.61
	6	2437	13.23	12.90	15.69
	11	2462	12.39	12.51	15.45
802.11n HT20	1	2412	10.86	11.43	13.49
	6	2437	11.20	10.71	13.69
	11	2462	10.33	10.38	13.31
802.11n HT40	3	2422	11.01	11.73	13.87
	9	2452	11.43	10.86	13.93
	11	2462	11.14	10.85	14.10

Bluetooth			
Mode	Channel	Frequency	Avg. Power
BR / EDR	0	2402	9.12
	39	2441	9.59
	78	2480	9.72
BT 4.0 LE	0	2402	1.10
	19	2440	1.07
	39	2480	1.50
BT 5.0 LE	0	2402	1.00
	19	2440	1.21
	39	2480	1.58

FCC SAR Test Report

<WLAN 5.2G>

Mode	Channel	Frequency	Avg. Power		
			Ant 0	Ant 1	MIMO
802.11a	36	5180	15.06	14.91	17.59
	40	5200	15.21	15.07	17.80
	48	5240	15.38	15.16	17.89
802.11n HT20	36	5180	13.22	12.48	15.63
	40	5200	13.36	12.75	15.72
	48	5240	13.60	12.87	15.84
802.11n HT40	38	5190	13.47	13.11	15.98
	46	5230	13.76	13.36	16.20
802.11ac VHT80	42	5210	11.47	10.95	13.89

<WLAN 5.3G>

Mode	Channel	Frequency	Avg. Power		
			Ant 0	Ant 1	MIMO
802.11a	52	5260	15.31	15.17	17.86
	60	5300	15.13	15.17	17.73
	64	5320	15.18	15.29	17.83
802.11n HT20	52	5260	13.46	13.15	15.88
	60	5300	13.30	13.15	15.75
	64	5320	13.27	13.14	15.75
802.11n HT40	54	5270	13.62	13.46	16.12
	62	5310	13.46	13.46	16.01
802.11ac VHT80	58	5290	11.46	11.21	13.83

FCC SAR Test Report

<WLAN 5.6G>

Mode	Channel	Frequency	Avg. Power		
			Ant 0	Ant 1	MIMO
802.11a	100	5500	14.09	14.23	16.69
	116	5580	14.13	13.84	16.60
	140	5700	14.42	14.79	17.28
802.11n HT20	100	5500	13.09	13.17	15.74
	116	5580	13.00	12.91	15.54
	140	5700	13.40	13.81	16.22
802.11n HT40	102	5510	13.39	13.41	15.97
	110	5550	13.25	13.14	15.80
	134	5670	13.63	14.11	16.49
802.11ac VHT80	106	5530	11.08	11.00	13.73
	122	5610	11.14	11.10	13.78

<WLAN 5.8G>

Mode	Channel	Frequency	Avg. Power		
			Ant 0	Ant 1	MIMO
802.11a	149	5745	15.44	15.88	18.17
	157	5785	15.00	15.59	17.89
	161	5805	14.27	14.98	17.50
802.11n HT20	149	5745	13.27	13.95	16.17
	157	5785	12.90	13.71	15.91
	161	5805	12.15	13.11	15.34
802.11n HT40	151	5755	13.64	14.32	16.57
	159	5795	13.15	13.97	16.22
802.11ac VHT80	155	5775	11.26	11.99	14.25

FCC SAR Test Report

<Reduce Power>

Band	GSM1900		
Channel	512	512	512
Frequency (MHz)	1850.2	1850.2	1850.2
Maximum Burst-Averaged Output Power			
GSM (GMSK, 1Tx-slot)	26.91	26.59	26.84
GPRS (GMSK, 1Tx-slot)	26.90	26.48	26.80
GPRS (GMSK, 2Tx-slot)	24.38	24.79	24.55
GPRS (GMSK, 3Tx-slot)	22.76	23.29	23.03
GPRS (GMSK, 4Tx-slot)	22.28	21.90	21.62
EDGE (8PSK, 1Tx-slot)	24.14	23.91	23.95
EDGE (8PSK, 2Tx-slot)	21.46	21.17	21.27
EDGE (8PSK, 3Tx-slot)	19.55	19.43	19.41
EDGE (8PSK, 4Tx-slot)	18.51	18.35	18.42
Maximum Frame-Averaged Output Power			
GSM (GMSK, 1Tx-slot)	17.91	17.59	17.84
GPRS (GMSK, 1Tx-slot)	17.90	17.48	17.80
GPRS (GMSK, 2Tx-slot)	18.38	18.79	18.55
GPRS (GMSK, 3Tx-slot)	18.50	19.03	18.77
GPRS (GMSK, 4Tx-slot)	19.28	18.90	18.62
EDGE (8PSK, 1Tx-slot)	15.14	14.91	14.95
EDGE (8PSK, 2Tx-slot)	15.46	15.17	15.27
EDGE (8PSK, 3Tx-slot)	15.29	15.17	15.15
EDGE (8PSK, 4Tx-slot)	15.51	15.35	15.42

Band	WCDMA Band II			WCDMA Band IV		
Channel	9262	9400	9538	1312	1413	1513
Frequency (MHz)	1852.4	1880.0	1907.6	1712.4	1732.6	1752.6
RMC 12.2K	20.10	20.01	20.13	20.72	20.65	20.62
HSDPA Subtest-1	19.12	19.03	19.15	19.81	19.74	19.78
HSDPA Subtest-2	19.09	19.00	19.12	19.68	19.61	19.72
HSDPA Subtest-3	18.64	18.55	18.67	19.23	19.16	19.34
HSDPA Subtest-4	18.61	18.52	18.64	19.13	19.06	19.31
DC-HSDPA Subtest-1	19.09	19.00	19.12	19.77	19.70	19.75
DC-HSDPA Subtest-2	19.15	19.06	19.18	19.63	19.56	19.73
DC-HSDPA Subtest-3	18.73	18.64	18.76	19.15	19.08	19.24
DC-HSDPA Subtest-4	18.70	18.61	18.73	19.08	19.01	19.22
HSUPA Subtest-1	19.17	19.08	19.20	19.69	19.62	19.72
HSUPA Subtest-2	17.21	17.12	17.24	17.81	17.74	17.91
HSUPA Subtest-3	18.05	17.96	18.08	18.56	18.49	18.73
HSUPA Subtest-4	17.15	17.06	17.18	17.65	17.58	17.89
HSUPA Subtest-5	18.13	18.04	18.16	19.66	19.59	19.87
HSPA+ Subtest-1	16.67	16.58	16.70	17.03	16.96	17.41

FCC SAR Test Report

LTE Band 2						
BW	MCS Index	RB Size	RB Offset	Low	Mid	High
		Channel		18700	18900	19100
		(MHz)		1860 MHz	1880 MHz	1900 MHz
20M	QPSK	1	0	19.73	19.69	19.62
		1	50	19.83	19.79	19.72
		1	99	19.79	19.75	19.68
		50	0	19.78	19.74	19.67
		50	25	19.82	19.78	19.71
		50	50	19.81	19.77	19.70
		100	0	19.74	19.70	19.63
	16QAM	1	0	19.71	19.67	19.60
		1	50	19.75	19.71	19.64
		1	99	19.79	19.75	19.68
		50	0	19.63	19.59	19.52
		50	25	19.66	19.62	19.55
		50	50	19.59	19.55	19.48
		100	0	19.71	19.67	19.60
	64QAM	1	0	19.33	19.29	19.22
		1	50	19.41	19.37	19.30
		1	99	19.35	19.31	19.24
		50	0	19.27	19.23	19.16
		50	25	19.21	19.17	19.10
		50	50	19.16	19.12	19.05
		100	0	19.22	19.18	19.11
BW	MCS Index	Channel		18675	18900	19125
		Frequency (MHz)		1857.5 MHz	1880 MHz	1902.5 MHz
15M	QPSK	1	0	19.72	19.65	19.54
		1	37	19.79	19.76	19.66
		1	74	19.77	19.74	19.64
		36	0	19.72	19.69	19.66
		36	19	19.81	19.76	19.66
		36	39	19.73	19.70	19.68
		75	0	19.73	19.66	19.60
	16QAM	1	0	19.68	19.66	19.54
		1	37	19.71	19.66	19.62
		1	74	19.73	19.73	19.65
		36	0	19.61	19.51	19.51
		36	19	19.58	19.58	19.50
		36	39	19.56	19.49	19.46
		75	0	19.70	19.62	19.52
	64QAM	1	0	19.27	19.26	19.18
		1	37	19.39	19.30	19.25
		1	74	19.29	19.23	19.22
		36	0	19.26	19.21	19.08
		36	19	19.14	19.09	19.04
		36	39	19.14	19.11	19.01
		75	0	19.20	19.10	19.10

FCC SAR Test Report

BW	MCS Index	Channel		18650	18900	19150
		Frequency (MHz)		1855 MHz	1880 MHz	1905 MHz
10M	QPSK	1	0	19.65	19.65	19.57
		1	24	19.81	19.71	19.71
		1	49	19.71	19.71	19.63
		25	0	19.75	19.68	19.65
		25	12	19.80	19.71	19.66
		25	25	19.75	19.69	19.68
		50	0	19.73	19.68	19.55
	16QAM	1	0	19.64	19.59	19.54
		1	24	19.72	19.65	19.62
		1	49	19.77	19.68	19.63
		25	0	19.57	19.51	19.50
		25	12	19.64	19.54	19.54
		25	25	19.51	19.51	19.43
		50	0	19.69	19.59	19.59
	64QAM	1	0	19.25	19.25	19.17
		1	24	19.38	19.31	19.28
		1	49	19.33	19.24	19.19
		25	0	19.21	19.15	19.14
		25	12	19.20	19.15	19.02
		25	25	19.11	19.04	18.99
		50	0	19.21	19.12	19.09
BW	MCS Index	Channel		18625	18900	19175
5M	QPSK	Frequency (MHz)		1852.5 MHz	1880 MHz	1907.5 MHz
		1	0	19.68	19.62	19.57
		1	12	19.81	19.71	19.70
		1	24	19.74	19.67	19.67
		12	0	19.74	19.69	19.62
		12	6	19.74	19.77	19.66
		12	13	19.77	19.72	19.69
	25	0	19.68	19.68	19.58	
	16QAM	1	0	19.64	19.62	19.58
		1	12	19.67	19.69	19.59
		1	24	19.77	19.67	19.66
		12	0	19.55	19.53	19.44
		12	6	19.60	19.60	19.49
		12	13	19.52	19.50	19.46
		25	0	19.65	19.60	19.55
	64QAM	1	0	19.26	19.24	19.20
		1	12	19.33	19.35	19.24
		1	24	19.27	19.30	19.22
		12	0	19.23	19.18	19.08
		12	6	19.13	19.16	19.08
		12	13	19.12	19.07	18.97
25		0	19.16	19.16	19.08	

FCC SAR Test Report

BW	MCS Index	Channel		18615	18900	19185
		Frequency (MHz)		1851.5 MHz	1880 MHz	1908.5 MHz
3M	QPSK	1	0	19.67	19.67	19.56
		1	12	19.76	19.74	19.70
		1	24	19.73	19.68	19.63
		12	0	19.71	19.69	19.65
		12	6	19.74	19.76	19.65
		12	13	19.73	19.76	19.68
		25	0	19.70	19.65	19.55
	16QAM	1	0	19.63	19.66	19.58
		1	12	19.70	19.66	19.60
		1	24	19.77	19.67	19.67
		12	0	19.55	19.55	19.47
		12	6	19.63	19.56	19.53
		12	13	19.57	19.48	19.43
		25	0	19.65	19.59	19.58
	64QAM	1	0	19.32	19.27	19.14
		1	12	19.36	19.29	19.24
		1	24	19.34	19.25	19.22
		12	0	19.22	19.21	19.09
		12	6	19.19	19.09	19.09
		12	13	19.08	19.08	19.00
		25	0	19.20	19.10	19.10
BW	MCS Index	Channel		18700	18900	19100
1.4M	QPSK	Frequency (MHz)		1860 MHz	1880 MHz	1900 MHz
		1	0	19.65	19.65	19.57
		1	12	19.80	19.73	19.70
		1	24	19.77	19.68	19.63
		12	0	19.72	19.66	19.65
		12	6	19.81	19.76	19.63
		12	13	19.76	19.69	19.64
	25	0	19.73	19.64	19.61	
	16QAM	1	0	19.66	19.60	19.55
		1	12	19.73	19.63	19.62
		1	24	19.74	19.67	19.67
		12	0	19.59	19.54	19.47
		12	6	19.58	19.61	19.50
		12	13	19.55	19.50	19.47
		25	0	19.65	19.65	19.55
	64QAM	1	0	19.26	19.24	19.20
		1	12	19.33	19.35	19.25
		1	24	19.33	19.23	19.22
		12	0	19.19	19.17	19.08
		12	6	19.15	19.15	19.04
		12	13	19.11	19.04	19.04
25		0	19.18	19.13	19.06	

FCC SAR Test Report

LTE Band 4						
BW	MCS Index	RB Size	RB Offset	Low	Mid	High
		Channel		20050	20175	20300
		Frequency (MHz)		1720 MHz	1732.5 MHz	1745 MHz
20M	QPSK	1	0	19.83	19.71	19.64
		1	50	19.67	19.55	19.48
		1	99	19.62	19.50	19.43
		50	0	19.74	19.62	19.55
		50	25	19.79	19.67	19.60
		50	50	19.73	19.61	19.54
	16QAM	100	0	19.75	19.63	19.56
		1	0	19.71	19.59	19.52
		1	50	19.63	19.51	19.44
		1	99	19.59	19.47	19.40
		50	0	19.73	19.61	19.54
		50	25	19.58	19.46	19.39
	64QAM	50	50	19.53	19.41	19.34
		100	0	19.65	19.53	19.46
		1	0	19.47	19.35	19.28
		1	50	19.42	19.30	19.23
		1	99	19.37	19.25	19.18
		50	0	19.31	19.19	19.12
15M	QPSK	50	25	19.45	19.33	19.26
		50	50	19.55	19.43	19.36
		100	0	19.29	19.17	19.10
		1	0	19.82	19.67	19.56
		1	37	19.63	19.52	19.42
		1	74	19.60	19.49	19.39
	16QAM	36	0	19.68	19.57	19.54
		36	19	19.78	19.65	19.55
		36	39	19.65	19.54	19.52
		75	0	19.74	19.59	19.53
		1	0	19.68	19.58	19.46
		1	37	19.59	19.46	19.42
	64QAM	1	74	19.53	19.45	19.37
		36	0	19.71	19.53	19.53
		36	19	19.50	19.42	19.34
		36	39	19.50	19.35	19.32
		75	0	19.64	19.48	19.38
		1	0	19.41	19.32	19.24
	64QAM	1	37	19.40	19.23	19.18
		1	74	19.31	19.17	19.16
		36	0	19.30	19.17	19.04
		36	19	19.38	19.25	19.20
		36	39	19.53	19.42	19.32
		75	0	19.27	19.09	19.09

FCC SAR Test Report

BW	MCS Index	Channel		20000	20175	20350
		Frequency (MHz)		1715 MHz	1732.5 MHz	1750 MHz
10M	QPSK	1	0	19.75	19.67	19.59
		1	24	19.65	19.47	19.47
		1	49	19.54	19.46	19.38
		25	0	19.71	19.56	19.53
		25	12	19.77	19.60	19.55
		25	25	19.67	19.53	19.52
		50	0	19.74	19.61	19.48
	16QAM	1	0	19.64	19.51	19.46
		1	24	19.60	19.45	19.42
		1	49	19.57	19.40	19.35
		25	0	19.67	19.53	19.52
		25	12	19.56	19.38	19.38
		25	25	19.45	19.37	19.29
		50	0	19.63	19.45	19.45
	64QAM	1	0	19.39	19.31	19.23
		1	24	19.39	19.24	19.21
		1	49	19.35	19.18	19.13
		25	0	19.25	19.11	19.10
		25	12	19.44	19.31	19.18
		25	25	19.50	19.35	19.30
		50	0	19.28	19.11	19.08
BW	MCS Index	Channel		19975	20175	20375
5M	QPSK	Frequency (MHz)		1712.5 MHz	1732.5 MHz	1752.5 MHz
		1	0	19.78	19.64	19.59
		1	12	19.65	19.47	19.46
		1	24	19.57	19.42	19.42
		12	0	19.70	19.57	19.50
		12	6	19.71	19.66	19.55
		12	13	19.69	19.56	19.53
	25	0	19.69	19.61	19.51	
	16QAM	1	0	19.64	19.54	19.50
		1	12	19.55	19.49	19.39
		1	24	19.57	19.39	19.38
		12	0	19.65	19.55	19.46
		12	6	19.52	19.44	19.33
		12	13	19.46	19.36	19.32
		25	0	19.59	19.46	19.41
	64QAM	1	0	19.40	19.30	19.26
		1	12	19.34	19.28	19.17
		1	24	19.29	19.24	19.16
		12	0	19.27	19.14	19.04
		12	6	19.37	19.32	19.24
		12	13	19.51	19.38	19.28
25		0	19.23	19.15	19.07	

FCC SAR Test Report

BW	MCS Index	Channel		19965	20175	20385
		Frequency (MHz)		1711.5 MHz	1732.5 MHz	1753.5 MHz
3M	QPSK	1	0	19.77	19.69	19.58
		1	7	19.60	19.50	19.46
		1	14	19.56	19.43	19.38
		8	0	19.67	19.57	19.53
		8	3	19.71	19.65	19.54
		8	7	19.65	19.60	19.52
		15	0	19.71	19.58	19.48
	16QAM	1	0	19.63	19.58	19.50
		1	7	19.58	19.46	19.40
		1	14	19.57	19.39	19.39
		8	0	19.65	19.57	19.49
		8	3	19.55	19.40	19.37
		8	7	19.51	19.34	19.29
		15	0	19.59	19.45	19.44
	64QAM	1	0	19.46	19.33	19.20
		1	7	19.37	19.22	19.17
		1	14	19.36	19.19	19.16
		8	0	19.26	19.17	19.05
		8	3	19.43	19.25	19.25
		8	7	19.47	19.39	19.31
		15	0	19.27	19.09	19.09
BW	MCS Index	Channel		19957	20175	20393
1.4M	QPSK	Frequency (MHz)		1710.7 MHz	1732.5 MHz	1754.3 MHz
		1	0	19.75	19.67	19.59
		1	2	19.64	19.49	19.46
		1	5	19.60	19.43	19.38
		3	0	19.68	19.54	19.53
		3	1	19.78	19.65	19.52
		3	3	19.68	19.53	19.48
	16QAM	6	0	19.74	19.57	19.54
		1	0	19.66	19.52	19.47
		1	2	19.61	19.43	19.42
		1	5	19.54	19.39	19.39
		3	0	19.69	19.56	19.49
		3	1	19.50	19.45	19.34
		3	3	19.49	19.36	19.33
	64QAM	6	0	19.59	19.51	19.41
		1	0	19.40	19.30	19.26
		1	2	19.34	19.28	19.18
		1	5	19.35	19.17	19.16
		3	0	19.23	19.13	19.04
		3	1	19.39	19.31	19.20
		3	3	19.50	19.35	19.35
6	0	19.25	19.12	19.05		

FCC SAR Test Report

LTE Band 7						
BW	MCS Index	RB Size	RB Offset	Low	Mid	Mid
		Channel		20850	21100	21350
		Frequency (MHz)		2510 MHz	2535 MHz	2560 MHz
20M	QPSK	1	0	19.17	19.23	19.19
		1	50	19.09	19.15	19.11
		1	99	19.15	19.21	19.17
		50	0	19.15	19.21	19.17
		50	25	19.11	19.17	19.13
		50	50	19.05	19.11	19.07
		100	0	19.09	19.15	19.11
	16QAM	1	0	18.97	19.03	18.99
		1	50	19.02	19.08	19.04
		1	99	18.89	18.95	18.91
		50	0	18.97	19.03	18.99
		50	25	19.02	19.08	19.04
		50	50	19.05	19.11	19.07
		100	0	18.91	18.97	18.93
	64QAM	1	0	18.73	18.79	18.75
		1	50	18.78	18.84	18.80
		1	99	18.81	18.87	18.83
		50	0	18.85	18.91	18.87
		50	25	18.72	18.78	18.74
		50	50	18.80	18.86	18.82
		100	0	18.88	18.94	18.90
BW	MCS Index	Channel		20825	21100	21375
15M	QPSK	Frequency (MHz)		2507.5 MHz	2535 MHz	2562.5 MHz
		1	0	19.16	19.19	19.11
		1	37	19.05	19.12	19.05
		1	74	19.13	19.20	19.13
		36	0	19.09	19.16	19.16
		36	19	19.10	19.15	19.08
		36	39	18.97	19.04	19.05
	75	0	19.08	19.11	19.08	
	16QAM	1	0	18.94	19.02	18.93
		1	37	18.98	19.03	19.02
		1	74	18.83	18.93	18.88
		36	0	18.95	18.95	18.98
		36	19	18.94	19.04	18.99
		36	39	19.02	19.05	19.05
		75	0	18.90	18.92	18.85
	64QAM	1	0	18.67	18.76	18.71
		1	37	18.76	18.77	18.75
		1	74	18.75	18.79	18.81
		36	0	18.84	18.89	18.79
		36	19	18.65	18.70	18.68
		36	39	18.78	18.85	18.78
75		0	18.86	18.86	18.89	

FCC SAR Test Report

BW	MCS Index	Channel		20800	21100	21400
		Frequency (MHz)		2505 MHz	2535 MHz	2565 MHz
10M	QPSK	1	0	19.09	19.19	19.14
		1	24	19.07	19.07	19.10
		1	49	19.07	19.17	19.12
		25	0	19.12	19.15	19.15
		25	12	19.09	19.10	19.08
		25	25	18.99	19.03	19.05
		50	0	19.08	19.13	19.03
	16QAM	1	0	18.90	18.95	18.93
		1	24	18.99	19.02	19.02
		1	49	18.87	18.88	18.86
		25	0	18.91	18.95	18.97
		25	12	19.00	19.00	19.03
		25	25	18.97	19.07	19.02
		50	0	18.89	18.89	18.92
	64QAM	1	0	18.65	18.75	18.70
		1	24	18.75	18.78	18.78
		1	49	18.79	18.80	18.78
		25	0	18.79	18.83	18.85
		25	12	18.71	18.76	18.66
		25	25	18.75	18.78	18.76
		50	0	18.87	18.88	18.88
BW	MCS Index	Channel		20775	21100	21425
5M	QPSK	Frequency (MHz)		2502.5 MHz	2535 MHz	2567.5 MHz
		1	0	19.12	19.16	19.14
		1	12	19.07	19.07	19.09
		1	24	19.10	19.13	19.16
		12	0	19.11	19.16	19.12
		12	6	19.03	19.16	19.08
		12	13	19.01	19.06	19.06
	16QAM	25	0	19.03	19.13	19.06
		1	0	18.90	18.98	18.97
		1	12	18.94	19.06	18.99
		1	24	18.87	18.87	18.89
		12	0	18.89	18.97	18.91
		12	6	18.96	19.06	18.98
		12	13	18.98	19.06	19.05
	64QAM	25	0	18.85	18.90	18.88
		1	0	18.66	18.74	18.73
		1	12	18.70	18.82	18.74
		1	24	18.73	18.86	18.81
		12	0	18.81	18.86	18.79
		12	6	18.64	18.77	18.72
		12	13	18.76	18.81	18.74
25	0	18.82	18.92	18.87		

FCC SAR Test Report

LTE Band 38						
BW	MCS Index	RB Size	RB Offset	Low	Mid	Mid
		Channel		37850	38000	38150
		Frequency (MHz)		2580 MHz	2595 MHz	2610 MHz
20M	QPSK	1	0	21.14	21.09	21.20
		1	50	21.12	21.07	21.18
		1	99	21.09	21.04	21.15
		50	0	21.03	20.98	21.09
		50	25	21.11	21.06	21.17
		50	50	21.07	21.02	21.13
		100	0	20.92	20.87	20.98
	16QAM	1	0	21.07	21.02	21.13
		1	50	21.01	20.96	21.07
		1	99	20.95	20.90	21.01
		50	0	20.90	20.85	20.96
		50	25	20.88	20.83	20.94
		50	50	20.85	20.80	20.91
		100	0	20.79	20.74	20.85
	64QAM	1	0	20.68	20.63	20.74
		1	50	20.65	20.60	20.71
		1	99	20.61	20.56	20.67
		50	0	20.57	20.52	20.63
		50	25	20.50	20.45	20.56
		50	50	20.65	20.60	20.71
		100	0	20.57	20.52	20.63
BW	MCS Index	Channel		37825	38000	38175
		Frequency (MHz)		2577.5 MHz	2595 MHz	2612.5MHz
15M	QPSK	1	0	21.13	21.05	21.12
		1	37	21.08	21.04	21.12
		1	74	21.07	21.03	21.11
		36	0	20.97	20.93	21.08
		36	19	21.10	21.04	21.12
		36	39	20.99	20.95	21.11
		75	0	20.91	20.83	20.95
	16QAM	1	0	21.04	21.01	21.07
		1	37	20.97	20.91	21.05
		1	74	20.89	20.88	20.98
		36	0	20.88	20.77	20.95
		36	19	20.80	20.79	20.89
		36	39	20.82	20.74	20.89
		75	0	20.78	20.69	20.77
	64QAM	1	0	20.62	20.60	20.70
		1	37	20.63	20.53	20.66
		1	74	20.55	20.48	20.65
		36	0	20.56	20.50	20.55
		36	19	20.43	20.37	20.50
		36	39	20.63	20.59	20.67
		75	0	20.55	20.44	20.62

FCC SAR Test Report

BW	MCS Index	Channel		37800	38000	38200
		Frequency (MHz)		2575 MHz	2595 MHz	2615 MHz
10M	QPSK	1	0	21.06	21.05	21.15
		1	24	21.10	20.99	21.17
		1	49	21.01	21.00	21.10
		25	0	21.00	20.92	21.07
		25	12	21.09	20.99	21.12
		25	25	21.01	20.94	21.11
		50	0	20.91	20.85	20.90
	16QAM	1	0	21.00	20.94	21.07
		1	24	20.98	20.90	21.05
		1	49	20.93	20.83	20.96
		25	0	20.84	20.77	20.94
		25	12	20.86	20.75	20.93
		25	25	20.77	20.76	20.86
		50	0	20.77	20.66	20.84
	64QAM	1	0	20.60	20.59	20.69
		1	24	20.62	20.54	20.69
		1	49	20.59	20.49	20.62
		25	0	20.51	20.44	20.61
		25	12	20.49	20.43	20.48
		25	25	20.60	20.52	20.65
		50	0	20.56	20.46	20.61
BW	MCS Index	Channel		37775	38000	38225
5M	QPSK	Frequency (MHz)		2572.5 MHz	2595 MHz	2617.5MHz
		1	0	21.09	21.02	21.15
		1	12	21.10	20.99	21.16
		1	24	21.04	20.96	21.14
		12	0	20.99	20.93	21.04
		12	6	21.03	21.05	21.12
		12	13	21.03	20.97	21.12
	16QAM	25	0	20.86	20.85	20.93
		1	0	21.00	20.97	21.11
		1	12	20.93	20.94	21.02
		1	24	20.93	20.82	20.99
		12	0	20.82	20.79	20.88
		12	6	20.82	20.81	20.88
		12	13	20.78	20.75	20.89
	64QAM	25	0	20.73	20.67	20.80
		1	0	20.61	20.58	20.72
		1	12	20.57	20.58	20.65
		1	24	20.53	20.55	20.65
		12	0	20.53	20.47	20.55
		12	6	20.42	20.44	20.54
		12	13	20.61	20.55	20.63
25	0	20.51	20.50	20.60		

FCC SAR Test Report

LTE Band 41							
BW	MCS Index	RB Size	RB Offset	Low	Mid	Mid	3GPP MPR (dB)
		Channel		40140	40640	41140	
		Frequency (MHz)		2545	2595	2645	
20M	QPSK	1	0	21.01	21.07	21.28	0
		1	50	20.96	21.02	21.23	0
		1	99	20.82	20.88	21.09	0
		50	0	20.98	21.04	21.25	1
		50	25	20.91	20.97	21.18	1
		50	50	20.84	20.90	21.11	1
	16QAM	100	0	20.96	21.02	21.23	1
		1	0	20.78	20.84	21.05	1
		1	50	20.87	20.93	21.14	1
		1	99	20.78	20.84	21.05	1
		50	0	20.87	20.93	21.14	2
		50	25	20.90	20.96	21.17	2
	64QAM	50	50	20.74	20.80	21.01	2
		100	0	20.76	20.82	21.03	2
		1	0	20.71	20.77	20.98	2
		1	50	20.64	20.70	20.91	2
		1	99	20.60	20.66	20.87	2
		50	0	20.58	20.64	20.85	3
BW	MCS Index	Channel		40115	40640	41165	3GPP MPR
		Frequency (MHz)		2542.5	2595	2647.5	
15M	QPSK	1	0	21.00	21.03	21.20	0
		1	37	20.92	20.99	21.17	0
		1	74	20.80	20.87	21.05	0
		36	0	20.92	20.99	21.24	1
		36	19	20.90	20.95	21.13	1
		36	39	20.76	20.83	21.09	1
		75	0	20.95	20.98	21.20	1
	16QAM	1	0	20.75	20.83	20.99	1
		1	37	20.83	20.88	21.12	1
		1	74	20.72	20.82	21.02	1
		36	0	20.85	20.85	21.13	2
		36	19	20.82	20.92	21.12	2
		36	39	20.71	20.74	20.99	2
		75	0	20.75	20.77	20.95	2
	64QAM	1	0	20.65	20.74	20.94	2
		1	37	20.62	20.63	20.86	2
		1	74	20.54	20.58	20.85	2
		36	0	20.57	20.62	20.77	3
		36	19	20.60	20.65	20.88	3
		36	39	20.50	20.57	20.75	3
		75	0	20.46	20.46	20.74	3

FCC SAR Test Report

BW	MCS Index	Channel		40090	40640	41190	3GPP MPR
		Frequency (MHz)		2540	2595	2650	
10M	QPSK	1	0	20.93	21.03	21.23	0
		1	24	20.94	20.94	21.22	0
		1	49	20.74	20.84	21.04	0
		25	0	20.95	20.98	21.23	1
		25	12	20.89	20.90	21.13	1
		25	25	20.78	20.82	21.09	1
		50	0	20.95	21.00	21.15	1
	16QAM	1	0	20.71	20.76	20.99	1
		1	24	20.84	20.87	21.12	1
		1	49	20.76	20.77	21.00	1
		25	0	20.81	20.85	21.12	2
		25	12	20.88	20.88	21.16	2
		25	25	20.66	20.76	20.96	2
		50	0	20.74	20.74	21.02	2
	64QAM	1	0	20.63	20.73	20.93	2
		1	24	20.61	20.64	20.89	2
		1	49	20.58	20.59	20.82	2
		25	0	20.52	20.56	20.83	3
		25	12	20.66	20.71	20.86	3
		25	25	20.47	20.50	20.73	3
		50	0	20.47	20.48	20.73	3
BW	MCS Index	Channel		40065	40640	41215	3GPP MPR
		Frequency (MHz)		2537.5	2595	2652.5	
5M	QPSK	1	0	20.96	21.00	21.23	0
		1	12	20.94	20.94	21.21	0
		1	24	20.77	20.80	21.08	0
		12	0	20.94	20.99	21.20	1
		12	6	20.83	20.96	21.13	1
		12	13	20.80	20.85	21.10	1
		25	0	20.90	21.00	21.18	1
	16QAM	1	0	20.71	20.79	21.03	1
		1	12	20.79	20.91	21.09	1
		1	24	20.76	20.76	21.03	1
		12	0	20.79	20.87	21.06	2
		12	6	20.84	20.94	21.11	2
		12	13	20.67	20.75	20.99	2
		25	0	20.70	20.75	20.98	2
	64QAM	1	0	20.64	20.72	20.96	2
		1	12	20.56	20.68	20.85	2
		1	24	20.52	20.65	20.85	2
		12	0	20.54	20.59	20.77	3
		12	6	20.59	20.72	20.92	3
		12	13	20.48	20.53	20.71	3
		25	0	20.42	20.52	20.72	3

4.7 SAR Testing Results

4.7.1 SAR Test Reduction Considerations

<KDB 447498 D01, General RF Exposure Guidance>

Testing of other required channels within the operating mode of a frequency band is not required when the reported SAR for the mid-band or highest output power channel is:

- (1) ≤ 0.8 W/kg or 2.0 W/kg, for 1-g or 10-g respectively, when the transmission band is ≤ 100 MHz
- (2) ≤ 0.6 W/kg or 1.5 W/kg, for 1-g or 10-g respectively, when the transmission band is between 100 MHz and 200 MHz
- (3) ≤ 0.4 W/kg or 1.0 W/kg, for 1-g or 10-g respectively, when the transmission band is ≥ 200 MHz

When SAR is not measured at the maximum power level allowed for production units, the measured SAR will be scaled to the maximum tune-up tolerance limit to determine compliance. The scaling factor for the tune-up power is defined as maximum tune-up limit (mW) / measured conducted power (mW). The reported SAR would be calculated by measured SAR x tune-up power scaling factor.

The SAR has been measured with highest transmission duty factor supported by the test mode tools for WLAN and/or Bluetooth. When the transmission duty factor could not achieve 100%, the reported SAR will be scaled to 100% transmission duty factor to determine compliance at the maximum tune-up power. The scaling factor for the duty factor is defined as 100% / transmission duty cycle (%). The reported SAR would be calculated by measured SAR x tune-up power scaling factor x duty cycle scaling factor.

<KDB 941225 D01, 3G SAR Measurement Procedures>

The mode tested for SAR is referred to as the primary mode. The equivalent modes considered for SAR test reduction are denoted as secondary modes. Both primary and secondary modes must be in the same frequency band. When the maximum output power and tune-up tolerance specified for production units in a secondary mode is $\leq 1/4$ dB higher than the primary mode or when the highest reported SAR of the primary mode is scaled by the ratio of specified maximum output power and tune-up tolerance of secondary to primary mode and the adjusted SAR is ≤ 1.2 W/kg, SAR measurement is not required for the secondary mode.

<KDB 941225 D05, SAR Evaluation Considerations for LTE Devices>

- (1) QPSK with 1 RB and 50% RB allocation

Start with the largest channel bandwidth and measure SAR, using the RB offset and required test channel combination with the highest maximum output power among RB offsets at the upper edge, middle and lower edge of each required test channel. When the reported SAR is ≤ 0.8 W/kg, testing of the remaining RB offset configurations and required test channels is not required; otherwise, SAR is required for the remaining required test channels and only for the RB offset configuration with the highest output power for that channel. When the reported SAR of a required test channel is > 1.45 W/kg, SAR is required for all three RB offset configurations for that required test channel.

- (2) QPSK with 100% RB allocation

SAR is not required when the highest maximum output power for 100% RB allocation is less than the highest maximum output power in 50% and 1 RB allocations and the highest reported SAR for 1 RB and 50% RB allocation are ≤ 0.8 W/kg. Otherwise, SAR is measured for the highest output power channel; and if the reported SAR is > 1.45 W/kg, the remaining required test channels must also be tested.

FCC SAR Test Report

(3) Higher order modulations

SAR is required only when the highest maximum output power for the configuration in the higher order modulation is > 1/2 dB higher than the same configuration in QPSK or when the reported SAR for the QPSK configuration is > 1.45 W/kg.

(4) Other channel bandwidth

SAR is required when the highest maximum output power of the smaller channel bandwidth is > 1/2 dB higher than the equivalent channel configurations in the largest channel bandwidth configuration or the reported SAR of a configuration for the largest channel bandwidth is > 1.45 W/kg.

<Power Confirmation for SAR Test Exclusion for LTE Downlink CA>

According to KDB 941225 D05A, the uplink maximum output power below was measured with downlink CA active on the channel with highest measured maximum output power when downlink CA is inactive. The downlink SCC channel was paired with the uplink channel as normal operation. For intra-band contiguous CA, the downlink channel spacing between the component carriers was set to multiple of 300 kHz less than the nominal channel spacing per section 5.4.1A of 3GPP TS36.521. For intra-band non-contiguous CA, the downlink channel spacing between the component carriers was set to maximum separation from PCC and remain fully within the downlink transmission band. For Inter-band CA, the SCC downlink channel was set to near the middle of its transmission band.

Power Measurements for Intra-Band Contiguous Downlink CA

Combination	PCC						SCC			Measurement Full Power	
	BW (MHz)	Modulation	RB Size	RB Offset	UL Channel	UL Frequency (MHz)	BW (MHz)	DL Channel	DL Frequency (MHz)	Single Carrier Tx Power (dBm)	Tx Power with DL-CA Active (dBm)
CA_7C	20	QPSK	1	99	20850	2510	20	21048	2529.8	22.95	23.13
	20	QPSK	1	99	21001	2525.1	20	21199	2544.9	23.04	23.15
	20	QPSK	1	99	21152	2540.2	20	21350	2560	23.06	23.20
CA_38C	20	QPSK	1	99	37850	2580	20	38048	2599.8	23.07	23.17
	20	QPSK	1	99	37901	2585.1	20	38099	2604.9	23.09	23.15
	20	QPSK	1	99	37952	2590.2	20	38150	2610	23.14	23.16

Combination	PCC						SCC			Measurement Reduce Power	
	BW (MHz)	Modulation	RB Size	RB Offset	UL Channel	UL Frequency (MHz)	BW (MHz)	DL Channel	DL Frequency (MHz)	Single Carrier Tx Power (dBm)	Tx Power with DL-CA Active (dBm)
CA_7C	20	QPSK	1	99	20850	2510	20	21048	2529.8	19.15	19.00
	20	QPSK	1	99	21001	2525.1	20	21199	2544.9	19.21	19.11
	20	QPSK	1	99	21152	2540.2	20	21350	2560	19.17	19.04
CA_38C	20	QPSK	1	99	37850	2580	20	38048	2599.8	21.09	20.94
	20	QPSK	1	99	37901	2585.1	20	38099	2604.9	21.04	21.01
	20	QPSK	1	99	37952	2590.2	20	38150	2610	21.15	21.02

Summary for SAR Test Exclusion for LTE Downlink CA

Per power confirmation results in above, the uplink maximum output power with downlink CA active remains within the specified tune-up tolerance and not more than 0.25 dB higher than the maximum output power with downlink CA inactive. According to KDB 941225 D05A, the SAR test exclusion applies to LTE downlink CA operation.

FCC SAR Test Report

<Power Confirmation for SAR Testing for LTE Uplink CA>

The conducted power for uplink CA active was measured on the highest reported SAR configuration for each exposure condition with both two carrier components was set to largest channel bandwidth.

Combination	PCC						SCC						Measurement Full Power	
	BW (MHz)	Modulation	RB Size	RB Offset	UL Channel	UL Frequency (MHz)	BW (MHz)	Modulation	RB Size	RB Offset	UL Channel	UL Frequency (MHz)	Single Carrier Tx Power (dBm)	Tx Power with UL-CA Active (dBm)
CA_7C	20	QPSK	1	99	20850	2510	20	QPSK	1	0	21048	2529.8	22.95	23.35
	20	QPSK	1	99	21001	2525.1	20	QPSK	1	0	21199	2544.9	23.04	23.33
	20	QPSK	1	99	21152	2540.2	20	QPSK	1	0	21350	2560	23.06	23.24
CA_38C	20	QPSK	1	99	37850	2580	20	QPSK	1	0	38048	2599.8	23.07	23.24
	20	QPSK	1	99	37901	2585.1	20	QPSK	1	0	38099	2604.9	23.09	23.18
	20	QPSK	1	99	37952	2590.2	20	QPSK	1	0	38150	2610	23.14	23.23

Combination	PCC						SCC						Measurement Reduce Power	
	BW (MHz)	Modulation	RB Size	RB Offset	UL Channel	UL Frequency (MHz)	BW (MHz)	Modulation	RB Size	RB Offset	UL Channel	UL Frequency (MHz)	Single Carrier Tx Power (dBm)	Tx Power with UL-CA Active (dBm)
CA_7C	20	QPSK	1	99	20850	2510	20	QPSK	1	0	21048	2529.8	19.15	19.01
	20	QPSK	1	99	21001	2525.1	20	QPSK	1	0	21199	2544.9	19.21	19.15
	20	QPSK	1	99	21152	2540.2	20	QPSK	1	0	21350	2560	19.17	19.08
CA_38C	20	QPSK	1	99	37850	2580	20	QPSK	1	0	38048	2599.8	21.09	20.98
	20	QPSK	1	99	37901	2585.1	20	QPSK	1	0	38099	2604.9	21.04	21.00
	20	QPSK	1	99	37952	2590.2	20	QPSK	1	0	38150	2610	21.15	21.05

SAR Measurements for Intra-Band Contiguous CA

The SAR testing was performed with the single carrier (uplink CA is inactive) for all test positions for each exposure condition. The LTE uplink CA active was verified with maximum output power on the highest SAR configuration of single carrier for each exposure condition. For intra-band contiguous CA, the SCC channel was set to closest available contiguous channel.

<KDB 248227 D01, SAR Guidance for Wi-Fi Transmitters>

- (1) For handsets operating next to ear, hotspot mode or mini-tablet configurations, the initial test position procedures were applied. The test position with the highest extrapolated peak SAR will be used as the initial test position. When the reported SAR of initial test position is ≤ 0.4 W/kg, SAR testing for remaining test positions is not required. Otherwise, SAR is evaluated at the subsequent highest peak SAR positions until the reported SAR result is ≤ 0.8 W/kg or all test positions are measured.
- (2) For WLAN 2.4 GHz, the highest measured maximum output power channel for DSSS was selected for SAR measurement. When the reported SAR is ≤ 0.8 W/kg, no further SAR testing is required. Otherwise, SAR is evaluated at the next highest measured output power channel. When any reported SAR is > 1.2 W/kg, SAR is required for the third channel. For OFDM modes (802.11g/n), SAR is not required when the highest reported SAR for DSSS is adjusted by the ratio of OFDM to DSSS specified maximum output power and it is ≤ 1.2 W/kg.
- (3) For WLAN 5 GHz, the initial test configuration was selected according to the transmission mode with the highest maximum output power. When the reported SAR of initial test configuration is > 0.8 W/kg, SAR is required for the subsequent highest measured output power channel until the reported SAR result is ≤ 1.2 W/kg or all required channels are measured. For other transmission modes, SAR is not required when the highest reported SAR for initial test configuration is adjusted by the ratio of subsequent test configuration to initial test configuration specified maximum output power and it is ≤ 1.2 W/kg.
- (4) For WLAN MIMO mode, the power-based standalone SAR test exclusion or the sum of SAR provision in KDB 447498 to determine simultaneous transmission SAR test exclusion should be applied. Otherwise, SAR for MIMO mode will be measured with all applicable antennas transmitting simultaneously at the specified maximum output power of MIMO operation.

FCC SAR Test Report

4.7.2 SAR Results for Head Exposure Condition

Plot No.	Band	Mode	Test Position	Ch.	TX Ant.	Max. Tune-up Power (dBm)	Measured Conducted Power (dBm)	Power Drift (dB)	Measured SAR-1g (W/kg)	Scaling Factor	Scaled SAR-1g (W/kg)
	GSM850	GPRS10	Right Cheek	251	0	30.5	29.59	0.00	0.112	1.23	0.14
	GSM850	GPRS10	Right Tilted	251	0	30.5	29.59	0.10	0.039	1.23	0.05
	GSM850	GPRS10	Left Cheek	251	0	30.5	29.59	0.00	0.090	1.23	0.11
	GSM850	GPRS10	Left Tilted	251	0	30.5	29.59	-0.03	0.049	1.23	0.06
1	GSM850	GPRS10	Right Cheek	251	1	30.5	29.59	-0.01	0.612	1.23	0.75
	GSM850	GPRS10	Right Tilted	251	1	30.5	29.59	0.06	0.474	1.23	0.58
	GSM850	GPRS10	Left Cheek	251	1	30.5	29.59	-0.10	0.416	1.23	0.51
	GSM850	GPRS10	Left Tilted	251	1	30.5	29.59	-0.06	0.333	1.23	0.41
	GSM1900	GPRS12	Right Cheek	810	0	24.5	24.01	0.03	0.020	1.12	0.02
	GSM1900	GPRS12	Right Tilted	810	0	24.5	24.01	0.07	0.012	1.12	0.01
2	GSM1900	GPRS12	Left Cheek	810	0	24.5	24.01	0.05	0.023	1.12	0.03
	GSM1900	GPRS12	Left Tilted	810	0	24.5	24.01	0.07	0.012	1.12	0.01
	WCDMA II	RMC12.2K	Right Cheek	9538	0	24.0	23.52	0.01	0.061	1.12	0.07
	WCDMA II	RMC12.2K	Right Tilted	9538	0	24.0	23.52	0.05	0.036	1.12	0.04
3	WCDMA II	RMC12.2K	Left Cheek	9538	0	24.0	23.52	0.08	0.074	1.12	0.08
	WCDMA II	RMC12.2K	Left Tilted	9538	0	24.0	23.52	0.17	0.040	1.12	0.05
	WCDMA IV	RMC12.2K	Right Cheek	1413	0	24.0	23.65	0.08	0.059	1.08	0.06
4	WCDMA IV	RMC12.2K	Right Tilted	1413	0	24.0	23.65	0.08	0.086	1.08	0.09
	WCDMA IV	RMC12.2K	Left Cheek	1413	0	24.0	23.65	0.00	0.064	1.08	0.07
	WCDMA IV	RMC12.2K	Left Tilted	1413	0	24.0	23.65	0.02	0.063	1.08	0.07
	WCDMA V	RMC12.2K	Right Cheek	4182	0	24.0	23.80	0.06	0.126	1.05	0.13
	WCDMA V	RMC12.2K	Right Tilted	4182	0	24.0	23.80	0.02	0.058	1.05	0.06
	WCDMA V	RMC12.2K	Left Cheek	4182	0	24.0	23.80	0.18	0.101	1.05	0.11
	WCDMA V	RMC12.2K	Left Tilted	4182	0	24.0	23.80	0.07	0.055	1.05	0.06
5	WCDMA V	RMC12.2K	Right Cheek	4182	1	24.0	23.80	-0.09	0.818	1.05	0.86
	WCDMA V	RMC12.2K	Right Tilted	4182	1	24.0	23.80	0.04	0.586	1.05	0.61
	WCDMA V	RMC12.2K	Left Cheek	4182	1	24.0	23.80	0.03	0.591	1.05	0.62
	WCDMA V	RMC12.2K	Left Tilted	4182	1	24.0	23.80	0.03	0.466	1.05	0.49
	WCDMA V	RMC12.2K	Right Cheek	4132	1	24.0	23.79	0.04	0.780	1.05	0.82
	WCDMA V	RMC12.2K	Right Cheek	4233	1	24.0	23.79	0.07	0.777	1.05	0.82
	WCDMA V	RMC12.2K	Right Cheek	4182	1	24.0	23.80	0.01	0.811	1.05	0.85

Plot No.	Band	Mode	Test Position	Ch.	RB#	RB Offset	TX Ant.	Max. Tune-up Power (dBm)	Measured Conducted Power (dBm)	Power Drift (dB)	Measured SAR-1g (W/kg)	Scaling Factor	Scaled SAR-1g (W/kg)
	LTE 2	QPSK20M	Right Cheek	18900	1	0	0	24.0	23.37	0.07	0.052	1.16	0.06
	LTE 2	QPSK20M	Right Tilted	18900	1	0	0	24.0	23.37	0.07	0.036	1.16	0.05
6	LTE 2	QPSK20M	Left Cheek	18900	1	0	0	24.0	23.37	0.03	0.061	1.16	0.07
	LTE 2	QPSK20M	Left Tilted	18900	1	0	0	24.0	23.37	0.14	0.043	1.16	0.05
	LTE 2	QPSK20M	Right Cheek	18900	50	0	0	23.0	22.51	0.00	0.041	1.12	0.05
	LTE 2	QPSK20M	Right Tilted	18900	50	0	0	23.0	22.51	0.09	0.027	1.12	0.03
	LTE 2	QPSK20M	Left Cheek	18900	50	0	0	23.0	22.51	0.00	0.048	1.12	0.05
	LTE 2	QPSK20M	Left Tilted	18900	50	0	0	23.0	22.51	0.01	0.031	1.12	0.03
	LTE 4	QPSK20M	Right Cheek	20050	1	50	0	24.0	23.38	0.03	0.045	1.15	0.05
7	LTE 4	QPSK20M	Right Tilted	20050	1	50	0	24.0	23.38	0.00	0.058	1.15	0.07
	LTE 4	QPSK20M	Left Cheek	20050	1	50	0	24.0	23.38	0.06	0.055	1.15	0.06
	LTE 4	QPSK20M	Left Tilted	20050	1	50	0	24.0	23.38	0.01	0.047	1.15	0.05
	LTE 4	QPSK20M	Right Cheek	20050	50	0	0	23.0	22.54	0.09	0.036	1.11	0.04
	LTE 4	QPSK20M	Right Tilted	20050	50	0	0	23.0	22.54	0.03	0.044	1.11	0.05
	LTE 4	QPSK20M	Left Cheek	20050	50	0	0	23.0	22.54	0.07	0.044	1.11	0.05
	LTE 4	QPSK20M	Left Tilted	20050	50	0	0	23.0	22.54	0.01	0.037	1.11	0.04

FCC SAR Test Report

Plot No.	Band	Mode	Test Position	Ch.	RB#	RB Offset	TX Ant.	Max. Tune-up Power (dBm)	Measured Conducted Power (dBm)	Power Drift (dB)	Measured SAR-1g (W/kg)	Scaling Factor	Scaled SAR-1g (W/kg)
	LTE 5	QPSK10M	Right Cheek	20525	1	0	0	24.5	23.98	0.07	0.103	1.13	0.12
	LTE 5	QPSK10M	Right Tilted	20525	1	0	0	24.5	23.98	0.08	0.053	1.13	0.06
	LTE 5	QPSK10M	Left Cheek	20525	1	0	0	24.5	23.98	0.00	0.092	1.13	0.10
	LTE 5	QPSK10M	Left Tilted	20525	1	0	0	24.5	23.98	0.03	0.051	1.13	0.06
8	LTE 5	QPSK10M	Right Cheek	20525	1	0	1	24.5	23.98	0.05	0.769	1.13	0.87
	LTE 5	QPSK10M	Right Tilted	20525	1	0	1	24.5	23.98	0.02	0.527	1.13	0.59
	LTE 5	QPSK10M	Left Cheek	20525	1	0	1	24.5	23.98	0.00	0.530	1.13	0.60
	LTE 5	QPSK10M	Left Tilted	20525	1	0	1	24.5	23.98	0.02	0.419	1.13	0.47
	LTE 5	QPSK10M	Right Cheek	20450	1	0	1	24.5	23.94	0.01	0.743	1.14	0.85
	LTE 5	QPSK10M	Right Cheek	20600	1	0	1	24.5	23.91	0.02	0.755	1.15	0.86
	LTE 5	QPSK10M	Right Cheek	20525	25	12	0	23.5	23.04	0.02	0.085	1.11	0.09
	LTE 5	QPSK10M	Right Tilted	20525	25	12	0	23.5	23.04	0.02	0.045	1.11	0.05
	LTE 5	QPSK10M	Left Cheek	20525	25	12	0	23.5	23.04	0.00	0.076	1.11	0.08
	LTE 5	QPSK10M	Left Tilted	20525	25	12	0	23.5	23.04	0.06	0.043	1.11	0.05
	LTE 5	QPSK10M	Right Cheek	20525	25	12	1	23.5	23.04	0.04	0.622	1.11	0.69
	LTE 5	QPSK10M	Right Tilted	20525	25	12	1	23.5	23.04	0.05	0.427	1.11	0.47
	LTE 5	QPSK10M	Left Cheek	20525	25	12	1	23.5	23.04	0.04	0.425	1.11	0.47
	LTE 5	QPSK10M	Left Tilted	20525	25	12	1	23.5	23.04	-0.03	0.338	1.11	0.38
	LTE 5	QPSK10M	Right Tilted	20600	50	0	1	23.5	23.01	-0.01	0.600	1.12	0.67
9	LTE 7	QPSK20M	Right Cheek	21350	1	0	0	24.0	23.19	0.02	0.096	1.21	0.12
	LTE 7	QPSK20M	Right Tilted	21350	1	0	0	24.0	23.19	0.00	0.091	1.21	0.11
	LTE 7	QPSK20M	Left Cheek	21350	1	0	0	24.0	23.19	-0.01	0.067	1.21	0.08
	LTE 7	QPSK20M	Left Tilted	21350	1	0	0	24.0	23.19	0.01	0.042	1.21	0.05
	LTE 7	QPSK20M	Right Cheek	21350	50	50	0	23.0	22.27	0.07	0.039	1.18	0.05
	LTE 7	QPSK20M	Right Tilted	21350	50	50	0	23.0	22.27	0.00	0.074	1.18	0.09
	LTE 7	QPSK20M	Left Cheek	21350	50	50	0	23.0	22.27	0.08	0.052	1.18	0.06
	LTE 7	QPSK20M	Left Tilted	21350	50	50	0	23.0	22.27	0.03	0.030	1.18	0.04
	LTE 7	QPSK20M	Right Cheek	PCC:20850 SCC:21048	PCC:1 SCC:1	PCC:99 SCC:0	0	24.0	23.35	0.02	0.091	1.16	0.11
	LTE 38	QPSK20M	Right Cheek	38150	1	99	0	24.0	23.14	0.00	0.054	1.22	0.07
10	LTE 38	QPSK20M	Right Tilted	38150	1	99	0	24.0	23.14	0.02	0.055	1.22	0.07
	LTE 38	QPSK20M	Left Cheek	38150	1	99	0	24.0	23.14	0.06	0.042	1.22	0.05
	LTE 38	QPSK20M	Left Tilted	38150	1	99	0	24.0	23.14	0.03	0.023	1.22	0.03
	LTE 38	QPSK20M	Right Cheek	38150	50	0	0	23.0	22.27	0.03	0.046	1.18	0.05
	LTE 38	QPSK20M	Right Tilted	38150	50	0	0	23.0	22.27	0.05	0.043	1.18	0.05
	LTE 38	QPSK20M	Left Cheek	38150	50	0	0	23.0	22.27	0.06	0.033	1.18	0.04
	LTE 38	QPSK20M	Left Tilted	38150	50	0	0	23.0	22.27	0.03	0.019	1.18	0.02
	LTE 38	QPSK20M	Right Tilted	PCC:37850 SCC:38048	PCC:1 SCC:1	PCC:99 SCC:0	0	24.0	23.24	0.01	0.051	1.19	0.06
11	LTE 41	QPSK20M	Right Cheek	41140	1	0	0	24.0	23.38	0.01	0.064	1.15	0.07
	LTE 41	QPSK20M	Right Tilted	41140	1	0	0	24.0	23.38	-0.02	0.061	1.15	0.07
	LTE 41	QPSK20M	Left Cheek	41140	1	0	0	24.0	23.38	0.09	0.045	1.15	0.05
	LTE 41	QPSK20M	Left Tilted	41140	1	0	0	24.0	23.38	0.14	0.028	1.15	0.03
	LTE 41	QPSK20M	Right Cheek	41140	50	0	0	23.0	22.47	0.04	0.051	1.13	0.06
	LTE 41	QPSK20M	Right Tilted	41140	50	0	0	23.0	22.47	0.01	0.048	1.13	0.05
	LTE 41	QPSK20M	Left Cheek	41140	50	0	0	23.0	22.47	0.08	0.036	1.13	0.04
	LTE 41	QPSK20M	Left Tilted	41140	50	0	0	23.0	22.47	0.11	0.021	1.13	0.02

FCC SAR Test Report

Plot No.	Band	Mode	Test Position	Ch.	TX Ant.	Max. Tune-up Power (dBm)	Measured Conducted Power (dBm)	Power Drift (dB)	Measured SAR-1g (W/kg)	Scaling Factor	Scaled SAR-1g (W/kg)
	WLAN2.4G	802.11b	Right Cheek	6	0	17.0	16.30	-0.05	0.199	1.17	0.23
	WLAN2.4G	802.11b	Right Tilted	6	0	17.0	16.30	0.05	0.293	1.17	0.34
	WLAN2.4G	802.11b	Left Cheek	6	0	17.0	16.30	0.02	0.546	1.17	0.64
	WLAN2.4G	802.11b	Left Tilted	6	0	17.0	16.30	0	0.436	1.17	0.51
	WLAN2.4G	802.11b	Right Cheek	1	1	17.0	16.60	0.08	0.555	1.10	0.61
	WLAN2.4G	802.11b	Right Tilted	1	1	17.0	16.60	0	0.331	1.10	0.36
	WLAN2.4G	802.11b	Left Cheek	1	1	17.0	16.60	0.01	0.137	1.10	0.15
	WLAN2.4G	802.11b	Left Tilted	1	1	17.0	16.60	0.02	0.096	1.10	0.11
	WLAN2.4G	802.11b	Right Cheek	6	0+1	19.0	18.86	0.02	0.589	1.03	0.61
	WLAN2.4G	802.11b	Right Tilted	6	0+1	19.0	18.86	-0.02	0.504	1.03	0.52
	WLAN2.4G	802.11b	Left Cheek	6	0+1	19.0	18.86	0.01	0.620	1.03	0.64
12	WLAN2.4G	802.11b	Left Tilted	6	0+1	19.0	18.86	0.13	0.712	1.03	0.74
	WLAN5.3G	802.11a	Right Cheek	52	0	16.0	15.31	0.05	0.271	1.17	0.32
	WLAN5.3G	802.11a	Right Tilted	52	0	16.0	15.31	0.02	0.265	1.17	0.31
	WLAN5.3G	802.11a	Left Cheek	52	0	16.0	15.31	0.05	0.419	1.17	0.49
13	WLAN5.3G	802.11a	Left Tilted	52	0	16.0	15.31	0.06	0.464	1.17	0.54
	WLAN5.3G	802.11a	Right Cheek	64	1	16.0	15.29	0.06	0.047	1.18	0.06
	WLAN5.3G	802.11a	Right Tilted	64	1	16.0	15.29	0.03	0.100	1.18	0.12
	WLAN5.3G	802.11a	Left Cheek	64	1	16.0	15.29	0.04	0.038	1.18	0.04
	WLAN5.3G	802.11a	Left Tilted	64	1	16.0	15.29	0.08	0.074	1.18	0.09
	WLAN5.3G	802.11a	Right Cheek	52	0+1	18.0	17.86	0.07	0.234	1.03	0.24
	WLAN5.3G	802.11a	Right Tilted	52	0+1	18.0	17.86	0.05	0.279	1.03	0.29
	WLAN5.3G	802.11a	Left Cheek	52	0+1	18.0	17.86	0.05	0.501	1.03	0.52
	WLAN5.3G	802.11a	Left Tilted	52	0+1	18.0	17.86	0.09	0.485	1.03	0.50
	WLAN5.6G	802.11a	Right Cheek	140	0	15.0	14.42	0.01	0.191	1.14	0.22
	WLAN5.6G	802.11a	Right Tilted	140	0	15.0	14.42	0.07	0.170	1.14	0.19
	WLAN5.6G	802.11a	Left Cheek	140	0	15.0	14.42	0.05	0.396	1.14	0.45
	WLAN5.6G	802.11a	Left Tilted	140	0	15.0	14.42	0.09	0.512	1.14	0.59
	WLAN5.6G	802.11a	Right Cheek	140	1	15.0	14.79	0.02	0.049	1.05	0.05
	WLAN5.6G	802.11a	Right Tilted	140	1	15.0	14.79	0.02	0.057	1.05	0.06
	WLAN5.6G	802.11a	Left Cheek	140	1	15.0	14.79	-0.13	0.057	1.05	0.06
	WLAN5.6G	802.11a	Left Tilted	140	1	15.0	14.79	0.05	0.071	1.05	0.07
	WLAN5.6G	802.11a	Right Cheek	140	0+1	18.0	17.28	0.07	0.187	1.18	0.22
	WLAN5.6G	802.11a	Right Tilted	140	0+1	18.0	17.28	-0.07	0.219	1.18	0.26
14	WLAN5.6G	802.11a	Left Cheek	140	0+1	18.0	17.28	0.07	0.490	1.18	0.58
	WLAN5.6G	802.11a	Left Tilted	140	0+1	18.0	17.28	0.07	0.381	1.18	0.45
	WLAN5.8G	802.11a	Right Cheek	149	0	16.0	15.44	0.18	0.190	1.14	0.22
	WLAN5.8G	802.11a	Right Tilted	149	0	16.0	15.44	0.06	0.202	1.14	0.23
	WLAN5.8G	802.11a	Left Cheek	149	0	16.0	15.44	0.03	0.403	1.14	0.46
15	WLAN5.8G	802.11a	Left Tilted	149	0	16.0	15.44	0	0.511	1.14	0.58
	WLAN5.8G	802.11a	Right Cheek	149	1	16.0	15.88	0.08	0.043	1.03	0.04
	WLAN5.8G	802.11a	Right Tilted	149	1	16.0	15.88	0.04	0.041	1.03	0.04
	WLAN5.8G	802.11a	Left Cheek	149	1	16.0	15.88	0.07	0.061	1.03	0.06
	WLAN5.8G	802.11a	Left Tilted	149	1	16.0	15.88	0.06	0.075	1.03	0.06
	WLAN5.8G	802.11a	Right Cheek	149	0+1	18.5	18.17	0.01	0.182	1.08	0.20
	WLAN5.8G	802.11a	Right Tilted	149	0+1	18.5	18.17	0.07	0.187	1.08	0.20
	WLAN5.8G	802.11a	Left Cheek	149	0+1	18.5	18.17	0.01	0.386	1.08	0.42
	WLAN5.8G	802.11a	Left Tilted	149	0+1	18.5	18.17	0.07	0.364	1.08	0.39
	Bluetooth	GFSK	Right Cheek	78	-	10.0	9.72	0.03	0.041	1.07	0.04
	Bluetooth	GFSK	Right Tilted	78	-	10.0	9.72	-0.06	0.044	1.07	0.05
	Bluetooth	GFSK	Left Cheek	78	-	10.0	9.72	0.02	0.063	1.07	0.07
16	Bluetooth	GFSK	Left Tilted	78	-	10.0	9.72	0.02	0.112	1.07	0.12

FCC SAR Test Report

4.7.3 SAR Results for Body-worn Exposure Condition (Separation Distance is 1.5 cm Gap)

Plot No.	Band	Mode	Test Position	Separation Distance (cm)	Ch.	TX Ant.	Power Reduction	Max. Tune-up Power (dBm)	Measured Conducted Power (dBm)	Power Drift (dB)	Measured SAR-1g (W/kg)	Scaling Factor	Scaled SAR-1g (W/kg)
	GSM850	GPRS10	Front Face	1.5	251	0	-	30.5	29.59	0.01	0.089	1.23	0.11
17	GSM850	GPRS10	Rear Face	1.5	251	0	-	30.5	29.59	0.04	0.095	1.23	0.12
	GSM850	GPRS10	Front Face	1.5	251	1	-	30.5	29.59	0.00	0.064	1.23	0.08
	GSM850	GPRS10	Rear Face	1.5	251	1	-	30.5	29.59	0.05	0.093	1.23	0.11
	GSM1900	GPRS12	Front Face	1.5	810	0	-	24.5	24.01	-0.12	0.119	1.12	0.13
18	GSM1900	GPRS12	Rear Face	1.5	512	0	Sensor On	23.0	22.28	0.04	0.192	1.18	0.23
	WCDMA II	RMC12.2K	Front Face	1.5	9538	0	-	24.0	23.52	0.19	0.361	1.12	0.40
19	WCDMA II	RMC12.2K	Rear Face	1.5	9538	0	Sensor On	20.5	20.13	0.06	0.652	1.09	0.71
20	WCDMA IV	RMC12.2K	Front Face	1.5	1413	0	-	24.0	23.65	0.03	0.275	1.08	0.30
	WCDMA IV	RMC12.2K	Rear Face	1.5	1312	0	Sensor On	21.0	20.72	0.08	0.257	1.07	0.27
	WCDMA V	RMC12.2K	Front Face	1.5	4182	0	-	24.0	23.80	0.01	0.116	1.05	0.12
21	WCDMA V	RMC12.2K	Rear Face	1.5	4182	0	-	24.0	23.80	0.03	0.142	1.05	0.15
	WCDMA V	RMC12.2K	Front Face	1.5	4182	1	-	24.0	23.80	-0.03	0.095	1.05	0.10
	WCDMA V	RMC12.2K	Rear Face	1.5	4182	1	-	24.0	23.80	0.07	0.140	1.05	0.15

Plot No.	Band	Mode	Test Position	Ch.	RB#	RB Offset	TX Ant.	Power Reduction	Max. Tune-up Power (dBm)	Measured Conducted Power (dBm)	Power Drift (dB)	Measured SAR-1g (W/kg)	Scaling Factor	Scaled SAR-1g (W/kg)
22	LTE 2	QPSK20M	Front Face	18900	1	0	0	-	24.0	23.37	0.08	0.290	1.16	0.34
	LTE 2	QPSK20M	Rear Face	18700	1	50	0	Sensor On	20.5	19.83	0.06	0.254	1.17	0.30
	LTE 2	QPSK20M	Front Face	18900	50	0	0	-	23.0	22.51	0.15	0.236	1.12	0.26
	LTE 2	QPSK20M	Rear Face	18700	50	25	0	Sensor On	20.5	19.82	-0.16	0.260	1.17	0.30
23	LTE 4	QPSK20M	Front Face	20050	1	50	0	-	24.0	23.38	0.00	0.241	1.15	0.28
	LTE 4	QPSK20M	Rear Face	20050	1	0	0	Sensor On	20.5	19.83	-0.01	0.202	1.17	0.24
	LTE 4	QPSK20M	Front Face	20050	50	0	0	-	23.0	22.54	-0.01	0.196	1.11	0.22
	LTE 4	QPSK20M	Rear Face	20050	50	25	0	Sensor On	20.5	19.79	-0.04	0.210	1.18	0.25
	LTE 5	QPSK10M	Front Face	20525	1	0	0	-	24.5	23.98	-0.01	0.113	1.13	0.13
24	LTE 5	QPSK10M	Rear Face	20525	1	0	0	-	24.5	23.98	-0.01	0.137	1.13	0.15
	LTE 5	QPSK10M	Front Face	20525	1	0	1	-	24.5	23.98	0.04	0.083	1.13	0.09
	LTE 5	QPSK10M	Rear Face	20525	1	0	1	-	24.5	23.98	0.13	0.125	1.13	0.14
	LTE 5	QPSK10M	Front Face	20525	25	12	0	-	23.5	23.04	-0.01	0.094	1.11	0.10
	LTE 5	QPSK10M	Rear Face	20525	25	12	0	-	23.5	23.04	0.03	0.114	1.11	0.13
	LTE 5	QPSK10M	Front Face	20525	25	12	1	-	23.5	23.04	0.00	0.067	1.11	0.07
	LTE 5	QPSK10M	Rear Face	20525	25	12	1	-	23.5	23.04	0.05	0.101	1.11	0.11
25	LTE 7	QPSK20M	Front Face	21350	1	0	0	-	24.0	23.19	0.02	0.392	1.21	0.47
	LTE 7	QPSK20M	Rear Face	21100	1	0	0	Sensor On	20.0	19.23	0.09	0.286	1.19	0.34
	LTE 7	QPSK20M	Front Face	21350	50	50	0	-	23.0	22.27	0.13	0.318	1.18	0.38
	LTE 7	QPSK20M	Rear Face	21100	50	0	0	Sensor On	20.0	19.21	0.01	0.297	1.20	0.36
	LTE 7	QPSK20M	Front Face	PCC:20850 SCC:21048	PCC:1 SCC:1	PCC:99 SCC:0	1	-	24.0	23.35	0.04	0.366	1.16	0.43
	LTE 38	QPSK20M	Front Face	38150	1	99	0	-	24.0	23.14	-0.01	0.237	1.22	0.29
	LTE 38	QPSK20M	Rear Face	38150	1	0	0	Sensor On	22.0	21.20	0.01	0.291	1.20	0.35
	LTE 38	QPSK20M	Front Face	38150	50	0	0	-	23.0	22.27	-0.07	0.191	1.18	0.23
26	LTE 38	QPSK20M	Rear Face	38150	50	25	0	Sensor On	22.0	21.17	0.01	0.292	1.21	0.35
	LTE 38	QPSK20M	Rear Face	PCC:37952 SCC:38150	PCC:1 SCC:1	PCC:99 SCC:0	1	Sensor On	22.0	21.05	0.01	0.265	1.24	0.33
	LTE 41	QPSK20M	Front Face	41140	1	0	0	-	24.0	23.38	0.08	0.262	1.15	0.30
	LTE 41	QPSK20M	Rear Face	41140	1	0	0	Sensor On	22.0	21.28	0.04	0.315	1.18	0.37
	LTE 41	QPSK20M	Front Face	41140	50	0	0	-	24.0	23.38	-0.03	0.231	1.15	0.27
27	LTE 41	QPSK20M	Rear Face	41140	50	0	0	Sensor On	22.0	21.25	0.01	0.318	1.19	0.38

FCC SAR Test Report

Plot No.	Band	Mode	Test Position	Ch.	TX Ant.	Max. Tune-up Power (dBm)	Measured Conducted Power (dBm)	Power Drift (dB)	Measured SAR-1g (W/kg)	Scaling Factor	Scaled SAR-1g (W/kg)
	WLAN2.4G	802.11b	Front Face	6	0	17.0	16.30	0.06	0.034	1.17	0.04
	WLAN2.4G	802.11b	Rear Face	6	0	17.0	16.30	0.04	0.048	1.17	0.06
	WLAN2.4G	802.11b	Front Face	1	1	17.0	16.60	0.03	0.042	1.10	0.05
	WLAN2.4G	802.11b	Rear Face	1	1	17.0	16.60	0.09	0.067	1.10	0.07
	WLAN2.4G	802.11b	Front Face	6	0+1	19.0	18.86	0.03	0.070	1.03	0.07
28	WLAN2.4G	802.11b	Rear Face	6	0+1	19.0	18.86	-0.11	0.103	1.03	0.11
	WLAN5.3G	802.11a	Front Face	52	0	16.0	15.31	0.05	0.039	1.17	0.05
	WLAN5.3G	802.11a	Rear Face	52	0	16.0	15.31	0.04	0.052	1.17	0.06
	WLAN5.3G	802.11a	Front Face	64	1	16.0	15.29	0.09	0.012	1.18	0.01
	WLAN5.3G	802.11a	Rear Face	64	1	16.0	15.29	0.03	0.062	1.18	0.07
	WLAN5.3G	802.11a	Front Face	52	0+1	18.0	17.86	0.08	0.038	1.03	0.04
29	WLAN5.3G	802.11a	Rear Face	52	0+1	18.0	17.86	0.01	0.074	1.03	0.08
	WLAN5.6G	802.11a	Front Face	140	0	16.0	14.42	0.04	0.035	1.44	0.05
	WLAN5.6G	802.11a	Rear Face	140	0	16.0	14.42	-0.06	0.063	1.44	0.09
	WLAN5.6G	802.11a	Front Face	140	1	16.0	14.79	0.03	0.011	1.32	0.02
	WLAN5.6G	802.11a	Rear Face	140	1	16.0	14.79	0.04	0.048	1.32	0.06
	WLAN5.6G	802.11a	Front Face	140	0+1	18.0	17.28	-0.03	0.033	1.18	0.04
30	WLAN5.6G	802.11a	Rear Face	140	0+1	18.0	17.28	-0.06	0.076	1.18	0.09
	WLAN5.8G	802.11a	Front Face	149	0	16.0	15.44	0.01	0.035	1.14	0.04
	WLAN5.8G	802.11a	Rear Face	149	0	16.0	15.44	0.10	0.059	1.14	0.07
	WLAN5.8G	802.11a	Front Face	149	1	16.0	15.88	0.08	0.013	1.03	0.01
	WLAN5.8G	802.11a	Rear Face	149	1	16.0	15.88	0.02	0.058	1.03	0.06
	WLAN5.8G	802.11a	Front Face	149	0+1	18.5	18.17	0.03	0.036	1.08	0.04
31	WLAN5.8G	802.11a	Rear Face	149	0+1	18.5	18.17	0.05	0.086	1.08	0.09
	Bluetooth	GFSK	Front Face	78	0	10.0	9.72	0.06	0.005	1.07	0.01
32	Bluetooth	GFSK	Rear Face	78	0	10.0	9.72	0.01	0.006	1.07	0.01

FCC SAR Test Report

4.7.4 SAR Results for Hotspot Exposure Condition (Separation Distance is 1.0 cm Gap)

Plot No.	Band	Mode	Test Position	Ch	TX Ant.	Power Reduction	Maximum Tune-up (dBm)	Conducted Power (dBm)	Power Drift	Measured SAR-1g (W/kg)	Scaling Factor	Scaled SAR-1g (W/kg)
33	GSM850	GPRS12	Front Face	251	0	-	30.5	29.59	0.07	0.164	1.23	0.20
	GSM850	GPRS12	Rear Face	251	0	-	30.5	29.59	0.04	0.209	1.23	0.26
	GSM850	GPRS12	Left Side	251	0	-	30.5	29.59	0.01	0.052	1.23	0.06
	GSM850	GPRS12	Right Side	251	0	-	30.5	29.59	0.02	0.109	1.23	0.13
	GSM850	GPRS12	Bottom Side	251	0	-	30.5	29.59	-0.01	0.169	1.23	0.21
	GSM850	GPRS12	Front Face	251	1	-	30.5	29.59	0.03	0.106	1.23	0.13
	GSM850	GPRS12	Rear Face	251	1	-	30.5	29.59	0.08	0.172	1.23	0.21
	GSM850	GPRS12	Left Side	251	1	-	30.5	29.59	0.02	0.049	1.23	0.06
	GSM850	GPRS12	Right Side	251	1	-	30.5	29.59	0.07	0.083	1.23	0.10
	GSM850	GPRS12	Top Side	251	1	-	30.5	29.59	-0.01	0.090	1.23	0.11
34	GSM1900	GPRS12	Front Face	810	0	-	24.5	24.01	0.05	0.232	1.12	0.26
	GSM1900	GPRS12	Rear Face	512	0	Sensor On	23.0	22.28	-0.14	0.387	1.18	0.46
	GSM1900	GPRS12	Left Side	810	0	-	24.5	24.01	0.12	0.035	1.12	0.04
	GSM1900	GPRS12	Right Side	810	0	-	24.5	24.01	-0.04	0.032	1.12	0.04
	GSM1900	GPRS12	Bottom Side	512	0	Sensor On	23.0	22.28	-0.01	0.613	1.18	0.72
35	WCDMA II	RMC12.2K	Front Face	9538	0	-	24.0	23.52	0.09	0.683	1.12	0.76
	WCDMA II	RMC12.2K	Rear Face	9538	0	Sensor On	20.5	20.13	-0.02	0.611	1.09	0.67
	WCDMA II	RMC12.2K	Left Side	9538	0	-	24.0	23.52	0.02	0.106	1.12	0.12
	WCDMA II	RMC12.2K	Right Side	9538	0	-	24.0	23.52	-0.02	0.119	1.12	0.13
	WCDMA II	RMC12.2K	Bottom Side	9538	0	Sensor On	20.5	20.13	-0.07	0.888	1.09	0.97
	WCDMA II	RMC12.2K	Bottom Side	9262	0	Sensor On	20.5	20.10	-0.01	0.807	1.10	0.88
	WCDMA II	RMC12.2K	Bottom Side	9400	0	Sensor On	20.5	20.01	-0.07	0.827	1.12	0.93
	WCDMA II	RMC12.2K	Bottom Side	9538	0	Sensor On	20.5	20.13	0.03	0.852	1.09	0.93
36	WCDMA IV	RMC12.2K	Front Face	1413	0	-	24.0	23.65	0.13	0.529	1.08	0.57
	WCDMA IV	RMC12.2K	Rear Face	1312	0	Sensor On	21.0	20.72	0.04	0.488	1.07	0.52
	WCDMA IV	RMC12.2K	Left Side	1413	0	-	24.0	23.65	0.1	0.100	1.08	0.11
	WCDMA IV	RMC12.2K	Right Side	1413	0	-	24.0	23.65	0.19	0.117	1.08	0.13
	WCDMA IV	RMC12.2K	Bottom Side	1312	0	Sensor On	21.0	20.72	-0.05	0.641	1.07	0.68
37	WCDMA V	RMC12.2K	Front Face	4182	0	-	24.0	23.80	-0.02	0.160	1.05	0.17
	WCDMA V	RMC12.2K	Rear Face	4182	0	-	24.0	23.80	0.08	0.207	1.05	0.22
	WCDMA V	RMC12.2K	Left Side	4182	0	-	24.0	23.80	-0.02	0.069	1.05	0.07
	WCDMA V	RMC12.2K	Right Side	4182	0	-	24.0	23.80	0.01	0.157	1.05	0.16
	WCDMA V	RMC12.2K	Bottom Side	4182	0	-	24.0	23.80	-0.09	0.183	1.05	0.19
	WCDMA V	RMC12.2K	Front Face	4182	1	-	24.0	23.80	-0.03	0.165	1.05	0.17
	WCDMA V	RMC12.2K	Rear Face	4182	1	-	24.0	23.80	0.05	0.264	1.05	0.28
	WCDMA V	RMC12.2K	Left Side	4182	1	-	24.0	23.80	0.04	0.061	1.05	0.06
WCDMA V	RMC12.2K	Right Side	4182	1	-	24.0	23.80	0.02	0.107	1.05	0.11	
WCDMA V	RMC12.2K	Top Side	4182	1	-	24.0	23.80	-0.01	0.130	1.05	0.14	

FCC SAR Test Report

Plot No.	Band	Mode	Test Position	Ch.	RB#	RB Offset	TX Ant.	Power Reduction	Max. Tune-up Power (dBm)	Measured Conducted Power (dBm)	Power Drift	Measured SAR-1g (W/kg)	Scaling Factor	Scaled SAR-1g (W/kg)
	LTE 2	QPSK20M	Front Face	18900	1	0	0	-	24.0	23.37	-0.02	0.574	1.16	0.66
	LTE 2	QPSK20M	Rear Face	18700	1	50	0	Sensor On	20.5	19.83	0.08	0.495	1.17	0.58
	LTE 2	QPSK20M	Left Side	18900	1	0	0	-	24.0	23.37	-0.07	0.110	1.16	0.13
	LTE 2	QPSK20M	Right Side	18900	1	0	0	-	24.0	23.37	-0.13	0.119	1.16	0.14
	LTE 2	QPSK20M	Bottom Side	18700	1	50	0	Sensor On	20.5	19.83	0.02	0.723	1.17	0.84
	LTE 2	QPSK20M	Bottom Side	18900	1	50	0	Sensor On	20.5	19.79	0.03	0.809	1.18	0.95
	LTE 2	QPSK20M	Bottom Side	19100	1	50	0	Sensor On	20.5	19.72	0.01	0.847	1.20	1.01
	LTE 2	QPSK20M	Front Face	18900	50	0	0	-	23.0	22.51	0.16	0.469	1.12	0.53
	LTE 2	QPSK20M	Rear Face	18700	50	25	0	Sensor On	20.5	19.82	0.06	0.507	1.17	0.59
	LTE 2	QPSK20M	Left Side	18900	50	0	0	-	23.0	22.51	0.06	0.085	1.12	0.10
	LTE 2	QPSK20M	Right Side	18900	50	0	0	-	23.0	22.51	-0.01	0.096	1.12	0.11
	LTE 2	QPSK20M	Bottom Side	18700	50	25	0	Sensor On	20.5	19.82	0.03	0.736	1.17	0.86
	LTE 2	QPSK20M	Bottom Side	18900	50	25	0	Sensor On	20.5	19.78	0.02	0.826	1.18	0.97
38	LTE 2	QPSK20M	Bottom Side	19100	50	25	0	Sensor On	20.5	19.71	-0.03	0.863	1.20	1.04
	LTE 2	QPSK20M	Bottom Side	18700	100	0	0	Sensor On	20.5	19.74	-0.08	0.775	1.19	0.92
	LTE 2	QPSK20M	Bottom Side	19100	50	25	0	Sensor On	20.5	19.71	-0.02	0.860	1.20	1.03
	LTE 4	QPSK20M	Front Face	20050	1	50	0	-	24.0	23.38	0.04	0.469	1.15	0.54
	LTE 4	QPSK20M	Rear Face	20050	1	0	0	Sensor On	20.5	19.83	0.04	0.395	1.17	0.46
	LTE 4	QPSK20M	Left Side	20050	1	50	0	-	24.0	23.38	-0.17	0.087	1.15	0.10
	LTE 4	QPSK20M	Right Side	20050	1	50	0	-	24.0	23.38	0.11	0.104	1.15	0.12
	LTE 4	QPSK20M	Bottom Side	20050	1	0	0	Sensor On	20.5	19.83	0	0.513	1.17	0.60
	LTE 4	QPSK20M	Front Face	20050	50	0	0	-	23.0	22.54	0.02	0.380	1.11	0.42
	LTE 4	QPSK20M	Rear Face	20050	50	25	0	Sensor On	20.5	19.79	0.07	0.413	1.18	0.49
	LTE 4	QPSK20M	Left Side	20050	50	0	0	-	23.0	22.54	0.17	0.073	1.11	0.08
	LTE 4	QPSK20M	Right Side	20050	50	0	0	-	23.0	22.54	0.01	0.085	1.11	0.09
39	LTE 4	QPSK20M	Bottom Side	20050	50	25	0	Sensor On	20.5	19.79	0.03	0.550	1.18	0.65
	LTE 5	QPSK10M	Front Face	20525	1	0	0	-	24.5	23.98	-0.05	0.154	1.13	0.17
	LTE 5	QPSK10M	Rear Face	20525	1	0	0	-	24.5	23.98	0.05	0.171	1.13	0.19
	LTE 5	QPSK10M	Left Side	20525	1	0	0	-	24.5	23.98	0.05	0.067	1.13	0.08
	LTE 5	QPSK10M	Right Side	20525	1	0	0	-	24.5	23.98	0	0.145	1.13	0.16
	LTE 5	QPSK10M	Bottom Side	20525	1	0	0	-	24.5	23.98	0.01	0.153	1.13	0.17
	LTE 5	QPSK10M	Front Face	20525	1	0	1	-	24.5	23.98	0.01	0.140	1.13	0.16
40	LTE 5	QPSK10M	Rear Face	20525	1	0	1	-	24.5	23.98	0.07	0.211	1.13	0.24
	LTE 5	QPSK10M	Left Side	20525	1	0	1	-	24.5	23.98	0.02	0.066	1.13	0.07
	LTE 5	QPSK10M	Right Side	20525	1	0	1	-	24.5	23.98	0	0.113	1.13	0.13
	LTE 5	QPSK10M	Top Side	20525	1	0	1	-	24.5	23.98	0.14	0.117	1.13	0.13
	LTE 5	QPSK10M	Front Face	20525	25	12	0	-	23.5	23.04	-0.01	0.136	1.11	0.15
	LTE 5	QPSK10M	Rear Face	20525	25	12	0	-	23.5	23.04	0.07	0.157	1.11	0.17
	LTE 5	QPSK10M	Left Side	20525	25	12	0	-	23.5	23.04	0.05	0.055	1.11	0.06
	LTE 5	QPSK10M	Right Side	20525	25	12	0	-	23.5	23.04	0	0.116	1.11	0.13
	LTE 5	QPSK10M	Bottom Side	20525	25	12	0	-	23.5	23.04	0.01	0.133	1.11	0.15
	LTE 5	QPSK10M	Front Face	20525	25	12	1	-	23.5	23.04	0.04	0.114	1.11	0.13
	LTE 5	QPSK10M	Rear Face	20525	25	12	1	-	23.5	23.04	0.06	0.173	1.11	0.19
	LTE 5	QPSK10M	Left Side	20525	25	12	1	-	23.5	23.04	0.07	0.051	1.11	0.06
	LTE 5	QPSK10M	Right Side	20525	25	12	1	-	23.5	23.04	0.03	0.089	1.11	0.10
	LTE 5	QPSK10M	Top Side	20525	25	12	1	-	23.5	23.04	0.08	0.098	1.11	0.11

FCC SAR Test Report

Plot No.	Band	Mode	Test Position	Ch.	RB#	RB Offset	Tx Ant.	Power Reduction	Max. Tune-up Power (dBm)	Measured Conducted Power (dBm)	Power Drift	Measured SAR-1g (W/kg)	Scaling Factor	Scaled SAR-1g (W/kg)
	LTE 7	QPSK20M	Front Face	21350	1	0	0	-	24.0	23.19	0.08	0.695	1.21	0.84
	LTE 7	QPSK20M	Rear Face	21100	1	0	0	Sensor On	20.0	19.23	0.06	0.536	1.19	0.64
	LTE 7	QPSK20M	Left Side	21350	1	0	0	-	24.0	23.19	-0.07	0.184	1.21	0.22
	LTE 7	QPSK20M	Right Side	21350	1	0	0	-	24.0	23.19	0.11	0.248	1.21	0.30
	LTE 7	QPSK20M	Bottom Side	21100	1	0	0	Sensor On	20.0	19.23	0.01	0.741	1.19	0.88
	LTE 7	QPSK20M	Front Face	20850	1	0	0	-	24.0	23.08	0.05	0.627	1.24	0.77
	LTE 7	QPSK20M	Front Face	21100	1	0	0	-	24.0	23.17	-0.03	0.652	1.21	0.79
	LTE 7	QPSK20M	Bottom Side	20850	1	0	0	Sensor On	20.0	19.17	0.07	0.715	1.21	0.87
	LTE 7	QPSK20M	Bottom Side	21350	1	0	0	Sensor On	20.0	19.19	0.05	0.785	1.21	0.95
	LTE 7	QPSK20M	Front Face	21350	50	50	0	-	23.0	22.27	0.01	0.569	1.18	0.67
	LTE 7	QPSK20M	Rear Face	21100	50	0	0	Sensor On	20.0	19.21	0.02	0.551	1.20	0.66
	LTE 7	QPSK20M	Left Side	21350	50	50	0	-	23.0	22.27	0.08	0.148	1.18	0.18
	LTE 7	QPSK20M	Right Side	21350	50	50	0	-	23.0	22.27	-0.05	0.201	1.18	0.24
	LTE 7	QPSK20M	Bottom Side	21100	50	0	0	Sensor On	20.0	19.21	0.03	0.777	1.20	0.93
	LTE 7	QPSK20M	Bottom Side	20850	50	0	0	Sensor On	20.0	19.15	0.14	0.752	1.22	0.91
41	LTE 7	QPSK20M	Bottom Side	21350	50	0	0	Sensor On	20.0	19.17	0.04	0.796	1.21	0.96
	LTE 7	QPSK20M	Front Face	21350	100	0	0	-	23.0	22.20	0.05	0.549	1.20	0.66
	LTE 7	QPSK20M	Bottom Side	21100	100	0	0	Sensor On	20.0	19.15	0.07	0.789	1.22	0.96
	LTE 7	QPSK20M	Bottom Side	PCC:20850 SCC:21048	PCC:1 SCC:1	PCC:99 SCC:0	0	Sensor On	20.0	19.01	0.05	0.759	1.26	0.95
	LTE 7	QPSK20M	Bottom Side	PCC:21001 SCC:21199	PCC:1 SCC:1	PCC:99 SCC:0	0	Sensor On	20.0	19.15	0.01	0.767	1.22	0.93
	LTE 7	QPSK20M	Bottom Side	PCC:21152 SCC:21350	PCC:1 SCC:1	PCC:99 SCC:0	0	Sensor On	20.0	19.08	0.02	0.771	1.24	0.95
	LTE 38	QPSK20M	Front Face	38150	1	99	0	-	24.0	23.14	0.02	0.419	1.22	0.51
	LTE 38	QPSK20M	Rear Face	38150	1	0	0	Sensor On	22.0	21.20	0.11	0.527	1.20	0.63
	LTE 38	QPSK20M	Left Side	38150	1	99	0	-	24.0	23.14	0.08	0.104	1.22	0.13
	LTE 38	QPSK20M	Right Side	38150	1	99	0	-	24.0	23.14	-0.02	0.148	1.22	0.18
	LTE 38	QPSK20M	Bottom Side	38150	1	0	0	Sensor On	22.0	21.20	0.13	0.765	1.20	0.92
	LTE 38	QPSK20M	Bottom Side	37850	1	0	0	Sensor On	22.0	21.14	-0.05	0.768	1.22	0.94
	LTE 38	QPSK20M	Bottom Side	38000	1	0	0	Sensor On	22.0	21.09	0.06	0.765	1.23	0.94
	LTE 38	QPSK20M	Front Face	38150	50	0	0	-	23.0	22.27	0.04	0.332	1.18	0.39
	LTE 38	QPSK20M	Rear Face	38150	50	25	0	Sensor On	22.0	21.17	0.15	0.522	1.21	0.63
	LTE 38	QPSK20M	Left Side	38150	50	0	0	-	23.0	22.27	0.12	0.085	1.18	0.10
	LTE 38	QPSK20M	Right Side	38150	50	0	0	-	23.0	22.27	-0.08	0.121	1.18	0.14
	LTE 38	QPSK20M	Bottom Side	38150	50	25	0	Sensor On	22.0	21.17	0.03	0.754	1.21	0.91
	LTE 38	QPSK20M	Bottom Side	37850	50	25	0	Sensor On	22.0	21.11	0.06	0.783	1.23	0.96
42	LTE 38	QPSK20M	Bottom Side	38000	50	25	0	Sensor On	22.0	21.06	0.09	0.779	1.24	0.97
	LTE 38	QPSK20M	Bottom Side	38150	100	0	0	Sensor On	22.0	20.98	0.04	0.756	1.26	0.96
	LTE 38	QPSK20M	Bottom Side	PCC:37850 SCC:38048	PCC:1 SCC:1	PCC:99 SCC:0	0	Sensor On	22.0	20.98	0.03	0.754	1.26	0.95
	LTE 38	QPSK20M	Bottom Side	PCC:37901 SCC:38099	PCC:1 SCC:1	PCC:99 SCC:0	0	Sensor On	22.0	21.00	0.01	0.766	1.26	0.96
	LTE 38	QPSK20M	Bottom Side	PCC:37952 SCC:38150	PCC:1 SCC:1	PCC:99 SCC:0	0	Sensor On	22.0	21.05	0.06	0.753	1.24	0.94
	LTE 41	QPSK20M	Front Face	41140	1	0	0	-	24.0	23.38	0.06	0.429	1.15	0.49
	LTE 41	QPSK20M	Rear Face	41140	1	0	0	Sensor On	22.0	21.28	0.13	0.539	1.18	0.64
	LTE 41	QPSK20M	Left Side	41140	1	0	0	-	24.0	23.38	-0.01	0.106	1.15	0.12
	LTE 41	QPSK20M	Right Side	41140	1	0	0	-	24.0	23.38	0.17	0.151	1.15	0.17
	LTE 41	QPSK20M	Bottom Side	41140	1	0	0	Sensor On	22.0	21.28	0.02	0.693	1.18	0.82
	LTE 41	QPSK20M	Bottom Side	40140	1	0	0	Sensor On	22.0	21.01	-0.09	0.716	1.26	0.90
	LTE 41	QPSK20M	Bottom Side	40640	1	0	0	Sensor On	22.0	21.07	0.03	0.734	1.24	0.91
	LTE 41	QPSK20M	Front Face	41140	50	0	0	-	24.0	23.38	0.05	0.340	1.15	0.39
	LTE 41	QPSK20M	Rear Face	41140	50	0	0	Sensor On	22.0	21.25	0.04	0.534	1.19	0.63
	LTE 41	QPSK20M	Left Side	41140	50	0	0	-	24.0	23.38	-0.06	0.087	1.15	0.10
	LTE 41	QPSK20M	Right Side	41140	50	0	0	-	24.0	23.38	0.17	0.124	1.15	0.14
	LTE 41	QPSK20M	Bottom Side	41140	50	0	0	Sensor On	22.0	21.25	0.11	0.702	1.19	0.83
	LTE 41	QPSK20M	Bottom Side	40140	50	0	0	Sensor On	22.0	20.98	0.08	0.729	1.26	0.92

FCC SAR Test Report

43	LTE 41	QPSK20M	Bottom Side	40640	50	0	0	Sensor On	22.0	21.04	0.08	0.744	1.25	0.93
	LTE 41	QPSK20M	Bottom Side	41140	100	0	0	Sensor On	22.0	21.23	0	0.702	1.19	0.84

Plot No.	Band	Mode	Test Position	Ch.	TX Ant.	Max. Tune-up Power (dBm)	Measured Conducted Power (dBm)	Power Drift (dB)	Measured SAR-1g (W/kg)	Scaling Factor	Scaled SAR-1g (W/kg)
	WLAN2.4G	802.11b	Front Face	6	0	17.0	16.30	0.08	0.057	1.17	0.07
	WLAN2.4G	802.11b	Rear Face	6	0	17.0	16.30	0.14	0.114	1.17	0.13
	WLAN2.4G	802.11b	Left Side	6	0	17.0	16.30	0.02	0.008	1.17	0.01
	WLAN2.4G	802.11b	Right Side	6	0	17.0	16.30	0.08	0.017	1.17	0.02
	WLAN2.4G	802.11b	Top Side	6	0	17.0	16.30	0.06	0.102	1.17	0.12
	WLAN2.4G	802.11b	Front Face	1	1	17.0	16.60	-0.03	0.082	1.10	0.09
	WLAN2.4G	802.11b	Rear Face	1	1	17.0	16.60	0.16	0.152	1.10	0.17
	WLAN2.4G	802.11b	Left Side	1	1	17.0	16.60	0.06	0.185	1.10	0.20
	WLAN2.4G	802.11b	Right Side	1	1	17.0	16.60	0.08	0.004	1.10	0.00
	WLAN2.4G	802.11b	Top Side	1	1	17.0	16.60	-0.10	0.023	1.10	0.02
	WLAN2.4G	802.11b	Front Face	6	0+1	19.0	18.86	0.14	0.121	1.03	0.12
44	WLAN2.4G	802.11b	Rear Face	6	0+1	19.0	18.86	0.04	0.189	1.03	0.20
	WLAN2.4G	802.11b	Left Side	6	0+1	19.0	18.86	0.13	0.082	1.03	0.08
	WLAN2.4G	802.11b	Right Side	6	0+1	19.0	18.86	0.01	0.032	1.03	0.03
	WLAN2.4G	802.11b	Top Side	6	0+1	19.0	18.86	0.19	0.107	1.03	0.11
	WLAN5.2G	802.11a	Front Face	48	0	16.0	15.38	0	0.074	1.15	0.09
	WLAN5.2G	802.11a	Rear Face	48	0	16.0	15.38	-0.02	0.083	1.15	0.10
	WLAN5.2G	802.11a	Left Side	48	0	16.0	15.38	-0.02	0.005	1.15	0.01
	WLAN5.2G	802.11a	Right Side	48	0	16.0	15.38	0.02	0.007	1.15	0.01
	WLAN5.2G	802.11a	Top Side	48	0	16.0	15.38	0.08	0.076	1.15	0.09
	WLAN5.2G	802.11a	Front Face	48	1	16.0	15.16	0.04	0.015	1.21	0.02
	WLAN5.2G	802.11a	Rear Face	48	1	16.0	15.16	0.05	0.085	1.21	0.10
	WLAN5.2G	802.11a	Left Side	48	1	16.0	15.16	0.06	0.010	1.21	0.01
	WLAN5.2G	802.11a	Right Side	48	1	16.0	15.16	0	0.069	1.21	0.08
	WLAN5.2G	802.11a	Top Side	48	1	16.0	15.16	0	0.055	1.21	0.07
	WLAN5.2G	802.11a	Front Face	48	0+1	18.0	17.89	0	0.068	1.03	0.07
45	WLAN5.2G	802.11a	Rear Face	48	0+1	18.0	17.89	0.07	0.186	1.03	0.19
	WLAN5.2G	802.11a	Left Side	48	0+1	18.0	17.89	0.04	0.004	1.03	0.00
	WLAN5.2G	802.11a	Right Side	48	0+1	18.0	17.89	0.07	0.069	1.03	0.07
	WLAN5.2G	802.11a	Top Side	48	0+1	18.0	17.89	0.04	0.119	1.03	0.12
	WLAN5.8G	802.11a	Front Face	149	0	16.0	15.44	0.05	0.062	1.14	0.07
	WLAN5.8G	802.11a	Rear Face	149	0	16.0	15.44	0.09	0.100	1.14	0.11
	WLAN5.8G	802.11a	Left Side	149	0	16.0	15.44	0.03	0.004	1.14	0.00
	WLAN5.8G	802.11a	Right Side	149	0	16.0	15.44	0.05	0.060	1.14	0.07
	WLAN5.8G	802.11a	Top Side	149	0	16.0	15.44	0.08	0.085	1.14	0.10
	WLAN5.8G	802.11a	Front Face	149	1	16.0	15.88	0.01	0.017	1.03	0.02
	WLAN5.8G	802.11a	Rear Face	149	1	16.0	15.88	0.09	0.114	1.03	0.12
	WLAN5.8G	802.11a	Left Side	149	1	16.0	15.88	0.05	0.006	1.03	0.01
	WLAN5.8G	802.11a	Right Side	149	1	16.0	15.88	0.05	0.072	1.03	0.07
	WLAN5.8G	802.11a	Top Side	149	1	16.0	15.88	0.02	0.049	1.03	0.05
	WLAN5.8G	802.11a	Front Face	149	0+1	18.5	18.17	0.01	0.064	1.08	0.07
46	WLAN5.8G	802.11a	Rear Face	149	0+1	18.5	18.17	0.05	0.169	1.08	0.18
	WLAN5.8G	802.11a	Left Side	149	0+1	18.5	18.17	0.09	0.009	1.08	0.01
	WLAN5.8G	802.11a	Right Side	149	0+1	18.5	18.17	0.15	0.098	1.08	0.11
	WLAN5.8G	802.11a	Top Side	149	0+1	18.5	18.17	0.09	0.098	1.08	0.11
	Bluetooth	GFSK	Front Face	78	0	10.0	9.72	-0.03	0.008	1.07	0.01
	Bluetooth	GFSK	Rear Face	78	0	10.0	9.72	0.09	0.016	1.07	0.02
	Bluetooth	GFSK	Left Side	78	0	10.0	9.72	0.12	0.003	1.07	0.00
47	Bluetooth	GFSK	Right Side	78	0	10.0	9.72	0.05	0.052	1.07	0.06
	Bluetooth	GFSK	Top Side	78	0	10.0	9.72	0.05	0.019	1.07	0.02

FCC SAR Test Report

4.7.5 SAR Results for Extremity Exposure Condition (Separation Distance is 0 cm Gap)

Plot No.	Band	Mode	Test Position	Ch	TX Ant.	Power Reduction	Maximum Tune-up (dBm)	Conducted Power (dBm)	Power Drift	Measured SAR-10g (W/kg)	Scaling Factor	Scaled SAR-10g (W/kg)
	WCDMA II	RMC12.2K	Rear Face	9538	0	Sensor On	20.5	20.13	-0.04	1.53	1.09	1.67
48	WCDMA II	RMC12.2K	Bottom Side	9538	0	Sensor On	20.5	20.13	-0.03	2.29	1.09	2.49
	WCDMA II	RMC12.2K	Bottom Side	9262	0	Sensor On	20.5	20.10	-0.08	2.27	1.10	2.49
	WCDMA II	RMC12.2K	Bottom Side	9400	0	Sensor On	20.5	20.01	-0.02	2.22	1.12	2.49
	WCDMA II	RMC12.2K	Bottom Side	9538	0	Sensor On	20.5	20.13	-0.03	2.22	1.09	2.42
	WCDMA IV	RMC12.2K	Rear Face	1312	0	Sensor On	21.0	20.72	-0.04	2.18	1.07	2.33
	WCDMA IV	RMC12.2K	Bottom Side	1413	0	Sensor On	21.0	20.65	-0.01	2.23	1.08	2.42
49	WCDMA IV	RMC12.2K	Bottom Side	1513	0	Sensor On	21.0	20.62	-0.01	2.26	1.09	2.47
	WCDMA IV	RMC12.2K	Bottom Side	1513	0	Sensor On	21.0	20.62	-0.01	2.21	1.09	2.41

Plot No.	Band	Mode	Test Position	Ch.	RB#	RB Offset	TX Ant.	Power Reduction	Max. Tune-up Power (dBm)	Measured Conducted Power (dBm)	Power Drift	Measured SAR-10g (W/kg)	Scaling Factor	Scaled SAR-10g (W/kg)
	LTE 2	QPSK20M	Rear Face	18700	1	50	0	Sensor On	20.5	19.83	0.04	1.48	1.17	1.73
	LTE 2	QPSK20M	Bottom Side	18700	1	50	0	Sensor On	20.5	19.83	0.10	2.1	1.17	2.45
	LTE 2	QPSK20M	Bottom Side	18900	1	50	0	Sensor On	20.5	19.79	0.02	2.06	1.18	2.43
	LTE 2	QPSK20M	Bottom Side	19100	1	50	0	Sensor On	20.5	19.72	0.01	2.13	1.20	2.55
	LTE 2	QPSK20M	Rear Face	18700	50	25	0	Sensor On	20.5	19.82	0.02	1.52	1.17	1.78
	LTE 2	QPSK20M	Bottom Side	18700	50	25	0	Sensor On	20.5	19.82	0.10	2.16	1.17	2.53
	LTE 2	QPSK20M	Bottom Side	18900	50	25	0	Sensor On	20.5	19.79	0.15	2.13	1.18	2.51
50	LTE 2	QPSK20M	Bottom Side	19100	50	25	0	Sensor On	20.5	19.72	0.11	2.2	1.20	2.63
	LTE 2	QPSK20M	Bottom Side	18700	100	0	0	Sensor On	20.5	19.74	0.03	2.12	1.19	2.53
	LTE 4	QPSK20M	Bottom Side	20050	1	0	0	Sensor On	20.5	19.83	0.11	1.76	1.17	2.05
	LTE 4	QPSK20M	Bottom Side	20175	1	0	0	Sensor On	20.5	19.71	0.04	1.75	1.20	2.10
	LTE 4	QPSK20M	Bottom Side	20300	1	0	0	Sensor On	20.5	19.64	0.06	1.78	1.22	2.17
	LTE 4	QPSK20M	Bottom Side	20050	50	25	0	Sensor On	20.5	19.79	0.06	1.85	1.18	2.18
	LTE 4	QPSK20M	Bottom Side	20175	50	25	0	Sensor On	20.5	19.71	0.04	1.85	1.20	2.22
51	LTE 4	QPSK20M	Bottom Side	20300	50	25	0	Sensor On	20.5	19.64	0.06	1.86	1.22	2.27
	LTE 4	QPSK20M	Bottom Side	20050	100	0	0	Sensor On	20.5	19.75	0.17	1.84	1.19	2.19
	LTE 7	QPSK20M	Rear Face	21100	1	0	0	Sensor On	20.0	19.23	0.09	1.66	1.19	1.98
	LTE 7	QPSK20M	Bottom Side	21100	1	0	0	Sensor On	20.0	19.23	0.07	0.797	1.19	0.95
52	LTE 7	QPSK20M	Rear Face	21100	50	0	0	Sensor On	20.0	19.21	0.05	1.74	1.20	2.09
	LTE 7	QPSK20M	Bottom Side	21100	50	0	0	Sensor On	20.0	19.21	0.10	0.816	1.20	0.98
	LTE 7	QPSK20M	Rear Face	20850	50	0	0	Sensor On	20.0	19.15	0.03	1.72	1.22	2.09
	LTE 7	QPSK20M	Rear Face	21350	50	0	0	Sensor On	20.0	19.17	-0.09	1.69	1.21	2.05
	LTE 7	QPSK20M	Rear Face	21100	100	0	0	Sensor On	20.0	19.15	0.00	1.72	1.22	2.09
	LTE 7	QPSK20M	Rear Face	PCC:20850 SCC:21048	PCC:1 SCC:1	PCC:99 SCC:0	0	Sensor On	20.0	19.01	0.01	1.65	1.26	2.07
	LTE 7	QPSK20M	Rear Face	PCC:21001 SCC:21199	PCC:1 SCC:1	PCC:99 SCC:0	0	Sensor On	20.0	19.15	0.08	1.67	1.22	2.03
	LTE 7	QPSK20M	Rear Face	PCC:21152 SCC:21350	PCC:1 SCC:1	PCC:99 SCC:0	0	Sensor On	20.0	19.08	0.03	1.61	1.24	1.99
	LTE 38	QPSK20M	Bottom Side	38150	1	0	0	Sensor On	22.0	21.20	0.15	0.671	1.20	0.81
53	LTE 38	QPSK20M	Bottom Side	38150	50	25	0	Sensor On	22.0	21.17	0.16	0.687	1.21	0.83
	LTE 38	QPSK20M	Bottom Side	PCC:37952 SCC:38150	PCC:1 SCC:1	PCC:99 SCC:0	0	Sensor On	22.0	21.05	0.01	0.645	1.24	0.80
	LTE 41	QPSK20M	Bottom Side	41140	1	0	0	Sensor On	22.0	21.28	0.04	0.716	1.18	0.85
54	LTE 41	QPSK20M	Bottom Side	41140	50	0	0	Sensor On	22.0	21.25	0.00	0.735	1.19	0.87

FCC SAR Test Report

Plot No.	Band	Mode	Test Position	Ch.	TX Ant.	Max. Tune-up Power (dBm)	Measured Conducted Power (dBm)	Power Drift (dB)	Measured SAR-10g (W/kg)	Scaling Factor	Scaled SAR-1g (W/kg)
	WLAN5.3G	802.11a	Front Face	52	0	16.0	15.31	0.07	0.216	1.17	0.25
	WLAN5.3G	802.11a	Rear Face	52	0	16.0	15.31	0.09	0.175	1.17	0.21
	WLAN5.3G	802.11a	Left Side	52	0	16.0	15.31	0.03	0.009	1.17	0.01
	WLAN5.3G	802.11a	Right Side	52	0	16.0	15.31	0.04	0.023	1.17	0.03
	WLAN5.3G	802.11a	Top Side	52	0	16.0	15.31	0.01	0.274	1.17	0.32
	WLAN5.3G	802.11a	Front Face	64	1	16.0	15.29	0	0.031	1.18	0.04
	WLAN5.3G	802.11a	Rear Face	64	1	16.0	15.29	0.13	0.337	1.18	0.40
	WLAN5.3G	802.11a	Left Side	64	1	16.0	15.29	0.06	0.005	1.18	0.01
	WLAN5.3G	802.11a	Right Side	64	1	16.0	15.29	0.04	0.281	1.18	0.33
	WLAN5.3G	802.11a	Top Side	64	1	16.0	15.29	0.07	0.112	1.18	0.13
	WLAN5.3G	802.11a	Front Face	52	0+1	18.0	17.86	0.05	0.210	1.03	0.22
55	WLAN5.3G	802.11a	Rear Face	52	0+1	18.0	17.86	0.03	0.399	1.03	0.41
	WLAN5.3G	802.11a	Left Side	52	0+1	18.0	17.86	0.012	0.010	1.03	0.01
	WLAN5.3G	802.11a	Right Side	52	0+1	18.0	17.86	0.08	0.203	1.03	0.21
	WLAN5.3G	802.11a	Top Side	52	0+1	18.0	17.86	0.03	0.314	1.03	0.32
	WLAN5.6G	802.11a	Front Face	140	0	15.0	14.42	0	0.225	1.14	0.26
	WLAN5.6G	802.11a	Rear Face	140	0	15.0	14.42	0.01	0.171	1.14	0.20
	WLAN5.6G	802.11a	Left Side	140	0	15.0	14.42	0.01	0.045	1.14	0.05
	WLAN5.6G	802.11a	Right Side	140	0	15.0	14.42	0	0.092	1.14	0.11
	WLAN5.6G	802.11a	Top Side	140	0	15.0	14.42	0.09	0.328	1.14	0.37
	WLAN5.6G	802.11a	Front Face	140	1	15.0	14.79	0.08	0.033	1.05	0.03
	WLAN5.6G	802.11a	Rear Face	140	1	15.0	14.79	-0.07	0.228	1.05	0.24
	WLAN5.6G	802.11a	Left Side	140	1	15.0	14.79	0	0.000	1.05	0.00
	WLAN5.6G	802.11a	Right Side	140	1	15.0	14.79	0.09	0.156	1.05	0.16
	WLAN5.6G	802.11a	Top Side	140	1	15.0	14.79	0.09	0.063	1.05	0.07
	WLAN5.6G	802.11a	Front Face	140	0+1	18.0	17.28	0	0.223	1.18	0.26
	WLAN5.6G	802.11a	Rear Face	140	0+1	18.0	17.28	0.09	0.317	1.18	0.37
	WLAN5.6G	802.11a	Left Side	140	0+1	18.0	17.28	0.02	0.004	1.18	0.01
	WLAN5.6G	802.11a	Right Side	140	0+1	18.0	17.28	0.05	0.224	1.18	0.26
56	WLAN5.6G	802.11a	Top Side	140	0+1	18.0	17.28	0.14	0.325	1.18	0.38

4.7.6 SAR Measurement Variability

According to KDB 865664 D01, SAR measurement variability was assessed for each frequency band, which is determined by the SAR probe calibration point and tissue-equivalent medium used for the device measurements. When both head and body tissue-equivalent media are required for SAR measurements in a frequency band, the variability measurement procedures should be applied to the tissue medium with the highest measured SAR, using the highest measured SAR configuration for that tissue-equivalent medium. Alternatively, if the highest measured SAR for both head and body tissue-equivalent media are ≤ 1.45 W/kg and the ratio of these highest SAR values, i.e., largest divided by smallest value, is ≤ 1.10 , the highest SAR configuration for either head or body tissue-equivalent medium may be used to perform the repeated measurement. These additional measurements are repeated after the completion of all measurements requiring the same head or body tissue-equivalent medium in a frequency band. The test device should be returned to ambient conditions (normal room temperature) with the battery fully charged before it is re-mounted on the device holder for the repeated measurement(s) to minimize any unexpected variations in the repeated results.

SAR repeated measurement procedure:

1. When the highest measured SAR is < 0.80 W/kg, repeated measurement is not required.
2. When the highest measured SAR is ≥ 0.80 W/kg, repeat that measurement once.
3. If the ratio of largest to smallest SAR for the original and first repeated measurements is > 1.20 , or when the original or repeated measurement is ≥ 1.45 W/kg, perform a second repeated measurement.
4. If the ratio of largest to smallest SAR for the original, first and second repeated measurements is > 1.20 , and the original, first or second repeated measurement is ≥ 1.5 W/kg, perform a third repeated measurement.

Band	Test Position	Ch.	Original Measured SAR-1g (W/kg)	1st Repeated SAR-1g (W/kg)	L/S Ratio	2nd Repeated SAR-1g (W/kg)	L/S Ratio	3rd Repeated SAR-1g (W/kg)	L/S Ratio
WCDMA V	Right Cheek	4182	0.818	0.811	1.009	N/A	N/A	N/A	N/A
WCDMA II	Bottom Side	9538	0.888	0.852	1.042	N/A	N/A	N/A	N/A
LTE 2	Bottom Side	19100	0.863	0.860	1.003	N/A	N/A	N/A	N/A

Band	Test Position	Ch.	Original Measured SAR-10g (W/kg)	1st Repeated SAR-10g (W/kg)	L/S Ratio	2nd Repeated SAR-1g (W/kg)	L/S Ratio	3rd Repeated SAR-1g (W/kg)	L/S Ratio
WCDMA II	Bottom Side	9538	2.29	2.22	1.031	N/A	N/A	N/A	N/A
WCDMA IV	Bottom Side	1513	2.26	2.21	1.023	N/A	N/A	N/A	N/A

FCC SAR Test Report

<Simultaneous transmission possibilities>

The simultaneous transmission possibilities for this device are listed as below.

Simultaneous TX Combination	Capable Transmit Configurations	Head (Voice / VoIP)	Body-worn (Voice / VoIP)	Hotspot (Data)
1	WWAN+WLAN 2.4G Ant0	Yes	Yes	Yes
2	WWAN+WLAN 2.4G Ant1	Yes	Yes	Yes
3	WWAN+WLAN 2.4G MIMO	Yes	Yes	Yes
4	WWAN+BT	Yes	Yes	Yes
5	WWAN+WLAN 5G Ant0	Yes	Yes	Yes
6	WWAN+WLAN 5G Ant1	Yes	Yes	Yes
7	WWAN+WLAN 5 MIMO	Yes	Yes	Yes
8	WWAN+WLAN 5G Ant0+BT	Yes	Yes	Yes
9	WWAN+WLAN 5G Ant1+BT	Yes	Yes	Yes
10	WWAN+WLAN 5G MIMO+BT	Yes	Yes	Yes
11	WWAN+WLAN 2.4G Ant0+ WLAN 5G Ant1	Yes	Yes	Yes

FCC SAR Test Report

<SAR Summation Analysis>

Simultaneous transmission SAR test exclusion is determined for each operating configuration and exposure condition according to the reported standalone SAR of each applicable simultaneous transmitting antenna. When the sum of SAR_{1g} of all simultaneously transmitting antennas in an operating mode and exposure condition combination is within the SAR limit (SAR_{1g} 1.6 W/kg), the simultaneous transmission SAR is not required. When the sum of SAR_{1g} is greater than the SAR limit (SAR_{1g} 1.6 W/kg), SAR test exclusion is determined by the SPLSR.

<Head Exposure condition>

WWAN Band	Exposure Position	1	2	5	1+2+5 Summed 1g SAR (W/kg)
		WWAN	2.4GHz WLAN Ant 0	5GHz WLAN Ant 1	
		1g SAR (W/kg)	1g SAR (W/kg)	1g SAR (W/kg)	
GSM850	Right Cheek	0.755	0.234	0.055	1.044
	Right Tilted	0.584	0.344	0.117	1.046
	Left Cheek	0.513	0.641	0.060	1.214
	Left Tilted	0.411	0.512	0.087	1.010
GSM1900	Right Cheek	0.023	0.234	0.055	0.312
	Right Tilted	0.014	0.344	0.117	0.475
	Left Cheek	0.026	0.641	0.060	0.727
	Left Tilted	0.014	0.512	0.087	0.613
WCDMA II	Right Cheek	0.068	0.234	0.055	0.357
	Right Tilted	0.040	0.344	0.117	0.501
	Left Cheek	0.083	0.641	0.060	0.784
	Left Tilted	0.045	0.512	0.087	0.645
WCDMA IV	Right Cheek	0.064	0.234	0.055	0.353
	Right Tilted	0.093	0.344	0.117	0.555
	Left Cheek	0.070	0.641	0.060	0.771
	Left Tilted	0.068	0.512	0.087	0.668
WCDMA V	Right Cheek	0.857	0.234	0.055	1.146
	Right Tilted	0.614	0.344	0.117	1.075
	Left Cheek	0.619	0.641	0.060	1.320
	Left Tilted	0.488	0.512	0.087	1.088
LTE Band 2	Right Cheek	0.060	0.234	0.055	0.350
	Right Tilted	0.052	0.344	0.117	0.514
	Left Cheek	0.070	0.641	0.060	0.771
	Left Tilted	0.049	0.512	0.087	0.649
LTE Band 4	Right Cheek	0.052	0.234	0.055	0.342
	Right Tilted	0.067	0.344	0.117	0.528
	Left Cheek	0.063	0.641	0.060	0.764
	Left Tilted	0.054	0.512	0.087	0.654

FCC SAR Test Report

WWAN Band	Exposure Position	1	2	5	1+2+5 Summed 1g SAR (W/kg)
		WWAN	2.4GHz WLAN Ant 0	5GHz WLAN Ant 1	
		1g SAR (W/kg)	1g SAR (W/kg)	1g SAR (W/kg)	
LTE Band 5	Right Cheek	0.867	0.234	0.055	1.156
	Right Tilted	0.594	0.344	0.117	1.056
	Left Cheek	0.597	0.641	0.060	1.299
	Left Tilted	0.472	0.512	0.087	1.072
LTE Band 7	Right Cheek	0.115	0.234	0.055	0.404
	Right Tilted	0.110	0.344	0.117	0.572
	Left Cheek	0.081	0.641	0.060	0.782
	Left Tilted	0.050	0.512	0.087	0.650
LTE Band 38	Right Cheek	0.066	0.234	0.055	0.355
	Right Tilted	0.067	0.344	0.117	0.528
	Left Cheek	0.052	0.641	0.060	0.753
	Left Tilted	0.028	0.512	0.087	0.628
LTE Band 41	Right Cheek	0.074	0.234	0.055	0.363
	Right Tilted	0.070	0.344	0.117	0.532
	Left Cheek	0.052	0.641	0.060	0.753
	Left Tilted	0.032	0.512	0.087	0.632

FCC SAR Test Report

WWAN Band	Exposure Position	1	2	4	7	1+2 Summed 1g SAR (W/kg)	1+4+7 Summed 1g SAR (W/kg)
		WWAN	2.4GHz WLAN MIMO	5GHz WLAN MIMO	Bluetooth Ant 0		
		1g SAR (W/kg)	1g SAR (W/kg)	1g SAR (W/kg)	1g SAR (W/kg)		
GSM850	Right Cheek	0.755	0.608	0.242	0.044	1.363	1.040
	Right Tilted	0.584	0.521	0.288	0.047	1.105	0.919
	Left Cheek	0.513	0.640	0.578	0.067	1.153	1.158
	Left Tilted	0.411	0.735	0.501	0.119	1.146	1.031
GSM1900	Right Cheek	0.023	0.608	0.242	0.044	0.631	0.308
	Right Tilted	0.014	0.521	0.288	0.047	0.534	0.349
	Left Cheek	0.026	0.640	0.578	0.067	0.667	0.671
	Left Tilted	0.014	0.735	0.501	0.119	0.749	0.634
WCDMA II	Right Cheek	0.068	0.608	0.242	0.044	0.676	0.354
	Right Tilted	0.040	0.521	0.288	0.047	0.560	0.375
	Left Cheek	0.083	0.640	0.578	0.067	0.723	0.728
	Left Tilted	0.045	0.735	0.501	0.119	0.780	0.665
WCDMA IV	Right Cheek	0.064	0.608	0.242	0.044	0.672	0.350
	Right Tilted	0.093	0.521	0.288	0.047	0.614	0.428
	Left Cheek	0.070	0.640	0.578	0.067	0.710	0.715
	Left Tilted	0.068	0.735	0.501	0.119	0.804	0.689
WCDMA V	Right Cheek	0.857	0.608	0.242	0.044	1.465	1.142
	Right Tilted	0.614	0.521	0.288	0.047	1.134	0.949
	Left Cheek	0.619	0.640	0.578	0.067	1.259	1.264
	Left Tilted	0.488	0.735	0.501	0.119	1.223	1.108

FCC SAR Test Report

WWAN Band	Exposure Position	1	2	4	7	1+2 Summed 1g SAR (W/kg)	1+4+7 Summed 1g SAR (W/kg)
		WWAN	2.4GHz WLAN MIMO	5GHz WLAN MIMO	Bluetooth Ant 0		
		1g SAR (W/kg)	1g SAR (W/kg)	1g SAR (W/kg)	1g SAR (W/kg)		
LTE Band 2	Right Cheek	0.060	0.608	0.242	0.044	0.669	0.346
	Right Tilted	0.052	0.521	0.288	0.047	0.573	0.387
	Left Cheek	0.070	0.640	0.578	0.067	0.711	0.716
	Left Tilted	0.049	0.735	0.501	0.119	0.785	0.670
LTE Band 4	Right Cheek	0.052	0.608	0.242	0.044	0.661	0.338
	Right Tilted	0.067	0.521	0.288	0.047	0.587	0.402
	Left Cheek	0.063	0.640	0.578	0.067	0.703	0.708
	Left Tilted	0.054	0.735	0.501	0.119	0.790	0.675
LTE Band 5	Right Cheek	0.867	0.608	0.242	0.044	1.475	1.152
	Right Tilted	0.594	0.521	0.288	0.047	1.115	0.929
	Left Cheek	0.597	0.640	0.578	0.067	1.238	1.243
	Left Tilted	0.472	0.735	0.501	0.119	1.208	1.093
LTE Band 7	Right Cheek	0.115	0.608	0.242	0.044	0.723	0.401
	Right Tilted	0.110	0.521	0.288	0.047	0.631	0.445
	Left Cheek	0.081	0.640	0.578	0.067	0.721	0.726
	Left Tilted	0.050	0.735	0.501	0.119	0.785	0.670
LTE Band 38	Right Cheek	0.066	0.608	0.242	0.044	0.674	0.351
	Right Tilted	0.067	0.521	0.288	0.047	0.587	0.402
	Left Cheek	0.052	0.640	0.578	0.067	0.692	0.697
	Left Tilted	0.028	0.735	0.501	0.119	0.763	0.649
LTE Band 41	Right Cheek	0.074	0.608	0.242	0.044	0.682	0.360
	Right Tilted	0.070	0.521	0.288	0.047	0.591	0.405
	Left Cheek	0.052	0.640	0.578	0.067	0.692	0.697
	Left Tilted	0.032	0.735	0.501	0.119	0.767	0.652

FCC SAR Test Report

<Hotspot Exposure condition>

WWAN Band	Exposure Position	1	2	5	1+2+5 Summed 1g SAR (W/kg)
		WWAN	2.4GHz WLAN Ant 0	5GHz WLAN Ant 1	
		1g SAR (W/kg)	1g SAR (W/kg)	1g SAR (W/kg)	
GSM850	Front	0.202	0.066	0.018	0.287
	Back	0.258	0.134	0.118	0.509
	Left side	0.064	0.009	0.012	0.086
	Right side	0.134	0.020	0.084	0.238
	Top side	0.110	0.120	0.067	0.297
	Bottom side	0.210			0.210
GSM1900	Front	0.260	0.066	0.018	0.344
	Back	0.457	0.134	0.118	0.708
	Left side	0.039	0.009	0.012	0.060
	Right side	0.036	0.020	0.084	0.139
	Top side		0.120	0.067	0.187
	Bottom side	0.720			0.720
WCDMA II	Front	0.763	0.066	0.018	0.848
	Back	0.665	0.134	0.118	0.917
	Left side	0.118	0.009	0.012	0.140
	Right side	0.133	0.020	0.084	0.236
	Top side		0.120	0.067	0.187
	Bottom side	0.970			0.970

WWAN Band	Exposure Position	1	2	5	1+2+5 Summed 1g SAR (W/kg)
		WWAN	2.4GHz WLAN Ant 0	5GHz WLAN Ant 1	
		1g SAR (W/kg)	1g SAR (W/kg)	1g SAR (W/kg)	
WCDMA IV	Front	0.573	0.066	0.018	0.658
	Back	0.520	0.134	0.118	0.772
	Left side	0.108	0.009	0.012	0.130
	Right side	0.127	0.020	0.084	0.230
	Top side		0.120	0.067	0.187
	Bottom side	0.680			0.680
WCDMA V	Front	0.173	0.066	0.018	0.257
	Back	0.276	0.134	0.118	0.528
	Left side	0.072	0.009	0.012	0.094
	Right side	0.164	0.020	0.084	0.268
	Top side	0.140	0.120	0.067	0.327
	Bottom side	0.190			0.190
LTE Band 2	Front	0.660	0.066	0.018	0.745
	Back	0.590	0.134	0.118	0.842
	Left side	0.127	0.009	0.012	0.149
	Right side	0.138	0.020	0.084	0.241
	Top side		0.120	0.067	0.187
	Bottom side	1.040			1.040
LTE Band 4	Front	0.540	0.066	0.018	0.625
	Back	0.490	0.134	0.118	0.742
	Left side	0.101	0.009	0.012	0.123
	Right side	0.120	0.020	0.084	0.224

FCC SAR Test Report

WWAN Band	Exposure Position	1	2	5	1+2+5 Summed 1g SAR (W/kg)
		WWAN	2.4GHz WLAN Ant 0	5GHz WLAN Ant 1	
		1g SAR (W/kg)	1g SAR (W/kg)	1g SAR (W/kg)	
	Top side		0.120	0.067	0.187
	Bottom side	0.650			0.650
LTE Band 5	Front	0.170	0.066	0.018	0.255
	Back	0.240	0.134	0.118	0.492
	Left side	0.080	0.009	0.012	0.102
	Right side	0.160	0.020	0.084	0.264
	Top side	0.130	0.120	0.067	0.317
	Bottom side	0.170			0.170
LTE Band 7	Front	0.840	0.066	0.018	0.925
	Back	0.660	0.134	0.118	0.912
	Left side	0.222	0.009	0.012	0.244
	Right side	0.299	0.020	0.084	0.402
	Top side		0.120	0.067	0.187
	Bottom side	0.960			0.960
LTE Band 38	Front	0.511	0.066	0.018	0.595
	Back	0.634	0.134	0.118	0.885
	Left side	0.127	0.009	0.012	0.149
	Right side	0.180	0.020	0.084	0.284
	Top side		0.120	0.067	0.187
	Bottom side	0.970			0.970
LTE Band 41	Front	0.494	0.066	0.018	0.579
	Back	0.636	0.134	0.118	0.888
	Left side	0.123	0.009	0.012	0.145
	Right side	0.175	0.020	0.084	0.278
	Top side		0.120	0.067	0.187
	Bottom side	0.928			0.928

FCC SAR Test Report

WWAN Band	Exposure Position	1	2	4	7	1+2 Summed 1g SAR (W/kg)	1+4+7 Summed 1g SAR (W/kg)
		WWAN	2.4GHz WLAN MIMO	5GHz WLAN MIMO	Bluetooth Ant 0		
		1g SAR (W/kg)	1g SAR (W/kg)	1g SAR (W/kg)	1g SAR (W/kg)		
GSM850	Front	0.202	0.125	0.070	0.008	0.327	0.281
	Back	0.258	0.195	0.191	0.017	0.453	0.465
	Left side	0.064	0.085	0.010	0.003	0.149	0.077
	Right side	0.134	0.033	0.106	0.055	0.168	0.295
	Top side	0.110	0.110	0.122	0.020	0.220	0.252
	Bottom side	0.210				0.210	0.210
GSM1900	Front	0.260	0.125	0.070	0.008	0.385	0.338
	Back	0.457	0.195	0.191	0.017	0.652	0.664
	Left side	0.039	0.085	0.010	0.003	0.123	0.052
	Right side	0.036	0.033	0.106	0.055	0.069	0.197
	Top side		0.110	0.122	0.020	0.110	0.142
	Bottom side	0.720				0.720	0.720
WCDMA II	Front	0.763	0.125	0.070	0.008	0.888	0.841
	Back	0.665	0.195	0.191	0.017	0.861	0.873
	Left side	0.118	0.085	0.010	0.003	0.203	0.131
	Right side	0.133	0.033	0.106	0.055	0.166	0.294
	Top side		0.110	0.122	0.020	0.110	0.142
	Bottom side	0.970				0.970	0.970
WCDMA IV	Front	0.573	0.125	0.070	0.008	0.698	0.652
	Back	0.520	0.195	0.191	0.017	0.716	0.728
	Left side	0.108	0.085	0.010	0.003	0.193	0.121
	Right side	0.127	0.033	0.106	0.055	0.160	0.288
	Top side		0.110	0.122	0.020	0.110	0.142
	Bottom side	0.680				0.680	0.680
WCDMA V	Front	0.173	0.125	0.070	0.008	0.298	0.251
	Back	0.276	0.195	0.191	0.017	0.472	0.484
	Left side	0.072	0.085	0.010	0.003	0.156	0.085
	Right side	0.164	0.033	0.106	0.055	0.198	0.325
	Top side	0.140	0.110	0.122	0.020	0.250	0.282
	Bottom side	0.190				0.190	0.190
LTE Band 2	Front	0.660	0.125	0.070	0.008	0.785	0.738
	Back	0.590	0.195	0.191	0.017	0.785	0.797
	Left side	0.127	0.085	0.010	0.003	0.212	0.140
	Right side	0.138	0.033	0.106	0.055	0.171	0.299
	Top side		0.110	0.122	0.020	0.110	0.142
	Bottom side	1.040				1.040	1.040

FCC SAR Test Report

WWAN Band	Exposure Position	1	2	4	7	1+2 Summed 1g SAR (W/kg)	1+4+7 Summed 1g SAR (W/kg)
		WWAN	2.4GHz WLAN MIMO	5GHz WLAN MIMO	Bluetooth Ant 0		
		1g SAR (W/kg)	1g SAR (W/kg)	1g SAR (W/kg)	1g SAR (W/kg)		
LTE Band 4	Front	0.540	0.125	0.070	0.008	0.665	0.618
	Back	0.490	0.195	0.191	0.017	0.685	0.697
	Left side	0.101	0.085	0.010	0.003	0.185	0.114
	Right side	0.120	0.033	0.106	0.055	0.153	0.281
	Top side		0.110	0.122	0.020	0.110	0.142
	Bottom side	0.650				0.650	0.650
LTE Band 5	Front	0.170	0.125	0.070	0.008	0.295	0.248
	Back	0.240	0.195	0.191	0.017	0.435	0.447
	Left side	0.080	0.085	0.010	0.003	0.165	0.093
	Right side	0.160	0.033	0.106	0.055	0.193	0.321
	Top side	0.130	0.110	0.122	0.020	0.240	0.272
	Bottom side	0.170				0.170	0.170
LTE Band 7	Front	0.840	0.125	0.070	0.008	0.965	0.918
	Back	0.660	0.195	0.191	0.017	0.855	0.867
	Left side	0.222	0.085	0.010	0.003	0.306	0.235
	Right side	0.299	0.033	0.106	0.055	0.332	0.460
	Top side		0.110	0.122	0.020	0.110	0.142
	Bottom side	0.960				0.960	0.960
LTE Band 38	Front	0.511	0.125	0.070	0.008	0.636	0.589
	Back	0.634	0.195	0.191	0.017	0.829	0.841
	Left side	0.127	0.085	0.010	0.003	0.211	0.140
	Right side	0.180	0.033	0.106	0.055	0.214	0.341
	Top side		0.110	0.122	0.020	0.110	0.142
	Bottom side	0.970				0.970	0.970
LTE Band 41	Front	0.494	0.125	0.070	0.008	0.619	0.573
	Back	0.636	0.195	0.191	0.017	0.831	0.843
	Left side	0.123	0.085	0.010	0.003	0.207	0.136
	Right side	0.175	0.033	0.106	0.055	0.208	0.336
	Top side		0.110	0.122	0.020	0.110	0.142
	Bottom side	0.928				0.928	0.928

FCC SAR Test Report

<Body Worn Exposure condition>

WWAN Band	Exposure Position	1	2	5	1+2+5 Summed 1g SAR (W/kg)
		WWAN	2.4GHz WLAN Ant 0	5GHz WLAN Ant 1	
		1g SAR (W/kg)	1g SAR (W/kg)	1g SAR (W/kg)	
GSM850	Front	0.110	0.040	0.015	0.165
	Back	0.120	0.057	0.073	0.250
GSM1900	Front	0.133	0.040	0.015	0.188
	Back	0.227	0.057	0.073	0.357
WCDMA II	Front	0.403	0.040	0.015	0.458
	Back	0.710	0.057	0.073	0.840
WCDMA IV	Front	0.298	0.040	0.015	0.353
	Back	0.274	0.057	0.073	0.404

FCC SAR Test Report

WWAN Band	Exposure Position	1	2	5	1+2+5 Summed 1g SAR (W/kg)
		WWAN	2.4GHz WLAN Ant 0	5GHz WLAN Ant 1	
		1g SAR (W/kg)	1g SAR (W/kg)	1g SAR (W/kg)	
WCDMA V	Front	0.121	0.040	0.015	0.177
	Back	0.149	0.057	0.073	0.279
LTE Band 2	Front	0.335	0.040	0.015	0.391
	Back	0.296	0.057	0.073	0.426
LTE Band 4	Front	0.280	0.040	0.015	0.335
	Back	0.250	0.057	0.073	0.380
LTE Band 5	Front	0.127	0.040	0.015	0.183
	Back	0.154	0.057	0.073	0.284
LTE Band 7	Front	0.470	0.040	0.015	0.525
	Back	0.360	0.057	0.073	0.490
LTE Band 38	Front	0.289	0.040	0.015	0.344
	Back	0.350	0.057	0.073	0.480
LTE Band 41	Front	0.302	0.040	0.015	0.357
	Back	0.378	0.057	0.073	0.508

WWAN Band	Exposure Position	1	2	4	7	1+2 Summed 1g SAR (W/kg)	1+4+7 Summed 1g SAR (W/kg)
		WWAN	2.4GHz WLAN MIMO	5GHz WLAN MIMO	Bluetooth Ant 0		
		1g SAR (W/kg)	1g SAR (W/kg)	1g SAR (W/kg)	1g SAR (W/kg)		
GSM850	Front	0.110	0.072	0.039	0.005	0.182	0.154
	Back	0.120	0.106	0.089	0.007	0.226	0.216
GSM1900	Front	0.133	0.072	0.039	0.005	0.205	0.178
	Back	0.227	0.106	0.089	0.007	0.333	0.323
WCDMA II	Front	0.403	0.072	0.039	0.005	0.475	0.448
	Back	0.710	0.106	0.089	0.007	0.816	0.806
WCDMA IV	Front	0.298	0.072	0.039	0.005	0.370	0.343
	Back	0.274	0.106	0.089	0.007	0.380	0.370
WCDMA V	Front	0.121	0.072	0.039	0.005	0.194	0.166
	Back	0.149	0.106	0.089	0.007	0.255	0.245
LTE Band 2	Front	0.335	0.072	0.039	0.005	0.407	0.380
	Back	0.296	0.106	0.089	0.007	0.403	0.393
LTE Band 4	Front	0.280	0.072	0.039	0.005	0.352	0.324
	Back	0.250	0.106	0.089	0.007	0.356	0.346
LTE Band 5	Front	0.127	0.072	0.039	0.005	0.200	0.172
	Back	0.154	0.106	0.089	0.007	0.261	0.251
LTE Band 7	Front	0.470	0.072	0.039	0.005	0.542	0.514
	Back	0.360	0.106	0.089	0.007	0.466	0.456
LTE Band 38	Front	0.289	0.072	0.039	0.005	0.361	0.333
	Back	0.350	0.106	0.089	0.007	0.456	0.446

FCC SAR Test Report

WWAN Band	Exposure Position	1	2	4	7	1+2 Summed 1g SAR (W/kg)	1+4+7 Summed 1g SAR (W/kg)
		WWAN	2.4GHz WLAN MIMO	5GHz WLAN MIMO	Bluetooth Ant 0		
		1g SAR (W/kg)	1g SAR (W/kg)	1g SAR (W/kg)	1g SAR (W/kg)		
LTE Band 41	Front	0.302	0.072	0.039	0.005	0.374	0.347
	Back	0.378	0.106	0.089	0.007	0.484	0.474

<Extremity Exposure condition>

WWAN Band	Exposure Position	1	5	1+5 Summed 1g SAR (W/kg)
		WWAN	5GHz WLAN Ant 1	
		10g SAR (W/kg)	10g SAR (W/kg)	
WCDMA II	Back	1.666	0.397	2.063
	Bottom side	2.494		2.494
WCDMA IV	Bottom side	2.467		2.467
LTE Band 2	Back	1.778	0.397	2.175
	Bottom side	2.633		2.633
LTE Band 4	Bottom side	2.267		2.267
LTE Band 7	Back	2.087	0.397	2.484
	Bottom side	0.979		0.979
LTE Band 38	Bottom side	0.832		0.832
LTE Band 41	Bottom side	0.874		0.874

WWAN Band	Exposure Position	1	4	1+4 Summed 1g SAR (W/kg)
		WWAN	5GHz WLAN MIMO	
		1g SAR (W/kg)	1g SAR (W/kg)	
WCDMA II	Back	1.666	0.412	2.078
	Bottom side	2.494		2.494
WCDMA IV	Bottom side	2.467		2.467
LTE Band 2	Back	1.778	0.412	2.494
	Bottom side	2.633		2.633
LTE Band 4	Bottom side	2.267		2.267
LTE Band 7	Back	2.087	0.412	2.499
	Bottom side	0.979		0.979
LTE Band 38	Bottom side	0.832		0.832
LTE Band 41	Bottom side	0.874		0.874

Test Engineer : Dennis Ye, and Jace Hu

5. Calibration of Test Equipment

Equipment	Manufacturer	Model	SN	Cal. Date	Cal. Interval
System Validation Dipole	SPEAG	D835V2	4d139	Sep. 03, 2019	1 Year
System Validation Dipole	SPEAG	D1750V2	1071	Aug. 30, 2019	1 Year
System Validation Dipole	SPEAG	D1900V2	5d159	Sep. 02, 2019	1 Year
System Validation Dipole	SPEAG	D2450V2	893	Sep. 04, 2019	1 Year
System Validation Dipole	SPEAG	D2600V2	1110	Sep. 05, 2019	1 Year
System Validation Dipole	SPEAG	D5GHzV2	1133	Aug. 27, 2019	1 Year
Dosimetric E-Field Probe	SPEAG	EX3DV4	3783	Aug. 30, 2019	1 Year
Data Acquisition Electronics	SPEAG	DAE4	1341	Aug. 28, 2019	1 Year
Dosimetric E-Field Probe	SPEAG	EX3DV4	7554	Sep. 16, 2019	1 Year
Data Acquisition Electronics	SPEAG	DAE4	1589	Sep. 10, 2019	1 Year
Radio Communication Analyzer	ANRITSU	MT8820C	6201300717	Jun. 24, 2019	1 Year
Wireless Communication Test Set	Agilent	E5515C	MY50260600	Jul. 26, 2019	1 Year
ENA Series Network Analyzer	Agilent	E5071C	MY46214638	Jun. 24, 2019	1 Year
Spectrum Analyzer	KEYSIGHT	N9010A	MY54510355	Jul. 26, 2019	1Year
MXG Analog Signal Generator	KEYSIGHT	N5183A	MY50143024	Mar. 27, 2019	1 Year
Power Meter	Agilent	N1914A	MY52180044	Oct. 10, 2018	2 Years
Power Sensor	Agilent	E9304A H18	MY52050011	Aug. 21, 2019	1 Year
Power Meter	ANRITSU	ML2495A	1506002	Jul. 26, 2019	1 Year
Power Sensor	ANRITSU	MA2411B	1339353	Aug. 26, 2019	1 Year
Temp. & Humi. Recorder	CLOCK	HTC-1	157248	Jun. 27, 2019	1 Year
Electronic Thermometer	YONGFA	YF-160A	120100323	Aug. 29, 2019	1 Year
Coupler	Woken	0110A056020-10	COM27RW1A3	Aug. 30, 2019	1 Year

6. Measurement Uncertainty

According to KDB 865664 D01, SAR measurement uncertainty analysis is required in SAR reports only when the highest measured SAR in a frequency band is ≥ 1.5 W/kg for 1-g SAR, and ≥ 3.75 W/kg for 10-g SAR. The procedures described in IEEE Std 1528-2013 should be applied. The expanded SAR measurement uncertainty must be $\leq 30\%$, for a confidence interval of $k = 2$. When the highest measured SAR within a frequency band is < 1.5 W/kg for 1-g and < 3.75 W/kg for 10-g, the extensive SAR measurement uncertainty analysis described in IEEE Std 1528-2013 is not required in SAR reports submitted for equipment approval. Hence, the measurement uncertainty analysis is not required in this SAR report because the test result met the condition.

7. Information on the Testing Laboratories

We, BV 7LAYERS COMMUNICATIONS TECHNOLOGY (SHENZHEN) CO. LTD., were founded in 2015 to provide our best service in EMC, Radio, Telecom and Safety consultation. Our laboratories are accredited and approved according to ISO/IEC 17025.

If you have any comments, please feel free to contact us at the following:

Add: No. B102, Dazu Chuangxin Mansion, North of Beihuan Avenue, North Area, Hi-Tech Industry Park, Nanshan District, Shenzhen, Guangdong, China

Tel: 86-755-8869-6566

Fax: 86-755-8869-6577

Email: customerservice.dg@cn.bureauveritas.com

Web Site: www.bureauveritas.com

The road map of all our labs can be found in our web site also.

---END---

Appendix A. SAR Plots of System Verification

The plots for system verification with largest deviation for each SAR system combination are shown as follows.

System Check_HSL835_200317

DUT: Dipole:835 MHz;Type:D835V2

Communication System: CW; Frequency: 835 MHz;Duty Cycle: 1:1

Medium: HSL835_0317 Medium parameters used: $f = 835 \text{ MHz}$; $\sigma = 0.9 \text{ S/m}$; $\epsilon_r = 40.574$; $\rho = 1000 \text{ kg/m}^3$

Ambient Temperature : 23.5°C ; Liquid Temperature : 22.3°C

DASY5 Configuration:

- Probe: EX3DV4 - SN3873; ConvF(9.59, 9.59, 9.59); Calibrated: 2019/08/30;
- Sensor-Surface: 1.4mm (Mechanical Surface Detection)
- Electronics: DAE4 Sn1341; Calibrated: 2019/08/28
- Phantom: Front Phantom with CRP v5.0; Type: QD000P40CD; Serial: TP:1695
- Measurement SW: DASY52, Version 52.8 (8); SEMCAD X Version 14.6.10 (7331)

Pin=250mW/Area Scan (71x121x1): Interpolated grid: $dx=1.500 \text{ mm}$, $dy=1.500 \text{ mm}$
Maximum value of SAR (interpolated) = 3.23 W/kg

Pin=250mW/Zoom Scan (5x5x7)/Cube 0: Measurement grid: $dx=8\text{mm}$, $dy=8\text{mm}$, $dz=5\text{mm}$
Reference Value = 59.72 V/m ; Power Drift = -0.07 dB
Peak SAR (extrapolated) = 3.64 W/kg
SAR(1 g) = 2.46 W/kg ; SAR(10 g) = 1.62 W/kg
Maximum value of SAR (measured) = 3.27 W/kg

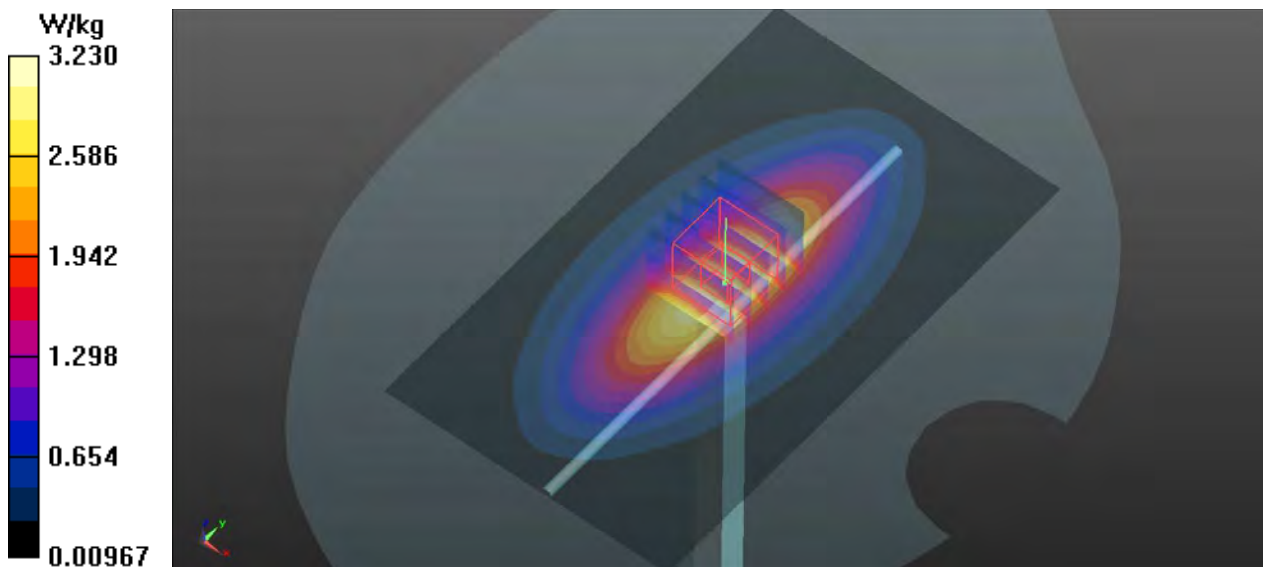

System Check_HSL1750_200319

DUT: Dipole:1750 MHz;Type:D1750V2

Communication System: CW; Frequency: 1750 MHz;Duty Cycle: 1:1

Medium: HSL1750_0319 Medium parameters used: $f = 1750$ MHz; $\sigma = 1.384$ S/m; $\epsilon_r = 38.512$; $\rho = 1000$ kg/m³

Ambient Temperature : 23.2°C; Liquid Temperature : 22.1°C

DASY5 Configuration:

- Probe: EX3DV4 - SN3873; ConvF(8.25, 8.25, 8.25); Calibrated: 2019/08/30;
- Sensor-Surface: 1.4mm (Mechanical Surface Detection)
- Electronics: DAE4 Sn1341; Calibrated: 2019/08/28
- Phantom: Front Phantom with CRP v5.0; Type: QD000P40CD; Serial: TP:1695
- Measurement SW: DASY52, Version 52.8 (8); SEMCAD X Version 14.6.10 (7331)

Pin=250mW/Area Scan (71x81x1): Interpolated grid: dx=1.500 mm, dy=1.500 mm
Maximum value of SAR (interpolated) = 14.2 W/kg

Pin=250mW/Zoom Scan (5x5x7)/Cube 0: Measurement grid: dx=8mm, dy=8mm, dz=5mm
Reference Value = 100.5 V/m; Power Drift = 0.02 dB
Peak SAR (extrapolated) = 17.1 W/kg
SAR(1 g) = 9.55 W/kg; SAR(10 g) = 5.16 W/kg
Maximum value of SAR (measured) = 14.4 W/kg

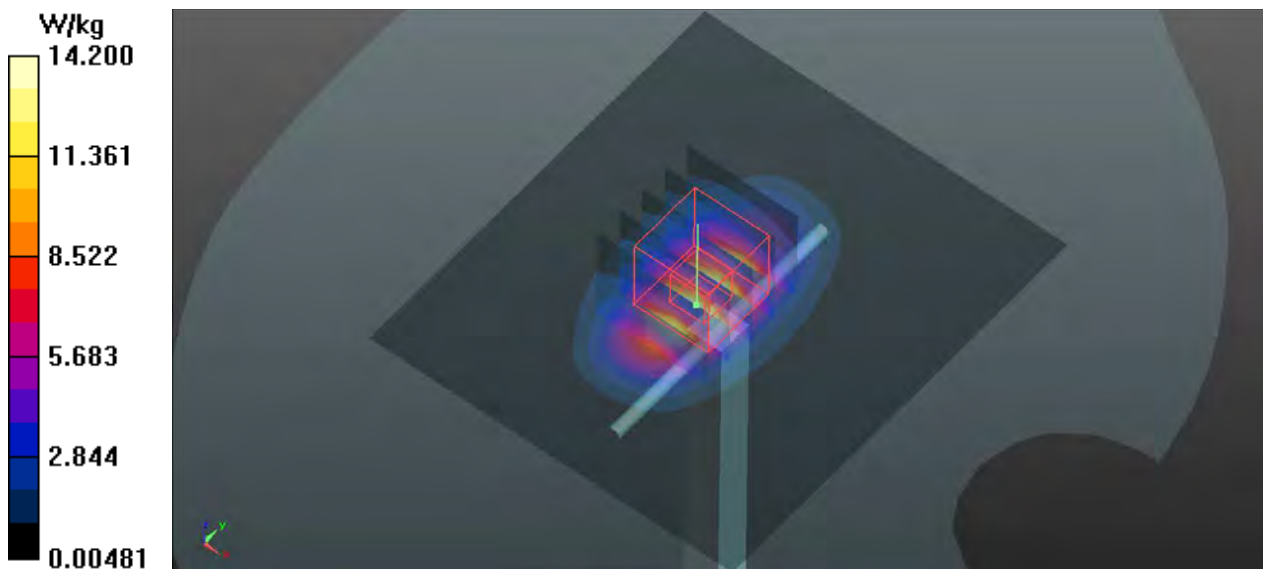

System Check_HSL1900_200321

DUT: Dipole:1900MHz;Type:D1900V2

Communication System: CW; Frequency: 1900 MHz;Duty Cycle: 1:1

Medium: HSL1900_0321 Medium parameters used: $f = 1900$ MHz; $\sigma = 1.443$ S/m; $\epsilon_r = 40.23$; $\rho = 1000$ kg/m³

Ambient Temperature : 23.6°C; Liquid Temperature : 22.2°C

DASY5 Configuration:

- Probe: EX3DV4 - SN3873; ConvF(7.96, 7.96, 7.96); Calibrated: 2019/08/30;
- Sensor-Surface: 1.4mm (Mechanical Surface Detection)
- Electronics: DAE4 Sn1341; Calibrated: 2019/08/28
- Phantom: Front Phantom with CRP v5.0; Type: QD000P40CD; Serial: TP:1695
- Measurement SW: DASY52, Version 52.8 (8); SEMCAD X Version 14.6.10 (7331)

Pin=250mW/Area Scan (71x81x1): Interpolated grid: dx=1.500 mm, dy=1.500 mm

Maximum value of SAR (interpolated) = 15.4 W/kg

Pin=250mW/Zoom Scan (5x5x7)/Cube 0: Measurement grid: dx=8mm, dy=8mm, dz=5mm

Reference Value = 98.48 V/m; Power Drift = 0.07 dB

Peak SAR (extrapolated) = 18.64 W/kg

SAR(1 g) = 10.2 W/kg; SAR(10 g) = 5.35 W/kg

Maximum value of SAR (measured) = 15.7 W/kg

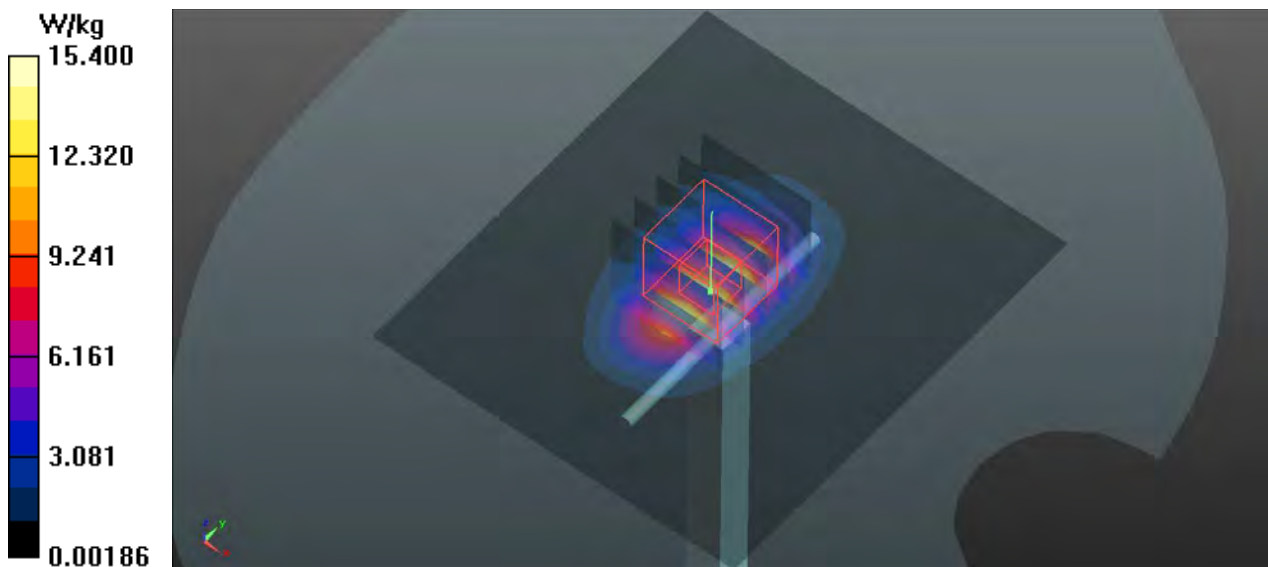

System Check_HSL2450_200317

DUT: Dipole:2450 MHz;Type:D2450V2

Communication System: CW; Frequency: 2450 MHz;Duty Cycle: 1:1

Medium: HSL2450_0317 Medium parameters used: $f = 2450$ MHz; $\sigma = 1.845$ S/m; $\epsilon_r = 39.406$; $\rho = 1000$ kg/m³

Ambient Temperature : 23.1°C; Liquid Temperature : 22.5°C

DASY5 Configuration:

- Probe: EX3DV4 - SN7554; ConvF(7.37, 7.37, 7.37) @ 2450 MHz; Calibrated: 9/16/2019
- Sensor-Surface: 1.4mm (Mechanical Surface Detection)
- Electronics: DAE4 Sn1589; Calibrated: 9/10/2019
- Phantom: Twin-SAM (Right SAM2); Type: QD 000 P41 AA; Serial: 1986
- Measurement SW: DASY52, Version 52.10 (2); SEMCAD X Version 14.6.12 (7470)

Pin=250mW/Area Scan (91x101x1): Interpolated grid: dx=1.200 mm, dy=1.200 mm
Maximum value of SAR (interpolated) = 22.4 W/kg

Pin=250mW/Zoom Scan (7x7x7)/Cube 0: Measurement grid: dx=5mm, dy=5mm, dz=5mm
Reference Value = 112.5 V/m; Power Drift = -0.05 dB
Peak SAR (extrapolated) = 28.0 W/kg
SAR(1 g) = 13.1 W/kg; SAR(10 g) = 6.08 W/kg
Maximum value of SAR (measured) = 22.3 W/kg

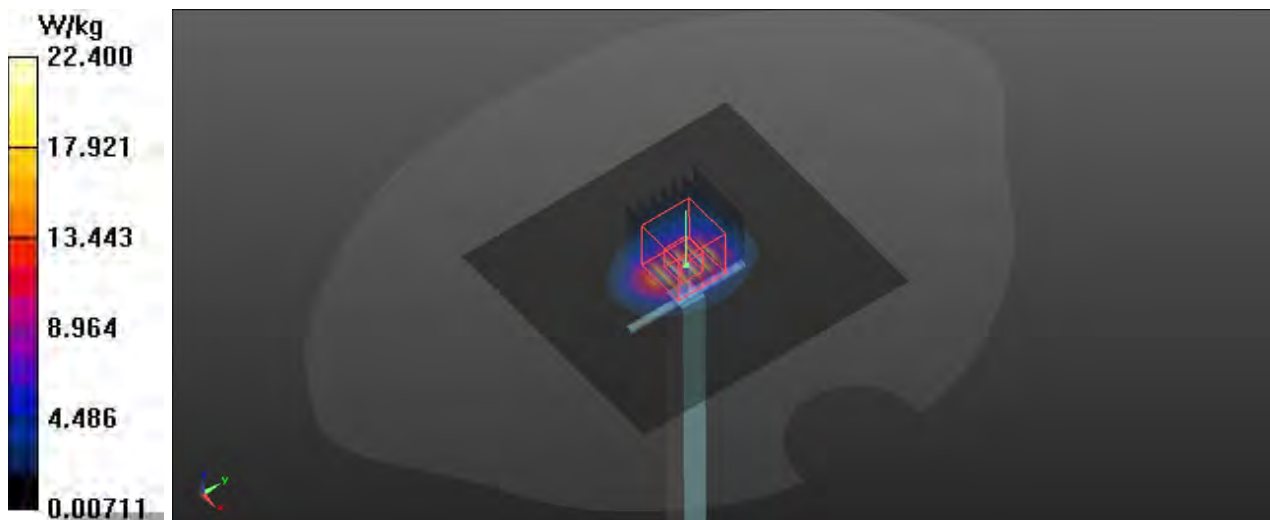

System Check_HSL2600_200323

DUT: Dipole:2600 MHz;Type:D2600V2

Communication System: CW; Frequency: 2600 MHz;Duty Cycle: 1:1

Medium: HSL2600_0323 Medium parameters used: $f = 2600$ MHz; $\sigma = 2.039$ S/m; $\epsilon_r = 38.932$; $\rho = 1000$ kg/m³

Ambient Temperature : 23.4°C; Liquid Temperature : 22.5°C

DASY5 Configuration:

- Probe: EX3DV4 - SN3873; ConvF(7.12, 7.12, 7.12); Calibrated: 2019/08/30;
- Sensor-Surface: 1.4mm (Mechanical Surface Detection)
- Electronics: DAE4 Sn1341; Calibrated: 2019/08/28
- Phantom: Front Phantom with CRP v5.0; Type: QD000P40CD; Serial: TP:1695
- Measurement SW: DASY52, Version 52.8 (8); SEMCAD X Version 14.6.10 (7331)

Pin=250mW/Area Scan (81x101x1): Interpolated grid: dx=1.200 mm, dy=1.200 mm

Maximum value of SAR (interpolated) = 24.2 W/kg

Pin=250mW/Zoom Scan (7x7x7)/Cube 0: Measurement grid: dx=5mm, dy=5mm, dz=5mm

Reference Value = 110.3 V/m; Power Drift = 0.15 dB

Peak SAR (extrapolated) = 31.12 W/kg

SAR(1 g) = 14 W/kg; SAR(10 g) = 6.13 W/kg

Maximum value of SAR (measured) = 24.6 W/kg

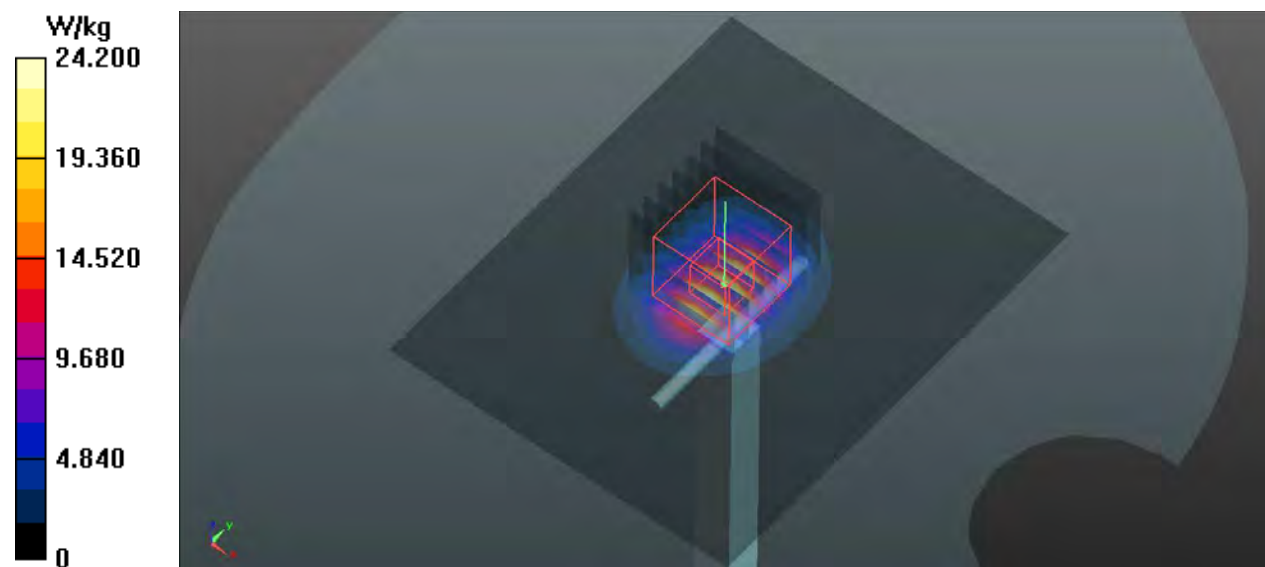

System Check_HSL5250_200321

DUT: Dipole 5GHzV2; Type:D5GHzV2

Communication System: CW; Frequency: 5250 MHz; Duty Cycle: 1:1

Medium: HSL5G_0321 Medium parameters used: $f = 5250$ MHz; $\sigma = 4.725$ S/m; $\epsilon_r = 37.313$; $\rho = 1000$ kg/m³

Ambient Temperature : 23.2°C; Liquid Temperature : 22.2°C

DASY5 Configuration:

- Probe: EX3DV4 - SN7554; ConvF(5.11, 5.11, 5.11) @ 5250 MHz; Calibrated: 9/16/2019
- Sensor-Surface: 1.4mm (Mechanical Surface Detection)
- Electronics: DAE4 Sn1589; Calibrated: 9/10/2019
- Phantom: Twin-SAM (Right SAM2); Type: QD 000 P41 AA; Serial: 1986
- Measurement SW: DASY52, Version 52.10 (2); SEMCAD X Version 14.6.12 (7470)

Pin=100mW/Area Scan (91x91x1): Interpolated grid: dx=1.000 mm, dy=1.000 mm
 Maximum value of SAR (interpolated) = 19.4 W/kg

Pin=100mW/Zoom Scan (7x7x11)/Cube 0: Measurement grid: dx=4mm, dy=4mm, dz=2mm
 Reference Value = 64.07 V/m; Power Drift = -0.07 dB
 Peak SAR (extrapolated) = 33.8 W/kg
SAR(1 g) = 8.34 W/kg; SAR(10 g) = 2.4 W/kg
 Maximum value of SAR (measured) = 21.0 W/kg

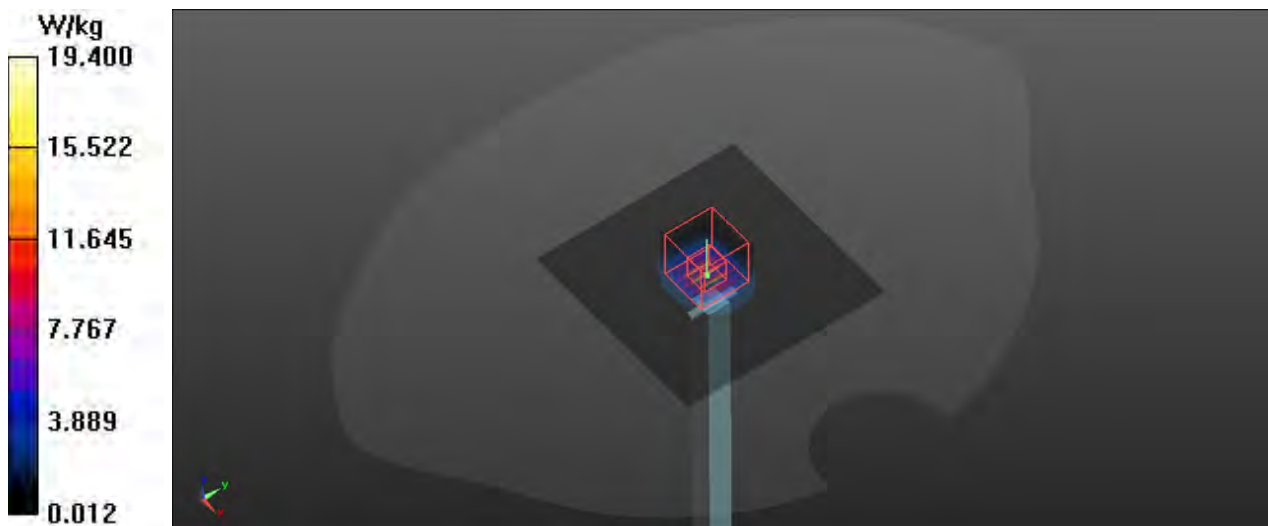

System Check_HSL5600_200326

DUT: Dipole 5GHzV2; Type:D5GHzV2

Communication System: CW; Frequency: 5600 MHz; Duty Cycle: 1:1

Medium: HSL5G_0326 Medium parameters used: $f = 5600$ MHz; $\sigma = 5.066$ S/m; $\epsilon_r = 36.835$; $\rho = 1000$ kg/m³

Ambient Temperature : 23.7°C; Liquid Temperature : 22.6°C

DASY5 Configuration:

- Probe: EX3DV4 - SN7554; ConvF(4.66, 4.66, 4.66) @ 5600 MHz; Calibrated: 9/16/2019
- Sensor-Surface: 1.4mm (Mechanical Surface Detection)
- Electronics: DAE4 Sn1589; Calibrated: 9/10/2019
- Phantom: Twin-SAM (Right SAM2); Type: QD 000 P41 AA; Serial: 1986
- Measurement SW: DASY52, Version 52.10 (2); SEMCAD X Version 14.6.12 (7470)

Pin=100mW/Area Scan (91x91x1): Interpolated grid: dx=1.000 mm, dy=1.000 mm
Maximum value of SAR (interpolated) = 22.4 W/kg

Pin=100mW/Zoom Scan (7x7x11)/Cube 0: Measurement grid: dx=4mm, dy=4mm, dz=2mm
Reference Value = 65.53 V/m; Power Drift = -0.04 dB
Peak SAR (extrapolated) = 40.0 W/kg
SAR(1 g) = 9.04 W/kg; SAR(10 g) = 2.58 W/kg
Maximum value of SAR (measured) = 23.4 W/kg

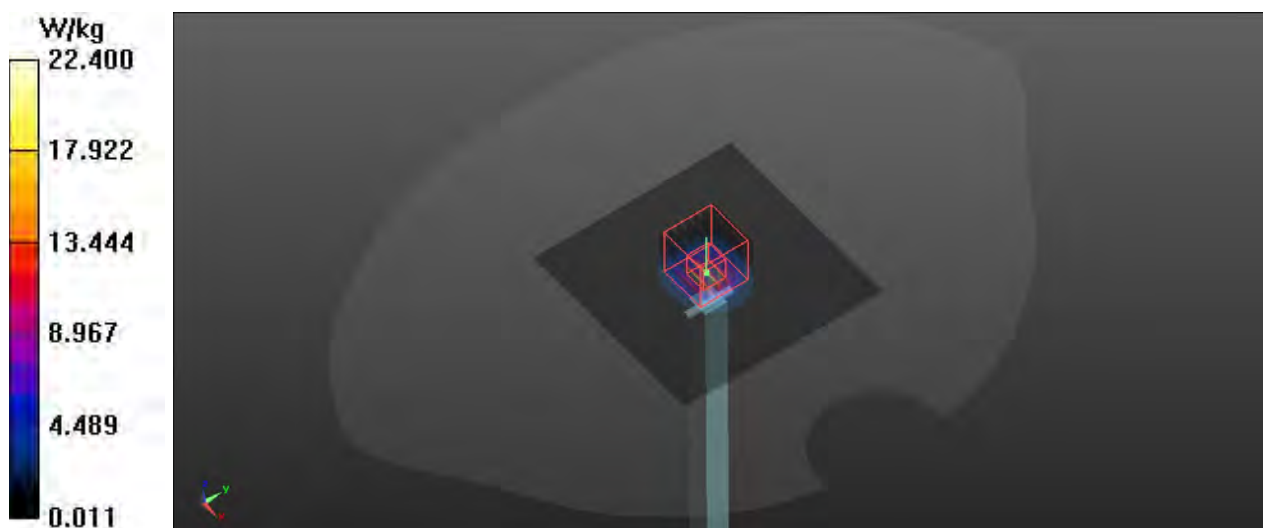

System Check_HSL5800_200328

DUT: Dipole 5GHzV2; Type: D5GHzV2

Communication System: CW; Frequency: 5800 MHz; Duty Cycle: 1:1

Medium: HSL5G_0328 Medium parameters used: $f = 5800$ MHz; $\sigma = 5.27$ S/m; $\epsilon_r = 36.569$; $\rho = 1000$ kg/m³

Ambient Temperature : 23.4°C; Liquid Temperature : 22.3°C

DASY5 Configuration:

- Probe: EX3DV4 - SN7554; ConvF(4.81, 4.81, 4.81) @ 5800 MHz; Calibrated: 9/16/2019
- Sensor-Surface: 1.4mm (Mechanical Surface Detection)
- Electronics: DAE4 Sn1589; Calibrated: 9/10/2019
- Phantom: Twin-SAM (Right SAM2); Type: QD 000 P41 AA; Serial: 1986
- Measurement SW: DASY52, Version 52.10 (2); SEMCAD X Version 14.6.12 (7470)

Pin=100mW/Area Scan (91x91x1): Interpolated grid: dx=1.000 mm, dy=1.000 mm
Maximum value of SAR (interpolated) = 19.3 W/kg

Pin=100mW/Zoom Scan (7x7x11)/Cube 0: Measurement grid: dx=4mm, dy=4mm, dz=2mm
Reference Value = 59.86 V/m; Power Drift = -0.08 dB
Peak SAR (extrapolated) = 36.8 W/kg
SAR(1 g) = 7.96 W/kg; SAR(10 g) = 2.26 W/kg
Maximum value of SAR (measured) = 20.9 W/kg

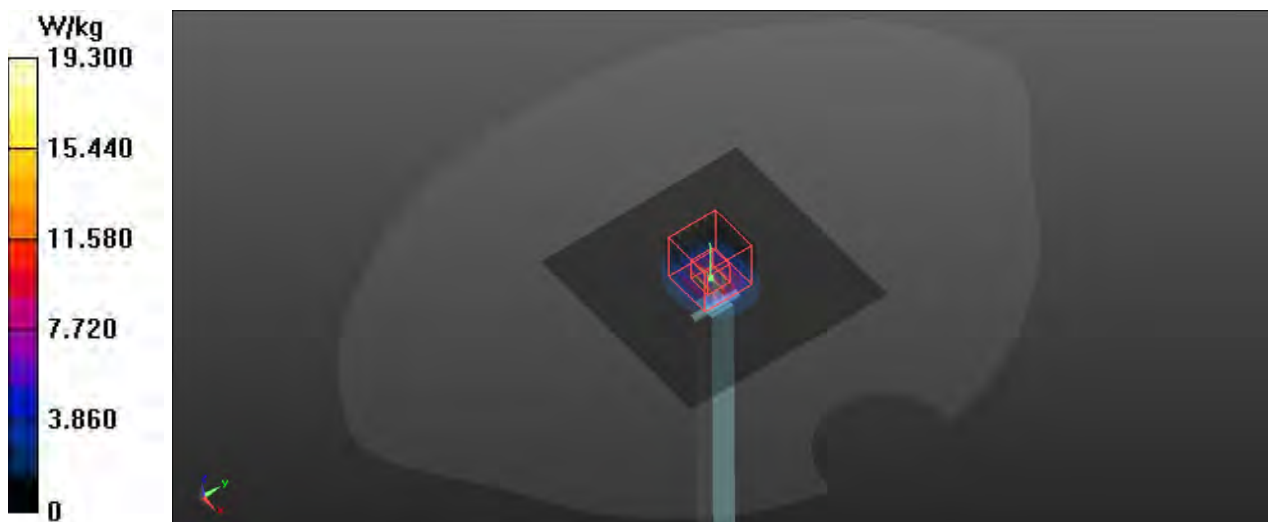

Appendix B. SAR Plots of SAR Measurement

The SAR plots for highest measured SAR in each exposure configuration, wireless mode and frequency band combination, and measured SAR > 1.5 W/kg are shown as follows.

P01 GSM850_GPRS10_Right Cheek_Ch251_Ant 1

DUT: 200304W004

Communication System: GPRS10; Frequency: 848.8 MHz; Duty Cycle: 1:4.15

Medium: HSL835_0317 Medium parameters used: $f = 849$ MHz; $\sigma = 0.906$ S/m; $\epsilon_r = 40.46$; $\rho = 1000$ kg/m³

Ambient Temperature : 23.5°C; Liquid Temperature : 22.3°C

DASY5 Configuration:

- Probe: EX3DV4 - SN3873; ConvF(9.59, 9.59, 9.59); Calibrated: 2019/08/30;
- Sensor-Surface: 1.4mm (Mechanical Surface Detection)
- Electronics: DAE4 Sn1341; Calibrated: 2019/08/28
- Phantom: Front Phantom with CRP v5.0; Type: QD000P40CD; Serial: TP:1695
- Measurement SW: DASY52, Version 52.8 (8); SEMCAD X Version 14.6.10 (7331)

- **Area Scan (81x131x1):** Interpolated grid: dx=1.500 mm, dy=1.500 mm

Maximum value of SAR (interpolated) = 1.10 W/kg

- **Zoom Scan (5x5x7)/Cube 0:** Measurement grid: dx=8mm, dy=8mm, dz=5mm

Reference Value = 22.14 V/m; Power Drift = -0.01 dB

Peak SAR (extrapolated) = 1.29 W/kg

SAR(1 g) = 0.612 W/kg; SAR(10 g) = 0.365 W/kg

Maximum value of SAR (measured) = 0.939 W/kg

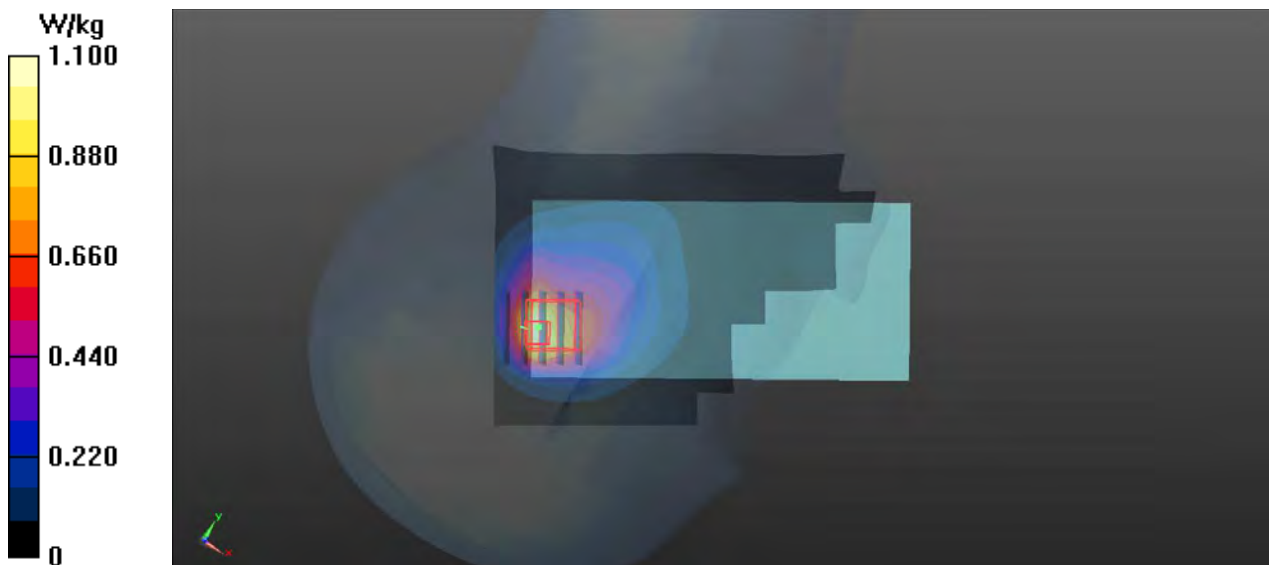

P02 GSM1900_GPRS12_Left Cheek_Ch810_Ant 0

DUT: 200304W004

Communication System: GPRS12; Frequency: 1909.8 MHz; Duty Cycle: 1:2.08

Medium: HSL1900_0321 Medium parameters used: $f = 1910$ MHz; $\sigma = 1.454$ S/m; $\epsilon_r = 40.209$; $\rho = 1000$ kg/m³

Ambient Temperature : 23.6°C; Liquid Temperature : 22.2°C

DASY5 Configuration:

- Probe: EX3DV4 - SN3873; ConvF(7.96, 7.96, 7.96); Calibrated: 2019/08/30;
- Sensor-Surface: 1.4mm (Mechanical Surface Detection)
- Electronics: DAE4 Sn1341; Calibrated: 2019/08/28
- Phantom: Front Phantom with CRP v5.0; Type: QD000P40CD; Serial: TP:1695
- Measurement SW: DASY52, Version 52.8 (8); SEMCAD X Version 14.6.10 (7331)

- **Area Scan (81x131x1):** Interpolated grid: dx=1.500 mm, dy=1.500 mm

Maximum value of SAR (interpolated) = 0.0330 W/kg

- **Zoom Scan (5x5x7)/Cube 0:** Measurement grid: dx=8mm, dy=8mm, dz=5mm

Reference Value = 2.126 V/m; Power Drift = 0.05 dB

Peak SAR (extrapolated) = 0.0380 W/kg

SAR(1 g) = 0.023 W/kg; SAR(10 g) = 0.014 W/kg

Maximum value of SAR (measured) = 0.0325 W/kg

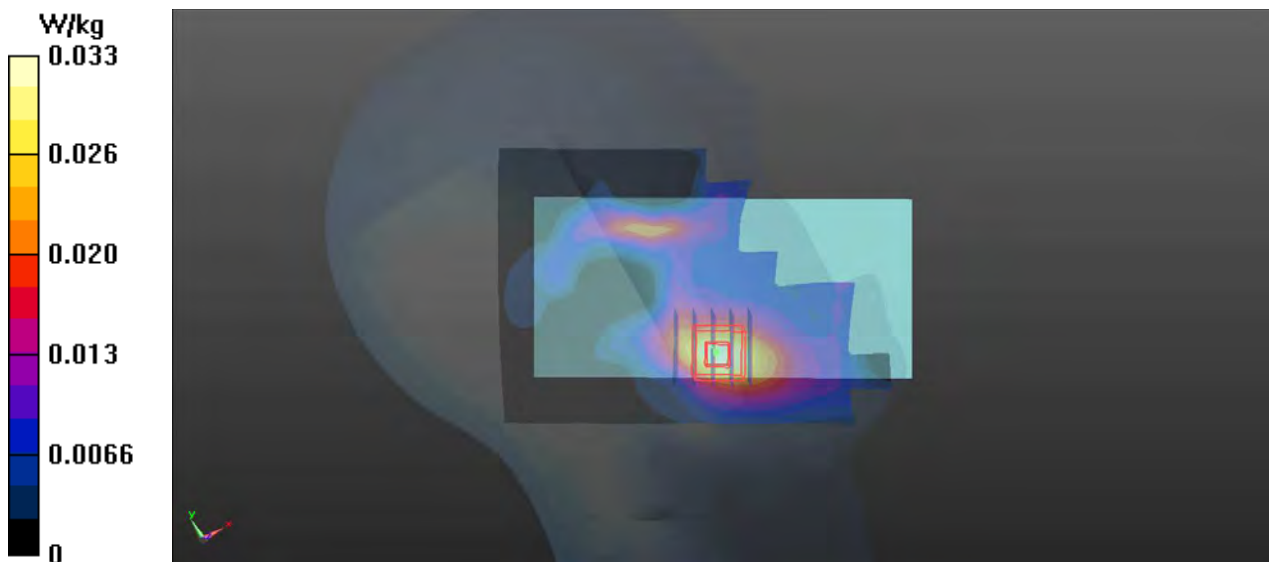

P03 WCDMA II_RMC12.2K_Left Cheek_Ant 0

DUT: 200304W004

Communication System: WCDMA; Frequency: 1907.6 MHz; Duty Cycle: 1:1

Medium: HSL1900_0321 Medium parameters used: $f = 1908$ MHz; $\sigma = 1.452$ S/m; $\epsilon_r = 40.214$; $\rho = 1000$ kg/m³

Ambient Temperature : 23.6°C; Liquid Temperature : 22.2°C

DASY5 Configuration:

- Probe: EX3DV4 - SN3873; ConvF(7.96, 7.96, 7.96); Calibrated: 2019/08/30;
- Sensor-Surface: 1.4mm (Mechanical Surface Detection)
- Electronics: DAE4 Sn1341; Calibrated: 2019/08/28
- Phantom: Front Phantom with CRP v5.0; Type: QD000P40CD; Serial: TP:1695
- Measurement SW: DASY52, Version 52.8 (8); SEMCAD X Version 14.6.10 (7331)

- **Area Scan (81x131x1):** Interpolated grid: dx=1.500 mm, dy=1.500 mm

Maximum value of SAR (interpolated) = 0.108 W/kg

- **Zoom Scan (5x5x7)/Cube 0:** Measurement grid: dx=8mm, dy=8mm, dz=5mm

Reference Value = 3.050 V/m; Power Drift = 0.08 dB

Peak SAR (extrapolated) = 0.121 W/kg

SAR(1 g) = 0.074 W/kg; SAR(10 g) = 0.045 W/kg

Maximum value of SAR (measured) = 0.104 W/kg



P04 WCDMA IV_RMC12.2K_Right Tilted_Ch1413_Ant 0

DUT: 200304W004

Communication System: WCDMA; Frequency: 1732.6 MHz; Duty Cycle: 1:1

Medium: HSL1750_0319 Medium parameters used: $f = 1733$ MHz; $\sigma = 1.371$ S/m; $\epsilon_r = 38.557$; $\rho = 1000$ kg/m³

Ambient Temperature : 23.2°C; Liquid Temperature : 22.1°C

DASY5 Configuration:

- Probe: EX3DV4 - SN3873; ConvF(8.25, 8.25, 8.25); Calibrated: 2019/08/30;
- Sensor-Surface: 1.4mm (Mechanical Surface Detection)
- Electronics: DAE4 Sn1341; Calibrated: 2019/08/28
- Phantom: Front Phantom with CRP v5.0; Type: QD000P40CD; Serial: TP:1695
- Measurement SW: DASY52, Version 52.8 (8); SEMCAD X Version 14.6.10 (7331)

- **Area Scan (81x131x1):** Interpolated grid: dx=1.500 mm, dy=1.500 mm

Maximum value of SAR (interpolated) = 0.134 W/kg

- **Zoom Scan (5x5x7)/Cube 0:** Measurement grid: dx=8mm, dy=8mm, dz=5mm

Reference Value = 6.804 V/m; Power Drift = 0.08 dB

Peak SAR (extrapolated) = 0.154 W/kg

SAR(1 g) = 0.086 W/kg; SAR(10 g) = 0.045 W/kg

Maximum value of SAR (measured) = 0.124 W/kg

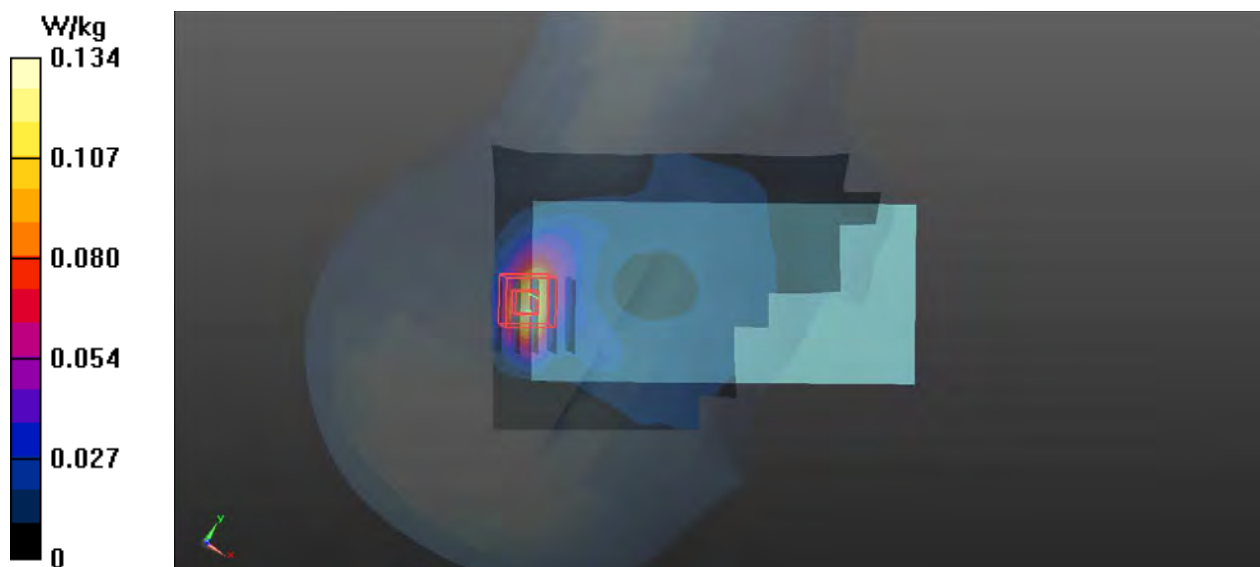

P05 WCDMA V_RMC12.2K_Right Cheek_Ch4182_Ant 1

DUT: 200304W004

Communication System: WCDMA; Frequency: 836.4 MHz; Duty Cycle: 1:1
Medium: HSL835_0317 Medium parameters used: $f = 836.4$ MHz; $\sigma = 0.9$ S/m; $\epsilon_r = 40.562$; $\rho = 1000$ kg/m³
Ambient Temperature : 23.5°C; Liquid Temperature : 22.3°C

DASY5 Configuration:

- Probe: EX3DV4 - SN3873; ConvF(9.59, 9.59, 9.59); Calibrated: 2019/08/30;
- Sensor-Surface: 1.4mm (Mechanical Surface Detection)
- Electronics: DAE4 Sn1341; Calibrated: 2019/08/28
- Phantom: Front Phantom with CRP v5.0; Type: QD000P40CD; Serial: TP:1695
- Measurement SW: DASY52, Version 52.8 (8); SEMCAD X Version 14.6.10 (7331)

- **Area Scan (81x131x1):** Interpolated grid: dx=1.500 mm, dy=1.500 mm
Maximum value of SAR (interpolated) = 1.50 W/kg

- **Zoom Scan (5x5x7)/Cube 0:** Measurement grid: dx=8mm, dy=8mm, dz=5mm
Reference Value = 26.98 V/m; Power Drift = -0.09 dB
Peak SAR (extrapolated) = 1.80 W/kg
SAR(1 g) = 0.818 W/kg; SAR(10 g) = 0.485 W/kg
Maximum value of SAR (measured) = 1.33 W/kg

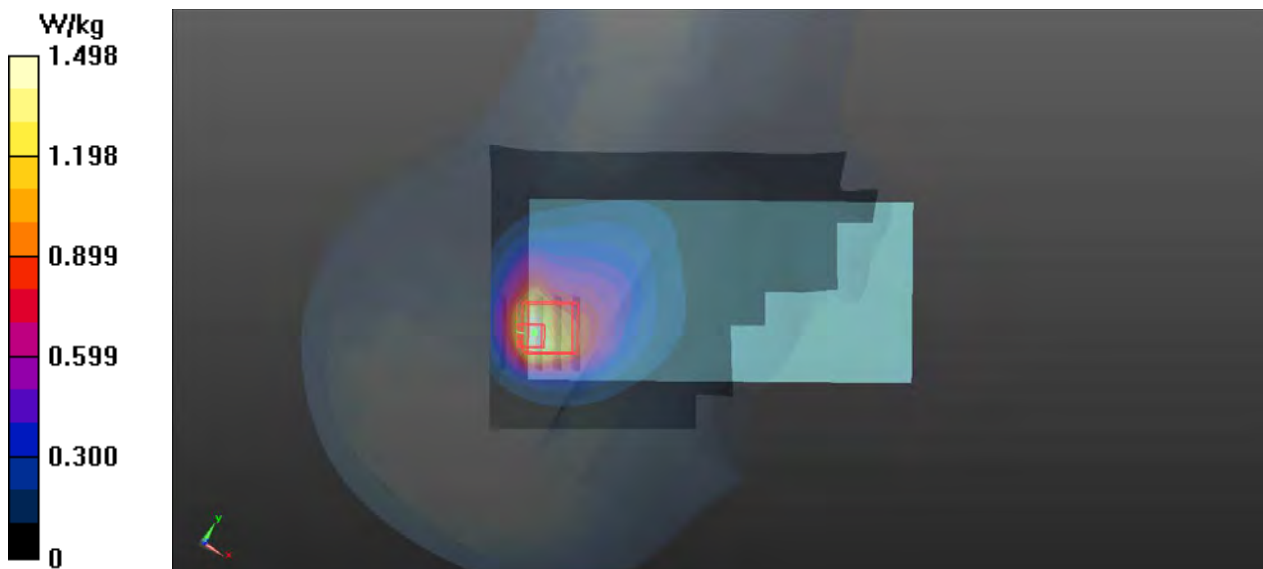

P06 LTE 2_QPSK20M_Left Cheek_Ch18900_1RB_OS0_Ant 0

DUT: 200304W004

Communication System: LTE; Frequency: 1880 MHz; Duty Cycle: 1:1

Medium: HSL1900_0321 Medium parameters used: $f = 1880$ MHz; $\sigma = 1.421$ S/m; $\epsilon_r = 40.255$; $\rho = 1000$ kg/m³

Ambient Temperature : 23.6°C; Liquid Temperature : 22.2°C

DASY5 Configuration:

- Probe: EX3DV4 - SN3873; ConvF(7.96, 7.96, 7.96); Calibrated: 2019/08/30;
- Sensor-Surface: 1.4mm (Mechanical Surface Detection)
- Electronics: DAE4 Sn1341; Calibrated: 2019/08/28
- Phantom: Front Phantom with CRP v5.0; Type: QD000P40CD; Serial: TP:1695
- Measurement SW: DASY52, Version 52.8 (8); SEMCAD X Version 14.6.10 (7331)

- **Area Scan (81x131x1):** Interpolated grid: dx=1.500 mm, dy=1.500 mm

Maximum value of SAR (interpolated) = 0.0870 W/kg

- **Zoom Scan (5x5x7)/Cube 0:** Measurement grid: dx=8mm, dy=8mm, dz=5mm

Reference Value = 3.027 V/m; Power Drift = 0.03 dB

Peak SAR (extrapolated) = 0.0980 W/kg

SAR(1 g) = 0.061 W/kg; SAR(10 g) = 0.037 W/kg

Maximum value of SAR (measured) = 0.0849 W/kg

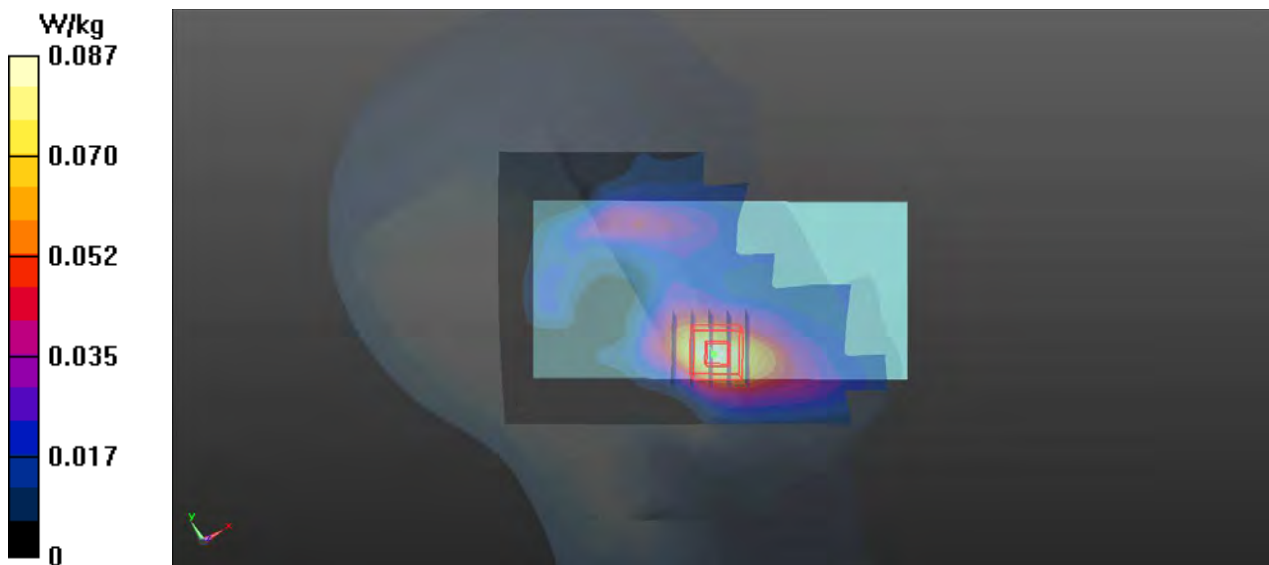

P07 LTE 4_QPSK20M_Right Tilted_Ch20050_1RB_OS50_Ant 0

DUT: 200304W004

Communication System: LTE; Frequency: 1720 MHz; Duty Cycle: 1:1
Medium: HSL1750_0319 Medium parameters used: $f = 1720$ MHz; $\sigma = 1.359$ S/m; $\epsilon_r = 38.618$; $\rho = 1000$ kg/m³
Ambient Temperature : 23.2°C; Liquid Temperature : 22.1°C

DASY5 Configuration:

- Probe: EX3DV4 - SN3873; ConvF(8.25, 8.25, 8.25); Calibrated: 2019/08/30;
- Sensor-Surface: 1.4mm (Mechanical Surface Detection)
- Electronics: DAE4 Sn1341; Calibrated: 2019/08/28
- Phantom: Front Phantom with CRP v5.0; Type: QD000P40CD; Serial: TP:1695
- Measurement SW: DASY52, Version 52.8 (8); SEMCAD X Version 14.6.10 (7331)

- **Area Scan (81x131x1):** Interpolated grid: dx=1.500 mm, dy=1.500 mm
Maximum value of SAR (interpolated) = 0.0951 W/kg

- **Zoom Scan (5x5x7)/Cube 0:** Measurement grid: dx=8mm, dy=8mm, dz=5mm
Reference Value = 5.747 V/m; Power Drift = 0.00 dB
Peak SAR (extrapolated) = 0.105 W/kg
SAR(1 g) = 0.058 W/kg; SAR(10 g) = 0.031 W/kg
Maximum value of SAR (measured) = 0.0858 W/kg

