

FCC SAR Test Report

APPLICANT : Xiaomi Communications Co., Ltd.
EQUIPMENT : Mobile Phone
BRAND NAME : Redmi
MODEL NAME : M1906G7G
FCC ID : 2AFZZG7G
STANDARD : FCC 47 CFR PART 2 (2.1093)
ANSI/IEEE C95.1-1992
IEEE 1528-2013

The product was received on Nov. 10, 2019 and testing was started from Nov. 12, 2019 and completed on Feb. 27, 2020. We, Sporton International (Kunshan) Inc., would like to declare that the tested sample has been evaluated in accordance with the test procedures and has been in compliance with the applicable technical standards.

The test results in this report apply exclusively to the tested model / sample. Without written approval of Sporton International (Kunshan) Inc., the test report shall not be reproduced except in full.

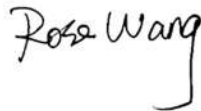

Reviewed by: Rose Wang / Supervisor

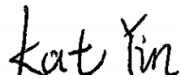

Approved by: Kat Yin / Manager



Sporton International (Kunshan) Inc.

**No. 1098, Pengxi North Road, Kunshan Economic Development Zone Jiangsu Province 215300
People's Republic of China**



Table of Contents

1. Statement of Compliance 4
2. Administration Data 6
3. Guidance Applied..... 6
4. Equipment Under Test (EUT) Information..... 7
4.1 General Information 7
4.2 General LTE SAR Test and Reporting Considerations 9
5. Proximity Sensor Triggering Test.....11
5.1 Proximity sensor triggering distances(Per KDB616217§6.2) 11
5.2 Tilt angle influences to proximity sensor triggering(Per KDB616217 §6.4)..... 14
6. RF Exposure Limits.....15
6.1 Uncontrolled Environment.....15
6.2 Controlled Environment.....15
7. Specific Absorption Rate (SAR).....16
7.1 Introduction16
7.2 SAR Definition.....16
8. System Description and Setup17
8.1 E-Field Probe18
8.2 Data Acquisition Electronics (DAE)18
8.3 Phantom.....19
8.4 Device Holder.....20
9. Measurement Procedures21
9.1 Spatial Peak SAR Evaluation21
9.2 Power Reference Measurement.....22
9.3 Area Scan22
9.4 Zoom Scan.....23
9.5 Volume Scan Procedures.....23
9.6 Power Drift Monitoring.....23
10. Test Equipment List.....24
11. System Verification25
11.1 Tissue Simulating Liquids25
11.2 Tissue Verification26
11.3 System Performance Check Results27
12. RF Exposure Positions28
12.1 Ear and handset reference point28
12.2 Definition of the cheek position29
12.3 Definition of the tilt position30
12.4 Body Worn Accessory31
12.5 Product Specific 10g SAR Exposure.....32
12.6 Wireless Router.....32
13. Conducted RF Output Power (Unit: dBm).....33
14. Antenna Location117
15. SAR Test Results119
15.1 Head SAR121
15.2 Hotspot SAR124
15.3 Body Worn Accessory SAR.....127
15.4 Product Specific SAR.....129
15.5 Repeated SAR Measurement130
16. Simultaneous Transmission Analysis.....131
16.1 Head Exposure Conditions132
16.2 Hotspot Exposure Conditions.....134
16.3 Body-Worn Accessory Exposure Conditions136
16.4 Product specific 10g SAR Exposure Conditions.....137
16.5 SPLSR Evaluation and Analysis.....138
17. Uncertainty Assessment140
18. References141
Appendix A. Plots of System Performance Check
Appendix B. Plots of High SAR Measurement
Appendix C. DASy Calibration Certificate
Appendix D. Test Setup Photos



Revision History

REPORT NO.	VERSION	DESCRIPTION	ISSUED DATE
FA021902	Rev. 01	Initial issue of report	Mar. 06, 2020



1. Statement of Compliance

The maximum results of Specific Absorption Rate (SAR) found during testing for **Xiaomi Communications Co., Ltd., Mobile Phone, M1906G7G**, are as follows.

Highest Standalone 1g SAR Summary						Highest Simultaneous Transmission 1g SAR (W/kg)
Equipment Class	Frequency Band		Head (Separation 0mm)	Hotspot (Separation 10mm)	Body-worn (Separation 15mm)	
			1g SAR (W/kg)			
Licensed	GSM	GSM850	1.07	0.47	0.22	1.58
		GSM1900	1.13	0.92	0.40	
	WCDMA	Band II	0.56	0.70	0.68	
		Band IV	0.49	1.12	0.40	
		Band V	1.12	0.34	0.22	
	LTE	LTE Band 2	0.57	0.71	0.54	
		LTE Band 4	0.80	0.89	0.32	
		LTE Band 5	0.68	0.25	0.16	
		LTE Band 7	0.59	1.10	0.46	
		LTE Band 38	0.77	0.42	0.18	
DTS	WLAN	2.4GHz WLAN	0.82	0.25	0.12	1.58
NII		5GHz WLAN	0.62	0.90	0.54	1.57
DSS	Bluetooth	Bluetooth				1.57
Date of Testing			2019/11/12~2020/2/27			

Highest 10g SAR Summary				
Equipment Class	Frequency Band		Product Specific 10g SAR (W/kg) (Separation 0mm)	Highest Simultaneous Transmission 10g SAR (W/kg)
Licensed	GSM	GSM1900	2.95	3.23
	WCDMA	Band II	3.23	
	LTE	LTE Band 2	2.79	
NII	WLAN	5GHz WLAN	1.61	3.23
Date of Testing			2019/11/12~2020/2/27	

Declaration of Conformity:

The test results with all measurement uncertainty excluded are presented in accordance with the regulation limits or requirements declared by manufacturers.

Comments and Explanations:

The declared of product specification for EUT presented in the report are provided by the manufacturer, and the manufacturer takes all the responsibilities for the accuracy of product specification.

This device is in compliance with Specific Absorption Rate (SAR) for general population/uncontrolled exposure limits (1.6 W/kg for Partial-Body 1g SAR, 4.0 W/kg for Product Specific 10g SAR) specified in FCC 47 CFR part 2 (2.1093) and ANSI/IEEE C95.1-1992, and had been tested in accordance with the measurement methods and procedures specified in IEEE 1528-2013 and FCC KDB publications.



2. Administration Data

Sporton International (Kunshan) Inc. is accredited to ISO/IEC 17025:2017 by American Association for Laboratory Accreditation with Certificate Number 5145.02.

Testing Laboratory		
Test Firm	Sporton International (Kunshan) Inc.	
Test Site Location	No. 1098, Pengxi North Road, Kunshan Economic Development Zone Jiangsu Province 215300 People's Republic of China TEL : +86-512-57900158 FAX : +86-512-57900958	
Test Site No.	FCC Designation No.	FCC Test Firm Registration No.
	CN1257	314309

Applicant	
Company Name	Xiaomi Communications Co., Ltd.
Address	#019, 9th Floor, Building 6, 33 Xi'erqi Middle Road, Haidian District, Beijing, China, 100085

Manufacturer	
Company Name	Xiaomi Communications Co., Ltd.
Address	#019, 9th Floor, Building 6, 33 Xi'erqi Middle Road, Haidian District, Beijing, China, 100085

3. Guidance Applied

The Specific Absorption Rate (SAR) testing specification, method, and procedure for this device is in accordance with the following standards:

- FCC 47 CFR Part 2 (2.1093)
- ANSI/IEEE C95.1-1992
- IEEE 1528-2013
- FCC KDB 865664 D01 SAR Measurement 100 MHz to 6 GHz v01r04
- FCC KDB 865664 D02 SAR Reporting v01r02
- FCC KDB 447498 D01 General RF Exposure Guidance v06
- FCC KDB 648474 D04 SAR Evaluation Considerations for Wireless Handsets v01r03
- FCC KDB 248227 D01 802.11 Wi-Fi SAR v02r02
- FCC KDB 941225 D01 3G SAR Procedures v03r01
- FCC KDB 941225 D05 SAR for LTE Devices v02r05
- FCC KDB 941225 D05A Rel.10 LTE SAR Test Guidance v01r02
- FCC KDB 941225 D06 Hotspot Mode SAR v02r01
- FCC KDB 616217 D04 SAR for laptop and tablets v01r02
-
-



4. Equipment Under Test (EUT) Information

4.1 General Information

Product Feature & Specification			
Equipment Name	Mobile Phone		
Brand Name	Redmi		
Model Name	M1906G7G		
FCC ID	2AFZZG7G		
IMEI Code	SIM1: 862763049855177 SIM2: 862763049355175		
Wireless Technology and Frequency Range	GSM850: 824.2 MHz ~ 848.8 MHz GSM1900: 1850.2 MHz ~ 1909.8 MHz WCDMA Band II: 1852.4 MHz ~ 1907.6 MHz WCDMA Band IV: 1712.4 MHz ~ 1752.6 MHz WCDMA Band V: 826.4 MHz ~ 846.6 MHz LTE Band 2: 1850.7 MHz ~ 1909.3 MHz LTE Band 4: 1710.7 MHz ~ 1754.3 MHz LTE Band 5: 824.7 MHz ~ 848.3 MHz LTE Band 7: 2502.5 MHz ~ 2567.5 MHz LTE Band 38: 2572.5 MHz ~ 2617.5 MHz WLAN 2.4GHz Band: 2412 MHz ~ 2462 MHz WLAN 5.2GHz Band: 5180 MHz ~ 5240 MHz WLAN 5.3GHz Band: 5260 MHz ~ 5320 MHz WLAN 5.5GHz Band: 5500 MHz ~ 5700 MHz WLAN 5.8GHz Band: 5745 MHz ~ 5805 MHz Bluetooth: 2402 MHz ~ 2480 MHz NFC : 13.56 MHz		
Mode	GSM/GPRS/EGPRS RMC/AMR 12.2Kbps HSDPA HSUPA DC-HSDPA HSPA+ (16QAM uplink) LTE: QPSK, 16QAM, 64QAM,256QAM(Downlink only) WLAN 2.4GHz : 802.11b/g/n/ HT20 WLAN 5GHz : 802.11a/n/ac HT20/HT40/VHT20/VHT40/VHT80 Bluetooth BR/EDR/LE NFC:ASK		
HW Version	P2		
SW Version	MIUI10		
Antenna Function for Transmitter		Ant. 1	Ant. 2
	Bluetooth	V	V
	WLAN 2.4GHz 802.11 b/g/n SISO	V	V
	WLAN 5GHz 802.11 a/n/ac SISO	V	V
GSM / (E)GPRS Transfer mode	Class B – EUT cannot support Packet Switched and Circuit Switched Network simultaneously but can automatically switch between Packet and Circuit Switched Network		
EUT Stage	Identical Prototype		
Remark:			
1. 802.11n-HT40 is not supported in 2.4GHz WLAN. 2. This device supports VoIP in GPRS, EGPRS, WCDMA and LTE (e.g. for 3rd-party VoIP), LTE supports VoLTE operation. 3. This device does not support DTM operation and support GRPS/EGRPS mode up to multi-slot class 12. 4. This device WLAN 2.4GHz supports hotspot operation and Bluetooth support tethering applications. 5. This device 2.4GHz WLAN/5.2GHz WLAN/5.8GHz WLAN support hotspot operation, and 5.2GHz WLAN/5.8GHz WLAN supports WiFi Direct (GC/GO), and 5.3GHz / 5.5GHz supports WiFi Direct (GC only). 6. For dual SIM card mobile has two SIM slots and supports dual SIM dual standby. The WWAN radio transmission will			



- be enabled by either one SIM at a time (single active). After pre-scan two SIM cards power, we found test result of the SIM1 was the worse, so we chose SIM1 slot to perform all tests.
7. This device has two WWAN transmit antennas. WWAN bottom antenna is located at the bottom edge of the device, and WWAN top antenna is located at the top edge of the device which can refer to antenna location chapter. Top and Bottom antenna support the same WWAN frequency bands, and they can't transmit simultaneously.
 8. For top WWAN antenna:
 - a. When the phone is in talking mode and receiver worked, then power reduction will be implemented immediately in GSM850/1900, WCDMA B2/B4/B5 and LTE B2/B4/B7/38/7C /38C.
 - b. When hotspot mode is enabled, power reduction will be activated to GSM850/1900, WCDMA B4/B5 and LTE B2/B4/B7/38/7C /38C. For GSM850, WCDMA B5 and LTE B7/38/7C /38C full power for hotspot mode can perform pass, no need to test reduced power.
 9. For bottom WWAN antenna:
 - a. The device employs proximity sensors that detect the presence of the user's body at the back or bottom faces of the device. When back or bottom of sensor on is detected, GSM1900, WCDMA B2/B4 and LTE B2/B4 for back/bottom sides of product specific 10g SAR condition reduced powers will be active for sensor on state, GSM1900, WCDMA B4 and LTE B2/B4 at back side for Body Worn, full power can be tested pass, so reduced power no need to be evaluated.
 - b. When hotspot mode is enabled, power reduction will be activated to GSM1900, WCDMA band II/IV, LTE band 2/4/7/7C.
 10. For WLAN antenna
 - a. For WLAN 2.4GHz/5.2/5.3/5.5GHz Ant1, When the phone is in talking mode, receiver worked and it transmits simultaneously with WWAN or Bluetooth for head mode, power reduction will be triggered for this scenario.
 - b. When hotspot mode is enabled, power reduction will be activated to WLAN2.4GHz/5.2GHz.
 11. The 2.4GHz/5GHz WLAN & Bluetooth can transmit in SISO antenna mode only and they have no MIMO antenna mode.
 12. There are two types of EUT (Sample 1 and Sample 2). According to the difference, they have no effect on SAR distribution, so only choose sample 1 to perform full testing.
 13. This is a variant report for M1906G7G, for model change note, please refer to the product equality declaration exhibit submitted. Based on the similarity between two models, GSM850/1900, WCDMA band II/IV/V and LTE Band 2/4/7/38 full SAR testing, and retest reduced power, other band only the worse cases from reference report (Sporton Report Number FA961001) were verified for difference.



4.2 General LTE SAR Test and Reporting Considerations

Summarized necessary items addressed in KDB 941225 D05 v02r05																																																															
FCC ID	2AFZZG7G																																																														
Equipment Name	Mobile Phone																																																														
Operating Frequency Range of each LTE transmission band	LTE Band 2: 1850.7 MHz ~ 1909.3 MHz LTE Band 4: 1710.7 MHz ~ 1754.3 MHz LTE Band 5: 824.7 MHz ~ 848.3 MHz LTE Band 7: 2502.5 MHz ~ 2567.5 MHz LTE Band 38: 2572.5 MHz ~ 2617.5 MHz																																																														
Channel Bandwidth	LTE Band 2: 1.4MHz, 3MHz, 5MHz, 10MHz, 15MHz, 20MHz LTE Band 4: 1.4MHz, 3MHz, 5MHz, 10MHz, 15MHz, 20MHz LTE Band 5: 1.4MHz, 3MHz, 5MHz, 10MHz LTE Band 7: 5MHz, 10MHz, 15MHz, 20MHz LTE Band 38: 5MHz, 10MHz, 15MHz, 20MHz																																																														
Uplink Modulations used	QPSK / 16QAM / 64QAM / 256QAM(Downlink only)																																																														
LTE Voice / Data requirements	Voice and Data																																																														
LTE Release Version	R12, Cat 13																																																														
CA Support	Yes, Uplink and Downlink																																																														
LTE MPR permanently built-in by design	<p>Table 6.2.3-1: Maximum Power Reduction (MPR) for Power Class 1, 2 and 3</p> <table border="1"> <thead> <tr> <th rowspan="2">Modulation</th> <th colspan="6">Channel bandwidth / Transmission bandwidth (N_{RB})</th> <th rowspan="2">MPR (dB)</th> </tr> <tr> <th>1.4 MHz</th> <th>3.0 MHz</th> <th>5 MHz</th> <th>10 MHz</th> <th>15 MHz</th> <th>20 MHz</th> </tr> </thead> <tbody> <tr> <td>QPSK</td> <td>> 5</td> <td>> 4</td> <td>> 8</td> <td>> 12</td> <td>> 16</td> <td>> 18</td> <td>≤ 1</td> </tr> <tr> <td>16 QAM</td> <td>≤ 5</td> <td>≤ 4</td> <td>≤ 8</td> <td>≤ 12</td> <td>≤ 16</td> <td>≤ 18</td> <td>≤ 1</td> </tr> <tr> <td>64 QAM</td> <td>> 5</td> <td>> 4</td> <td>> 8</td> <td>> 12</td> <td>> 16</td> <td>> 18</td> <td>≤ 2</td> </tr> <tr> <td>256 QAM</td> <td>≤ 5</td> <td>≤ 4</td> <td>≤ 8</td> <td>≤ 12</td> <td>≤ 16</td> <td>≤ 18</td> <td>≤ 2</td> </tr> <tr> <td></td> <td>> 5</td> <td>> 4</td> <td>> 8</td> <td>> 12</td> <td>> 16</td> <td>> 18</td> <td>≤ 3</td> </tr> <tr> <td></td> <td colspan="6" style="text-align: center;">≥ 1</td> <td>≤ 5</td> </tr> </tbody> </table>	Modulation	Channel bandwidth / Transmission bandwidth (N _{RB})						MPR (dB)	1.4 MHz	3.0 MHz	5 MHz	10 MHz	15 MHz	20 MHz	QPSK	> 5	> 4	> 8	> 12	> 16	> 18	≤ 1	16 QAM	≤ 5	≤ 4	≤ 8	≤ 12	≤ 16	≤ 18	≤ 1	64 QAM	> 5	> 4	> 8	> 12	> 16	> 18	≤ 2	256 QAM	≤ 5	≤ 4	≤ 8	≤ 12	≤ 16	≤ 18	≤ 2		> 5	> 4	> 8	> 12	> 16	> 18	≤ 3		≥ 1						≤ 5
Modulation	Channel bandwidth / Transmission bandwidth (N _{RB})						MPR (dB)																																																								
	1.4 MHz	3.0 MHz	5 MHz	10 MHz	15 MHz	20 MHz																																																									
QPSK	> 5	> 4	> 8	> 12	> 16	> 18	≤ 1																																																								
16 QAM	≤ 5	≤ 4	≤ 8	≤ 12	≤ 16	≤ 18	≤ 1																																																								
64 QAM	> 5	> 4	> 8	> 12	> 16	> 18	≤ 2																																																								
256 QAM	≤ 5	≤ 4	≤ 8	≤ 12	≤ 16	≤ 18	≤ 2																																																								
	> 5	> 4	> 8	> 12	> 16	> 18	≤ 3																																																								
	≥ 1						≤ 5																																																								
LTE A-MPR	In the base station simulator configuration, Network Setting value is set to NS_01 to disable A-MPR during SAR testing and the LTE SAR tests was transmitting on all TTI frames (Maximum TTI)																																																														
Spectrum plots for RB configuration	A properly configured base station simulator was used for the SAR and power measurement; therefore, spectrum plots for each RB allocation and offset configuration are not included in the SAR report.																																																														
Power reduction applied to satisfy SAR compliance	<p>Yes,</p> <p>For top WWAN antenna:</p> <ol style="list-style-type: none"> When the phone is in talking mode and receiver worked, then power reduction will be implemented immediately for LTE B2/B4/B7/38/7C /38C. When hotspot mode is enabled, power reduction will be activated to LTE B2/B4/B7/38/7C /38C. <p>For bottom WWAN antenna:</p> <ol style="list-style-type: none"> P-sensor can detect handheld state, LTE B2/B4 for back/bottom sides of product specific 10g SAR condition reduced powers will be active. When hotspot mode is enabled, power reduction will be activated to LTE band 2/4/7/7C. 																																																														
LTE Carrier Aggregation Combinations	Intra-Band possible combinations, the detail power verification please referred to section 13. SAR verified ,please referred to section 15																																																														
LTE Carrier Aggregation Additional Information	<p>(1) This device supports LTE Carrier Aggregation (CA) in the uplink for LTE 7C / 38C with two component carriers in the uplink. SAR Measurements and conducted powers were evaluated per FCC Guidance.</p> <p>(2) This device supports maximum of 2 carriers in the downlink and 2 carriers in the uplink. Additional following LTE Release features are not supported: Relay, HetNet, Enhanced MIMO, eICl, WiFi Offloading, MDH, eMBMA, Cross-Carrier Scheduling, Enhanced SC-FDMA.</p>																																																														



Transmission (H, M, L) channel numbers and frequencies in each LTE band												
LTE Band 2												
	Bandwidth 1.4 MHz		Bandwidth 3 MHz		Bandwidth 5 MHz		Bandwidth 10 MHz		Bandwidth 15 MHz		Bandwidth 20 MHz	
	Ch. #	Freq. (MHz)	Ch. #	Freq. (MHz)	Ch. #	Freq. (MHz)	Ch. #	Freq. (MHz)	Ch. #	Freq. (MHz)	Ch. #	Freq. (MHz)
L	18607	1850.7	18615	1851.5	18625	1852.5	18650	1855	18675	1857.5	18700	1860
M	18900	1880	18900	1880	18900	1880	18900	1880	18900	1880	18900	1880
H	19193	1909.3	19185	1908.5	19175	1907.5	19150	1905	19125	1902.5	19100	1900
LTE Band 4												
	Bandwidth 1.4 MHz		Bandwidth 3 MHz		Bandwidth 5 MHz		Bandwidth 10 MHz		Bandwidth 15 MHz		Bandwidth 20 MHz	
	Ch. #	Freq. (MHz)	Ch. #	Freq. (MHz)	Ch. #	Freq. (MHz)	Ch. #	Freq. (MHz)	Ch. #	Freq. (MHz)	Ch. #	Freq. (MHz)
L	19957	1710.7	19965	1711.5	19975	1712.5	20000	1715	20025	1717.5	20050	1720
M	20175	1732.5	20175	1732.5	20175	1732.5	20175	1732.5	20175	1732.5	20175	1732.5
H	20393	1754.3	20385	1753.5	20375	1752.5	20350	1750	20325	1747.5	20300	1745
LTE Band 5												
	Bandwidth 1.4 MHz		Bandwidth 3 MHz		Bandwidth 5 MHz		Bandwidth 10 MHz		Bandwidth 15 MHz		Bandwidth 20 MHz	
	Ch. #	Freq. (MHz)	Ch. #	Freq. (MHz)	Ch. #	Freq. (MHz)	Ch. #	Freq. (MHz)	Ch. #	Freq. (MHz)	Ch. #	Freq. (MHz)
L	20407	824.7	20415	825.5	20425	826.5	20450	829	20450	829	20450	829
M	20525	836.5	20525	836.5	20525	836.5	20525	836.5	20525	836.5	20525	836.5
H	20643	848.3	20635	847.5	20625	846.5	20600	844	20600	844	20600	844
LTE Band 7												
	Bandwidth 5 MHz		Bandwidth 10 MHz		Bandwidth 15 MHz		Bandwidth 20 MHz		Bandwidth 15 MHz		Bandwidth 20 MHz	
	Ch. #	Freq. (MHz)	Ch. #	Freq. (MHz)	Ch. #	Freq. (MHz)	Ch. #	Freq. (MHz)	Ch. #	Freq. (MHz)	Ch. #	Freq. (MHz)
L	20775	2502.5	20800	2505	20825	2507.5	20850	2510	20850	2510	20850	2510
M	21100	2535	21100	2535	21100	2535	21100	2535	21100	2535	21100	2535
H	21425	2567.5	21400	2565	21375	2562.5	21350	2560	21350	2560	21350	2560
LTE Band 38												
	Bandwidth 5 MHz		Bandwidth 10 MHz		Bandwidth 15 MHz		Bandwidth 20 MHz		Bandwidth 15 MHz		Bandwidth 20 MHz	
	Ch. #	Freq. (MHz)	Ch. #	Freq. (MHz)	Ch. #	Freq. (MHz)	Ch. #	Freq. (MHz)	Ch. #	Freq. (MHz)	Ch. #	Freq. (MHz)
L	37775	2572.5	37800	2575	37825	2577.5	37850	2580	37850	2580	37850	2580
M	38000	2595	38000	2595	38000	2595	38000	2595	38000	2595	38000	2595
H	38225	2617.5	38200	2615	38175	2612.5	38150	2610	38150	2610	38150	2610

5. Proximity Sensor Triggering Test

5.1 Proximity sensor triggering distances(Per KDB616217§6.2)

1. Proximity sensor triggering distance testing was performed according to the procedures outlined in KDB 616217 D04 section 6.2, and EUT moving further away from the flat phantom and EUT moving toward the flat phantom were both assessed and the tissue-equivalent medium for highest frequency (1900MHz) and lowest (1750MHz) frequency was used for proximity sensor triggering testing.
2. Capacitive proximity sensor placed coincident with antenna elements at the bottom end of the phone are utilized to determine when the device comes in proximity of the user's body at the back or bottom side surface of the device. There is no need to do sensor coverage testing for the proximity sensor is designed to support sufficient detection range and sensitivity to cover regions of the sensors in all applicable directions since the proximity sensor entirely covers the antenna.
3. When the sensor is active, GSM1900, WCDMA B2 / B4, and LTE B2 / B4 reduced power will be active.
4. The sensors used to detect the proximity of the user's finger or hand at the back or bottom side surface of the device use a detection threshold distance. The data shown in the sections below shows the distance(s).

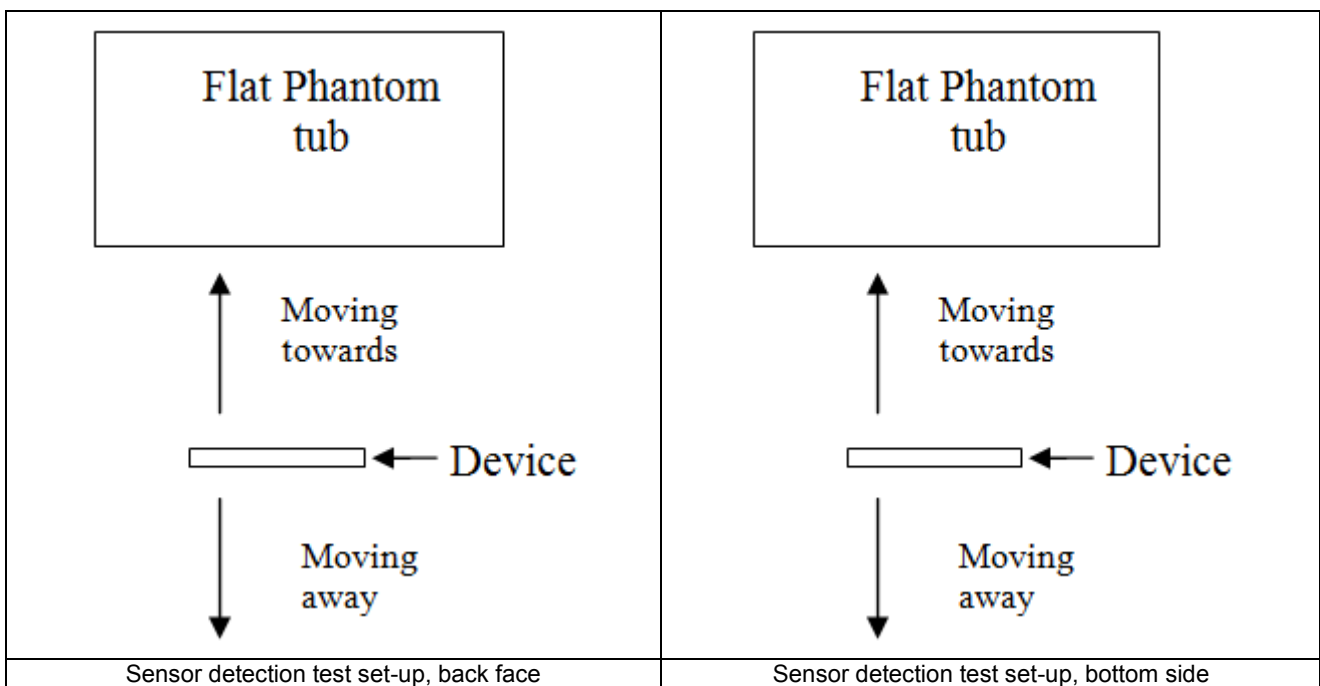

Proximity Sensor Triggering Distance (mm)				
Position	Back		Bottom Side	
	Moving towards	Moving away	Moving towards	Moving away
Minimum	16	16	8	8

<Sensor Trigger Distance and Measured Power>

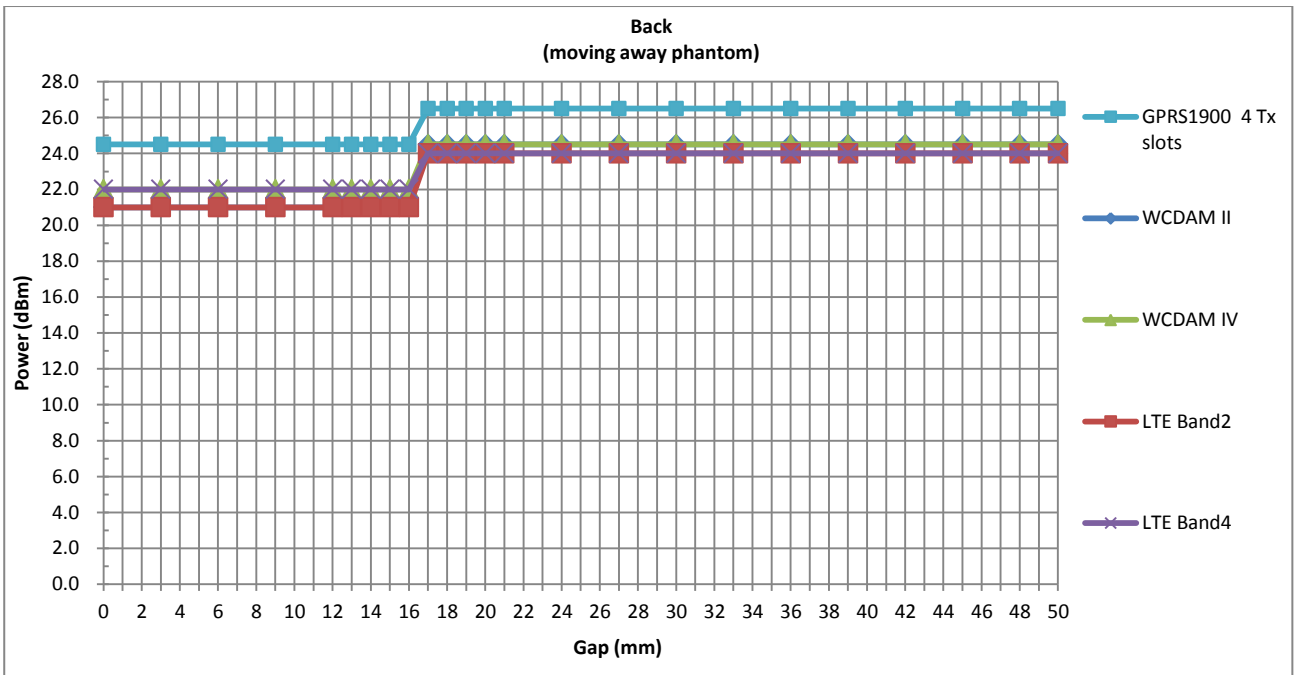
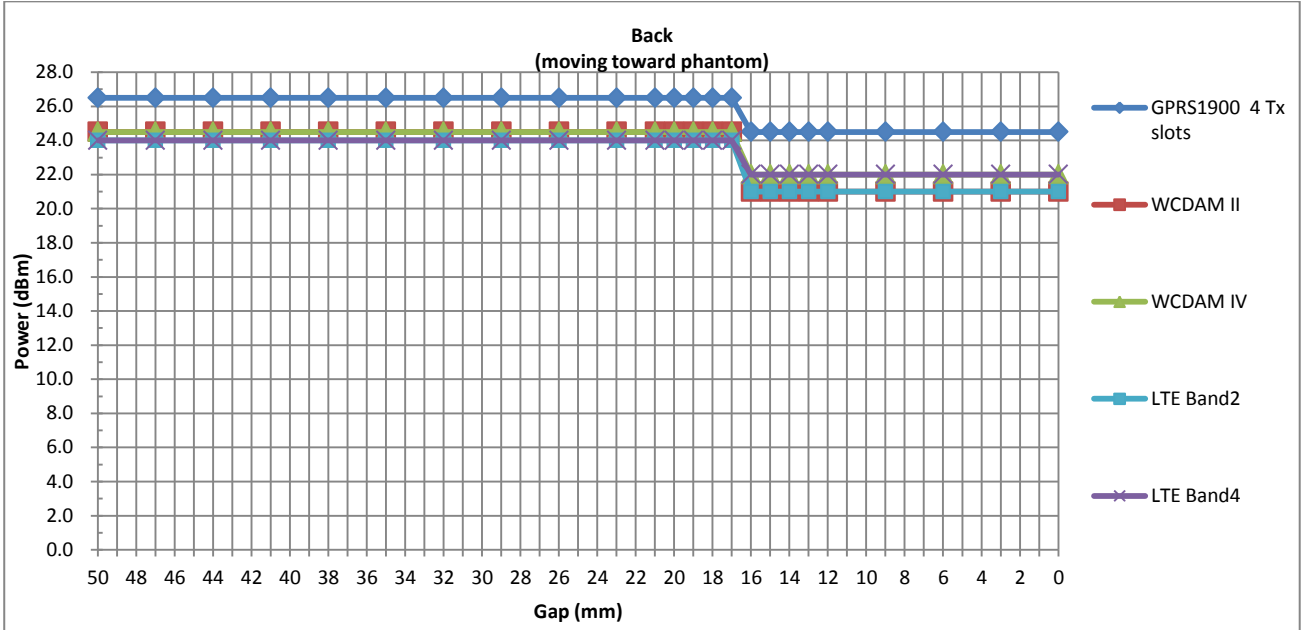

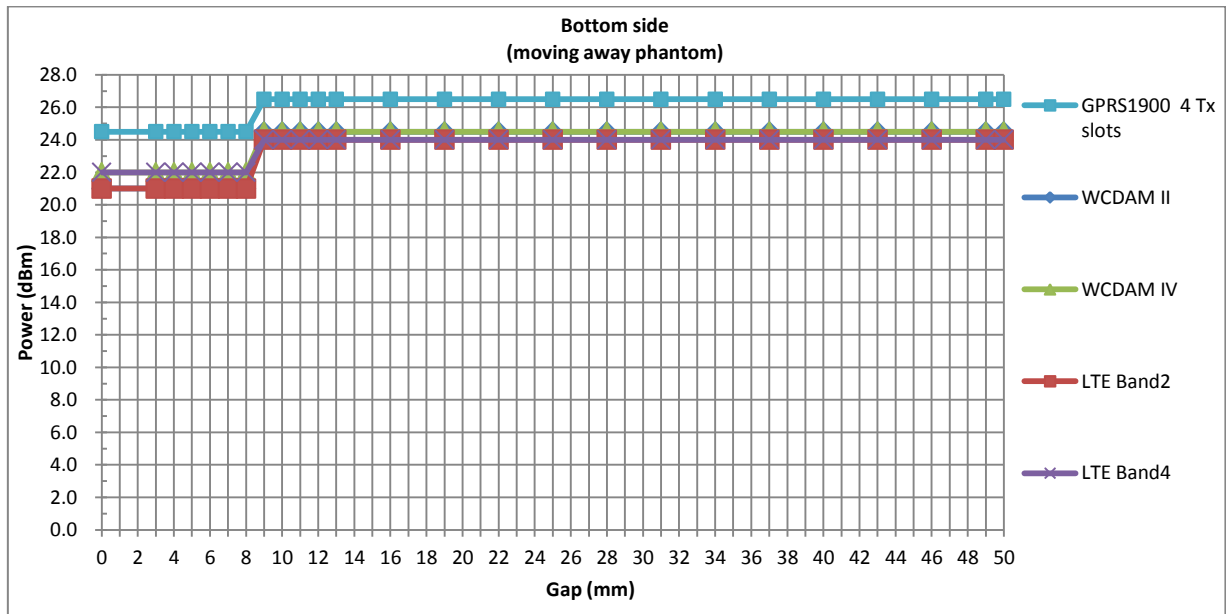
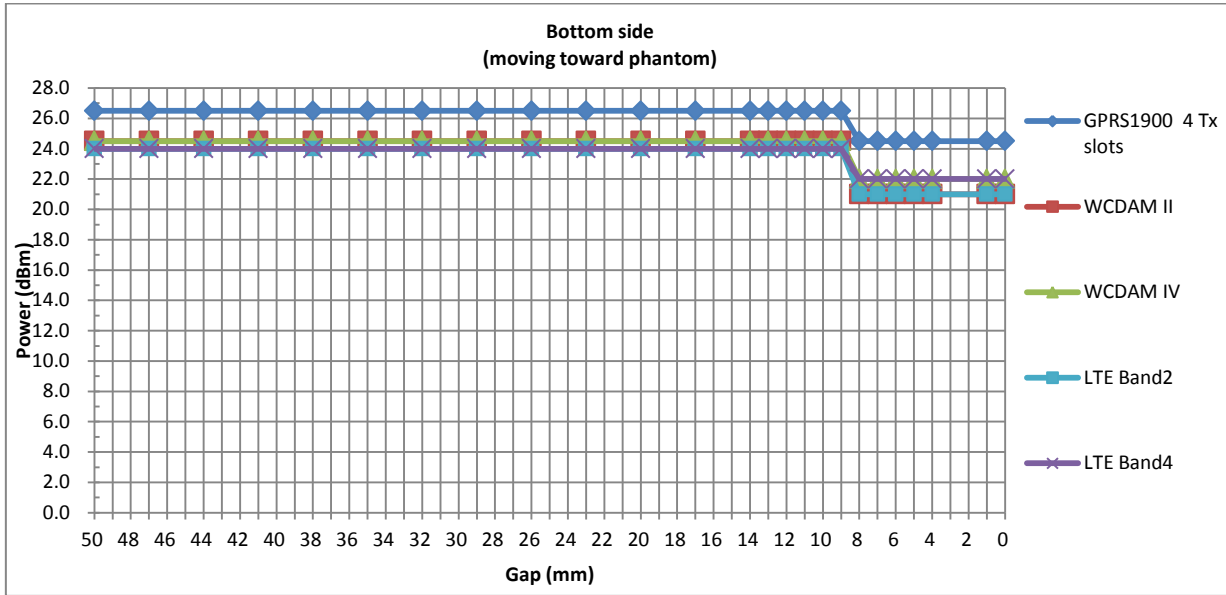

5.2 Tilt angle influences to proximity sensor triggering(Per KDB616217 §6.4)

The DUT was positioned directly below the flat phantom at the minimum measured trigger distance with bottom side parallel to the base of the flat phantom for each band.

The EUT was rotated about bottom side for angles up to +/- 45°. If the output power increased during the rotation the DUT was moved 1mm toward the phantom and the rotation repeated. This procedure was repeated until the power remained reduced for all angles up to +/- 45°.

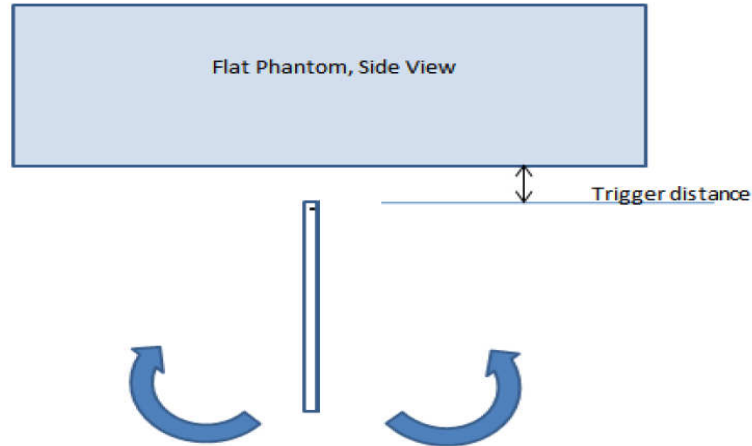

Proximity Sensor Coverage Assesment(Bottom Side)

Table: Summary of Tablet Tilt Angle Influence to Proximity Sensor Triggering (Bottom Side)

Main ant Band(MHz)	Minimum trigger distance at which power reduction was maintained over ±45°	Power Reduction Status											
		-45°	-35°	-25°	-15°	-5°	0°	5°	15°	25°	35°	45°	
GSM1900	8mm	on	on	on	on	on	on	on	on	on	on	on	on
WCDMA Band II	8mm	on	on	on	on	on	on	on	on	on	on	on	on
WCDMA Band IV	8mm	on	on	on	on	on	on	on	on	on	on	on	on
LTE Band 2	8mm	on	on	on	on	on	on	on	on	on	on	on	on
LTE Band 4	8mm	on	on	on	on	on	on	on	on	on	on	on	on

Conclusion: As is shown from the validation data, it can be ensured that the proximity sensor can be valid triggered for the DUT tilt coverage exposure condition.

6. RF Exposure Limits

6.1 Uncontrolled Environment

Uncontrolled Environments are defined as locations where there is the exposure of individuals who have no knowledge or control of their exposure. The general population/uncontrolled exposure limits are applicable to situations in which the general public may be exposed or in which persons who are exposed as a consequence of their employment may not be made fully aware of the potential for exposure or cannot exercise control over their exposure. Members of the general public would come under this category when exposure is not employment-related; for example, in the case of a wireless transmitter that exposes persons in its vicinity.

6.2 Controlled Environment

Controlled Environments are defined as locations where there is exposure that may be incurred by persons who are aware of the potential for exposure, (i.e. as a result of employment or occupation). In general, occupational/controlled exposure limits are applicable to situations in which persons are exposed as a consequence of their employment, who have been made fully aware of the potential for exposure and can exercise control over their exposure. The exposure category is also applicable when the exposure is of a transient nature due to incidental passage through a location where the exposure levels may be higher than the general population/uncontrolled limits, but the exposed person is fully aware of the potential for exposure and can exercise control over his or her exposure by leaving the area or by some other appropriate means.

Limits for Occupational/Controlled Exposure (W/kg)

Whole-Body	Partial-Body	Hands, Wrists, Feet and Ankles
0.4	8.0	20.0

Limits for General Population/Uncontrolled Exposure (W/kg)

Whole-Body	Partial-Body	Hands, Wrists, Feet and Ankles
0.08	1.6	4.0

Whole-Body SAR is averaged over the entire body, partial-body SAR is averaged over any 1gram of tissue defined as a tissue volume in the shape of a cube. SAR for hands, wrists, feet and ankles is averaged over any 10 grams of tissue defined as a tissue volume in the shape of a cube.

7. Specific Absorption Rate (SAR)

7.1 Introduction

SAR is related to the rate at which energy is absorbed per unit mass in an object exposed to a radio field. The SAR distribution in a biological body is complicated and is usually carried out by experimental techniques or numerical modeling. The standard recommends limits for two tiers of groups, occupational/controlled and general population/uncontrolled, based on a person's awareness and ability to exercise control over his or her exposure. In general, occupational/controlled exposure limits are higher than the limits for general population/uncontrolled.

7.2 SAR Definition

The SAR definition is the time derivative (rate) of the incremental energy (dW) absorbed by (dissipated in) an incremental mass (dm) contained in a volume element (dv) of a given density (ρ). The equation description is as below:

$$SAR = \frac{d}{dt} \left(\frac{dW}{dm} \right) = \frac{d}{dt} \left(\frac{dW}{\rho dv} \right)$$

SAR is expressed in units of Watts per kilogram (W/kg)

$$SAR = \frac{\sigma |E|^2}{\rho}$$

Where: σ is the conductivity of the tissue, ρ is the mass density of the tissue and E is the RMS electrical field strength.

8. System Description and Setup

The DASY system used for performing compliance tests consists of the following items:

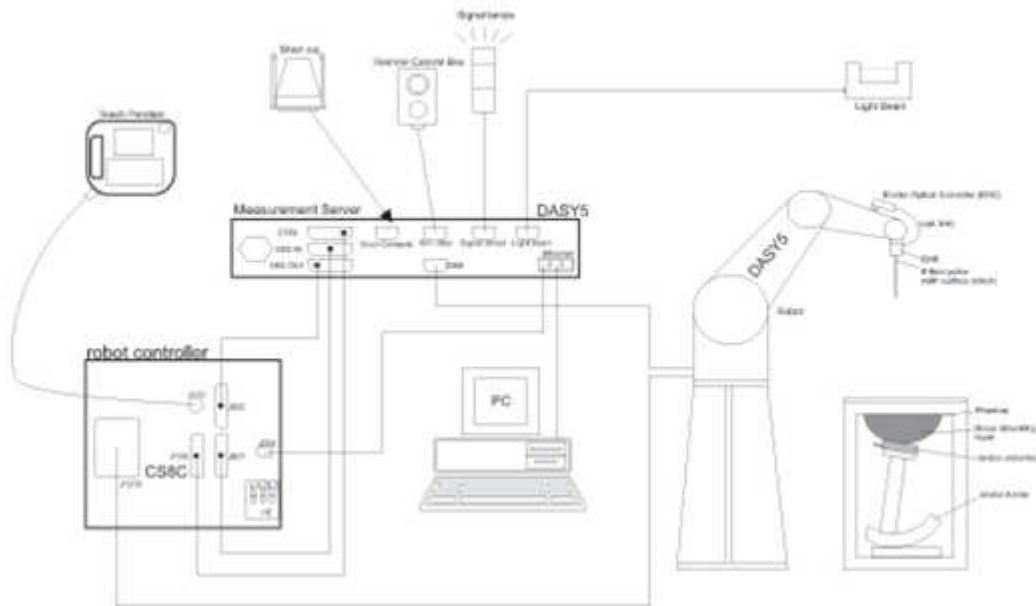

- A standard high precision 6-axis robot with controller, teach pendant and software. An arm extension for accommodating the data acquisition electronics (DAE).
- An isotropic Field probe optimized and calibrated for the targeted measurement.
- A data acquisition electronics (DAE) which performs the signal amplification, signal multiplexing, AD-conversion, offset measurements, mechanical surface detection, collision detection, etc. The unit is battery powered with standard or rechargeable batteries. The signal is optically transmitted to the EOC.
- The Electro-optical converter (EOC) performs the conversion from optical to electrical signals for the digital communication to the DAE. To use optical surface detection, a special version of the EOC is required. The EOC signal is transmitted to the measurement server.
- The function of the measurement server is to perform the time critical tasks such as signal filtering, control of the robot operation and fast movement interrupts.
- The Light Beam used is for probe alignment. This improves the (absolute) accuracy of the probe positioning.
- A computer running WinXP or Win7 and the DASY5 software.
- Remote control and teach pendant as well as additional circuitry for robot safety such as warning lamps, etc.
- The phantom, the device holder and other accessories according to the targeted measurement.

8.1 E-Field Probe

The SAR measurement is conducted with the dosimetric probe (manufactured by SPEAG).The probe is specially designed and calibrated for use in liquid with high permittivity. The dosimetric probe has special calibration in liquid at different frequency. This probe has a built in optical surface detection system to prevent from collision with phantom.

<EX3DV4 Probe>

Construction	Symmetric design with triangular core Built-in shielding against static charges PEEK enclosure material (resistant to organic solvents, e.g., DGBE)	
Frequency	10 MHz – >6 GHz Linearity: ±0.2 dB (30 MHz – 6 GHz)	
Directivity	±0.3 dB in TSL (rotation around probe axis) ±0.5 dB in TSL (rotation normal to probe axis)	
Dynamic Range	10 µW/g – >100 mW/g Linearity: ±0.2 dB (noise: typically <1 µW/g)	
Dimensions	Overall length: 337 mm (tip: 20 mm) Tip diameter: 2.5 mm (body: 12 mm) Typical distance from probe tip to dipole centers: 1 mm	

<ES3DV3 Probe>

Construction	Symmetric design with triangular core Interleaved sensors Built-in shielding against static charges PEEK enclosure material (resistant to organic solvents, e.g., DGBE)	
Frequency	10 MHz – 4 GHz; Linearity: ±0.2 dB (30 MHz – 4 GHz)	
Directivity	±0.2 dB in TSL (rotation around probe axis) ±0.3 dB in TSL (rotation normal to probe axis)	
Dynamic Range	5 µW/g – >100 mW/g; Linearity: ±0.2 dB	
Dimensions	Overall length: 337 mm (tip: 20 mm) Tip diameter: 3.9 mm (body: 12 mm) Distance from probe tip to dipole centers: 3.0 mm	

8.2 Data Acquisition Electronics (DAE)

The data acquisition electronics (DAE) consists of a highly sensitive electrometer-grade preamplifier with auto-zeroing, a channel and gain-switching multiplexer, a fast 16 bit AD-converter and a command decoder and control logic unit. Transmission to the measurement server is accomplished through an optical downlink for data and status information as well as an optical uplink for commands and the clock.

The input impedance of the DAE is 200 MOhm; the inputs are symmetrical and floating. Common mode rejection is above 80 dB.



Photo of DAE

8.3 Phantom

<SAM Twin Phantom>

Shell Thickness	2 ± 0.2 mm; Center ear point: 6 ± 0.2 mm
Filling Volume	Approx. 25 liters
Dimensions	Length: 1000 mm; Width: 500 mm; Height: adjustable feet
Measurement Areas	Left Hand, Right Hand, Flat Phantom



The bottom plate contains three pair of bolts for locking the device holder. The device holder positions are adjusted to the standard measurement positions in the three sections. A white cover is provided to tap the phantom during off-periods to prevent water evaporation and changes in the liquid parameters. On the phantom top, three reference markers are provided to identify the phantom position with respect to the robot.

<ELI Phantom>

Shell Thickness	2 ± 0.2 mm (sagging: <1%)
Filling Volume	Approx. 30 liters
Dimensions	Major ellipse axis: 600 mm Minor axis: 400 mm



The ELI phantom is intended for compliance testing of handheld and body-mounted wireless devices in the frequency range of 30 MHz to 6 GHz. ELI4 is fully compatible with standard and all known tissue simulating liquids.

8.4 Device Holder

<Mounting Device for Hand-Held Transmitter>

In combination with the Twin SAM V5.0/V5.0c or ELI phantoms, the Mounting Device for Hand-Held Transmitters enables rotation of the mounted transmitter device to specified spherical coordinates. At the heads, the rotation axis is at the ear opening. Transmitter devices can be easily and accurately positioned according to IEC 62209-1, IEEE 1528, FCC, or other specifications. The device holder can be locked for positioning at different phantom sections (left head, right head, flat). And upgrade kit to Mounting Device to enable easy mounting of wider devices like big smart-phones, e-books, small tablets, etc. It holds devices with width up to 140 mm.



Mounting Device for Hand-Held Transmitters



Mounting Device Adaptor for Wide-Phones

<Mounting Device for Laptops and other Body-Worn Transmitters>

The extension is lightweight and made of POM, acrylic glass and foam. It fits easily on the upper part of the mounting device in place of the phone positioned. The extension is fully compatible with the SAM Twin and ELI phantoms.



Mounting Device for Laptops

9. Measurement Procedures

The measurement procedures are as follows:

<Conducted power measurement>

- (a) For WWAN power measurement, use base station simulator to configure EUT WWAN transmission in conducted connection with RF cable, at maximum power in each supported wireless interface and frequency band.
- (b) Read the WWAN RF power level from the base station simulator.
- (c) For WLAN/BT power measurement, use engineering software to configure EUT WLAN/BT continuously transmission, at maximum RF power in each supported wireless interface and frequency band
- (d) Connect EUT RF port through RF cable to the power meter, and measure WLAN/BT output power

<SAR measurement>

- (a) Use base station simulator to configure EUT WWAN transmission in radiated connection, and engineering software to configure EUT WLAN/BT continuously transmission, at maximum RF power, in the highest power channel.
- (b) Place the EUT in the positions as Appendix D demonstrates.
- (c) Set scan area, grid size and other setting on the DASY software.
- (d) Measure SAR results for the highest power channel on each testing position.
- (e) Find out the largest SAR result on these testing positions of each band
- (f) Measure SAR results for other channels in worst SAR testing position if the reported SAR of highest power channel is larger than 0.8 W/kg

According to the test standard, the recommended procedure for assessing the peak spatial-average SAR value consists of the following steps:

- (a) Power reference measurement
- (b) Area scan
- (c) Zoom scan
- (d) Power drift measurement

9.1 Spatial Peak SAR Evaluation

The procedure for spatial peak SAR evaluation has been implemented according to the test standard. It can be conducted for 1g and 10g, as well as for user-specific masses. The DASY software includes all numerical procedures necessary to evaluate the spatial peak SAR value.

The base for the evaluation is a "cube" measurement. The measured volume must include the 1g and 10g cubes with the highest averaged SAR values. For that purpose, the center of the measured volume is aligned to the interpolated peak SAR value of a previously performed area scan.

The entire evaluation of the spatial peak values is performed within the post-processing engine (SEMCAD). The system always gives the maximum values for the 1g and 10g cubes. The algorithm to find the cube with highest averaged SAR is divided into the following stages:

- (a) Extraction of the measured data (grid and values) from the Zoom Scan
- (b) Calculation of the SAR value at every measurement point based on all stored data (A/D values and measurement parameters)
- (c) Generation of a high-resolution mesh within the measured volume
- (d) Interpolation of all measured values from the measurement grid to the high-resolution grid
- (e) Extrapolation of the entire 3-D field distribution to the phantom surface over the distance from sensor to surface
- (f) Calculation of the averaged SAR within masses of 1g and 10g

9.2 Power Reference Measurement

The Power Reference Measurement and Power Drift Measurements are for monitoring the power drift of the device under test in the batch process. The minimum distance of probe sensors to surface determines the closest measurement point to phantom surface. This distance cannot be smaller than the distance of sensor calibration points to probe tip as defined in the probe properties.

9.3 Area Scan

The area scan is used as a fast scan in two dimensions to find the area of high field values, before doing a fine measurement around the hot spot. The sophisticated interpolation routines implemented in DASY software can find the maximum found in the scanned area, within a range of the global maximum. The range (in dB) is specified in the standards for compliance testing. For example, a 2 dB range is required in IEEE standard 1528 and IEC 62209 standards, whereby 3 dB is a requirement when compliance is assessed in accordance with the ARIB standard (Japan), if only one zoom scan follows the area scan, then only the absolute maximum will be taken as reference. For cases where multiple maximums are detected, the number of zoom scans has to be increased accordingly.

Area scan parameters extracted from FCC KDB 865664 D01v01r04 SAR measurement 100 MHz to 6 GHz.

	≤ 3 GHz	> 3 GHz
Maximum distance from closest measurement point (geometric center of probe sensors) to phantom surface	5 ± 1 mm	$\frac{1}{2} \cdot \delta \cdot \ln(2) \pm 0.5$ mm
Maximum probe angle from probe axis to phantom surface normal at the measurement location	30° ± 1°	20° ± 1°
Maximum area scan spatial resolution: $\Delta x_{Area}, \Delta y_{Area}$	≤ 2 GHz: ≤ 15 mm 2 – 3 GHz: ≤ 12 mm	3 – 4 GHz: ≤ 12 mm 4 – 6 GHz: ≤ 10 mm
	When the x or y dimension of the test device, in the measurement plane orientation, is smaller than the above, the measurement resolution must be ≤ the corresponding x or y dimension of the test device with at least one measurement point on the test device.	

9.4 Zoom Scan

Zoom scans are used assess the peak spatial SAR values within a cubic averaging volume containing 1 gram and 10 gram of simulated tissue. The zoom scan measures points (refer to table below) within a cube shoes base faces are centered on the maxima found in a preceding area scan job within the same procedure. When the measurement is done, the zoom scan evaluates the averaged SAR for 1 gram and 10 gram and displays these values next to the job's label.

Zoom scan parameters extracted from FCC KDB 865664 D01v01r04 SAR measurement 100 MHz to 6 GHz.

		≤ 3 GHz	> 3 GHz	
Maximum zoom scan spatial resolution: $\Delta x_{Zoom}, \Delta y_{Zoom}$		≤ 2 GHz: ≤ 8 mm 2 – 3 GHz: ≤ 5 mm*	3 – 4 GHz: ≤ 5 mm* 4 – 6 GHz: ≤ 4 mm*	
Maximum zoom scan spatial resolution, normal to phantom surface	uniform grid: $\Delta z_{Zoom}(n)$	≤ 5 mm	3 – 4 GHz: ≤ 4 mm 4 – 5 GHz: ≤ 3 mm 5 – 6 GHz: ≤ 2 mm	
	graded grid	$\Delta z_{Zoom}(1)$: between 1 st two points closest to phantom surface	≤ 4 mm	3 – 4 GHz: ≤ 3 mm 4 – 5 GHz: ≤ 2.5 mm 5 – 6 GHz: ≤ 2 mm
		$\Delta z_{Zoom}(n>1)$: between subsequent points	$\leq 1.5 \cdot \Delta z_{Zoom}(n-1)$	
Minimum zoom scan volume	x, y, z	≥ 30 mm	3 – 4 GHz: ≥ 28 mm 4 – 5 GHz: ≥ 25 mm 5 – 6 GHz: ≥ 22 mm	
Note: δ is the penetration depth of a plane-wave at normal incidence to the tissue medium; see draft standard IEEE P1528-2011 for details. * When zoom scan is required and the <i>reported</i> SAR from the <i>area scan based 1-g SAR estimation</i> procedures of KDB 447498 is ≤ 1.4 W/kg, ≤ 8 mm, ≤ 7 mm and ≤ 5 mm zoom scan resolution may be applied, respectively, for 2 GHz to 3 GHz, 3 GHz to 4 GHz and 4 GHz to 6 GHz.				

9.5 Volume Scan Procedures

The volume scan is used for assess overlapping SAR distributions for antennas transmitting in different frequency bands. It is equivalent to an oversized zoom scan used in standalone measurements. The measurement volume will be used to enclose all the simultaneous transmitting antennas. For antennas transmitting simultaneously in different frequency bands, the volume scan is measured separately in each frequency band. In order to sum correctly to compute the 1g aggregate SAR, the EUT remain in the same test position for all measurements and all volume scan use the same spatial resolution and grid spacing. When all volume scan were completed, the software, SEMCAD postprocessor can combine and subsequently superpose these measurement data to calculating the multiband SAR.

9.6 Power Drift Monitoring

All SAR testing is under the EUT install full charged battery and transmit maximum output power. In DASy measurement software, the power reference measurement and power drift measurement procedures are used for monitoring the power drift of EUT during SAR test. Both these procedures measure the field at a specified reference position before and after the SAR testing. The software will calculate the field difference in dB. If the power drifts more than 5%, the SAR will be retested.



10. Test Equipment List

Manufacturer	Name of Equipment	Type/Model	Serial Number	Calibration	
				Last Cal.	Due Date
SPEAG	835MHz System Validation Kit	D835V2	4d151	2019/3/27	2020/3/26
SPEAG	1750MHz System Validation Kit	D1750V2	1090	2019/3/27	2020/3/26
SPEAG	1900MHz System Validation Kit	D1900V2	5d170	2019/3/26	2020/3/25
SPEAG	2450MHz System Validation Kit	D2450V2	908	2019/3/25	2020/3/24
SPEAG	2600MHz System Validation Kit	D2600V2	1078	2019/3/6	2020/3/5
SPEAG	5000MHz System Validation Kit	D5GHzV2	1113	2019/9/24	2020/9/23
SPEAG	Data Acquisition Electronics	DAE4	1358	2019/4/17	2020/4/16
SPEAG	Dosimetric E-Field Probe	EX3DV4	3857	2019/5/27	2020/5/26
SPEAG	Dosimetric E-Field Probe	ES3DV3	3279	2019/3/4	2020/3/3
SPEAG	SAM Twin Phantom	QD 000 P40 CB	TP-1697	NCR	NCR
SPEAG	Phone Positioner	N/A	N/A	NCR	NCR
Anritsu	Radio Communication Analyzer	MT8821C	6201432831	2019/4/17	2020/4/16
Agilent	Wireless Communication Test Set	E5515C	MY52102706	2019/4/17	2020/4/16
Agilent	ENA Series Network Analyzer	E5071C	MY46111157	2019/4/17	2020/4/16
SPEAG	Dielectric Probe Kit	DAK-3.5	Dec. 06, 1902	2019/10/28	2020/10/27
Anritsu	Vector Signal Generator	MG3710A	6201682672	2019/1/14	2020/1/13
Anritsu	Vector Signal Generator	MG3710A	6201682672	2020/1/8	2021/1/7
Rohde & Schwarz	Power Meter	NRVD	102081	2019/8/15	2020/8/14
Rohde & Schwarz	Power Sensor	NRV-Z5	100538	2019/8/14	2020/8/13
Rohde & Schwarz	Power Sensor	NRV-Z5	100539	2019/8/14	2020/8/13
R&S	CBT BLUETOOTH TESTER	CBT	101641	2019/1/14	2020/1/13
R&S	CBT BLUETOOTH TESTER	CBT	101641	2020/1/8	2021/1/7
EXA	Spectrum Analyzer	FSV7	101631	2019/1/14	2020/1/13
EXA	Spectrum Analyzer	FSV7	101631	2020/1/8	2021/1/7
Testo	Hygrometer	608-H1	1241332088	2019/1/11	2020/1/10
Testo	Hygrometer	608-H1	1241332088	2020/1/8	2021/1/7
FLUKE	DIGITAC THERMOMETER	51II	97240029	2019/8/15	2020/8/14
ARRA	Power Divider	A3200-2	N/A	Note	
MCL	Attenuation1	BW-S10W5+	N/A	Note	
MCL	Attenuation2	BW-S10W5+	N/A	Note	
MCL	Attenuation3	BW-S10W5+	N/A	Note	
BONN	POWER AMPLIFIER	BLMA 0830-3	087193A	Note	
BONN	POWER AMPLIFIER	BLMA 2060-2	087193B	Note	
Agilent	Dual Directional Coupler	778D	20500	Note	
Agilent	Dual Directional Coupler	11691D	MY48151020	Note	

Note:

Prior to system verification and validation, the path loss from the signal generator to the system check source and the power meter, which includes the amplifier, cable, attenuator and directional coupler, was measured by the network analyzer. The reading of the power meter was offset by the path loss difference between the path to the power meter and the path to the system check source to monitor the actual power level fed to the system check source.

11. System Verification

11.1 Tissue Simulating Liquids

For the measurement of the field distribution inside the SAM phantom with DASY, the phantom must be filled with around 25 liters of homogeneous body tissue simulating liquid. For head SAR testing, the liquid height from the ear reference point (ERP) of the phantom to the liquid top surface is larger than 15 cm, which is shown in Fig. 10.1. For body SAR testing, the liquid height from the center of the flat phantom to the liquid top surface is larger than 15 cm, which is shown in Fig. 10.2.

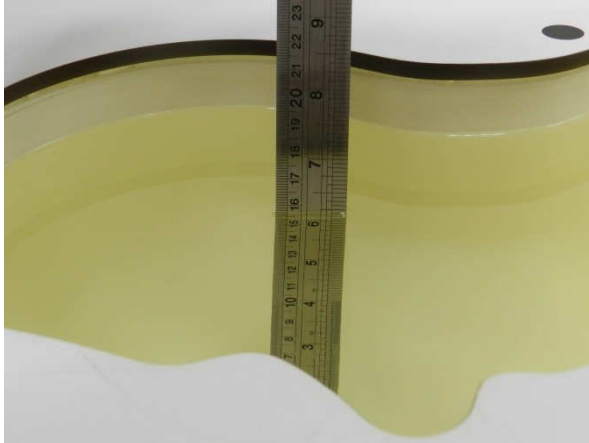

Fig 11.1.1 Photo of Liquid Height for Head SAR



Fig 11.1.2 Photo of Liquid Height for Body SAR



11.2 Tissue Verification

The following tissue formulations are provided for reference only as some of the parameters have not been thoroughly verified. The composition of ingredients may be modified accordingly to achieve the desired target tissue parameters required for routine SAR evaluation.

Frequency (MHz)	Water (%)	Sugar (%)	Cellulose (%)	Salt (%)	Preventol (%)	DGBE (%)	Conductivity (σ)	Permittivity (ε _r)
For Head								
835	40.3	57.9	0.2	1.4	0.2	0	0.90	41.5
1800, 1900, 2000	55.2	0	0	0.3	0	44.5	1.40	40.0
2450	55.0	0	0	0	0	45.0	1.80	39.2
2600	54.8	0	0	0.1	0	45.1	1.96	39.0

Simulating Liquid for 5GHz, Manufactured by SPEAG

Ingredients	(% by weight)
Water	64~78%
Mineral oil	11~18%
Emulsifiers	9~15%
Additives and Salt	2~3%

<Tissue Dielectric Parameter Check Results>

Frequency (MHz)	Tissue Type	Liquid Temp. (°C)	Conductivity (σ)	Permittivity (ε _r)	Conductivity Target (σ)	Permittivity Target (ε _r)	Delta (σ) (%)	Delta (ε _r) (%)	Limit (%)	Date
835	Head	22.8	0.911	42.724	0.9	41.5	1.22	2.95	±5	2020.2.27
1750	Head	22.7	1.343	38.54	1.37	40.1	-1.97	-3.89	±5	2020.2.26
1900	Head	22.7	1.389	41.478	1.4	40	-0.79	3.70	±5	2020.2.26
2450	Head	22.7	1.86	38.535	1.8	39.2	3.33	-1.70	±5	2019.11.12
2600	Head	22.8	2.051	40.175	1.96	39	4.64	3.01	±5	2020.2.25
5250	Head	22.9	4.595	36.402	4.71	35.9	-2.44	1.40	±5	2019.12.23
5600	Head	22.9	4.986	35.822	5.07	35.5	-1.66	0.91	±5	2019.12.23
5750	Head	22.6	5.16	35.569	5.22	35.4	-1.15	0.48	±5	2019.12.23

11.3 System Performance Check Results

Comparing to the original SAR value provided by SPEAG, the verification data should be within its specification of 10 %. Below table shows the target SAR and measured SAR after normalized to 1W input power. The table below indicates the system performance check can meet the variation criterion and the plots can be referred to Appendix A of this report.

<1g SAR>

Date	Frequency (MHz)	Tissue Type	Input Power (mW)	Dipole S/N	Probe S/N	DAE S/N	Measured 1g SAR (W/kg)	Targeted 1g SAR (W/kg)	Normalized 1g SAR (W/kg)	Deviation (%)
2020.2.27	835	Head	250	4d151	3279	1358	2.48	9.3	9.92	6.67
2020.2.26	1750	Head	250	1090	3279	1358	9.55	36.4	38.2	4.95
2020.2.26	1900	Head	250	5d170	3279	1358	9.34	39	37.36	-4.21
2019.11.12	2450	Head	250	908	3279	1358	13	52.8	52	-1.52
2020.2.25	2600	Head	250	1078	3279	1358	13.7	57.6	54.8	-4.86
2019.12.23	5250	Head	100	1113	3857	1358	7.6	80.5	76	-5.59
2019.12.23	5600	Head	100	1113	3857	1358	8.01	83.4	80.1	-3.96
2019.12.23	5750	Head	100	1113	3857	1358	7.82	80	78.2	-2.25

<10g SAR>

Date	Frequency (MHz)	Tissue Type	Input Power (mW)	Dipole S/N	Probe S/N	DAE S/N	Measured 10g SAR (W/kg)	Targeted 10g SAR (W/kg)	Normalized 10g SAR (W/kg)	Deviation (%)
2020.2.26	1900	Head	250	5d170	3279	1358	5	20.3	20	-1.48
2019.12.23	5250	Head	100	1113	3857	1358	2.14	23.1	21.4	-7.36
2019.12.23	5600	Head	100	1113	3857	1358	2.25	23.8	22.5	-5.46

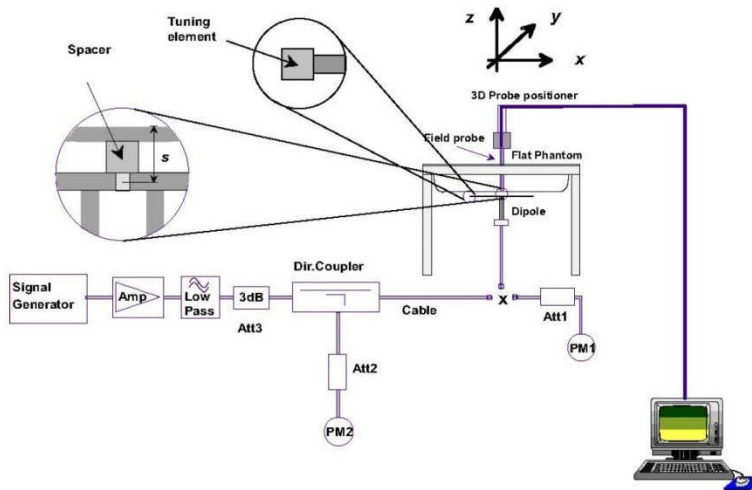

Fig 11.3.1 System Performance Check Setup



Fig 11.3.2 Setup Photo

12. RF Exposure Positions

12.1 Ear and handset reference point

Figure 11.1.1 shows the front, back, and side views of the SAM phantom. The center-of-mouth reference point is labeled “M,” the left ear reference point (ERP) is marked “LE,” and the right ERP is marked “RE.” Each ERP is 15 mm along the B-M (back-mouth) line behind the entrance-to-ear-canal (EEC) point, as shown in Figure 11.1.2 The Reference Plane is defined as passing through the two ear reference points and point M. The line N-F (neck-front), also called the reference pivoting line, is normal to the Reference Plane and perpendicular to both a line passing through RE and LE and the B-M line (see Figure 11.1.3). Both N-F and B-M lines should be marked on the exterior of the phantom shell to facilitate handset positioning. Posterior to the N-F line the ear shape is a flat surface with 6 mm thickness at each ERP, and forward of the N-F line the ear is truncated, as illustrated in Figure 11.1.2. The ear truncation is introduced to preclude the ear lobe from interfering with handset tilt, which could lead to unstable positioning at the cheek.

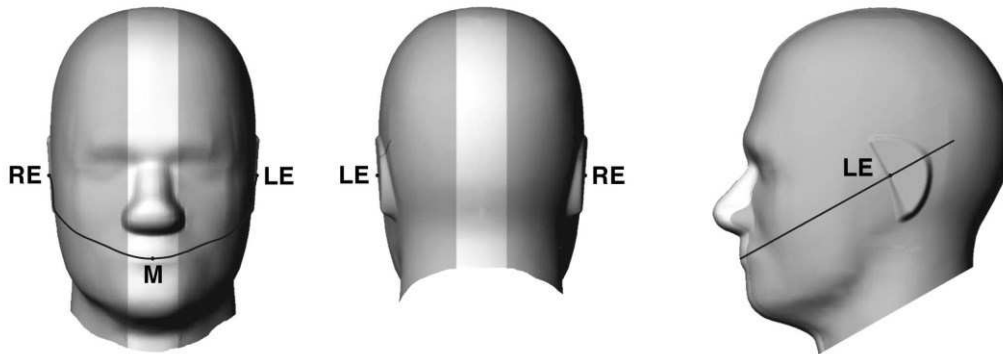

Fig 11.1.1 Front, back, and side views of SAM twin phantom

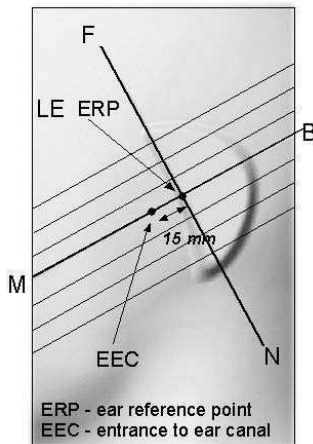

Fig 11.1.2 Close-up side view of phantom showing the ear region.

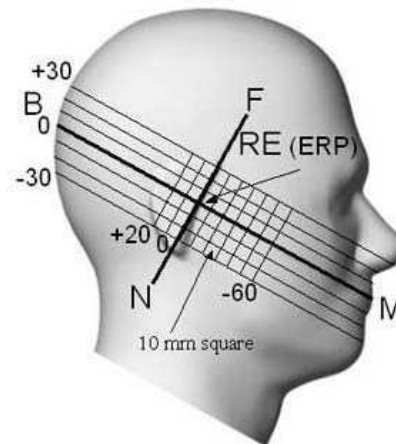

Fig 11.1.3 Side view of the phantom showing relevant markings and seven cross-sectional plane locations

12.2 Definition of the cheek position

1. Ready the handset for talk operation, if necessary. For example, for handsets with a cover piece (flip cover), open the cover. If the handset can transmit with the cover closed, both configurations must be tested.
2. Define two imaginary lines on the handset—the vertical centerline and the horizontal line. The vertical centerline passes through two points on the front side of the handset—the midpoint of the width w_t of the handset at the level of the acoustic output (point A in Figure 11.2.1 and Figure 11.2.2), and the midpoint of the width w_b of the bottom of the handset (point B). The horizontal line is perpendicular to the vertical centerline and passes through the center of the acoustic output (see Figure 11.2.1). The two lines intersect at point A. Note that for many handsets, point A coincides with the center of the acoustic output; however, the acoustic output may be located elsewhere on the horizontal line. Also note that the vertical centerline is not necessarily parallel to the front face of the handset (see Figure 11.2.2), especially for clamshell handsets, handsets with flip covers, and other irregularly-shaped handsets.
3. Position the handset close to the surface of the phantom such that point A is on the (virtual) extension of the line passing through points RE and LE on the phantom (see Figure 11.2.3), such that the plane defined by the vertical centerline and the horizontal line of the handset is approximately parallel to the sagittal plane of the phantom.
4. Translate the handset towards the phantom along the line passing through RE and LE until handset point A touches the pinna at the ERP.
5. While maintaining the handset in this plane, rotate it around the LE-RE line until the vertical centerline is in the plane normal to the plane containing B-M and N-F lines, i.e., the Reference Plane.
6. Rotate the handset around the vertical centerline until the handset (horizontal line) is parallel to the N-F line.
7. While maintaining the vertical centerline in the Reference Plane, keeping point A on the line passing through RE and LE, and maintaining the handset contact with the pinna, rotate the handset about the N-F line until any point on the handset is in contact with a phantom point below the pinna on the cheek. See Figure 11.2.3. The actual rotation angles should be documented in the test report.

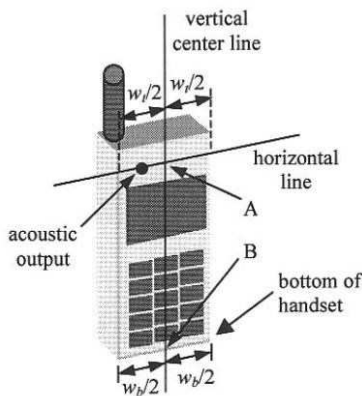

Fig 11.2.1 Handset vertical and horizontal reference lines—“fixed case”

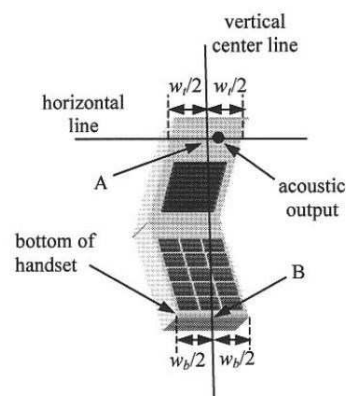

Fig 11.2.2 Handset vertical and horizontal reference lines—“clam-shell case”

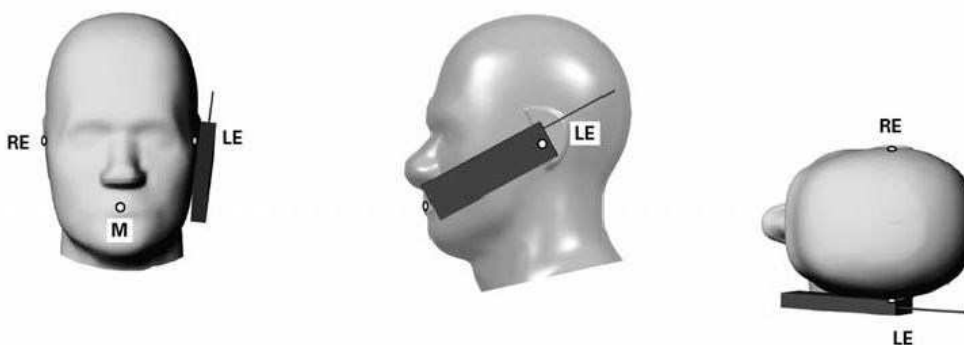

Fig 11.2.3 cheek or touch position. The reference points for the right ear (RE), left ear (LE), and mouth (M), which establish the Reference Plane for handset positioning, are indicated.

12.3 Definition of the tilt position

1. Ready the handset for talk operation, if necessary. For example, for handsets with a cover piece (flip cover), open the cover. If the handset can transmit with the cover closed, both configurations must be tested.
2. While maintaining the orientation of the handset, move the handset away from the pinna along the line passing through RE and LE far enough to allow a rotation of the handset away from the cheek by 15°.
3. Rotate the handset around the horizontal line by 15°.
4. While maintaining the orientation of the handset, move the handset towards the phantom on the line passing through RE and LE until any part of the handset touches the ear. The tilt position is obtained when the contact point is on the pinna. See Figure 11.3.1. If contact occurs at any location other than the pinna, e.g., the antenna at the back of the phantom head, the angle of the handset should be reduced. In this case, the tilt position is obtained if any point on the handset is in contact with the pinna and a second point

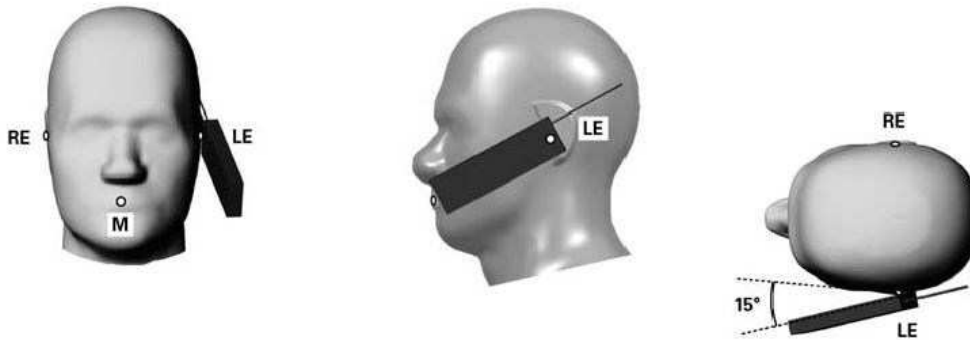

Fig 11.3.1 Tilt position. The reference points for the right ear (RE), left ear (LE), and mouth (M), which define the Reference Plane for handset positioning, are indicated.

12.4 Body Worn Accessory

Body-worn operating configurations are tested with the belt-clips and holsters attached to the device and positioned against a flat phantom in a normal use configuration (see Figure 11.4). Per KDB648474 D04v01r03, body-worn accessory exposure is typically related to voice mode operations when handsets are carried in body-worn accessories. The body-worn accessory procedures in FCC KDB 447498 D01v06 should be used to test for body-worn accessory SAR compliance, without a headset connected to it. This enables the test results for such configuration to be compatible with that required for hotspot mode when the body-worn accessory test separation distance is greater than or equal to that required for hotspot mode, when applicable. When the reported SAR for body-worn accessory, measured without a headset connected to the handset is $> 1.2 \text{ W/kg}$, the highest reported SAR configuration for that wireless mode and frequency band should be repeated for that body-worn accessory with a handset attached to the handset.

Accessories for body-worn operation configurations are divided into two categories: those that do not contain metallic components and those that do contain metallic components. When multiple accessories that do not contain metallic components are supplied with the device, the device is tested with only the accessory that dictates the closest spacing to the body. Then multiple accessories that contain metallic components are tested with the device with each accessory. If multiple accessories share an identical metallic component (i.e. the same metallic belt-chip used with different holsters with no other metallic components) only the accessory that dictates the closest spacing to the body is tested.

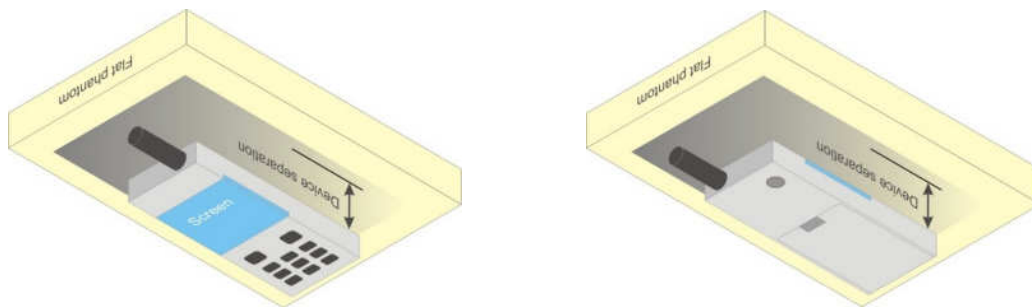

Fig 11.4 Body Worn Position



12.5 Product Specific 10g SAR Exposure

For smart phones with a display diagonal dimension > 15.0 cm or an overall diagonal dimension > 16.0 cm that provide similar mobile web access and multimedia support found in mini-tablets or UMPC mini-tablets that support voice calls next to the ear, According to KDB648474 D04v01r03, the following phablet procedures should be applied to evaluate SAR compliance for each applicable wireless modes and frequency band. Devices marketed as phablets, regardless of form factors and operating characteristics must be tested as a phablet to determine SAR compliance

1. The normally required head and body-worn accessory SAR test procedures for handsets, including hotspot mode, must be applied.
2. The UMPC mini-tablet procedures must also be applied to test the SAR of all surfaces and edges with an antenna located at ≤ 25 mm from that surface or edge, in direct contact with a flat phantom, for 10-g extremity SAR according to the body-equivalent tissue dielectric parameters in KDB 865664 to address interactive hand use exposure conditions.6 The UMPC mini-tablet 1-g SAR at 5 mm is not required. When hotspot mode applies, 10-g extremity SAR is required only for the surfaces and edges with hotspot mode 1-g reported SAR > 1.2 W/kg.

12.6 Wireless Router

Some battery-operated handsets have the capability to transmit and receive user through simultaneous transmission of WIFI simultaneously with a separate licensed transmitter. The FCC has provided guidance in FCC KDB Publication 941225 D06 v02r01 where SAR test considerations for handsets (L x W ≥ 9 cm x 5 cm) are based on a composite test separation distance of 10mm from the front, back and edges of the device containing transmitting antennas within 2.5cm of their edges, determined from general mixed use conditions for this type of devices. Since the hotspot SAR results may overlap with the body-worn accessory SAR requirements, the more conservative configurations can be considered, thus excluding some body-worn accessory SAR tests.

When the user enables the personal wireless router functions for the handset, actual operations include simultaneous transmission of both the WIFI transmitter and another licensed transmitter. Both transmitters often do not transmit at the same transmitting frequency and thus cannot be evaluated for SAR under actual use conditions due to the limitations of the SAR assessment probes. Therefore, SAR must be evaluated for each frequency transmission and mode separately and spatially summed with the WIFI transmitter according to FCC KDB Publication 447498 D01v06 publication procedures. The "Portable Hotspot" feature on the handset was NOT activated during SAR assessments, to ensure the SAR measurements were evaluated for a single transmission frequency RF signal at a time.



13. Conducted RF Output Power (Unit: dBm)

<GSM Conducted Power>

General Note:

1. Per KDB 447498 D01v06, the maximum output power channel is used for SAR testing and for further SAR test reduction.
2. Per KDB 941225 D01v03r01, for SAR test reduction for GSM / GPRS / EDGE modes is determined by the source-based time-averaged output power including tune-up tolerance. The mode with highest specified time-averaged output power should be tested for SAR compliance in the applicable exposure conditions. For modes with the same specified maximum output power and tolerance, the higher number time-slot configuration should be tested. Therefore, the GPRS 4Tx slots for GSM850/GSM1900 are considered as the primary mode.
3. Other configurations of GSM / GPRS / EDGE are considered as secondary modes. The 3G SAR test reduction procedure is applied, when the maximum output power and tune-up tolerance specified for production units in a secondary mode is $\leq \frac{1}{4}$ dB higher than the primary mode, SAR measurement is not required for the secondary mode.

<WWAN Top/Bottom Antenna--Full Power Mode>

GSM850	Burst Average Power (dBm)			Tune-up Limit (dBm)	Frame-Average Power (dBm)			Tune-up Limit (dBm)
	Tx Channel	128	189		251	128	189	
Frequency (MHz)	824.2	836.4	848.8		824.2	836.4	848.8	
GSM 1 Tx slot	31.97	31.85	31.84	33.00	22.97	22.85	22.84	24.00
GPRS 1 Tx slot	31.96	31.84	31.83	33.00	22.96	22.84	22.83	24.00
GPRS 2 Tx slots	31.49	31.37	31.35	32.00	25.49	25.37	25.35	26.00
GPRS 3 Tx slots	29.98	29.93	29.90	30.00	25.72	25.67	25.64	25.74
GPRS 4 Tx slots	28.97	28.84	28.78	29.00	25.97	25.84	25.78	26.00
EDGE 1 Tx slot	26.91	26.74	26.49	28.00	17.91	17.74	17.49	19.00
EDGE 2 Tx slots	25.61	25.62	25.43	27.00	19.61	19.62	19.43	21.00
EDGE 3 Tx slots	23.72	23.50	23.31	25.00	19.46	19.24	19.05	20.74
EDGE 4 Tx slots	22.23	22.13	22.17	24.00	19.23	19.13	19.17	21.00
GSM1900	Burst Average Power (dBm)			Tune-up Limit (dBm)	Frame-Average Power (dBm)			Tune-up Limit (dBm)
Tx Channel	512	661	810		512	661	810	
Frequency (MHz)	1850.2	1880	1909.8		1850.2	1880	1909.8	
GSM 1 Tx slot	29.87	29.99	30.03	30.50	20.87	20.99	21.03	21.50
GPRS 1 Tx slot	29.85	29.98	30.02	30.50	20.85	20.98	21.02	21.50
GPRS 2 Tx slots	29.13	29.33	29.35	29.50	23.13	23.33	23.35	23.50
GPRS 3 Tx slots	27.40	27.50	27.47	27.50	23.14	23.24	23.21	23.24
GPRS 4 Tx slots	26.33	26.44	26.39	26.50	23.33	23.44	23.39	23.50
EDGE 1 Tx slot	26.02	26.21	26.13	27.00	17.02	17.21	17.13	18.00
EDGE 2 Tx slots	25.13	25.38	25.31	26.00	19.13	19.38	19.31	20.00
EDGE 3 Tx slots	23.37	23.63	23.60	24.00	19.11	19.37	19.34	19.74
EDGE 4 Tx slots	22.36	22.65	22.60	23.00	19.36	19.65	19.60	20.00

Remark: The frame-averaged power is linearly scaled the maximum burst averaged power over 8 time slots.

The calculated method are shown as below:

- Frame-averaged power = Maximum burst averaged power (1 Tx Slot) - 9 dB
- Frame-averaged power = Maximum burst averaged power (2 Tx Slots) - 6 dB
- Frame-averaged power = Maximum burst averaged power (3 Tx Slots) - 4.26 dB
- Frame-averaged power = Maximum burst averaged power (4 Tx Slots) - 3 dB

<WWAN Top Antenna --Reduced Power for Receiver On/Hotspot On>

GSM850	Burst Average Power (dBm)			Tune-up Limit (dBm)	Frame-Average Power (dBm)			Tune-up Limit (dBm)
	Tx Channel	128	189		251	128	189	
Frequency (MHz)	824.2	836.4	848.8		824.2	836.4	848.8	
GSM 1 Tx slot	31.26	31.27	31.15	32.00	22.26	22.27	22.15	23.00
GPRS 1 Tx slot	31.25	31.26	31.14	32.00	22.25	22.26	22.14	23.00
GPRS 2 Tx slots	30.79	30.79	30.69	31.00	24.79	24.79	24.69	25.00
GPRS 3 Tx slots	28.80	28.80	28.63	29.00	24.54	24.54	24.37	24.74
GPRS 4 Tx slots	27.89	27.88	27.72	28.00	24.89	24.88	24.72	25.00
EDGE 1 Tx slot	26.82	26.87	26.85	28.00	17.82	17.87	17.85	19.00
EDGE 2 Tx slots	25.79	25.80	25.80	27.00	19.79	19.80	19.80	21.00
EDGE 3 Tx slots	23.75	23.81	23.82	25.00	19.49	19.55	19.56	20.74
EDGE 4 Tx slots	22.50	22.71	22.64	24.00	19.50	19.71	19.64	21.00
GSM1900								
	Burst Average Power (dBm)			Tune-up Limit (dBm)	Frame-Average Power (dBm)			Tune-up Limit (dBm)
Tx Channel	512	661	810		512	661	810	
Frequency (MHz)	1850.2	1880	1909.8		1850.2	1880	1909.8	
GSM 1 Tx slot	27.31	27.38	27.45	28.00	18.31	18.38	18.45	19.00
GPRS 1 Tx slot	27.30	27.37	27.44	28.00	18.30	18.37	18.44	19.00
GPRS 2 Tx slots	26.29	26.37	26.45	27.00	20.29	20.37	20.45	21.00
GPRS 3 Tx slots	24.32	24.40	24.47	25.00	20.06	20.14	20.21	20.74
GPRS 4 Tx slots	23.29	23.47	23.46	24.00	20.29	20.47	20.46	21.00
EDGE 1 Tx slot	26.07	26.05	26.17	27.00	17.07	17.05	17.17	18.00
EDGE 2 Tx slots	25.21	25.16	25.30	26.00	19.21	19.16	19.30	20.00
EDGE 3 Tx slots	23.33	23.32	23.46	24.00	19.07	19.06	19.20	19.74
EDGE 4 Tx slots	22.29	22.30	22.42	23.00	19.29	19.30	19.42	20.00

Remark: The frame-averaged power is linearly scaled the maximum burst averaged power over 8 time slots.
 The calculated method are shown as below:
 Frame-averaged power = Maximum burst averaged power (1 Tx Slot) - 9 dB
 Frame-averaged power = Maximum burst averaged power (2 Tx Slots) - 6 dB
 Frame-averaged power = Maximum burst averaged power (3 Tx Slots) - 4.26 dB
 Frame-averaged power = Maximum burst averaged power (4 Tx Slots) - 3 dB

<WWAN Bottom Antenna --Reduced Power for Sensor On>

GSM1900	Burst Average Power (dBm)			Tune-up Limit (dBm)	Frame-Average Power (dBm)			Tune-up Limit (dBm)
	Tx Channel	512	661		810	512	661	
Frequency (MHz)	1850.2	1880	1909.8		1850.2	1880	1909.8	
GSM 1 Tx slot	28.66	28.73	28.87	29.50	19.66	19.73	19.87	20.50
GPRS 1 Tx slot	28.65	28.72	28.86	29.50	19.65	19.72	19.86	20.50
GPRS 2 Tx slots	26.92	27.00	27.17	27.50	20.92	21.00	21.17	21.50
GPRS 3 Tx slots	24.92	25.01	25.20	25.50	20.66	20.75	20.94	21.24
GPRS 4 Tx slots	23.87	23.95	24.13	24.50	20.87	20.95	21.13	21.50
EDGE 1 Tx slot	26.18	26.16	26.33	27.00	17.18	17.16	17.33	18.00
EDGE 2 Tx slots	25.35	25.31	25.51	26.00	19.35	19.31	19.51	20.00
EDGE 3 Tx slots	23.47	23.43	23.68	24.00	19.21	19.17	19.42	19.74
EDGE 4 Tx slots	22.46	22.45	22.71	23.00	19.46	19.45	19.71	20.00

Remark: The frame-averaged power is linearly scaled the maximum burst averaged power over 8 time slots.
 The calculated method are shown as below:
 Frame-averaged power = Maximum burst averaged power (1 Tx Slot) - 9 dB
 Frame-averaged power = Maximum burst averaged power (2 Tx Slots) - 6 dB
 Frame-averaged power = Maximum burst averaged power (3 Tx Slots) - 4.26 dB
 Frame-averaged power = Maximum burst averaged power (4 Tx Slots) - 3 dB



<WWAN Bottom Antenna --Reduced Power for Hotspot On>

GSM1900 Tx Channel	Burst Average Power (dBm)			Tune-up Limit (dBm)	Frame-Average Power (dBm)			Tune-up Limit (dBm)
	512	661	810		512	661	810	
Frequency (MHz)	1850.2	1880	1909.8		1850.2	1880	1909.8	
GSM 1 Tx slot	27.86	27.98	28.10	28.50	18.86	18.98	19.10	19.50
GPRS 1 Tx slot	27.85	27.94	28.09	28.50	18.85	18.94	19.09	19.50
GPRS 2 Tx slots	24.92	25.01	25.22	26.00	18.92	19.01	19.22	20.00
GPRS 3 Tx slots	22.90	22.99	23.18	24.00	18.64	18.73	18.92	19.74
GPRS 4 Tx slots	21.83	21.92	22.13	23.00	18.83	18.92	19.13	20.00
EDGE 1 Tx slot	26.18	26.16	26.33	27.00	17.18	17.16	17.33	18.00
EDGE 2 Tx slots	25.35	25.31	25.51	26.00	19.35	19.31	19.51	20.00
EDGE 3 Tx slots	23.47	23.43	23.68	24.00	19.21	19.17	19.42	19.74
EDGE 4 Tx slots	22.46	22.45	22.71	23.00	19.46	19.45	19.71	20.00

Remark: The frame-averaged power is linearly scaled the maximum burst averaged power over 8 time slots.
 The calculated method are shown as below:
 Frame-averaged power = Maximum burst averaged power (1 Tx Slot) - 9 dB
 Frame-averaged power = Maximum burst averaged power (2 Tx Slots) - 6 dB
 Frame-averaged power = Maximum burst averaged power (3 Tx Slots) - 4.26 dB
 Frame-averaged power = Maximum burst averaged power (4 Tx Slots) - 3 dB

<WCDMA Conducted Power>

1. The following tests were conducted according to the test requirements outlines in 3GPP TS 34.121 specification.
2. The procedures in KDB 941225 D01v03r01 are applied for 3GPP Rel. 6 HSPA to configure the device in the required sub-test mode(s) to determine SAR test exclusion.
3. For HSPA+ devices supporting 16 QAM in the uplink, power measurements procedure is according to the configurations in Table C.11.1.4 of 3GPP TS 34.121-1.
4. For DC-HSDPA, the device was configured according to the H-Set 12, Fixed Reference Channel (FRC) configuration in Table C.8.1.12 of 3GPP TS 34.121-1, with the primary and the secondary serving HS-DSCH Cell enabled during the power measurement.

A summary of these settings are illustrated below:

HSDPA Setup Configuration:

- a. The EUT was connected to Base Station Agilent E5515C referred to the Setup Configuration.
- b. The RF path losses were compensated into the measurements.
- c. A call was established between EUT and Base Station with following setting:
 - i. Set Gain Factors (β_c and β_d) and parameters were set according to each
 - ii. Specific sub-test in the following table, C10.1.4, quoted from the TS 34.121
 - iii. Set RMC 12.2Kbps + HSDPA mode.
 - iv. Set Cell Power = -86 dBm
 - v. Set HS-DSCH Configuration Type to FRC (H-set 1, QPSK)
 - vi. Select HSDPA Uplink Parameters
 - vii. Set Delta ACK, Delta NACK and Delta CQI = 8
 - viii. Set Ack-Nack Repetition Factor to 3
 - ix. Set CQI Feedback Cycle (k) to 4 ms
 - x. Set CQI Repetition Factor to 2
 - xi. Power Ctrl Mode = All Up bits
- d. The transmitted maximum output power was recorded.

Table C.10.1.4: β values for transmitter characteristics tests with HS-DPCCH

Sub-test	β_c	β_d	β_d (SF)	β_c/β_d	β_{hs} (Note 1, Note 2)	CM (dB) (Note 3)	MPR (dB) (Note 3)
1	2/15	15/15	64	2/15	4/15	0.0	0.0
2	12/15 (Note 4)	15/15 (Note 4)	64	12/15 (Note 4)	24/15	1.0	0.0
3	15/15	8/15	64	15/8	30/15	1.5	0.5
4	15/15	4/15	64	15/4	30/15	1.5	0.5

Note 1: $\Delta_{ACK}, \Delta_{NACK}$ and $\Delta_{CQI} = 30/15$ with $\beta_{hs} = 30/15 * \beta_c$.

Note 2: For the HS-DPCCH power mask requirement test in clause 5.2C, 5.7A, and the Error Vector Magnitude (EVM) with HS-DPCCH test in clause 5.13.1A, and HSDPA EVM with phase discontinuity in clause 5.13.1AA, Δ_{ACK} and $\Delta_{NACK} = 30/15$ with $\beta_{hs} = 30/15 * \beta_c$, and $\Delta_{CQI} = 24/15$ with $\beta_{hs} = 24/15 * \beta_c$.

Note 3: CM = 1 for $\beta_c/\beta_d = 12/15, \beta_{hs}/\beta_c = 24/15$. For all other combinations of DPDCCH, DPCCH and HS-DPCCH the MPR is based on the relative CM difference. This is applicable for only UEs that support HSDPA in release 6 and later releases.

Note 4: For subtest 2 the β_c/β_d ratio of 12/15 for the TFC during the measurement period (TF1, TF0) is achieved by setting the signalled gain factors for the reference TFC (TF1, TF1) to $\beta_c = 11/15$ and $\beta_d = 15/15$.

Setup Configuration

HSUPA Setup Configuration:

- a. The EUT was connected to Base Station Agilent E5515C referred to the Setup Configuration.
- b. The RF path losses were compensated into the measurements.
- c. A call was established between EUT and Base Station with following setting * :
 - i. Call Configs = 5.2B, 5.9B, 5.10B, and 5.13.2B with QPSK
 - ii. Set the Gain Factors (β_c and β_d) and parameters (AG Index) were set according to each specific sub-test in the following table, C11.1.3, quoted from the TS 34.121
 - iii. Set Cell Power = -86 dBm
 - iv. Set Channel Type = 12.2k + HSPA
 - v. Set UE Target Power
 - vi. Power Ctrl Mode= Alternating bits
 - vii. Set and observe the E-TFCl
 - viii. Confirm that E-TFCl is equal to the target E-TFCl of 75 for sub-test 1, and other subtest's E-TFCl
- d. The transmitted maximum output power was recorded.

Table C.11.1.3: β values for transmitter characteristics tests with HS-DPCCH and E-DCH

Sub-test	β_c	β_d	β_d (SF)	β_c/β_d	β_{HS} (Note1)	β_{ec}	β_{ed} (Note 4) (Note 5)	β_{ed} (SF)	β_{ed} (Codes)	CM (dB) (Note 2)	MPR (dB) (Note 2) (Note 6)	AG Index (Note 5)	E-TFCl
1	11/15 (Note 3)	15/15 (Note 3)	64	11/15 (Note 3)	22/15	209/25	1309/225	4	1	1.0	0.0	20	75
2	6/15	15/15	64	6/15	12/15	12/15	94/75	4	1	3.0	2.0	12	67
3	15/15	9/15	64	15/9	30/15	30/15	$\beta_{ed1}: 47/15$ $\beta_{ed2}: 47/15$	4 4	2	2.0	1.0	15	92
4	2/15	15/15	64	2/15	4/15	2/15	56/75	4	1	3.0	2.0	17	71
5	15/15	0	-	-	5/15	5/15	47/15	4	1	1.0	0.0	12	67

Note 1: For sub-test 1 to 4, Δ_{ACK} , Δ_{NACK} and $\Delta_{CQI} = 30/15$ with $\beta_{hs} = 30/15 * \beta_c$. For sub-test 5, Δ_{ACK} , Δ_{NACK} and $\Delta_{CQI} = 5/15$ with $\beta_{hs} = 5/15 * \beta_c$.

Note 2: CM = 1 for $\beta_c/\beta_d = 12/15$, $\beta_{hs}/\beta_c = 24/15$. For all other combinations of DPDCH, DPCCH, HS-DPCCH, E-DPDCH and E-DPCCH the MPR is based on the relative CM difference.

Note 3: For subtest 1 the β_c/β_d ratio of 11/15 for the TFC during the measurement period (TF1, TF0) is achieved by setting the signalled gain factors for the reference TFC (TF1, TF1) to $\beta_c = 10/15$ and $\beta_d = 15/15$.

Note 4: In case of testing by UE using E-DPDCH Physical Layer category 1, Sub-test 3 is omitted according to TS25.306 Table 5.1g.

Note 5: β_{ed} can not be set directly; it is set by Absolute Grant Value.

Note 6: For subtests 2, 3 and 4, UE may perform E-DPDCH power scaling at max power which could results in slightly smaller MPR values.

Setup Configuration

DC-HSDPA 3GPP release 8 Setup Configuration:

- a. The EUT was connected to Base Station Agilent E5515C referred to the Setup Configuration below
- b. The RF path losses were compensated into the measurements.
- c. A call was established between EUT and Base Station with following setting:
 - i. Set RMC 12.2Kbps + HSDPA mode.
 - ii. Set Cell Power = -25 dBm
 - iii. Set HS-DSCH Configuration Type to FRC (H-set 12, QPSK)
 - iv. Select HSDPA Uplink Parameters
 - v. Set Gain Factors (β_c and β_d) and parameters were set according to each Specific sub-test in the following table, C10.1.4, quoted from the TS 34.121
 - a). Subtest 1: $\beta_c/\beta_d=2/15$
 - b). Subtest 2: $\beta_c/\beta_d=12/15$
 - c). Subtest 3: $\beta_c/\beta_d=15/8$
 - d). Subtest 4: $\beta_c/\beta_d=15/4$
 - vi. Set Delta ACK, Delta NACK and Delta CQI = 8
 - vii. Set Ack-Nack Repetition Factor to 3
 - viii. Set CQI Feedback Cycle (k) to 4 ms
 - ix. Set CQI Repetition Factor to 2
 - x. Power Ctrl Mode = All Up bits
- d. The transmitted maximum output power was recorded.

The following tests were conducted according to the test requirements outlines in 3GPP TS 34.121 specification. A summary of these settings are illustrated below:

C.8.1.12 Fixed Reference Channel Definition H-Set 12

Table C.8.1.12: Fixed Reference Channel H-Set 12

Parameter	Unit	Value
Nominal Avg. Inf. Bit Rate	kbps	60
Inter-TTI Distance	TTI's	1
Number of HARQ Processes	Processes	6
Information Bit Payload (N_{INF})	Bits	120
Number Code Blocks	Blocks	1
Binary Channel Bits Per TTI	Bits	960
Total Available SML's in UE	SML's	19200
Number of SML's per HARQ Proc.	SML's	3200
Coding Rate		0.15
Number of Physical Channel Codes	Codes	1
Modulation		QPSK
Note 1: The RMC is intended to be used for DC-HSDPA mode and both cells shall transmit with identical parameters as listed in the table. Note 2: Maximum number of transmission is limited to 1, i.e., retransmission is not allowed. The redundancy and constellation version 0 shall be used.		

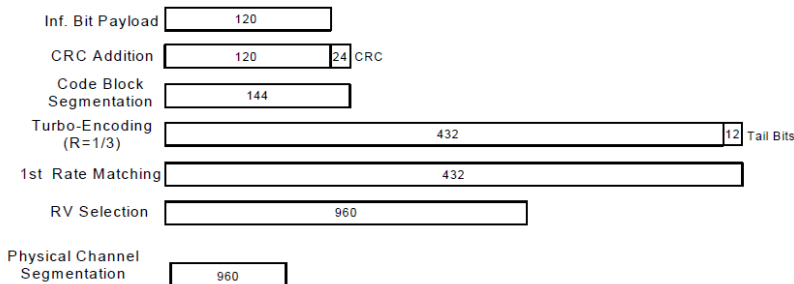

Figure C.8.19: Coding rate for Fixed reference Channel H-Set 12 (QPSK)

Setup Configuration



HSPA+ 3GPP release 7 (uplink category 7) 16QAM, Setup Configuration:

- a. The EUT was connected to Base Station Agilent E5515C referred to the Setup Configuration.
- b. The RF path losses were compensated into the measurements.
- c. A call was established between EUT and Base Station with following setting * :
 - i. Call Configs = 5.2E:HSPA+:UL with 16QAM
 - ii. Set the Gain Factors (β_c and β_d) and parameters (AG Index) were set according to each specific sub-test in the following table, C11.1.4, quoted from the TS 34.121-1 s5.2E
 - iii. Set Channel Parm
 - iv. Set Cell Power = -86 dBm
 - v. Set Channel Type = HSPA
 - vi. Set UE Target Power =21 dBm
 - vii. Power Ctrl Mode= All Up Bits
 - viii. Set Manual Uplink DPCH Bc/Bd = Manual
 - ix. Set Manual Uplink DPCH Bc and Bd=15,15(for 34.121-1 v8.10.0 table C11.1.4 sub-test 1)
 - x. Set HSPA Conn DL Channel Levels
 - xi. Set HS-SCCH Configs
 - xii. Set RB Test Mode Setup
 - xiii. Set Common HSUPA Parameters
 - xiv. Set Serving Grant
 - xv. Confirm that E-TFCI is equal to the target E-TFCI of 105 for sub-test 1, and other subtest's E-TFCI
- d. The transmitted maximum output power was recorded.

Table C.11.1.4: β values for transmitter characteristics tests with HS-DPCCH and E-DCH with 16QAM

Sub-test	β_c (Note3)	β_d	β_{HS} (Note1)	β_{ec}	β_{ed} (2xSF2) (Note 4)	β_{ed} (2xSF4) (Note 4)	CM (dB) (Note 2)	MPR (dB) (Note 2)	AG Index (Note 4)	E-TFCI (Note 5)	E-TFCI (boost)
1	1	0	30/15	30/15	β_{ed1} : 30/15 β_{ed2} : 30/15	β_{ed3} : 24/15 β_{ed4} : 24/15	3.5	2.5	14	105	105

Note 1: $\Delta_{ACK}, \Delta_{NACK}$ and $\Delta_{CQI} = 30/15$ with $\beta_{HS} = 30/15 * \beta_c$.

Note 2: CM = 3.5 and the MPR is based on the relative CM difference, MPR = MAX(CM-1,0).

Note 3: DPDCH is not configured, therefore the β_c is set to 1 and $\beta_d = 0$ by default.

Note 4: β_{ed} can not be set directly; it is set by Absolute Grant Value.

Note 5: All the sub-tests require the UE to transmit 2SF2+2SF4 16QAM EDCH and they apply for UE using E-DPDCH category 7. E-DCH TTI is set to 2ms TTI and E-DCH table index = 2. To support these E-DCH configurations DPDCH is not allocated. The UE is signaled to use the extrapolation algorithm.

Setup Configuration



<WCDMA Conducted Power>

General Note:

- Per KDB 941225 D01v03r01, for SAR testing is measured using a 12.2 kbps RMC with TPC bits configured to all "1's".
- Per KDB 941225 D01v03r01, RMC 12.2kbps setting is used to evaluate SAR. The maximum output power and tune-up tolerance specified for production units in HSDPA / HSUPA / DC-HSDPA / HSPA+ is ≤ ¼ dB higher than RMC 12.2Kbps or when the highest reported SAR of the RMC12.2Kbps is scaled by the ratio of specified maximum output power and tune-up tolerance of HSDPA / HSUPA / DC-HSDPA / HSPA+ to RMC12.2Kbps and the adjusted SAR is ≤ 1.2 W/kg, SAR measurement is not required for HSDPA / HSUPA / DC-HSDPA / HSPA+, and according to the following RF output power, the output power results of the secondary modes (HSDPA / HSUPA / DC-HSDPA / HSPA+) are less than ¼ dB higher than the primary modes; therefore, SAR measurement is not required for HSDPA / HSUPA / DC-HSDPA / HSPA+.

<WWAN Top/Bottom Antenna--Full Power Mode>

Band		WCDMA Band II			Tune-up Limit (dBm)	WCDMA Band IV			Tune-up Limit (dBm)	WCDMA Band V			Tune-up Limit (dBm)
Tx Channel		9262	9400	9538		1312	1413	1513		4132	4182	4233	
Rx Channel		9662	9800	9938		1537	1638	1738		4357	4407	4458	
Frequency (MHz)		1852.4	1880	1907.6	1712.4	1732.6	1752.6	826.4	836.4	846.6			
3GPP Rel 99	AMR 12.2Kbps	23.95	23.97	24.06	24.50	24.22	24.09	24.17	24.50	24.10	24.02	24.00	24.50
3GPP Rel 99	RMC 12.2Kbps	23.96	23.98	24.08	24.50	24.23	24.10	24.19	24.50	24.12	24.04	24.01	24.50
3GPP Rel 6	HSDPA Subtest-1	22.60	22.70	22.75	23.50	23.28	23.16	23.24	23.50	23.08	23.01	23.05	23.50
3GPP Rel 6	HSDPA Subtest-2	22.54	22.63	22.72	23.50	23.24	23.19	23.25	23.50	23.09	22.90	22.89	23.50
3GPP Rel 6	HSDPA Subtest-3	22.15	22.14	22.23	23.00	22.77	22.67	22.77	23.00	22.44	22.37	22.44	23.00
3GPP Rel 6	HSDPA Subtest-4	22.15	22.19	22.25	23.00	22.73	22.66	22.78	23.00	22.46	22.38	22.35	23.00
3GPP Rel 8	DC-HSDPA Subtest-1	22.50	22.67	22.65	23.50	23.17	23.03	23.14	23.50	22.95	22.92	22.92	23.50
3GPP Rel 8	DC-HSDPA Subtest-2	22.40	22.56	22.65	23.50	23.15	23.10	23.12	23.50	23.00	22.83	22.97	23.50
3GPP Rel 8	DC-HSDPA Subtest-3	22.03	22.05	22.13	23.00	22.67	22.53	22.63	23.00	22.34	22.26	22.33	23.00
3GPP Rel 8	DC-HSDPA Subtest-4	22.04	22.10	22.12	23.00	22.67	22.54	22.64	23.00	22.33	22.23	22.23	23.00
3GPP Rel 6	HSUPA Subtest-1	20.58	20.71	20.74	21.50	21.28	21.11	21.20	21.50	21.10	21.11	20.99	21.50
3GPP Rel 6	HSUPA Subtest-2	20.69	20.65	20.76	21.50	21.28	21.12	21.24	21.50	21.16	21.08	21.09	21.50
3GPP Rel 6	HSUPA Subtest-3	21.66	21.72	21.74	22.50	22.24	22.18	22.21	22.50	22.09	21.96	22.06	22.50
3GPP Rel 6	HSUPA Subtest-4	20.16	20.13	20.21	21.50	20.79	20.64	20.72	21.50	20.57	20.53	20.54	21.50
3GPP Rel 6	HSUPA Subtest-5	21.70	21.70	21.70	23.50	22.30	22.10	22.30	23.50	22.10	22.00	21.90	23.50
3GPP Rel 7	HSPA+ (16QAM) Subtest-1	21.50	21.48	21.23	22.50	21.63	21.74	21.83	22.50	21.65	21.57	21.58	22.50



<WWAN Top Antenna --Reduced Power for Receiver On/ Hotspot On >

Band		WCDMA Band II			Tune-up Limit (dBm)	WCDMA Band IV			Tune-up Limit (dBm)	WCDMA Band V			Tune-up Limit (dBm)
Tx Channel		9262	9400	9538		1312	1413	1513		4132	4182	4233	
Rx Channel		9662	9800	9938		1537	1638	1738		4357	4407	4458	
Frequency (MHz)		1852.4	1880	1907.6	1712.4	1732.6	1752.6	826.4	836.4	846.6			
3GPP Rel 99	AMR 12.2Kbps	20.31	20.05	20.21	20.50	20.06	20.13	20.19	21.00	23.02	22.89	22.84	23.50
3GPP Rel 99	RMC 12.2Kbps	20.32	20.06	20.33	20.50	20.07	20.14	20.20	21.00	23.03	22.90	23.04	23.50
3GPP Rel 6	HSDPA Subtest-1	19.47	19.34	19.29	19.50	19.64	19.57	19.52	20.00	22.47	22.32	22.28	22.50
3GPP Rel 6	HSDPA Subtest-2	19.39	19.30	19.25	19.50	19.65	19.58	19.49	20.00	22.43	22.24	22.23	22.50
3GPP Rel 6	HSDPA Subtest-3	18.94	18.93	18.78	19.00	19.13	19.05	18.94	19.50	21.97	21.65	21.75	22.00
3GPP Rel 6	HSDPA Subtest-4	18.94	18.92	18.75	19.00	19.11	19.04	18.97	19.50	21.89	21.69	21.75	22.00
3GPP Rel 8	DC-HSDPA Subtest-1	19.44	19.37	19.32	19.50	19.67	19.54	19.49	20.00	22.45	22.46	22.43	22.50
3GPP Rel 8	DC-HSDPA Subtest-2	19.45	19.38	19.29	19.50	19.59	19.50	19.45	20.00	22.43	22.45	22.46	22.50
3GPP Rel 8	DC-HSDPA Subtest-3	18.93	18.85	18.74	19.00	19.14	19.13	18.98	19.50	21.99	22.00	21.98	22.00
3GPP Rel 8	DC-HSDPA Subtest-4	18.91	18.84	18.77	19.00	19.14	19.12	18.95	19.50	21.87	21.80	21.97	22.00
3GPP Rel 6	HSUPA Subtest-1	17.33	17.14	17.34	17.50	17.64	17.62	17.51	18.00	20.41	20.24	20.14	20.50
3GPP Rel 6	HSUPA Subtest-2	17.21	17.16	17.30	17.50	17.61	17.58	17.55	18.00	20.39	20.21	20.26	20.50
3GPP Rel 6	HSUPA Subtest-3	18.37	18.15	18.28	18.50	18.62	18.54	18.50	19.00	21.32	21.23	21.16	21.50
3GPP Rel 6	HSUPA Subtest-4	17.12	16.85	17.04	17.50	17.14	17.16	16.95	18.00	19.79	19.70	19.73	20.50
3GPP Rel 6	HSUPA Subtest-5	18.70	18.40	18.60	19.50	18.60	18.50	18.40	20.00	21.40	21.00	20.90	22.50
3GPP Rel 7	HSPA+ (16QAM) Subtest-1	18.56	18.23	18.34	19.50	18.56	18.45	18.43	20.00	21.34	21.00	21.00	22.50



<WWAN Bottom Antenna --Reduced Power for Sensor On >

Band		WCDMA Band II			Tune-up Limit (dBm)	WCDMA Band IV			Tune-up Limit (dBm)
Tx Channel		9262	9400	9538		1312	1413	1513	
Rx Channel		9662	9800	9938		1537	1638	1738	
Frequency (MHz)		1852.4	1880	1907.6		1712.4	1732.6	1752.6	
3GPP Rel 99	AMR 12.2Kbps	20.63	20.35	20.55	21.00	21.32	21.28	21.23	22.00
3GPP Rel 99	RMC 12.2Kbps	20.64	20.36	20.65	21.00	21.35	21.29	21.36	22.00
3GPP Rel 6	HSDPA Subtest-1	19.84	19.74	19.83	20.00	20.76	20.70	20.63	21.00
3GPP Rel 6	HSDPA Subtest-2	19.90	19.67	19.77	20.00	20.72	20.61	20.56	21.00
3GPP Rel 6	HSDPA Subtest-3	19.50	19.23	19.37	19.50	20.23	20.21	20.19	20.50
3GPP Rel 6	HSDPA Subtest-4	19.50	19.27	19.33	19.50	20.27	20.26	20.16	20.50
3GPP Rel 8	DC-HSDPA Subtest-1	19.81	19.87	19.89	20.00	20.70	20.73	20.78	21.00
3GPP Rel 8	DC-HSDPA Subtest-2	19.82	19.99	19.78	20.00	20.72	20.67	20.32	21.00
3GPP Rel 8	DC-HSDPA Subtest-3	19.39	19.45	19.45	19.50	20.23	20.21	20.31	20.50
3GPP Rel 8	DC-HSDPA Subtest-4	19.45	19.43	19.34	19.50	20.21	20.23	20.32	20.50
3GPP Rel 6	HSUPA Subtest-1	17.87	17.76	17.88	18.00	18.85	18.80	18.68	19.00
3GPP Rel 6	HSUPA Subtest-2	17.97	17.59	17.86	18.00	18.80	18.78	18.63	19.00
3GPP Rel 6	HSUPA Subtest-3	18.85	18.75	18.91	19.00	19.81	19.77	19.76	20.00
3GPP Rel 6	HSUPA Subtest-4	17.51	17.22	17.24	18.00	18.36	18.28	18.12	19.00
3GPP Rel 6	HSUPA Subtest-5	18.90	18.80	18.80	20.00	19.80	19.70	19.60	21.00
3GPP Rel 7	HSPA+ (16QAM) Subtest-1	18.78	18.82	18.67	19.00	20.00	20.01	19.92	21.00



<WWAN Bottom Antenna --Reduced Power for Hotspot On>

Band		WCDMA Band II			Tune-up Limit (dBm)	WCDMA Band IV			Tune-up Limit (dBm)
Tx Channel		9262	9400	9538		1312	1413	1513	
Rx Channel		9662	9800	9938		1537	1638	1738	
Frequency (MHz)		1852.4	1880	1907.6		1712.4	1732.6	1752.6	
3GPP Rel 99	AMR 12.2Kbps	17.86	17.65	17.87	18.00	21.32	21.28	21.23	22.00
3GPP Rel 99	RMC 12.2Kbps	17.87	17.68	17.88	18.00	21.35	21.29	21.36	22.00
3GPP Rel 6	HSDPA Subtest-1	16.90	16.67	16.80	17.00	20.76	20.70	20.63	21.00
3GPP Rel 6	HSDPA Subtest-2	16.85	16.64	16.76	17.00	20.72	20.61	20.56	21.00
3GPP Rel 6	HSDPA Subtest-3	16.46	16.17	16.31	16.50	20.23	20.21	20.19	20.50
3GPP Rel 6	HSDPA Subtest-4	16.38	16.14	16.25	16.50	20.27	20.26	20.16	20.50
3GPP Rel 8	DC-HSDPA Subtest-1	16.87	16.68	16.76	17.00	20.70	20.73	20.78	21.00
3GPP Rel 8	DC-HSDPA Subtest-2	16.98	16.71	16.72	17.00	20.72	20.67	20.32	21.00
3GPP Rel 8	DC-HSDPA Subtest-3	16.43	16.34	16.43	16.50	20.23	20.21	20.31	20.50
3GPP Rel 8	DC-HSDPA Subtest-4	16.45	16.41	16.34	16.50	20.21	20.23	20.32	20.50
3GPP Rel 6	HSUPA Subtest-1	14.91	14.67	14.80	15.00	18.85	18.80	18.68	19.00
3GPP Rel 6	HSUPA Subtest-2	14.95	14.70	14.75	15.00	18.80	18.78	18.63	19.00
3GPP Rel 6	HSUPA Subtest-3	15.92	15.67	15.81	16.00	19.81	19.77	19.76	20.00
3GPP Rel 6	HSUPA Subtest-4	14.44	14.19	14.23	15.00	18.36	18.28	18.12	19.00
3GPP Rel 6	HSUPA Subtest-5	16.00	15.70	15.80	17.00	19.80	19.70	19.60	21.00
3GPP Rel 7	HSPA+ (16QAM) Subtest-1	16.12	15.80	15.78	17.00	20.00	20.01	19.92	21.00

<LTE Conducted Power>

General Note:

1. Anritsu MT8820C base station simulator was used to setup the connection with EUT; the frequency band, channel bandwidth, RB allocation configuration, modulation type are set in the base station simulator to configure EUT transmitting at maximum power and at different configurations which are requested to be reported to FCC, for conducted power measurement and SAR testing.
2. Per KDB 941225 D05v02r05, when a properly configured base station simulator is used for the SAR and power measurements, spectrum plots for each RB allocation and offset configuration is not required.
3. Per KDB 941225 D05v02r05, start with the largest channel bandwidth and measure SAR for QPSK with 1 RB allocation, using the RB offset and required test channel combination with the highest maximum output power for RB offsets at the upper edge, middle and lower edge of each required test channel.
4. Per KDB 941225 D05v02r05, 50% RB allocation for QPSK SAR testing follows 1RB QPSK allocation procedure.
5. Per KDB 941225 D05v02r05, for QPSK with 100% RB allocation, SAR is not required when the highest maximum output power for 100 % RB allocation is less than the highest maximum output power in 50% and 1 RB allocations and the highest reported SAR for 1 RB and 50% RB allocation are ≤ 0.8 W/kg. Otherwise, SAR is measured for the highest output power channel; and if the reported SAR is > 1.45 W/kg, the remaining required test channels must also be tested.
6. Per KDB 941225 D05v02r05, 16QAM output power for each RB allocation configuration is $>$ not $\frac{1}{2}$ dB higher than the same configuration in QPSK and the reported SAR for the QPSK configuration is ≤ 1.45 W/kg; Per KDB 941225 D05v02r05, 16QAM SAR testing is not required.
7. Per KDB 941225 D05v02r05, smaller bandwidth output power for each RB allocation configuration is $>$ not $\frac{1}{2}$ dB higher than the same configuration in the largest supported bandwidth, and the reported SAR for the largest supported bandwidth is ≤ 1.45 W/kg; Per KDB 941225 D05v02r05, smaller bandwidth SAR testing is not required.
8. For LTE B4 / B5 / B38 the maximum bandwidth does not support three non-overlapping channels, per KDB 941225 D05v02r05, when a device supports overlapping channel assignment in a channel bandwidth configuration, the middle channel of the group of overlapping channels should be selected for testing.
9. According to 2017 TCB workshop, for 64QAM and 16QAM should be verified by checking the signal constellation with a call box to avoid incorrect maximum power levels due to MPR and other requirements associated with signal modulation, and the following figure is taken from the "Fundamental Measurement >> Modulation Analysis >> constellation" mode of the device connect to the MT8821C base station, therefore, the device 64QAM and 16QAM signal modulation are correct.



64QAM

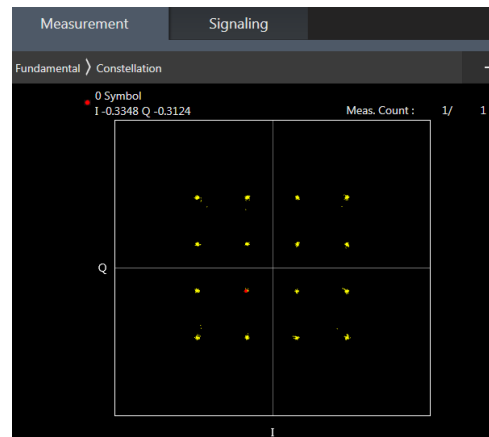

16QAM



<WWAN Top/Bottom Antenna-- Full Power Mode>

<LTE Band 2>

BW [MHz]	Modulation	RB Size	RB Offset	Power Low Ch. / Freq.	Power Middle Ch. / Freq.	Power High Ch. / Freq.	Tune-up limit (dBm)	MPR (dB)
Channel				18700	18900	19100		
Frequency (MHz)				1860	1880	1900		
20	QPSK	1	0	23.69	23.88	23.57	24	0
20	QPSK	1	49	23.80	23.73	23.66		
20	QPSK	1	99	23.67	23.61	23.63		
20	QPSK	50	0	22.77	22.85	22.70	23	1
20	QPSK	50	24	22.84	22.73	22.69		
20	QPSK	50	50	22.69	22.70	22.58		
20	QPSK	100	0	22.71	22.71	22.61	23	1
20	16QAM	1	0	22.79	22.98	22.67		
20	16QAM	1	49	22.61	22.79	22.77		
20	16QAM	1	99	22.64	22.79	22.70	22	2
20	16QAM	50	0	21.68	21.80	21.71		
20	16QAM	50	24	21.83	21.72	21.74		
20	16QAM	50	50	21.66	21.77	21.57		
20	16QAM	100	0	21.61	21.77	21.64	22	2
20	64QAM	1	0	21.70	21.70	21.70		
20	64QAM	1	49	21.82	21.70	21.90		
20	64QAM	1	99	21.54	21.75	21.78	21	3
20	64QAM	50	0	20.76	20.85	20.85		
20	64QAM	50	24	20.88	20.81	20.74		
20	64QAM	50	50	20.86	20.82	20.56		
20	64QAM	100	0	20.83	20.93	20.74		



Channel				18675	18900	19125	Tune-up limit (dBm)	MPR (dB)
Frequency (MHz)				1857.5	1880	1902.5		
15	QPSK	1	0	23.82	23.75	23.69	24	0
15	QPSK	1	37	23.87	23.63	23.67		
15	QPSK	1	74	23.72	23.64	23.69		
15	QPSK	36	0	22.77	22.78	22.65	23	1
15	QPSK	36	20	22.81	22.72	22.76		
15	QPSK	36	39	22.74	22.64	22.55		
15	QPSK	75	0	22.78	22.75	22.70	23	1
15	16QAM	1	0	22.98	22.55	22.69		
15	16QAM	1	37	22.93	22.90	22.82		
15	16QAM	1	74	22.90	22.77	22.99	22	2
15	16QAM	36	0	21.73	21.78	21.71		
15	16QAM	36	20	21.77	21.70	21.71		
15	16QAM	36	39	21.77	21.64	21.71	22	2
15	16QAM	75	0	21.73	21.69	21.66		
15	64QAM	1	0	21.84	21.86	21.85		
15	64QAM	1	37	21.93	21.91	21.84	22	2
15	64QAM	1	74	21.89	21.88	21.80		
15	64QAM	36	0	20.92	20.85	20.85		
15	64QAM	36	20	20.81	20.85	20.76	21	3
15	64QAM	36	39	20.82	20.70	20.80		
15	64QAM	75	0	20.82	20.80	20.74		
Channel				18650	18900	19150	Tune-up limit (dBm)	MPR (dB)
Frequency (MHz)				1855	1880	1905		
10	QPSK	1	0	23.78	23.68	23.60	24	0
10	QPSK	1	25	23.75	23.71	23.63		
10	QPSK	1	49	23.68	23.70	23.65		
10	QPSK	25	0	22.69	22.68	22.72	23	1
10	QPSK	25	12	22.82	22.64	22.65		
10	QPSK	25	25	22.67	22.68	22.60		
10	QPSK	50	0	22.71	22.76	22.68	23	1
10	16QAM	1	0	22.98	22.52	22.94		
10	16QAM	1	25	22.98	22.64	22.73		
10	16QAM	1	49	22.92	22.83	22.76	22	2
10	16QAM	25	0	21.64	21.56	21.72		
10	16QAM	25	12	21.78	21.67	21.77		
10	16QAM	25	25	21.69	21.69	21.63	22	2
10	16QAM	50	0	21.66	21.71	21.61		
10	64QAM	1	0	21.83	21.56	21.88		
10	64QAM	1	25	21.91	21.59	21.83	22	2
10	64QAM	1	49	21.82	21.58	21.79		
10	64QAM	25	0	20.67	20.80	20.68		
10	64QAM	25	12	20.79	20.76	20.78	21	3
10	64QAM	25	25	20.74	20.71	20.59		
10	64QAM	50	0	20.60	20.79	20.59		



Channel				18625	18900	19175	Tune-up limit (dBm)	MPR (dB)
Frequency (MHz)				1852.5	1880	1907.5		
5	QPSK	1	0	23.70	23.63	23.62	24	0
5	QPSK	1	12	23.74	23.65	23.65		
5	QPSK	1	24	23.71	23.65	23.53		
5	QPSK	12	0	22.68	22.74	22.62	23	1
5	QPSK	12	7	22.84	22.73	22.68		
5	QPSK	12	13	22.74	22.67	22.65		
5	QPSK	25	0	22.83	22.62	22.62	23	1
5	16QAM	1	0	22.94	22.66	22.61		
5	16QAM	1	12	22.93	22.63	22.91		
5	16QAM	1	24	22.79	22.80	22.95	22	2
5	16QAM	12	0	21.75	21.67	21.70		
5	16QAM	12	7	21.85	21.73	21.67		
5	16QAM	12	13	21.78	21.66	21.64	22	2
5	16QAM	25	0	21.78	21.59	21.65		
5	64QAM	1	0	21.77	21.78	21.46		
5	64QAM	1	12	21.67	21.80	21.77	22	2
5	64QAM	1	24	21.81	21.69	21.61		
5	64QAM	12	0	20.62	20.59	20.56		
5	64QAM	12	7	20.91	20.54	20.64	21	3
5	64QAM	12	13	20.74	20.63	20.46		
5	64QAM	25	0	20.74	20.65	20.67		
Channel				18615	18900	19185	Tune-up limit (dBm)	MPR (dB)
Frequency (MHz)				1851.5	1880	1908.5		
3	QPSK	1	0	23.68	23.55	23.56	24	0
3	QPSK	1	8	23.74	23.59	23.65		
3	QPSK	1	14	23.67	23.63	23.56		
3	QPSK	8	0	22.83	22.76	22.81	23	1
3	QPSK	8	4	22.92	22.88	22.81		
3	QPSK	8	7	22.83	22.82	22.77		
3	QPSK	15	0	22.94	22.80	22.72	23	1
3	16QAM	1	0	22.82	22.52	22.47		
3	16QAM	1	8	22.72	22.81	22.62		
3	16QAM	1	14	22.73	22.67	22.90	22	2
3	16QAM	8	0	21.97	21.81	21.77		
3	16QAM	8	4	21.96	21.84	21.83		
3	16QAM	8	7	21.93	21.80	21.83	22	2
3	16QAM	15	0	21.85	21.96	21.67		
3	64QAM	1	0	21.52	21.58	21.48		
3	64QAM	1	8	21.81	21.54	21.51	22	2
3	64QAM	1	14	21.53	21.53	21.61		
3	64QAM	8	0	20.85	20.80	20.74		
3	64QAM	8	4	20.94	20.84	20.89	21	3
3	64QAM	8	7	20.81	20.81	21.00		
3	64QAM	15	0	20.96	20.66	20.73		



Channel				18607	18900	19193	Tune-up limit (dBm)	MPR (dB)
Frequency (MHz)				1850.7	1880	1909.3		
1.4	QPSK	1	0	23.60	23.38	23.42	24	0
1.4	QPSK	1	3	23.66	23.56	23.52		
1.4	QPSK	1	5	23.54	23.38	23.55		
1.4	QPSK	3	0	23.67	23.61	23.54		
1.4	QPSK	3	1	23.72	23.63	23.56		
1.4	QPSK	3	3	23.63	23.49	23.55		
1.4	QPSK	6	0	22.73	22.59	22.67	23	1
1.4	16QAM	1	0	22.55	22.68	22.41	23	1
1.4	16QAM	1	3	22.64	22.74	22.73		
1.4	16QAM	1	5	22.70	22.32	22.26		
1.4	16QAM	3	0	22.64	22.47	22.47		
1.4	16QAM	3	1	22.61	22.62	22.68		
1.4	16QAM	3	3	22.63	22.64	22.60		
1.4	16QAM	6	0	21.74	21.70	21.64	22	2
1.4	64QAM	1	0	21.63	21.55	21.50	22	2
1.4	64QAM	1	3	21.70	21.55	21.43		
1.4	64QAM	1	5	21.63	21.73	21.52		
1.4	64QAM	3	0	21.91	21.61	21.56		
1.4	64QAM	3	1	21.74	21.68	21.56		
1.4	64QAM	3	3	21.68	21.55	21.48		
1.4	64QAM	6	0	20.81	20.75	20.60	21	3



<LTE Band 4>

BW [MHz]	Modulation	RB Size	RB Offset	Power Low Ch. / Freq.	Power Middle Ch. / Freq.	Power High Ch. / Freq.	Tune-up limit (dBm)	MPR (dB)
Channel				20050	20175	20300		
Frequency (MHz)				1720	1732.5	1745		
20	QPSK	1	0	23.48	23.74	23.62	24	0
20	QPSK	1	49	23.73	23.60	23.48		
20	QPSK	1	99	23.44	23.46	23.39		
20	QPSK	50	0	22.64	22.84	22.68	23	1
20	QPSK	50	24	22.68	22.66	22.63		
20	QPSK	50	50	22.80	22.49	22.48		
20	QPSK	100	0	22.66	22.59	22.60	23	1
20	16QAM	1	0	22.68	22.92	22.97		
20	16QAM	1	49	22.99	22.85	22.64		
20	16QAM	1	99	22.80	22.79	22.60	22	2
20	16QAM	50	0	21.63	21.58	21.62		
20	16QAM	50	24	21.81	21.70	21.47		
20	16QAM	50	50	21.85	21.47	21.51	22	2
20	16QAM	100	0	21.79	21.69	21.50		
20	64QAM	1	0	21.80	21.67	21.95		
20	64QAM	1	49	21.79	21.59	21.67	22	2
20	64QAM	1	99	21.61	21.84	21.60		
20	64QAM	50	0	20.62	20.69	20.64		
20	64QAM	50	24	20.73	20.75	20.52	21	3
20	64QAM	50	50	20.71	20.48	20.53		
20	64QAM	100	0	20.78	20.50	20.59		



Channel				20025	20175	20325	Tune-up limit (dBm)	MPR (dB)
Frequency (MHz)				1717.5	1732.5	1747.5		
15	QPSK	1	0	23.55	23.69	23.58	24	0
15	QPSK	1	37	23.54	23.56	23.48		
15	QPSK	1	74	23.59	23.47	23.20		
15	QPSK	36	0	22.55	22.62	22.49	23	1
15	QPSK	36	20	22.60	22.61	22.38		
15	QPSK	36	39	22.63	22.60	22.45		
15	QPSK	75	0	22.72	22.59	22.51	23	1
15	16QAM	1	0	22.97	22.85	22.79		
15	16QAM	1	37	23.00	22.58	22.98		
15	16QAM	1	74	22.84	22.53	22.79	22	2
15	16QAM	36	0	21.63	21.73	21.70		
15	16QAM	36	20	21.62	21.63	21.52		
15	16QAM	36	39	21.64	21.58	21.44	22	2
15	16QAM	75	0	21.72	21.61	21.43		
15	64QAM	1	0	21.66	21.80	21.91		
15	64QAM	1	37	21.68	21.69	21.64	22	2
15	64QAM	1	74	21.66	21.57	21.60		
15	64QAM	36	0	20.61	20.67	20.63		
15	64QAM	36	20	20.65	20.71	20.54	21	3
15	64QAM	36	39	20.64	20.63	20.36		
15	64QAM	75	0	20.74	20.58	20.56		
Channel				20000	20175	20350	Tune-up limit (dBm)	MPR (dB)
Frequency (MHz)				1715	1732.5	1750		
10	QPSK	1	0	23.65	23.57	23.48	24	0
10	QPSK	1	25	23.63	23.61	23.41		
10	QPSK	1	49	23.57	23.43	23.26		
10	QPSK	25	0	22.53	22.63	22.43	23	1
10	QPSK	25	12	22.59	22.65	22.53		
10	QPSK	25	25	22.63	22.60	22.35		
10	QPSK	50	0	22.62	22.56	22.40	23	1
10	16QAM	1	0	22.93	22.67	22.74		
10	16QAM	1	25	22.91	22.76	22.69		
10	16QAM	1	49	22.85	22.59	22.59	22	2
10	16QAM	25	0	21.58	21.61	21.47		
10	16QAM	25	12	21.67	21.80	21.55		
10	16QAM	25	25	21.51	21.60	21.35	22	2
10	16QAM	50	0	21.53	21.56	21.37		
10	64QAM	1	0	21.90	21.75	21.60		
10	64QAM	1	25	21.87	21.67	21.67	22	2
10	64QAM	1	49	21.95	21.87	21.65		
10	64QAM	25	0	20.50	20.61	20.54		
10	64QAM	25	12	20.68	20.67	20.48	21	3
10	64QAM	25	25	20.61	20.67	20.34		
10	64QAM	50	0	20.60	20.56	20.41		



Channel				19975	20175	20375	Tune-up limit (dBm)	MPR (dB)
Frequency (MHz)				1712.5	1732.5	1752.5		
5	QPSK	1	0	23.57	23.53	23.30	24	0
5	QPSK	1	12	23.56	23.65	23.38		
5	QPSK	1	24	23.29	23.50	23.31		
5	QPSK	12	0	22.56	22.60	22.39	23	1
5	QPSK	12	7	22.63	22.70	22.39		
5	QPSK	12	13	22.61	22.58	22.37		
5	QPSK	25	0	22.64	22.61	22.33	23	1
5	16QAM	1	0	22.59	22.93	22.72		
5	16QAM	1	12	22.81	22.76	22.71		
5	16QAM	1	24	22.74	22.95	22.72	22	2
5	16QAM	12	0	21.64	21.66	21.33		
5	16QAM	12	7	21.67	21.58	21.36		
5	16QAM	12	13	21.54	21.62	21.32	22	2
5	16QAM	25	0	21.57	21.67	21.39		
5	64QAM	1	0	21.53	21.58	21.48		
5	64QAM	1	12	21.46	21.66	21.38	22	2
5	64QAM	1	24	21.39	21.86	21.45		
5	64QAM	12	0	20.54	20.57	20.36		
5	64QAM	12	7	20.54	20.63	20.38	21	3
5	64QAM	12	13	20.55	20.54	20.30		
5	64QAM	25	0	20.65	20.59	20.47		
Channel				19965	20175	20385	Tune-up limit (dBm)	MPR (dB)
Frequency (MHz)				1711.5	1732.5	1753.5		
3	QPSK	1	0	23.52	23.46	23.24	24	0
3	QPSK	1	8	23.57	23.56	23.30		
3	QPSK	1	14	23.51	23.51	23.23		
3	QPSK	8	0	22.58	22.69	22.45	23	1
3	QPSK	8	4	22.83	22.79	22.58		
3	QPSK	8	7	22.66	22.73	22.51		
3	QPSK	15	0	22.71	22.81	22.39	23	1
3	16QAM	1	0	22.80	22.66	22.60		
3	16QAM	1	8	22.61	22.94	22.78		
3	16QAM	1	14	22.71	22.60	22.45	22	2
3	16QAM	8	0	21.92	21.86	21.60		
3	16QAM	8	4	21.87	21.83	21.65		
3	16QAM	8	7	21.78	21.84	21.80	22	2
3	16QAM	15	0	21.87	21.73	21.56		
3	64QAM	1	0	21.83	21.66	21.61		
3	64QAM	1	8	21.60	21.67	21.46	22	2
3	64QAM	1	14	21.52	21.85	21.61		
3	64QAM	8	0	20.68	20.77	20.59		
3	64QAM	8	4	20.91	20.88	20.48	21	3
3	64QAM	8	7	20.75	20.79	20.42		
3	64QAM	15	0	20.67	20.72	20.45		



Channel				19957	20175	20393	Tune-up limit (dBm)	MPR (dB)
Frequency (MHz)				1710.7	1732.5	1754.3		
1.4	QPSK	1	0	23.43	23.45	23.08	24	0
1.4	QPSK	1	3	23.43	23.54	23.11		
1.4	QPSK	1	5	23.30	23.33	23.10		
1.4	QPSK	3	0	23.51	23.55	23.24		
1.4	QPSK	3	1	23.44	23.60	23.19		
1.4	QPSK	3	3	23.39	23.60	23.23		
1.4	QPSK	6	0	22.57	22.69	22.27	23	1
1.4	16QAM	1	0	22.45	22.48	22.53	23	1
1.4	16QAM	1	3	22.70	22.60	22.71		
1.4	16QAM	1	5	22.69	22.79	22.37		
1.4	16QAM	3	0	22.32	22.43	22.33		
1.4	16QAM	3	1	22.48	22.55	22.37		
1.4	16QAM	3	3	22.44	22.56	22.25		
1.4	16QAM	6	0	21.69	21.77	21.47	22	2
1.4	64QAM	1	0	21.43	21.42	21.23	22	2
1.4	64QAM	1	3	21.43	21.44	21.15		
1.4	64QAM	1	5	21.39	21.34	21.30		
1.4	64QAM	3	0	21.54	21.59	21.32		
1.4	64QAM	3	1	21.29	21.37	21.29		
1.4	64QAM	3	3	21.53	21.50	21.18		
1.4	64QAM	6	0	20.67	20.73	20.46	21	3



<LTE Band 5>

BW [MHz]	Modulation	RB Size	RB Offset	Power Low Ch. / Freq.	Power Middle Ch. / Freq.	Power High Ch. / Freq.	Tune-up limit (dBm)	MPR (dB)
Channel				20450	20525	20600		
Frequency (MHz)				829	836.5	844		
10	QPSK	1	0	23.58	23.77	23.64	24	0
10	QPSK	1	25	23.73	23.62	23.58		
10	QPSK	1	49	23.58	23.53	23.58		
10	QPSK	25	0	22.56	22.64	22.58	23	1
10	QPSK	25	12	22.62	22.58	22.60		
10	QPSK	25	25	22.62	22.51	22.51		
10	QPSK	50	0	22.64	22.66	22.57	23	1
10	16QAM	1	0	22.86	22.90	22.91		
10	16QAM	1	25	22.95	22.79	22.94		
10	16QAM	1	49	22.93	22.69	22.97	22	2
10	16QAM	25	0	21.67	21.62	21.39		
10	16QAM	25	12	21.74	21.73	21.54		
10	16QAM	25	25	21.61	21.66	21.53	22	2
10	16QAM	50	0	21.65	21.65	21.45		
10	64QAM	1	0	21.74	21.92	21.79		
10	64QAM	1	25	21.74	21.80	21.89	22	2
10	64QAM	1	49	21.76	21.71	21.75		
10	64QAM	25	0	20.59	20.67	20.60		
10	64QAM	25	12	20.74	20.70	20.58	21	3
10	64QAM	25	25	20.71	20.67	20.58		
10	64QAM	50	0	20.58	20.72	20.49		



Channel				20425	20525	20625	Tune-up limit (dBm)	MPR (dB)
Frequency (MHz)				826.5	836.5	846.5		
5	QPSK	1	0	23.58	23.46	23.48	24	0
5	QPSK	1	12	23.70	23.65	23.63		
5	QPSK	1	24	23.46	23.51	23.68		
5	QPSK	12	0	22.61	22.56	22.61	23	1
5	QPSK	12	7	22.69	22.65	22.58		
5	QPSK	12	13	22.60	22.56	22.60		
5	QPSK	25	0	22.74	22.52	22.63	23	1
5	16QAM	1	0	22.86	22.70	22.65		
5	16QAM	1	12	22.80	22.81	22.63		
5	16QAM	1	24	22.91	22.87	22.68	22	2
5	16QAM	12	0	21.58	21.58	21.56		
5	16QAM	12	7	21.70	21.80	21.52		
5	16QAM	12	13	21.67	21.56	21.61	22	2
5	16QAM	25	0	21.69	21.73	21.67		
5	64QAM	1	0	21.79	21.64	21.69		
5	64QAM	1	12	21.75	21.77	21.47	22	2
5	64QAM	1	24	21.62	21.57	21.70		
5	64QAM	12	0	20.64	20.55	20.50		
5	64QAM	12	7	20.51	20.77	20.69	21	3
5	64QAM	12	13	20.70	20.55	20.49		
5	64QAM	25	0	20.70	20.65	20.64		
Channel				20415	20525	20635	Tune-up limit (dBm)	MPR (dB)
Frequency (MHz)				825.5	836.5	847.5		
3	QPSK	1	0	23.29	23.25	23.15	24	0
3	QPSK	1	8	23.32	23.17	23.44		
3	QPSK	1	14	23.35	23.31	23.25		
3	QPSK	8	0	22.62	22.42	22.46	23	1
3	QPSK	8	4	22.64	22.54	22.70		
3	QPSK	8	7	22.54	22.53	22.49		
3	QPSK	15	0	22.62	22.45	22.56	23	1
3	16QAM	1	0	22.63	22.60	22.61		
3	16QAM	1	8	22.55	22.72	22.83		
3	16QAM	1	14	22.52	22.40	22.50	22	2
3	16QAM	8	0	21.78	21.60	21.57		
3	16QAM	8	4	21.70	21.74	21.56		
3	16QAM	8	7	21.54	21.58	21.58	22	2
3	16QAM	15	0	21.55	21.45	21.59		
3	64QAM	1	0	21.50	21.48	21.51		
3	64QAM	1	8	21.55	21.83	21.81	22	2
3	64QAM	1	14	21.47	21.82	21.49		
3	64QAM	8	0	20.55	20.58	20.45		
3	64QAM	8	4	20.64	20.62	20.62	21	3
3	64QAM	8	7	20.52	20.58	20.56		
3	64QAM	15	0	20.50	20.57	20.48		



Channel				20407	20525	20643	Tune-up limit (dBm)	MPR (dB)
Frequency (MHz)				824.7	836.5	848.3		
1.4	QPSK	1	0	23.46	23.37	23.50	24	0
1.4	QPSK	1	3	23.44	23.40	23.51		
1.4	QPSK	1	5	23.37	23.31	23.45		
1.4	QPSK	3	0	23.53	23.41	23.48		
1.4	QPSK	3	1	23.54	23.48	23.56		
1.4	QPSK	3	3	23.53	23.49	23.56		
1.4	QPSK	6	0	22.60	22.55	22.59	23	1
1.4	16QAM	1	0	22.54	22.60	22.50	23	1
1.4	16QAM	1	3	22.97	22.75	22.92		
1.4	16QAM	1	5	22.94	22.86	22.59		
1.4	16QAM	3	0	22.56	22.45	22.51		
1.4	16QAM	3	1	22.57	22.57	22.61		
1.4	16QAM	3	3	22.60	22.54	22.47		
1.4	16QAM	6	0	21.84	21.76	21.54	22	2
1.4	64QAM	1	0	21.61	21.96	21.51	22	2
1.4	64QAM	1	3	21.61	21.61	21.61		
1.4	64QAM	1	5	21.54	21.58	21.74		
1.4	64QAM	3	0	21.38	21.48	21.58		
1.4	64QAM	3	1	21.65	21.52	21.41		
1.4	64QAM	3	3	21.57	21.40	21.50		
1.4	64QAM	6	0	20.61	20.59	20.63	21	3



<LTE Band 7>

BW [MHz]	Modulation	RB Size	RB Offset	Power Low Ch. / Freq.	Power Middle Ch. / Freq.	Power High Ch. / Freq.	Tune-up limit (dBm)	MPR (dB)
Channel				20850	21100	21350		
Frequency (MHz)				2510	2535	2560		
20	QPSK	1	0	23.43	23.52	23.50	24	0
20	QPSK	1	49	23.55	23.67	23.82		
20	QPSK	1	99	23.56	23.64	23.81		
20	QPSK	50	0	22.32	22.66	22.55	23	1
20	QPSK	50	24	22.54	22.71	22.81		
20	QPSK	50	50	22.67	22.61	22.61		
20	QPSK	100	0	22.47	22.59	22.57	23	1
20	16QAM	1	0	22.53	22.54	22.54		
20	16QAM	1	49	22.59	22.63	22.58		
20	16QAM	1	99	22.39	22.73	22.83	22	2
20	16QAM	50	0	21.49	21.66	21.58		
20	16QAM	50	24	21.49	21.68	21.74		
20	16QAM	50	50	21.59	21.63	21.71	22	2
20	16QAM	100	0	21.43	21.58	21.67		
20	64QAM	1	0	21.29	21.76	21.54		
20	64QAM	1	49	21.40	21.67	21.72	22	2
20	64QAM	1	99	21.86	21.73	21.82		
20	64QAM	50	0	20.38	20.66	20.53		
20	64QAM	50	24	20.53	20.73	20.72	21	3
20	64QAM	50	50	20.63	20.61	20.57		
20	64QAM	100	0	20.48	20.54	20.63		



Channel				20825	21100	21375	Tune-up limit (dBm)	MPR (dB)
Frequency (MHz)				2507.5	2535	2562.5		
15	QPSK	1	0	23.34	23.56	23.62	24	0
15	QPSK	1	37	23.60	23.65	23.80		
15	QPSK	1	74	23.58	23.58	23.78		
15	QPSK	36	0	22.32	22.62	22.60	23	1
15	QPSK	36	20	22.54	22.59	22.68		
15	QPSK	36	39	22.56	22.60	22.71		
15	QPSK	75	0	22.50	22.69	22.70	23	1
15	16QAM	1	0	22.66	22.52	22.64		
15	16QAM	1	37	22.88	22.70	22.80		
15	16QAM	1	74	22.36	22.85	22.78	22	2
15	16QAM	36	0	21.47	21.58	21.74		
15	16QAM	36	20	21.55	21.69	21.77		
15	16QAM	36	39	21.48	21.62	21.73	22	2
15	16QAM	75	0	21.50	21.67	21.71		
15	64QAM	1	0	21.43	21.78	21.64		
15	64QAM	1	37	21.80	21.73	21.75	22	2
15	64QAM	1	74	21.58	21.54	21.83		
15	64QAM	36	0	20.36	20.65	20.73		
15	64QAM	36	20	20.43	20.64	20.75	21	3
15	64QAM	36	39	20.63	20.65	20.71		
15	64QAM	75	0	20.42	20.57	20.63		
Channel				20800	21100	21400	Tune-up limit (dBm)	MPR (dB)
Frequency (MHz)				2505	2535	2565		
10	QPSK	1	0	23.59	23.49	23.65	24	0
10	QPSK	1	25	23.46	23.64	23.76		
10	QPSK	1	49	23.45	23.54	23.64		
10	QPSK	25	0	22.40	22.64	22.76	23	1
10	QPSK	25	12	22.54	22.62	22.79		
10	QPSK	25	25	22.42	22.63	22.71		
10	QPSK	50	0	22.49	22.55	22.79	23	1
10	16QAM	1	0	22.69	22.64	22.81		
10	16QAM	1	25	22.83	22.48	22.84		
10	16QAM	1	49	22.80	22.77	22.80	22	2
10	16QAM	25	0	21.39	21.72	21.67		
10	16QAM	25	12	21.60	21.68	21.82		
10	16QAM	25	25	21.51	21.64	21.68	22	2
10	16QAM	50	0	21.47	21.64	21.70		
10	64QAM	1	0	21.30	21.60	21.70		
10	64QAM	1	25	21.78	21.80	21.79	22	2
10	64QAM	1	49	21.54	21.83	21.80		
10	64QAM	25	0	20.43	20.60	20.70		
10	64QAM	25	12	20.47	20.69	20.74	21	3
10	64QAM	25	25	20.45	20.57	20.65		
10	64QAM	50	0	20.47	20.68	20.77		



Channel				20775	21100	21425	Tune-up limit (dBm)	MPR (dB)
Frequency (MHz)				2502.5	2535	2567.5		
5	QPSK	1	0	23.54	23.59	23.69	24	0
5	QPSK	1	12	23.44	23.73	23.69		
5	QPSK	1	24	23.37	23.63	23.77		
5	QPSK	12	0	22.38	22.55	22.80	23	1
5	QPSK	12	7	22.44	22.63	22.83		
5	QPSK	12	13	22.39	22.67	22.71		
5	QPSK	25	0	22.47	22.60	22.75		
5	16QAM	1	0	22.67	22.34	22.73	23	1
5	16QAM	1	12	22.62	22.74	22.81		
5	16QAM	1	24	22.68	22.68	22.76		
5	16QAM	12	0	21.40	21.63	21.75	22	2
5	16QAM	12	7	21.53	21.73	21.77		
5	16QAM	12	13	21.44	21.57	21.80		
5	16QAM	25	0	21.48	21.65	21.63		
5	64QAM	1	0	21.31	21.47	21.69	22	2
5	64QAM	1	12	21.86	21.70	21.77		
5	64QAM	1	24	21.50	21.70	21.59		
5	64QAM	12	0	20.43	20.54	20.69	21	3
5	64QAM	12	7	20.45	20.69	20.81		
5	64QAM	12	13	20.44	20.60	20.72		
5	64QAM	25	0	20.42	20.59	20.84		



<WWAN Top Antenna --Reduced Power for Receiver On/Hotspot On >

<LTE Band 2>

BW [MHz]	Modulation	RB Size	RB Offset	Power Low Ch. / Freq.	Power Middle Ch. / Freq.	Power High Ch. / Freq.	Tune-up limit (dBm)	MPR (dB)
Channel				18700	18900	19100		
Frequency (MHz)				1860	1880	1900		
20	QPSK	1	0	20.12	20.10	20.36	21	0
20	QPSK	1	49	19.97	20.07	20.01		
20	QPSK	1	99	20.10	19.99	20.00		
20	QPSK	50	0	19.96	20.03	20.11	21	0
20	QPSK	50	24	20.01	20.07	20.08		
20	QPSK	50	50	19.92	20.09	19.87		
20	QPSK	100	0	19.93	20.06	19.99	21	0
20	16QAM	1	0	20.21	20.25	20.27		
20	16QAM	1	49	20.28	20.21	20.25		
20	16QAM	1	99	20.14	20.30	20.07	21	0
20	16QAM	50	0	19.97	20.02	20.13		
20	16QAM	50	24	19.99	20.09	20.09		
20	16QAM	50	50	19.93	20.11	19.86	21	0
20	16QAM	100	0	19.92	20.03	19.98		
20	64QAM	1	0	20.06	20.14	20.21		
20	64QAM	1	49	20.16	20.27	20.24	21	0
20	64QAM	1	99	19.98	20.17	19.94		
20	64QAM	50	0	19.96	20.00	20.11		
20	64QAM	50	24	19.99	20.08	20.08	21	0
20	64QAM	50	50	19.92	20.06	19.85		
20	64QAM	100	0	19.92	20.05	19.98		



Channel				18675	18900	19125	Tune-up limit (dBm)	MPR (dB)
Frequency (MHz)				1857.5	1880	1902.5		
15	QPSK	1	0	19.93	20.01	20.02	21	0
15	QPSK	1	37	19.96	20.06	19.98		
15	QPSK	1	74	19.86	20.03	19.83		
15	QPSK	36	0	19.94	20.00	20.02	21	0
15	QPSK	36	20	19.96	20.05	19.97		
15	QPSK	36	39	19.90	20.05	19.86		
15	QPSK	75	0	19.92	20.06	19.96	21	0
15	16QAM	1	0	20.26	20.34	20.33		
15	16QAM	1	37	20.28	20.20	20.29		
15	16QAM	1	74	20.18	20.35	20.16	21	0
15	16QAM	36	0	19.93	20.01	20.05		
15	16QAM	36	20	19.94	20.07	20.00		
15	16QAM	36	39	19.92	20.07	19.88	21	0
15	16QAM	75	0	19.92	20.05	19.97		
15	64QAM	1	0	20.12	20.20	20.20		
15	64QAM	1	37	20.15	20.25	20.18	21	0
15	64QAM	1	74	20.06	20.23	20.00		
15	64QAM	36	0	19.93	20.00	20.05		
15	64QAM	36	20	19.95	20.05	19.96	21	0
15	64QAM	36	39	19.92	20.05	19.87		
15	64QAM	75	0	19.92	20.05	19.98		
Channel				18650	18900	19150	Tune-up limit (dBm)	MPR (dB)
Frequency (MHz)				1855	1880	1905		
10	QPSK	1	0	19.87	19.99	19.96	21	0
10	QPSK	1	25	19.94	20.05	19.92		
10	QPSK	1	49	19.84	20.00	19.83		
10	QPSK	25	0	19.85	19.94	19.92	21	0
10	QPSK	25	12	19.92	20.05	19.96		
10	QPSK	25	25	19.87	20.03	19.80		
10	QPSK	50	0	19.88	19.99	19.93	21	0
10	16QAM	1	0	20.23	20.30	20.26		
10	16QAM	1	25	20.29	20.29	20.29		
10	16QAM	1	49	20.17	20.31	20.12	21	0
10	16QAM	25	0	19.89	19.98	19.96		
10	16QAM	25	12	19.96	20.06	19.99		
10	16QAM	25	25	19.89	20.00	19.83	21	0
10	16QAM	50	0	19.89	20.02	19.92		
10	64QAM	1	0	20.09	20.16	20.15		
10	64QAM	1	25	20.11	20.23	20.11	21	0
10	64QAM	1	49	20.03	20.18	19.99		
10	64QAM	25	0	19.85	19.96	19.95		
10	64QAM	25	12	19.96	20.08	19.99	21	0
10	64QAM	25	25	19.89	20.02	19.84		
10	64QAM	50	0	19.89	20.00	19.90		



Channel				18625	18900	19175	Tune-up limit (dBm)	MPR (dB)
Frequency (MHz)				1852.5	1880	1907.5		
5	QPSK	1	0	19.84	19.97	19.81	21	0
5	QPSK	1	12	19.92	20.03	19.90		
5	QPSK	1	24	19.82	19.96	19.81		
5	QPSK	12	0	19.86	19.99	19.87	21	0
5	QPSK	12	7	19.91	20.05	19.91		
5	QPSK	12	13	19.88	20.03	19.85		
5	QPSK	25	0	19.90	20.01	19.89	21	0
5	16QAM	1	0	20.14	20.25	20.13		
5	16QAM	1	12	20.21	20.33	20.19		
5	16QAM	1	24	20.15	20.26	20.03	21	0
5	16QAM	12	0	19.86	20.00	19.90		
5	16QAM	12	7	19.91	20.07	19.89		
5	16QAM	12	13	19.90	20.01	19.85	21	0
5	16QAM	25	0	19.92	20.06	19.92		
5	64QAM	1	0	20.03	20.13	19.97		
5	64QAM	1	12	20.10	20.22	20.07	21	0
5	64QAM	1	24	20.02	20.13	19.93		
5	64QAM	12	0	19.86	19.98	19.88		
5	64QAM	12	7	19.91	20.04	19.89	21	0
5	64QAM	12	13	19.88	19.99	19.84		
5	64QAM	25	0	19.93	20.04	19.92		
Channel				18615	18900	19185	Tune-up limit (dBm)	MPR (dB)
Frequency (MHz)				1851.5	1880	1908.5		
3	QPSK	1	0	19.57	19.70	19.56	21	0
3	QPSK	1	8	19.66	19.75	19.62		
3	QPSK	1	14	19.55	19.71	19.53		
3	QPSK	8	0	19.78	19.90	19.78	21	0
3	QPSK	8	4	19.85	19.97	19.83		
3	QPSK	8	7	19.79	19.94	19.75		
3	QPSK	15	0	19.77	19.93	19.76	21	0
3	16QAM	1	0	19.88	19.97	19.84		
3	16QAM	1	8	19.94	20.05	19.91		
3	16QAM	1	14	19.86	19.97	19.79	21	0
3	16QAM	8	0	19.84	19.97	19.83		
3	16QAM	8	4	19.89	20.02	19.89		
3	16QAM	8	7	19.83	19.98	19.80	21	0
3	16QAM	15	0	19.80	19.94	19.79		
3	64QAM	1	0	19.73	19.85	19.70		
3	64QAM	1	8	19.83	19.92	19.74	21	0
3	64QAM	1	14	19.70	19.86	19.66		
3	64QAM	8	0	19.80	19.92	19.82		
3	64QAM	8	4	19.87	19.97	19.85	21	0
3	64QAM	8	7	19.81	19.95	19.76		
3	64QAM	15	0	19.76	19.91	19.77		



Channel				18607	18900	19193	Tune-up limit (dBm)	MPR (dB)
Frequency (MHz)				1850.7	1880	1909.3		
1.4	QPSK	1	0	19.67	19.79	19.63	21	0
1.4	QPSK	1	3	19.73	19.82	19.69		
1.4	QPSK	1	5	19.67	19.79	19.65		
1.4	QPSK	3	0	19.77	19.88	19.72		
1.4	QPSK	3	1	19.79	19.89	19.73		
1.4	QPSK	3	3	19.78	19.89	19.72		
1.4	QPSK	6	0	19.87	19.99	19.81	21	0
1.4	16QAM	1	0	19.98	20.10	19.91	21	0
1.4	16QAM	1	3	20.02	20.13	19.97		
1.4	16QAM	1	5	19.99	20.07	19.92		
1.4	16QAM	3	0	19.83	19.94	19.78		
1.4	16QAM	3	1	19.84	19.95	19.78		
1.4	16QAM	3	3	19.82	19.95	19.75		
1.4	16QAM	6	0	19.99	20.09	19.95	21	0
1.4	64QAM	1	0	19.84	19.94	19.76	21	0
1.4	64QAM	1	3	19.85	19.99	19.81		
1.4	64QAM	1	5	19.83	19.93	19.76		
1.4	64QAM	3	0	19.81	19.92	19.78		
1.4	64QAM	3	1	19.83	19.97	19.79		
1.4	64QAM	3	3	19.83	19.93	19.76		
1.4	64QAM	6	0	19.90	20.00	19.84	21	0



<LTE Band 4>

BW [MHz]	Modulation	RB Size	RB Offset	Power Low Ch. / Freq.	Power Middle Ch. / Freq.	Power High Ch. / Freq.	Tune-up limit (dBm)	MPR (dB)
Channel				20050	20175	20300		
Frequency (MHz)				1720	1732.5	1745		
20	QPSK	1	0	22.47	22.60	22.49	23.5	0
20	QPSK	1	49	22.57	22.58	22.39		
20	QPSK	1	99	22.43	22.27	22.17		
20	QPSK	50	0	22.09	22.18	22.06	23	0.5
20	QPSK	50	24	22.14	22.13	21.95		
20	QPSK	50	50	22.17	21.95	21.86		
20	QPSK	100	0	22.11	21.96	21.99	23	0.5
20	16QAM	1	0	22.16	22.26	22.14		
20	16QAM	1	49	22.29	22.25	22.10		
20	16QAM	1	99	22.13	21.93	21.98	22	1.5
20	16QAM	50	0	21.05	21.02	21.06		
20	16QAM	50	24	21.13	21.10	20.95		
20	16QAM	50	50	21.15	20.95	20.85	22	1.5
20	16QAM	100	0	21.10	20.96	20.95		
20	64QAM	1	0	21.26	21.37	21.25		
20	64QAM	1	49	21.41	21.37	21.21	22	1.5
20	64QAM	1	99	21.24	21.08	21.06		
20	64QAM	50	0	20.24	20.22	20.23		
20	64QAM	50	24	20.31	20.29	20.13	21	2.5
20	64QAM	50	50	20.35	20.14	20.03		
20	64QAM	100	0	20.29	20.16	20.16		



Channel				20025	20175	20325	Tune-up limit (dBm)	MPR (dB)
Frequency (MHz)				1717.5	1732.5	1747.5		
15	QPSK	1	0	22.54	22.58	22.42	23.5	0
15	QPSK	1	37	22.57	22.58	22.41		
15	QPSK	1	74	22.52	22.41	22.24		
15	QPSK	36	0	22.04	22.06	21.92	23	0.5
15	QPSK	36	20	22.11	22.08	21.87		
15	QPSK	36	39	22.08	21.97	21.85		
15	QPSK	75	0	22.08	22.05	21.91	23	0.5
15	16QAM	1	0	22.16	22.34	22.09		
15	16QAM	1	37	22.25	22.25	22.16		
15	16QAM	1	74	22.23	22.03	22.03	22	1.5
15	16QAM	36	0	21.05	21.07	20.94		
15	16QAM	36	20	21.10	21.09	20.88		
15	16QAM	36	39	21.09	20.96	20.86	22	1.5
15	16QAM	75	0	21.10	21.07	20.90		
15	64QAM	1	0	21.31	21.42	21.20		
15	64QAM	1	37	21.39	21.36	21.27	22	1.5
15	64QAM	1	74	21.35	21.16	21.13		
15	64QAM	36	0	20.25	20.25	20.13		
15	64QAM	36	20	20.28	20.29	20.09	21	2.5
15	64QAM	36	39	20.29	20.19	20.05		
15	64QAM	75	0	20.28	20.25	20.10		
Channel				20000	20175	20350	Tune-up limit (dBm)	MPR (dB)
Frequency (MHz)				1715	1732.5	1750		
10	QPSK	1	0	22.53	22.56	22.37	23.5	0
10	QPSK	1	25	22.57	22.59	22.39		
10	QPSK	1	49	22.52	22.43	22.27		
10	QPSK	25	0	21.97	22.00	21.85	23	0.5
10	QPSK	25	12	22.09	22.10	21.89		
10	QPSK	25	25	22.06	22.02	21.83		
10	QPSK	50	0	22.08	22.04	21.90	23	0.5
10	16QAM	1	0	22.13	22.27	22.08		
10	16QAM	1	25	22.20	22.25	22.18		
10	16QAM	1	49	22.17	22.07	22.06	22	1.5
10	16QAM	25	0	21.02	21.03	20.87		
10	16QAM	25	12	21.11	21.12	20.92		
10	16QAM	25	25	21.06	21.02	20.80	22	1.5
10	16QAM	50	0	21.04	21.04	20.88		
10	64QAM	1	0	21.25	21.38	21.17		
10	64QAM	1	25	21.34	21.37	21.28	22	1.5
10	64QAM	1	49	21.31	21.15	21.13		
10	64QAM	25	0	20.23	20.22	20.06		
10	64QAM	25	12	20.33	20.32	20.11	21	2.5
10	64QAM	25	25	20.26	20.23	20.02		
10	64QAM	50	0	20.22	20.21	20.05		



Channel				19975	20175	20375	Tune-up limit (dBm)	MPR (dB)
Frequency (MHz)				1712.5	1732.5	1752.5		
5	QPSK	1	0	22.47	22.50	22.30	23.5	0
5	QPSK	1	12	22.54	22.59	22.33		
5	QPSK	1	24	22.47	22.48	22.24		
5	QPSK	12	0	22.00	22.03	21.79	23	0.5
5	QPSK	12	7	22.07	22.11	21.86		
5	QPSK	12	13	22.05	22.05	21.81		
5	QPSK	25	0	22.02	22.05	21.79	23	0.5
5	16QAM	1	0	22.11	22.21	22.09		
5	16QAM	1	12	22.20	22.25	22.15		
5	16QAM	1	24	22.10	22.10	22.02	22	1.5
5	16QAM	12	0	21.02	21.03	20.80		
5	16QAM	12	7	21.09	21.08	20.84		
5	16QAM	12	13	21.01	21.03	20.81	22	1.5
5	16QAM	25	0	21.05	21.07	20.81		
5	64QAM	1	0	21.24	21.33	21.15		
5	64QAM	1	12	21.31	21.34	21.21	22	1.5
5	64QAM	1	24	21.22	21.22	21.11		
5	64QAM	12	0	20.19	20.20	19.99		
5	64QAM	12	7	20.25	20.26	20.03	21	2.5
5	64QAM	12	13	20.22	20.23	20.00		
5	64QAM	25	0	20.26	20.27	20.01		
Channel				19965	20175	20385	Tune-up limit (dBm)	MPR (dB)
Frequency (MHz)				1711.5	1732.5	1753.5		
3	QPSK	1	0	22.24	22.27	22.02	23.5	0
3	QPSK	1	8	22.31	22.34	22.06		
3	QPSK	1	14	22.24	22.24	21.98		
3	QPSK	8	0	21.95	21.97	21.74	23	0.5
3	QPSK	8	4	22.00	22.02	21.77		
3	QPSK	8	7	21.96	21.99	21.73		
3	QPSK	15	0	21.99	21.98	21.72	23	0.5
3	16QAM	1	0	21.87	21.95	21.77		
3	16QAM	1	8	21.98	22.00	21.86		
3	16QAM	1	14	21.88	21.88	21.76	22	1.5
3	16QAM	8	0	21.00	21.04	20.78		
3	16QAM	8	4	21.08	21.09	20.83		
3	16QAM	8	7	21.03	21.03	20.79	22	1.5
3	16QAM	15	0	20.97	20.99	20.73		
3	64QAM	1	0	21.00	21.05	20.90		
3	64QAM	1	8	21.11	21.13	20.96	22	1.5
3	64QAM	1	14	21.00	21.03	20.84		
3	64QAM	8	0	20.18	20.19	19.94		
3	64QAM	8	4	20.24	20.25	19.97	21	2.5
3	64QAM	8	7	20.19	20.18	19.93		
3	64QAM	15	0	20.14	20.13	19.89		



Channel				19957	20175	20393	Tune-up limit (dBm)	MPR (dB)
Frequency (MHz)				1710.7	1732.5	1754.3		
1.4	QPSK	1	0	22.35	22.37	22.13	23.5	0
1.4	QPSK	1	3	22.43	22.45	22.18		
1.4	QPSK	1	5	22.37	22.39	22.14		
1.4	QPSK	3	0	22.41	22.47	22.26		
1.4	QPSK	3	1	22.43	22.46	22.27		
1.4	QPSK	3	3	22.41	22.46	22.27		
1.4	QPSK	6	0	22.09	22.10	21.85	22.5	1
1.4	16QAM	1	0	22.00	22.06	21.93	22.5	1
1.4	16QAM	1	3	22.02	22.08	21.96		
1.4	16QAM	1	5	22.00	22.05	21.88		
1.4	16QAM	3	0	21.97	22.00	21.78		
1.4	16QAM	3	1	21.98	22.04	21.81		
1.4	16QAM	3	3	21.95	21.99	21.77		
1.4	16QAM	6	0	21.17	21.20	20.94	21.5	2
1.4	64QAM	1	0	21.12	21.20	21.00	21.5	2
1.4	64QAM	1	3	21.17	21.21	21.06		
1.4	64QAM	1	5	21.13	21.19	21.02		
1.4	64QAM	3	0	21.19	21.23	21.00		
1.4	64QAM	3	1	21.19	21.23	21.02		
1.4	64QAM	3	3	21.16	21.20	21.00		
1.4	64QAM	6	0	20.30	20.32	20.07	20.5	3



<LTE Band 7>

BW [MHz]	Modulation	RB Size	RB Offset	Power Low Ch. / Freq.	Power Middle Ch. / Freq.	Power High Ch. / Freq.	Tune-up limit (dBm)	MPR (dB)
Channel				20850	21100	21350		
Frequency (MHz)				2510	2535	2560		
20	QPSK	1	0	18.23	18.21	18.46	18.5	0
20	QPSK	1	49	18.02	18.12	18.24		
20	QPSK	1	99	18.32	18.06	18.29		
20	QPSK	50	0	17.84	18.10	18.05	18.5	0
20	QPSK	50	24	18.03	18.14	18.29		
20	QPSK	50	50	18.09	18.08	18.08		
20	QPSK	100	0	17.95	18.09	18.06	18.5	0
20	16QAM	1	0	18.13	18.19	18.33		
20	16QAM	1	49	18.34	18.41	18.40		
20	16QAM	1	99	18.29	18.42	18.45	18.5	0
20	16QAM	50	0	17.84	18.11	18.07		
20	16QAM	50	24	18.02	18.15	18.28		
20	16QAM	50	50	18.09	18.10	18.06	18.5	0
20	16QAM	100	0	17.97	18.09	18.06		
20	64QAM	1	0	17.96	18.03	18.17		
20	64QAM	1	49	18.19	18.27	18.40	18.5	0
20	64QAM	1	99	18.15	18.25	18.34		
20	64QAM	50	0	17.84	18.08	18.05		
20	64QAM	50	24	18.01	18.14	18.27	18.5	0
20	64QAM	50	50	18.08	18.07	18.07		
20	64QAM	100	0	17.96	18.07	18.07		



Channel				20825	21100	21375	Tune-up limit (dBm)	MPR (dB)
Frequency (MHz)				2507.5	2535	2562.5		
15	QPSK	1	0	17.88	17.95	18.09	18.5	0
15	QPSK	1	37	17.99	18.09	18.25		
15	QPSK	1	74	18.00	18.11	18.32		
15	QPSK	36	0	17.87	18.04	18.21	18.5	0
15	QPSK	36	20	17.98	18.08	18.23		
15	QPSK	36	39	18.02	18.07	18.23		
15	QPSK	75	0	17.95	18.07	18.20	18.5	0
15	16QAM	1	0	18.19	18.23	18.42		
15	16QAM	1	37	18.31	18.39	18.34		
15	16QAM	1	74	18.33	18.45	18.34	18.5	0
15	16QAM	36	0	17.88	18.06	18.21		
15	16QAM	36	20	17.98	18.11	18.25		
15	16QAM	36	39	18.02	18.09	18.21	18.5	0
15	16QAM	75	0	17.97	18.09	18.21		
15	64QAM	1	0	18.03	18.09	18.26		
15	64QAM	1	37	18.16	18.24	18.39	18.5	0
15	64QAM	1	74	18.19	18.29	18.43		
15	64QAM	36	0	17.88	18.04	18.21		
15	64QAM	36	20	17.99	18.09	18.25	18.5	0
15	64QAM	36	39	18.04	18.10	18.22		
15	64QAM	75	0	17.96	18.08	18.20		
Channel				20800	21100	21400	Tune-up limit (dBm)	MPR (dB)
Frequency (MHz)				2505	2535	2565		
10	QPSK	1	0	17.86	17.99	18.11	18.5	0
10	QPSK	1	25	18.00	18.08	18.29		
10	QPSK	1	49	17.94	18.07	18.30		
10	QPSK	25	0	17.88	18.05	18.30	18.5	0
10	QPSK	25	12	17.96	18.10	18.32		
10	QPSK	25	25	18.00	18.07	18.20		
10	QPSK	50	0	17.95	18.10	18.25	18.5	0
10	16QAM	1	0	18.17	18.25	18.40		
10	16QAM	1	25	18.31	18.37	18.34		
10	16QAM	1	49	18.25	18.36	18.32	18.5	0
10	16QAM	25	0	17.93	18.08	18.31		
10	16QAM	25	12	17.99	18.12	18.31		
10	16QAM	25	25	18.01	18.11	18.22	18.5	0
10	16QAM	50	0	17.96	18.10	18.27		
10	64QAM	1	0	18.05	18.13	18.26		
10	64QAM	1	25	18.17	18.25	18.42	18.5	0
10	64QAM	1	49	18.13	18.23	18.44		
10	64QAM	25	0	17.90	18.08	18.29		
10	64QAM	25	12	17.98	18.13	18.33	18.5	0
10	64QAM	25	25	18.00	18.06	18.21		
10	64QAM	50	0	17.92	18.07	18.24		



Channel				20775	21100	21425	Tune-up limit (dBm)	MPR (dB)
Frequency (MHz)				2502.5	2535	2567.5		
5	QPSK	1	0	17.88	17.97	18.18	18.5	0
5	QPSK	1	12	17.98	18.08	18.31		
5	QPSK	1	24	17.91	18.03	18.25		
5	QPSK	12	0	17.90	18.03	18.31	18.5	0
5	QPSK	12	7	17.99	18.09	18.32		
5	QPSK	12	13	17.99	18.07	18.26		
5	QPSK	25	0	17.98	18.05	18.29	18.5	0
5	16QAM	1	0	18.20	18.26	18.44		
5	16QAM	1	12	18.29	18.37	18.34		
5	16QAM	1	24	18.24	18.31	18.32	18.5	0
5	16QAM	12	0	17.91	18.04	18.33		
5	16QAM	12	7	17.98	18.10	18.32		
5	16QAM	12	13	17.99	18.08	18.25	18.5	0
5	16QAM	25	0	17.99	18.09	18.31		
5	64QAM	1	0	18.02	18.12	18.33		
5	64QAM	1	12	18.17	18.26	18.43	18.5	0
5	64QAM	1	24	18.08	18.22	18.43		
5	64QAM	12	0	17.89	18.03	18.27		
5	64QAM	12	7	17.96	18.09	18.29	18.5	0
5	64QAM	12	13	17.95	18.04	18.25		
5	64QAM	25	0	17.96	18.08	18.32		



<WWAN Bottom Antenna --Reduced Power for Sensor On >

<LTE Band 2>

BW [MHz]	Modulation	RB Size	RB Offset	Power Low Ch. / Freq.	Power Middle Ch. / Freq.	Power High Ch. / Freq.	Tune-up limit (dBm)	MPR (dB)
Channel				18700	18900	19100		
Frequency (MHz)				1860	1880	1900		
20	QPSK	1	0	20.20	20.34	20.58	21	0
20	QPSK	1	49	20.36	20.50	20.47		
20	QPSK	1	99	20.23	20.42	20.22		
20	QPSK	50	0	20.30	20.42	20.57	21	0
20	QPSK	50	24	20.39	20.51	20.52		
20	QPSK	50	50	20.29	20.51	20.31		
20	QPSK	100	0	20.28	20.47	20.48	21	0
20	16QAM	1	0	20.15	20.24	20.39		
20	16QAM	1	49	20.24	20.39	20.39		
20	16QAM	1	99	20.10	20.29	20.09	21	0
20	16QAM	50	0	19.89	20.01	20.18		
20	16QAM	50	24	19.96	20.09	20.12		
20	16QAM	50	50	19.86	20.12	19.90	21	0
20	16QAM	100	0	19.87	20.05	20.03		
20	64QAM	1	0	20.02	20.12	20.25		
20	64QAM	1	49	20.13	20.28	20.28	21	0
20	64QAM	1	99	19.99	20.20	19.99		
20	64QAM	50	0	19.88	20.01	20.16		
20	64QAM	50	24	19.95	20.08	20.09	21	0
20	64QAM	50	50	19.86	20.11	19.90		
20	64QAM	100	0	19.86	20.06	20.05		



Channel				18675	18900	19125	Tune-up limit (dBm)	MPR (dB)
Frequency (MHz)				1857.5	1880	1902.5		
15	QPSK	1	0	20.29	20.44	20.47	21	0
15	QPSK	1	37	20.34	20.50	20.45		
15	QPSK	1	74	20.25	20.46	20.29		
15	QPSK	36	0	20.27	20.43	20.47	21	0
15	QPSK	36	20	20.32	20.45	20.42		
15	QPSK	36	39	20.27	20.46	20.32		
15	QPSK	75	0	20.29	20.49	20.44	21	0
15	16QAM	1	0	20.19	20.32	20.24		
15	16QAM	1	37	20.23	20.29	20.33		
15	16QAM	1	74	20.15	20.25	20.16	21	0
15	16QAM	36	0	19.91	20.03	20.11		
15	16QAM	36	20	19.93	20.08	20.05		
15	16QAM	36	39	19.88	20.10	19.95	21	0
15	16QAM	75	0	19.89	20.06	20.04		
15	64QAM	1	0	20.09	20.19	20.23		
15	64QAM	1	37	20.11	20.26	20.22	21	0
15	64QAM	1	74	20.02	20.22	20.05		
15	64QAM	36	0	19.89	20.03	20.12		
15	64QAM	36	20	19.92	20.08	20.04	21	0
15	64QAM	36	39	19.88	20.10	19.93		
15	64QAM	75	0	19.87	20.07	20.02		
Channel				18650	18900	19150	Tune-up limit (dBm)	MPR (dB)
Frequency (MHz)				1855	1880	1905		
10	QPSK	1	0	20.24	20.40	20.40	21	0
10	QPSK	1	25	20.32	20.47	20.39		
10	QPSK	1	49	20.22	20.43	20.28		
10	QPSK	25	0	20.22	20.38	20.41	21	0
10	QPSK	25	12	20.30	20.47	20.41		
10	QPSK	25	25	20.25	20.43	20.30		
10	QPSK	50	0	20.27	20.45	20.38	21	0
10	16QAM	1	0	20.16	20.30	20.30		
10	16QAM	1	25	20.23	20.38	20.30		
10	16QAM	1	49	20.14	20.33	20.16	21	0
10	16QAM	25	0	19.85	20.00	20.03		
10	16QAM	25	12	19.93	20.09	20.05		
10	16QAM	25	25	19.88	20.06	19.89	21	0
10	16QAM	50	0	19.85	20.02	19.97		
10	64QAM	1	0	20.00	20.14	20.15		
10	64QAM	1	25	20.08	20.24	20.15	21	0
10	64QAM	1	49	19.99	20.20	20.05		
10	64QAM	25	0	19.84	19.99	20.03		
10	64QAM	25	12	19.94	20.10	20.06	21	0
10	64QAM	25	25	19.89	20.07	19.91		
10	64QAM	50	0	19.86	20.02	19.96		



Channel				18625	18900	19175	Tune-up limit (dBm)	MPR (dB)
Frequency (MHz)				1852.5	1880	1907.5		
5	QPSK	1	0	20.20	20.41	20.29	21	0
5	QPSK	1	12	20.30	20.45	20.38		
5	QPSK	1	24	20.21	20.40	20.28		
5	QPSK	12	0	20.23	20.42	20.36	21	0
5	QPSK	12	7	20.32	20.49	20.38		
5	QPSK	12	13	20.30	20.43	20.34		
5	QPSK	25	0	20.25	20.45	20.31	21	0
5	16QAM	1	0	20.11	20.25	20.21		
5	16QAM	1	12	20.22	20.37	20.24		
5	16QAM	1	24	20.14	20.30	20.14	21	0
5	16QAM	12	0	19.85	20.03	19.96		
5	16QAM	12	7	19.92	20.11	19.98		
5	16QAM	12	13	19.89	20.06	19.92	21	0
5	16QAM	25	0	19.88	20.09	19.98		
5	64QAM	1	0	20.03	20.18	20.09		
5	64QAM	1	12	20.08	20.25	20.17	21	0
5	64QAM	1	24	20.00	20.19	20.03		
5	64QAM	12	0	19.81	20.01	19.92		
5	64QAM	12	7	19.88	20.06	19.97	21	0
5	64QAM	12	13	19.84	20.05	19.92		
5	64QAM	25	0	19.89	20.08	19.97		
Channel				18615	18900	19185	Tune-up limit (dBm)	MPR (dB)
Frequency (MHz)				1851.5	1880	1908.5		
3	QPSK	1	0	19.96	20.16	20.03	21	0
3	QPSK	1	8	20.04	20.20	20.10		
3	QPSK	1	14	19.93	20.14	20.00		
3	QPSK	8	0	20.15	20.33	20.24	21	0
3	QPSK	8	4	20.23	20.39	20.31		
3	QPSK	8	7	20.17	20.35	20.22		
3	QPSK	15	0	20.16	20.35	20.25	21	0
3	16QAM	1	0	19.84	20.01	19.89		
3	16QAM	1	8	19.93	20.08	19.98		
3	16QAM	1	14	19.84	20.06	19.87	21	0
3	16QAM	8	0	19.85	20.01	19.92		
3	16QAM	8	4	19.90	20.06	19.97		
3	16QAM	8	7	19.84	20.02	19.89	21	0
3	16QAM	15	0	19.80	19.98	19.88		
3	64QAM	1	0	19.68	19.88	19.78		
3	64QAM	1	8	19.78	19.94	19.83	21	0
3	64QAM	1	14	19.72	19.94	19.75		
3	64QAM	8	0	19.78	19.95	19.86		
3	64QAM	8	4	19.84	20.01	19.90	21	0
3	64QAM	8	7	19.79	19.97	19.83		
3	64QAM	15	0	19.76	19.96	19.83		



Channel				18607	18900	19193	Tune-up limit (dBm)	MPR (dB)
Frequency (MHz)				1850.7	1880	1909.3		
1.4	QPSK	1	0	20.06	20.24	20.12	21	0
1.4	QPSK	1	3	20.14	20.29	20.18		
1.4	QPSK	1	5	20.08	20.24	20.13		
1.4	QPSK	3	0	20.17	20.37	20.23		
1.4	QPSK	3	1	20.19	20.35	20.22		
1.4	QPSK	3	3	20.20	20.34	20.22		
1.4	QPSK	6	0	20.29	20.44	20.31	21	0
1.4	16QAM	1	0	19.98	20.15	19.98	21	0
1.4	16QAM	1	3	20.00	20.19	20.03		
1.4	16QAM	1	5	19.98	20.12	19.98		
1.4	16QAM	3	0	19.82	20.00	19.86		
1.4	16QAM	3	1	19.81	20.01	19.88		
1.4	16QAM	3	3	19.82	19.99	19.87		
1.4	16QAM	6	0	19.97	20.16	20.03	21	0
1.4	64QAM	1	0	19.81	20.04	19.88	21	0
1.4	64QAM	1	3	19.89	20.05	19.93		
1.4	64QAM	1	5	19.85	19.99	19.88		
1.4	64QAM	3	0	19.84	19.98	19.89		
1.4	64QAM	3	1	19.86	20.02	19.91		
1.4	64QAM	3	3	19.83	19.99	19.86		
1.4	64QAM	6	0	19.92	20.08	19.95	21	0



<LTE Band 4>

BW [MHz]	Modulation	RB Size	RB Offset	Power Low Ch. / Freq.	Power Middle Ch. / Freq.	Power High Ch. / Freq.	Tune-up limit (dBm)	MPR (dB)
Channel				20050	20175	20300		
Frequency (MHz)				1720	1732.5	1745		
20	QPSK	1	0	21.22	21.50	21.18	22	0
20	QPSK	1	49	21.30	21.45	21.10		
20	QPSK	1	99	21.21	21.22	21.21		
20	QPSK	50	0	21.22	21.32	21.21	22	0
20	QPSK	50	24	21.28	21.30	21.11		
20	QPSK	50	50	21.15	21.31	21.02		
20	QPSK	100	0	21.15	21.26	21.12	22	0
20	16QAM	1	0	21.37	21.47	21.37		
20	16QAM	1	49	21.35	21.48	21.31		
20	16QAM	1	99	21.31	21.17	21.17	22	0
20	16QAM	50	0	21.20	21.23	21.20		
20	16QAM	50	24	21.28	21.29	21.10		
20	16QAM	50	50	21.30	21.14	21.02	22	0
20	16QAM	100	0	21.27	21.14	21.11		
20	64QAM	1	0	21.28	21.37	21.27		
20	64QAM	1	49	21.42	21.38	21.22	22	0
20	64QAM	1	99	21.24	21.10	21.03		
20	64QAM	50	0	20.51	20.51	20.39		
20	64QAM	50	24	20.54	20.54	20.32	21	1
20	64QAM	50	50	20.54	20.54	20.30		
20	64QAM	100	0	20.52	20.52	20.35		



Channel				20025	20175	20325	Tune-up limit (dBm)	MPR (dB)
Frequency (MHz)				1717.5	1732.5	1747.5		
15	QPSK	1	0	21.21	21.21	21.12	22	0
15	QPSK	1	37	21.25	21.25	21.10		
15	QPSK	1	74	21.20	21.20	20.92		
15	QPSK	36	0	21.19	21.19	21.07	22	0
15	QPSK	36	20	21.24	21.24	21.03		
15	QPSK	36	39	21.24	21.24	20.99		
15	QPSK	75	0	21.23	21.23	21.05	22	0
15	16QAM	1	0	21.43	21.43	21.33		
15	16QAM	1	37	21.30	21.33	21.37		
15	16QAM	1	74	21.45	21.45	21.25	22	0
15	16QAM	36	0	21.19	21.19	21.09		
15	16QAM	36	20	21.24	21.24	21.04		
15	16QAM	36	39	21.24	21.24	21.01	22	0
15	16QAM	75	0	21.25	21.25	21.05		
15	64QAM	1	0	21.34	21.34	21.22		
15	64QAM	1	37	21.38	21.38	21.23	22	0
15	64QAM	1	74	21.32	21.32	21.11		
15	64QAM	36	0	20.44	20.49	20.31		
15	64QAM	36	20	20.54	20.57	20.35	21	1
15	64QAM	36	39	20.51	20.48	20.26		
15	64QAM	75	0	20.47	20.47	20.29		
Channel				20000	20175	20350	Tune-up limit (dBm)	MPR (dB)
Frequency (MHz)				1715	1732.5	1750		
10	QPSK	1	0	21.17	21.20	21.02	22	0
10	QPSK	1	25	21.24	21.23	21.04		
10	QPSK	1	49	21.15	21.11	20.89		
10	QPSK	25	0	21.10	21.16	20.99	22	0
10	QPSK	25	12	21.23	21.24	21.05		
10	QPSK	25	25	21.20	21.16	20.94		
10	QPSK	50	0	21.18	21.20	21.03	22	0
10	16QAM	1	0	21.41	21.47	21.30		
10	16QAM	1	25	21.23	21.21	21.36		
10	16QAM	1	49	21.40	21.30	21.22	22	0
10	16QAM	25	0	21.14	21.20	21.03		
10	16QAM	25	12	21.26	21.26	21.07		
10	16QAM	25	25	21.24	21.17	20.97	22	0
10	16QAM	50	0	21.17	21.18	21.02		
10	64QAM	1	0	21.30	21.36	21.16		
10	64QAM	1	25	21.36	21.37	21.24	22	0
10	64QAM	1	49	21.29	21.22	21.09		
10	64QAM	25	0	20.41	20.46	20.20		
10	64QAM	25	12	20.49	20.50	20.27	21	1
10	64QAM	25	25	20.46	20.44	20.21		
10	64QAM	50	0	20.49	20.51	20.24		



Channel				19975	20175	20375	Tune-up limit (dBm)	MPR (dB)
Frequency (MHz)				1712.5	1732.5	1752.5		
5	QPSK	1	0	21.16	21.17	20.95	22	0
5	QPSK	1	12	21.22	21.23	20.98		
5	QPSK	1	24	21.13	21.14	20.90		
5	QPSK	12	0	21.14	21.18	20.90	22	0
5	QPSK	12	7	21.21	21.20	20.98		
5	QPSK	12	13	21.20	21.17	20.93		
5	QPSK	25	0	21.15	21.18	20.92	22	0
5	16QAM	1	0	21.42	21.43	21.25		
5	16QAM	1	12	21.40	21.46	21.31		
5	16QAM	1	24	21.37	21.34	21.20	22	0
5	16QAM	12	0	21.14	21.18	20.95		
5	16QAM	12	7	21.23	21.22	20.98		
5	16QAM	12	13	21.19	21.18	20.94	22	0
5	16QAM	25	0	21.18	21.21	20.96		
5	64QAM	1	0	21.28	21.33	21.17		
5	64QAM	1	12	21.34	21.38	21.17	22	0
5	64QAM	1	24	21.25	21.27	21.10		
5	64QAM	12	0	20.41	20.42	20.16		
5	64QAM	12	7	20.44	20.45	20.20	21	1
5	64QAM	12	13	20.40	20.41	20.15		
5	64QAM	25	0	20.36	20.38	20.12		
Channel				19965	20175	20385	Tune-up limit (dBm)	MPR (dB)
Frequency (MHz)				1711.5	1732.5	1753.5		
3	QPSK	1	0	20.85	20.90	20.64	22	0
3	QPSK	1	8	20.94	20.96	20.72		
3	QPSK	1	14	20.85	20.84	20.60		
3	QPSK	8	0	21.07	21.09	20.85	22	0
3	QPSK	8	4	21.13	21.16	20.89		
3	QPSK	8	7	21.08	21.11	20.84		
3	QPSK	15	0	21.08	21.09	20.83	22	0
3	16QAM	1	0	21.08	21.11	20.91		
3	16QAM	1	8	21.17	21.19	21.03		
3	16QAM	1	14	21.07	21.10	20.93	22	0
3	16QAM	8	0	21.15	21.16	20.92		
3	16QAM	8	4	21.22	21.20	20.96		
3	16QAM	8	7	21.14	21.14	20.89	22	0
3	16QAM	15	0	21.08	21.11	20.86		
3	64QAM	1	0	20.98	20.98	20.80		
3	64QAM	1	8	21.05	21.06	20.88	22	0
3	64QAM	1	14	20.96	20.98	20.77		
3	64QAM	8	0	20.44	20.44	20.22		
3	64QAM	8	4	20.41	20.47	20.22	21	1
3	64QAM	8	7	20.39	20.43	20.19		
3	64QAM	15	0	20.48	20.51	20.26		



Channel				19957	20175	20393	Tune-up limit (dBm)	MPR (dB)
Frequency (MHz)				1710.7	1732.5	1754.3		
1.4	QPSK	1	0	20.98	21.00	20.74	22	0
1.4	QPSK	1	3	21.01	21.05	20.80		
1.4	QPSK	1	5	20.98	21.01	20.74		
1.4	QPSK	3	0	21.08	21.11	20.86		
1.4	QPSK	3	1	21.09	21.12	20.87		
1.4	QPSK	3	3	21.06	21.11	20.85		
1.4	QPSK	6	0	21.16	21.20	20.93	22	0
1.4	16QAM	1	0	21.23	21.25	21.08	22	0
1.4	16QAM	1	3	21.27	21.31	21.13		
1.4	16QAM	1	5	21.24	21.26	21.07		
1.4	16QAM	3	0	21.05	21.10	20.88		
1.4	16QAM	3	1	21.09	21.11	20.90		
1.4	16QAM	3	3	21.06	21.11	20.88		
1.4	16QAM	6	0	21.25	21.29	21.05	22	0
1.4	64QAM	1	0	21.15	21.16	20.94	22	0
1.4	64QAM	1	3	21.16	21.18	20.99		
1.4	64QAM	1	5	21.12	21.13	20.95		
1.4	64QAM	3	0	21.14	21.14	20.92		
1.4	64QAM	3	1	21.11	21.17	20.92		
1.4	64QAM	3	3	21.09	21.13	20.89		
1.4	64QAM	6	0	20.67	20.56	20.56	21	1

<WWAN Bottom Antenna --Reduced Power for Hotspot On>

<LTE Band 2>

BW [MHz]	Modulation	RB Size	RB Offset	Power Low Ch. / Freq.	Power Middle Ch. / Freq.	Power High Ch. / Freq.	Tune-up limit (dBm)	MPR (dB)
Channel				18700	18900	19100		
Frequency (MHz)				1860	1880	1900		
20	QPSK	1	0	18.12	18.21	18.48	19	0
20	QPSK	1	49	18.03	18.14	18.11		
20	QPSK	1	99	18.21	18.24	18.14		
20	QPSK	50	0	18.02	18.09	18.49	19	0
20	QPSK	50	24	18.07	18.16	18.13		
20	QPSK	50	50	17.97	18.17	17.94		
20	QPSK	100	0	17.98	18.12	18.07	19	0
20	16QAM	1	0	18.23	18.32	18.42		
20	16QAM	1	49	18.35	18.47	18.43		
20	16QAM	1	99	18.19	18.40	18.14	19	0
20	16QAM	50	0	18.02	18.08	18.21		
20	16QAM	50	24	18.05	18.16	18.14		
20	16QAM	50	50	17.97	18.18	17.95	19	0
20	16QAM	100	0	17.98	18.10	18.05		
20	64QAM	1	0	18.09	18.18	18.29		
20	64QAM	1	49	18.22	18.31	18.31	19	0
20	64QAM	1	99	18.06	18.26	18.03		
20	64QAM	50	0	18.00	18.07	18.19		
20	64QAM	50	24	18.03	18.16	18.17	19	0
20	64QAM	50	50	17.96	18.16	17.93		
20	64QAM	100	0	17.98	18.12	18.06		



Channel				18675	18900	19125	Tune-up limit (dBm)	MPR (dB)
Frequency (MHz)				1857.5	1880	1902.5		
15	QPSK	1	0	17.99	18.12	18.10	19	0
15	QPSK	1	37	18.02	18.15	18.05		
15	QPSK	1	74	17.94	18.13	17.93		
15	QPSK	36	0	17.99	18.10	18.13	19	0
15	QPSK	36	20	18.02	18.13	18.05		
15	QPSK	36	39	17.97	18.15	17.94		
15	QPSK	75	0	17.99	18.15	18.05	19	0
15	16QAM	1	0	18.25	18.36	18.37		
15	16QAM	1	37	18.33	18.41	18.33		
15	16QAM	1	74	18.22	18.38	18.21	19	0
15	16QAM	36	0	18.02	18.11	18.13		
15	16QAM	36	20	18.03	18.14	18.08		
15	16QAM	36	39	17.98	18.16	17.95	19	0
15	16QAM	75	0	18.01	18.14	18.06		
15	64QAM	1	0	18.15	18.25	18.25		
15	64QAM	1	37	18.18	18.28	18.22	19	0
15	64QAM	1	74	18.10	18.26	18.08		
15	64QAM	36	0	18.00	18.08	18.13		
15	64QAM	36	20	18.01	18.14	18.09	19	0
15	64QAM	36	39	17.99	18.14	17.93		
15	64QAM	75	0	18.00	18.14	18.05		
Channel				18650	18900	19150	Tune-up limit (dBm)	MPR (dB)
Frequency (MHz)				1855	1880	1905		
10	QPSK	1	0	17.95	18.04	18.04	19	0
10	QPSK	1	25	17.98	18.14	17.97		
10	QPSK	1	49	17.91	18.07	17.90		
10	QPSK	25	0	17.92	18.02	18.02	19	0
10	QPSK	25	12	17.99	18.15	18.05		
10	QPSK	25	25	17.95	18.11	17.89		
10	QPSK	50	0	17.95	18.09	18.01	19	0
10	16QAM	1	0	18.25	18.35	18.33		
10	16QAM	1	25	18.30	18.42	18.31		
10	16QAM	1	49	18.22	18.36	18.17	19	0
10	16QAM	25	0	17.93	18.06	18.07		
10	16QAM	25	12	18.02	18.14	18.07		
10	16QAM	25	25	17.95	18.11	17.93	19	0
10	16QAM	50	0	17.94	18.10	18.01		
10	64QAM	1	0	18.10	18.22	18.18		
10	64QAM	1	25	18.13	18.27	18.15	19	0
10	64QAM	1	49	18.04	18.22	18.06		
10	64QAM	25	0	17.93	18.03	18.04		
10	64QAM	25	12	18.01	18.13	18.06	19	0
10	64QAM	25	25	17.96	18.12	17.91		
10	64QAM	50	0	17.94	18.05	18.00		



Channel				18625	18900	19175	Tune-up limit (dBm)	MPR (dB)
Frequency (MHz)				1852.5	1880	1907.5		
5	QPSK	1	0	17.91	18.06	17.89	19	0
5	QPSK	1	12	17.96	18.11	18.00		
5	QPSK	1	24	17.90	18.05	17.90		
5	QPSK	12	0	17.93	18.07	17.96	19	0
5	QPSK	12	7	17.98	18.15	17.99		
5	QPSK	12	13	17.95	18.10	17.95		
5	QPSK	25	0	17.95	18.11	17.96	19	0
5	16QAM	1	0	18.22	18.35	18.21		
5	16QAM	1	12	18.27	18.41	18.30		
5	16QAM	1	24	18.17	18.31	18.14	19	0
5	16QAM	12	0	17.93	18.08	17.98		
5	16QAM	12	7	17.98	18.16	18.02		
5	16QAM	12	13	17.99	18.12	17.94	19	0
5	16QAM	25	0	17.98	18.12	18.00		
5	64QAM	1	0	18.07	18.24	18.12		
5	64QAM	1	12	18.18	18.32	18.18	19	0
5	64QAM	1	24	18.06	18.21	18.08		
5	64QAM	12	0	17.91	18.05	17.94		
5	64QAM	12	7	17.95	18.13	17.99	19	0
5	64QAM	12	13	17.92	18.06	17.91		
5	64QAM	25	0	17.98	18.13	17.98		
Channel				18615	18900	19185	Tune-up limit (dBm)	MPR (dB)
Frequency (MHz)				1851.5	1880	1908.5		
3	QPSK	1	0	17.63	17.79	17.62	19	0
3	QPSK	1	8	17.70	17.86	17.69		
3	QPSK	1	14	17.61	17.77	17.58		
3	QPSK	8	0	17.84	18.00	17.87	19	0
3	QPSK	8	4	17.90	18.06	17.93		
3	QPSK	8	7	17.86	18.03	17.82		
3	QPSK	15	0	17.85	18.02	17.87	19	0
3	16QAM	1	0	17.93	18.07	17.93		
3	16QAM	1	8	18.01	18.17	17.97		
3	16QAM	1	14	17.92	18.07	17.92	19	0
3	16QAM	8	0	17.92	18.03	17.93		
3	16QAM	8	4	17.96	18.08	17.99		
3	16QAM	8	7	17.90	18.05	17.90	19	0
3	16QAM	15	0	17.88	18.02	17.90		
3	64QAM	1	0	17.78	17.91	17.81		
3	64QAM	1	8	17.87	17.99	17.85	19	0
3	64QAM	1	14	17.77	17.91	17.76		
3	64QAM	8	0	17.85	18.00	17.90		
3	64QAM	8	4	17.91	18.05	17.95	19	0
3	64QAM	8	7	17.84	18.01	17.84		
3	64QAM	15	0	17.81	18.01	17.86		



Channel				18607	18900	19193	Tune-up limit (dBm)	MPR (dB)
Frequency (MHz)				1850.7	1880	1909.3		
1.4	QPSK	1	0	17.74	17.89	17.71	19	0
1.4	QPSK	1	3	17.77	17.94	17.76		
1.4	QPSK	1	5	17.74	17.88	17.73		
1.4	QPSK	3	0	17.85	17.99	17.82		
1.4	QPSK	3	1	17.88	18.01	17.84		
1.4	QPSK	3	3	17.84	17.99	17.84		
1.4	QPSK	6	0	17.95	18.08	17.94	19	0
1.4	16QAM	1	0	18.06	18.21	18.02	19	0
1.4	16QAM	1	3	18.10	18.25	18.08		
1.4	16QAM	1	5	18.07	18.18	18.04		
1.4	16QAM	3	0	17.88	18.02	17.85		
1.4	16QAM	3	1	17.89	18.00	17.86		
1.4	16QAM	3	3	17.88	17.96	17.83		
1.4	16QAM	6	0	18.05	18.16	18.03	19	0
1.4	64QAM	1	0	17.95	18.10	17.92	19	0
1.4	64QAM	1	3	17.93	18.12	17.96		
1.4	64QAM	1	5	17.95	18.06	17.93		
1.4	64QAM	3	0	17.95	18.05	17.91		
1.4	64QAM	3	1	17.93	18.07	17.92		
1.4	64QAM	3	3	17.91	18.06	17.90		
1.4	64QAM	6	0	17.97	18.12	17.94	19	0



<LTE Band 4>

BW [MHz]	Modulation	RB Size	RB Offset	Power Low Ch. / Freq.	Power Middle Ch. / Freq.	Power High Ch. / Freq.	Tune-up limit (dBm)	MPR (dB)
Channel				20050	20175	20300		
Frequency (MHz)				1720	1732.5	1745		
20	QPSK	1	0	21.22	21.50	21.18	22	0
20	QPSK	1	49	21.30	21.45	21.10		
20	QPSK	1	99	21.21	21.22	21.21		
20	QPSK	50	0	21.22	21.32	21.21	22	0
20	QPSK	50	24	21.28	21.30	21.11		
20	QPSK	50	50	21.15	21.31	21.02		
20	QPSK	100	0	21.15	21.26	21.12	22	0
20	16QAM	1	0	21.37	21.47	21.37		
20	16QAM	1	49	21.35	21.48	21.31		
20	16QAM	1	99	21.31	21.17	21.17	22	0
20	16QAM	50	0	21.20	21.23	21.20		
20	16QAM	50	24	21.28	21.29	21.10		
20	16QAM	50	50	21.30	21.14	21.02	22	0
20	16QAM	100	0	21.27	21.14	21.11		
20	64QAM	1	0	21.28	21.37	21.27		
20	64QAM	1	49	21.42	21.38	21.22	22	0
20	64QAM	1	99	21.24	21.10	21.03		
20	64QAM	50	0	20.51	20.51	20.39		
20	64QAM	50	24	20.54	20.54	20.32	21	1
20	64QAM	50	50	20.54	20.54	20.30		
20	64QAM	100	0	20.52	20.52	20.35		



Channel				20025	20175	20325	Tune-up limit (dBm)	MPR (dB)
Frequency (MHz)				1717.5	1732.5	1747.5		
15	QPSK	1	0	21.21	21.21	21.12	22	0
15	QPSK	1	37	21.25	21.25	21.10		
15	QPSK	1	74	21.20	21.20	20.92		
15	QPSK	36	0	21.19	21.19	21.07	22	0
15	QPSK	36	20	21.24	21.24	21.03		
15	QPSK	36	39	21.24	21.24	20.99		
15	QPSK	75	0	21.23	21.23	21.05	22	0
15	16QAM	1	0	21.43	21.43	21.33		
15	16QAM	1	37	21.30	21.33	21.37		
15	16QAM	1	74	21.45	21.45	21.25	22	0
15	16QAM	36	0	21.19	21.19	21.09		
15	16QAM	36	20	21.24	21.24	21.04		
15	16QAM	36	39	21.24	21.24	21.01	22	0
15	16QAM	75	0	21.25	21.25	21.05		
15	64QAM	1	0	21.34	21.34	21.22		
15	64QAM	1	37	21.38	21.38	21.23	22	0
15	64QAM	1	74	21.32	21.32	21.11		
15	64QAM	36	0	20.44	20.49	20.31		
15	64QAM	36	20	20.54	20.57	20.35	21	1
15	64QAM	36	39	20.51	20.48	20.26		
15	64QAM	75	0	20.47	20.47	20.29		
Channel				20000	20175	20350	Tune-up limit (dBm)	MPR (dB)
Frequency (MHz)				1715	1732.5	1750		
10	QPSK	1	0	21.17	21.20	21.02	22	0
10	QPSK	1	25	21.24	21.23	21.04		
10	QPSK	1	49	21.15	21.11	20.89		
10	QPSK	25	0	21.10	21.16	20.99	22	0
10	QPSK	25	12	21.23	21.24	21.05		
10	QPSK	25	25	21.20	21.16	20.94		
10	QPSK	50	0	21.18	21.20	21.03	22	0
10	16QAM	1	0	21.41	21.47	21.30		
10	16QAM	1	25	21.23	21.21	21.36		
10	16QAM	1	49	21.40	21.30	21.22	22	0
10	16QAM	25	0	21.14	21.20	21.03		
10	16QAM	25	12	21.26	21.26	21.07		
10	16QAM	25	25	21.24	21.17	20.97	22	0
10	16QAM	50	0	21.17	21.18	21.02		
10	64QAM	1	0	21.30	21.36	21.16		
10	64QAM	1	25	21.36	21.37	21.24	22	0
10	64QAM	1	49	21.29	21.22	21.09		
10	64QAM	25	0	20.41	20.46	20.20		
10	64QAM	25	12	20.49	20.50	20.27	21	1
10	64QAM	25	25	20.46	20.44	20.21		
10	64QAM	50	0	20.49	20.51	20.24		



Channel				19975	20175	20375	Tune-up limit (dBm)	MPR (dB)
Frequency (MHz)				1712.5	1732.5	1752.5		
5	QPSK	1	0	21.16	21.17	20.95	22	0
5	QPSK	1	12	21.22	21.23	20.98		
5	QPSK	1	24	21.13	21.14	20.90		
5	QPSK	12	0	21.14	21.18	20.90	22	0
5	QPSK	12	7	21.21	21.20	20.98		
5	QPSK	12	13	21.20	21.17	20.93		
5	QPSK	25	0	21.15	21.18	20.92	22	0
5	16QAM	1	0	21.42	21.43	21.25		
5	16QAM	1	12	21.40	21.46	21.31		
5	16QAM	1	24	21.37	21.34	21.20	22	0
5	16QAM	12	0	21.14	21.18	20.95		
5	16QAM	12	7	21.23	21.22	20.98		
5	16QAM	12	13	21.19	21.18	20.94	22	0
5	16QAM	25	0	21.18	21.21	20.96		
5	64QAM	1	0	21.28	21.33	21.17		
5	64QAM	1	12	21.34	21.38	21.17	22	0
5	64QAM	1	24	21.25	21.27	21.10		
5	64QAM	12	0	20.41	20.42	20.16		
5	64QAM	12	7	20.44	20.45	20.20	21	1
5	64QAM	12	13	20.40	20.41	20.15		
5	64QAM	25	0	20.36	20.38	20.12		
Channel				19965	20175	20385	Tune-up limit (dBm)	MPR (dB)
Frequency (MHz)				1711.5	1732.5	1753.5		
3	QPSK	1	0	20.85	20.90	20.64	22	0
3	QPSK	1	8	20.94	20.96	20.72		
3	QPSK	1	14	20.85	20.84	20.60		
3	QPSK	8	0	21.07	21.09	20.85	22	0
3	QPSK	8	4	21.13	21.16	20.89		
3	QPSK	8	7	21.08	21.11	20.84		
3	QPSK	15	0	21.08	21.09	20.83	22	0
3	16QAM	1	0	21.08	21.11	20.91		
3	16QAM	1	8	21.17	21.19	21.03		
3	16QAM	1	14	21.07	21.10	20.93	22	0
3	16QAM	8	0	21.15	21.16	20.92		
3	16QAM	8	4	21.22	21.20	20.96		
3	16QAM	8	7	21.14	21.14	20.89	22	0
3	16QAM	15	0	21.08	21.11	20.86		
3	64QAM	1	0	20.98	20.98	20.80		
3	64QAM	1	8	21.05	21.06	20.88	22	0
3	64QAM	1	14	20.96	20.98	20.77		
3	64QAM	8	0	20.44	20.44	20.22		
3	64QAM	8	4	20.41	20.47	20.22	21	1
3	64QAM	8	7	20.39	20.43	20.19		
3	64QAM	15	0	20.48	20.51	20.26		



Channel				19957	20175	20393	Tune-up limit (dBm)	MPR (dB)
Frequency (MHz)				1710.7	1732.5	1754.3		
1.4	QPSK	1	0	20.98	21.00	20.74	22	0
1.4	QPSK	1	3	21.01	21.05	20.80		
1.4	QPSK	1	5	20.98	21.01	20.74		
1.4	QPSK	3	0	21.08	21.11	20.86		
1.4	QPSK	3	1	21.09	21.12	20.87		
1.4	QPSK	3	3	21.06	21.11	20.85		
1.4	QPSK	6	0	21.16	21.20	20.93	22	0
1.4	16QAM	1	0	21.23	21.25	21.08	22	0
1.4	16QAM	1	3	21.27	21.31	21.13		
1.4	16QAM	1	5	21.24	21.26	21.07		
1.4	16QAM	3	0	21.05	21.10	20.88		
1.4	16QAM	3	1	21.09	21.11	20.90		
1.4	16QAM	3	3	21.06	21.11	20.88		
1.4	16QAM	6	0	21.25	21.29	21.05	22	0
1.4	64QAM	1	0	21.15	21.16	20.94	22	0
1.4	64QAM	1	3	21.16	21.18	20.99		
1.4	64QAM	1	5	21.12	21.13	20.95		
1.4	64QAM	3	0	21.14	21.14	20.92		
1.4	64QAM	3	1	21.11	21.17	20.92		
1.4	64QAM	3	3	21.09	21.13	20.89		
1.4	64QAM	6	0	20.67	20.56	20.56	21	1



<LTE Band 7>

BW [MHz]	Modulation	RB Size	RB Offset	Power Low Ch. / Freq.	Power Middle Ch. / Freq.	Power High Ch. / Freq.	Tune-up limit (dBm)	MPR (dB)
Channel				20850	21100	21350		
Frequency (MHz)				2510	2535	2560		
20	QPSK	1	0	23.13	23.00	23.10	23.5	0
20	QPSK	1	49	23.12	23.18	23.45		
20	QPSK	1	99	23.15	23.16	23.37		
20	QPSK	50	0	22.47	22.72	22.70	23	0.5
20	QPSK	50	24	22.65	22.75	22.89		
20	QPSK	50	50	22.69	22.70	22.69		
20	QPSK	100	0	22.56	22.68	22.69		
20	16QAM	1	0	22.63	22.64	22.80	23	0.5
20	16QAM	1	49	22.84	22.88	23.00		
20	16QAM	1	99	22.76	22.89	23.00		
20	16QAM	50	0	21.44	21.70	21.69	22	1.5
20	16QAM	50	24	21.63	21.72	21.88		
20	16QAM	50	50	21.67	21.68	21.68		
20	16QAM	100	0	21.56	21.68	21.65		
20	64QAM	1	0	21.54	21.57	21.72	22	1.5
20	64QAM	1	49	21.75	21.78	21.90		
20	64QAM	1	99	21.67	21.81	21.99		
20	64QAM	50	0	20.45	20.68	20.68	21	2.5
20	64QAM	50	24	20.62	20.70	20.86		
20	64QAM	50	50	20.68	20.67	20.66		
20	64QAM	100	0	20.56	20.69	20.68		



Channel				20825	21100	21375	Tune-up limit (dBm)	MPR (dB)
Frequency (MHz)				2507.5	2535	2562.5		
15	QPSK	1	0	23.03	23.09	23.21	23.5	0
15	QPSK	1	37	23.12	23.21	23.37		
15	QPSK	1	74	23.13	23.23	23.44		
15	QPSK	36	0	22.51	22.65	22.83	23	0.5
15	QPSK	36	20	22.61	22.69	22.87		
15	QPSK	36	39	22.64	22.70	22.82		
15	QPSK	75	0	22.59	22.69	22.84	23	0.5
15	16QAM	1	0	22.72	22.75	22.90		
15	16QAM	1	37	22.84	22.89	22.89		
15	16QAM	1	74	22.80	22.97	22.87	22	1.5
15	16QAM	36	0	21.52	21.68	21.86		
15	16QAM	36	20	21.62	21.70	21.89		
15	16QAM	36	39	21.63	21.69	21.84	22	1.5
15	16QAM	75	0	21.58	21.68	21.82		
15	64QAM	1	0	21.66	21.67	21.80		
15	64QAM	1	37	21.74	21.79	21.97	22	1.5
15	64QAM	1	74	21.73	21.87	21.89		
15	64QAM	36	0	20.51	20.65	20.83		
15	64QAM	36	20	20.61	20.69	20.86	21	2.5
15	64QAM	36	39	20.62	20.70	20.84		
15	64QAM	75	0	20.58	20.66	20.83		
Channel				20800	21100	21400	Tune-up limit (dBm)	MPR (dB)
Frequency (MHz)				2505	2535	2565		
10	QPSK	1	0	23.00	23.08	23.20	23.5	0
10	QPSK	1	25	23.13	23.19	23.37		
10	QPSK	1	49	23.06	23.16	23.37		
10	QPSK	25	0	22.54	22.65	22.90	23	0.5
10	QPSK	25	12	22.61	22.70	22.91		
10	QPSK	25	25	22.63	22.68	22.79		
10	QPSK	50	0	22.60	22.69	22.88	23	0.5
10	16QAM	1	0	22.73	22.74	22.89		
10	16QAM	1	25	22.84	22.87	22.89		
10	16QAM	1	49	22.78	22.88	22.87	22	1.5
10	16QAM	25	0	21.55	21.68	21.92		
10	16QAM	25	12	21.62	21.72	21.93		
10	16QAM	25	25	21.63	21.68	21.82	22	1.5
10	16QAM	50	0	21.56	21.67	21.86		
10	64QAM	1	0	21.61	21.65	21.77		
10	64QAM	1	25	21.74	21.78	21.97	22	1.5
10	64QAM	1	49	21.68	21.75	21.99		
10	64QAM	25	0	20.52	20.67	20.91		
10	64QAM	25	12	20.60	20.71	20.94	21	2.5
10	64QAM	25	25	20.64	20.69	20.82		
10	64QAM	50	0	20.54	20.66	20.84		



Channel				20775	21100	21425	Tune-up limit (dBm)	MPR (dB)
Frequency (MHz)				2502.5	2535	2567.5		
5	QPSK	1	0	22.99	23.06	23.26	23.5	0
5	QPSK	1	12	23.12	23.18	23.39		
5	QPSK	1	24	23.06	23.13	23.36		
5	QPSK	12	0	22.54	22.62	22.90	23	0.5
5	QPSK	12	7	22.61	22.69	22.90		
5	QPSK	12	13	22.61	22.66	22.87		
5	QPSK	25	0	22.57	22.65	22.91	23	0.5
5	16QAM	1	0	22.68	22.73	22.90		
5	16QAM	1	12	22.83	22.84	22.89		
5	16QAM	1	24	22.77	22.81	22.87	22	1.5
5	16QAM	12	0	21.52	21.63	21.91		
5	16QAM	12	7	21.61	21.69	21.91		
5	16QAM	12	13	21.61	21.66	21.87	22	1.5
5	16QAM	25	0	21.60	21.67	21.92		
5	64QAM	1	0	21.64	21.65	21.89		
5	64QAM	1	12	21.72	21.78	21.87	22	1.5
5	64QAM	1	24	21.67	21.72	21.98		
5	64QAM	12	0	20.51	20.61	20.89		
5	64QAM	12	7	20.59	20.63	20.88	21	2.5
5	64QAM	12	13	20.58	20.64	20.83		
5	64QAM	25	0	20.76	20.87	20.89		

<TDD LTE SAR Measurement>

TDD LTE configuration setup for SAR measurement

SAR was tested with a fixed periodic duty factor according to the highest transmission duty factor implemented for the device and supported by 3GPP.

- a. 3GPP TS 36.211 section 4.2 for Type 2 Frame Structure and Table 4.2-2 for uplink-downlink configurations
- b. "special subframe S" contains both uplink and downlink transmissions, it has been taken into consideration to determine the transmission duty factor according to the worst case uplink and downlink cyclic prefix requirements for UpPTS
- c. Establishing connections with base station simulators ensure a consistent means for testing SAR and recommended for evaluating SAR. The Anritsu MT8820C (firmware: #22.52#004) was used for LTE output power measurements and SAR testing.

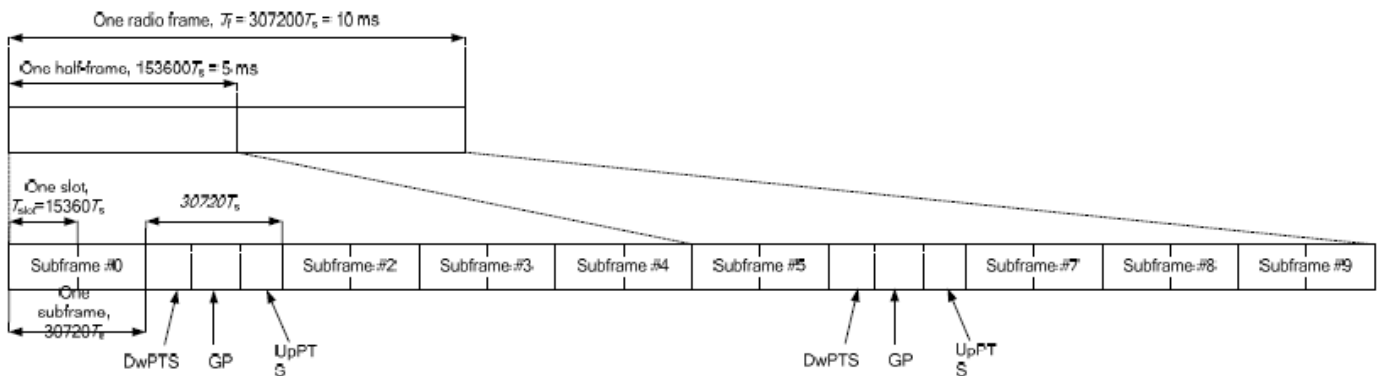

Figure 4.2-1: Frame structure type 2 (for 5 ms switch-point periodicity).

Table 4.2-2: Uplink-downlink configurations.

Uplink-downlink configuration	Downlink-to-Uplink Switch-point periodicity	Subframe number									
		0	1	2	3	4	5	6	7	8	9
0	5 ms	D	S	U	U	U	D	S	U	U	U
1	5 ms	D	S	U	U	D	D	S	U	U	D
2	5 ms	D	S	U	D	D	D	S	U	D	D
3	10 ms	D	S	U	U	U	D	D	D	D	D
4	10 ms	D	S	U	U	D	D	D	D	D	D
5	10 ms	D	S	U	D	D	D	D	D	D	D
6	5 ms	D	S	U	U	U	D	S	U	U	D

Table 4.2-1: Configuration of special subframe (lengths of DwPTS/GP/UpPTS).

Special subframe configuration	Normal cyclic prefix in downlink			Extended cyclic prefix in downlink				
	DwPTS	UpPTS		DwPTS	UpPTS			
		Normal cyclic prefix in uplink	Extended cyclic prefix in uplink		Normal cyclic prefix in uplink	Extended cyclic prefix in uplink		
0	6592 · Ts	2192 · Ts	2560 · Ts	7680 · Ts	2192 · Ts	2560 · Ts		
1	19760 · Ts			20480 · Ts				
2	21952 · Ts			23040 · Ts				
3	24144 · Ts			25600 · Ts				
4	26336 · Ts			7680 · Ts				
5	6592 · Ts	4384 · Ts	5120 · Ts	20480 · Ts	4384 · Ts	5120 · Ts		
6	19760 · Ts			23040 · Ts				
7	21952 · Ts			12800 · Ts				
8	24144 · Ts			-			-	-
9	13168 · Ts			-			-	-

Special subframe (30720·T _s): Normal cyclic prefix in downlink (UpPTS)			
	Special subframe configuration	Normal cyclic prefix in uplink	Extended cyclic prefix in uplink
Uplink duty factor in one special subframe	0~4	7.13%	8.33%
	5~9	14.3%	16.7%

Special subframe(30720·T _s): Extended cyclic prefix in downlink (UpPTS)			
	Special subframe configuration	Normal cyclic prefix in uplink	Extended cyclic prefix in uplink
Uplink duty factor in one special subframe	0~3	7.13%	8.33%
	4~7	14.3%	16.7%

The highest duty factor is resulted from:

- i. Uplink-downlink configuration: 0. In a half-frame consisted of 5 subframes, uplink operation is in 3 uplink subframes and 1 special subframe.
- ii. special subframe configuration: 5-9 for normal cyclic prefix in downlink, 4-7 for extended cyclic prefix in downlink
- iii. for special subframe with extended cyclic prefix in uplink, the total uplink duty factor in one half-frame is: $(3+0.167)/5 = 63.3\%$
- iv. for special subframe with normal cyclic prefix in uplink, the total uplink duty factor in one half-frame is: $(3+0.143)/5 = 62.9\%$
- v. For TDD LTE SAR measurement, the duty cycle 1:1.59 (62.9 %) was used perform testing and considering the theoretical duty cycle of 63.3% for extended cyclic prefix in the uplink, and the theoretical duty cycle of 62.9% for normal cyclic prefix in uplink, a scaling factor of extended cyclic prefix $63.3\%/62.9\% = 1.006$ is applied to scale-up the measured SAR result. The scaled TDD LTE SAR = measured SAR (W/kg)* Tune-up Scaling Factor* scaling factor for extended cyclic prefix.



<WWAN Top/Bottom Antenna-- Full Power Mode>

<LTE Band 38>

BW [MHz]	Modulation	RB Size	RB Offset	Power Low Ch. / Freq.	Power Middle Ch. / Freq.	Power High Ch. / Freq.	Tune-up limit (dBm)	MPR (dB)
Channel				37850	38000	38150		
Frequency (MHz)				2580	2595	2610		
20	QPSK	1	0	23.66	23.95	23.64	24	0
20	QPSK	1	49	23.90	23.78	23.86		
20	QPSK	1	99	23.78	23.69	23.73		
20	QPSK	50	0	22.80	22.97	22.77	23	1
20	QPSK	50	24	22.91	22.84	22.88		
20	QPSK	50	50	22.87	22.81	22.80		
20	QPSK	100	0	22.83	22.80	22.78	23	1
20	16QAM	1	0	22.82	22.76	22.74		
20	16QAM	1	49	22.93	22.96	22.92		
20	16QAM	1	99	22.86	22.83	22.79	22	2
20	16QAM	50	0	21.91	21.77	21.83		
20	16QAM	50	24	21.95	21.88	21.90		
20	16QAM	50	50	21.93	21.88	21.87	22	2
20	16QAM	100	0	21.89	21.79	21.77		
20	64QAM	1	0	21.57	21.51	21.51		
20	64QAM	1	49	21.73	21.70	21.66	22	2
20	64QAM	1	99	21.62	21.58	21.64		
20	64QAM	50	0	20.86	20.72	20.75		
20	64QAM	50	24	20.92	20.83	20.85	21	3
20	64QAM	50	50	20.84	20.89	20.81		
20	64QAM	100	0	20.95	20.88	20.85		



Channel				37825	38000	38175	Tune-up limit (dBm)	MPR (dB)
Frequency (MHz)				2577.5	2595	2612.5		
15	QPSK	1	0	23.75	23.73	23.72	24	0
15	QPSK	1	37	23.90	23.85	23.90		
15	QPSK	1	74	23.82	23.81	23.82		
15	QPSK	36	0	22.84	22.77	22.75	23	1
15	QPSK	36	20	22.88	22.79	22.87		
15	QPSK	36	39	22.87	22.85	22.84		
15	QPSK	75	0	22.88	22.85	22.85		
15	16QAM	1	0	22.93	22.87	22.84	23	1
15	16QAM	1	37	22.92	22.88	22.93		
15	16QAM	1	74	22.98	22.93	22.95		
15	16QAM	36	0	21.77	21.76	21.72	22	2
15	16QAM	36	20	21.90	21.78	21.87		
15	16QAM	36	39	21.87	21.83	21.80		
15	16QAM	75	0	21.90	21.87	21.88		
15	64QAM	1	0	21.70	21.61	21.59	22	2
15	64QAM	1	37	21.75	21.71	21.66		
15	64QAM	1	74	21.74	21.66	21.69		
15	64QAM	36	0	20.88	20.82	20.78	21	3
15	64QAM	36	20	20.92	20.89	20.93		
15	64QAM	36	39	20.93	20.88	20.82		
15	64QAM	75	0	20.90	20.85	20.88		
Channel				37800	38000	38200	Tune-up limit (dBm)	MPR (dB)
Frequency (MHz)				2575	2595	2615		
10	QPSK	1	0	23.83	23.77	23.73	24	0
10	QPSK	1	25	23.88	23.80	23.83		
10	QPSK	1	49	23.94	23.84	23.86		
10	QPSK	25	0	22.87	22.80	22.81	23	1
10	QPSK	25	12	22.92	22.83	22.85		
10	QPSK	25	25	22.88	22.84	22.85		
10	QPSK	50	0	22.93	22.85	22.84		
10	16QAM	1	0	22.90	22.91	22.92	23	1
10	16QAM	1	25	22.98	22.95	22.87		
10	16QAM	1	49	22.97	22.96	22.97		
10	16QAM	25	0	21.88	21.82	21.87	22	2
10	16QAM	25	12	21.96	21.93	21.95		
10	16QAM	25	25	21.93	21.93	21.89		
10	16QAM	50	0	21.89	21.90	21.92		
10	64QAM	1	0	21.71	21.66	21.65	22	2
10	64QAM	1	25	21.75	21.67	21.62		
10	64QAM	1	49	21.76	21.73	21.71		
10	64QAM	25	0	20.86	20.80	20.83	21	3
10	64QAM	25	12	20.92	20.86	20.89		
10	64QAM	25	25	20.94	20.86	20.86		
10	64QAM	50	0	20.87	20.85	20.85		



Channel				37775	38000	38225	Tune-up limit (dBm)	MPR (dB)
Frequency (MHz)				2572.5	2595	2617.5		
5	QPSK	1	0	23.74	23.71	23.70	24	0
5	QPSK	1	12	23.87	23.78	23.82		
5	QPSK	1	24	23.73	23.63	23.68		
5	QPSK	12	0	22.83	22.79	22.86	23	1
5	QPSK	12	7	22.88	22.85	22.88		
5	QPSK	12	13	22.86	22.78	22.83		
5	QPSK	25	0	22.90	22.80	22.83		
5	16QAM	1	0	22.86	22.81	22.74	23	1
5	16QAM	1	12	22.95	22.94	22.93		
5	16QAM	1	24	22.90	22.84	22.86		
5	16QAM	12	0	21.86	21.79	21.85	22	2
5	16QAM	12	7	21.90	21.82	21.86		
5	16QAM	12	13	21.86	21.80	21.83		
5	16QAM	25	0	21.92	21.84	21.91		
5	64QAM	1	0	21.64	21.56	21.56	22	2
5	64QAM	1	12	21.78	21.70	21.69		
5	64QAM	1	24	21.67	21.62	21.67		
5	64QAM	12	0	20.85	20.78	20.79	21	3
5	64QAM	12	7	20.83	20.81	20.84		
5	64QAM	12	13	20.86	20.79	20.78		
5	64QAM	25	0	20.91	20.80	20.86		



<WWAN Top Antenna --Reduced Power for Receiver On/Hotspot On>

<LTE Band 38>

BW [MHz]	Modulation	RB Size	RB Offset	Power Low Ch. / Freq.	Power Middle Ch. / Freq.	Power High Ch. / Freq.	Tune-up limit (dBm)	MPR (dB)
Channel				37850	38000	38150		
Frequency (MHz)				2580	2595	2610		
20	QPSK	1	0	20.84	21.00	21.18	21.5	0
20	QPSK	1	49	21.00	20.95	21.02		
20	QPSK	1	99	20.91	20.93	20.98		
20	QPSK	50	0	21.01	20.95	21.13	21.5	0
20	QPSK	50	24	21.10	21.05	21.12		
20	QPSK	50	50	21.03	21.04	21.10		
20	QPSK	100	0	20.92	20.92	20.98		
20	16QAM	1	0	21.00	20.86	20.87	21.5	0
20	16QAM	1	49	21.11	21.06	21.10		
20	16QAM	1	99	21.01	20.99	21.04		
20	16QAM	50	0	21.06	21.01	21.08	21.5	0
20	16QAM	50	24	21.16	21.10	21.17		
20	16QAM	50	50	21.11	21.09	21.15		
20	16QAM	100	0	20.97	20.98	21.03		
20	64QAM	1	0	20.74	20.61	20.63	21.5	0
20	64QAM	1	49	20.85	20.81	20.83		
20	64QAM	1	99	20.73	20.75	20.86		
20	64QAM	50	0	20.38	20.34	20.40	21	0.5
20	64QAM	50	24	20.49	20.44	20.50		
20	64QAM	50	50	20.43	20.41	20.47		
20	64QAM	100	0	20.42	20.43	20.49		



Channel				37825	38000	38175	Tune-up limit (dBm)	MPR (dB)
Frequency (MHz)				2577.5	2595	2612.5		
15	QPSK	1	0	20.99	20.89	20.90	21.5	0
15	QPSK	1	37	21.00	20.95	20.99		
15	QPSK	1	74	20.96	21.00	21.01		
15	QPSK	36	0	20.90	20.84	20.90	21.5	0
15	QPSK	36	20	20.96	20.90	20.98		
15	QPSK	36	39	20.96	20.88	20.97		
15	QPSK	75	0	21.02	20.98	21.01	21.5	0
15	16QAM	1	0	21.05	20.98	20.95		
15	16QAM	1	37	21.08	21.03	21.08		
15	16QAM	1	74	21.10	21.07	21.14	21.5	0
15	16QAM	36	0	20.92	20.84	20.92		
15	16QAM	36	20	20.98	20.94	21.01		
15	16QAM	36	39	20.94	20.90	20.99	21.5	0
15	16QAM	75	0	21.08	21.01	21.07		
15	64QAM	1	0	20.83	20.68	20.72		
15	64QAM	1	37	20.83	20.79	20.83	21.5	0
15	64QAM	1	74	20.82	20.77	20.85		
15	64QAM	36	0	20.39	20.31	20.37		
15	64QAM	36	20	20.43	20.37	20.44	21	0.5
15	64QAM	36	39	20.39	20.37	20.44		
15	64QAM	75	0	20.48	20.43	20.47		
Channel				37800	38000	38200	Tune-up limit (dBm)	MPR (dB)
Frequency (MHz)				2575	2595	2615		
10	QPSK	1	0	20.96	20.96	20.85	21.5	0
10	QPSK	1	25	21.01	21.01	21.00		
10	QPSK	1	49	20.91	20.91	21.03		
10	QPSK	25	0	20.97	20.97	20.96	21.5	0
10	QPSK	25	12	21.00	21.00	21.00		
10	QPSK	25	25	20.97	20.97	20.97		
10	QPSK	50	0	21.05	21.05	21.09	21.5	0
10	16QAM	1	0	21.02	21.02	21.02		
10	16QAM	1	25	21.12	21.12	21.12		
10	16QAM	1	49	21.08	21.08	21.08	21.5	0
10	16QAM	25	0	21.04	21.04	21.03		
10	16QAM	25	12	21.07	21.07	21.07		
10	16QAM	25	25	21.03	21.03	21.04	21.5	0
10	16QAM	50	0	21.11	21.11	21.14		
10	64QAM	1	0	20.75	20.75	20.73		
10	64QAM	1	25	20.85	20.85	20.83	21.5	0
10	64QAM	1	49	20.73	20.73	20.80		
10	64QAM	25	0	20.38	20.38	20.37		
10	64QAM	25	12	20.41	20.41	20.43	21	0.5
10	64QAM	25	25	20.41	20.41	20.41		
10	64QAM	50	0	20.42	20.42	20.49		



Channel				37775	38000	38225	Tune-up limit (dBm)	MPR (dB)
Frequency (MHz)				2572.5	2595	2617.5		
5	QPSK	1	0	20.88	20.84	20.90	21.5	0
5	QPSK	1	12	20.97	20.89	20.98		
5	QPSK	1	24	20.85	20.83	20.92		
5	QPSK	12	0	20.98	20.83	20.96	21.5	0
5	QPSK	12	7	21.03	20.90	21.01		
5	QPSK	12	13	20.96	20.89	21.00		
5	QPSK	25	0	21.00	20.91	20.97		
5	16QAM	1	0	21.07	20.90	20.99	21.5	0
5	16QAM	1	12	21.09	21.03	21.10		
5	16QAM	1	24	21.00	21.02	21.11		
5	16QAM	12	0	21.00	20.88	20.97	21.5	0
5	16QAM	12	7	21.03	20.90	21.04		
5	16QAM	12	13	20.97	20.91	20.99		
5	16QAM	25	0	21.09	21.00	21.08		
5	64QAM	1	0	20.79	20.66	20.73	21.5	0
5	64QAM	1	12	20.82	20.75	20.82		
5	64QAM	1	24	20.80	20.70	20.83		
5	64QAM	12	0	20.36	20.26	20.34	21	0.5
5	64QAM	12	7	20.42	20.30	20.42		
5	64QAM	12	13	20.37	20.29	20.39		
5	64QAM	25	0	20.44	20.35	20.40		

<LTE Carrier Aggregation>

General Note:

1. This device supports Carrier Aggregation on downlink for CA_7C /CA_38C and uplink for CA_7C/ CA_38C. For the device supports bands and bandwidths and configurations are provided as follow table was according to 3GPP.
2. In applying the existing power measurement procedures of KDB 941225 D05A for DL CA SAR test exclusion, only the subset with the largest number of combinations of frequency bands and CCs in each row need combination, and for this device that all the configurations were choose to power measurement.
3. All permutations exist. No restrictions on Pcell & Scell combinations.

Index	2CC	Restriction	Completely Covered by Measurement Superset
2CC #1	CA_7C		No
2CC #2	CA_38C		No

LTE Carrier Aggregation Conducted Power (Downlink)

General Note:

- i. According to KDB941225 D05A v01r02, uplink maximum output power measurement with downlink carrier aggregation active should be measured, using the highest output channel measured without downlink carrier aggregation, to confirm that uplink maximum output power with downlink carrier aggregation active remains within the specified tune-up tolerance limits and not more than ¼ dB higher than the maximum output measured without downlink carrier aggregation active.
- ii. Uplink maximum output power with downlink carrier aggregation active does not show more than ¼ dB higher than the maximum output power without downlink carrier aggregation active, therefore SAR evaluation with downlink carrier aggregation active can be excluded.
- iii. For power measurement were control and acknowledge data is sent on uplink channels that operate identical to specifications when downlink carrier aggregation is inactive.
- iv. Selected highest measured power when downlink carrier aggregation is inactive for conducted power comparison with downlink carrier aggregation is active, to confirm that when downlink carrier aggregation is active uplink maximum output power remains within the specified tune-up tolerance limits and not more than ¼ dB higher than the maximum output power measured when downlink carrier aggregation inactive.
- v. For Intra-band, contiguous CA, the downlink channels selected to perform the uplink power measurement must satisfy 3GPP channel spacing (5.4.1A of 3GPP TS 36.521 or equivalent) and channel bandwidth (5.4.2A) requirements.

$$\text{Nominal channel spacing} = \left\lceil \frac{BW_{\text{Channel}(1)} + BW_{\text{Channel}(2)} - 0.1|BW_{\text{Channel}(1)} - BW_{\text{Channel}(2)}|}{0.6} \right\rceil 0.3 \text{ [MHz]}$$

<WWAN Top/Bottom Antenna--Full Power Mode>

<Two Carrier power verification>

Configure		CA Configuration (BCS)	PCC						SCC				Power		
			LTE Band	BW (MHz)	UL Freq. (MHz)	UL Channel	Mod.	UL# RB	UL RB Offset	LTE Band	BW (MHz)	DL Freq. (MHz)	DL Channel	With CA Tx. Power (dBm)	Without CA Tx. Power (dBm)
Intra-Band	Contiguous	CA_7C	Band 7	20M	2560	21350	QPSK	1	49	Band 7	20M	2660.2	3152	23.75	23.82
		CA_38C	Band 38	20M	2585.1	37901	QPSK	1	0	Band 38	20M	2604.9	38099	23.81	23.95

<WWAN Top Antenna --Reduced Power for Receiver On/Hotspot On>

<Two Carrier power verification>

Configure		CA Configuration (BCS)	PCC						SCC				Power		
			LTE Band	BW (MHz)	UL Freq. (MHz)	UL Channel	Mod.	UL# RB	UL RB Offset	LTE Band	BW (MHz)	DL Freq. (MHz)	DL Channel	With CA Tx. Power (dBm)	Without CA Tx. Power (dBm)
Intra-Band	Contiguous	CA_7C	Band 7	20M	2560	21350	QPSK	1	0	Band 7	20M	2660.2	3152	18.38	18.46
		CA_38C	Band 38	20M	2610	38150	QPSK	1	0	Band 38	20M	2590.2	37952	21.00	21.18

<WWAN Bottom Antenna --Reduced Power for Hotspot On>

<Two Carrier power verification>

Configure		CA Configuration (BCS)	PCC						SCC				Power		
			LTE Band	BW (MHz)	UL Freq. (MHz)	UL Channel	Mod.	UL# RB	UL RB Offset	LTE Band	BW (MHz)	DL Freq. (MHz)	DL Channel	With CA Tx. Power (dBm)	Without CA Tx. Power (dBm)
Intra-Band	Contiguous	CA_7C	Band 7	20M	2560	21350	QPSK	1	49	Band 7	20M	2660.2	3152	23.23	23.45

LTE Carrier Aggregation Conducted Power (Uplink)

1. This device supports uplink carrier aggregation for LTE CA_7C, CA_38C with a maximum of two 20MHz component carriers. For intra band contiguous carrier aggregation scenarios, 3GPP 36.101 Table 6.2.2A-1 specifies that the aggregate maximum allowed output power is equivalent to the single carrier scenario. For the non-contiguously allocated resource blocks which the MPR level is determined by various RB separation and RB sizes requirement, and the allowed MPR levels, settings and the conducted powers are permanently implemented in this device per the 3GPP 36.36.101 section 6.2.3A.1.3 requirements.
2. According to November 2017 TCB workshop, the output power with uplink CA active was measured for the high / middle / low channel configuration with the highest reported SAR for each exposure condition, the power was measured with wideband signal integration over both component carriers.
3. In applying the power measurement procedures of KDB 941225 D05A for DL CA to qualify for UL SAR test exclusion, power measurement is required only for the subset in each row with the largest combination of frequency bands and CCs
4. Maximum output power measurement is required for each UL CA configuration for the required test channels described in KDB 941225 D05. The required test channel should be associated with the UL PCC. For channels at the ends of a frequency band, the SCC and subsequent CCs are added to the side within the transmission band. Otherwise, the CCs should be added alternatively to either side of the PCC.

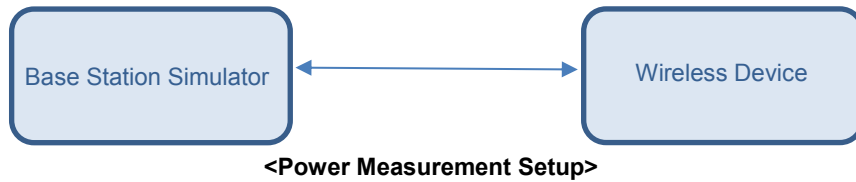



<WWAN Top/Bottom Antenna--Full Power Mode>

<LTE Band 7>

CA_7C										
Combination 20MHz+20MHz (100RB+100RB)										
PCC Channel	SCC Channel	Modulation	PCC		SCC		Total RB Size	Target MPR Level (dB)	Measured Power (dBm)	Tune up Power (dBm)
			RB Size	RB offset	RB Size	RB offset				
20850	21048	QPSK	1	49	0	0	1	0	23.08	24.00
21100	20902	QPSK	1	49	0	0	2	0	23.71	24.00
21350	21152	QPSK	1	49	0	0	2	0	23.69	24.00

<LTE Band 38>

CA_38C										
Combination 20MHz+20MHz (100RB+100RB)										
PCC Channel	SCC Channel	Modulation	PCC		SCC		Total RB Size	Target MPR Level (dB)	Measured Power (dBm)	Tune up Power (dBm)
			RB Size	RB offset	RB Size	RB offset				
37850	38048	QPSK	1	0	0	0	1	0	23.3	24.00
37901	38099	QPSK	1	0	0	0	1	0	23.58	24.00
38150	37952	QPSK	1	0	0	0	2	0	23.86	24.00

<WWAN Top Antenna --Reduced Power for Receiver On/Hotspot On>

<LTE Band 7>

CA_7C										
Combination 20MHz+20MHz (100RB+100RB)										
PCC Channel	SCC Channel	Modulation	PCC		SCC		Total RB Size	Target MPR Level (dB)	Measured Power (dBm)	Tune up Power (dBm)
			RB Size	RB offset	RB Size	RB offset				
20850	21048	QPSK	1	0	0	0	1	0	18.32	18.50
21100	20902	QPSK	1	0	0	0	2	0	18.21	18.50
21350	21152	QPSK	1	0	0	0	2	0	18.42	18.50

<LTE Band 38>

CA_38C										
Combination 20MHz+20MHz (100RB+100RB)										
PCC Channel	SCC Channel	Modulation	PCC		SCC		Total RB Size	Target MPR Level (dB)	Measured Power (dBm)	Tune up Power (dBm)
			RB Size	RB offset	RB Size	RB offset				
37850	38048	QPSK	50	0	0	0	1	0	20.88	21.50
37901	38099	QPSK	50	0	0	0	1	0	21.01	21.50
38150	37952	QPSK	50	0	0	0	1	0	21.09	21.50



<WWAN Bottom Antenna --Reduced Power for Hotspot On>

<LTE Band 7>

CA_7C										
Combination 20MHz+20MHz (100RB+100RB)										
PCC Channel	SCC Channel	Modulation	PCC		SCC		Total RB Size	Target MPR Level (dB)	Measured Power (dBm)	Tune up Power (dBm)
			RB Size	RB offset	RB Size	RB offset				
20850	21048	QPSK	1	49	0	0	1	0	23.12	23.50
21100	20902	QPSK	1	49	0	0	1	0	23.01	23.50
21350	21152	QPSK	1	49	0	0	1	0	23.28	23.50

<WLAN Conducted Power>

General Note:

1. Per KDB 248227 D01v02r02, SAR test reduction is determined according to 802.11 transmission mode configurations and certain exposure conditions with multiple test positions. In the 2.4 GHz band, separate SAR procedures are applied to DSSS and OFDM configurations to simplify DSSS test requirements. For OFDM, in both 2.4 and 5 GHz bands, an initial test configuration must be determined for each standalone and aggregated frequency band, according to the transmission mode configuration with the highest maximum output power specified for production units to perform SAR measurements. If the same highest maximum output power applies to different combinations of channel bandwidths, modulations and data rates, additional procedures are applied to determine which test configurations require SAR measurement. When applicable, an initial test position may be applied to reduce the number of SAR measurements required for next to the ear, UMPC mini-tablet or hotspot mode configurations with multiple test positions.
2. For 2.4 GHz 802.11b DSSS, either the initial test position procedure for multiple exposure test positions or the DSSS procedure for fixed exposure position is applied; these are mutually exclusive. For 2.4 GHz and 5 GHz OFDM configurations, the initial test configuration is applied to measure SAR using either the initial test position procedure for multiple exposure test position configurations or the initial test configuration procedures for fixed exposure test conditions. Based on the reported SAR of the measured configurations and maximum output power of the transmission mode configurations that are not included in the initial test configuration, the subsequent test configuration and initial test position procedures are applied to determine if SAR measurements are required for the remaining OFDM transmission configurations. In general, the number of test channels that require SAR measurement is minimized based on maximum output power measured for the test sample(s).
3. For OFDM transmission configurations in the 2.4 GHz and 5 GHz bands, When the same maximum power is specified for multiple transmission modes in a frequency band, the largest channel bandwidth, lowest order modulation, lowest data rate and lowest order 802.11a/g/n/ac mode is used for SAR measurement, on the highest measured output power channel for each frequency band.
4. DSSS and OFDM configurations are considered separately according to the required SAR procedures. SAR is measured in the initial test position using the 802.11 transmission mode configuration required by the DSSS procedure or initial test configuration and subsequent test configuration(s) according to the OFDM procedures.18 The initial test position procedure is described in the following:
 - a. When the reported SAR of the initial test position is ≤ 0.4 W/kg, further SAR measurement is not required for the other test positions in that exposure configuration and 802.11 transmission mode combinations within the frequency band or aggregated band.
 - b. When the reported SAR of the test position is > 0.4 W/kg, SAR is repeated for the 802.11 transmission mode configuration tested in the initial test position to measure the subsequent next closet/smallest test separation distance and maximum coupling test position on the highest maximum output power channel, until the report SAR is ≤ 0.8 W/kg or all required test position are tested.
 - c. For all positions/configurations, when the reported SAR is > 0.8 W/kg, SAR is measured for these test positions/configurations on the subsequent next highest measured output power channel(s) until the reported SAR is ≤ 1.2 W/kg or all required channels are tested.



<Full Power>

<2.4GHz WLAN Ant.1>

	Mode	Channel	Frequency (MHz)	Average power (dBm)	Tune-Up Limit	Duty Cycle %
2.4GHz WLAN	802.11b 1Mbps	1	2412	14.20	15.00	99.05
		6	2437	14.90	15.00	
		11	2462	16.50	17.00	
	802.11g 6Mbps	1	2412	14.10	15.00	96.54
		6	2437	16.10	16.50	
		11	2462	14.50	15.00	
	802.11n-HT20 MCS0	1	2412	13.40	14.00	96.68
		6	2437	15.00	15.50	
		11	2462	13.70	14.00	

<2.4GHz WLAN Ant.2>

	Mode	Channel	Frequency (MHz)	Average power (dBm)	Tune-Up Limit	Duty Cycle %
2.4GHz WLAN	802.11b 1Mbps	1	2412	13.80	15.00	98.93
		6	2437	14.40	15.00	
		11	2462	16.20	17.00	
	802.11g 6Mbps	1	2412	13.90	15.00	96.55
		6	2437	15.30	16.50	
		11	2462	14.20	15.00	
	802.11n-HT20 MCS0	1	2412	13.20	14.00	96.68
		6	2437	14.20	15.50	
		11	2462	13.50	14.00	



<5GHz WLAN Ant.1>

5.2GHz WLAN	Mode	Channel	Frequency (MHz)	Average power (dBm)	Tune-Up Limit	Duty Cycle %
	802.11a 6Mbps	36	5180	16.29	17.00	96.19
		40	5200	16.16	17.00	
		44	5220	16.09	17.00	
		48	5240	16.18	17.00	
	802.11n-HT20 MCS0	36	5180	16.38	16.50	95.94
		40	5200	16.30	16.50	
		44	5220	16.25	16.50	
		48	5240	16.19	16.50	
	802.11n-HT40 MCS0	38	5190	12.40	13.50	93.06
46		5230	14.71	15.50		
802.11ac-VHT20 MCS0	36	5180	15.92	16.50	96.70	
	40	5200	15.78	16.50		
	44	5220	15.72	16.50		
	48	5240	15.95	16.50		
802.11ac-VHT40 MCS0	38	5190	12.00	13.50	93.14	
	46	5230	14.80	15.50		
802.11ac-VHT80 MCS0	42	5210	10.60	12.50	88.08	

5.3GHz WLAN	Mode	Channel	Frequency (MHz)	Average power (dBm)	Tune-Up Limit	Duty Cycle %
	802.11a 6Mbps	52	5260	16.22	17.00	96.19
		56	5280	16.27	17.00	
		60	5300	16.24	17.00	
		64	5320	16.17	17.00	
	802.11n-HT20 MCS0	52	5260	16.36	16.50	95.94
		56	5280	16.29	16.50	
		60	5300	16.28	16.50	
		64	5320	16.30	16.50	
	802.11n-HT40 MCS0	54	5270	14.87	15.50	93.06
		62	5310	12.40	15.50	
	802.11ac-VHT20 MCS0	52	5260	15.97	16.50	96.70
		56	5280	15.90	16.50	
		60	5300	15.83	16.50	
		64	5320	15.76	16.50	
	802.11ac-VHT40 MCS0	54	5270	14.95	15.50	93.14
62		5310	12.30	13.50		
802.11ac-VHT80 MCS0	58	5290	11.20	12.00	88.08	



5.5GHz WLAN	Mode	Channel	Frequency (MHz)	Average power (dBm)	Tune-Up Limit	=Duty Cycle %
	802.11a 6Mbps	100	5500	15.84	16.50	96.19
		116	5580	15.62	16.50	
		124	5620	15.64	16.50	
		132	5660	15.89	16.50	
		140	5700	13.60	14.50	
	802.11n-HT20 MCS0	100	5500	13.40	14.50	95.94
		116	5580	15.78	16.50	
		124	5620	15.89	16.50	
		132	5660	15.85	16.50	
140		5700	13.00	14.00		
802.11n-HT40 MCS0	102	5510	11.60	12.50	93.06	
	110	5550	14.43	15.50		
	126	5630	14.40	15.50		
	134	5670	14.55	15.50		
802.11ac-VHT20 MCS0	100	5500	13.10	14.50	96.70	
	116	5580	15.45	16.50		
	124	5620	15.50	16.50		
	132	5660	15.64	16.50		
	140	5700	12.60	14.00		
802.11ac-VHT40 MCS0	102	5510	11.40	12.50	93.14	
	110	5550	14.66	15.50		
	126	5630	14.51	15.50		
	134	5670	14.71	15.50		
802.11ac-VHT80 MCS0	106	5530	11.20	12.50	88.08	
	122	5610	13.90	14.50		

5.8GHz WLAN	Mode	Channel	Frequency (MHz)	Average power (dBm)	Tune-Up Limit	Duty Cycle %
	802.11a MCS0	149	5745	13.00	13.50	96.19
		157	5785	12.50	13.50	
		161	5805	12.50	13.50	
	802.11n-HT20 MCS0	149	5745	12.90	13.50	95.94
		157	5785	12.60	13.50	
		161	5805	12.30	13.50	
	802.11n-HT40 MCS0	151	5755	11.50	13.00	93.06
		159	5795	11.60	13.00	
	802.11ac-VHT20 MCS0	149	5745	12.80	13.50	96.70
157		5785	12.50	13.50		
161		5805	12.20	13.50		
802.11ac-VHT40 MCS0	151	5755	11.40	13.00	93.14	
	159	5795	11.50	13.00		
802.11ac-VHT80 MCS0	155	5775	10.80	12.00	88.08	



<5GHz WLAN Ant.2>

	Mode	Channel	Frequency (MHz)	Average power (dBm)	Tune-Up Limit	Duty Cycle %
5.2GHz WLAN	802.11a 6Mbps	36	5180	12.78	14.00	96.89
		40	5200	12.62	14.00	
		44	5220	12.65	14.00	
		48	5240	12.95	14.00	
	802.11n-HT20 MCS0	36	5180	12.65	13.50	96.67
		40	5200	12.52	13.50	
		44	5220	12.55	13.50	
		48	5240	12.80	13.50	
	802.11n-HT40 MCS0	38	5190	11.69	12.50	93.10
		46	5230	11.80	12.50	
	802.11ac-VHT20 MCS0	36	5180	12.63	13.50	96.70
		40	5200	12.49	13.50	
		44	5220	12.56	13.50	
		48	5240	12.79	13.50	
802.11ac-VHT40 MCS0	38	5190	11.75	12.50	93.17	
	46	5230	11.84	12.50		
802.11ac-VHT80 MCS0	42	5210	11.10	12.50	87.50	

	Mode	Channel	Frequency (MHz)	Average power (dBm)	Tune-Up Limit	Duty Cycle %
5.3GHz WLAN	802.11a 6Mbps	52	5260	12.92	14.00	96.89
		56	5280	12.69	14.00	
		60	5300	12.54	14.00	
		64	5320	12.77	14.00	
	802.11n-HT20 MCS0	52	5260	12.78	13.50	96.67
		56	5280	12.52	13.50	
		60	5300	12.40	13.50	
		64	5320	12.66	13.50	
	802.11n-HT40 MCS0	54	5270	11.90	12.50	93.10
		62	5310	11.63	12.50	
	802.11ac-VHT20 MCS0	52	5260	12.74	13.50	96.70
		56	5280	12.61	13.50	
		60	5300	12.48	13.50	
		64	5320	12.73	13.50	
802.11ac-VHT40 MCS0	54	5270	11.91	12.50	93.17	
	62	5310	11.64	12.50		
802.11ac-VHT80 MCS0	58	5290	11.27	12.00	87.50	



5.5GHz WLAN	Mode	Channel	Frequency (MHz)	Average power (dBm)	Tune-Up Limit	Duty Cycle %
	802.11a 6Mbps	100	5500	12.84	14.00	96.89
		116	5580	12.75	14.00	
		124	5620	12.71	14.00	
		132	5660	12.23	14.00	
		140	5700	12.42	14.00	
	802.11n-HT20 MCS0	100	5500	12.76	14.00	96.67
		116	5580	12.56	14.00	
		124	5620	12.49	14.00	
		132	5660	12.17	14.00	
140		5700	12.26	14.00		
802.11n-HT40 MCS0	102	5510	11.83	13.00	93.10	
	110	5550	11.72	13.00		
	126	5630	11.68	13.00		
	134	5670	11.30	13.00		
802.11ac-VHT20 MCS0	100	5500	12.70	14.00	96.70	
	116	5580	12.64	14.00		
	124	5620	12.57	14.00		
	132	5660	12.12	14.00		
	140	5700	12.15	14.00		
802.11ac-VHT40 MCS0	102	5510	11.85	13.00	93.17	
	110	5550	11.77	13.00		
	126	5630	11.81	13.00		
	134	5670	11.32	13.00		
802.11ac-VHT80 MCS0	106	5530	11.06	12.00	87.50	
	122	5610	10.99	12.00		

5.8GHz WLAN	Mode	Channel	Frequency (MHz)	Average power (dBm)	Tune-Up Limit	Duty Cycle %
	802.11a MCS0	149	5745	12.07	13.50	96.89
		157	5785	12.02	13.50	
		161	5805	11.86	13.50	
	802.11n-HT20 MCS0	149	5745	11.95	13.50	96.67
		157	5785	11.99	13.50	
		161	5805	11.83	13.50	
	802.11n-HT40 MCS0	151	5755	11.12	13.00	93.10
		159	5795	11.16	13.00	
	802.11ac-VHT20 MCS0	149	5745	11.92	13.50	96.70
157		5785	11.93	13.50		
161		5805	11.72	13.50		
802.11ac-VHT40 MCS0	151	5755	11.22	13.00	93.17	
	159	5795	11.16	13.00		
802.11ac-VHT80 MCS0	155	5775	10.48	12.00	87.50	



<Reduced Power for transmitting simultaneously with WWAN/Bluetooth>

<2.4GHz WLAN Ant.1>

	Mode	Channel	Frequency (MHz)	Average power (dBm)	Tune-Up Limit	Duty Cycle %
2.4GHz WLAN	802.11b 1Mbps	1	2412	13.93	15.00	99.05
		6	2437	14.21	15.00	
		11	2462	13.89	15.00	
	802.11g 6Mbps	1	2412	14.10	15.00	96.54
		6	2437	13.88	15.00	
		11	2462	14.50	15.00	
	802.11n-HT20 MCS0	1	2412	13.40	14.00	96.68
		6	2437	14.19	15.00	
		11	2462	13.70	14.00	

<2.4GHz WLAN Ant.2>

	Mode	Channel	Frequency (MHz)	Average power (dBm)	Tune-Up Limit	Duty Cycle %
2.4GHz WLAN	802.11b 1Mbps	1	2412	13.80	15.00	98.93
		6	2437	14.40	15.00	
		11	2462	14.22	15.00	
	802.11g 6Mbps	1	2412	13.90	15.00	96.55
		6	2437	14.40	15.00	
		11	2462	14.20	15.00	
	802.11n-HT20 MCS0	1	2412	13.20	14.00	96.68
		6	2437	14.20	15.00	
		11	2462	13.50	14.00	



<5GHz WLAN Ant.1>

5.2GHz WLAN	Mode	Channel	Frequency (MHz)	Average power (dBm)	Tune-Up Limit	Duty Cycle %
	802.11a 6Mbps	36	5180	13.20	14.50	96.19
		40	5200	13.02	14.50	
		44	5220	13.00	14.50	
		48	5240	13.04	14.50	
	802.11n-HT20 MCS0	36	5180	12.36	14.00	95.94
		40	5200	12.41	14.00	
		44	5220	12.46	14.00	
		48	5240	12.43	14.00	
	802.11n-HT40 MCS0	38	5190	12.40	13.50	93.06
46		5230	12.37	14.00		
802.11ac-VHT20 MCS0	36	5180	12.29	14.00	96.70	
	40	5200	12.35	14.00		
	44	5220	12.37	14.00		
	48	5240	12.28	14.00		
802.11ac-VHT40 MCS0	38	5190	12.00	13.00	93.14	
	46	5230	12.48	14.00		
802.11ac-VHT80 MCS0	42	5210	10.60	12.50	88.08	

5.3GHz WLAN	Mode	Channel	Frequency (MHz)	Average power (dBm)	Tune-Up Limit	Duty Cycle %
	802.11a 6Mbps	52	5260	13.05	14.50	96.19
		56	5280	13.11	14.50	
		60	5300	13.07	14.50	
		64	5320	13.02	14.50	
	802.11n-HT20 MCS0	52	5260	12.46	14.00	95.94
		56	5280	12.25	14.00	
		60	5300	12.32	14.00	
		64	5320	12.37	14.00	
	802.11n-HT40 MCS0	54	5270	12.21	14.00	93.06
		62	5310	12.31	14.00	
	802.11ac-VHT20 MCS0	52	5260	12.21	14.00	96.70
		56	5280	12.15	14.00	
		60	5300	12.28	14.00	
64		5320	12.33	14.00		
802.11ac-VHT40 MCS0	54	5270	12.31	14.00	93.14	
	62	5310	12.30	13.50		
802.11ac-VHT80 MCS0	58	5290	11.20	12.00	88.08	



	Mode	Channel	Frequency (MHz)	Average power (dBm)	Tune-Up Limit	Duty Cycle %
5.5GHz WLAN	802.11a 6Mbps	100	5500	13.45	14.50	96.19
		116	5580	13.44	14.50	
		124	5620	13.45	14.50	
		132	5660	13.48	14.50	
		140	5700	13.46	14.50	
	802.11n-HT20 MCS0	100	5500	12.38	14.00	95.94
		116	5580	12.17	14.00	
		124	5620	12.32	14.00	
		132	5660	12.29	14.00	
		140	5700	12.20	14.00	
	802.11n-HT40 MCS0	102	5510	11.60	12.50	93.06
		110	5550	12.32	14.00	
		126	5630	12.26	14.00	
		134	5670	12.11	14.00	
	802.11ac-VHT20 MCS0	100	5500	12.36	14.00	96.70
		116	5580	12.13	14.00	
		124	5620	12.28	14.00	
		132	5660	12.21	14.00	
		140	5700	12.03	14.00	
	802.11ac-VHT40 MCS0	102	5510	11.40	12.50	93.14
		110	5550	12.39	14.00	
		126	5630	12.33	14.00	
		134	5670	12.25	14.00	
	802.11ac-VHT80 MCS0	106	5530	11.20	12.50	88.08
122		5610	12.17	14.00		



<5GHz WLAN Ant.2>

5.2GHz WLAN	Mode	Channel	Frequency (MHz)	Average power (dBm)	Tune-Up Limit	Duty Cycle %
	802.11a 6Mbps	36	5180	10.34	11.50	96.89
		40	5200	10.31	11.50	
		44	5220	10.15	11.50	
		48	5240	10.28	11.50	
	802.11n-HT20 MCS0	36	5180	10.29	11.00	96.67
		40	5200	10.22	11.00	
		44	5220	10.16	11.00	
		48	5240	10.25	11.00	
	802.11n-HT40 MCS0	38	5190	10.69	11.00	93.10
46		5230	10.78	11.00		
802.11ac-VHT20 MCS0	36	5180	10.26	11.00	96.70	
	40	5200	10.17	11.00		
	44	5220	10.13	11.00		
	48	5240	10.22	11.00		
802.11ac-VHT40 MCS0	38	5190	10.77	11.00	93.17	
	46	5230	10.71	11.00		
802.11ac-VHT80 MCS0	42	5210	10.85	11.00	87.50	

5.3GHz WLAN	Mode	Channel	Frequency (MHz)	Average power (dBm)	Tune-Up Limit	Duty Cycle %
	802.11a 6Mbps	52	5260	10.53	11.50	96.89
		56	5280	10.39	11.50	
		60	5300	10.29	11.50	
		64	5320	10.31	11.50	
	802.11n-HT20 MCS0	52	5260	10.49	11.00	96.67
		56	5280	10.32	11.00	
		60	5300	10.23	11.00	
		64	5320	10.26	11.00	
	802.11n-HT40 MCS0	54	5270	10.39	11.00	93.10
62		5310	10.15	11.00		
802.11ac-VHT20 MCS0	52	5260	10.40	11.00	96.70	
	56	5280	10.33	11.00		
	60	5300	10.26	11.00		
	64	5320	10.18	11.00		
802.11ac-VHT40 MCS0	54	5270	10.39	11.00	93.17	
	62	5310	10.22	11.00		
802.11ac-VHT80 MCS0	58	5290	10.88	11.00	87.50	



	Mode	Channel	Frequency (MHz)	Average power (dBm)	Tune-Up Limit	Duty Cycle %
5.5GHz WLAN	802.11a 6Mbps	100	5500	11.21	12.00	96.89
		116	5580	10.88	12.00	
		124	5620	11.02	12.00	
		132	5660	10.70	12.00	
		140	5700	10.81	12.00	
	802.11n-HT20 MCS0	100	5500	10.92	11.50	96.67
		116	5580	10.87	11.50	
		124	5620	10.79	11.50	
		132	5660	10.55	11.50	
		140	5700	10.69	11.50	
	802.11n-HT40 MCS0	102	5510	10.64	11.50	93.10
		110	5550	10.36	11.50	
		126	5630	10.28	11.50	
		134	5670	10.03	11.50	
	802.11ac-VHT20 MCS0	100	5500	10.92	11.50	96.70
		116	5580	10.86	11.50	
		124	5620	10.90	11.50	
		132	5660	10.53	11.50	
		140	5700	10.63	11.50	
	802.11ac-VHT40 MCS0	102	5510	10.65	11.50	93.17
		110	5550	10.42	11.50	
		126	5630	10.33	11.50	
		134	5670	10.03	11.50	
	802.11ac-VHT80 MCS0	106	5530	10.42	11.50	87.50
122		5610	10.37	11.50		

<Reduced Power for Hotspot On >

<2.4GHz WLAN Ant.1>

	Mode	Channel	Frequency (MHz)	Average power (dBm)	Tune-Up Limit	Duty Cycle %
2.4GHz WLAN	802.11b 1Mbps	1	2412	13.93	15.00	99.05
		6	2437	14.21	15.00	
		11	2462	13.89	15.00	
	802.11g 6Mbps	1	2412	14.10	15.00	96.54
		6	2437	13.88	15.00	
		11	2462	14.50	15.00	
	802.11n-HT20 MCS0	1	2412	13.40	14.00	96.68
		6	2437	14.19	15.00	
		11	2462	13.70	14.00	

<2.4GHz WLAN Ant.2>

	Mode	Channel	Frequency (MHz)	Average power (dBm)	Tune-Up Limit	Duty Cycle %
2.4GHz WLAN	802.11b 1Mbps	1	2412	13.80	15.00	98.93
		6	2437	14.40	15.00	
		11	2462	14.22	15.00	
	802.11g 6Mbps	1	2412	13.90	15.00	96.55
		6	2437	14.40	15.00	
		11	2462	14.20	15.00	
	802.11n-HT20 MCS0	1	2412	13.20	14.00	96.68
		6	2437	14.20	15.00	
		11	2462	13.50	14.00	



<5GHz WLAN Ant.1>

	Mode	Channel	Frequency (MHz)	Average power (dBm)	Tune-Up Limit	Duty Cycle %
5.2GHz WLAN	802.11a 6Mbps	36	5180	13.20	14.50	96.19
		40	5200	13.02	14.50	
		44	5220	13.00	14.50	
		48	5240	13.04	14.50	
	802.11n-HT20 MCS0	36	5180	12.36	14.00	95.94
		40	5200	12.41	14.00	
		44	5220	12.46	14.00	
		48	5240	12.43	14.00	
	802.11n-HT40 MCS0	38	5190	12.40	13.50	93.06
		46	5230	12.37	14.00	
	802.11ac-VHT20 MCS0	36	5180	12.29	14.00	96.70
		40	5200	12.35	14.00	
		44	5220	12.37	14.00	
		48	5240	12.28	14.00	
	802.11ac-VHT40 MCS0	38	5190	12.00	13.00	93.14
		46	5230	12.48	14.00	
802.11ac-VHT80 MCS0	42	5210	10.60	12.50	88.08	

<5GHz WLAN Ant.2>

	Mode	Channel	Frequency (MHz)	Average power (dBm)	Tune-Up Limit	Duty Cycle %
5.2GHz WLAN	802.11a 6Mbps	36	5180	10.34	11.50	96.89
		40	5200	10.31	11.50	
		44	5220	10.15	11.50	
		48	5240	10.28	11.50	
	802.11n-HT20 MCS0	36	5180	10.29	11.00	96.67
		40	5200	10.22	11.00	
		44	5220	10.16	11.00	
		48	5240	10.25	11.00	
	802.11n-HT40 MCS0	38	5190	10.69	11.00	93.10
		46	5230	10.78	11.00	
	802.11ac-VHT20 MCS0	36	5180	10.26	11.00	96.70
		40	5200	10.17	11.00	
		44	5220	10.13	11.00	
		48	5240	10.22	11.00	
	802.11ac-VHT40 MCS0	38	5190	10.77	11.00	93.17
		46	5230	10.71	11.00	
802.11ac-VHT80 MCS0	42	5210	10.85	11.00	87.50	

<2.4GHz Bluetooth>

General Note:

1. For 2.4GHz Bluetooth SAR testing was selected 1Mbps, due to its highest average power.
2. The Bluetooth duty cycle are 77.13 % for Antenna1 and 76.60 % for Antenna2 as following figure, according to 2016 Oct. TCB workshop for Bluetooth SAR scaling need further consideration and the theoretical duty cycle is 83.3%, therefore the actual duty cycle will be scaled up to the theoretical value of Bluetooth reported SAR calculation.

<Bluetooth Antenna 1>

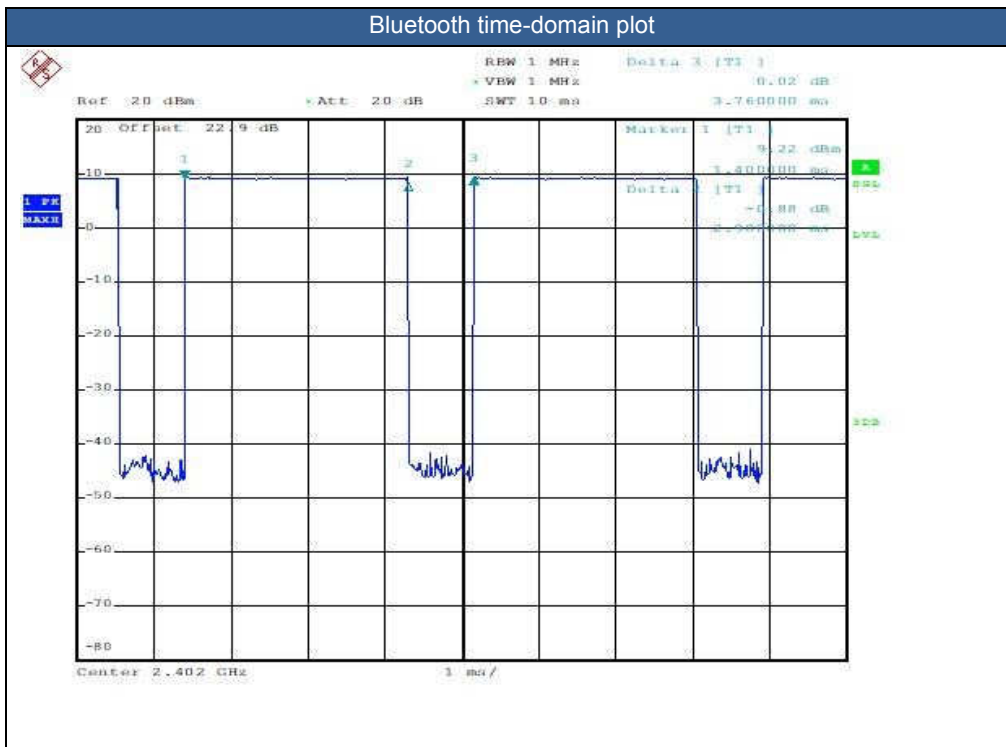

Mode	Channel	Frequency (MHz)	Data Rate
			1Mbps
BR/EDR	CH 00	2402	9.13
	CH 39	2441	9.11
	CH 78	2480	6.60
Tune-up Limit			10.00

Mode	Channel	Frequency (MHz)	Average power (dBm)
			GFSK
v4.0 LE	CH 00	2402	4.40
	CH 19	2440	5.10
	CH 39	2480	2.80
Tune-up Limit			7.00

Mode	Channel	Frequency (MHz)	Average power (dBm)
			GFSK
v5.0 LE	CH 00	2402	4.50
	CH 19	2440	5.20
	CH 39	2480	2.90
Tune-up Limit			6.00

<Bluetooth Antenna 2>

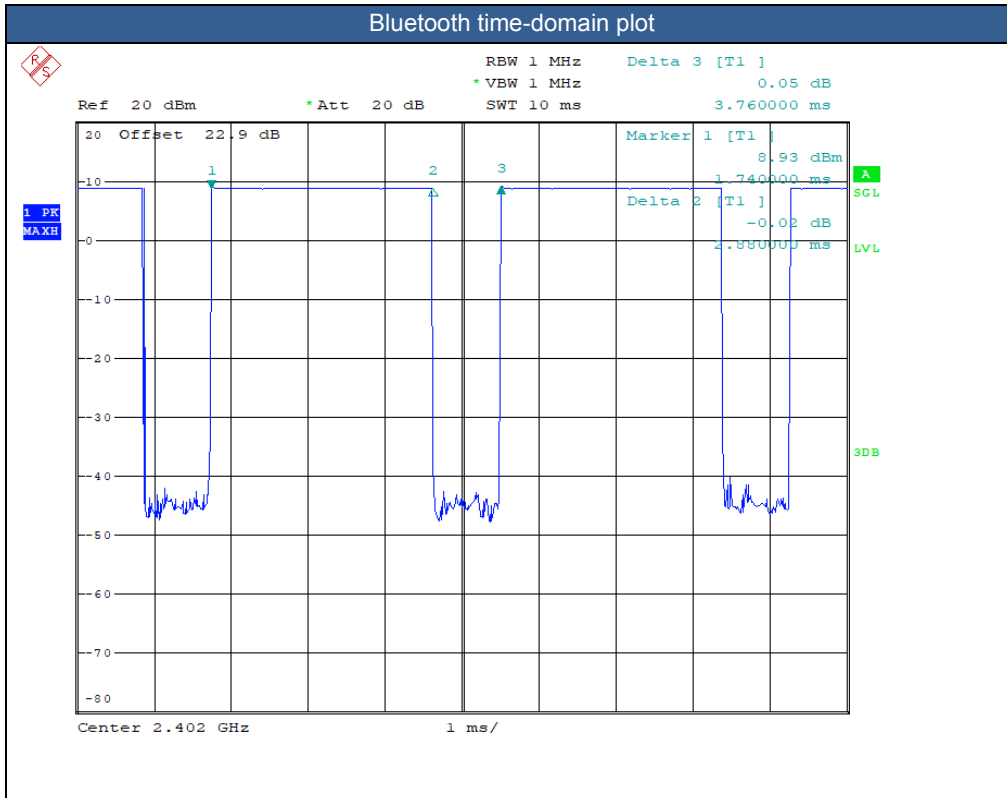

Mode	Channel	Frequency (MHz)	Data Rate
			1Mbps
BR/EDR	CH 00	2402	7.96
	CH 39	2441	7.34
	CH 78	2480	5.70
Tune-up Limit			9.00

Mode	Channel	Frequency (MHz)	Average power (dBm)
			GFSK
v4.0 LE	CH 00	2402	4.00
	CH 19	2440	4.70
	CH 39	2480	2.70
Tune-up Limit			7.00

Mode	Channel	Frequency (MHz)	Average power (dBm)
			GFSK
v5.0 LE	CH 00	2402	4.10
	CH 19	2440	4.80
	CH 39	2480	2.80
Tune-up Limit			6.00

14. Antenna Location

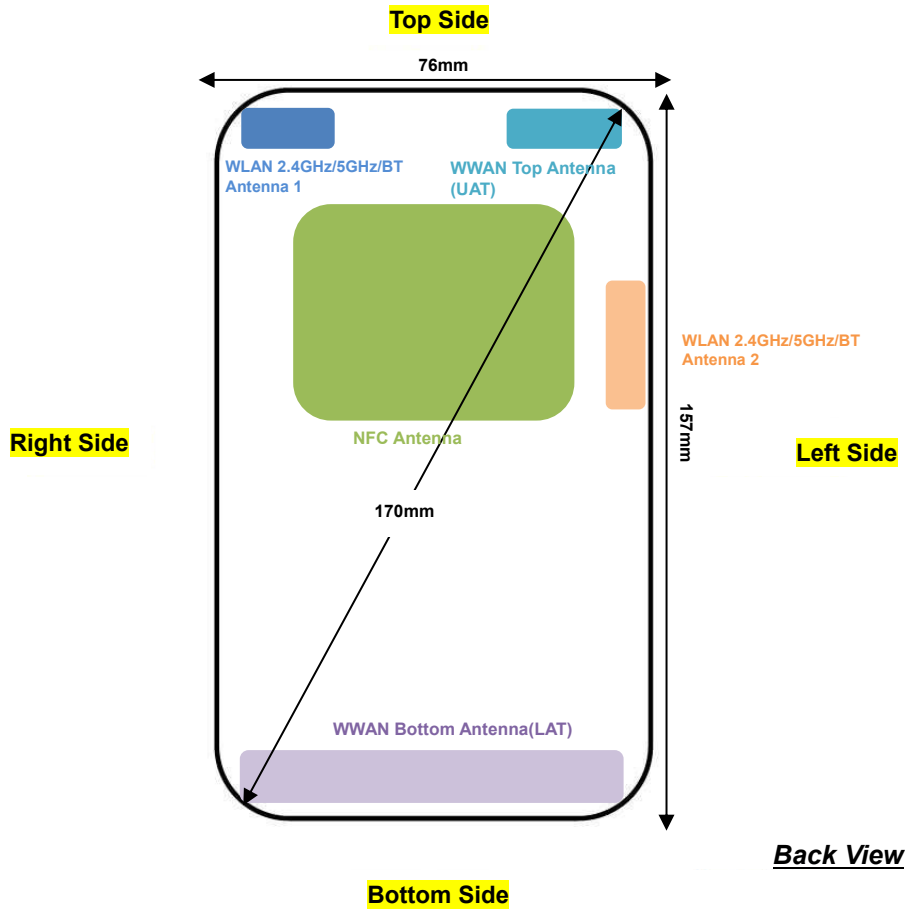

Antenna	Support Band
WWAN Top Antenna	GSM: 850 / 1900 WCDMA: B2 / B4 / B5 LTE: B2 / B4 / B5 / B7 / B38
WWAN Bottom Antenna	GSM: 850 / 1900 WCDMA: B2 / B4 / B5 LTE: B2 / B4 / B5 / B7 / B38
WLAN 2.4GHz/5GHz/BT Antenna 1	WLAN 2.4GHz WLAN 5GHz Bluetooth
WLAN 2.4GHz/5GHz/BT Antenna 2	WLAN 2.4GHz WLAN 5GHz Bluetooth
NFC Antenna	NFC

Distance of the Antenna to the EUT surface/edge						
Antennas	Back	Front	Top Side	Bottom Side	Right Side	Left Side
WWAN Top Antenna(UAT)	≤ 25mm	≤ 25mm	≤ 25mm	>25mm	>25mm	≤ 25mm
WWAN Bottom Antenna(LAT)	≤ 25mm	≤ 25mm	>25mm	≤ 25mm	≤ 25mm	≤ 25mm
WLAN 2.4GHz/5GHz/BT Antenna 1	≤ 25mm	≤ 25mm	≤ 25mm	>25mm	≤ 25mm	>25mm
WLAN 2.4GHz/5GHz /BT Antenna 2	≤ 25mm	≤ 25mm	>25mm	>25mm	>25mm	≤ 25mm

Distance of the Antenna to the EUT surface/edge						
Antennas	Back	Front	Top Side	Bottom Side	Right Side	Left Side
WWAN Top Antenna	Yes	Yes	Yes	No	No	Yes
WWAN Bottom Antenna	Yes	Yes	No	Yes	Yes	Yes
WLAN 2.4GHz/5GHz/BT Antenna 1	Yes	Yes	Yes	No	Yes	No
WLAN 2.4GHz/5GHz/BT Antenna 2	Yes	Yes	No	No	No	Yes

General Note:

Referring to KDB 941225 D06 v02r01, when the overall device length and width are ≥ 9cm*5cm, the test distance is 10 mm. SAR must be measured for all sides and surfaces with a transmitting antenna located within 25mm from that surface or edge.



15. SAR Test Results

General Note:

1. Per KDB 447498 D01v06, the reported SAR is the measured SAR value adjusted for maximum tune-up tolerance.
 - a. Tune-up scaling Factor = tune-up limit power (mW) / EUT RF power (mW), where tune-up limit is the maximum rated power among all production units.
 - b. For SAR testing of WLAN signal with non-100% duty cycle, the measured SAR is scaled-up by the duty cycle scaling factor which is equal to "1/(duty cycle)"
 - c. For WWAN: Reported SAR(W/kg)= Measured SAR(W/kg)*Tune-up Scaling Factor
 - d. For WLAN/Bluetooth: Reported SAR(W/kg)= Measured SAR(W/kg)* Duty Cycle scaling factor * Tune-up scaling factor
2. Per KDB 865664 D01v01r04, for each frequency band, repeated SAR measurement is required only when the measured SAR is ≥ 0.8 W/kg.
3. Per KDB 648474 D04v01r03, when the reported SAR for a body-worn accessory measured without a headset connected to the handset is ≤ 1.2 W/kg, SAR testing with a headset connected to the handset is not required.
4. Per KDB648474 D04v01r03, for smart phones with a display diagonal dimension > 15.0 cm or an overall diagonal dimension > 16.0 cm, when hotspot mode applies, 10-g product specific SAR is required only for the surfaces and edges with hotspot mode 1-g reported SAR > 1.2 W/kg, however, when power reduction applies to hotspot mode the measured SAR must be scaled to the maximum output power, including tolerance, allowed for phablet modes to compare with the 1.2 W/kg SAR test reduction threshold, for this device only bottom side SAR for WWAN transmitter scaled to maximum output power is higher than 1.2W/kg of GSM1900,WCDMA B2, and LTE B2, therefore product specific SAR is necessary.
5. For 5.3GHz / 5.5GHz WLAN product specific SAR is necessary too, due to an overall diagonal dimension is > 16cm.
6. For top WWAN antenna:
 - a. When the phone is in talking mode and receiver worked, then power reduction will be implemented immediately in GSM850/1900, WCDMA B2/B4/B5 and LTE B2/B4/B7/38/7C /38C.
 - b. When hotspot mode is enabled, power reduction will be activated to GSM850/1900, WCDMA B4/B5 and LTE B2/B4/B7/38/7C /38C. For GSM850, WCDMA B5 and LTE B7/38/7C /38C full power for hotspot mode can perform pass, no need to test reduced power.
7. For bottom WWAN antenna:
 - a. The device employs proximity sensors that detect the presence of the user's body at the back or bottom faces of the device. When back or bottom of sensor on is detected, GSM1900, WCDMA B2/B4 and LTE B2/B4 for back/bottom sides of product specific 10g SAR condition reduced powers will be active for sensor on state, GSM1900, WCDMA B4 and LTE B2/B4 at back side for Body Worn, full power can be tested pass, so reduced power no need to be evaluated.
 - b. When hotspot mode is enabled, power reduction will be activated to GSM1900, WCDMA band II/IV, LTE band 2/4/7/7C.
8. For WLAN antenna
 - a. For WLAN 2.4GHz/5.2/5.3/5.5GHz Ant1, When the phone is in talking mode, receiver worked and it transmits simultaneously with WWAN or Bluetooth for head mode, power reduction will be triggered for this scenario.
 - b. When hotspot mode is enabled, power reduction will be activated to WLAN2.4GHz/5.2GHz.
9. The 2.4GHz/5GHz WLAN & Bluetooth can transmit in SISO antenna mode only and they have no MIMO antenna mode.
10. There are two types of EUT (Sample 1 and Sample 2). According to the difference, they have no effect on SAR distribution, so only choose sample 1 to perform full testing.
11. UAT means top antenna, LAT means bottom antenna.

**GSM Note:**

1. Per KDB 941225 D01v03r01, for SAR test reduction for GSM / GPRS / EDGE modes is determined by the source-based time-averaged output power including tune-up tolerance. The mode with highest specified time-averaged output power should be tested for SAR compliance in the applicable exposure conditions. For modes with the same specified maximum output power and tolerance, the higher number time-slot configuration should be tested. Therefore, the GPRS (4Tx slots) for GSM850/GSM1900 are considered as the primary mode.
2. Other configurations of GSM / GPRS / EDGE are considered as secondary modes. The 3G SAR test reduction procedure is applied, when the maximum output power and tune-up tolerance specified for production units in a secondary mode is $\leq \frac{1}{4}$ dB higher than the primary mode, SAR measurement is not required for the secondary mode.

WCDMA Note:

1. Per KDB 941225 D01v03r01, for SAR testing is measured using a 12.2 kbps RMC with TPC bits configured to all "1's".
2. Per KDB 941225 D01v03r01, RMC 12.2kbps setting is used to evaluate SAR. The maximum output power and tune-up tolerance specified for production units in HSDPA / HSUPA / DC-HSDPA / HSPA+ is $\leq \frac{1}{4}$ dB higher than RMC 12.2Kbps or when the highest reported SAR of the RMC12.2Kbps is scaled by the ratio of specified maximum output power and tune-up tolerance of HSDPA / HSUPA / DC-HSDPA / HSPA+ to RMC12.2Kbps and the adjusted SAR is ≤ 1.2 W/kg, SAR measurement is not required for HSDPA / HSUPA / DC-HSDPA / HSPA+, and according to the following RF output power, the output power results of the secondary modes (HSDPA / HSUPA / DC-HSDPA / HSPA+), are less than $\frac{1}{4}$ dB higher than the primary modes; therefore, SAR measurement is not required for HSDPA / HSUPA / DC-HSDPA / HSPA+.

LTE Note:

1. Per KDB 941225 D05v02r05, start with the largest channel bandwidth and measure SAR for QPSK with 1 RB allocation, using the RB offset and required test channel combination with the highest maximum output power for RB offsets at the upper edge, middle and lower edge of each required test channel.
2. Per KDB 941225 D05v02r05, 50% RB allocation for QPSK SAR testing follows 1RB QPSK allocation procedure.
3. Per KDB 941225 D05v02r05, for QPSK with 100% RB allocation, SAR is not required when the highest maximum output power for 100 % RB allocation is less than the highest maximum output power in 50% and 1 RB allocations and the highest reported SAR for 1 RB and 50% RB allocation are ≤ 0.8 W/kg. Otherwise, SAR is measured for the highest output power channel; and if the reported SAR is > 1.45 W/kg, the remaining required test channels must also be tested.
4. Per KDB 941225 D05v02r05, 16QAM output power for each RB allocation configuration is $> \text{not } \frac{1}{2}$ dB higher than the same configuration in QPSK and the reported SAR for the QPSK configuration is ≤ 1.45 W/kg; Per KDB 941225 D05v02r05, 16QAM SAR testing is not required.
5. Per KDB 941225 D05v02r05, smaller bandwidth output power for each RB allocation configuration is $> \text{not } \frac{1}{2}$ dB higher than the same configuration in the largest supported bandwidth, and the reported SAR for the largest supported bandwidth is ≤ 1.45 W/kg; Per KDB 941225 D05v02r05, smaller bandwidth SAR testing is not required.
6. For LTE B4 / B5 / B38 the maximum bandwidth does not support three non-overlapping channels, per KDB 941225 D05v02r05, when a device supports overlapping channel assignment in a channel bandwidth configuration, the middle channel of the group of overlapping channels should be selected for testing.

WLAN/Bluetooth Note:

1. Per KDB 248227 D01v02r02, for 2.4GHz 802.11g/n SAR testing is not required when the highest reported SAR for DSSS is adjusted by the ratio of OFDM to DSSS specified maximum output power and the adjusted SAR is ≤ 1.2 W/kg.
2. When the reported SAR of the test position is > 0.4 W/kg, SAR is repeated for the 802.11 transmission mode configuration tested in the initial test position to measure the subsequent next closest/smallest test separation distance and maximum coupling test position on the highest maximum output power channel, until the report SAR is ≤ 0.8 W/kg or all required test position are tested.
3. For all positions / configurations, when the reported SAR is > 0.8 W/kg, SAR is measured for these test positions / configurations on the subsequent next highest measured output power channel(s) until the reported SAR is ≤ 1.2 W/kg or all required channels are tested.
4. During SAR testing the WLAN transmission was verified using a spectrum analyzer.



15.1 Head SAR

<GSM SAR>

Plot No.	Band	Mode	Test Position	Gap (mm)	Power State	Ch.	Freq. (MHz)	Average Power (dBm)	Tune-Up Limit (dBm)	Tune-up Scaling Factor	Power Drift (dB)	Measured 1g SAR (W/kg)	Reported 1g SAR (W/kg)
	GSM 850-UAT	GPRS 4 Tx slots	Right Cheek	0	Reduced	128	824.2	27.89	28.00	1.026	0.07	0.928	0.952
	GSM 850-UAT	GPRS 4 Tx slots	Right Cheek	0	Reduced	189	836.4	27.88	28.00	1.028	0.09	0.86	0.884
	GSM 850-UAT	GPRS 4 Tx slots	Right Cheek	0	Reduced	251	848.8	27.72	28.00	1.067	-0.01	0.892	0.951
	GSM 850-UAT	GPRS 4 Tx slots	Right Tilted	0	Reduced	128	824.2	27.89	28.00	1.026	0.04	0.876	0.898
	GSM 850-UAT	GPRS 4 Tx slots	Right Tilted	0	Reduced	189	836.4	27.88	28.00	1.028	0.02	0.81	0.833
	GSM 850-UAT	GPRS 4 Tx slots	Right Tilted	0	Reduced	251	848.8	27.72	28.00	1.067	-0.04	0.812	0.866
	GSM 850-UAT	GPRS 4 Tx slots	Left Cheek	0	Reduced	128	824.2	27.89	28.00	1.026	0.1	0.975	1.000
01	GSM 850-UAT	GPRS 4 Tx slots	Left Cheek	0	Reduced	189	836.4	27.88	28.00	1.028	0.03	1.040	1.069
	GSM 850-UAT	GPRS 4 Tx slots	Left Cheek	0	Reduced	251	848.8	27.72	28.00	1.067	0.02	0.932	0.994
	GSM 850-UAT	GPRS 4 Tx slots	Left Tilted	0	Reduced	128	824.2	27.89	28.00	1.026	0.03	0.759	0.778
	GSM 850-LAT	GPRS 4 Tx slots	Right Cheek	0	Full	128	824.2	28.97	29.00	1.007	0.09	0.253	0.255
	GSM1900-UAT	GPRS 4 Tx slots	Right Cheek	0	Reduced	661	1880	23.47	24.00	1.130	0.05	0.867	0.980
02	GSM1900-UAT	GPRS 4 Tx slots	Right Cheek	0	Reduced	512	1850.2	23.29	24.00	1.178	-0.01	0.963	1.134
	GSM1900-UAT	GPRS 4 Tx slots	Right Cheek	0	Reduced	810	1909.8	23.46	24.00	1.132	0.05	0.96	1.087
	GSM1900-UAT	GPRS 4 Tx slots	Right Tilted	0	Reduced	661	1880	23.47	24.00	1.130	0.04	0.471	0.532
	GSM1900-UAT	GPRS 4 Tx slots	Left Cheek	0	Reduced	661	1880	23.47	24.00	1.130	-0.03	0.428	0.484
	GSM1900-UAT	GPRS 4 Tx slots	Left Tilted	0	Reduced	661	1880	23.47	24.00	1.130	0.03	0.261	0.295
	GSM1900-LAT	GPRS 4 Tx slots	Right Cheek	0	Full	661	1880	26.44	26.50	1.014	-0.03	0.07	0.071

<WCDMA SAR>

Plot No.	Band	Mode	Test Position	Gap (mm)	Power State	Ch.	Freq. (MHz)	Average Power (dBm)	Tune-Up Limit (dBm)	Tune-up Scaling Factor	Power Drift (dB)	Measured 1g SAR (W/kg)	Reported 1g SAR (W/kg)
03	WCDMA II-UAT	RMC 12.2Kbps	Right Cheek	0	Reduced	9538	1907.6	20.33	20.50	1.040	0.06	0.536	0.557
	WCDMA II-UAT	RMC 12.2Kbps	Right Tilted	0	Reduced	9538	1907.6	20.33	20.50	1.040	0.06	0.295	0.307
	WCDMA II-UAT	RMC 12.2Kbps	Left Cheek	0	Reduced	9538	1907.6	20.33	20.50	1.040	-0.01	0.292	0.304
	WCDMA II-UAT	RMC 12.2Kbps	Left Tilted	0	Reduced	9538	1907.6	20.33	20.50	1.040	0.05	0.167	0.174
	WCDMA II-LAT	RMC 12.2Kbps	Right Cheek	0	Full	9538	1907.6	24.08	24.50	1.102	0.04	0.149	0.164
04	WCDMA IV-UAT	RMC 12.2Kbps	Right Cheek	0	Reduced	1513	1752.6	20.20	21.00	1.202	0.13	0.403	0.485
	WCDMA IV-UAT	RMC 12.2Kbps	Right Tilted	0	Reduced	1513	1752.6	20.20	21.00	1.202	0.14	0.33	0.397
	WCDMA IV-UAT	RMC 12.2Kbps	Left Cheek	0	Reduced	1513	1752.6	20.20	21.00	1.202	0.05	0.273	0.328
	WCDMA IV-UAT	RMC 12.2Kbps	Left Tilted	0	Reduced	1513	1752.6	20.20	21.00	1.202	0.02	0.179	0.215
	WCDMA IV-LAT	RMC 12.2Kbps	Left Cheek	0	Full	1312	1712.4	24.23	24.50	1.064	0.07	0.066	0.070
	WCDMA V-UAT	RMC 12.2Kbps	Right Cheek	0	Reduced	4233	846.6	23.04	23.50	1.112	0.03	0.956	1.063
	WCDMA V-UAT	RMC 12.2Kbps	Right Cheek	0	Reduced	4132	826.4	23.03	23.50	1.114	0.09	0.842	0.938
	WCDMA V-UAT	RMC 12.2Kbps	Right Cheek	0	Reduced	4182	836.4	22.90	23.50	1.148	-0.02	0.918	1.054
05	WCDMA V-UAT	RMC 12.2Kbps	Right Tilted	0	Reduced	4233	846.6	23.04	23.50	1.112	0.02	1.010	1.123
	WCDMA V-UAT	RMC 12.2Kbps	Right Tilted	0	Reduced	4132	826.4	23.03	23.50	1.114	0.01	0.822	0.916
	WCDMA V-UAT	RMC 12.2Kbps	Right Tilted	0	Reduced	4182	836.4	22.90	23.50	1.148	0.09	0.926	1.063
	WCDMA V-UAT	RMC 12.2Kbps	Left Cheek	0	Reduced	4233	846.6	23.04	23.50	1.112	0.01	0.788	0.876
	WCDMA V-UAT	RMC 12.2Kbps	Left Cheek	0	Reduced	4132	826.4	23.03	23.50	1.114	0.02	0.732	0.816
	WCDMA V-UAT	RMC 12.2Kbps	Left Cheek	0	Reduced	4182	836.4	22.90	23.50	1.148	-0.05	0.756	0.868
	WCDMA V-UAT	RMC 12.2Kbps	Left Tilted	0	Reduced	4233	846.6	23.04	23.50	1.112	0.03	0.668	0.743
	WCDMA V-LAT	RMC 12.2Kbps	Right Cheek	0	Full	4132	826.4	24.12	24.50	1.091	-0.06	0.200	0.218



<FDD LTE SAR>

Plot No.	Band	BW (MHz)	Modulation	RB Size	RB offset	Test Position	Gap (mm)	Power State	Ch.	Freq. (MHz)	Average Power (dBm)	Tune-Up Limit (dBm)	Tune-up Scaling Factor	Power Drift (dB)	Measured 1g SAR (W/kg)	Reported 1g SAR (W/kg)
06	LTE Band 2-UAT	20M	QPSK	1	0	Right Cheek	0	Reduced	19100	1900	20.36	21.00	1.159	0.01	0.460	0.533
	LTE Band 2-UAT	20M	QPSK	50	0	Right Cheek	0	Reduced	19100	1900	20.11	21.00	1.227	0.01	0.464	0.570
	LTE Band 2-UAT	20M	QPSK	1	0	Right Tilted	0	Reduced	19100	1900	20.36	21.00	1.159	0.13	0.323	0.374
	LTE Band 2-UAT	20M	QPSK	50	0	Right Tilted	0	Reduced	19100	1900	20.11	21.00	1.227	0.05	0.325	0.399
	LTE Band 2-UAT	20M	QPSK	1	0	Left Cheek	0	Reduced	19100	1900	20.36	21.00	1.159	0.06	0.299	0.346
	LTE Band 2-UAT	20M	QPSK	50	0	Left Cheek	0	Reduced	19100	1900	20.11	21.00	1.227	0.01	0.306	0.376
	LTE Band 2-UAT	20M	QPSK	1	0	Left Tilted	0	Reduced	19100	1900	20.36	21.00	1.159	0.06	0.220	0.255
	LTE Band 2-UAT	20M	QPSK	50	0	Left Tilted	0	Reduced	19100	1900	20.11	21.00	1.227	0.07	0.226	0.277
	LTE Band 2-LAT	20M	QPSK	1	0	Right Cheek	0	Full	18900	1880	23.88	24.00	1.028	-0.14	0.078	0.080
07	LTE Band 4-UAT	20M	QPSK	1	0	Right Cheek	0	Reduced	20175	1732.5	22.60	23.50	1.230	0.04	0.650	0.800
	LTE Band 4-UAT	20M	QPSK	50	0	Right Cheek	0	Reduced	20175	1732.5	22.18	23.00	1.208	0.11	0.620	0.749
	LTE Band 4-UAT	20M	QPSK	100	0	Right Cheek	0	Reduced	20175	1732.5	21.96	23.00	1.271	0.03	0.614	0.780
	LTE Band 4-UAT	20M	QPSK	1	0	Right Tilted	0	Reduced	20175	1732.5	22.60	23.50	1.230	-0.02	0.626	0.770
	LTE Band 4-UAT	20M	QPSK	50	0	Right Tilted	0	Reduced	20175	1732.5	22.18	23.00	1.208	0.06	0.522	0.630
	LTE Band 4-UAT	20M	QPSK	1	0	Left Cheek	0	Reduced	20175	1732.5	22.60	23.50	1.230	-0.08	0.411	0.506
	LTE Band 4-UAT	20M	QPSK	50	0	Left Cheek	0	Reduced	20175	1732.5	22.18	23.00	1.208	0.07	0.35	0.423
	LTE Band 4-UAT	20M	QPSK	1	0	Left Tilted	0	Reduced	20175	1732.5	22.60	23.50	1.230	-0.02	0.283	0.348
	LTE Band 4-UAT	20M	QPSK	50	0	Left Tilted	0	Reduced	20175	1732.5	22.18	23.00	1.208	0.02	0.241	0.291
LTE Band 4-LAT	20M	QPSK	1	0	Right Cheek	0	Full	20175	1732.5	23.74	24.00	1.062	0.05	0.048	0.051	
08	LTE Band 5-UAT	10M	QPSK	1	0	Right Tilted	0	Full	20525	836.5	23.77	24.00	1.054	-0.02	0.640	0.675
	LTE Band 5-LAT	10M	QPSK	1	0	Right Cheek	0	Full	20525	836.5	23.77	24.00	1.054	-0.07	0.135	0.142
09	LTE Band 7-UAT	20M	QPSK	1	0	Right Cheek	0	Reduced	21350	2560	18.46	18.50	1.009	0.02	0.588	0.593
	LTE Band 7-UAT	20M	QPSK	1	0	Right Cheek	0	Reduced	21350+21152	2560+2540.2	18.42	18.50	1.019	-0.02	0.536	0.546
	LTE Band 7-UAT	20M	QPSK	50	24	Right Cheek	0	Reduced	21350	2560	18.29	18.50	1.050	-0.11	0.564	0.592
	LTE Band 7-UAT	20M	QPSK	1	0	Right Tilted	0	Reduced	21350	2560	18.46	18.50	1.009	0.01	0.473	0.477
	LTE Band 7-UAT	20M	QPSK	50	24	Right Tilted	0	Reduced	21350	2560	18.29	18.50	1.050	0.04	0.471	0.494
	LTE Band 7-UAT	20M	QPSK	1	0	Left Cheek	0	Reduced	21350	2560	18.46	18.50	1.009	0.03	0.243	0.245
	LTE Band 7-UAT	20M	QPSK	50	24	Left Cheek	0	Reduced	21350	2560	18.29	18.50	1.050	0.03	0.245	0.257
	LTE Band 7-UAT	20M	QPSK	1	0	Left Tilted	0	Reduced	21350	2560	18.46	18.50	1.009	0.01	0.182	0.184
	LTE Band 7-UAT	20M	QPSK	50	24	Left Tilted	0	Reduced	21350	2560	18.29	18.50	1.050	0.03	0.184	0.193
LTE Band 7-LAT	20M	QPSK	1	49	Right Cheek	0	Full	21350	2560	23.82	24.00	1.042	0.05	0.084	0.088	

<TDD LTE SAR>

Plot No.	Band	BW (MHz)	Modulation	RB Size	RB offset	Test Position	Gap (mm)	Power State	Ch.	Freq. (MHz)	Average Power (dBm)	Tune-Up Limit (dBm)	Tune-up Scaling Factor	Duty Cycle %	Duty Cycle Scaling Factor	Power Drift (dB)	Measured 1g SAR (W/kg)	Reported 1g SAR (W/kg)
10	LTE Band 38-UAT	20M	QPSK	1	0	Right Cheek	0	Reduced	38000	2595	21.00	21.50	1.122	62.9	1.006	0.01	0.669	0.755
	LTE Band 38-UAT	20M	QPSK	50	0	Right Cheek	0	Reduced	38000	2595	20.95	21.50	1.135	62.9	1.006	-0.06	0.677	0.773
	LTE Band 38-UAT	20M	QPSK	50	0	Right Cheek	0	Reduced	37901+38099	2585.1+2604.9	21.01	21.50	1.119	62.9	1.006	0.09	0.631	0.711
	LTE Band 38-UAT	20M	QPSK	1	0	Right Tilted	0	Reduced	38000	2595	21.00	21.50	1.122	62.9	1.006	0.03	0.531	0.599
	LTE Band 38-UAT	20M	QPSK	50	0	Right Tilted	0	Reduced	38000	2595	20.95	21.50	1.135	62.9	1.006	0.01	0.497	0.567
	LTE Band 38-UAT	20M	QPSK	1	0	Left Cheek	0	Reduced	38000	2595	21.00	21.50	1.122	62.9	1.006	0.03	0.296	0.334
	LTE Band 38-UAT	20M	QPSK	50	0	Left Cheek	0	Reduced	38000	2595	20.95	21.50	1.135	62.9	1.006	0.01	0.303	0.346
	LTE Band 38-UAT	20M	QPSK	1	0	Left Tilted	0	Reduced	38000	2595	21.00	21.50	1.122	62.9	1.006	0.03	0.224	0.253
	LTE Band 38-UAT	20M	QPSK	50	0	Left Tilted	0	Reduced	38000	2595	20.95	21.50	1.135	62.9	1.006	0.03	0.226	0.258
LTE Band 38-LAT	20M	QPSK	1	0	Right Cheek	0	Full	38000	2595	23.95	24.00	1.012	62.9	1.006	0.04	0.053	0.054	



<WLAN 2.4GHz SAR>

Plot No.	Band	Mode	Test Position	Gap (mm)	Antenna	Power State	Ch.	Freq. (MHz)	Average Power (dBm)	Tune-Up Limit (dBm)	Tune-up Scaling Factor	Duty Cycle %	Duty Cycle Scaling Factor	Power Drift (dB)	Measured 1g SAR (W/kg)	Reported 1g SAR (W/kg)
11	WLAN2.4GHz-	802.11b 1Mbps	Left Cheek	0	1	Full	11	2462	16.50	17.00	1.122	99.05	1.010	-0.07	0.721	0.817
	WLAN2.4GHz-	802.11b 1Mbps	Left Cheek	0	1	Full	6	2437	14.90	15.00	1.023	99.05	1.010	0.02	0.517	0.534
	WLAN2.4GHz	802.11b 1Mbps	Left Cheek	0	1	Reduced	6	2437	14.21	15.00	1.199	99.05	1.010	0.03	0.373	0.452
	WLAN2.4GHz	802.11b 1Mbps	Right Cheek	0	2	Full	11	2462	16.20	17.00	1.202	98.93	1.011	-0.05	0.369	0.449

<WLAN 5GHz SAR>

Plot No.	Band	Mode	Test Position	Gap (mm)	Antenna	Power State	Ch.	Freq. (MHz)	Average Power (dBm)	Tune-Up Limit (dBm)	Tune-up Scaling Factor	Duty Cycle %	Duty Cycle Scaling Factor	Power Drift (dB)	Measured 1g SAR (W/kg)	Reported 1g SAR (W/kg)
12	WLAN5.3GHz	802.11a 6Mbps	Left Tilted	0	1	Full	56	5280	16.27	17.00	1.183	96.19	1.040	-0.08	0.328	0.404
	WLAN5.3GHz	802.11a 6Mbps	Left Tilted	0	1	Reduced	56	5280	13.11	14.50	1.377	96.19	1.040	-0.06	0.248	0.355
	WLAN5.3GHz	802.11a 6Mbps	Right Cheek	0	2	Full	52	5260	12.92	14.00	1.282	96.89	1.032	-0.06	0.176	0.233
13	WLAN5.5GHz	802.11a 6Mbps	Left Tilted	0	1	Full	132	5660	15.89	16.50	1.151	96.19	1.040	-0.06	0.520	0.622
	WLAN5.5GHz	802.11a 6Mbps	Left Tilted	0	1	Reduced	132	5660	13.48	14.50	1.265	96.19	1.040	-0.05	0.409	0.538
	WLAN5.5GHz	802.11a 6Mbps	Right Cheek	0	2	Full	100	5500	12.84	14.00	1.306	96.89	1.032	-0.06	0.113	0.152
14	WLAN5.8GHz	802.11a 6Mbps	Left Tilted	0	1	Full	149	5745	13.00	13.50	1.122	96.19	1.040	-0.06	0.299	0.349
	WLAN5.8GHz	802.11a 6Mbps	Right Cheek	0	2	Full	149	5745	12.07	13.50	1.390	96.89	1.032	-0.09	0.078	0.112



15.2 Hotspot SAR

<GSM SAR>

Plot No.	Band	Mode	Test Position	Gap (mm)	Power State	Ch.	Freq. (MHz)	Average Power (dBm)	Tune-Up Limit (dBm)	Tune-up Scaling Factor	Power Drift (dB)	Measured 1g SAR (W/kg)	Reported 1g SAR (W/kg)
15	GSM 850-UAT	GPRS 4 Tx slots	Back	10	Full	128	824.2	28.97	29.00	1.007	-0.01	0.471	0.474
	GSM 850-LAT	GPRS 4 Tx slots	Back	10	Full	128	824.2	28.97	29.00	1.007	-0.03	0.363	0.366
	GSM1900-UAT	GPRS 4 Tx slots	Back	10	Full	661	1880	26.44	26.50	1.014	-0.11	0.125	0.127
	GSM1900-LAT	GPRS 4 Tx slots	Front	10	Reduced	810	1909.8	22.13	23.00	1.222	0.03	0.301	0.368
	GSM1900-LAT	GPRS 4 Tx slots	Back	10	Reduced	810	1909.8	22.13	23.00	1.222	-0.01	0.402	0.491
	GSM1900-LAT	GPRS 4 Tx slots	Left Side	10	Reduced	810	1909.8	22.13	23.00	1.222	0.03	0.036	0.043
	GSM1900-LAT	GPRS 4 Tx slots	Right Side	10	Reduced	810	1909.8	22.13	23.00	1.222	0.04	0.041	0.050
16	GSM1900-LAT	GPRS 4 Tx slots	Bottom Side	10	Reduced	810	1909.8	22.13	23.00	1.222	-0.01	0.750	0.916
	GSM1900-LAT	GPRS 4 Tx slots	Bottom Side	10	Reduced	512	1850.2	21.83	23.00	1.309	0.03	0.453	0.593
	GSM1900-LAT	GPRS 4 Tx slots	Bottom Side	10	Reduced	661	1880	21.92	23.00	1.282	0.04	0.545	0.699

<WCDMA SAR>

Plot No.	Band	Mode	Test Position	Gap (mm)	State	Ch.	Freq. (MHz)	Average Power (dBm)	Tune-Up Limit (dBm)	Tune-up Scaling Factor	Power Drift (dB)	Measured 1g SAR (W/kg)	Reported 1g SAR (W/kg)
	WCDMA II-UAT	RMC 12.2Kbps	Back	10	Full	9538	1907.6	24.08	24.50	1.102	-0.18	0.292	0.322
	WCDMA II-LAT	RMC 12.2Kbps	Front	10	Reduced	9538	1907.6	17.88	18.00	1.028	0.03	0.246	0.253
	WCDMA II-LAT	RMC 12.2Kbps	Back	10	Reduced	9538	1907.6	17.88	18.00	1.028	0.01	0.373	0.383
	WCDMA II-LAT	RMC 12.2Kbps	Left Side	10	Reduced	9538	1907.6	17.88	18.00	1.028	0.01	0.027	0.028
	WCDMA II-LAT	RMC 12.2Kbps	Right Side	10	Reduced	9538	1907.6	17.88	18.00	1.028	0.04	0.038	0.039
17	WCDMA II-LAT	RMC 12.2Kbps	Bottom Side	10	Reduced	9538	1907.6	17.88	18.00	1.028	0.1	0.681	0.700
	WCDMA IV-UAT	RMC 12.2Kbps	Top Side	10	Full	1312	1712.4	24.23	24.50	1.064	0.05	0.322	0.343
	WCDMA IV-LAT	RMC 12.2Kbps	Front	10	Reduced	1513	1752.6	21.36	22.00	1.159	0.03	0.309	0.358
	WCDMA IV-LAT	RMC 12.2Kbps	Back	10	Reduced	1513	1752.6	21.36	22.00	1.159	-0.08	0.466	0.540
	WCDMA IV-LAT	RMC 12.2Kbps	Left Side	10	Reduced	1513	1752.6	21.36	22.00	1.159	0.01	0.066	0.077
	WCDMA IV-LAT	RMC 12.2Kbps	Right Side	10	Reduced	1513	1752.6	21.36	22.00	1.159	0.07	0.060	0.069
	WCDMA IV-LAT	RMC 12.2Kbps	Bottom Side	10	Reduced	1513	1752.6	21.36	22.00	1.159	0.01	0.902	1.045
	WCDMA IV-LAT	RMC 12.2Kbps	Bottom Side	10	Reduced	1312	1712.4	21.35	22.00	1.161	0.03	0.923	1.072
18	WCDMA IV-LAT	RMC 12.2Kbps	Bottom Side	10	Reduced	1413	1732.6	21.29	22.00	1.178	0.01	0.948	1.116
19	WCDMA V-UAT	RMC 12.2Kbps	Back	10	Full	4132	826.4	24.12	24.50	1.091	0.07	0.311	0.339
	WCDMA V-LAT	RMC 12.2Kbps	Back	10	Full	4132	826.4	24.12	24.50	1.091	0.14	0.289	0.315



<FDD LTE SAR>

Plot No.	Band	BW (MHz)	Modulation	RB Size	RB offset	Test Position	Gap (mm)	Power State	Ch.	Freq. (MHz)	Average Power (dBm)	Tune-Up Limit (dBm)	Tune-up Scaling Factor	Power Drift (dB)	Measured 1g SAR (W/kg)	Reported 1g SAR (W/kg)
	LTE Band 2-UAT	20M	QPSK	1	0	Back	10	Full	18900	1880	23.88	24.00	1.028	-0.07	0.235	0.242
	LTE Band 2-LAT	20M	QPSK	1	0	Front	10	Reduced	19100	1900	18.48	19.00	1.127	0.01	0.229	0.258
	LTE Band 2-LAT	20M	QPSK	50	0	Front	10	Reduced	19100	1900	18.49	19.00	1.125	0.03	0.246	0.277
	LTE Band 2-LAT	20M	QPSK	1	0	Back	10	Reduced	19100	1900	18.48	19.00	1.127	0.04	0.344	0.388
	LTE Band 2-LAT	20M	QPSK	50	0	Back	10	Reduced	19100	1900	18.49	19.00	1.125	0.09	0.369	0.415
	LTE Band 2-LAT	20M	QPSK	1	0	Left Side	10	Reduced	19100	1900	18.48	19.00	1.127	0.03	0.030	0.034
	LTE Band 2-LAT	20M	QPSK	50	0	Left Side	10	Reduced	19100	1900	18.49	19.00	1.125	0.03	0.031	0.035
	LTE Band 2-LAT	20M	QPSK	1	0	Right Side	10	Reduced	19100	1900	18.48	19.00	1.127	0.01	0.032	0.036
	LTE Band 2-LAT	20M	QPSK	50	0	Right Side	10	Reduced	19100	1900	18.49	19.00	1.125	0.01	0.033	0.037
	LTE Band 2-LAT	20M	QPSK	1	0	Bottom Side	10	Reduced	19100	1900	18.48	19.00	1.127	0.1	0.591	0.666
20	LTE Band 2-LAT	20M	QPSK	50	0	Bottom Side	10	Reduced	19100	1900	18.49	19.00	1.125	0.06	0.629	0.707
	LTE Band 4-UAT	20M	QPSK	1	0	Top Side	10	Full	20175	1732.5	23.74	24.00	1.062	0.06	0.253	0.269
	LTE Band 4-LAT	20M	QPSK	1	0	Front	10	Reduced	20175	1732.5	21.50	22.00	1.122	0.01	0.247	0.277
	LTE Band 4-LAT	20M	QPSK	50	0	Front	10	Reduced	20175	1732.5	21.32	22.00	1.169	0.03	0.236	0.276
	LTE Band 4-LAT	20M	QPSK	1	0	Back	10	Reduced	20175	1732.5	21.50	22.00	1.122	0.08	0.394	0.442
	LTE Band 4-LAT	20M	QPSK	50	0	Back	10	Reduced	20175	1732.5	21.32	22.00	1.169	0.01	0.394	0.461
	LTE Band 4-LAT	20M	QPSK	1	0	Left Side	10	Reduced	20175	1732.5	21.50	22.00	1.122	0.03	0.055	0.061
	LTE Band 4-LAT	20M	QPSK	50	0	Left Side	10	Reduced	20175	1732.5	21.32	22.00	1.169	0.01	0.054	0.063
	LTE Band 4-LAT	20M	QPSK	1	0	Right Side	10	Reduced	20175	1732.5	21.50	22.00	1.122	0.04	0.054	0.061
	LTE Band 4-LAT	20M	QPSK	50	0	Right Side	10	Reduced	20175	1732.5	21.32	22.00	1.169	0.04	0.053	0.062
	LTE Band 4-LAT	20M	QPSK	1	0	Bottom Side	10	Reduced	20175	1732.5	21.50	22.00	1.122	0.01	0.711	0.798
	LTE Band 4-LAT	20M	QPSK	50	0	Bottom Side	10	Reduced	20175	1732.5	21.32	22.00	1.169	0.03	0.722	0.844
21	LTE Band 4-LAT	20M	QPSK	100	0	Bottom Side	10	Reduced	20175	1732.5	21.26	22.00	1.186	0.04	0.748	0.887
22	LTE Band 5-UAT	10M	QPSK	1	0	Back	10	Full	20525	836.5	23.77	24.00	1.054	-0.08	0.238	0.251
	LTE Band 5-LAT	10M	QPSK	1	0	Back	10	Full	20525	836.5	23.77	24.00	1.054	0.02	0.224	0.236
	LTE Band 7-UAT	20M	QPSK	1	49	Left Side	10	Full	21350	2560	23.82	24.00	1.042	0.06	0.670	0.698
	LTE Band 7-LAT	20M	QPSK	1	49	Front	10	Reduced	21350	2560	23.45	23.50	1.012	-0.04	0.507	0.513
	LTE Band 7-LAT	20M	QPSK	50	24	Front	10	Reduced	21350	2560	22.89	23.00	1.026	-0.03	0.457	0.469
	LTE Band 7-LAT	20M	QPSK	1	49	Back	10	Reduced	21350	2560	23.45	23.50	1.012	0.17	0.817	0.826
	LTE Band 7-LAT	20M	QPSK	1	49	Back	10	Reduced	20850	2510	23.12	23.50	1.091	0.03	0.736	0.803
	LTE Band 7-LAT	20M	QPSK	1	49	Back	10	Reduced	21100	2535	23.18	23.50	1.076	0.17	0.725	0.780
	LTE Band 7-LAT	20M	QPSK	50	24	Back	10	Reduced	21350	2560	22.89	23.00	1.026	0.03	0.700	0.718
	LTE Band 7-LAT	20M	QPSK	100	0	Back	10	Reduced	21350	2560	22.69	23.00	1.074	0.02	0.558	0.599
	LTE Band 7-LAT	20M	QPSK	1	49	Left Side	10	Reduced	21350	2560	23.45	23.50	1.012	0.03	0.351	0.355
	LTE Band 7-LAT	20M	QPSK	50	24	Left Side	10	Reduced	21350	2560	22.89	23.00	1.026	0.04	0.317	0.325
	LTE Band 7-LAT	20M	QPSK	1	49	Right Side	10	Reduced	21350	2560	23.45	23.50	1.012	0.01	0.130	0.132
	LTE Band 7-LAT	20M	QPSK	50	24	Right Side	10	Reduced	21350	2560	22.89	23.00	1.026	0.01	0.114	0.117
23	LTE Band 7-LAT	20M	QPSK	1	49	Bottom Side	10	Reduced	21350	2560	23.45	23.50	1.012	0.08	1.090	1.103
	LTE Band 7-LAT	20M	QPSK	1	49	Bottom Side	10	Reduced	21350+21152	2560+2540.2	23.28	23.50	1.052	0.01	1.030	1.084
	LTE Band 7-LAT	20M	QPSK	1	49	Bottom Side	10	Reduced	20850	2510	23.12	23.50	1.091	0.06	0.814	0.888
	LTE Band 7-LAT	20M	QPSK	1	49	Bottom Side	10	Reduced	21100	2535	23.18	23.50	1.076	0.04	0.845	0.910
	LTE Band 7-LAT	20M	QPSK	50	24	Bottom Side	10	Reduced	21350	2560	22.89	23.00	1.026	0.03	0.784	0.804
	LTE Band 7-LAT	20M	QPSK	50	24	Bottom Side	10	Reduced	20850	2510	22.65	23.00	1.084	0.04	0.745	0.808
	LTE Band 7-LAT	20M	QPSK	50	24	Bottom Side	10	Reduced	21100	2535	22.75	23.00	1.059	0.04	0.765	0.810
	LTE Band 7-LAT	20M	QPSK	100	0	Bottom Side	10	Reduced	21350	2560	22.69	23.00	1.074	0.01	0.778	0.836



<TDD LTE SAR>

Plot No.	Band	BW (MHz)	Modulation	RB Size	RB offset	Test Position	Gap (mm)	Power State	Ch.	Freq. (MHz)	Average Power (dBm)	Tune-Up Limit (dBm)	Tune-up Scaling Factor	Duty Cycle %	Duty Cycle Scaling Factor	Power Drift (dB)	Measured 1g SAR (W/kg)	Reported 1g SAR (W/kg)
	LTE Band 38-UAT	20M	QPSK	1	0	Left Side	10	Full	38000	2595	23.95	24.00	1.012	62.9	1.006	0.03	0.343	0.349
24	LTE Band 38-LAT	20M	QPSK	1	0	Back	10	Full	38000	2595	23.95	24.00	1.012	62.9	1.006	-0.01	0.409	0.416

<WLAN 2.4GHz SAR>

Plot No.	Band	Mode	Test Position	Gap (mm)	Antenna	Power State	Ch.	Freq. (MHz)	Average Power (dBm)	Tune-Up Limit (dBm)	Tune-up Scaling Factor	Duty Cycle %	Duty Cycle Scaling Factor	Power Drift (dB)	Measured 1g SAR (W/kg)	Reported 1g SAR (W/kg)
25	WLAN2.4GHz	802.11b 1Mbps	Top Side	10	1	Full	11	2462	16.50	17.00	1.122	99.05	1.010	0.01	0.216	0.245
	WLAN2.4GHz	802.11b 1Mbps	Left Side	10	2	Full	11	2462	16.20	17.00	1.202	98.93	1.011	-0.02	0.170	0.207

<WLAN 5GHz SAR>

Plot No.	Band	Mode	Test Position	Gap (mm)	Antenna	Power State	Ch.	Freq. (MHz)	Average Power (dBm)	Tune-Up Limit (dBm)	Tune-up Scaling Factor	Duty Cycle %	Duty Cycle Scaling Factor	Power Drift (dB)	Measured 1g SAR (W/kg)	Reported 1g SAR (W/kg)
26	WLAN5.2GHz	802.11a 6Mbps	Back	10	1	Full	36	5180	16.29	17.00	1.178	96.19	1.040	-0.09	0.736	0.901
	WLAN5.2GHz	802.11a 6Mbps	Left Side	10	2	Full	48	5240	12.95	14.00	1.274	96.89	1.032	-0.01	0.200	0.263
27	WLAN5.8GHz	802.11a 6Mbps	Back	10	1	Full	149	5745	13.00	13.50	1.122	96.19	1.040	-0.09	0.669	0.781
	WLAN5.8GHz	802.11a 6Mbps	Left Side	10	2	Full	149	5745	12.07	13.50	1.390	96.89	1.032	-0.07	0.081	0.116



15.3 Body Worn Accessory SAR

<GSM SAR>

Plot No.	Band	Mode	Test Position	Gap (mm)	Power State	Ch.	Freq. (MHz)	Average Power (dBm)	Tune-Up Limit (dBm)	Tune-up Scaling Factor	Power Drift (dB)	Measured 1g SAR (W/kg)	Reported 1g SAR (W/kg)
	GSM 850-UAT	GPRS 4 Tx slots	Back	15	Full	128	824.2	28.97	29.00	1.007	-0.16	0.208	0.209
28	GSM 850-LAT	GPRS 4 Tx slots	Back	15	Full	128	824.2	28.97	29.00	1.007	0.02	0.219	0.221
	GSM1900-UAT	GPRS 4 Tx slots	Back	15	Full	661	1880	26.44	26.50	1.014	-0.04	0.121	0.123
29	GSM1900-LAT	GPRS 4 Tx slots	Back	15	Full	661	1880	26.44	26.50	1.014	0.02	0.398	0.404

<WCDMA SAR>

Plot No.	Band	Mode	Test Position	Gap (mm)	Power State	Ch.	Freq. (MHz)	Average Power (dBm)	Tune-Up Limit (dBm)	Tune-up Scaling Factor	Power Drift (dB)	Measured 1g SAR (W/kg)	Reported 1g SAR (W/kg)
	WCDMA II-UAT	RMC 12.2Kbps	Back	15	Full	9538	1907.6	24.08	24.50	1.102	-0.01	0.19	0.209
30	WCDMA II-LAT	RMC 12.2Kbps	Front	15	Full	9538	1907.6	23.85	24.50	1.161	-0.02	0.583	0.677
	WCDMA II-LAT	RMC 12.2Kbps	Back	15	Reduced	9538	1907.6	20.65	21.00	1.084	0.04	0.341	0.370
	WCDMA IV-UAT	RMC 12.2Kbps	Front	15	Full	1312	1712.4	24.23	24.50	1.064	0.03	0.147	0.156
31	WCDMA IV-LAT	RMC 12.2Kbps	Back	15	Full	1312	1712.4	24.23	24.50	1.064	-0.04	0.373	0.397
	WCDMA V-UAT	RMC 12.2Kbps	Back	15	Full	4132	826.4	24.12	24.50	1.091	-0.04	0.151	0.165
32	WCDMA V-LAT	RMC 12.2Kbps	Back	15	Full	4132	826.4	24.12	24.50	1.091	-0.03	0.202	0.220

<FDD LTE SAR>

Plot No.	Band	BW (MHz)	Modulation	RB Size	RB offset	Test Position	Gap (mm)	Power State	Ch.	Freq. (MHz)	Average Power (dBm)	Tune-Up Limit (dBm)	Tune-up Scaling Factor	Power Drift (dB)	Measured 1g SAR (W/kg)	Reported 1g SAR (W/kg)
	LTE Band 2-UAT	20M	QPSK	1	0	Back	15	Full	18900	1880	23.88	24.00	1.028	-0.01	0.112	0.115
33	LTE Band 2-LAT	20M	QPSK	1	0	Back	15	Full	18900	1880	23.88	24.00	1.028	-0.01	0.527	0.542
	LTE Band 4-UAT	20M	QPSK	1	0	Back	15	Full	20175	1732.5	23.74	24.00	1.062	-0.02	0.078	0.083
34	LTE Band 4-LAT	20M	QPSK	1	0	Back	15	Full	20175	1732.5	23.74	24.00	1.062	-0.02	0.299	0.317
	LTE Band 5-UAT	10M	QPSK	1	0	Back	15	Full	20525	836.5	23.77	24.00	1.054	-0.03	0.128	0.135
35	LTE Band 5-LAT	10M	QPSK	1	0	Back	15	Full	20525	836.5	23.77	24.00	1.054	0.07	0.148	0.156
	LTE Band 7-UAT	20M	QPSK	1	49	Back	15	Full	21350	2560	23.82	24.00	1.042	-0.06	0.193	0.201
36	LTE Band 7-LAT	20M	QPSK	1	49	Back	15	Full	21350	2560	23.82	24.00	1.042	0.09	0.440	0.459

<TDD LTE SAR>

Plot No.	Band	BW (MHz)	Modulation	RB Size	RB offset	Test Position	Gap (mm)	Power State	Ch.	Freq. (MHz)	Average Power (dBm)	Tune-Up Limit (dBm)	Tune-up Scaling Factor	Duty Cycle %	Duty Cycle Scaling Factor	Power Drift (dB)	Measured 1g SAR (W/kg)	Reported 1g SAR (W/kg)
	LTE Band 38-UAT	20M	QPSK	1	0	Back	15	Full	38000	2595	23.95	24.00	1.012	62.9	1.006	-0.04	0.102	0.104
37	LTE Band 38-LAT	20M	QPSK	1	0	Front	15	Full	38000	2595	23.95	24.00	1.012	62.9	1.006	0.02	0.174	0.177



<WLAN 2.4GHz SAR>

Plot No.	Band	Mode	Test Position	Gap (mm)	Antenna	Power State	Ch.	Freq. (MHz)	Average Power (dBm)	Tune-Up Limit (dBm)	Tune-up Scaling Factor	Duty Cycle %	Duty Cycle Scaling Factor	Power Drift (dB)	Measured 1g SAR (W/kg)	Reported 1g SAR (W/kg)
38	WLAN2.4GHz	802.11b 1Mbps	Back	15	1	Full	11	2462	16.50	17.00	1.122	99.05	1.010	-0.01	0.102	0.116
	WLAN2.4GHz	802.11b 1Mbps	Back	15	2	Full	11	2462	16.20	17.00	1.202	98.93	1.011	-0.02	0.095	0.115

<WLAN 5GHz SAR>

Plot No.	Band	Mode	Test Position	Gap (mm)	Antenna	Power State	Ch.	Freq. (MHz)	Average Power (dBm)	Tune-Up Limit (dBm)	Tune-up Scaling Factor	Duty Cycle %	Duty Cycle Scaling Factor	Power Drift (dB)	Measured 1g SAR (W/kg)	Reported 1g SAR (W/kg)
39	WLAN5.3GHz	802.11a 6Mbps	Back	15	1	Full	56	5280	16.27	17.00	1.183	96.19	1.040	-0.09	0.439	0.540
	WLAN5.3GHz	802.11a 6Mbps	Back	15	2	Full	52	5260	12.92	14.00	1.282	96.89	1.032	0.01	0.092	0.122
40	WLAN5.5GHz	802.11a 6Mbps	Back	15	1	Full	132	5660	15.89	16.50	1.151	96.19	1.040	-0.09	0.296	0.354
	WLAN5.5GHz	802.11a 6Mbps	Back	15	2	Full	100	5500	12.84	14.00	1.306	96.89	1.032	-0.08	0.098	0.132
41	WLAN5.8GHz	802.11a 6Mbps	Back	15	1	Full	149	5745	13.00	13.50	1.122	96.19	1.040	0.03	0.341	0.398
	WLAN5.8GHz	802.11a 6Mbps	Back	15	2	Full	149	5745	12.07	13.50	1.390	96.89	1.032	-0.09	0.043	0.062



15.4 Product Specific SAR

<GSM SAR>

Plot No.	Band	Mode	Test Position	Gap (mm)	Power State	Ch.	Freq. (MHz)	Average Power (dBm)	Tune-Up Limit (dBm)	Tune-up Scaling Factor	Power Drift (dB)	Measured 10g SAR (W/kg)	Reported 10g SAR (W/kg)
	GSM1900-LAT	GPRS 4 Tx slots	Bottom Side	0	Reduced	661	1880	23.95	24.50	1.135	0.01	2.400	2.724
	GSM1900-LAT	GPRS 4 Tx slots	Bottom Side	0	Reduced	512	1850.2	23.87	24.50	1.156	0.01	2.550	2.948
42	GSM1900-LAT	GPRS 4 Tx slots	Bottom Side	0	Reduced	810	1909.8	24.13	24.50	1.089	0.15	2.710	2.951

<WCDMA SAR>

Plot No.	Band	Mode	Test Position	Gap (mm)	Power State	Ch.	Freq. (MHz)	Average Power (dBm)	Tune-Up Limit (dBm)	Tune-up Scaling Factor	Power Drift (dB)	Measured 10g SAR (W/kg)	Reported 10g SAR (W/kg)
	WCDMA II-LAT	RMC 12.2Kbps	Bottom Side	0	Reduced	9538	1907.6	20.65	21.00	1.084	0.05	2.530	2.742
	WCDMA II-LAT	RMC 12.2Kbps	Bottom Side	0	Reduced	9262	1852.4	20.64	21.00	1.086	0.05	2.880	3.129
43	WCDMA II-LAT	RMC 12.2Kbps	Bottom Side	0	Reduced	9400	1880	20.36	21.00	1.159	0.07	2.790	3.233

<FDD LTE SAR>

Plot No.	Band	BW (MHz)	Modulation	RB Size	RB offset	Test Position	Gap (mm)	Power State	Ch.	Freq. (MHz)	Average Power (dBm)	Tune-Up Limit (dBm)	Tune-up Scaling Factor	Power Drift (dB)	Measured 10g SAR (W/kg)	Reported 10g SAR (W/kg)
	LTE Band 2-LAT	20M	QPSK	1	0	Bottom Side	0	Reduced	18900	1880	20.34	21.00	1.164	0.01	2.240	2.608
	LTE Band 2-LAT	20M	QPSK	1	0	Bottom Side	0	Reduced	18700	1860	20.20	21.00	1.202	0.01	2.250	2.705
	LTE Band 2-LAT	20M	QPSK	1	0	Bottom Side	0	Reduced	19100	1900	20.58	21.00	1.102	0.01	2.190	2.412
44	LTE Band 2-LAT	20M	QPSK	50	0	Bottom Side	0	Reduced	18900	1880	20.30	21.00	1.175	0.1	2.370	2.785
	LTE Band 2-LAT	20M	QPSK	50	0	Bottom Side	0	Reduced	18700	1860	20.42	21.00	1.143	0.03	2.320	2.651
	LTE Band 2-LAT	20M	QPSK	50	0	Bottom Side	0	Reduced	19100	1900	20.57	21.00	1.104	0.03	2.320	2.561
	LTE Band 2-LAT	20M	QPSK	100	0	Bottom Side	0	Reduced	19100	1900	20.48	21.00	1.127	0.03	2.260	2.547

<WLAN 5GHz SAR>

Plot No.	Band	Mode	Test Position	Gap (mm)	Antenna	Power State	Ch.	Freq. (MHz)	Average Power (dBm)	Tune-Up Limit (dBm)	Tune-up Scaling Factor	Duty Cycle %	Duty Cycle Scaling Factor	Power Drift (dB)	Measured 10g SAR (W/kg)	Reported 10g SAR (W/kg)
45	WLAN5.3GHz	802.11a 6Mbps	Back	0	1	Full	56	5280	16.27	17.00	1.183	96.19	1.040	-0.09	1.310	1.612
	WLAN5.3GHz	802.11a 6Mbps	Front	0	2	Full	52	5260	12.92	14.00	1.282	96.89	1.032	0	0.253	0.335
46	WLAN5.5GHz	802.11a 6Mbps	Back	0	1	Full	132	5660	15.89	16.50	1.151	96.19	1.040	0.01	1.100	1.317
	WLAN5.5GHz	802.11a 6Mbps	Front	0	2	Full	100	5500	12.84	14.00	1.306	96.89	1.032	0	0.229	0.309



15.5 Repeated SAR Measurement

<1g SAR>

No.	Band	BW (MHz)	Modulation	RB Size	RB offset	Mode	Test Position	Gap (mm)	Antenna	Power State	Ch.	Freq. (MHz)	Average Power (dBm)	Tune-Up Limit (dBm)	Tune-up Scaling Factor	Duty Cycle %	Duty Cycle Scaling Factor	Power Drift (dB)	Measured 1g SAR (W/kg)	Ratio	Reported 1g SAR (W/kg)
1st	GSM 850-UAT	-	-	-	-	GPRS 4 Tx slots	Left Cheek	0		Reduced	189	836.4	27.88	28.00	1.028		1.000	0.03	1.040	1	1.069
2nd	GSM 850-UAT	-	-	-	-	GPRS 4 Tx slots	Left Cheek	0		Reduced	189	836.4	27.88	28.00	1.028		1.000	0.09	1.010	1.030	1.038
1st	GSM1900-UAT	-	-	-	-	GPRS 4 Tx slots	Right Cheek	0		Reduced	512	1850.2	23.29	24.00	1.178		1.000	-0.01	0.963	1	1.134
2nd	GSM1900-UAT	-	-	-	-	GPRS 4 Tx slots	Right Cheek	0		Reduced	512	1850.2	23.29	24.00	1.178		1.000	0.04	0.951	1.013	1.120
1st	WCDMA IV-UAT	-	-	-	-	RMC 12.2Kbps	Bottom Side	10		Reduced	1413	1732.6	21.29	22.00	1.178		1.000	0.01	0.948	1	1.116
2nd	WCDMA IV-UAT	-	-	-	-	RMC 12.2Kbps	Bottom Side	10		Reduced	1413	1732.6	21.29	22.00	1.178		1.000	-0.02	0.931	1.018	1.096
1st	LTE Band 7-LAT	20M	QPSK	1	49	-	Bottom Side	10		Reduced	21350	2560	23.45	23.50	1.012		1.000	0.08	1.090	1	1.103
2nd	LTE Band 7-LAT	20M	QPSK	1	49	-	Bottom Side	10		Reduced	21350	2560	23.45	23.50	1.012		1.000	-0.02	1.070	1.019	1.082

<10g SAR>

No.	Band	BW (MHz)	Modulation	RB Size	RB offset	Mode	Test Position	Gap (mm)	Antenna	Power State	Ch.	Freq. (MHz)	Average Power (dBm)	Tune-Up Limit (dBm)	Tune-up Scaling Factor	Duty Cycle %	Duty Cycle Scaling Factor	Power Drift (dB)	Measured 10g SAR (W/kg)	Ratio	Reported 10g SAR (W/kg)
1st	WCDMA II-LAT	-	-	-	-	RMC 12.2Kbps	Bottom Side	0		Reduced	9262	1852.4	20.64	21.00	1.086		1.000	0.05	2.880	1	3.129
2nd	WCDMA II-LAT	-	-	-	-	RMC 12.2Kbps	Bottom Side	0		Reduced	9262	1852.4	20.64	21.00	1.086		1.000	-0.01	2.810	1.025	3.053

General Note:

1. Per KDB 865664 D01v01r04, for each frequency band, repeated SAR measurement is required only when the measured SAR is ≥ 0.8 W/kg.
2. Per KDB 865664 D01v01r04, if the extremity repeated SAR is necessary, the same procedures should be adapted for measurements according to extremity and occupational exposure limits by applying a factor of 2.5 for extremity exposure to the corresponding SAR thresholds.
3. The ratio is the difference in percentage between original and repeated *measured SAR*.
4. All measurement SAR result is scaled-up to account for tune-up tolerance and is compliant.

16. Simultaneous Transmission Analysis

No.	Simultaneous Transmission Configurations	Portable Handset			
		Head	Body-worn	Hotspot	Product specific
1.	GSM Voice + Bluetooth SISO	Yes	Yes		Yes
2.	GPRS/EDGE + Bluetooth SISO	Yes	Yes	Yes	Yes
3.	WCDMA + Bluetooth SISO	Yes	Yes	Yes	Yes
4.	LTE + Bluetooth SISO	Yes	Yes	Yes	Yes
5.	GSM Voice + 2.4GHz WLAN SISO	Yes	Yes		Yes
6.	GPRS/EDGE + 2.4GHz WLAN SISO	Yes	Yes	Yes	Yes
7.	WCDMA +2.4GHz WLAN SISO	Yes	Yes	Yes	Yes
8.	LTE + 2.4GHz WLAN SISO	Yes	Yes	Yes	Yes
9.	GSM Voice + WLAN5.3/5.5GHz SISO	Yes	Yes		Yes
10.	GPRS/EDGE + WLAN5.3/5.5GHz SISO	Yes	Yes		Yes
11.	WCDMA + WLAN5.3/5.5GHz SISO	Yes	Yes		Yes
12.	LTE + WLAN5.3/5.5GHz SISO	Yes	Yes		Yes
13.	GSM Voice + WLAN5.2/5.8GHz SISO	Yes	Yes		Yes
14.	GPRS/EDGE + WLAN5.2/5.8GHz SISO	Yes	Yes	Yes	Yes
15.	WCDMA + WLAN5.2/5.8GHz SISO	Yes	Yes	Yes	Yes
16.	LTE + WLAN5.2/5.8GHz SISO	Yes	Yes	Yes	Yes
17.	WLAN5GHz SISO+ Bluetooth SISO	Yes	Yes	Yes	Yes
18.	GSM Voice + Bluetooth SISO+ WLAN5.3/5.5GHz SISO	Yes	Yes		Yes
19.	GPRS/EDGE + Bluetooth SISO+ WLAN5.3/5.5GHz SISO	Yes	Yes		Yes
20.	WCDMA + Bluetooth SISO+ WLAN5.3/5.5GHz SISO	Yes	Yes		Yes
21.	LTE + Bluetooth SISO+ WLAN5.3/5.5GHz SISO	Yes	Yes		Yes
22.	GSM Voice + Bluetooth SISO+ WLAN5.2/5.8GHz SISO	Yes	Yes		Yes
23.	GPRS/EDGE + Bluetooth SISO+ WLAN5.2/5.8GHz SISO	Yes	Yes	Yes	Yes
24.	WCDMA + Bluetooth SISO+ WLAN5.2/5.8GHz SISO	Yes	Yes	Yes	Yes
25.	LTE + Bluetooth SISO+ WLAN5.2/5.8GHz SISO	Yes	Yes	Yes	Yes

General Note:

- This device supports VoIP in GPRS, EGPRS, WCDMA and LTE (e.g. for 3rd-party VoIP), and LTE supports VoLTE function.
- EUT will choose each GSM, WCDMA and LTE according to the network signal condition; therefore, they will not operate simultaneously at any moment.
- For simultaneously transmission SAR analysis, SAR values only considered which we did perform SAR testing on FA021902, and other test results were leverage from the parent model which referred to the test report number FA961001.
- This device WLAN 2.4GHz supports hotspot operation and Bluetooth support tethering applications.
- This device 2.4GHz WLAN/5.2GHz WLAN/5.8GHz WLAN support hotspot operation, and 5.2GHz WLAN/5.8GHz WLAN supports WiFi Direct (GC/GO), and 5.3GHz / 5.5GHz supports WiFi Direct (GC only).
- WLAN 2.4GHz and Bluetooth share the same antenna so can't transmit simultaneously.
- According to the character of EUT, WLAN5GHz and Bluetooth can transmit simultaneously.
- According to the character of EUT, WLAN5GHz and WLAN 2.4GHz can't transmit simultaneously.
- For simultaneously analysis, since the SAR summation of 3 transmitters can cover others combination of 2 transmitters, therefore in this section did not additional to evaluate 2TX combination of simultaneously transmission.
- All licensed modes share the same antenna part and cannot transmit simultaneously.
- The reported SAR summation is calculated based on the same configuration and test position
- Per KDB 447498 D01v06, simultaneous transmission SAR is compliant if,
 - 1g Scalar SAR summation < 1.6W/kg and 10g Scalar SAR summation < 4.0W/kg.
 - SPLSR = (SAR1 + SAR2)^1.5 / (min. separation distance, mm), and the peak separation distance is determined from the square root of [(x1-x2)² + (y1-y2)² + (z1-z2)²], where (x1, y1, z1) and (x2, y2, z2) are the coordinates of the extrapolated peak SAR locations in the zoom scan.
 - If SPLSR ≤ 0.04 for 1g SAR, SPLSR ≤ 0.10 for 10g SAR simultaneously transmission SAR measurement is not necessary.
 - Simultaneously transmission SAR measurement, and the reported multi-band 1g SAR < 1.6W/kg and 10g SAR <



- 4.0W/kg.
- v) For WWAN/Bluetooth product specific 10g stand-alone SAR is not required for a transmitter or antenna, due to 1g hotspot SAR is <1.2W/kg.
- vi) The SPLSR calculated results please refer to section 16.4.

16.1 Head Exposure Conditions

WWAN Band	Exposure Position	1	2	3	4	5	6	7	1+2	1+3	1+4+6	1+5+6	1+4+7	1+5+7		
		WWAN	2.4GHz WLAN Ant 1	2.4GHz WLAN Ant 2	5GHz WLAN Ant 1	5GHz WLAN Ant 2	Bluetooth Ant 1	Bluetooth Ant 2	Summed 1g SAR (W/kg)	Summed 1g SAR (W/kg)	Summed 1g SAR (W/kg)	Summed 1g SAR (W/kg)	Summed 1g SAR (W/kg)	Summed 1g SAR (W/kg)		
		1g SAR (W/kg)	1g SAR (W/kg)	1g SAR (W/kg)	1g SAR (W/kg)	1g SAR (W/kg)	Estimated 1g SAR (W/kg)	Estimated 1g SAR (W/kg)								
GSM	GSM 850-UAT	Right Cheek	0.952	0.297	0.449	0.318	0.233	0.037	0.037	1.25	1.40	1.31	1.22	1.31	1.22	
		Right Tilted	0.898	0.309	0.052	0.391	0.087	0.052	0.013	1.21	0.95	1.34	1.04	1.30	1.00	
		Left Cheek	1.069	0.452	0.131	0.404	0.105	0.081	0.02	1.52	1.20	1.55	1.26	1.49	1.19	
		Left Tilted	0.778	0.515	0.032	0.538	0.072	0.082	0.009	1.29	0.81	1.40	0.93	1.33	0.86	
	GSM 850-LAT	Right Cheek	0.255	0.297	0.449	0.318	0.233	0.037	0.037	0.55	0.70	0.61	0.53	0.61	0.53	
		Left Cheek	0.166	0.452	0.131	0.404	0.105	0.081	0.02	0.62	0.30	0.65	0.35	0.59	0.29	
		Left Tilted	0.091	0.515	0.032	0.538	0.072	0.082	0.009	0.61	0.12	0.71	0.25	0.64	0.17	
	GSM1900-UAT	Right Cheek	1.134	0.297	0.449	0.318	0.233	0.037	0.037	1.43	1.58	1.49	1.40	1.49	1.40	
		Right Tilted	0.532	0.309	0.052	0.391	0.087	0.052	0.013	0.84	0.58	0.98	0.67	0.94	0.63	
		Left Cheek	0.484	0.452	0.131	0.404	0.105	0.081	0.02	0.94	0.62	0.97	0.67	0.91	0.61	
		Left Tilted	0.295	0.515	0.032	0.538	0.072	0.082	0.009	0.81	0.33	0.92	0.45	0.84	0.38	
	GSM1900-LAT	Right Cheek	0.071	0.297	0.449	0.318	0.233	0.037	0.037	0.37	0.52	0.43	0.34	0.43	0.34	
		Left Cheek	0.063	0.452	0.131	0.404	0.105	0.081	0.02	0.52	0.19	0.55	0.25	0.49	0.19	
		Left Tilted	0.055	0.515	0.032	0.538	0.072	0.082	0.009	0.57	0.09	0.68	0.21	0.60	0.14	
	WCDMA	WCDMA II-UAT	Right Cheek	0.557	0.297	0.449	0.318	0.233	0.037	0.037	0.85	1.01	0.91	0.83	0.91	0.83
			Right Tilted	0.307	0.309	0.052	0.391	0.087	0.052	0.013	0.62	0.36	0.75	0.45	0.71	0.41
Left Cheek			0.304	0.452	0.131	0.404	0.105	0.081	0.02	0.76	0.44	0.79	0.49	0.73	0.43	
Left Tilted			0.174	0.515	0.032	0.538	0.072	0.082	0.009	0.69	0.21	0.79	0.33	0.72	0.26	
WCDMA II-LAT		Right Cheek	0.164	0.297	0.449	0.318	0.233	0.037	0.037	0.46	0.61	0.52	0.43	0.52	0.43	
		Left Cheek	0.103	0.452	0.131	0.404	0.105	0.081	0.02	0.56	0.23	0.59	0.29	0.53	0.23	
		Left Tilted	0.079	0.515	0.032	0.538	0.072	0.082	0.009	0.59	0.11	0.70	0.23	0.63	0.16	
WCDMA IV-UAT		Right Cheek	0.485	0.297	0.449	0.318	0.233	0.037	0.037	0.78	0.93	0.84	0.76	0.84	0.76	
		Right Tilted	0.397	0.309	0.052	0.391	0.087	0.052	0.013	0.71	0.45	0.84	0.54	0.80	0.50	
		Left Cheek	0.328	0.452	0.131	0.404	0.105	0.081	0.02	0.78	0.46	0.81	0.51	0.75	0.45	
		Left Tilted	0.215	0.515	0.032	0.538	0.072	0.082	0.009	0.73	0.25	0.84	0.37	0.76	0.30	
WCDMA IV-LAT		Right Cheek	0.077	0.297	0.449	0.318	0.233	0.037	0.037	0.37	0.53	0.43	0.35	0.43	0.35	
		Left Cheek	0.070	0.452	0.131	0.404	0.105	0.081	0.02	0.52	0.20	0.56	0.26	0.49	0.20	
		Left Tilted	0.049	0.515	0.032	0.538	0.072	0.082	0.009	0.56	0.08	0.67	0.20	0.60	0.13	
WCDMA V-UAT		Right Cheek	1.063	0.297	0.449	0.318	0.233	0.037	0.037	1.36	1.51	1.42	1.33	1.42	1.33	
		Right Tilted	1.123	0.309	0.052	0.391	0.087	0.052	0.013	1.43	1.18	1.57	1.26	1.53	1.22	
		Left Cheek	0.876	0.452	0.131	0.404	0.105	0.081	0.02	1.33	1.01	1.36	1.06	1.30	1.00	
		Left Tilted	0.743	0.515	0.032	0.538	0.072	0.082	0.009	1.26	0.78	1.36	0.90	1.29	0.82	
WCDMA V-LAT		Right Cheek	0.218	0.297	0.449	0.318	0.233	0.037	0.037	0.52	0.67	0.57	0.49	0.57	0.49	
		Left Cheek	0.132	0.452	0.131	0.404	0.105	0.081	0.02	0.58	0.26	0.62	0.32	0.56	0.26	
	Left Tilted	0.078	0.515	0.032	0.538	0.072	0.082	0.009	0.59	0.11	0.70	0.23	0.63	0.16		



WWAN Band	Exposure Position	1	2	3	4	5	6	7	1+2 Summed 1g SAR (W/kg)	1+3 Summed 1g SAR (W/kg)	1+4+6 Summed 1g SAR (W/kg)	1+5+6 Summed 1g SAR (W/kg)	1+4+7 Summed 1g SAR (W/kg)	1+5+7 Summed 1g SAR (W/kg)	
		WWAN	2.4GHz WLAN Ant 1	2.4GHz WLAN Ant 2	5GHz WLAN Ant 1	5GHz WLAN Ant 2	Bluetooth Ant 1	Bluetooth Ant 2							
		1g SAR (W/kg)	1g SAR (W/kg)	1g SAR (W/kg)	1g SAR (W/kg)	1g SAR (W/kg)	Estimated 1g SAR (W/kg)	Estimated 1g SAR (W/kg)							
LTE	LTE Band 2-UAT	Right Cheek	0.570	0.297	0.449	0.318	0.233	0.037	0.037	0.87	1.02	0.93	0.84	0.93	0.84
		Right Tilted	0.399	0.309	0.052	0.391	0.087	0.052	0.013	0.71	0.45	0.84	0.54	0.80	0.50
		Left Cheek	0.376	0.452	0.131	0.404	0.105	0.081	0.02	0.83	0.51	0.86	0.56	0.80	0.50
		Left Tilted	0.277	0.515	0.032	0.538	0.072	0.082	0.009	0.79	0.31	0.90	0.43	0.82	0.36
	LTE Band 2-LAT	Right Cheek	0.080	0.297	0.449	0.318	0.233	0.037	0.037	0.38	0.53	0.44	0.35	0.44	0.35
		Left Cheek	0.071	0.452	0.131	0.404	0.105	0.081	0.02	0.52	0.20	0.56	0.26	0.50	0.20
		Left Tilted	0.058	0.515	0.032	0.538	0.072	0.082	0.009	0.57	0.09	0.68	0.21	0.61	0.14
	LTE Band 4-UAT	Right Cheek	0.800	0.297	0.449	0.318	0.233	0.037	0.037	1.10	1.25	1.16	1.07	1.16	1.07
		Right Tilted	0.770	0.309	0.052	0.391	0.087	0.052	0.013	1.08	0.82	1.21	0.91	1.17	0.87
		Left Cheek	0.506	0.452	0.131	0.404	0.105	0.081	0.02	0.96	0.64	0.99	0.69	0.93	0.63
		Left Tilted	0.348	0.515	0.032	0.538	0.072	0.082	0.009	0.86	0.38	0.97	0.50	0.90	0.43
	LTE Band 4-LAT	Right Cheek	0.051	0.297	0.449	0.318	0.233	0.037	0.037	0.35	0.50	0.41	0.32	0.41	0.32
		Left Cheek	0.573	0.452	0.131	0.404	0.105	0.081	0.02	1.03	0.70	1.06	0.76	1.00	0.70
		Left Tilted	0.356	0.515	0.032	0.538	0.072	0.082	0.009	0.87	0.39	0.98	0.51	0.90	0.44
	LTE Band 5-UAT	Right Cheek	0.816	0.297	0.449	0.318	0.233	0.037	0.037	1.11	1.27	1.17	1.09	1.17	1.09
		Right Tilted	0.675	0.309	0.052	0.391	0.087	0.052	0.013	0.98	0.73	1.12	0.81	1.08	0.78
		Left Cheek	0.710	0.452	0.131	0.404	0.105	0.081	0.02	1.16	0.84	1.20	0.90	1.13	0.84
		Left Tilted	0.492	0.515	0.032	0.538	0.072	0.082	0.009	1.01	0.52	1.11	0.65	1.04	0.57
	LTE Band 5-LAT	Right Cheek	0.142	0.297	0.449	0.318	0.233	0.037	0.037	0.44	0.59	0.50	0.41	0.50	0.41
		Left Cheek	0.095	0.452	0.131	0.404	0.105	0.081	0.02	0.55	0.23	0.58	0.28	0.52	0.22
		Left Tilted	0.054	0.515	0.032	0.538	0.072	0.082	0.009	0.57	0.09	0.67	0.21	0.60	0.14
	LTE Band 7-UAT	Right Cheek	0.593	0.297	0.449	0.318	0.233	0.037	0.037	0.89	1.04	0.95	0.86	0.95	0.86
		Right Tilted	0.494	0.309	0.052	0.391	0.087	0.052	0.013	0.80	0.55	0.94	0.63	0.90	0.59
		Left Cheek	0.257	0.452	0.131	0.404	0.105	0.081	0.02	0.71	0.39	0.74	0.44	0.68	0.38
		Left Tilted	0.193	0.515	0.032	0.538	0.072	0.082	0.009	0.71	0.23	0.81	0.35	0.74	0.27
	LTE Band 7-LAT	Right Cheek	0.088	0.297	0.449	0.318	0.233	0.037	0.037	0.39	0.54	0.44	0.36	0.44	0.36
		Left Cheek	0.061	0.452	0.131	0.404	0.105	0.081	0.02	0.51	0.19	0.55	0.25	0.49	0.19
		Left Tilted	0.043	0.515	0.032	0.538	0.072	0.082	0.009	0.56	0.08	0.66	0.20	0.59	0.12
	LTE Band 38-UAT	Right Cheek	0.773	0.297	0.449	0.318	0.233	0.037	0.037	1.07	1.22	1.13	1.04	1.13	1.04
		Right Tilted	0.599	0.309	0.052	0.391	0.087	0.052	0.013	0.91	0.65	1.04	0.74	1.00	0.70
		Left Cheek	0.346	0.452	0.131	0.404	0.105	0.081	0.02	0.80	0.48	0.83	0.53	0.77	0.47
		Left Tilted	0.258	0.515	0.032	0.538	0.072	0.082	0.009	0.77	0.29	0.88	0.41	0.81	0.34
	LTE Band 38-LAT	Right Cheek	0.054	0.297	0.449	0.318	0.233	0.037	0.037	0.35	0.50	0.41	0.32	0.41	0.32
		Left Cheek	0.055	0.452	0.131	0.404	0.105	0.081	0.02	0.51	0.19	0.54	0.24	0.48	0.18
		Left Tilted	0.03	0.515	0.032	0.538	0.072	0.082	0.009	0.55	0.06	0.65	0.18	0.58	0.11



16.2 Hotspot Exposure Conditions

WWAN Band	Exposure Position	1	2	3	4	5	6	7	1+2 Summed 1g SAR (W/kg)	1+3 Summed 1g SAR (W/kg)	1+4+6			1+5+6 Summed 1g SAR (W/kg)	1+4+7			1+5+7 Summed 1g SAR (W/kg)
		WWAN	2.4GHz WLAN Ant 1	2.4GHz WLAN Ant 2	5GHz WLAN Ant 1	5GHz WLAN Ant 2	Bluetooth Ant 1	Bluetooth Ant 2			Summed 1g SAR (W/kg)	SPLSR	Case No		Summed 1g SAR (W/kg)	SPLSR	Case No	
		1g SAR (W/kg)	1g SAR (W/kg)	1g SAR (W/kg)	1g SAR (W/kg)	1g SAR (W/kg)	Estimated 1g SAR (W/kg)	Estimated 1g SAR (W/kg)										
GSM	GSM 850-UAT	Back	0.474	0.257	0.074	0.901	0.17	0.034	0.018	0.73	0.55	1.41		0.68	1.39		0.66	
		Left side	0.411		0.207		0.263		0.014	0.41	0.62	0.41		0.67	0.43		0.69	
		Top side	0.434	0.245		0.363		0.03		0.68	0.43	0.83		0.46	0.80		0.43	
	GSM 850-LAT	Back	0.366	0.257	0.074	0.901	0.17	0.034	0.018	0.62	0.44	1.30		0.57	1.29		0.55	
		Left side	0.142		0.207		0.263		0.014	0.14	0.35	0.14		0.41	0.16		0.42	
	GSM1900-UAT	Back	0.127	0.257	0.074	0.901	0.17	0.034	0.018	0.38	0.20	1.06		0.33	1.05		0.32	
		Left side	0.188		0.207		0.263		0.014	0.19	0.40	0.19		0.45	0.20		0.47	
		Top side	0.137	0.245		0.363		0.03		0.38	0.14	0.53		0.17	0.50		0.14	
	GSM1900-LAT	Front	0.368	0.152	0.054	0.127	0.083	0.018	0.012	0.52	0.42	0.51		0.47	0.51		0.46	
		Back	0.491	0.257	0.074	0.901	0.17	0.034	0.018	0.75	0.57	1.43		0.70	1.41		0.68	
		Left side	0.043		0.207		0.263		0.014	0.04	0.25	0.04		0.31	0.06		0.32	
		Right side	0.050	0.136		0.247		0.017		0.19	0.05	0.31		0.07	0.30		0.05	
		Bottom side	0.916							0.92	0.92	0.92		0.92	0.92		0.92	
	WCDMA	WCDMA II-UAT	Back	0.322	0.257	0.074	0.901	0.17	0.034	0.018	0.58	0.40	1.26		0.53	1.24		0.51
			Left side	0.326		0.207		0.263		0.014	0.33	0.53	0.33		0.59	0.34		0.60
Top side			0.288	0.245		0.363		0.03		0.53	0.29	0.68		0.32	0.65		0.29	
WCDMA II-LAT		Front	0.253	0.152	0.054	0.127	0.083	0.018	0.012	0.41	0.31	0.40		0.35	0.39		0.35	
		Back	0.383	0.257	0.074	0.901	0.17	0.034	0.018	0.64	0.46	1.32		0.59	1.30		0.57	
		Left side	0.028		0.207		0.263		0.014	0.03	0.24	0.03		0.29	0.04		0.31	
		Right side	0.039	0.136		0.247		0.017		0.18	0.04	0.30		0.06	0.29		0.04	
Bottom side		0.700							0.70	0.70	0.70		0.70	0.70		0.70		
WCDMA IV-UAT		Back	0.230	0.257	0.074	0.901	0.17	0.034	0.018	0.49	0.30	1.17		0.43	1.15		0.42	
		Left side	0.230		0.207		0.263		0.014	0.23	0.44	0.23		0.49	0.24		0.51	
		Top side	0.343	0.245		0.363		0.03		0.59	0.34	0.74		0.37	0.71		0.34	
WCDMA IV-LAT		Front	0.358	0.152	0.054	0.127	0.083	0.018	0.012	0.51	0.41	0.50		0.46	0.50		0.45	
		Back	0.540	0.257	0.074	0.901	0.17	0.034	0.018	0.80	0.61	1.48		0.74	1.46		0.73	
		Left side	0.077		0.207		0.263		0.014	0.08	0.28	0.08		0.34	0.09		0.35	
		Right side	0.069	0.136		0.247		0.017		0.21	0.07	0.33		0.09	0.32		0.07	
		Bottom side	1.116							1.12	1.12	1.12		1.12	1.12		1.12	
WCDMA V-UAT		Back	0.339	0.257	0.074	0.901	0.17	0.034	0.018	0.60	0.41	1.27		0.54	1.26		0.53	
		Left side	0.219		0.207		0.263		0.014	0.22	0.43	0.22		0.48	0.23		0.50	
		Top side	0.258	0.245		0.363		0.03		0.50	0.26	0.65		0.29	0.62		0.26	
WCDMA V-LAT		Back	0.315	0.257	0.074	0.901	0.17	0.034	0.018	0.57	0.39	1.25		0.52	1.23		0.50	
		Left side	0.072		0.207		0.263		0.014	0.07	0.28	0.07		0.34	0.09		0.35	
LTE		LTE Band 2-UAT	Back	0.242	0.257	0.074	0.901	0.17	0.034	0.018	0.50	0.32	1.18		0.45	1.16		0.43
			Left side	0.225		0.207		0.263		0.014	0.23	0.43	0.23		0.49	0.24		0.50
			Top side	0.243	0.245		0.363		0.03		0.49	0.24	0.64		0.27	0.61		0.24
	LTE Band 2-LAT	Front	0.277	0.152	0.054	0.127	0.083	0.018	0.012	0.43	0.33	0.42		0.38	0.42		0.37	
		Back	0.415	0.257	0.074	0.901	0.17	0.034	0.018	0.67	0.49	1.35		0.62	1.33		0.60	
		Left side	0.035		0.207		0.263		0.014	0.04	0.24	0.04		0.30	0.05		0.31	
		Right side	0.037	0.136		0.247		0.017		0.17	0.04	0.30		0.05	0.28		0.04	
		Bottom side	0.707							0.71	0.71	0.71		0.71	0.71		0.71	



WWAN Band	Exposure Position	1	2	3	4	5	6	7	1+2 Summed 1g SAR (W/kg)	1+3 Summed 1g SAR (W/kg)	1+4+6			1+4+7			1+5+7 Summed 1g SAR (W/kg)			
		WWAN	2.4GHz WLAN Ant 1	2.4GHz WLAN Ant 2	5GHz WLAN Ant 1	5GHz WLAN Ant 2	Bluetooth Ant 1	Bluetooth Ant 2			Summed 1g SAR (W/kg)	SPLSR	Case No	Summed 1g SAR (W/kg)	SPLSR	Case No				
		1g SAR (W/kg)	1g SAR (W/kg)	1g SAR (W/kg)	1g SAR (W/kg)	1g SAR (W/kg)	Estimated 1g SAR (W/kg)	Estimated 1g SAR (W/kg)												
LTE	LTE Band 4-UAT	Back	0.209	0.257	0.074	0.901	0.17	0.034	0.018	0.47	0.28	1.14			0.41	1.13			0.40	
		Left side	0.166		0.207		0.263			0.014	0.17	0.37	0.17			0.43	0.18			0.44
		Top side	0.269	0.245		0.363		0.03			0.51	0.27	0.66			0.30	0.63			0.27
	LTE Band 4-LAT	Front	0.277	0.152	0.054	0.127	0.083	0.018	0.012	0.43	0.33	0.42			0.38	0.42			0.37	
		Back	0.461	0.257	0.074	0.901	0.17	0.034	0.018	0.72	0.54	1.40			0.67	1.38			0.65	
		Left side	0.063		0.207		0.263			0.014	0.06	0.27	0.06			0.33	0.08			0.34
		Right side	0.062	0.136		0.247		0.017			0.20	0.06	0.33			0.08	0.31			0.06
	Bottom side	0.887								0.89	0.89	0.89			0.89	0.89			0.89	
	LTE Band 5-UAT	Back	0.251	0.257	0.074	0.901	0.17	0.034	0.018	0.51	0.33	1.19			0.46	1.17			0.44	
		Left side	0.157		0.207		0.263		0.014	0.16	0.36	0.16			0.42	0.17			0.43	
		Top side	0.220	0.245		0.363		0.03		0.47	0.22	0.61			0.25	0.58			0.22	
	LTE Band 5-LAT	Back	0.236	0.257	0.074	0.901	0.17	0.034	0.018	0.49	0.31	1.17			0.44	1.16			0.42	
		Left side	0.060		0.207		0.263		0.014	0.06	0.27	0.06			0.32	0.07			0.34	
	LTE Band 7-UAT	Back	0.346	0.257	0.074	0.901	0.17	0.034	0.018	0.60	0.42	1.28			0.55	1.27			0.53	
		Left side	0.698		0.207		0.263		0.014	0.70	0.91	0.70			0.96	0.71			0.98	
		Top side	0.183	0.245		0.363		0.03		0.43	0.18	0.58			0.21	0.55			0.18	
	LTE Band 7-LAT	Front	0.513	0.152	0.054	0.127	0.083	0.018	0.012	0.67	0.57	0.66			0.61	0.65			0.61	
		Back	0.826	0.257	0.074	0.901	0.17	0.034	0.018	1.08	0.90	1.76	0.02	#01	1.03	1.75	0.02	#02	1.01	
		Left side	0.355		0.207		0.263		0.014	0.36	0.56	0.36			0.62	0.37			0.63	
		Right side	0.132	0.136		0.247		0.017		0.27	0.13	0.40			0.15	0.38			0.13	
		Bottom side	1.103							1.10	1.10	1.10			1.10	1.10			1.10	
	LTE Band 38-UAT	Back	0.191	0.257	0.074	0.901	0.17	0.034	0.018	0.45	0.27	1.13			0.40	1.11			0.38	
		Left side	0.349		0.207		0.263		0.014	0.35	0.56	0.35			0.61	0.36			0.63	
		Top side	0.099	0.245		0.363		0.03		0.34	0.10	0.49			0.13	0.46			0.10	
	LTE Band 38-LAT	Back	0.416	0.257	0.074	0.901	0.17	0.034	0.018	0.67	0.49	1.35			0.62	1.34			0.60	
		Left side	0.241		0.207		0.263		0.014	0.24	0.45	0.24			0.50	0.26			0.52	



16.3 Body-Worn Accessory Exposure Conditions

WWAN Band	Exposure Position	1	2	3	4	5	6	7	1+2 Summed 1g SAR (W/kg)	1+3 Summed 1g SAR (W/kg)	1+4+6 Summed 1g SAR (W/kg)	1+5+6 Summed 1g SAR (W/kg)	1+4+7 Summed 1g SAR (W/kg)	1+5+7 Summed 1g SAR (W/kg)	
		WWAN 1g SAR (W/kg)	2.4GHz WLAN Ant 1 1g SAR (W/kg)	2.4GHz WLAN Ant 2 1g SAR (W/kg)	5GHz WLAN Ant 1 1g SAR (W/kg)	5GHz WLAN Ant 2 1g SAR (W/kg)	Bluetooth Ant 1 Estimated 1g SAR (W/kg)	Bluetooth Ant 2 Estimated 1g SAR (W/kg)							
GSM	GSM 850-UAT	Back	0.209	0.116	0.115	0.540	0.132	0.020	0.015	0.33	0.32	0.77	0.36	0.76	0.36
	GSM 850-LAT	Back	0.221	0.116	0.115	0.540	0.132	0.020	0.015	0.34	0.34	0.78	0.37	0.78	0.37
	GSM1900-UAT	Back	0.123	0.116	0.115	0.540	0.132	0.020	0.015	0.24	0.24	0.68	0.28	0.68	0.27
	GSM1900-LAT	Back	0.404	0.116	0.115	0.540	0.132	0.020	0.015	0.52	0.52	0.96	0.56	0.96	0.55
WCDMA	WCDMA II-UAT	Back	0.209	0.116	0.115	0.540	0.132	0.020	0.015	0.33	0.32	0.77	0.36	0.76	0.36
		Front	0.677	0.069	0.057	0.099	0.059	0.017	0.011	0.75	0.73	0.79	0.75	0.79	0.75
	WCDMA II-LAT	Back	0.370	0.116	0.115	0.540	0.132	0.020	0.015	0.49	0.49	0.93	0.52	0.93	0.52
		Front	0.156	0.069	0.057	0.099	0.059	0.017	0.011	0.23	0.21	0.27	0.23	0.27	0.23
	WCDMA IV-UAT	Back	0.114	0.116	0.115	0.540	0.132	0.020	0.015	0.23	0.23	0.67	0.27	0.67	0.26
		Back	0.397	0.116	0.115	0.540	0.132	0.020	0.015	0.51	0.51	0.96	0.55	0.95	0.54
	WCDMA V-UAT	Back	0.165	0.116	0.115	0.540	0.132	0.020	0.015	0.28	0.28	0.73	0.32	0.72	0.31
	WCDMA V-LAT	Back	0.220	0.116	0.115	0.540	0.132	0.020	0.015	0.34	0.34	0.78	0.37	0.78	0.37
LTE	LTE Band 2-UAT	Back	0.115	0.116	0.115	0.540	0.132	0.02	0.015	0.23	0.23	0.68	0.27	0.67	0.26
	LTE Band 2-LAT	Back	0.542	0.116	0.115	0.540	0.132	0.020	0.015	0.66	0.66	1.10	0.69	1.10	0.69
	LTE Band 4-UAT	Back	0.083	0.116	0.115	0.540	0.132	0.020	0.015	0.20	0.20	0.64	0.24	0.64	0.23
	LTE Band 4-LAT	Back	0.317	0.116	0.115	0.540	0.132	0.020	0.015	0.43	0.43	0.88	0.47	0.87	0.46
	LTE Band 5-UAT	Back	0.135	0.116	0.115	0.540	0.132	0.020	0.015	0.25	0.25	0.70	0.29	0.69	0.28
	LTE Band 5-LAT	Back	0.156	0.116	0.115	0.540	0.132	0.020	0.015	0.27	0.27	0.72	0.31	0.71	0.30
	LTE Band 7-UAT	Back	0.201	0.116	0.115	0.540	0.132	0.020	0.015	0.32	0.32	0.76	0.35	0.76	0.35
	LTE Band 7-LAT	Back	0.459	0.116	0.115	0.540	0.132	0.020	0.015	0.58	0.57	1.02	0.61	1.01	0.61
	LTE Band 38-UAT	Back	0.104	0.116	0.115	0.540	0.132	0.020	0.015	0.22	0.22	0.66	0.26	0.66	0.25
	LTE Band 38-LAT	Front	0.177	0.069	0.057	0.099	0.059	0.017	0.011	0.25	0.23	0.29	0.25	0.29	0.25
Back		0.269	0.116	0.115	0.540	0.132	0.020	0.015	0.39	0.38	0.83	0.42	0.82	0.42	



16.4 Product specific 10g SAR Exposure Conditions

<Bottom Antenna>

WWAN Band		Exposure Position	1	2	3	1+2 Summed 10g SAR (W/kg)	1+3 Summed 10g SAR (W/kg)
			WWAN	5GHz WLAN Ant.1	5GHz WLAN Ant.2		
			10g SAR (W/kg)	10g SAR (W/kg)	10g SAR (W/kg)		
GSM	GSM1900	Bottom side	2.951			2.95	2.95
WCDMA	Band II	Bottom side	3.233			3.23	3.23
LTE	Band 2	Bottom side	2.785			2.79	2.79

Remark:

For Bluetooth Product specific 10g stand-alone SAR is not required for a transmitter or antenna, due to 1g hotspot SAR is <1.2W/kg.

16.5 SPLSR Evaluation and Analysis

General Note:

1. When standalone SAR is measured for both antennas in the pair, the peak location separation distance is computed by the square root of $[(x1-x2)^2 + (y1-y2)^2 + (z1-z2)^2]$, where (x1, y1, z1) and (x2, y2, z2) are the coordinates in the area scans or extrapolated peak SAR locations in the zoom scans, as appropriate.
2. $SPLSR = (SAR1 + SAR2)1.5 / (\text{min. separation distance, mm})$. If $SPLSR \leq 0.04$ for 1g SAR and $SPLSR \leq 0.10$ for 10g SAR, simultaneously transmission SAR measurement is not necessary.

Case 01	Band	Position	SAR (W/kg)	Gap (mm)	SAR peak location (mm)			3D distance (mm)	Summed SAR (W/kg)	SPLSR Results	Simultaneous SAR
					X	Y	Z				
Case 01	LTE Band 7-LAT	Back	0.826	10	-24.2	-64.8	1.78	134.6	1.76	0.02	Not required
	WLAN5GHz Ant1		0.901	10	-28.2	64	0.92				
	Bluetooth Ant1		0.034	10	-26.2	69.8	1.31				
Case 01	LTE Band 7-LAT	Back	0.826	10	-24.2	-64.8	1.78	128.9	1.76	0.02	Not required
	Bluetooth Ant1		0.034	10	-26.2	69.8	1.31				
	WLAN5GHz Ant1		0.901	10	-28.2	64	0.92				

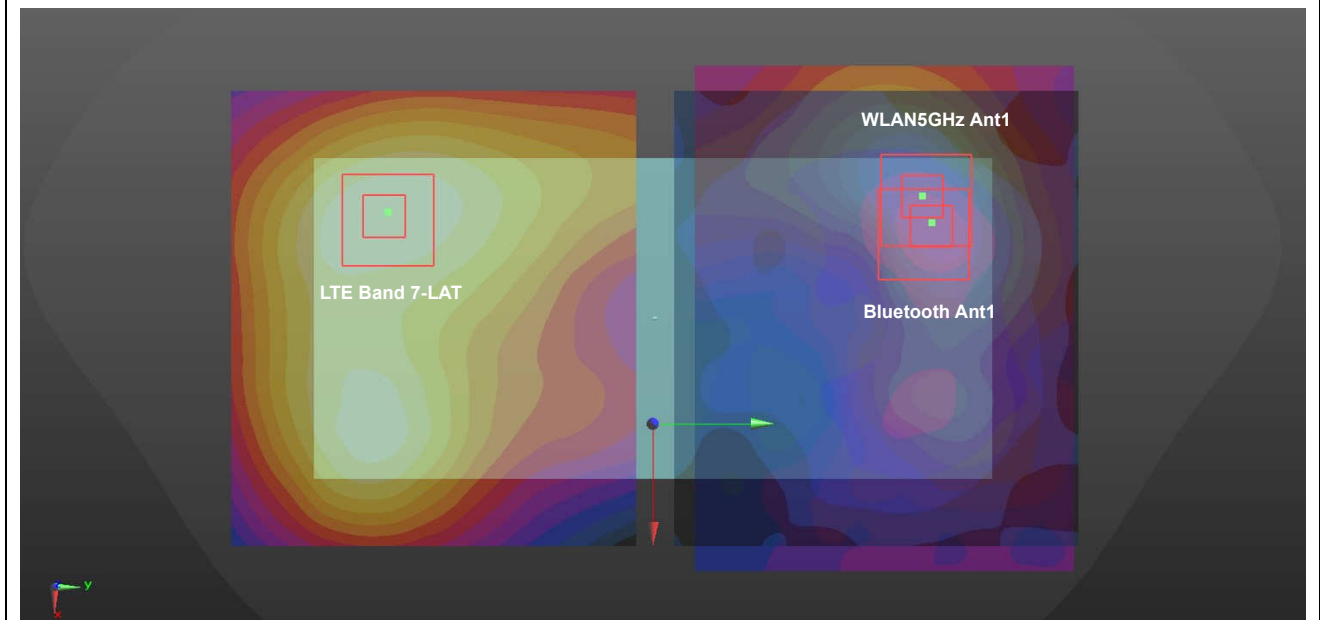

Case 02	Band	Position	SAR (W/kg)	Gap (mm)	SAR peak location (mm)			3D distance (mm)	Summed SAR (W/kg)	SPLSR Results	Simultaneous SAR
					X	Y	Z				
Case 02	LTE Band 7-LAT	Back	0.826	10	-24.2	-64.8	1.78	123.5	0.84	0.01	Not required
	Bluetooth Ant2		0.018	10	35.6	43.2	1.89				
	LTE Band 7-LAT	Back	0.826	10	-24.2	-64.8	1.78	128.9	1.73	0.02	Not required
	WLAN5GHz Ant1		0.901	10	-28.2	64	0.92				
	Bluetooth Ant2	Back	0.018	10	35.6	43.2	1.89	67.1	0.92	0.01	Not required
	WLAN5GHz Ant1		0.901	10	-28.2	64	0.92				

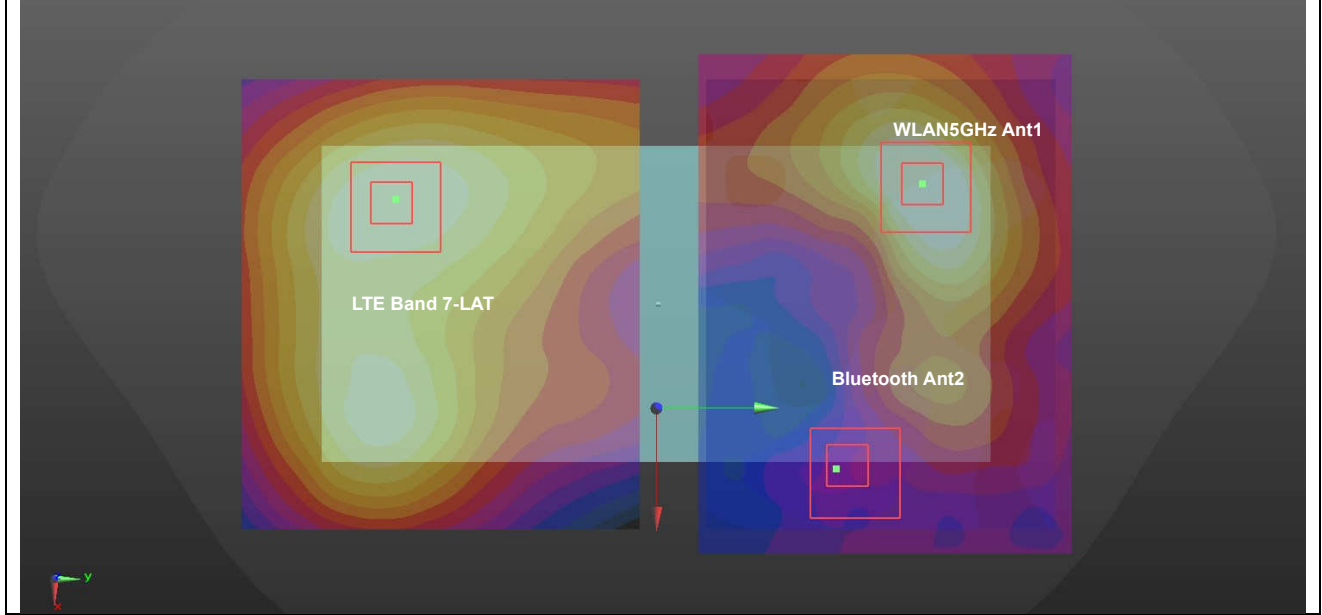

Test Engineer : Nick Hu, Yuan Zhao, Jiaying Chang, Yuankai Kong



17. Uncertainty Assessment

Per KDB 865664 D01 SAR measurement 100MHz to 6GHz, when the highest measured 1-g SAR within a frequency band is < 1.5 W/kg and the measured 10-g SAR within a frequency band is < 3.75 W/kg. The expanded SAR measurement uncertainty must be $\leq 30\%$, for a confidence interval of $k = 2$. If these conditions are met, extensive SAR measurement uncertainty analysis described in IEEE Std 1528-2013 is not required in SAR reports submitted for equipment approval. For this device, the highest measured 1-g SAR is less 1.5W/kg and highest measured 10-g SAR is less 3.75W/kg. Therefore, the measurement uncertainty table is not required in this report.



18. References

- [1] FCC 47 CFR Part 2 “Frequency Allocations and Radio Treaty Matters; General Rules and Regulations”
- [2] ANSI/IEEE Std. C95.1-1992, “IEEE Standard for Safety Levels with Respect to Human Exposure to Radio Frequency Electromagnetic Fields, 3 kHz to 300 GHz”, September 1992
- [3] IEEE Std. 1528-2013, “IEEE Recommended Practice for Determining the Peak Spatial-Average Specific Absorption Rate (SAR) in the Human Head from Wireless Communications Devices: Measurement Techniques”, Sep 2013
- [4] SPEAG DASY System Handbook
- [5] FCC KDB 865664 D01 v01r04, "SAR Measurement Requirements for 100 MHz to 6 GHz", Aug 2015.
- [6] FCC KDB 865664 D02 v01r02, “RF Exposure Compliance Reporting and Documentation Considerations” Oct 2015.
- [7] FCC KDB 248227 D01 v02r02, “SAR Guidance for IEEE 802.11 (WiFi) Transmitters”, Oct 2015.
- [8] FCC KDB 447498 D01 v06, “Mobile and Portable Device RF Exposure Procedures and Equipment Authorization Policies”, Oct 2015
- [9] FCC KDB 648474 D04 v01r03, “SAR Evaluation Considerations for Wireless Handsets”, Oct 2015.
- [10] FCC KDB 941225 D01 v03r01, “3G SAR MEAUREMENT PROCEDURES”, Oct 2015
- [11] FCC KDB 941225 D05 v02r05, “SAR Evaluation Considerations for LTE Devices”, Dec 2015
- [12] FCC KDB 941225 D05A v01r02, “Rel. 10 LTE SAR Test Guidance and KDB Inquiries”, Oct 2015
- [13] FCC KDB 941225 D06 v02r01, "SAR Evaluation Procedures for Portable Devices with Wireless Router Capabilities", Oct 2015.
- [14] FCC KDB 616217 D04 v01r02, “SAR Evaluation Considerations for Laptop, Notebook, Netbook and Tablet Computers”, Oct 2015



Appendix A. Plots of System Performance Check

The plots are shown as follows.

System Check_Head_835MHz

DUT: D835V2 - SN:4d151

Communication System: UID 0, CW (0); Frequency: 835 MHz; Duty Cycle: 1:1
Medium: HSL_850 Medium parameters used: $f = 835 \text{ MHz}$; $\sigma = 0.911 \text{ S/m}$; $\epsilon_r = 42.724$; $\rho = 1000 \text{ kg/m}^3$
Ambient Temperature : $23.5 \text{ }^\circ\text{C}$; Liquid Temperature : $22.8 \text{ }^\circ\text{C}$

DASY5 Configuration:

- Probe: ES3DV3 - SN3279; ConvF(6.38, 6.38, 6.38); Calibrated: 2019.3.4
- Sensor-Surface: 3mm (Mechanical Surface Detection)
- Electronics: DAE4 Sn1358; Calibrated: 2019.4.17
- Phantom: SAM1; Type: SAM; Serial: TP-1697
- Measurement SW: DASY52, Version 52.10 (1); SEMCAD X Version 14.6.11 (7439)

Pin=250mW/Area Scan (61x61x1): Interpolated grid: $dx=1.500 \text{ mm}$, $dy=1.500 \text{ mm}$
Maximum value of SAR (interpolated) = 3.52 W/kg

Pin=250mW/Zoom Scan (5x5x7)/Cube 0: Measurement grid: $dx=8\text{mm}$, $dy=8\text{mm}$, $dz=5\text{mm}$
Reference Value = 62.41 V/m ; Power Drift = 0.05 dB
Peak SAR (extrapolated) = 4.17 W/kg
SAR(1 g) = 2.48 W/kg ; SAR(10 g) = 1.54 W/kg
Maximum value of SAR (measured) = 3.55 W/kg

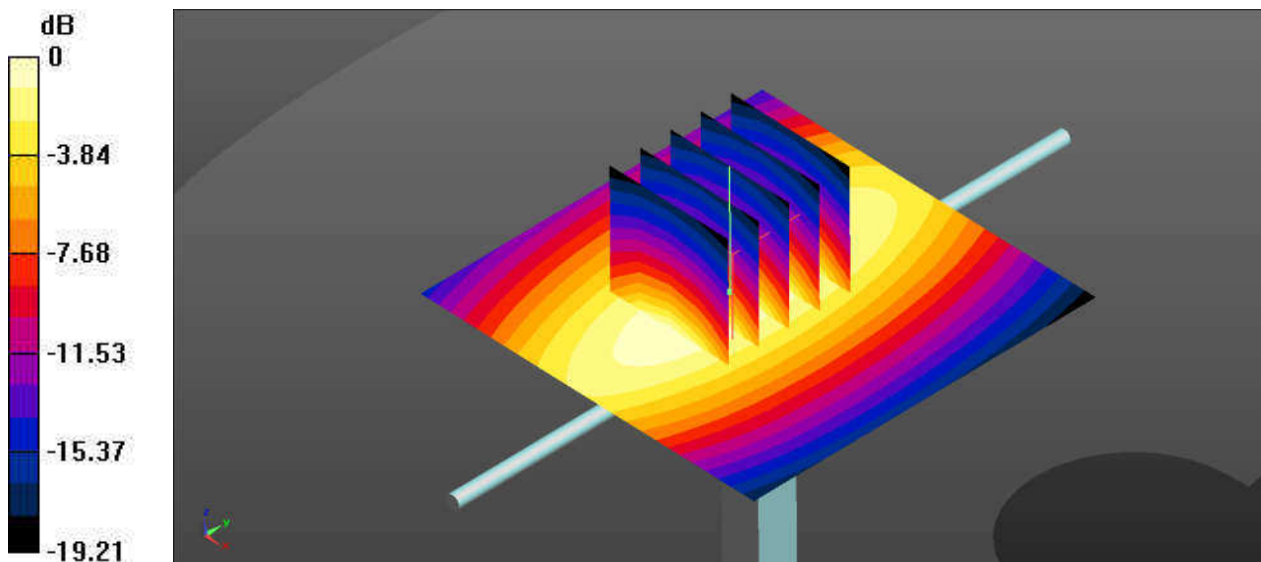

0 dB = $3.52 \text{ W/kg} = 5.47 \text{ dBW/kg}$

System Check_Head_1750MHz

DUT: D1750V2 - SN:1090

Communication System: UID 0, CW (0); Frequency: 1750 MHz; Duty Cycle: 1:1
Medium: HSL_1750 Medium parameters used: $f = 1750$ MHz; $\sigma = 1.343$ S/m; $\epsilon_r = 38.54$; $\rho = 1000$ kg/m³
Ambient Temperature : 23.5 °C ; Liquid Temperature : 22.7 °C

DASY5 Configuration:

- Probe: ES3DV3 - SN3279; ConvF(5.59, 5.59, 5.59); Calibrated: 2019.3.4
- Sensor-Surface: 3mm (Mechanical Surface Detection)
- Electronics: DAE4 Sn1358; Calibrated: 2019.4.17
- Phantom: SAM1; Type: SAM; Serial: TP-1697
- Measurement SW: DASY52, Version 52.10 (1); SEMCAD X Version 14.6.11 (7439)

Pin=250mW/Area Scan (61x61x1): Interpolated grid: dx=1.500 mm, dy=1.500 mm
Maximum value of SAR (interpolated) = 14.9 W/kg

Pin=250mW/Zoom Scan (5x5x7)/Cube 0: Measurement grid: dx=8mm, dy=8mm, dz=5mm
Reference Value = 107.8 V/m; Power Drift = -0.02 dB
Peak SAR (extrapolated) = 17.4 W/kg
SAR(1 g) = 9.55 W/kg; SAR(10 g) = 5.17 W/kg
Maximum value of SAR (measured) = 14.5 W/kg

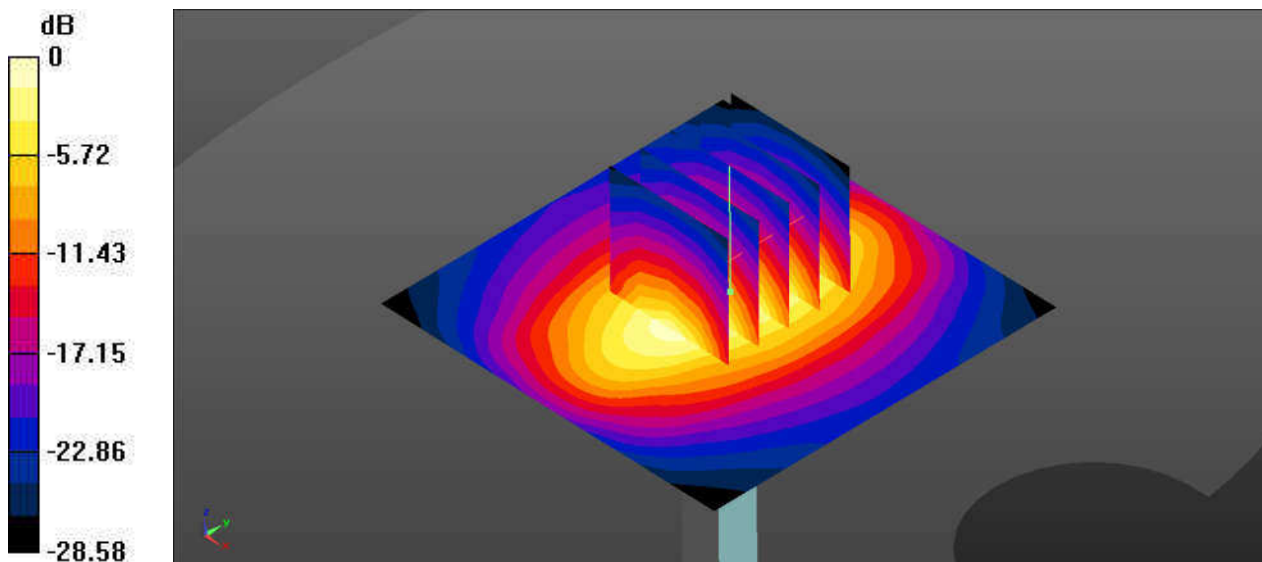

0 dB = 14.9 W/kg = 11.73 dBW/kg

System Check_Head_1900MHz

DUT: D1900V2 - SN:5d170

Communication System: UID 0, CW (0); Frequency: 1900 MHz; Duty Cycle: 1:1
Medium: HSL_1900 Medium parameters used: $f = 1900$ MHz; $\sigma = 1.389$ S/m; $\epsilon_r = 41.478$; $\rho = 1000$ kg/m³
Ambient Temperature : 23.5 °C ; Liquid Temperature : 22.7 °C

DASY5 Configuration:

- Probe: ES3DV3 - SN3279; ConvF(5.35, 5.35, 5.35); Calibrated: 2019.3.4
- Sensor-Surface: 3mm (Mechanical Surface Detection)
- Electronics: DAE4 Sn1358; Calibrated: 2019.4.17
- Phantom: SAM1; Type: SAM; Serial: TP-1697
- Measurement SW: DASY52, Version 52.10 (1); SEMCAD X Version 14.6.11 (7439)

Pin=250mW/Area Scan (61x61x1): Interpolated grid: dx=1.500 mm, dy=1.500 mm
Maximum value of SAR (interpolated) = 13.4 W/kg

Pin=250mW/Zoom Scan (5x5x7)/Cube 0: Measurement grid: dx=8mm, dy=8mm, dz=5mm
Reference Value = 82.95 V/m; Power Drift = 0.13 dB
Peak SAR (extrapolated) = 16.7 W/kg
SAR(1 g) = 9.34 W/kg; SAR(10 g) = 5 W/kg
Maximum value of SAR (measured) = 13.1 W/kg

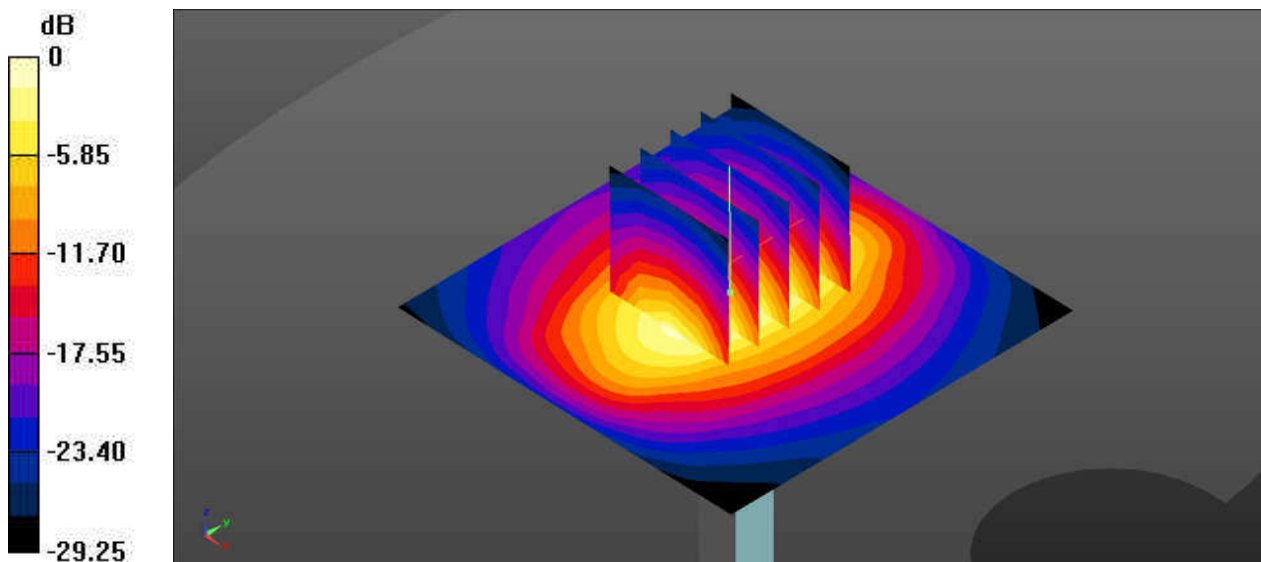

0 dB = 13.4 W/kg = 11.27 dBW/kg

System Check_Head_2450MHz

DUT: D2450V2 - SN:908

Communication System: UID 0, CW (0); Frequency: 2450 MHz; Duty Cycle: 1:1

Medium: HSL_2450 Medium parameters used: $f = 2450$ MHz; $\sigma = 1.86$ S/m; $\epsilon_r = 38.535$; $\rho = 1000$ kg/m³

Ambient Temperature : 23.3 °C; Liquid Temperature : 22.7 °C

DASY5 Configuration:

- Probe: ES3DV3 - SN3279; ConvF(4.77, 4.77, 4.77); Calibrated: 2019.3.4
- Sensor-Surface: 3mm (Mechanical Surface Detection)
- Electronics: DAE4 Sn1358; Calibrated: 2019.4.17
- Phantom: SAM1; Type: SAM; Serial: TP-1697
- Measurement SW: DASY52, Version 52.10 (1); SEMCAD X Version 14.6.11 (7439)

Pin=250mW/Area Scan (71x71x1): Interpolated grid: dx=1.200 mm, dy=1.200 mm

Maximum value of SAR (interpolated) = 20.5 W/kg

Pin=250mW/Zoom Scan (7x7x7)/Cube 0: Measurement grid: dx=5mm, dy=5mm, dz=5mm

Reference Value = 83.43 V/m; Power Drift = 0.09 dB

Peak SAR (extrapolated) = 27.3 W/kg

SAR(1 g) = 13 W/kg; SAR(10 g) = 5.93 W/kg

Maximum value of SAR (measured) = 20.0 W/kg

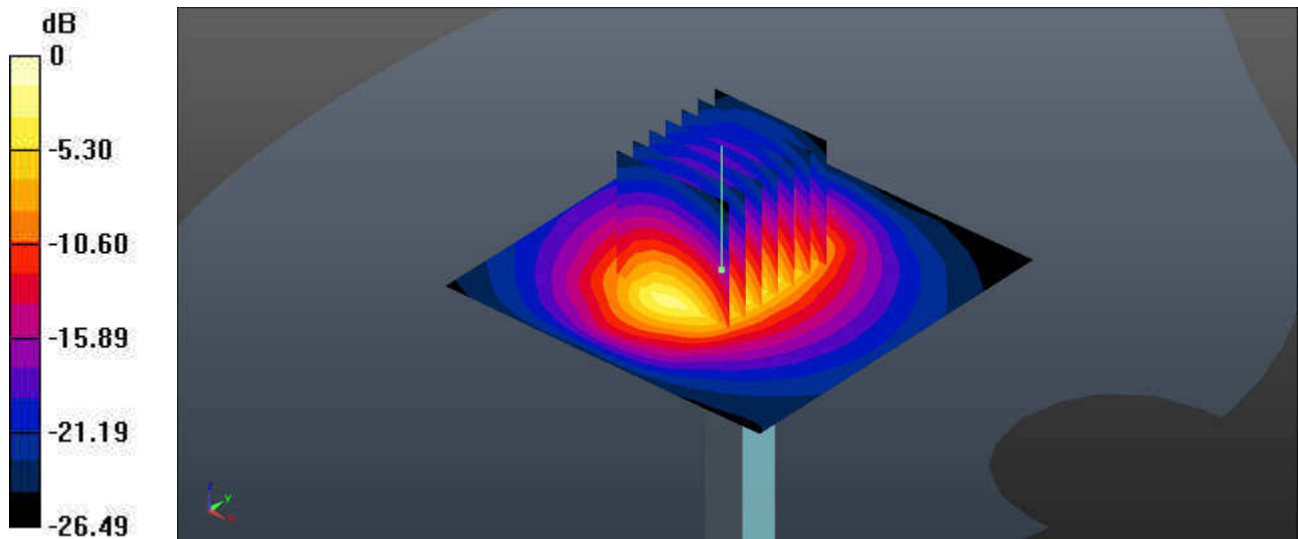

0 dB = 20.5 W/kg = 13.12 dBW/kg

System Check_Head_2600MHz

DUT: D2600V2 - SN:1078

Communication System: UID 0, CW (0); Frequency: 2600 MHz; Duty Cycle: 1:1
Medium: HSL_2600 Medium parameters used: $f = 2600$ MHz; $\sigma = 2.051$ S/m; $\epsilon_r = 40.175$; $\rho = 1000$ kg/m³
Ambient Temperature : 23.4 °C ; Liquid Temperature : 22.8 °C

DASY5 Configuration:

- Probe: ES3DV3 - SN3279; ConvF(4.58, 4.58, 4.58); Calibrated: 2019.3.4
- Sensor-Surface: 3mm (Mechanical Surface Detection)
- Electronics: DAE4 Sn1358; Calibrated: 2019.4.17
- Phantom: SAM1; Type: SAM; Serial: TP-1697
- Measurement SW: DASY52, Version 52.10 (1); SEMCAD X Version 14.6.11 (7439)

Pin=250mW/Area Scan (71x71x1): Interpolated grid: dx=1.200 mm, dy=1.200 mm

Maximum value of SAR (interpolated) = 22.5 W/kg

Pin=250mW/Zoom Scan (7x7x7)/Cube 0: Measurement grid: dx=5mm, dy=5mm, dz=5mm

Reference Value = 75.52 V/m; Power Drift = 0.19 dB

Peak SAR (extrapolated) = 30.7 W/kg

SAR(1 g) = 13.7 W/kg; SAR(10 g) = 5.98 W/kg

Maximum value of SAR (measured) = 21.9 W/kg

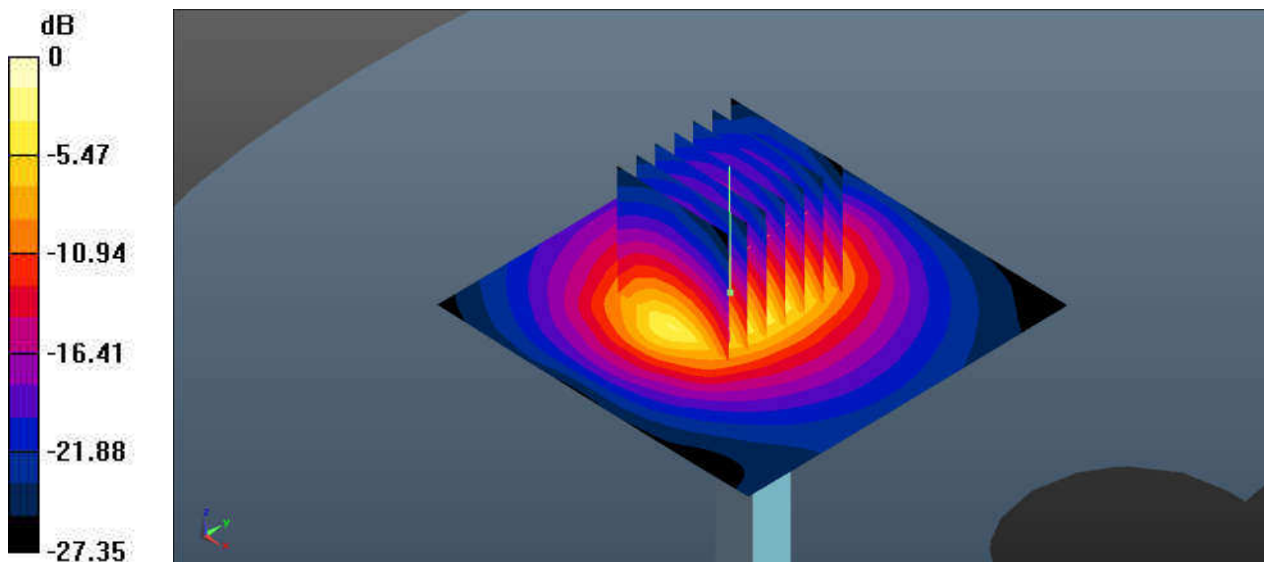

0 dB = 22.5 W/kg = 13.52 dBW/kg

System Check_Head_5250MHz

DUT: D5GHzV2 - SN:1113

Communication System: UID 0, CW (0); Frequency: 5250 MHz; Duty Cycle: 1:1

Medium: HSL_5000 Medium parameters used: $f = 5250 \text{ MHz}$; $\sigma = 4.595 \text{ S/m}$; $\epsilon_r = 36.402$; $\rho = 1000 \text{ kg/m}^3$

Ambient Temperature : $23.2 \text{ }^\circ\text{C}$; Liquid Temperature : $22.9 \text{ }^\circ\text{C}$

DASY5 Configuration:

- Probe: EX3DV4 - SN3857; ConvF(5.19, 5.19, 5.19); Calibrated: 2019.5.27
- Sensor-Surface: 1.4mm (Mechanical Surface Detection)
- Electronics: DAE4 Sn1358; Calibrated: 2019.4.17
- Phantom: SAM1; Type: SAM; Serial: TP-1697
- Measurement SW: DASY52, Version 52.10 (1); SEMCAD X Version 14.6.11 (7439)

Pin=100mW/Area Scan (71x71x1): Interpolated grid: $dx=1.000 \text{ mm}$, $dy=1.000 \text{ mm}$

Maximum value of SAR (interpolated) = 18.7 W/kg

Pin=100mW/Zoom Scan (8x8x7)/Cube 0: Measurement grid: $dx=4\text{mm}$, $dy=4\text{mm}$, $dz=1.4\text{mm}$

Reference Value = 40.92 V/m ; Power Drift = 0.17 dB

Peak SAR (extrapolated) = 32.4 W/kg

SAR(1 g) = 7.6 W/kg ; SAR(10 g) = 2.14 W/kg

Maximum value of SAR (measured) = 18.7 W/kg

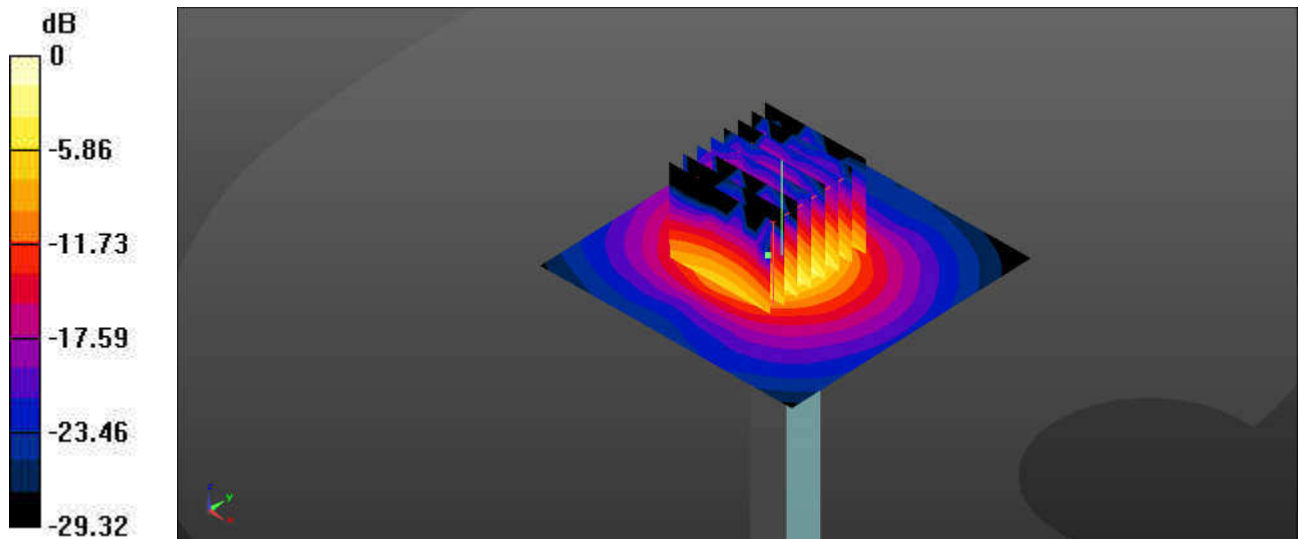

0 dB = $18.7 \text{ W/kg} = 12.72 \text{ dBW/kg}$

System Check_Head_5600MHz

DUT: D5GHzV2 - SN:1113

Communication System: UID 0, CW (0); Frequency: 5600 MHz; Duty Cycle: 1:1

Medium: HSL_5000 Medium parameters used: $f = 5600 \text{ MHz}$; $\sigma = 4.986 \text{ S/m}$; $\epsilon_r = 35.822$; $\rho = 1000 \text{ kg/m}^3$

Ambient Temperature : $23.2 \text{ }^\circ\text{C}$; Liquid Temperature : $22.9 \text{ }^\circ\text{C}$

DASY5 Configuration:

- Probe: EX3DV4 - SN3857; ConvF(4.92, 4.92, 4.92); Calibrated: 2019.5.27
- Sensor-Surface: 1.4mm (Mechanical Surface Detection)
- Electronics: DAE4 Sn1358; Calibrated: 2019.4.17
- Phantom: SAM1; Type: SAM; Serial: TP-1697
- Measurement SW: DASY52, Version 52.10 (1); SEMCAD X Version 14.6.11 (7439)

Pin=100mW/Area Scan (71x71x1): Interpolated grid: $dx=1.000 \text{ mm}$, $dy=1.000 \text{ mm}$

Maximum value of SAR (interpolated) = 20.2 W/kg

Pin=100mW/Zoom Scan (8x8x7)/Cube 0: Measurement grid: $dx=4\text{mm}$, $dy=4\text{mm}$, $dz=1.4\text{mm}$

Reference Value = 40.97 V/m ; Power Drift = 0.13 dB

Peak SAR (extrapolated) = 36.4 W/kg

SAR(1 g) = 8.01 W/kg ; SAR(10 g) = 2.25 W/kg

Maximum value of SAR (measured) = 19.8 W/kg

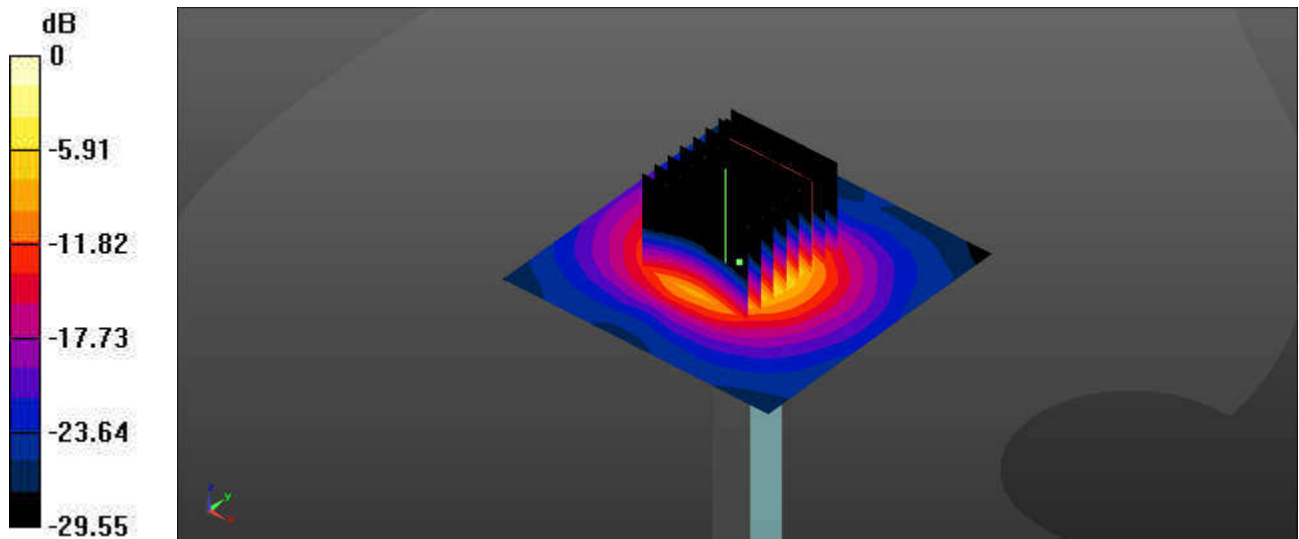

0 dB = $20.2 \text{ W/kg} = 13.05 \text{ dBW/kg}$

System Check_Head_5750MHz

DUT: D5GHzV2 - SN:1113

Communication System: UID 0, CW (0); Frequency: 5750 MHz;Duty Cycle: 1:1

Medium: HSL_5000 Medium parameters used: $f = 5750$ MHz; $\sigma = 5.16$ S/m; $\epsilon_r = 35.569$; $\rho = 1000$ kg/m³

Ambient Temperature : 23.3 °C; Liquid Temperature : 22.6 °C

DASY5 Configuration:

- Probe: EX3DV4 - SN3857; ConvF(5.17, 5.17, 5.17); Calibrated: 2019.5.27
- Sensor-Surface: 1.4mm (Mechanical Surface Detection)
- Electronics: DAE4 Sn1358; Calibrated: 2019.4.17
- Phantom: SAM1; Type: SAM; Serial: TP-1697
- Measurement SW: DASY52, Version 52.10 (1); SEMCAD X Version 14.6.11 (7439)

Pin=100mW/Area Scan (71x71x1): Interpolated grid: dx=1.000 mm, dy=1.000 mm

Maximum value of SAR (interpolated) = 19.2 W/kg

Pin=100mW/Zoom Scan (8x8x7)/Cube 0: Measurement grid: dx=4mm, dy=4mm, dz=1.4mm

Reference Value = 30.75 V/m; Power Drift = 0.05 dB

Peak SAR (extrapolated) = 32.8 W/kg

SAR(1 g) = 7.82 W/kg; SAR(10 g) = 2.24 W/kg

Maximum value of SAR (measured) = 18.8 W/kg

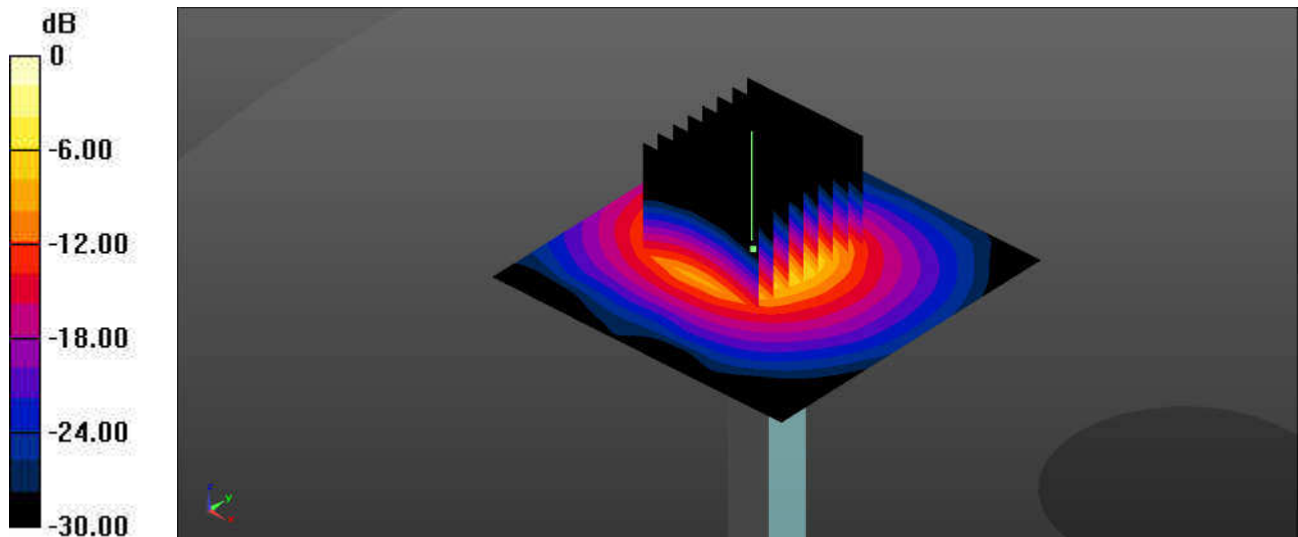

0 dB = 19.2 W/kg = 12.83 dBW/kg



Appendix B. Plots of High SAR Measurement

The plots are shown as follows.

01_GSM 850-UAT-GPRS 4 Tx slots_Left Cheek_0mm_Ch189

Communication System: UID 0, GSM850 (0); Frequency: 836.4 MHz; Duty Cycle: 1:2.08
Medium: HSL_850 Medium parameters used: $f = 836.4$ MHz; $\sigma = 0.913$ S/m; $\epsilon_r = 42.708$; $\rho = 1000$ kg/m³
Ambient Temperature : 23.5 °C ; Liquid Temperature : 22.8 °C

DASY5 Configuration:

- Probe: ES3DV3 - SN3279; ConvF(6.38, 6.38, 6.38); Calibrated: 2019.3.4
- Sensor-Surface: 3mm (Mechanical Surface Detection)
- Electronics: DAE4 Sn1358; Calibrated: 2019.4.17
- Phantom: SAM1; Type: SAM; Serial: TP-1697
- Measurement SW: DASY52, Version 52.10 (1); SEMCAD X Version 14.6.11 (7439)

Ch189/Area Scan (71x71x1): Interpolated grid: dx=1.500 mm, dy=1.500 mm

Maximum value of SAR (interpolated) = 1.22 W/kg

Ch189/Zoom Scan (5x5x7)/Cube 0: Measurement grid: dx=8mm, dy=8mm, dz=5mm

Reference Value = 27.24 V/m; Power Drift = 0.03 dB

Peak SAR (extrapolated) = 2.14 W/kg

SAR(1 g) = 1.04 W/kg; SAR(10 g) = 0.543 W/kg

Maximum value of SAR (measured) = 1.24 W/kg

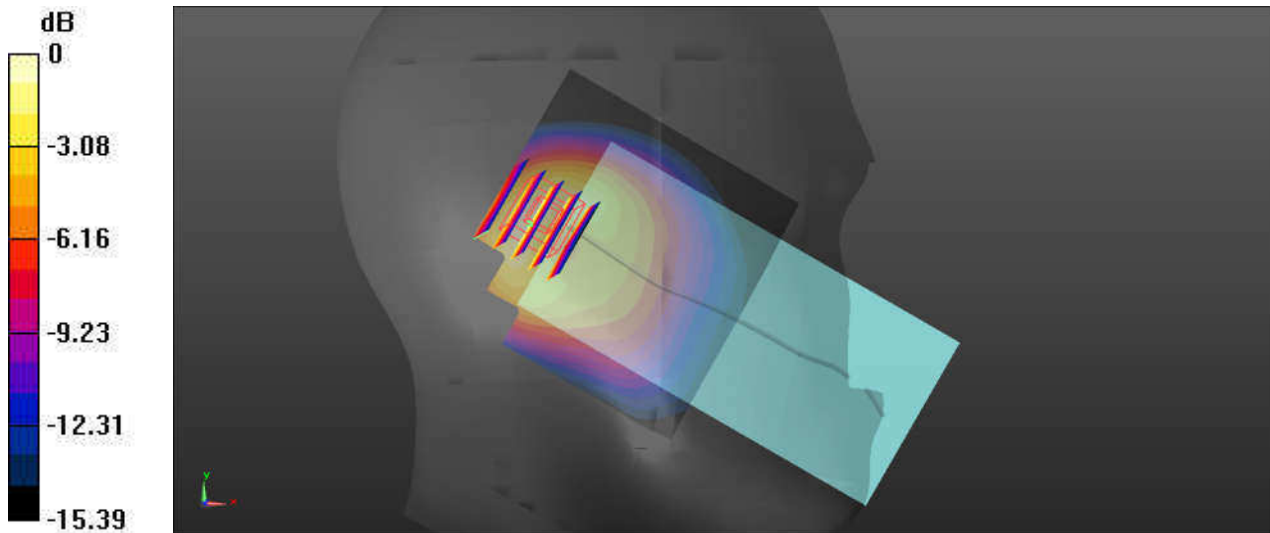

0 dB = 1.24 W/kg = 0.93 dBW/kg

02_GSM1900-UAT_GPRS 4 Tx slots_Right Cheek_0mm_Ch512

Communication System: UID 0, PCS (0); Frequency: 1850.2 MHz; Duty Cycle: 1:2.08
Medium: HSL_1900 Medium parameters used: $f = 1850.2$ MHz; $\sigma = 1.34$ S/m; $\epsilon_r = 41.673$; $\rho = 1000$ kg/m³
Ambient Temperature : 23.5 °C ; Liquid Temperature : 22.7 °C

DASY5 Configuration:

- Probe: ES3DV3 - SN3279; ConvF(5.35, 5.35, 5.35); Calibrated: 2019.3.4
- Sensor-Surface: 3mm (Mechanical Surface Detection)
- Electronics: DAE4 Sn1358; Calibrated: 2019.4.17
- Phantom: SAM1; Type: SAM; Serial: TP-1697
- Measurement SW: DASY52, Version 52.10 (1); SEMCAD X Version 14.6.11 (7439)

Ch512/Area Scan (71x71x1): Interpolated grid: dx=1.500 mm, dy=1.500 mm

Maximum value of SAR (interpolated) = 1.37 W/kg

Ch512/Zoom Scan (5x5x7)/Cube 0: Measurement grid: dx=8mm, dy=8mm, dz=5mm

Reference Value = 21.54 V/m; Power Drift = -0.01 dB

Peak SAR (extrapolated) = 2.04 W/kg

SAR(1 g) = 0.963 W/kg; SAR(10 g) = 0.582 W/kg

Maximum value of SAR (measured) = 1.10 W/kg

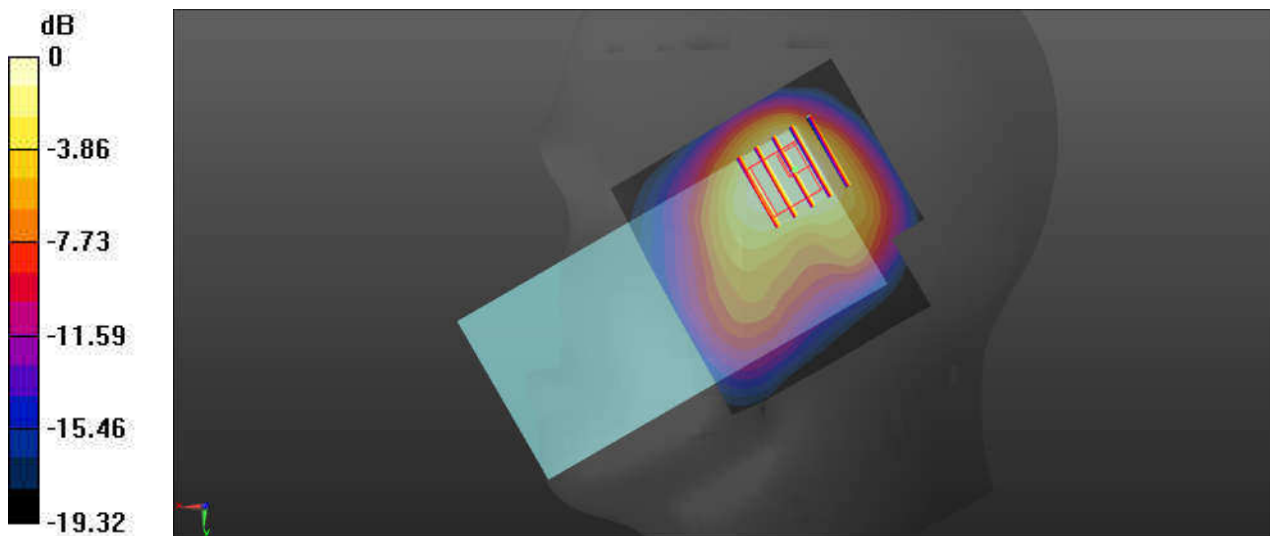

0 dB = 1.10 W/kg = 0.41 dBW/kg

03_WCDMA II-UAT_RMC 12.2Kbps_Right Cheek_0mm_Ch9538

Communication System: UID 0, WCDMA (0); Frequency: 1907.6 MHz; Duty Cycle: 1:1
Medium: HSL_1900 Medium parameters used: $f = 1907.6$ MHz; $\sigma = 1.397$ S/m; $\epsilon_r = 41.45$; $\rho = 1000$ kg/m³
Ambient Temperature : 23.5 °C ; Liquid Temperature : 22.7 °C

DASY5 Configuration:

- Probe: ES3DV3 - SN3279; ConvF(5.35, 5.35, 5.35); Calibrated: 2019.3.4
- Sensor-Surface: 3mm (Mechanical Surface Detection)
- Electronics: DAE4 Sn1358; Calibrated: 2019.4.17
- Phantom: SAM1; Type: SAM; Serial: TP-1697
- Measurement SW: DASY52, Version 52.10 (1); SEMCAD X Version 14.6.11 (7439)

Ch9538/Area Scan (71x71x1): Interpolated grid: dx=1.500 mm, dy=1.500 mm
Maximum value of SAR (interpolated) = 0.757 W/kg

Ch9538/Zoom Scan (5x5x7)/Cube 0: Measurement grid: dx=8mm, dy=8mm, dz=5mm
Reference Value = 14.28 V/m; Power Drift = 0.06 dB
Peak SAR (extrapolated) = 1.07 W/kg
SAR(1 g) = 0.536 W/kg; SAR(10 g) = 0.319 W/kg
Maximum value of SAR (measured) = 0.638 W/kg

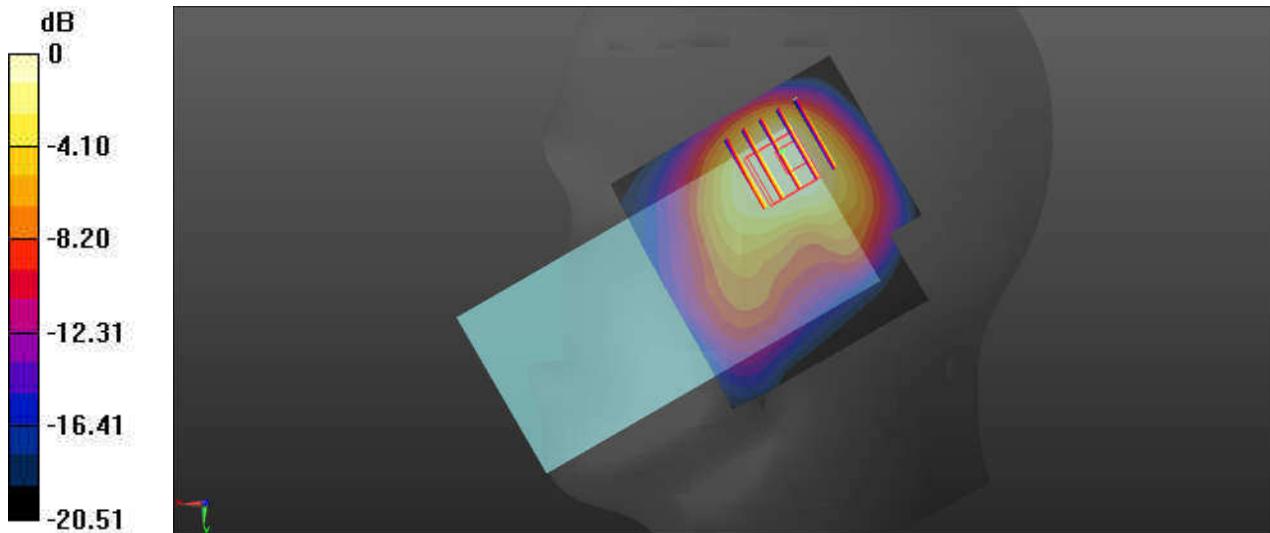

04_WCDMA IV-UAT_RMC 12.2Kbps_Right Cheek_0mm_Ch1513

Communication System: UID 0, WCDMA (0); Frequency: 1752.6 MHz; Duty Cycle: 1:1
Medium: HSL_1750 Medium parameters used: $f = 1753$ MHz; $\sigma = 1.346$ S/m; $\epsilon_r = 38.529$; $\rho = 1000$ kg/m³
Ambient Temperature : 23.5 °C; Liquid Temperature : 22.7 °C

DASY5 Configuration:

- Probe: ES3DV3 - SN3279; ConvF(5.59, 5.59, 5.59); Calibrated: 2019.3.4
- Sensor-Surface: 3mm (Mechanical Surface Detection)
- Electronics: DAE4 Sn1358; Calibrated: 2019.4.17
- Phantom: SAM1; Type: SAM; Serial: TP-1697
- Measurement SW: DASY52, Version 52.10 (1); SEMCAD X Version 14.6.11 (7439)

Ch1513/Area Scan (71x71x1): Interpolated grid: dx=1.500 mm, dy=1.500 mm

Maximum value of SAR (interpolated) = 0.518 W/kg

Ch1513/Zoom Scan (5x5x7)/Cube 0: Measurement grid: dx=8mm, dy=8mm, dz=5mm

Reference Value = 14.89 V/m; Power Drift = 0.13 dB

Peak SAR (extrapolated) = 0.784 W/kg

SAR(1 g) = 0.403 W/kg; SAR(10 g) = 0.257 W/kg

Maximum value of SAR (measured) = 0.496 W/kg

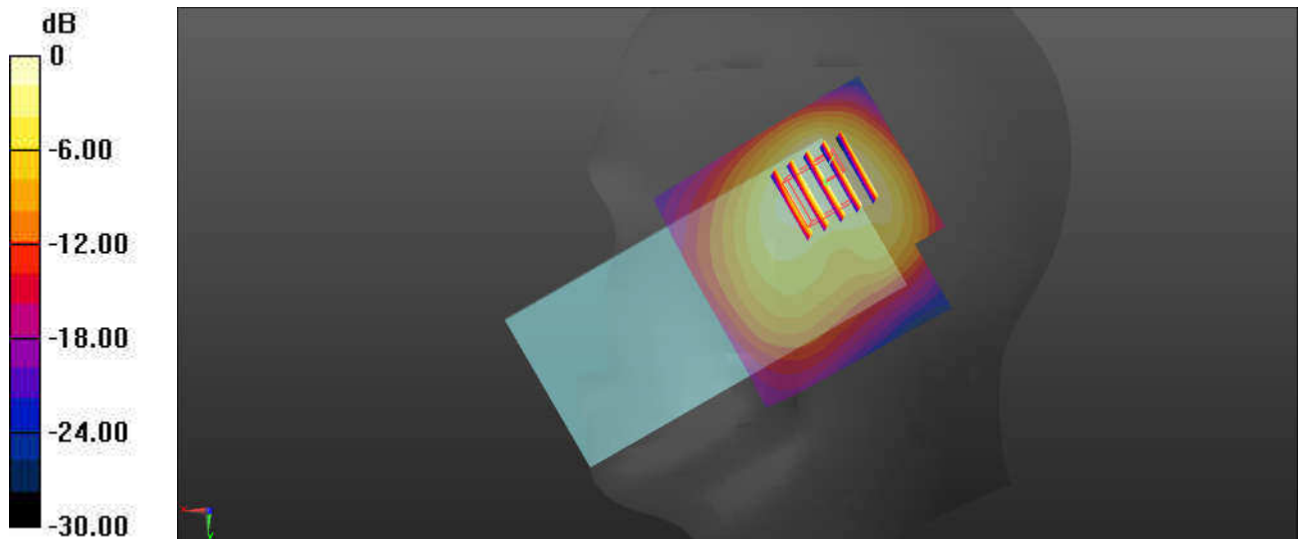

0 dB = 0.518 W/kg = -2.86 dBW/kg

05_GWCDMA V-UAT_RMC 12.2Kbps_Right Tilted_0mm_Ch4233

Communication System: UID 0, WCDMA (0); Frequency: 846.6 MHz; Duty Cycle: 1:1
Medium: HSL_850 Medium parameters used: $f = 847$ MHz; $\sigma = 0.923$ S/m; $\epsilon_r = 42.589$; $\rho = 1000$ kg/m³
Ambient Temperature : 23.5 °C; Liquid Temperature : 22.8 °C

DASY5 Configuration:

- Probe: ES3DV3 - SN3279; ConvF(6.38, 6.38, 6.38); Calibrated: 2019.3.4
- Sensor-Surface: 3mm (Mechanical Surface Detection)
- Electronics: DAE4 Sn1358; Calibrated: 2019.4.17
- Phantom: SAM1; Type: SAM; Serial: TP-1697
- Measurement SW: DASY52, Version 52.10 (1); SEMCAD X Version 14.6.11 (7439)

Ch4233/Area Scan (71x71x1): Interpolated grid: dx=1.500 mm, dy=1.500 mm

Maximum value of SAR (interpolated) = 1.42 W/kg

Ch4233/Zoom Scan (5x5x7)/Cube 0: Measurement grid: dx=8mm, dy=8mm, dz=5mm

Reference Value = 29.61 V/m; Power Drift = 0.02 dB

Peak SAR (extrapolated) = 2.64 W/kg

SAR(1 g) = 1.01 W/kg; SAR(10 g) = 0.501 W/kg

Maximum value of SAR (measured) = 1.27 W/kg

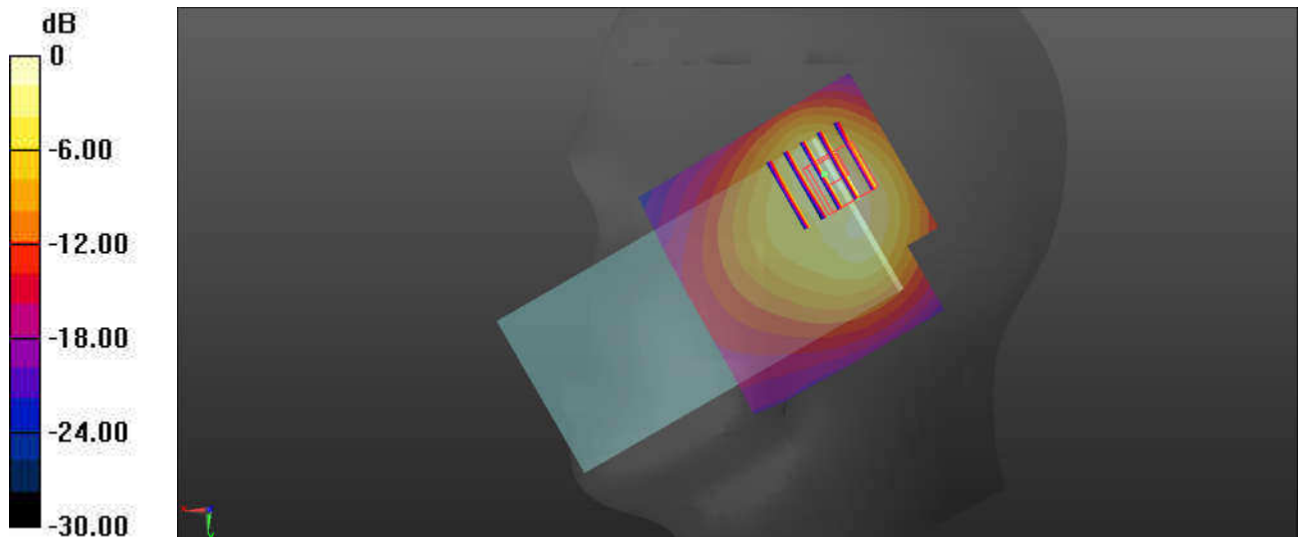

0 dB = 1.42 W/kg = 1.52 dBW/kg

06_LTE Band 2-UAT_20M_QPSK_50RB_0offset_Right Cheek_0mm_Ch19100

Communication System: UID 0, LTE-FDD (0); Frequency: 1900 MHz; Duty Cycle: 1:1
Medium: HSL_1900 Medium parameters used: $f = 1900$ MHz; $\sigma = 1.389$ S/m; $\epsilon_r = 41.478$; $\rho = 1000$ kg/m³
Ambient Temperature : 23.5 °C; Liquid Temperature : 22.7 °C

DASY5 Configuration:

- Probe: ES3DV3 - SN3279; ConvF(5.35, 5.35, 5.35); Calibrated: 2019.3.4
- Sensor-Surface: 3mm (Mechanical Surface Detection)
- Electronics: DAE4 Sn1358; Calibrated: 2019.4.17
- Phantom: SAM1; Type: SAM; Serial: TP-1697
- Measurement SW: DASY52, Version 52.10 (1); SEMCAD X Version 14.6.11 (7439)

Ch19100/Area Scan (71x71x1): Interpolated grid: dx=1.500 mm, dy=1.500 mm

Maximum value of SAR (interpolated) = 0.632 W/kg

Ch19100/Zoom Scan (5x5x7)/Cube 0: Measurement grid: dx=8mm, dy=8mm, dz=5mm

Reference Value = 14.05 V/m; Power Drift = 0.01 dB

Peak SAR (extrapolated) = 0.939 W/kg

SAR(1 g) = 0.464 W/kg; SAR(10 g) = 0.275 W/kg

Maximum value of SAR (measured) = 0.559 W/kg

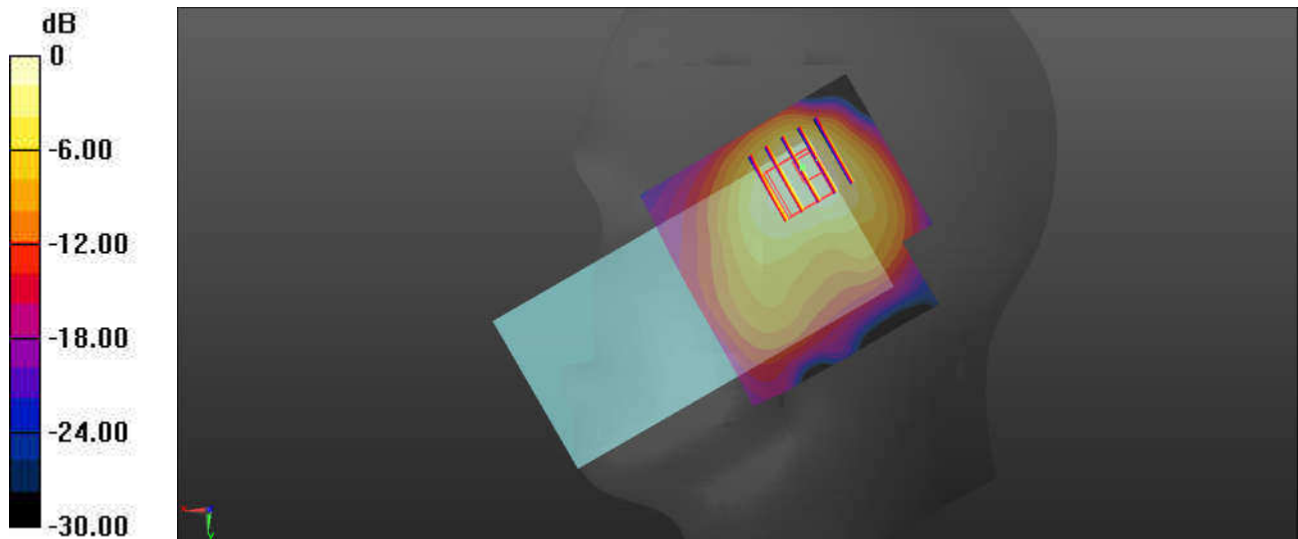

0 dB = 0.632 W/kg = -1.99 dBW/kg

07_LTE Band 4-UAT_20M_QPSK_1RB_0offset_Right Cheek_0mm_Ch20175

Communication System: UID 0, LTE-FDD (0); Frequency: 1732.5 MHz; Duty Cycle: 1:1
Medium: HSL_1750 Medium parameters used: $f = 1733$ MHz; $\sigma = 1.324$ S/m; $\epsilon_r = 38.61$; $\rho = 1000$ kg/m³
Ambient Temperature : 23.5 °C; Liquid Temperature : 22.7 °C

DASY5 Configuration:

- Probe: ES3DV3 - SN3279; ConvF(5.59, 5.59, 5.59); Calibrated: 2019.3.4
- Sensor-Surface: 3mm (Mechanical Surface Detection)
- Electronics: DAE4 Sn1358; Calibrated: 2019.4.17
- Phantom: SAM1; Type: SAM; Serial: TP-1697
- Measurement SW: DASY52, Version 52.10 (1); SEMCAD X Version 14.6.11 (7439)

Ch20175/Area Scan (71x71x1): Interpolated grid: dx=1.500 mm, dy=1.500 mm

Maximum value of SAR (interpolated) = 0.980 W/kg

Ch20175/Zoom Scan (6x7x7)/Cube 0: Measurement grid: dx=8mm, dy=8mm, dz=5mm

Reference Value = 19.74 V/m; Power Drift = 0.04 dB

Peak SAR (extrapolated) = 1.33 W/kg

SAR(1 g) = 0.650 W/kg; SAR(10 g) = 0.430 W/kg

Maximum value of SAR (measured) = 0.992 W/kg

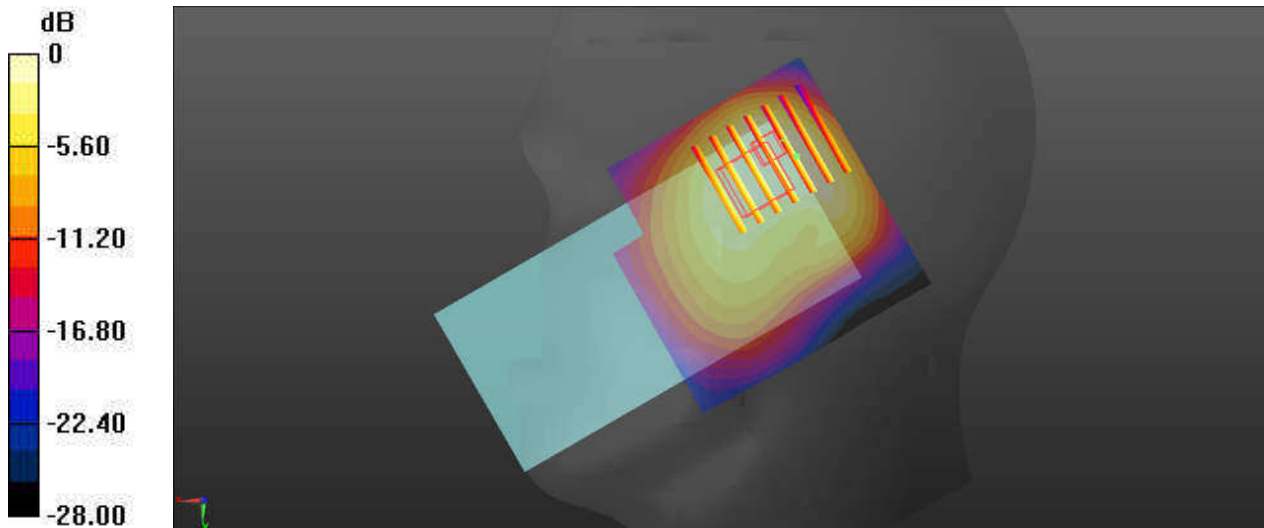

0 dB = 0.980 W/kg = -0.09 dBW/kg

08_LTE Band 5-UAT_10M_QPSK_1RB_0offset_Right Tilted_0mm_Ch20525

Communication System: UID 0, LTE-FDD (0); Frequency: 836.5 MHz; Duty Cycle: 1:1
 Medium: HSL_850 Medium parameters used: $f = 836.5$ MHz; $\sigma = 0.913$ S/m; $\epsilon_r = 42.706$; $\rho = 1000$ kg/m³
 Ambient Temperature : 23.5 °C; Liquid Temperature : 22.8 °C

DASY5 Configuration:

- Probe: ES3DV3 - SN3279; ConvF(6.38, 6.38, 6.38); Calibrated: 2019.3.4
- Sensor-Surface: 3mm (Mechanical Surface Detection)
- Electronics: DAE4 Sn1358; Calibrated: 2019.4.17
- Phantom: SAM1; Type: SAM; Serial: TP-1697
- Measurement SW: DASY52, Version 52.10 (1); SEMCAD X Version 14.6.11 (7439)

Ch20525/Area Scan (71x71x1): Interpolated grid: dx=1.500 mm, dy=1.500 mm
 Maximum value of SAR (interpolated) = 1.28 W/kg

Ch20525/Zoom Scan (5x5x7)/Cube 0: Measurement grid: dx=8mm, dy=8mm, dz=5mm
 Reference Value = 28.40 V/m; Power Drift = -0.02 dB
 Peak SAR (extrapolated) = 1.84 W/kg
SAR(1 g) = 0.640 W/kg; SAR(10 g) = 0.313 W/kg
 Maximum value of SAR (measured) = 1.32 W/kg

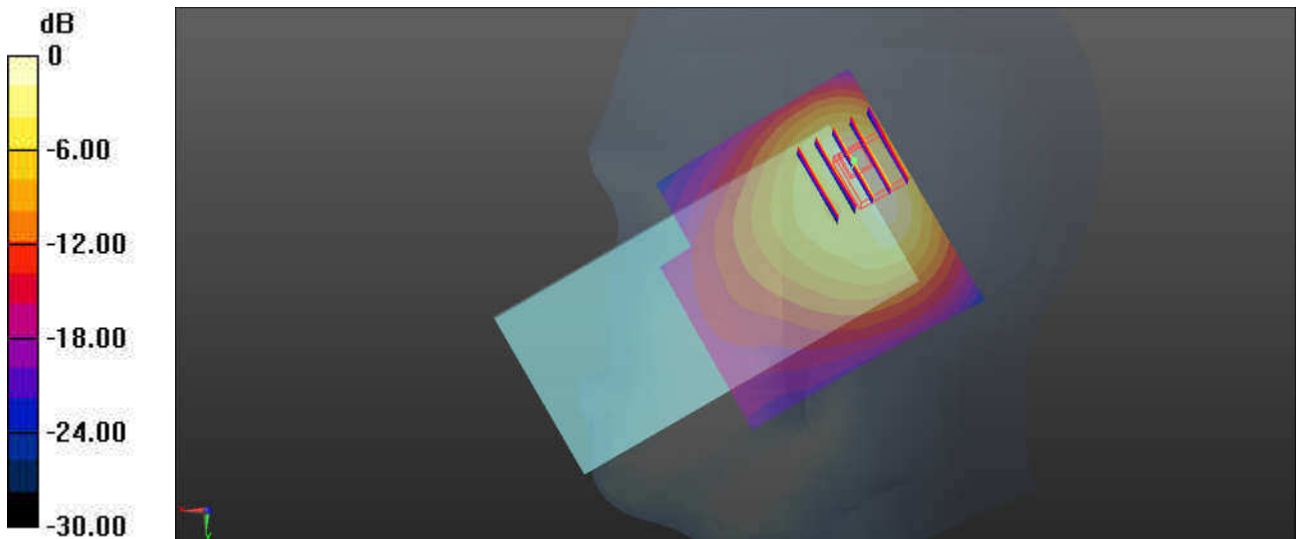

0 dB = 1.28 W/kg = 1.07 dBW/kg

09_LTE Band 7-UAT_20M_QPSK_1RB_0offset_Right Cheek_0mm_Ch21350

Communication System: UID 0, LTE-FDD (0); Frequency: 2560 MHz; Duty Cycle: 1:1
 Medium: HSL_2600 Medium parameters used: $f = 2560$ MHz; $\sigma = 2.002$ S/m; $\epsilon_r = 40.295$; $\rho = 1000$ kg/m³
 Ambient Temperature : 23.4 °C; Liquid Temperature : 22.8 °C

DASY5 Configuration:

- Probe: ES3DV3 - SN3279; ConvF(4.58, 4.58, 4.58); Calibrated: 2019.3.4
- Sensor-Surface: 3mm (Mechanical Surface Detection)
- Electronics: DAE4 Sn1358; Calibrated: 2019.4.17
- Phantom: SAM1; Type: SAM; Serial: TP-1697
- Measurement SW: DASY52, Version 52.10 (1); SEMCAD X Version 14.6.11 (7439)

Ch21350/Area Scan (91x81x1): Interpolated grid: dx=1.200 mm, dy=1.200 mm

Maximum value of SAR (interpolated) = 0.868 W/kg

Ch21350/Zoom Scan (7x7x7)/Cube 0: Measurement grid: dx=5mm, dy=5mm, dz=5mm

Reference Value = 9.570 V/m; Power Drift = 0.02 dB

Peak SAR (extrapolated) = 1.34 W/kg

SAR(1 g) = 0.588 W/kg; SAR(10 g) = 0.289 W/kg

Maximum value of SAR (measured) = 0.760 W/kg

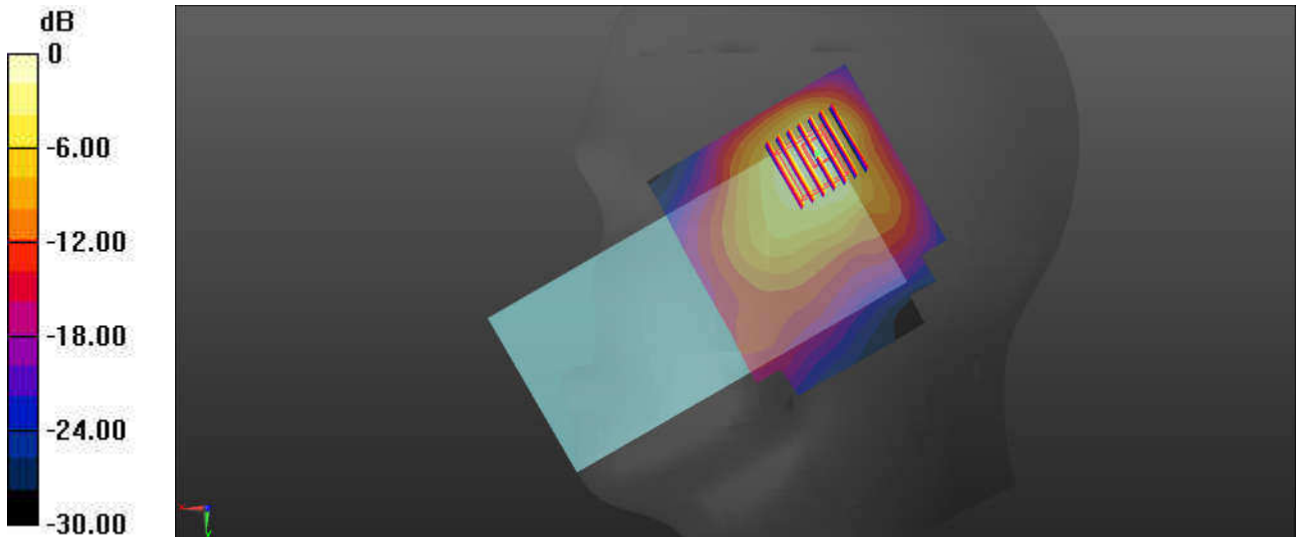

0 dB = 0.868 W/kg = -0.61 dBW/kg