



FCC Test Report

APPLICANT : Xiaomi Communications Co., Ltd.
EQUIPMENT : Mobile Phone
BRAND NAME : Redmi
MODEL NAME : M1906G7G
FCC ID : 2AFZZG7G
STANDARD : 47 CFR Part 15 Subpart B
CLASSIFICATION : Certification

The product was received on Jun. 10, 2019 and testing was completed on Aug. 05, 2019. We, Sporton International (Kunshan) Inc., would like to declare that the tested sample has been evaluated in accordance with the test procedures given in ANSI C63.4-2014 and has been in compliance with the applicable technical standards.

The test results in this report apply exclusively to the tested model / sample. Without written approval of Sporton International (Kunshan) Inc., the test report shall not be reproduced except in full.

Jason Jia

Reviewed by: Jason Jia / Supervisor

James Huang

Approved by: James Huang / Manager



Sporton International (Kunshan) Inc.

**No. 1098, Pengxi North Road, Kunshan Economic Development Zone Jiangsu Province 215300
People's Republic of China**



TABLE OF CONTENTS

REVISION HISTORY 3

SUMMARY OF TEST RESULT 4

1. GENERAL DESCRIPTION 5

 1.1. Applicant..... 5

 1.2. Manufacturer 5

 1.3. Product Feature of Equipment Under Test 5

 1.4. Product Specification of Equipment Under Test 6

 1.5. Modification of EUT 7

 1.6. Test Location 7

 1.7. Applicable Standards 7

2. TEST CONFIGURATION OF EQUIPMENT UNDER TEST 8

 2.1. Test Mode 8

 2.2. Connection Diagram of Test System 10

 2.3. Support Unit used in test configuration and system 10

 2.4. EUT Operation Test Setup 11

3. TEST RESULT 12

 3.1. Test of AC Conducted Emission Measurement 12

 3.2. Test of Radiated Emission Measurement 16

4. LIST OF MEASURING EQUIPMENT 20

5. UNCERTAINTY OF EVALUATION 21

APPENDIX A. SETUP PHOTOGRAPHS



REVISION HISTORY

REPORT NO.	VERSION	DESCRIPTION	ISSUED DATE
FC961001	Rev. 01	Initial issue of report	Sep. 12, 2019



SUMMARY OF TEST RESULT

Report Section	FCC Rule	Description	Limit	Result	Remark
3.1	15.107	AC Conducted Emission	< 15.107 limits	PASS	Under limit 13.16 dB at 0.474 MHz
3.2	15.109	Radiated Emission	< 15.109 limits	PASS	Under limit 5.51 dB at 45.520 MHz



1. General Description

1.1. Applicant

Xiaomi Communications Co., Ltd.

The Rainbow City of China Resources, NO.68, Qinghe Middle Street, Haidian District, Beijing, China

1.2. Manufacturer

Xiaomi Communications Co., Ltd.

The Rainbow City of China Resources, NO.68, Qinghe Middle Street, Haidian District, Beijing, China

1.3. Product Feature of Equipment Under Test

Product Feature	
Equipment	Mobile Phone
Brand Name	Redmi
Model Name	M1906G7G
FCC ID	2AFZZG7G
EUT supports Radios application	GSM/GPRS/EGPRS WCDMA/HSPA/DC-HSDPA/HSPA+/LTE WLAN 2.4GHz 802.11b/g/n HT20 WLAN 5GHz 802.11a/n HT20/HT40 WLAN 5GHz 802.11ac VHT20/VHT40/VHT80 Bluetooth BR/EDR/LE FM Receiver/GNSS/NFC
IMEI Code	Conduction: 866498040025776/866498040025784 Radiation: 866498040025594/866498040025602 for Sample1 866498040018359/866498040018367 for Sample2
HW Version	P2
SW Version	MIUI10
EUT Stage	Identical Prototype

Remark:

1. The above EUT's information was declared by manufacturer. Please refer to the specifications or user's manual for more detailed description.
2. There are two types of EUT. The difference is memory capacity and memory suppliers only. According to the difference, we choose sample 1 to perform full test, sample 2 to verify difference for Radiation.



1.4. Product Specification of Equipment Under Test

Standards-related Product Specification	
Tx Frequency	GSM850: 824.2 MHz ~ 848.8 MHz GSM1900: 1850.2 MHz ~ 1909.8MHz WCDMA Band V: 826.4 MHz ~ 846.6 MHz WCDMA Band IV : 1712.4 MHz ~ 1752.6 MHz WCDMA Band II: 1852.4 MHz ~ 1907.6 MHz LTE Band 2 : 1850.7 MHz ~ 1909.3 MHz LTE Band 4 : 1710.7 MHz ~ 1754.3 MHz LTE Band 5 : 824.7 MHz ~ 848.3 MHz LTE Band 7 : 2502.5 MHz ~ 2567.5 MHz LTE Band 38 : 2572.5 MHz ~ 2617.5 MHz 802.11b/g/n: 2412 MHz ~ 2462 MHz 802.11a/n/ac: 5180 MHz ~ 5240 MHz; 5260 MHz ~ 5320 MHz; 5500 MHz ~ 5700 MHz 5745 MHz ~ 5805 MHz Bluetooth: 2402 MHz ~ 2480 MHz NFC : 13.56 MHz
Rx Frequency	GSM850: 869.2 MHz ~ 893.8 MHz GSM1900: 1930.2 MHz ~ 1989.8 MHz WCDMA Band V: 871.4 MHz ~ 891.6 MHz WCDMA Band IV : 2112.4 MHz ~ 2152.6 MHz WCDMA Band II: 1932.4 MHz ~ 1987.6 MHz LTE Band 2 : 1930.7 MHz ~ 1989.3 MHz LTE Band 4 : 2110.7 MHz ~ 2154.3 MHz LTE Band 5 : 869.7 MHz ~ 893.3 MHz LTE Band 7 : 2622.5 MHz ~ 2687.5 MHz LTE Band 38: 2572.5 MHz ~ 2617.5 MHz 802.11b/g/n: 2412 MHz ~ 2462 MHz 802.11a/n/ac: 5180 MHz ~ 5240 MHz; 5260 MHz ~ 5320 MHz; 5500 MHz ~ 5700 MHz 5745 MHz ~ 5805 MHz Bluetooth: 2402 MHz ~ 2480 MHz GNSS : 1559 MHz ~ 1610 MHz NFC : 13.56 MHz FM: 88MHz~108MHz
Antenna Type	WWAN : PIFA Antenna WLAN : PIFA Antenna Bluetooth : PIFA Antenna GNSS: PIFA Antenna NFC : Loop Antenna FM: External Handset Antenna
Type of Modulation	GSM: GMSK GPRS: GMSK EDGE(MCS 0-4): GMSK / (MCS 5-9): 8PSK WCDMA : BPSK (Uplink) HSDPA/DC-HSDPA : QPSK (Uplink) HSUPA : QPSK (Uplink) HSPA+ : 16QAM



	DC-HSDPA : 64QAM LTE: QPSK / 16QAM / 64QAM / 256QAM(Downlink only) 802.11b : DSSS (BPSK / QPSK / CCK) 802.11a/g/n/ac : OFDM (BPSK / QPSK / 16QAM / 64QAM /256QAM) Bluetooth LE : GFSK Bluetooth (1Mbps) : GFSK Bluetooth (2Mbps) :π/4-DQPSK Bluetooth (3Mbps) : 8-DPSK GNSS : BPSK NFC: ASK FM
--	--

Note: GNSS Rx = GPS Rx + Glonass Rx + BDS Rx + Galileo Rx

1.5. Modification of EUT

No modifications are made to the EUT during all test items.

1.6. Test Location

Sporton International (Kunshan) Inc. is accredited to ISO/IEC 17025:2017 by American Association for Laboratory Accreditation with Certificate Number 5145.02.

Test Firm	Sporton International (Kunshan) Inc.		
Test Site Location	No. 1098, Pengxi North Road, Kunshan Economic Development Zone Jiangsu Province 215300 People's Republic of China TEL : +86-512-57900158 FAX : +86-512-57900958		
Test Site No.	Sporton Site No.	FCC Designation No.	FCC Test Firm Registration No.
	CO01-KS 03CH02-KS	CN1257	314309

1.7. Applicable Standards

According to the specifications of the manufacturer, the EUT must comply with the requirements of the following standards:

- 47 CFR Part 15 Subpart B
- ANSI C63.4-2014

Remark: All test items were verified and recorded according to the standards and without any deviation during the test.



2. Test Configuration of Equipment Under Test

2.1. Test Mode

The EUT has been associated with peripherals pursuant to ANSI C63.4-2014 and configuration operated in a manner tended to maximize its emission characteristics in a typical application.

Frequency range investigated: conduction emission (150 kHz to 30 MHz), radiation emission (30MHz to the 5th harmonic of the highest fundamental frequency or to 40 GHz, whichever is lower).

Test Items	Function Type
AC Conducted Emission	Mode 1: GSM 850 Rx(Middle) + Earphone + BT Idle + WLAN Idle(2.4G) + Camera(Rear) + USB Cable1(Charging from Adapter) for Sample 1
	Mode 2: GSM 1900 Rx + Earphone + BT Idle + WLAN Idle(5G) + Camera(Front) + USB Cable2(Charging from Adapter) for Sample 1
	Mode 3: WCDMA Band V Rx(Low) + Earphone + BT Idle + WLAN Idle(2.4G) + MPEG4 + USB Cable1(Charging from Adapter) for Sample 1
	Mode 4: LTE Band 5 Rx(High) + Earphone + BT Idle + WLAN Idle(5G) + NFC On + USB Cable1(Charging from Adapter) for Sample 1
	Mode 5: LTE Band 4 Rx + Earphone + BT Idle + WLAN Idle(2.4G) + FM Rx(98MHz) + USB Cable1(Charging from Adapter) for Sample 1
	Mode 6: LTE Band 7 Rx + Earphone + BT Idle + WLAN Idle(5G) + GNSS Rx + USB Cable 1(Data Link with Notebook) for Sample 1
	Mode 7: LTE Band 38 Rx + Earphone + BT Idle + WLAN Idle(2.4G) + GNSS Rx + USB Cable 2(Data Link with Notebook) for Sample 1
Radiated Emissions	Mode 1: GSM 850 Rx(Middle) + Earphone + BT Idle + WLAN Idle(2.4G) + Camera(Rear) + USB Cable1(Charging from Adapter) for Sample 1
	Mode 2: GSM 1900 Rx + Earphone + BT Idle + WLAN Idle(5G) + Camera(Front) + USB Cable2(Charging from Adapter) for Sample 1
	Mode 3: WCDMA band V Rx(Low) + Earphone + BT Idle + WLAN Idle(2.4G) + MPEG4 + USB Cable1(Charging from Adapter) for Sample 1
	Mode 4: LTE Band 5 Rx(High) + Earphone + BT Idle + WLAN Idle(5G) + NFC On + USB Cable1(Charging from Adapter) for Sample 1
	Mode 5: LTE Band 4 Rx + Earphone + BT Idle + WLAN Idle(2.4G) + FM Rx(88MHz) + USB Cable1(Charging from Adapter) for Sample 1
	Mode 6: LTE Band 7 Rx + Earphone + BT Idle + WLAN Idle(5G) + GNSS Rx + USB Cable 1(Data Link with Notebook) for Sample 1
	Mode 7: LTE Band 38 Rx + Earphone + BT Idle + WLAN Idle(2.4G) + GNSS Rx + USB Cable 2(Data Link with Notebook) for Sample 1
	Mode 8: LTE Band 38 Rx + Earphone + BT Idle + WLAN Idle(2.4G) + GNSS Rx + USB Cable 2(Data Link with Notebook) for Sample 2



Remark:

1. The worst case of AC is mode 6; only the test data of this mode is reported.
2. The worst case of RE is mode 7; only the test data of this mode is reported.
3. Data Link with Notebook means data application transferred mode between EUT and Notebook.
4. Pre-scanned Low/Middle/High channel for GSM850/WCDMA Band V/LTE Band 5, FM Rx, the worst channel was recorded in this report.

2.2. Connection Diagram of Test System

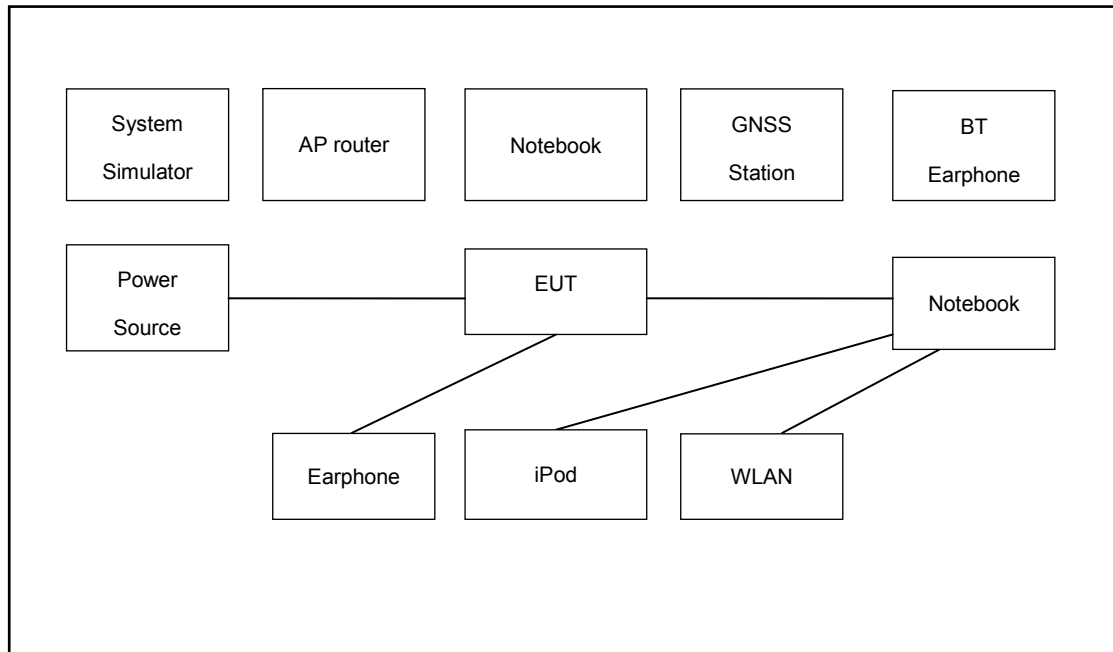

2.3. Support Unit used in test configuration and system

Item	Equipment	Trade Name	Model Name	FCC ID	Data Cable	Power Cord
1.	Base Station	R&S	CMU 200	N/A	N/A	Unshielded, 1.8m
2.	LTE Base Station	Anritsu	MT8820C	N/A	N/A	Unshielded, 1.8m
3.	Bluetooth Earphone	Xiaomi	LYEJ02LM	N/A	N/A	N/A
4.	Notebook	Lenovo	G480	N/A	N/A	shielded cable DC O/P 1.8m Unshielded AC I/P cable 1.8m
5.	Notebook	Dell	Latitude3440	N/A	N/A	shielded cable DC O/P 1.8m Unshielded AC I/P cable 1.8m
6.	WLAN AP	D-Link	DIR-855	KA2DIR855A2	N/A	Unshielded, 1.8m
7.	WLAN AP	TP-Link	TL-WDR5600	N/A	N/A	Unshielded, 1.8m
8.	iPod	Apple	A1199	Fcc DoC	Shielded, 1.2m	N/A
9.	SD Card	Kingston	8GB	N/A	N/A	N/A
10.	Signal Generator	R&S	SMBV100A	N/A	N/A	Unshielded, 1.8m
11.	Earphone	Lenovo	SH100	N/A	Unshielded, 1.2m	N/A



2.4. EUT Operation Test Setup

The EUT was in GSM or WCDMA or LTE idle mode during the testing. The EUT was synchronized to the BCCH, and is in continuous receiving mode by setting system simulator's paging reorganization.

At the same time, the EUT was attached to the Bluetooth earphone or WLAN AP, and the following programs installed in the EUT were programmed during the test.

1. Data application is transferred between notebook and EUT via USB cable.
2. Turn on camera to capture images.
3. Turn on MPEG4 function.
4. Turn on NFC function.
5. Turn on GNSS function to make the EUT receive continuous signals from GNSS station.
6. Turn on FM function to make the EUT receive continuous signals from FM station.



3. Test Result

3.1. Test of AC Conducted Emission Measurement

3.1.1 Limits of AC Conducted Emission

For equipment that is designed to be connected to the public utility (AC) power line, the radio frequency voltage that is conducted back onto the AC power line on any frequency or frequencies within the band 150 kHz to 30 MHz shall not exceed the limits in the following table.

<Class B Limit>

Frequency of emission (MHz)	Conducted limit (dBuV)	
	Quasi-peak	Average
0.15-0.5	66 to 56*	56 to 46*
0.5-5	56	46
5-30	60	50

*Decreases with the logarithm of the frequency.

3.1.2 Measuring Instruments

The measuring equipment is listed in the section 4 of this test report.

3.1.3 Test Procedure

1. The EUT was placed 0.4 meter from the conducting wall of the shielding room was kept at least 80 centimeters from any other grounded conducting surface.
2. Connect EUT to the power mains through a line impedance stabilization network (LISN).
3. All the support units are connecting to the other LISN.
4. The LISN provides 50 ohm coupling impedance for the measuring instrument.
5. The FCC states that a 50 ohm, 50 microhenry LISN should be used.
6. Both sides of AC line were checked for maximum conducted interference.
7. The frequency range from 150 kHz to 30 MHz was searched.
8. Set the test-receiver system to Peak Detect Function and specified bandwidth (IF Bandwidth = 9kHz) with Maximum Hold Mode. Then measurement is also conducted by Average Detector and Quasi-Peak Detector Function respectively.

3.1.4 Test Setup





3.1.5 Test Result of AC Conducted Emission

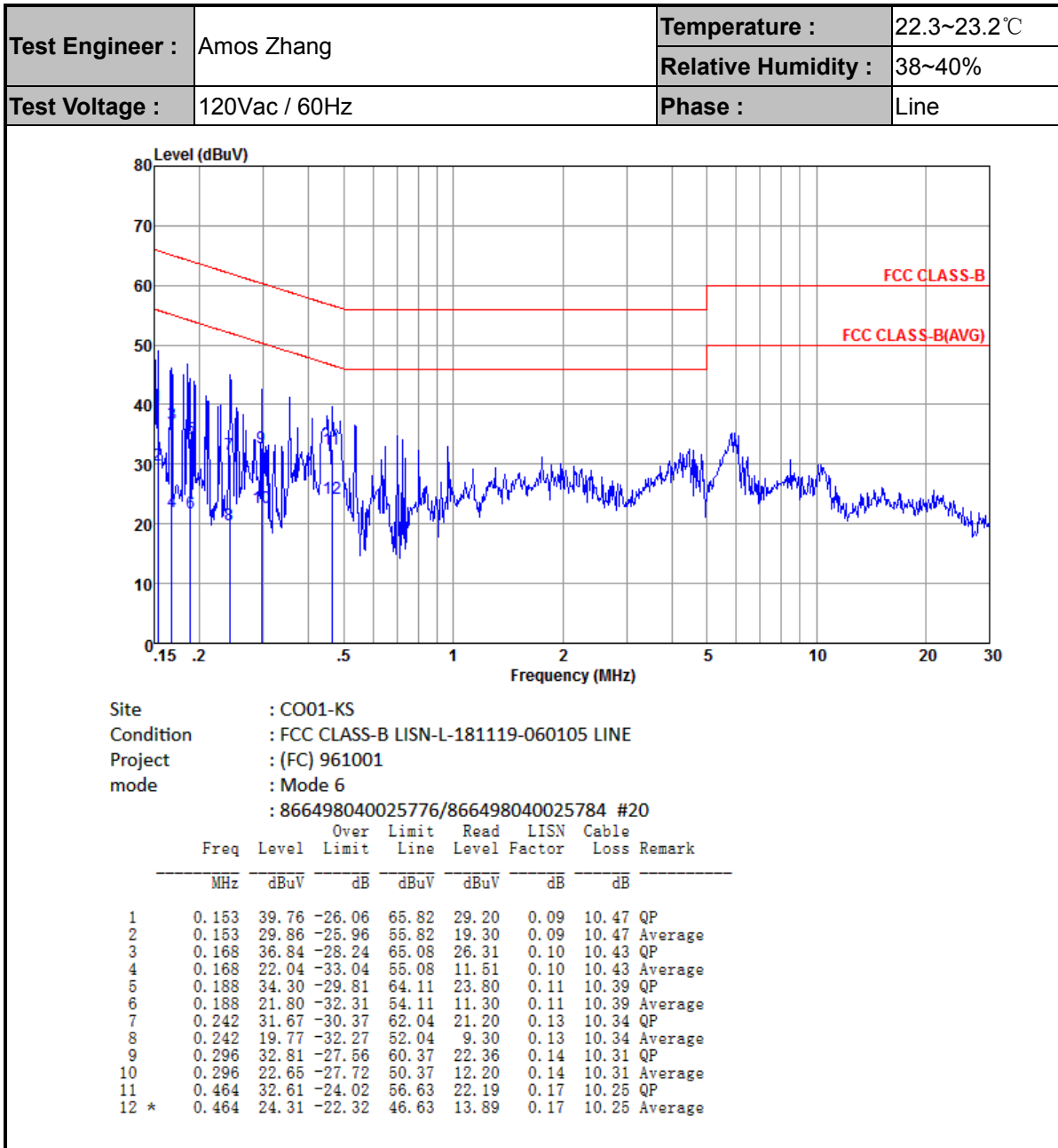



Test Engineer :	Amos Zhang	Temperature :	22.3~23.2°C
		Relative Humidity :	38~40%
Test Voltage :	120Vac / 60Hz	Phase :	Neutral

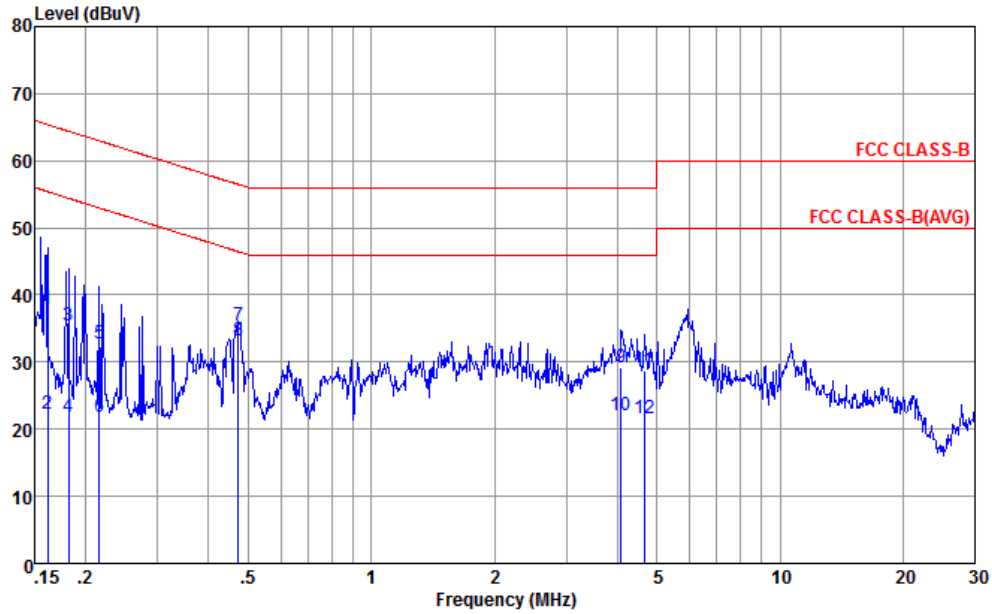

Site : CO01-KS
 Condition : FCC CLASS-B LISN-N-181119-060105 NEUTRAL
 Project : (FC) 961001
 mode : Mode 6
 : 866498040025776/866498040025784 #20

	Freq	Level	Over	Limit	Read	LISN	Cable	Remark
	MHz	dBuV	Limit	Line	Level	Factor	Loss	
			dB	dBuV	dBuV	dB	dB	
1	0.162	37.83	-27.55	65.38	27.20	0.18	10.45	QP
2	0.162	22.23	-33.15	55.38	11.60	0.18	10.45	Average
3	0.182	35.38	-29.04	64.42	24.80	0.18	10.40	QP
4	0.182	21.78	-32.64	54.42	11.20	0.18	10.40	Average
5	0.216	32.72	-30.24	62.96	22.20	0.17	10.35	QP
6	0.216	21.82	-31.14	52.96	11.30	0.17	10.35	Average
7	0.474	35.49	-20.96	56.45	25.10	0.15	10.24	QP
8 *	0.474	33.29	-13.16	46.45	22.90	0.15	10.24	Average
9	4.092	29.23	-26.77	56.00	18.81	0.17	10.25	QP
10	4.092	22.03	-23.97	46.00	11.61	0.17	10.25	Average
11	4.647	28.64	-27.36	56.00	18.20	0.18	10.26	QP
12	4.647	21.64	-24.36	46.00	11.20	0.18	10.26	Average



3.2. Test of Radiated Emission Measurement

3.2.1. Limit of Radiated Emission

The emissions from an unintentional radiator shall not exceed the field strength levels specified in the following table:

<Class B Limit>

Frequency (MHz)	Field Strength (microvolts/meter)	Measurement Distance (meters)
30 – 88	100	3
88 – 216	150	3
216 - 960	200	3
Above 960	500	3

3.2.2. Measuring Instruments

The measuring equipment is listed in the section 4 of this test report.

3.2.3. Test Procedures

1. The EUT was placed on a turntable with 0.8 meter above ground.
2. The EUT was set 3 meters from the interference receiving antenna, which was mounted on the top of a variable height antenna tower.
3. The table was rotated 360 degrees to determine the position of the highest radiation.
4. The antenna is a Bi-Log antenna and its height is adjusted between one to four meters above ground to find the maximum value of the field strength for both horizontal polarization and vertical polarization of the antenna.
5. For each suspected emission, the EUT was arranged to its worst case and then tune the antenna tower (from 1 m to 4 m) and turntable (from 0 degree to 360 degrees) to find the maximum reading.
6. Set the test-receiver system to Peak Detect Function and specified bandwidth with Maximum Hold Mode (RBW=120kHz/VBW=300kHz for frequency below 1GHz; RBW=1MHz VBW=3MHz (Peak), RBW=1MHz/VBW=10Hz (Average) for frequency above 1GHz).
7. If the emission level of the EUT in peak mode was 3 dB lower than the limit specified, peak values of EUT will be reported. Otherwise, the emission will be repeated by using the quasi-peak method and reported.
8. Emission level (dBµV/m) = 20 log Emission level (µV/m)
9. Corrected Reading: Antenna Factor + Cable Loss + Read Level - Preamp Factor = Level

3.2.4. Test Setup of Radiated Emission

For radiated emissions from 30MHz to 1GHz

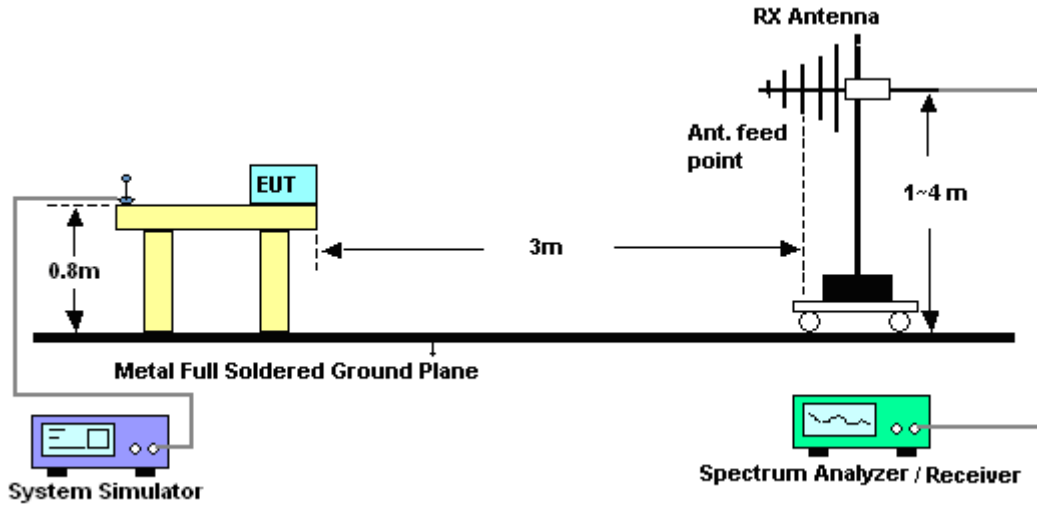

For radiated emissions above 1GHz

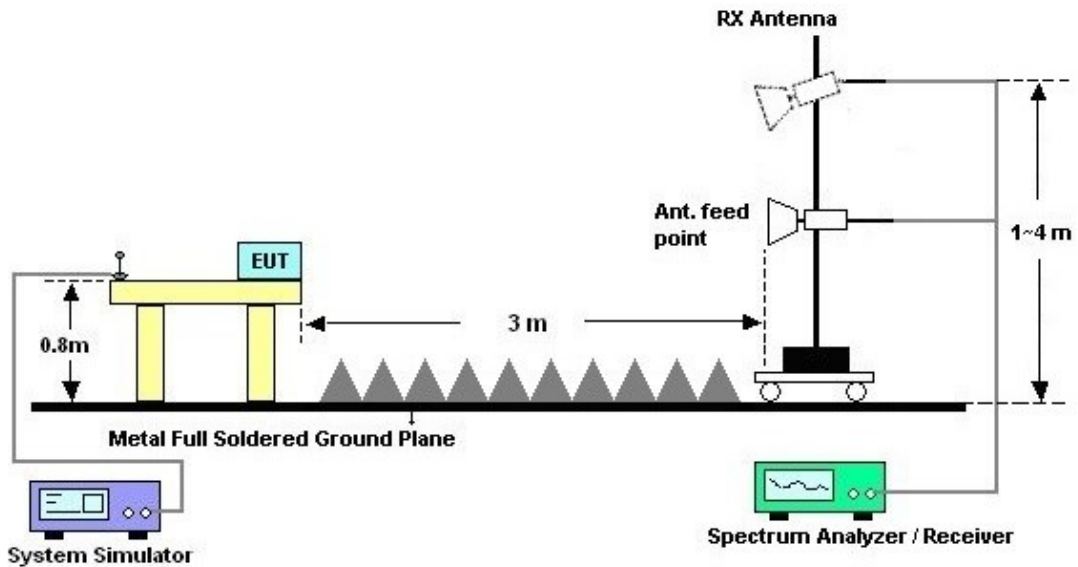



3.2.5. Test Result of Radiated Emission

Test Engineer :	Carl Ni	Temperature :	21~22°C
		Relative Humidity :	41~42%
Test Distance :	3m	Polarization :	Horizontal

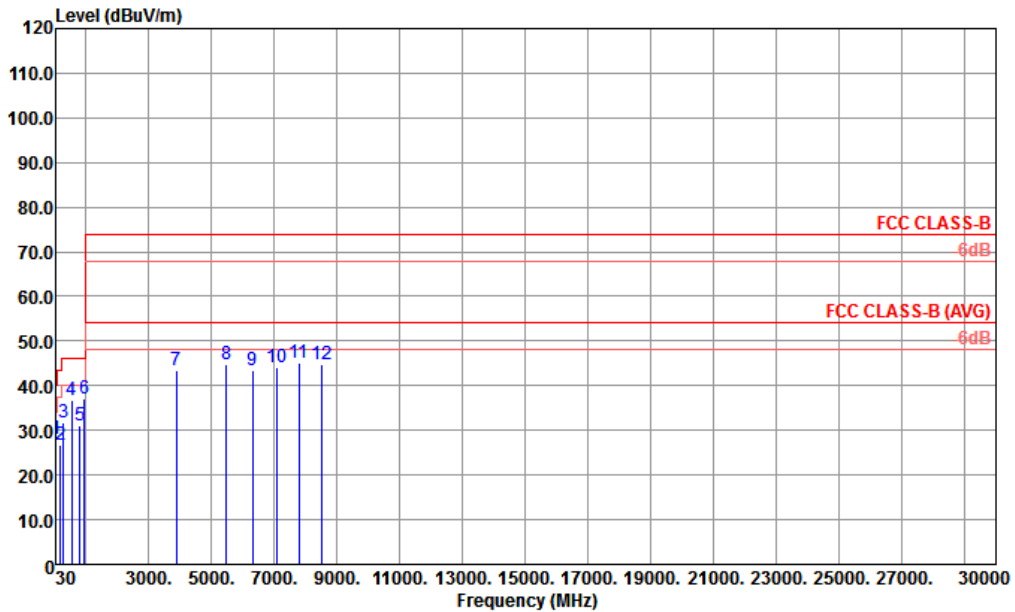

Site : 03CH02-KS
 Condition : FCC CLASS-B 3m LF 49922-3M HORIZONTAL
 Project : (FC)961001
 Mode : 7
 IMEI : 866498040025594/5602 #21

	Freq	Level	Over Limit	Limit Line	ReadAntenna Level	Antenna Factor	Cable Loss	Preamp Factor	A/Pos	T/Pos	Remark
	MHz	dBuV/m	dB	dBuV/m	dBuV	dB/m	dB	dB	cm	deg	
1	47.46	28.13	-11.87	40.00	43.36	15.90	0.81	31.94	---	---	Peak
2	187.14	26.62	-16.88	43.50	41.32	15.64	1.57	31.91	---	---	Peak
3	276.38	31.89	-14.11	46.00	42.97	19.02	1.92	32.02	---	---	Peak
4	533.43	36.88	-9.12	46.00	41.61	24.97	2.61	32.31	---	---	Peak
5	797.27	31.19	-14.81	46.00	31.84	28.22	3.26	32.13	---	---	Peak
6	936.95	37.02	-8.98	46.00	34.14	30.47	3.52	31.11	100	0	Peak
7	3880.00	43.51	-30.49	74.00	34.52	33.66	7.32	31.99	---	---	Peak
8	5464.00	44.76	-29.24	74.00	32.56	34.48	8.77	31.05	---	---	Peak
9	6304.00	43.53	-30.47	74.00	30.53	35.11	9.45	31.56	---	---	Peak
10	7104.00	44.17	-29.83	74.00	30.04	35.49	10.03	31.39	---	---	Peak
11	7776.00	45.07	-28.93	74.00	30.15	36.14	10.80	32.02	---	---	Peak
12	8496.00	44.73	-29.27	74.00	28.94	36.50	11.24	31.95	---	---	Peak

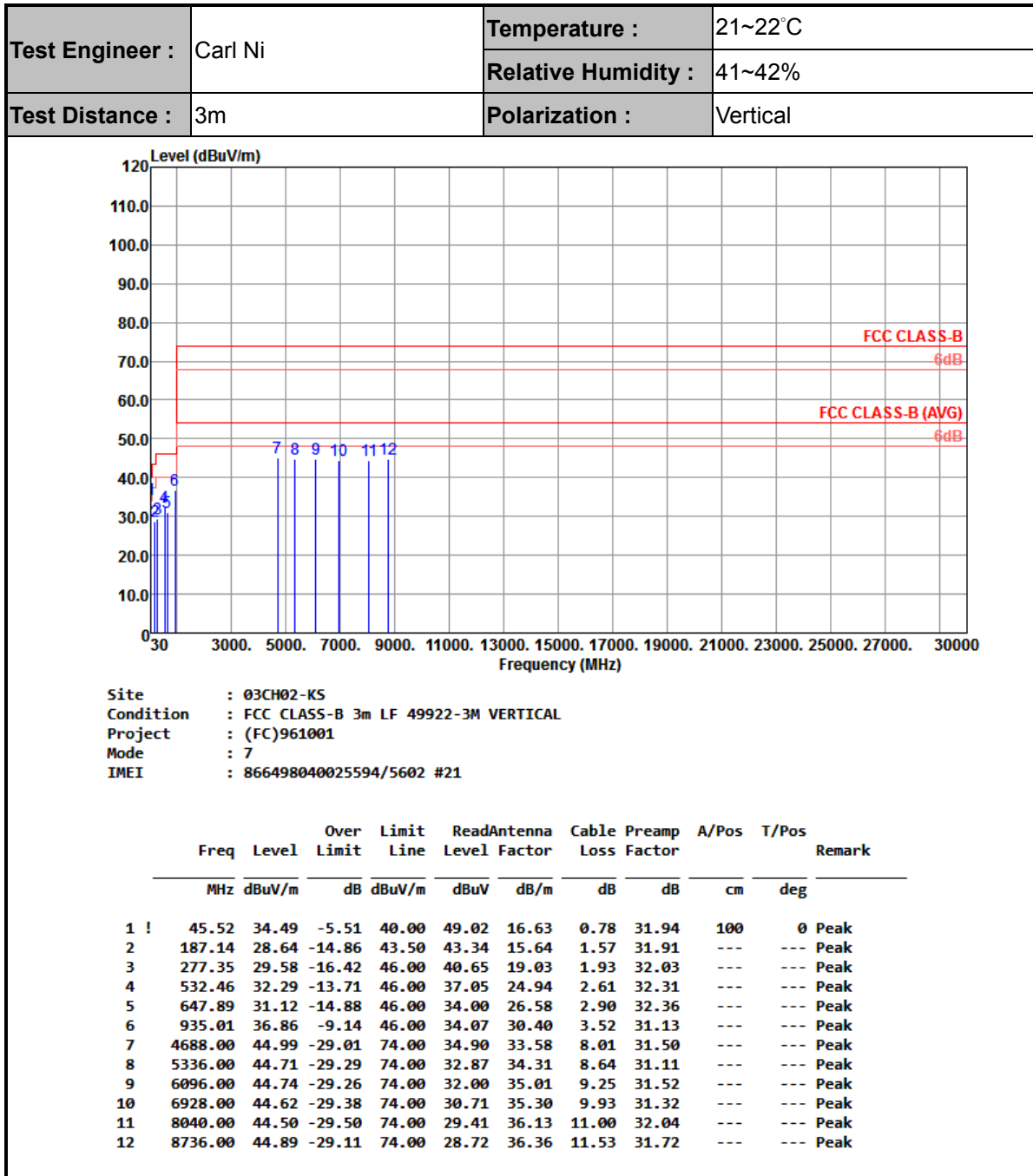



4. List of Measuring Equipment

Instrument	Manufacturer	Model No.	Serial No.	Characteristics	Calibration Date	Test Date	Due Date	Remark
EMI Receiver	R&S	ESC17	100768	9kHz~7GHz;	Apr. 16, 2019	Aug. 05, 2019	Apr. 15, 2020	Conduction (CO01-KS)
AC LISN	MessTec	AN3016	060103	9kHz~30MHz	Oct. 12, 2018	Aug. 05, 2019	Oct. 11, 2019	Conduction (CO01-KS)
AC LISN (for auxiliary equipment)	MessTec	AN3016	060105	9kHz~30MHz	Nov. 19, 2018	Aug. 05, 2019	Nov. 18, 2019	Conduction (CO01-KS)
AC Power Source	Chroma	61602	ABP000000811	AC 0V~300V, 45Hz~1000Hz	Oct. 12, 2018	Aug. 05, 2019	Oct. 11, 2019	Conduction (CO01-KS)
EMI Test Receiver	R&S	ESR7	101403	9kHz~7GHz;Max 30dBm	Aug. 06, 2018	Jul. 31, 2019	Aug. 05, 2019	Radiation (03CH02-KS)
EXA Spectrum Analyzer	Keysight	N9010A	MY55150208	10Hz-44G,MAX 30dB	Apr. 16, 2019	Jul. 31, 2019	Apr. 15, 2020	Radiation (03CH02-KS)
Bilog Antenna	TeseQ	CBL6112D	23182	30MHz-2GHz	Dec. 29, 2018	Jul. 31, 2019	Dec. 28, 2019	Radiation (03CH02-KS)
Double Ridge Horn Antenna	ETS-Lindgren	3117	75959	1GHz~18GHz	Jan. 27, 2019	Jul. 31, 2019	Jan. 26, 2020	Radiation (03CH02-KS)
SHF-EHF Horn	Com-power	AH-840	101070	18GHz~40GHz	Jan. 05, 2019	Jul. 31, 2019	Jan. 04, 2020	Radiation (03CH02-KS)
Amplifier	MITEQ	TTA1840-35-HG	1887435	18~40GHz	Jan. 14, 2019	Jul. 31, 2019	Jan. 13, 2020	Radiation (03CH02-KS)
Amplifier	SONOMA	310N	187289	9KHz-1GHz	Aug. 06, 2018	Jul. 31, 2019	Aug. 05, 2019	Radiation (03CH02-KS)
Amplifier	Keysight	83017A	MY57280106	500MHz~26.5G Hz	Apr. 15, 2019	Jul. 31, 2019	Apr. 14, 2020	Radiation (03CH02-KS)
AC Power Source	Chroma	61601	616010002473	N/A	NCR	Jul. 31, 2019	NCR	Radiation (03CH02-KS)
Turn Table	MF	MF7802	N/A	0~360 degree	NCR	Jul. 31, 2019	NCR	Radiation (03CH02-KS)
Antenna Mast	MF	MF7802	N/A	1 m~4 m	NCR	Jul. 31, 2019	NCR	Radiation (03CH02-KS)

NCR: No Calibration Required



5. Uncertainty of Evaluation

Uncertainty of Conducted Emission Measurement (150 kHz ~ 30 MHz)

Measuring Uncertainty for a Level of Confidence of 95% ($U = 2Uc(y)$)	2.9dB
---	-------

Uncertainty of Radiated Emission Measurement (30 MHz ~ 1000 MHz)

Measuring Uncertainty for a Level of Confidence of 95% ($U = 2Uc(y)$)	4.9dB
---	-------

Uncertainty of Radiated Emission Measurement (1000 MHz ~ 18000 MHz)

Measuring Uncertainty for a Level of Confidence of 95% ($U = 2Uc(y)$)	5.0dB
---	-------

Uncertainty of Radiated Emission Measurement (18000 MHz ~ 40000 MHz)

Measuring Uncertainty for a Level of Confidence of 95% ($U = 2Uc(y)$)	5.1dB
---	-------