



Test Report No.: RF190712W002-5



FCC TEST REPORT (PART 27)



Applicant:	Xiaomi Communications Co., Ltd.
Address:	The Rainbow City of China Resources, NO.68, Qinghe Middle Street, Haidian District, Beijing, China

Manufacturer or Supplier:	Xiaomi Communications Co., Ltd.
Address:	The Rainbow City of China Resources, NO.68, Qinghe Middle Street, Haidian District, Beijing, China
Product:	Mobile Phone
Brand Name:	XIAOMI
Model Name:	M1904F3BG
FCC ID:	2AFZZF3BG
Date of tests:	Jul 13, 2019 ~ Aug 07, 2019

The tests have been carried out according to the requirements of the following standard:

- FCC Part 27, Subpart C, L ANSI/TIA/EIA-603- D
- FCC Part 2 ANSI/TIA/EIA-603-E ANSI C63.26-2015

CONCLUSION: The submitted sample was found to COMPLY with the test requirement

Prepared by Alex Chen Engineer / Mobile Department	Approved by Luke Lu Manager / Mobile Department
 Date: Aug 13, 2019	 Date: Aug 13, 2019

This report is governed by, and incorporates by reference, CPS Conditions of Service as posted at the date of issuance of this report at <http://www.bureauveritas.com/home/about-us/our-business/cps/about-us/terms-conditions> and is intended for your exclusive use. Any copying or replication of this report to or for any other person or entity, or use of our name or trademark, is permitted only with our prior written permission. This report sets forth our findings solely with respect to the test samples identified herein. The results set forth in this report are not indicative or representative of the quality or characteristics of the lot from which a test sample was taken or any similar or identical product unless specifically and expressly noted. Our report includes all of the tests requested by you and the results thereof based upon the information that you provided to us. Measurement uncertainty is only provided upon request for accredited tests. You have 60 days from date of issuance of this report to notify us of any material error or omission caused by our negligence or if you require measurement uncertainty; provided, however, that such notice shall be in writing and shall specifically address the issue you wish to raise. A failure to raise such issue within the prescribed time shall constitute your unqualified acceptance of the completeness of this report, the tests conducted and the correctness of the report contents.



TABLE OF CONTENTS

RELEASE CONTROL RECORD 4

1 SUMMARY OF TEST RESULTS 5

1.1 MEASUREMENT UNCERTAINTY 5

1.2 TEST SITE AND INSTRUMENTS 6

2 GENERAL INFORMATION 7

2.1 GENERAL DESCRIPTION OF EUT 7

2.2 CONFIGURATION OF SYSTEM UNDER TEST 10

2.3 DESCRIPTION OF SUPPORT UNITS 11

2.4 DESCRIPTION OF TEST MODES 11

2.5 GENERAL DESCRIPTION OF APPLIED STANDARDS 14

3 TEST TYPES AND RESULTS 15

3.1 OUTPUT POWER MEASUREMENT 15

3.1.1 LIMITS OF OUTPUT POWER MEASUREMENT 15

3.1.2 TEST PROCEDURES 15

3.1.3 TEST SETUP 16

3.1.4 TEST RESULTS 17

3.2 FREQUENCY STABILITY MEASUREMENT 38

3.2.1 LIMITS OF FREQUENCY STABILITY MEASUREMENT 38

3.2.2 TEST PROCEDURE 38

3.2.3 TEST SETUP 38

3.2.4 TEST RESULTS 39

3.3 OCCUPIED BANDWIDTH MEASUREMENT 46

3.3.1 LIMITS OF OCCUPIED BANDWIDTH MEASUREMENT 46

3.3.2 TEST SETUP 46

3.3.3 TEST PROCEDURES 46

3.3.4 TEST RESULTS 47

3.4 PEAK TO AVERAGE RATIO 54

3.4.1 LIMITS OF PEAK TO AVERAGE RATIO MEASUREMENT 54

3.4.2 TEST SETUP 54

3.4.3 TEST PROCEDURES 54

3.4.4 TEST RESULTS 55

3.5 BAND EDGE MEASUREMENT 64

3.5.1 LIMITS OF BAND EDGE MEASUREMENT 64

3.5.2 TEST SETUP 64

3.5.3 TEST PROCEDURES 65

3.5.4 TEST RESULTS 66

3.6 CONDUCTED SPURIOUS EMISSIONS 85

3.6.1 LIMITS OF CONDUCTED SPURIOUS EMISSIONS MEASUREMENT 85

3.6.2 TEST PROCEDURE 85

3.6.3 TEST SETUP 85

3.6.4 TEST RESULTS 86

3.7 RADIATED EMISSION MEASUREMENT 93

3.7.1 LIMITS OF RADIATED EMISSION MEASUREMENT 93

3.7.2 TEST PROCEDURES 93

3.7.3 DEVIATION FROM TEST STANDARD 93

3.7.4 TEST SETUP 94

3.7.5 TEST RESULTS 95



**BUREAU
VERITAS**

Test Report No.: RF190712W002-5

4	INFORMATION ON THE TESTING LABORATORIES	143
5	APPENDIX A – MODIFICATIONS RECORDERS FOR ENGINEERING CHANGES TO THE EUT BY THE LAB	144



Test Report No.: RF190712W002-5

RELEASE CONTROL RECORD

ISSUE NO.	REASON FOR CHANGE	DATE ISSUED
RF190712W002-5	Original release	Aug 13, 2019

1 SUMMARY OF TEST RESULTS

The EUT has been tested according to the following specifications:

APPLIED STANDARD: FCC Part 27 & Part 2			
STANDARD SECTION	TEST TYPE AND LIMIT	RESULT	REMARK
2.1046 27.50(d)(4)	Maximum Peak Output Power	PASS	Meet the requirement of limit.
2.1055 27.54	Frequency Stability	PASS	Meet the requirement of limit.
2.1049 27.53(h)	Occupied Bandwidth	PASS	Meet the requirement of limit.
27.50(d)(5)	Peak to average ratio	PASS	Meet the requirement of limit.
27.53(h)	Band Edge Measurements	PASS	Meet the requirement of limit.
2.1051 27.53(h)	Conducted Spurious Emissions	PASS	Meet the requirement of limit.
2.1053 27.53(h)	Radiated Spurious Emissions	PASS	Meet the requirement of limit. Minimum passing margin is -13.00 dB at 152.320MHz.

1.1 MEASUREMENT UNCERTAINTY

Where relevant, the following measurement uncertainty levels have been estimated for tests performed on the EUT as specified in CISPR 16-4-2:

MEASUREMENT	UNCERTAINTY
Frequency Stability	± 76.97Hz
Radiated emissions & Radiated Power (30MHz~1GMHz)	±4.98dB
Radiated emissions & Radiated Power (1GMHz ~6GMHz)	±4.70dB
Radiated emissions (6GMHz ~18GMHz)	±4.60dB
Radiated emissions (18GMHz ~40GMHz)	±4.12dB
Conducted emissions	±4.01dB
Occupied Channel Bandwidth	±43.58KHz
Conducted Output power	±2.06dB
Band Edge Measurements	±4.70dB
Peak to average ratio	±0.76dB

This uncertainty represents an expanded uncertainty expressed at approximately the 95% confidence level using a coverage factor of k=2.



Test Report No.: RF190712W002-5

1.2 TEST SITE AND INSTRUMENTS

Equipment	Manufacturer	Model No.	Serial No.	Last Cal.	Next Cal.
MXE EMI Receiver	KEYSIGHT	N9038A-544	MY54450026	Feb. 26,19	Feb. 25,20
EXA Signal Analyzer	KEYSIGHT	N9010A-526	MY54510322	Feb. 26,19	Feb. 25,20
Bilog Antenna	ETS-LINDGREN	3143B	00161965	Feb. 26,19	Feb. 25,20
Horn Antenna (1GHz-18GHz)	ETS-LINDGREN	3117	00168692	Nov. 30, 18	Nov. 29, 19
Horn Antenna (18GHz-40GHz)	N/A	QWH-SL-18-40 -K-SG/QMS-00 361	15433	Nov. 21, 18	Nov. 20, 19
Radio Communication Analyzer	ANRITSU	MT8820C	6201465426	Feb. 26,19	Feb. 25,20
Signal Pre-Amplifier	EMSI	EMC 9135	980249	Jun. 24,19	Jun. 23,20
Signal Pre-Amplifier	EMSI	EMC 012645B	980257	Jun. 24,19	Jun. 23,20
Signal Pre-Amplifier	EMSI	EMC 184045B	980259	Jun. 24,19	Jun. 23,20
3m Semi-anechoic Chamber	ETS-LINDGREN	9m*6m*6m	Euroshieldpn- CT0001143-1216	Feb. 26,19	Feb. 25,20
Test Software	E3	V 9.160323	N/A	N/A	N/A
Test Software	ADT	ADT_Radiated _V7.6.15.9.2	N/A	N/A	N/A
10dB Attenuator	JFW/USA	50HF-010-SM A	1505	Jun. 24,19	Jun. 23,20
Power Meter	Anritsu	ML2495A	1506002	Feb. 26,19	Feb. 25,20
Power Sensor	Anritsu	MA2411B	1339352	Feb. 26,19	Feb. 25,20
Humid & Temp Programmable Tester	Juyi	ITH-120-45-CP -AR	IAA1504-001	Jun. 24,19	Jun. 23,20
MXG Analog Microvave Signal Generator	KEYSIGHT	N5183A	MY50143024	Feb. 26,19	Feb. 25,20
Power Divider	MCLI/USA	PS2-15	24880	Jul. 09,19	Jul. 08,20

- NOTE:**
1. The calibration interval of the above test instruments is 12 months or 24 months and the calibrations are traceable to CEPREI/CHINA, GRGT/CHINA and NIM/CHINA.
 2. The test was performed in 3m Semi-anechoic Chamber and RF Oven Room.
 3. The horn antenna is used only for the measurement of emission frequency above 1GHz if tested.
 4. The FCC Site Registration No. is 525120; The Designation No. is CN1171.

2 GENERAL INFORMATION

2.1 GENERAL DESCRIPTION OF EUT

PRODUCT	Mobile Phone	
BRAND NAME	XIAOMI	
MODEL NAME	M1904F3BG	
POWER SUPPLY	5V/9V/12Vdc (adapter or host equipment) 3.85Vdc (Li-ion, battery) $V_{min}=3.6V, V_{nor}=3.85V, V_{max}=4.4V$	
MODULATION TECHNOLOGY	WCDMA	BPSK, QPSK
	LTE	QPSK, 16QAM, 64QAM
FREQUENCY RANGE	WCDMA IV	1712.4MHz ~ 1752.6MHz
	LTE Band 4 Channel Bandwidth: 1.4MHz	1710.7MHz ~ 1754.3MHz
	LTE Band 4 Channel Bandwidth: 3MHz	1711.5MHz ~ 1753.5MHz
	LTE Band 4 Channel Bandwidth: 5MHz	1712.5MHz ~ 1752.5MHz
	LTE Band 4 Channel Bandwidth: 10MHz	1715.0MHz ~ 1750.0MHz
	LTE Band 4 Channel Bandwidth: 15MHz	1717.5MHz ~ 1747.5MHz
	LTE Band 4 Channel Bandwidth: 20MHz	1720.0MHz ~ 1745.0MHz
EMISSION DESIGNATOR	WCDMA IV	4M16F9W
	LTE Band 4 Channel Bandwidth: 1.4MHz	QPSK: 1M08G7D
		16QAM: 1M08W7D
		64QAM: 1M08W7D
	LTE Band 4 Channel Bandwidth: 3MHz	QPSK: 2M68G7D
		16QAM: 2M68W7D
		64QAM: 2M68W7D
	LTE Band 4 Channel Bandwidth: 5MHz	QPSK: 4M47G7D
		16QAM: 4M47W7D
		64QAM: 4M48W7D
	LTE Band 4 Channel Bandwidth: 10MHz	QPSK: 8M95G7D
		16QAM: 8M93W7D
64QAM: 8M94W7D		



EMISSION DESIGNATOR	LTE Band 4 Channel Bandwidth: 15MHz	QPSK: 13M4G7D
		16QAM: 13M4W7D
		64QAM: 13M4W7D
	LTE Band 4 Channel Bandwidth: 20MHz	QPSK: 17M9G7D
		16QAM: 17M9W7D
		64QAM: 17M9W7D
MAX. ERP/EIRP POWER	WCDMA IV	WWAN-ANT-0: 213mw WWAN-ANT-1: 53mw
	LTE Band 4 Channel Bandwidth: 1.4MHz	WWAN-ANT-0: 173mw WWAN-ANT-1: 41mw
	LTE Band 4 Channel Bandwidth: 3MHz	WWAN-ANT-0: 175mw WWAN-ANT-1: 42mw
	LTE Band 4 Channel Bandwidth: 5MHz	WWAN-ANT-0: 169mw WWAN-ANT-1: 40mw
	LTE Band 4 Channel Bandwidth: 10MHz	WWAN-ANT-0: 175mw WWAN-ANT-1: 42mw
	LTE Band 4 Channel Bandwidth: 15MHz	WWAN-ANT-0: 171mw WWAN-ANT-1: 41mw
	LTE Band 4 Channel Bandwidth: 20MHz	WWAN-ANT-0: 153mw WWAN-ANT-1: 36mw
ANTENNA TYPE	Main Antenna(ANT 0): Fixed Internal Antenna with 0.66dBi gain for WCDMA IV/ LTE Band 4 Diversity Antenna(ANT 1): Fixed Internal Antenna with -6.89dBi gain for WCDMA IV/ LTE Band 4	
HW VERSION	P1	
SW VERSION	MIUI 10	
ACCESSORY DEVICE	Refer to user's manual	
DATA CABLE	USB cable: non-shielded, detachable, 1m Earphone cable: non-shielded, detachable, 1.25m	

NOTE:

1. For a more detailed features description, please refer to the manufacturer's specifications or the user's manual.
2. For the test results, the EUT had been tested with all conditions. But only the worst case was shown in test report.



**BUREAU
VERITAS**

Test Report No.: RF190712W002-5

List of Accessories:

ACCESSORIES	BRAND	MODEL	MANUFACTURER	SPECIFICATION
Battery	MI	BM4F	Sunwoda Electronic Co., Ltd	Rating: 3.85Vdc, 4030mAh
AC Adapter	MI	MDY-10-ED	Jiansu Chenyang Electron Co., Ltd	I/P: 100 - 240 Vac, 0.5 A O/P: 5 Vdc, 3A or 9 Vdc, 2 A or 12 Vdc, 1.5A
USB Cable 1	MI	K23312	Suzhou Keli Science&Technology Development Co., Ltd	1.0m non-shielded cable, with w/o ferrite core
Earphone	MI	EM023	One More Acoustics Technology Co., Ltd	1.25m non-shielded cable, with w/o ferrite core

2.2 CONFIGURATION OF SYSTEM UNDER TEST

FOR RADIATION EMISSION TEST

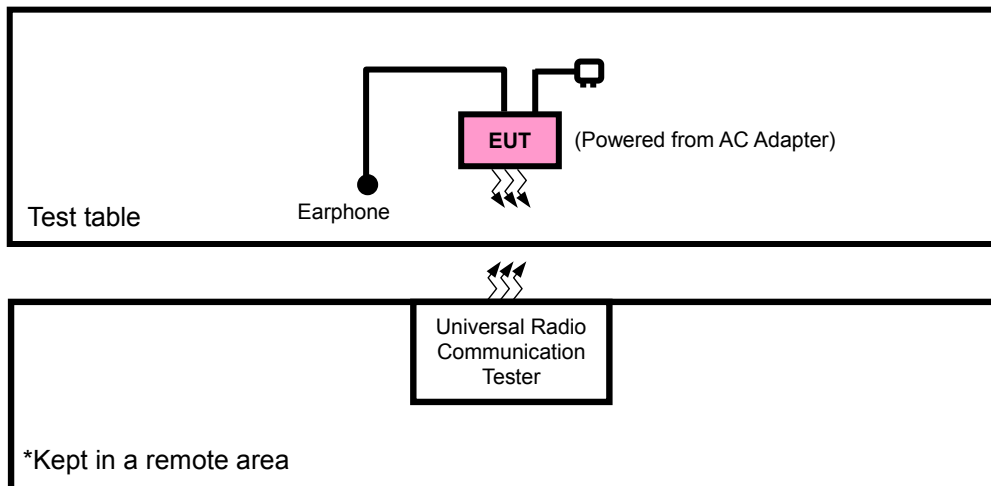



2.3 DESCRIPTION OF SUPPORT UNITS

The EUT has been tested as an independent unit together with other necessary accessories or support units. The following support units or accessories were used to form a representative test configuration during the tests.

NO.	PRODUCT	BRAND	MODEL NO.	SERIAL NO.	FCC ID
1	DC source	LONG WEI	PS-6403D	010934269	N/A

NO.	SIGNAL CABLE DESCRIPTION OF THE ABOVE SUPPORT UNITS
1	DC Line: Unshielded, Detachable 1.8m

NOTE:

1. All power cords of the above support units are non shielded (1.8m).

2.4 DESCRIPTION OF TEST MODES

Pre-Scan has been conducted to determine the worst-case mode from all possible combinations between available modulations, data rates, XYZ axis and antenna ports. The worst case in ERP/EIRP and radiated emission was found when positioned on X-plane for WCDMA /LTE. Following channel(s) was (were) selected for the final test as listed below:

EUT CONFIGURE MODE	DESCRIPTION
A	EUT + Adapter + USB Cable + Earphone with WCDMA or LTE link
B	EUT + Battery with WCDMA or LTE link

WCDMA MODE

EUT CONFIGURE MODE	TEST ITEM	AVAILABLE CHANNEL	TESTED CHANNEL	MODE
B	EIRP	1312 to 1513	1312, 1413, 1513	WCDMA
B	FREQUENCY STABILITY	1312 to 1513	1312, 1513	WCDMA
B	OCCUPIED BANDWIDTH	1312 to 1513	1312, 1413, 1513	WCDMA
B	BAND EDGE	1312 to 1513	1312, 1513	WCDMA
B	PEAK TO AVERAGE RATIO	1312 to 1513	1312, 1413, 1513	WCDMA
B	CONDCUDED EMISSION	1312 to 1513	1312, 1413, 1513	WCDMA
A	RADIATED EMISSION	1312 to 1513	1312, 1413, 1513	WCDMA



Test Report No.: RF190712W002-5

LTE BAND 4

EUT CONFIGURE MODE	TEST ITEM	AVAILABLE CHANNEL	TESTED CHANNEL	CHANNEL BANDWIDTH	MODULATION	MODE	
B	EIRP	19957 to 20393	19957, 20175, 20393	1.4MHz	QPSK, 16QAM, 64QAM	1 RB / 0 RB Offset	
		19965 to 20385	19965, 20175, 20385	3MHz	QPSK, 16QAM, 64QAM	1 RB / 0 RB Offset	
		19975 to 20375	19975, 20175, 20375	5MHz	QPSK, 16QAM, 64QAM	1 RB / 0 RB Offset	
		20000 to 20350	20000, 20175, 20350	10MHz	QPSK, 16QAM, 64QAM	1 RB / 0 RB Offset	
		20025 to 20325	20025, 20175, 20325	15MHz	QPSK, 16QAM, 64QAM	1 RB / 0 RB Offset	
		20050 to 20300	20050, 20175, 20300	20MHz	QPSK, 16QAM, 64QAM	1 RB / 0 RB Offset	
B	FREQUENCY STABILITY	19957 to 20393	19957, 20393	1.4MHz	QPSK	1 RB / 0 RB Offset	
		19965 to 20385	19965, 20385	3MHz	QPSK	1 RB / 0 RB Offset	
		19975 to 20375	19975, 20375	5MHz	QPSK	1 RB / 0 RB Offset	
		20000 to 20350	20000, 20350	10MHz	QPSK	1 RB / 0 RB Offset	
		20025 to 20325	20025, 20325	15MHz	QPSK	1 RB / 0 RB Offset	
		20050 to 20300	20050, 20300	20MHz	QPSK	1 RB / 0 RB Offset	
B	OCCUPIED BANDWIDTH	19957 to 20393	19957, 20175, 20393	1.4MHz	QPSK, 16QAM, 64QAM	6 RB / 0 RB Offset	
		19965 to 20385	19965, 20175, 20385	3MHz	QPSK, 16QAM, 64QAM	15 RB / 0 RB Offset	
		19975 to 20375	19975, 20175, 20375	5MHz	QPSK, 16QAM, 64QAM	25 RB / 0 RB Offset	
		20000 to 20350	20000, 20175, 20350	10MHz	QPSK, 16QAM, 64QAM	50 RB / 0 RB Offset	
		20025 to 20325	20025, 20175, 20325	15MHz	QPSK, 16QAM, 64QAM	75 RB / 0 RB Offset	
		20050 to 20300	20050, 20175, 20300	20MHz	QPSK, 16QAM, 64QAM	100 RB / 0 RB Offset	
B	PEAK TO AVERAGE RATIO	19957 to 20393	19957, 20175, 20393	1.4MHz	QPSK, 16QAM, 64QAM	1 RB / 0 RB Offset	
		19965 to 20385	19965, 20175, 20385	3MHz	QPSK, 16QAM, 64QAM	1 RB / 0 RB Offset	
		19975 to 20375	19975, 20175, 20375	5MHz	QPSK, 16QAM, 64QAM	1 RB / 0 RB Offset	
		20000 to 20350	20000, 20175, 20350	10MHz	QPSK, 16QAM, 64QAM	1 RB / 0 RB Offset	
		20025 to 20325	20025, 20175, 20325	15MHz	QPSK, 16QAM, 64QAM	1 RB / 0 RB Offset	
		20050 to 20300	20050, 20175, 20300	20MHz	QPSK, 16QAM, 64QAM	1 RB / 0 RB Offset	
B	BAND EDGE	19957 to 20393	19957	1.4MHz	QPSK, 16QAM, 64QAM	1 RB / 0 RB Offset	
			20393	1.4MHz	QPSK, 16QAM, 64QAM	6 RB / 0 RB Offset	
		19965 to 20385	19965	3MHz	QPSK, 16QAM, 64QAM	1 RB / 0 RB Offset	
			20385	3MHz	QPSK, 16QAM, 64QAM	15 RB / 0 RB Offset	
		19975 to 20375	19975	5MHz	QPSK, 16QAM, 64QAM	1 RB / 0 RB Offset	
			20375	5MHz	QPSK, 16QAM, 64QAM	25 RB / 0 RB Offset	
		20000 to 20350	20000	10MHz	QPSK, 16QAM, 64QAM	1 RB / 0 RB Offset	
			20350	10MHz	QPSK, 16QAM, 64QAM	50 RB / 0 RB Offset	
							1 RB / 5 RB Offset
							1 RB / 14 RB Offset
							1 RB / 24 RB Offset
							1 RB / 49 RB Offset

B	BAND EDGE	20025 to 20325	20025	15MHz	QPSK, 16QAM, 64QAM	1 RB / 0 RB Offset 75 RB / 0 RB Offset		
			20325	15MHz	QPSK, 16QAM, 64QAM	1 RB / 74 RB Offset 75 RB / 0 RB Offset		
		20050 to 20300	20050	20MHz	QPSK, 16QAM, 64QAM	1 RB / 0 RB Offset 100 RB / 0 RB Offset		
			20300	20MHz	QPSK, 16QAM, 64QAM	1 RB / 99 RB Offset 100 RB / 0 RB Offset		
		B	CONDCUDED EMISSION	19957 to 20393	19957, 20175, 20393	1.4MHz	QPSK	1 RB / 0 RB Offset
				19965 to 20385	19965, 20175, 20385	3MHz	QPSK	1 RB / 0 RB Offset
19975 to 20375	19975, 20175, 20375			5MHz	QPSK	1 RB / 0 RB Offset		
20000 to 20350	20000, 20175, 20350			10MHz	QPSK	1 RB / 0 RB Offset		
20025 to 20325	20025, 20175, 20325			15MHz	QPSK	1 RB / 0 RB Offset		
20050 to 20300	20050, 20175, 20300			20MHz	QPSK	1 RB / 0 RB Offset		
A	RADIATED EMISSION	19957 to 20393	20175	1.4MHz	QPSK	1 RB / 0 RB Offset		
		19965 to 20385	19965, 20175, 20385	3MHz	QPSK	1 RB / 0 RB Offset		
		19975 to 20375	20175	5MHz	QPSK	1 RB / 0 RB Offset		
		20000 to 20350	20175	10MHz	QPSK	1 RB / 0 RB Offset		
		20025 to 20325	20175	15MHz	QPSK	1 RB / 0 RB Offset		
		20050 to 20300	20175	20MHz	QPSK	1 RB / 0 RB Offset		

Note: This device was tested under all bandwidths, RB configurations and modulations. The worst case was found in QPSK modulation.

TEST CONDITION:

TEST ITEM	ENVIRONMENTAL CONDITIONS	INPUT POWER	TESTED BY
EIRP	24deg. C, 60%RH	3.85Vdc from Battery	Star Le
FREQUENCY STABILITY	24deg. C, 61%RH	DC 3.6V/3.85V/4.4V	Walker Ye
OCCUPIED BANDWIDTH	24deg. C, 61%RH	3.85Vdc from Battery	Walker Ye
PEAK TO AVERAGE RATIO	24deg. C, 61%RH	3.85Vdc from Battery	Walker Ye
BAND EDGE	24deg. C, 61%RH	3.85Vdc from Battery	Walker Ye
CONDCUDED EMISSION	24deg. C, 61%RH	3.85Vdc from Battery	Walker Ye
RADIATED EMISSION	23deg. C, 70%RH	DC 5V/9V/12V from adaptor	Star Le



Test Report No.: RF190712W002-5

2.5 GENERAL DESCRIPTION OF APPLIED STANDARDS

The EUT is a RF product. According to the specifications of the manufacturer, it must comply with the requirements of the following standards:

FCC 47 CFR Part 2

FCC 47 CFR Part 27

KDB 971168 D01 Power Meas License Digital Systems v03r01

ANSI/TIA/EIA-603-D

ANSI/TIA/EIA-603-E

ANSI C63.26-2015

NOTE: All test items have been performed and recorded as per the above standards.



3 TEST TYPES AND RESULTS

3.1 OUTPUT POWER MEASUREMENT

3.1.1 LIMITS OF OUTPUT POWER MEASUREMENT

Fixed, mobile, and portable (hand-held) stations operating in the 1710–1755 MHz band are limited to 1 watt EIRP.

3.1.2 TEST PROCEDURES

EIRP / ERP MEASUREMENT:

- a. The EUT was set up for the maximum power with LTE link data modulation. The power was measured with R&S Spectrum Analyzer. All measurements were done at 3 channels (low, middle and high operational frequency range). RBW and VBW is 10MHz for LTE.
- b. E.I.R.P power measurement. In the semi-anechoic chamber, EUT placed on the 0.8m height of Turn Table, rotated the table around 360 degrees to search the maximum radiation power and receiver antenna shall be rotated vertical and horizontal polarization and moved height from 1m to 4m to find the maximum polar radiated power. The “Read Value” is the spectrum reading the maximum power value.
- c. The substitution horn antenna is substituted for EUT at the same position and signals generator export the CW signal to the substitution antenna via a TX cable. Rotated the Turn Table and moved receiving antenna to find the maximum radiation power. Adjust output power level of S.G to get a Value of spectrum reading equal to “Read Value” of step a. Record the power level of S.G
- d. $EIRP = \text{Output power level of S.G} - \text{TX cable loss} + \text{Antenna gain of substitution horn}$
- e. $E.R.P = E.I.R.P - 2.15 \text{ dB}$

CONDUCTED POWER MEASUREMENT:

- a. The EUT was set up for the maximum power with LTE link data modulation and link up with simulator.
- b. Set the EUT to transmit under low, middle and high channel and record the power level shown on simulator.

3.1.3 TEST SETUP

EIRP MEASUREMENT:

<Radiated Emission below or equal 1 GHz>

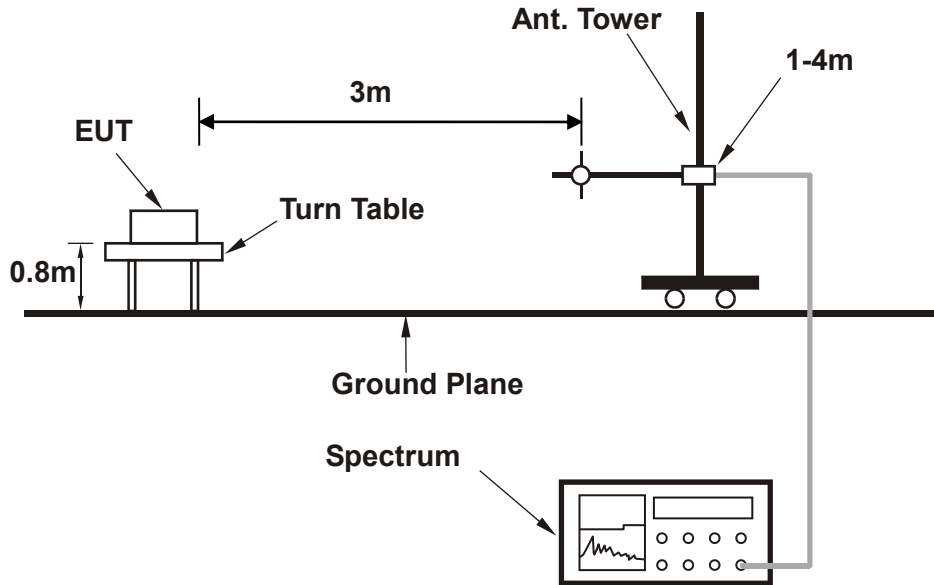

<Frequency Range above 1GHz>

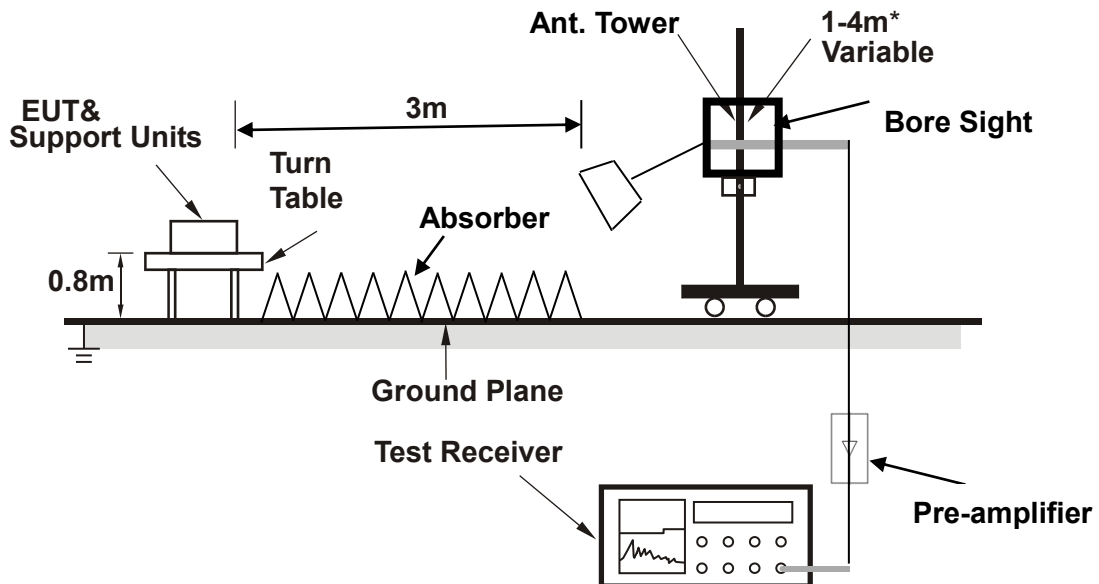

Note: Above 1G is a directional antenna

Depends on the EUT height and the antenna 3dB beamwidth both, refer to section 7.3 of CISPR 16-2-3.

For the actual test configuration, please refer to the attached file (Test Setup Photo).

CONDUCTED POWER MEASUREMENT:

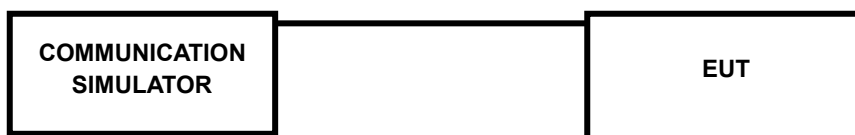

3.1.4 TEST RESULTS

AVERAGE CONDUCTED OUTPUT POWER (dBm)

Band	WCDMA IV		
Channel	1312	1413	1513
Frequency (MHz)	1712.4	1732.6	1752.6
RMC 12.2K	22.04	22.05	22.10
HSPA			
HSDPA Subtest-1	21.11	21.15	21.12
HSDPA Subtest-2	21.10	21.13	21.10
HSDPA Subtest-3	20.62	20.68	20.66
HSDPA Subtest-4	20.59	20.66	20.64
DC-HSDPA Subtest-1	21.08	21.13	21.08
DC-HSDPA Subtest-2	21.06	21.11	21.06
DC-HSDPA Subtest-3	20.58	20.65	20.57
DC-HSDPA Subtest-4	20.56	20.62	20.55
HSUPA Subtest-1	21.05	21.13	21.06
HSUPA Subtest-2	19.18	19.19	19.09
HSUPA Subtest-3	19.98	20.01	19.91
HSUPA Subtest-4	19.15	19.21	19.04
HSUPA Subtest-5	21.00	21.10	21.00

LTE Band 4							
BW	Modulation	RB Size	RB Offset	Low CH 19957	Mid CH 20175	High CH 20393	MPR
				Frequency 1710.7 MHz	Frequency 1732.5 MHz	Frequency 1754.3 MHz	
1.4MHz	QPSK	1	0	21.93	21.93	21.93	0
		1	2	21.87	21.80	21.85	0
		1	5	21.84	21.75	21.78	0
		3	0	21.80	21.74	21.81	0
		3	1	21.84	21.79	21.74	0
		3	3	21.82	21.75	21.78	0
		6	0	20.93	20.84	20.89	1
	16QAM	1	0	21.02	20.96	20.99	1
		1	2	21.15	21.05	21.12	1
		1	5	21.22	21.15	21.23	1
		3	0	20.86	20.81	20.82	1
		3	1	20.88	20.91	20.88	1
		3	3	20.96	20.91	20.96	1
		6	0	19.96	19.96	19.94	2
	64QAM	1	0	19.88	19.86	19.90	2
		1	2	19.89	19.91	19.89	2
		1	5	19.89	19.79	19.86	2
		3	0	19.91	18.89	18.88	2
		3	1	19.96	18.96	18.93	2
		3	3	19.96	18.89	18.97	2
		6	0	19.01	18.96	18.97	3

LTE Band 4							
BW	Modulation	RB Size	RB Offset	Low CH 19965	Mid CH 20175	High CH 20385	MPR
				Frequency 1711.5 MHz	Frequency 1732.5 MHz	Frequency 1753.5 MHz	
3MHz	QPSK	1	0	21.95	21.95	21.92	0
		1	7	21.83	21.81	21.85	0
		1	14	21.80	21.75	21.78	0
		8	0	20.79	20.77	20.81	1
		8	3	20.77	20.79	20.76	1
		8	7	20.79	20.82	20.82	1
		15	0	20.90	20.85	20.83	1
	16QAM	1	0	20.99	21.02	21.02	1
		1	7	21.12	21.08	21.10	1
		1	14	21.25	21.15	21.23	1
		8	0	19.82	19.82	19.82	2
		8	3	19.93	19.86	19.91	2
		8	7	19.98	19.89	19.92	2
		15	0	19.96	19.90	19.97	2
	64QAM	1	0	19.94	19.89	19.84	2
		1	7	19.92	19.85	19.88	2
		1	14	19.90	19.81	19.86	2
		8	0	18.94	18.93	18.89	3
		8	3	19.00	18.90	18.98	3
		8	7	18.93	18.93	18.93	3
		15	0	19.03	18.93	19.01	3

LTE Band 4							
BW	Modulation	RB Size	RB Offset	Low CH 19975	Mid CH 20175	High CH 20375	MPR
				Frequency 1712.5 MHz	Frequency 1732.5 MHz	Frequency 1752.5 MHz	
5 MHz	QPSK	1	0	21.96	21.90	21.93	0
		1	12	21.88	21.78	21.85	0
		1	24	21.81	21.74	21.82	0
		12	0	20.82	20.77	20.78	1
		12	6	20.77	20.80	20.77	1
		12	13	20.83	20.78	20.83	1
		25	0	20.88	20.88	20.86	1
	16QAM	1	0	21.00	20.98	21.02	1
		1	12	21.09	21.11	21.09	1
		1	24	21.25	21.15	21.22	1
		12	0	19.82	19.80	19.79	2
		12	6	19.90	19.90	19.87	2
		12	13	19.93	19.91	19.95	2
		25	0	19.96	19.91	19.94	2
	64QAM	1	0	19.88	19.86	19.90	2
		1	12	19.89	19.91	19.88	2
		1	24	19.83	19.86	19.86	2
		12	0	18.95	18.90	18.88	3
		12	6	18.94	18.97	18.97	3
		12	13	18.97	18.92	18.90	3
		25	0	18.99	18.99	18.99	3

LTE Band 4							
BW	Modulation	RB Size	RB Offset	Low CH 20000	Mid CH 20175	High CH 20350	MPR
				Frequency 1715 MHz	Frequency 1732.5 MHz	Frequency 1750 MHz	
10 MHz	QPSK	1	0	21.93	21.93	21.93	0
		1	24	21.88	21.78	21.86	0
		1	49	21.78	21.78	21.78	0
		25	0	20.83	20.76	20.81	1
		25	12	20.83	20.74	20.77	1
		25	25	20.81	20.75	20.82	1
		50	0	20.93	20.88	20.83	1
	16QAM	1	0	21.00	20.95	20.98	1
		1	24	21.14	21.07	21.12	1
		1	49	21.25	21.16	21.19	1
		25	0	19.84	19.78	19.85	2
		25	12	19.94	19.84	19.92	2
		25	25	19.92	19.92	19.92	2
		50	0	20.00	19.90	19.98	2
	64QAM	1	0	19.87	19.87	19.87	2
		1	24	19.94	19.87	19.92	2
		1	49	19.89	19.80	19.83	2
		25	0	18.93	18.87	18.94	3
		25	12	19.01	18.96	18.91	3
		25	25	18.96	18.89	18.92	3
		50	0	19.04	18.95	19.00	3

LTE Band 4							
BW	Modulation	RB Size	RB Offset	Low CH 20025	Mid CH 20175	High CH 20325	MPR
				Frequency 1717.5 MHz	Frequency 1732.5 MHz	Frequency 1747.5 MHz	
15 MHz	QPSK	1	0	22.00	21.93	21.90	0
		1	37	21.86	21.83	21.81	0
		1	74	21.84	21.81	21.79	0
		36	0	20.80	20.77	20.82	1
		36	19	20.84	20.79	20.77	1
		36	39	20.79	20.76	20.82	1
		75	0	20.93	20.86	20.88	1
	16QAM	1	0	21.04	21.02	20.98	1
		1	37	21.13	21.08	21.12	1
		1	74	21.21	21.21	21.21	1
		36	0	19.88	19.78	19.86	2
		36	19	19.88	19.88	19.88	2
		36	39	19.97	19.90	19.95	2
		75	0	20.01	19.93	19.91	2
	64QAM	1	0	19.89	19.88	19.88	2
		1	37	19.95	19.86	19.89	2
		1	74	19.85	19.79	19.86	2
		36	0	18.98	18.93	18.88	3
		36	19	18.95	18.90	18.93	3
		36	39	18.99	18.96	18.94	3
		75	0	19.03	18.93	19.01	3

LTE Band 4							
BW	Modulation	RB Size	RB Offset	Low CH 20050	Mid CH 20175	High CH 20300	MPR
				Frequency 1720 MHz	Frequency 1732.5 MHz	Frequency 1745 MHz	
20 MHz	QPSK	1	0	22.01	21.97	21.98	0
		1	50	21.90	21.86	21.87	0
		1	99	21.86	21.82	21.83	0
		50	0	20.86	20.82	20.83	1
		50	25	20.85	20.81	20.82	1
		50	50	20.87	20.83	20.84	1
		100	0	20.94	20.90	20.91	1
	16QAM	1	0	21.07	21.03	21.04	1
		1	50	21.17	21.13	21.14	1
		1	99	21.27	21.23	21.24	1
		50	0	19.90	19.86	19.87	2
		50	25	19.96	19.92	19.93	2
		50	50	20.00	19.96	19.97	2
		100	0	20.02	19.98	19.99	2
	64QAM	1	0	19.95	19.91	19.92	2
		1	50	19.97	19.93	19.94	2
		1	99	19.91	19.87	19.88	2
		50	0	18.99	18.95	18.96	3
		50	25	19.02	18.98	18.99	3
		50	50	19.01	18.97	18.98	3
		100	0	19.05	19.01	19.02	3



Test Report No.: RF190712W002-5

EIRP

WWAN-ANT-0

WCDMA IV

Channel	Frequency (MHz)	SPA LVL (dBm)	Correction Factor(dB)	EIRP(dBm)	EIRP(mW)	Polarization (H/V)
1312	1712.40	-24.36	41.39	17.03	50.49	H
1413	1732.60	-24.78	41.36	16.58	45.50	H
1513	1752.60	-25.21	42.63	17.42	55.20	H
1312	1712.40	-20.89	44.17	23.28	212.86	V
1413	1732.60	-21.12	44.20	23.08	203.24	V
1513	1752.60	-21.35	44.35	23.00	199.30	V

REMARKS: 1. EIRP Output Power (dBm) = SPA LVL (dBm) + Correction Factor (dB).
2. Correction factor (dB) = Free Space Loss + Antenna Factor + Cable Loss



**BUREAU
VERITAS**

Test Report No.: RF190712W002-5

LTE BAND 4

CHANNEL BANDWIDTH: 1.4MHz QPSK

Channel	Frequency (MHz)	SPA LVL (dBm)	Correction Factor(dB)	EIRP(dBm)	EIRP(mW)	Polarization (H/V)	LIMIT (W)
19957	1710.7	-27.12	41.29	14.17	26.15	H	1
20175	1732.5	-26.78	41.36	14.58	28.71	H	1
20393	1754.3	-26.44	42.74	16.30	42.64	H	1
19957	1710.7	-21.86	44.25	22.39	173.18	V	1
20175	1732.5	-22.78	44.20	21.42	138.68	V	1
20393	1754.3	-22.22	44.09	21.87	153.64	V	1

CHANNEL BANDWIDTH: 1.4MHz 16QAM

Channel	Frequency (MHz)	SPA LVL (dBm)	Correction Factor(dB)	EIRP(dBm)	EIRP(mW)	Polarization (H/V)	LIMIT (W)
19957	1710.7	-27.99	41.29	13.30	21.40	H	1
20175	1732.5	-27.71	41.36	13.65	23.17	H	1
20393	1754.3	-27.40	42.74	15.34	34.18	H	1
19957	1710.7	-22.73	44.25	21.52	141.74	V	1
20175	1732.5	-23.71	44.20	20.49	111.94	V	1
20393	1754.3	-23.18	44.09	20.91	123.17	V	1

CHANNEL BANDWIDTH: 1.4MHz 64QAM

Channel	Frequency (MHz)	SPA LVL (dBm)	Correction Factor(dB)	EIRP(dBm)	EIRP(mW)	Polarization (H/V)	LIMIT (W)
19957	1710.7	-30.08	41.29	11.21	13.23	H	1
20175	1732.5	-29.83	41.36	11.53	14.22	H	1
20393	1754.3	-29.56	42.74	13.18	20.79	H	1
19957	1710.7	-24.81	44.25	19.44	87.80	V	1
20175	1732.5	-25.77	44.20	18.43	69.66	V	1
20393	1754.3	-25.24	44.09	18.85	76.65	V	1



BUREAU
VERITAS

Test Report No.: RF190712W002-5

LTE BAND 4

CHANNEL BANDWIDTH: 3MHz QPSK

Channel	Frequency (MHz)	SPA LVL (dBm)	Correction Factor(dB)	EIRP(dBm)	EIRP(mW)	Polarization (H/V)	LIMIT (W)
19965	1711.5	-27.10	41.27	14.17	26.10	H	1
20175	1732.5	-26.84	41.36	14.52	28.31	H	1
20385	1753.5	-26.39	42.76	16.37	43.32	H	1
19965	1711.5	-21.84	44.26	22.42	174.66	V	1
20175	1732.5	-22.84	44.20	21.36	136.77	V	1
20385	1753.5	-22.17	44.23	22.06	160.77	V	1

CHANNEL BANDWIDTH: 3MHz 16QAM

Channel	Frequency (MHz)	SPA LVL (dBm)	Correction Factor(dB)	EIRP(dBm)	EIRP(mW)	Polarization (H/V)	LIMIT (W)
19965	1711.5	-28.17	41.27	13.10	20.40	H	1
20175	1732.5	-27.73	41.36	13.63	23.07	H	1
20385	1753.5	-27.38	42.76	15.38	34.49	H	1
19965	1711.5	-22.91	44.26	21.35	136.52	V	1
20175	1732.5	-23.73	44.20	20.47	111.43	V	1
20385	1753.5	-23.16	44.23	21.07	128.00	V	1

CHANNEL BANDWIDTH: 3MHz 64QAM

Channel	Frequency (MHz)	SPA LVL (dBm)	Correction Factor(dB)	EIRP(dBm)	EIRP(mW)	Polarization (H/V)	LIMIT (W)
19965	1711.5	-30.24	41.27	11.03	12.67	H	1
20175	1732.5	-29.76	41.36	11.60	14.45	H	1
20385	1753.5	-29.25	42.76	13.51	22.42	H	1
19965	1711.5	-24.99	44.26	19.27	84.57	V	1
20175	1732.5	-25.80	44.20	18.40	69.18	V	1
20385	1753.5	-25.31	44.23	18.92	78.02	V	1



BUREAU
VERITAS

Test Report No.: RF190712W002-5

LTE BAND 4

CHANNEL BANDWIDTH: 5MHz QPSK

Channel	Frequency (MHz)	SPA LVL (dBm)	Correction Factor(dB)	EIRP(dBm)	EIRP(mW)	Polarization (H/V)	LIMIT (W)
19975	1712.5	-27.16	41.39	14.23	26.48	H	1
20175	1732.5	-26.79	41.36	14.57	28.64	H	1
20375	1752.5	-26.34	42.63	16.29	42.55	H	1
19975	1712.5	-21.90	44.17	22.27	168.50	V	1
20175	1732.5	-22.79	44.20	21.41	138.36	V	1
20375	1752.5	-22.12	44.35	22.23	166.92	V	1

CHANNEL BANDWIDTH: 5MHz 16QAM

Channel	Frequency (MHz)	SPA LVL (dBm)	Correction Factor(dB)	EIRP(dBm)	EIRP(mW)	Polarization (H/V)	LIMIT (W)
19975	1712.5	-27.99	41.39	13.40	21.87	H	1
20175	1732.5	-27.81	41.36	13.55	22.65	H	1
20375	1752.5	-27.44	42.63	15.19	33.03	H	1
19975	1712.5	-22.73	44.17	21.44	139.19	V	1
20175	1732.5	-23.81	44.20	20.39	109.40	V	1
20375	1752.5	-23.22	44.35	21.13	129.57	V	1

CHANNEL BANDWIDTH: 5MHz 64QAM

Channel	Frequency (MHz)	SPA LVL (dBm)	Correction Factor(dB)	EIRP(dBm)	EIRP(mW)	Polarization (H/V)	LIMIT (W)
19975	1712.5	-30.05	41.39	11.34	13.61	H	1
20175	1732.5	-29.85	41.36	11.51	14.16	H	1
20375	1752.5	-29.50	42.63	13.13	20.55	H	1
19975	1712.5	-24.78	44.17	19.39	86.82	V	1
20175	1732.5	-25.87	44.20	18.33	68.08	V	1
20375	1752.5	-25.27	44.35	19.08	80.82	V	1



BUREAU
VERITAS

Test Report No.: RF190712W002-5

LTE BAND 4

CHANNEL BANDWIDTH: 10MHz QPSK

Channel	Frequency (MHz)	SPA LVL (dBm)	Correction Factor(dB)	EIRP(dBm)	EIRP(mW)	Polarization (H/V)	LIMIT (W)
20000	1715.0	-26.97	41.49	14.52	28.29	H	1
20175	1732.5	-26.73	41.36	14.63	29.04	H	1
20350	1750.0	-26.21	42.28	16.07	40.49	H	1
20000	1715.0	-21.71	44.06	22.35	171.91	V	1
20175	1732.5	-22.73	44.20	21.47	140.28	V	1
20350	1750.0	-21.99	44.43	22.44	175.39	V	1

CHANNEL BANDWIDTH: 10MHz 16QAM

Channel	Frequency (MHz)	SPA LVL (dBm)	Correction Factor(dB)	EIRP(dBm)	EIRP(mW)	Polarization (H/V)	LIMIT (W)
20000	1715.0	-28.12	41.49	13.37	21.71	H	1
20175	1732.5	-27.83	41.36	13.53	22.54	H	1
20350	1750.0	-27.37	42.28	14.91	31.00	H	1
20000	1715.0	-22.86	44.06	21.20	131.92	V	1
20175	1732.5	-23.83	44.20	20.37	108.89	V	1
20350	1750.0	-23.15	44.43	21.28	134.28	V	1

CHANNEL BANDWIDTH: 10MHz 64QAM

Channel	Frequency (MHz)	SPA LVL (dBm)	Correction Factor(dB)	EIRP(dBm)	EIRP(mW)	Polarization (H/V)	LIMIT (W)
20000	1715.0	-30.22	41.49	11.27	13.38	H	1
20175	1732.5	-29.90	41.36	11.46	14.00	H	1
20350	1750.0	-29.42	42.28	12.86	19.33	H	1
20000	1715.0	-24.95	44.06	19.11	81.53	V	1
20175	1732.5	-25.92	44.20	18.28	67.30	V	1
20350	1750.0	-25.17	44.43	19.26	84.33	V	1



BUREAU
VERITAS

Test Report No.: RF190712W002-5

LTE BAND 4

CHANNEL BANDWIDTH: 15MHz QPSK

Channel	Frequency (MHz)	SPA LVL (dBm)	Correction Factor(dB)	EIRP(dBm)	EIRP(mW)	Polarization (H/V)	LIMIT (W)
20025	1717.5	-26.98	41.34	14.36	27.28	H	1
20175	1732.5	-26.80	41.36	14.56	28.58	H	1
20325	1747.5	-26.28	42.09	15.81	38.07	H	1
20025	1717.5	-21.72	44.04	22.32	170.77	V	1
20175	1732.5	-22.80	44.20	21.40	138.04	V	1
20325	1747.5	-22.06	44.22	22.16	164.25	V	1

CHANNEL BANDWIDTH: 15MHz 16QAM

Channel	Frequency (MHz)	SPA LVL (dBm)	Correction Factor(dB)	EIRP(dBm)	EIRP(mW)	Polarization (H/V)	LIMIT (W)
20025	1717.5	-27.84	41.34	13.50	22.38	H	1
20175	1732.5	-27.67	41.36	13.69	23.39	H	1
20325	1747.5	-27.13	42.09	14.96	31.30	H	1
20025	1717.5	-22.58	44.04	21.46	140.09	V	1
20175	1732.5	-23.67	44.20	20.53	112.98	V	1
20325	1747.5	-22.91	44.22	21.31	135.05	V	1

CHANNEL BANDWIDTH: 15MHz 64QAM

Channel	Frequency (MHz)	SPA LVL (dBm)	Correction Factor(dB)	EIRP(dBm)	EIRP(mW)	Polarization (H/V)	LIMIT (W)
20025	1717.5	-29.89	41.34	11.45	13.96	H	1
20175	1732.5	-27.73	41.36	13.63	23.07	H	1
20325	1747.5	-28.28	42.09	13.81	24.02	H	1
20025	1717.5	-24.62	44.04	19.42	87.58	V	1
20175	1732.5	-25.70	44.20	18.50	70.79	V	1
20325	1747.5	-24.97	44.22	19.25	84.04	V	1



BUREAU
VERITAS

Test Report No.: RF190712W002-5

LTE BAND 4

CHANNEL BANDWIDTH: 20MHz QPSK

Channel	Frequency (MHz)	SPA LVL (dBm)	Correction Factor(dB)	EIRP(dBm)	EIRP(mW)	Polarization (H/V)	LIMIT (W)
20050	1720.0	-27.56	41.28	13.72	23.56	H	1
20175	1732.5	-27.25	41.36	14.11	25.77	H	1
20300	1745.0	-26.86	41.96	15.10	32.34	H	1
20050	1720.0	-22.30	44.14	21.84	152.58	V	1
20175	1732.5	-23.25	44.20	20.95	124.34	V	1
20300	1745.0	-22.64	43.88	21.24	133.11	V	1

CHANNEL BANDWIDTH: 20MHz 16QAM

Channel	Frequency (MHz)	SPA LVL (dBm)	Correction Factor(dB)	EIRP(dBm)	EIRP(mW)	Polarization (H/V)	LIMIT (W)
20050	1720.0	-28.49	41.28	12.79	19.02	H	1
20175	1732.5	-28.32	41.36	13.04	20.14	H	1
20300	1745.0	-27.69	41.96	14.27	26.71	H	1
20050	1720.0	-23.23	44.14	20.91	123.17	V	1
20175	1732.5	-24.32	44.20	19.88	97.19	V	1
20300	1745.0	-23.47	43.88	20.41	109.95	V	1

CHANNEL BANDWIDTH: 20MHz 64QAM

Channel	Frequency (MHz)	SPA LVL (dBm)	Correction Factor(dB)	EIRP(dBm)	EIRP(mW)	Polarization (H/V)	LIMIT (W)
20050	1720.0	-30.77	41.28	10.51	11.25	H	1
20175	1732.5	-30.45	41.36	10.91	12.33	H	1
20300	1745.0	-29.84	41.96	12.12	16.28	H	1
20050	1720.0	-25.26	44.14	18.88	77.18	V	1
20175	1732.5	-26.43	44.20	17.77	59.79	V	1
20300	1745.0	-25.56	43.88	18.32	67.95	V	1

REMARKS: 1. EIRP Output Power (dBm) = SPA LVL (dBm) + Correction Factor (dB).
2. Correction factor (dB) = Free Space Loss + Antenna Factor + Cable Loss



BUREAU
VERITAS

Test Report No.: RF190712W002-5

WWAN-ANT-1

WCDMA IV

Channel	Frequency (MHz)	SPA LVL (dBm)	Correction Factor(dB)	EIRP(dBm)	EIRP(mW)	Polarization (H/V)
1312	1712.40	-30.27	41.39	11.12	12.94	H
1413	1732.60	-30.42	41.36	10.94	12.42	H
1513	1752.60	-31.53	42.63	11.10	12.88	H
1312	1712.40	-26.89	44.17	17.28	53.47	V
1413	1732.60	-27.12	44.20	17.08	51.05	V
1513	1752.60	-27.35	44.35	17.00	50.06	V

REMARKS: 1. EIRP Output Power (dBm) = SPA LVL (dBm) + Correction Factor (dB).
2. Correction factor (dB) = Free Space Loss + Antenna Factor + Cable Loss



BUREAU
VERITAS

Test Report No.: RF190712W002-5

LTE BAND 4

CHANNEL BANDWIDTH: 1.4MHz QPSK

Channel	Frequency (MHz)	SPA LVL (dBm)	Correction Factor(dB)	EIRP(dBm)	EIRP(mW)	Polarization (H/V)	LIMIT (W)
19957	1710.7	-33.88	41.29	7.41	5.51	H	1
20175	1732.5	-33.12	41.36	8.24	6.67	H	1
20393	1754.3	-32.99	42.74	9.75	9.44	H	1
19957	1710.7	-28.08	44.25	16.17	41.35	V	1
20175	1732.5	-29.17	44.20	15.03	31.84	V	1
20393	1754.3	-28.43	44.09	15.66	36.77	V	1

CHANNEL BANDWIDTH: 1.4MHz 16QAM

Channel	Frequency (MHz)	SPA LVL (dBm)	Correction Factor(dB)	EIRP(dBm)	EIRP(mW)	Polarization (H/V)	LIMIT (W)
19957	1710.7	-34.75	41.29	6.54	4.51	H	1
20175	1732.5	-34.05	41.36	7.31	5.38	H	1
20393	1754.3	-33.95	42.74	8.79	7.56	H	1
19957	1710.7	-28.95	44.25	15.30	33.85	V	1
20175	1732.5	-30.10	44.20	14.10	25.70	V	1
20393	1754.3	-29.39	44.09	14.70	29.48	V	1

CHANNEL BANDWIDTH: 1.4MHz 64QAM

Channel	Frequency (MHz)	SPA LVL (dBm)	Correction Factor(dB)	EIRP(dBm)	EIRP(mW)	Polarization (H/V)	LIMIT (W)
19957	1710.7	-36.84	41.29	4.45	2.79	H	1
20175	1732.5	-36.17	41.36	5.19	3.30	H	1
20393	1754.3	-36.11	42.74	6.63	4.60	H	1
19957	1710.7	-31.03	44.25	13.22	20.97	V	1
20175	1732.5	-32.16	44.20	12.04	16.00	V	1
20393	1754.3	-31.45	44.09	12.64	18.34	V	1



**BUREAU
VERITAS**

Test Report No.: RF190712W002-5

LTE BAND 4

CHANNEL BANDWIDTH: 3MHz QPSK

Channel	Frequency (MHz)	SPA LVL (dBm)	Correction Factor(dB)	EIRP(dBm)	EIRP(mW)	Polarization (H/V)	LIMIT (W)
19965	1711.5	-33.86	41.27	7.41	5.50	H	1
20175	1732.5	-33.18	41.36	8.18	6.58	H	1
20385	1753.5	-32.94	42.76	9.82	9.59	H	1
19965	1711.5	-28.06	44.26	16.20	41.71	V	1
20175	1732.5	-29.23	44.20	14.97	31.41	V	1
20385	1753.5	-28.38	44.23	15.85	38.48	V	1

CHANNEL BANDWIDTH: 3MHz 16QAM

Channel	Frequency (MHz)	SPA LVL (dBm)	Correction Factor(dB)	EIRP(dBm)	EIRP(mW)	Polarization (H/V)	LIMIT (W)
19965	1711.5	-34.93	41.27	6.34	4.30	H	1
20175	1732.5	-34.07	41.36	7.29	5.36	H	1
20385	1753.5	-33.93	42.76	8.83	7.63	H	1
19965	1711.5	-29.13	44.26	15.13	32.60	V	1
20175	1732.5	-30.12	44.20	14.08	25.59	V	1
20385	1753.5	-29.37	44.23	14.86	30.63	V	1

CHANNEL BANDWIDTH: 3MHz 64QAM

Channel	Frequency (MHz)	SPA LVL (dBm)	Correction Factor(dB)	EIRP(dBm)	EIRP(mW)	Polarization (H/V)	LIMIT (W)
19965	1711.5	-37.00	41.27	4.27	2.67	H	1
20175	1732.5	-36.10	41.36	5.26	3.36	H	1
20385	1753.5	-35.80	42.76	6.96	4.96	H	1
19965	1711.5	-31.21	44.26	13.05	20.19	V	1
20175	1732.5	-32.19	44.20	12.01	15.89	V	1
20385	1753.5	-31.52	44.23	12.71	18.67	V	1



BUREAU
VERITAS

Test Report No.: RF190712W002-5

LTE BAND 4

CHANNEL BANDWIDTH: 5MHz QPSK

Channel	Frequency (MHz)	SPA LVL (dBm)	Correction Factor(dB)	EIRP(dBm)	EIRP(mW)	Polarization (H/V)	LIMIT (W)
19975	1712.5	-33.92	41.39	7.47	5.58	H	1
20175	1732.5	-33.13	41.36	8.23	6.65	H	1
20375	1752.5	-32.89	42.63	9.74	9.42	H	1
19975	1712.5	-28.12	44.17	16.05	40.23	V	1
20175	1732.5	-29.18	44.20	15.02	31.77	V	1
20375	1752.5	-28.33	44.35	16.02	39.95	V	1

CHANNEL BANDWIDTH: 5MHz 16QAM

Channel	Frequency (MHz)	SPA LVL (dBm)	Correction Factor(dB)	EIRP(dBm)	EIRP(mW)	Polarization (H/V)	LIMIT (W)
19975	1712.5	-34.75	41.39	6.64	4.61	H	1
20175	1732.5	-34.15	41.36	7.21	5.26	H	1
20375	1752.5	-33.99	42.63	8.64	7.31	H	1
19975	1712.5	-28.95	44.17	15.22	33.24	V	1
20175	1732.5	-30.20	44.20	14.00	25.12	V	1
20375	1752.5	-29.43	44.35	14.92	31.01	V	1

CHANNEL BANDWIDTH: 5MHz 64QAM

Channel	Frequency (MHz)	SPA LVL (dBm)	Correction Factor(dB)	EIRP(dBm)	EIRP(mW)	Polarization (H/V)	LIMIT (W)
19975	1712.5	-36.81	41.39	4.58	2.87	H	1
20175	1732.5	-36.19	41.36	5.17	3.29	H	1
20375	1752.5	-36.05	42.63	6.58	4.55	H	1
19975	1712.5	-31.00	44.17	13.17	20.73	V	1
20175	1732.5	-32.26	44.20	11.94	15.63	V	1
20375	1752.5	-31.48	44.35	12.87	19.34	V	1



BUREAU
VERITAS

Test Report No.: RF190712W002-5

LTE BAND 4

CHANNEL BANDWIDTH: 10MHz QPSK

Channel	Frequency (MHz)	SPA LVL (dBm)	Correction Factor(dB)	EIRP(dBm)	EIRP(mW)	Polarization (H/V)	LIMIT (W)
20000	1715.0	-33.73	41.49	7.76	5.96	H	1
20175	1732.5	-33.07	41.36	8.29	6.75	H	1
20350	1750.0	-32.76	42.28	9.52	8.96	H	1
20000	1715.0	-27.93	44.06	16.13	41.05	V	1
20175	1732.5	-29.12	44.20	15.08	32.21	V	1
20350	1750.0	-28.20	44.43	16.23	41.98	V	1

CHANNEL BANDWIDTH: 10MHz 16QAM

Channel	Frequency (MHz)	SPA LVL (dBm)	Correction Factor(dB)	EIRP(dBm)	EIRP(mW)	Polarization (H/V)	LIMIT (W)
20000	1715.0	-34.88	41.49	6.61	4.58	H	1
20175	1732.5	-34.17	41.36	7.19	5.24	H	1
20350	1750.0	-33.92	42.28	8.36	6.86	H	1
20000	1715.0	-29.08	44.06	14.98	31.50	V	1
20175	1732.5	-30.22	44.20	13.98	25.00	V	1
20350	1750.0	-29.36	44.43	15.07	32.14	V	1

CHANNEL BANDWIDTH: 10MHz 64QAM

Channel	Frequency (MHz)	SPA LVL (dBm)	Correction Factor(dB)	EIRP(dBm)	EIRP(mW)	Polarization (H/V)	LIMIT (W)
20000	1715.0	-36.98	41.49	4.51	2.82	H	1
20175	1732.5	-36.24	41.36	5.12	3.25	H	1
20350	1750.0	-35.97	42.28	6.31	4.28	H	1
20000	1715.0	-31.17	44.06	12.89	19.47	V	1
20175	1732.5	-32.31	44.20	11.89	15.45	V	1
20350	1750.0	-31.38	44.43	13.05	20.18	V	1



BUREAU
VERITAS

Test Report No.: RF190712W002-5

LTE BAND 4

CHANNEL BANDWIDTH: 15MHz QPSK

Channel	Frequency (MHz)	SPA LVL (dBm)	Correction Factor(dB)	EIRP(dBm)	EIRP(mW)	Polarization (H/V)	LIMIT (W)
20025	1717.5	-33.74	41.34	7.60	5.75	H	1
20175	1732.5	-33.14	41.36	8.22	6.64	H	1
20325	1747.5	-32.83	42.09	9.26	8.43	H	1
20025	1717.5	-27.94	44.04	16.10	40.78	V	1
20175	1732.5	-29.19	44.20	15.01	31.70	V	1
20325	1747.5	-28.27	44.22	15.95	39.31	V	1

CHANNEL BANDWIDTH: 15MHz 16QAM

Channel	Frequency (MHz)	SPA LVL (dBm)	Correction Factor(dB)	EIRP(dBm)	EIRP(mW)	Polarization (H/V)	LIMIT (W)
20025	1717.5	-34.60	41.34	6.74	4.72	H	1
20175	1732.5	-34.01	41.36	7.35	5.43	H	1
20325	1747.5	-33.68	42.09	8.41	6.93	H	1
20025	1717.5	-28.80	44.04	15.24	33.45	V	1
20175	1732.5	-30.06	44.20	14.14	25.94	V	1
20325	1747.5	-29.12	44.22	15.10	32.32	V	1

CHANNEL BANDWIDTH: 15MHz 64QAM

Channel	Frequency (MHz)	SPA LVL (dBm)	Correction Factor(dB)	EIRP(dBm)	EIRP(mW)	Polarization (H/V)	LIMIT (W)
20025	1717.5	-36.65	41.34	4.69	2.94	H	1
20175	1732.5	-34.07	41.36	7.29	5.36	H	1
20325	1747.5	-34.83	42.09	7.26	5.32	H	1
20025	1717.5	-30.84	44.04	13.20	20.91	V	1
20175	1732.5	-32.09	44.20	12.11	16.26	V	1
20325	1747.5	-31.18	44.22	13.04	20.11	V	1



BUREAU
VERITAS

Test Report No.: RF190712W002-5

LTE BAND 4

CHANNEL BANDWIDTH: 20MHz QPSK

Channel	Frequency (MHz)	SPA LVL (dBm)	Correction Factor(dB)	EIRP(dBm)	EIRP(mW)	Polarization (H/V)	LIMIT (W)
20050	1720.0	-34.32	41.28	6.96	4.97	H	1
20175	1732.5	-33.59	41.36	7.77	5.99	H	1
20300	1745.0	-33.41	41.96	8.55	7.16	H	1
20050	1720.0	-28.52	44.14	15.62	36.43	V	1
20175	1732.5	-29.64	44.20	14.56	28.55	V	1
20300	1745.0	-28.85	43.88	15.03	31.86	V	1

CHANNEL BANDWIDTH: 20MHz 16QAM

Channel	Frequency (MHz)	SPA LVL (dBm)	Correction Factor(dB)	EIRP(dBm)	EIRP(mW)	Polarization (H/V)	LIMIT (W)
20050	1720.0	-35.25	41.28	6.03	4.01	H	1
20175	1732.5	-34.66	41.36	6.70	4.68	H	1
20300	1745.0	-34.24	41.96	7.72	5.91	H	1
20050	1720.0	-29.45	44.14	14.69	29.41	V	1
20175	1732.5	-30.71	44.20	13.49	22.32	V	1
20300	1745.0	-29.68	43.88	14.20	26.31	V	1

CHANNEL BANDWIDTH: 20MHz 64QAM

Channel	Frequency (MHz)	SPA LVL (dBm)	Correction Factor(dB)	EIRP(dBm)	EIRP(mW)	Polarization (H/V)	LIMIT (W)
20050	1720.0	-37.53	41.28	3.75	2.37	H	1
20175	1732.5	-36.79	41.36	4.57	2.86	H	1
20300	1745.0	-36.39	41.96	5.57	3.60	H	1
20050	1720.0	-31.48	44.14	12.66	18.43	V	1
20175	1732.5	-32.82	44.20	11.38	13.73	V	1
20300	1745.0	-31.77	43.88	12.11	16.26	V	1

REMARKS: 1. EIRP Output Power (dBm) = SPA LVL (dBm) + Correction Factor (dB).
2. Correction factor (dB) = Free Space Loss + Antenna Factor + Cable Loss

3.2 FREQUENCY STABILITY MEASUREMENT

3.2.1 LIMITS OF FREQUENCY STABILITY MEASUREMENT

The frequency stability shall be sufficient to ensure that the fundamental emissions stay within the authorized bands of operation.

3.2.2 TEST PROCEDURE

- a. Device is placed at the oven room. The oven room could control the temperatures and humidity. Power warm up is at least 15 min and power applied should perform before recording frequency error.
- b. EUT is connected the external power supply to control the DC input power. The test voltage range is from minimum to maximum working voltage. Each step shall be record the frequency error rate.
- c. The temperature range step is 10 degrees in this test items. All temperature levels shall be hold the $\pm 0.5^{\circ}\text{C}$ during the measurement testing. The each temperature step shall be at least 0.5 hours, consider the EUT could be test under the stability condition.

NOTE: The frequency error was recorded frequency error from the communication simulator.

3.2.3 TEST SETUP

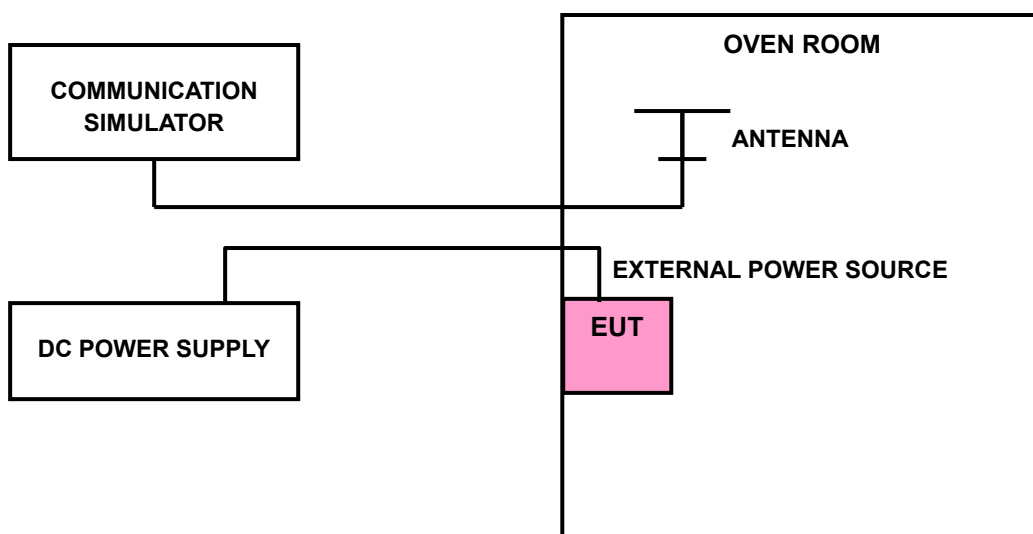

3.2.4 TEST RESULTS

WCDMA BAND IV

FREQUENCY ERROR VS. VOLTAGE

VOLTAGE (Volts)	FREQUENCY ERROR (ppm)		LIMIT (ppm)
	Low Channel	High Channel	
V _{nor}	0.0019	0.0017	2.5
V _{min}	-0.0022	-0.0021	2.5
V _{max}	0.0019	0.0018	2.5

NOTE: The applicant defined the normal working voltage of the battery is from V_{min} to V_{dc}.

FREQUENCY ERROR vs. TEMPERATURE.

TEMP. (°C)	FREQUENCY ERROR (ppm)		LIMIT (ppm)
	Low Channel	High Channel	
-30	-0.0127	-0.0121	2.5
-20	-0.0116	-0.0111	2.5
-10	-0.0099	-0.0095	2.5
0	-0.0088	-0.0085	2.5
10	-0.0065	-0.0063	2.5
20	-0.0052	-0.0050	2.5
30	-0.0043	-0.0042	2.5
40	-0.0026	-0.0025	2.5
50	-0.0014	-0.0014	2.5

LTE BAND 4

FREQUENCY ERROR VS. VOLTAGE

VOLTAGE (Volts)	1.4MHz		LIMIT (ppm)
	FREQUENCY ERROR (ppm)		
	Low Channel	High Channel	
V _{nor}	0.0008	0.0010	2.5
V _{min}	-0.0013	-0.0014	2.5
V _{max}	-0.0008	0.0009	2.5

NOTE: The applicant defined the normal working voltage of the battery is from V_{min} to V_{dc}.

FREQUENCY ERROR vs. TEMPERATURE.

TEMP. (°C)	1.4MHz		LIMIT (ppm)
	FREQUENCY ERROR (ppm)		
	Low Channel	High Channel	
-30	-0.0060	-0.0055	2.5
-20	-0.0054	-0.0050	2.5
-10	-0.0048	-0.0043	2.5
0	-0.0039	-0.0036	2.5
10	-0.0035	-0.0032	2.5
20	-0.0026	-0.0024	2.5
30	-0.0016	-0.0014	2.5
40	-0.0009	-0.0008	2.5
50	-0.0002	-0.0002	2.5

FREQUENCY ERROR VS. VOLTAGE

VOLTAGE (Volts)	3MHz		LIMIT (ppm)
	FREQUENCY ERROR (ppm)		
	Low Channel	High Channel	
V _{nor}	0.0008	0.0009	2.5
V _{min}	-0.0009	-0.0011	2.5
V _{max}	0.0008	0.0008	2.5

NOTE: The applicant defined the normal working voltage of the battery is from V_{min} to V_{dc}.

FREQUENCY ERROR vs. TEMPERATURE.

TEMP. (°C)	3MHz		LIMIT (ppm)
	FREQUENCY ERROR (ppm)		
	Low Channel	High Channel	
-30	-0.0060	-0.0055	2.5
-20	-0.0055	-0.0050	2.5
-10	-0.0045	-0.0041	2.5
0	-0.0039	0.0008	2.5
10	-0.0029	-0.0008	2.5
20	-0.0024	-0.0019	2.5
30	-0.0019	-0.0018	2.5
40	-0.0011	-0.0011	2.5
50	-0.0003	-0.0003	2.5

FREQUENCY ERROR VS. VOLTAGE

VOLTAGE (Volts)	5MHz		LIMIT (ppm)
	FREQUENCY ERROR (ppm)		
	Low Channel	High Channel	
V _{nor}	0.0009	0.0010	2.5
V _{min}	-0.0007	-0.0012	2.5
V _{max}	0.0009	0.0008	2.5

NOTE: The applicant defined the normal working voltage of the battery is from V_{min} to V_{dc}.

FREQUENCY ERROR vs. TEMPERATURE.

TEMP. (°C)	5MHz		LIMIT (ppm)
	FREQUENCY ERROR (ppm)		
	Low Channel	High Channel	
-30	-0.0056	-0.0052	2.5
-20	-0.0049	-0.0047	2.5
-10	-0.0044	-0.0041	2.5
0	-0.0037	-0.0033	2.5
10	-0.0028	-0.0026	2.5
20	-0.0019	-0.0019	2.5
30	-0.0015	-0.0014	2.5
40	-0.0007	-0.0007	2.5
50	-0.0002	-0.0002	2.5

FREQUENCY ERROR VS. VOLTAGE

VOLTAGE (Volts)	10MHz		LIMIT (ppm)
	FREQUENCY ERROR (ppm)		
	Low Channel	High Channel	
V _{nor}	0.0009	0.0012	2.5
V _{min}	-0.0011	-0.0013	2.5
V _{max}	0.0009	0.0009	2.5

NOTE: The applicant defined the normal working voltage of the battery is from V_{min} to V_{dc}.

FREQUENCY ERROR vs. TEMPERATURE.

TEMP. (°C)	10MHz		LIMIT (ppm)
	FREQUENCY ERROR (ppm)		
	Low Channel	High Channel	
-30	-0.0056	-0.0053	2.5
-20	-0.0050	-0.0048	2.5
-10	-0.0043	-0.0041	2.5
0	-0.0033	-0.0030	2.5
10	-0.0026	-0.0024	2.5
20	-0.0021	-0.0019	2.5
30	-0.0014	-0.0012	2.5
40	-0.0008	-0.0007	2.5
50	-0.0001	-0.0001	2.5

FREQUENCY ERROR VS. VOLTAGE

VOLTAGE (Volts)	15MHz		LIMIT (ppm)
	FREQUENCY ERROR (ppm)		
	Low Channel	High Channel	
V _{nor}	0.0010	0.0009	2.5
V _{min}	-0.0012	-0.0012	2.5
V _{max}	0.0009	0.0010	2.5

NOTE: The applicant defined the normal working voltage of the battery is from V_{min} to V_{dc}.

FREQUENCY ERROR vs. TEMPERATURE.

TEMP. (°C)	15MHz		LIMIT (ppm)
	FREQUENCY ERROR (ppm)		
	Low Channel	High Channel	
-30	-0.0056	-0.0053	2.5
-20	-0.0048	-0.0045	2.5
-10	-0.0042	-0.0039	2.5
0	-0.0032	-0.0031	2.5
10	-0.0026	-0.0024	2.5
20	-0.0019	-0.0018	2.5
30	-0.0013	-0.0012	2.5
40	-0.0009	-0.0008	2.5
50	-0.0002	-0.0003	2.5

FREQUENCY ERROR VS. VOLTAGE

VOLTAGE (Volts)	20MHz		LIMIT (ppm)
	FREQUENCY ERROR (ppm)		
	Low Channel	High Channel	
V _{nor}	0.0011	0.0012	2.5
V _{min}	-0.0013	-0.0012	2.5
V _{max}	0.0010	0.0012	2.5

NOTE: The applicant defined the normal working voltage of the battery is from V_{min} to V_{dc}.

FREQUENCY ERROR vs. TEMPERATURE.

TEMP. (°C)	20MHz		LIMIT (ppm)
	FREQUENCY ERROR (ppm)		
	Low Channel	High Channel	
-30	-0.0051	-0.0048	2.5
-20	-0.0044	-0.0041	2.5
-10	-0.0040	-0.0037	2.5
0	-0.0032	-0.0030	2.5
10	-0.0025	-0.0023	2.5
20	-0.0019	-0.0018	2.5
30	-0.0011	-0.0010	2.5
40	-0.0005	-0.0004	2.5
50	-0.0002	-0.0001	2.5

3.3 OCCUPIED BANDWIDTH MEASUREMENT

3.3.1 LIMITS OF OCCUPIED BANDWIDTH MEASUREMENT

The width of a frequency band such that, below the lower and above the upper frequency limits, the mean powers emitted are each equal to a specified percentage 0.5 %of the total mean power of a given emission.

3.3.2 TEST SETUP

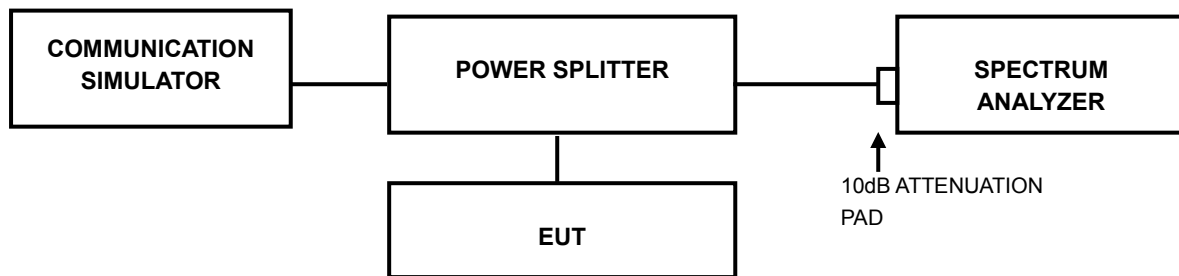

3.3.3 TEST PROCEDURES

- The conducted occupied bandwidth used the power splitter via EUT RF power connector between simulation base station and spectrum analyzer.
- Use OBW measurement function of Spectrum analyzer to measure 99 % occupied bandwidth.



3.3.4 TEST RESULTS

WCDMA BAND IV

Channel	FREQ. (MHz)	99% Occupied Bandwidth (MHz)	Channel	FREQ. (MHz)	26dB Bandwidth (MHz)
		WCDMA			WCDMA
1312	1712.40	4.15	1312	1712.40	4.73
1413	1732.60	4.16	1413	1732.60	4.70
1513	1752.60	4.14	1513	1752.60	4.69

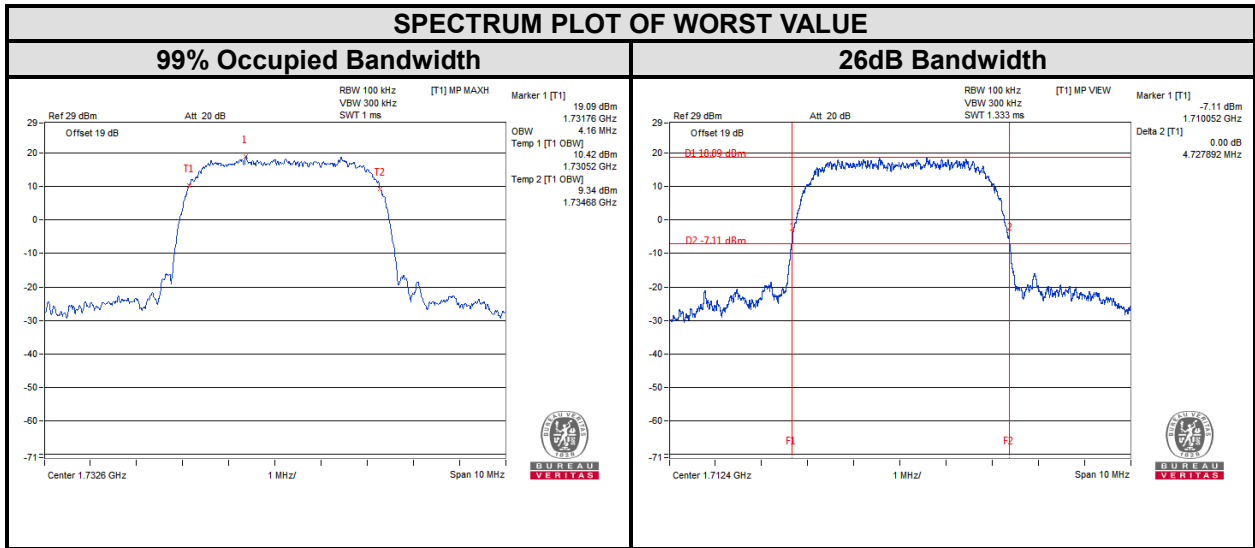



**BUREAU
VERITAS**

Test Report No.: RF190712W002-5

LTE BAND 4

CHANNEL BANDWIDTH: 1.4MHz				
CHANNEL	Frequency (MHz)	99% OCCUPIED Bandwidth (MHz)		
		QPSK	16QAM	64QAM
19957	1710.7	1.08	1.08	1.08
20175	1732.5	1.08	1.08	1.08
20393	1754.3	1.08	1.08	1.08
CHANNEL	Frequency (MHz)	26dB Bandwidth (MHz)		
		QPSK	16QAM	64QAM
19957	1710.7	1.23	1.22	1.22
20175	1732.5	1.23	1.22	1.22
20393	1754.3	1.23	1.22	1.22



LTE BAND 4

CHANNEL BANDWIDTH: 3MHz				
CHANNEL	Frequency (MHz)	99% OCCUPIED Bandwidth (MHz)		
		QPSK	16QAM	64QAM
19965	1711.5	2.68	2.68	2.68
20175	1732.5	2.68	2.68	2.68
20385	1753.5	2.68	2.68	2.68
CHANNEL	Frequency (MHz)	26dB Bandwidth (MHz)		
		QPSK	16QAM	64QAM
19965	1711.5	2.97	2.93	2.92
20175	1732.5	2.93	2.93	2.90
20385	1753.5	2.92	2.94	2.92





**BUREAU
VERITAS**

Test Report No.: RF190712W002-5

LTE BAND 4

CHANNEL BANDWIDTH: 5MHz				
CHANNEL	Frequency (MHz)	99% OCCUPIED Bandwidth (MHz)		
		QPSK	16QAM	64QAM
19975	1712.5	4.47	4.47	4.48
20175	1732.5	4.47	4.47	4.48
20375	1752.5	4.47	4.47	4.48
CHANNEL	Frequency (MHz)	26dB Bandwidth (MHz)		
		QPSK	16QAM	64QAM
19975	1712.5	4.88	4.91	4.88
20175	1732.5	4.91	4.88	4.89
20375	1752.5	4.88	4.88	4.87





**BUREAU
VERITAS**

Test Report No.: RF190712W002-5

LTE BAND 4

CHANNEL BANDWIDTH: 10MHz				
CHANNEL	Frequency (MHz)	99% OCCUPIED Bandwidth (MHz)		
		QPSK	16QAM	64QAM
20000	1715	8.94	8.93	8.93
20175	1732.5	8.93	8.91	8.93
20350	1750	8.95	8.92	8.94
CHANNEL	Frequency (MHz)	26dB Bandwidth (MHz)		
		QPSK	16QAM	64QAM
20000	1715	9.64	9.55	9.63
20175	1732.5	9.61	9.58	9.62
20350	1750	9.59	9.60	9.56



LTE BAND 4

CHANNEL BANDWIDTH: 15MHz				
CHANNEL	Frequency (MHz)	99% OCCUPIED Bandwidth (MHz)		
		QPSK	16QAM	64QAM
20025	1717.5	13.41	13.41	13.39
20175	1732.5	13.40	13.36	13.36
20325	1747.5	13.43	13.40	13.38
CHANNEL	Frequency (MHz)	26dB Bandwidth (MHz)		
		QPSK	16QAM	64QAM
20025	1717.5	14.46	14.55	14.48
20175	1732.5	14.38	14.36	14.51
20325	1747.5	14.42	14.50	14.54



LTE BAND 4

CHANNEL BANDWIDTH: 20MHz				
CHANNEL	Frequency (MHz)	99% OCCUPIED Bandwidth (MHz)		
		QPSK	16QAM	64QAM
20050	1720	17.87	17.88	17.88
20175	1732.5	17.83	17.85	17.81
20300	1745	17.86	17.88	17.86
CHANNEL	Frequency (MHz)	26dB Bandwidth (MHz)		
		QPSK	16QAM	64QAM
20050	1720	19.18	19.24	19.11
20175	1732.5	19.08	18.98	19.17
20300	1745	19.19	19.15	19.25

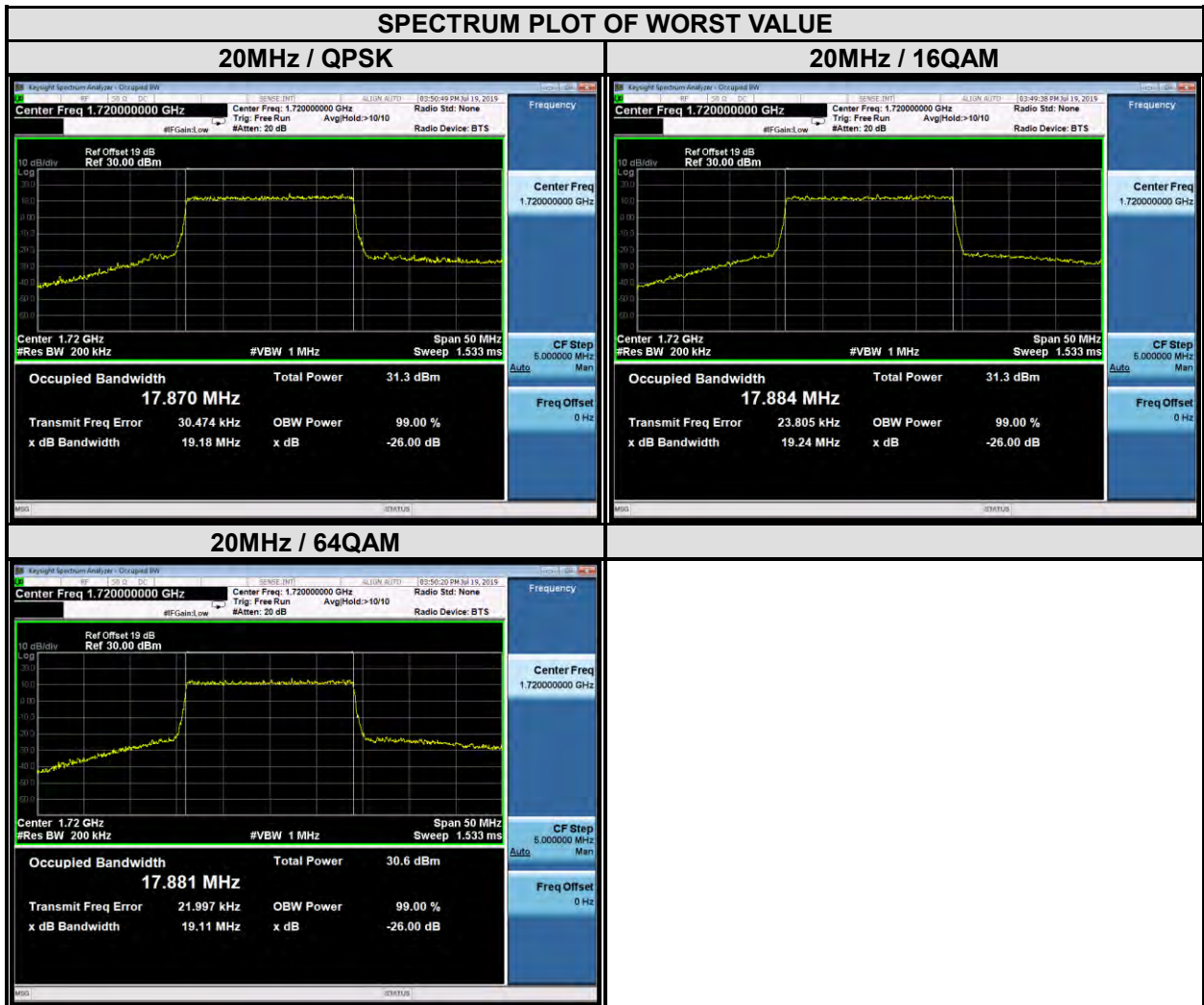

3.4 PEAK TO AVERAGE RATIO

3.4.1 LIMITS OF PEAK TO AVERAGE RATIO MEASUREMENT

In measuring transmissions in this band using an average power technique, the peak to-average ratio (PAR) of the transmission may not exceed 13 dB

3.4.2 TEST SETUP

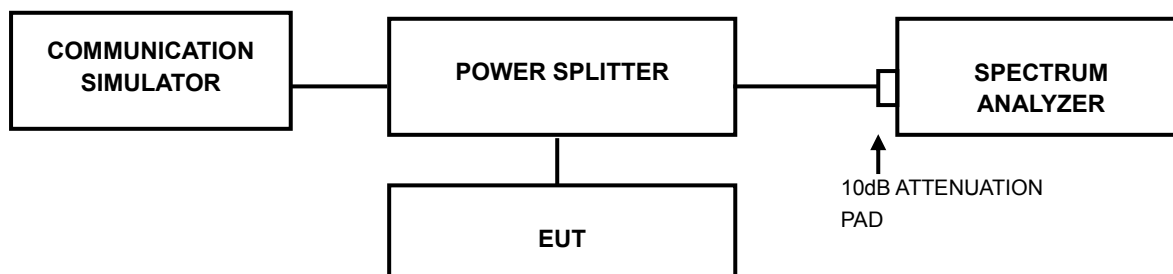

3.4.3 TEST PROCEDURES

1. Set resolution/measurement bandwidth \geq signal's occupied bandwidth;
2. Set the number of counts to a value that stabilizes the measured CCDF curve;
3. Record the maximum PAPR level associated with a probability of 0.1%.



Test Report No.: RF190712W002-5

3.4.4 TEST RESULTS

WCDMA Band IV

CHANNEL	FREQUENCY (MHz)	PEAK TO AVERAGE RATIO (dB)
1312	1712.4	2.78

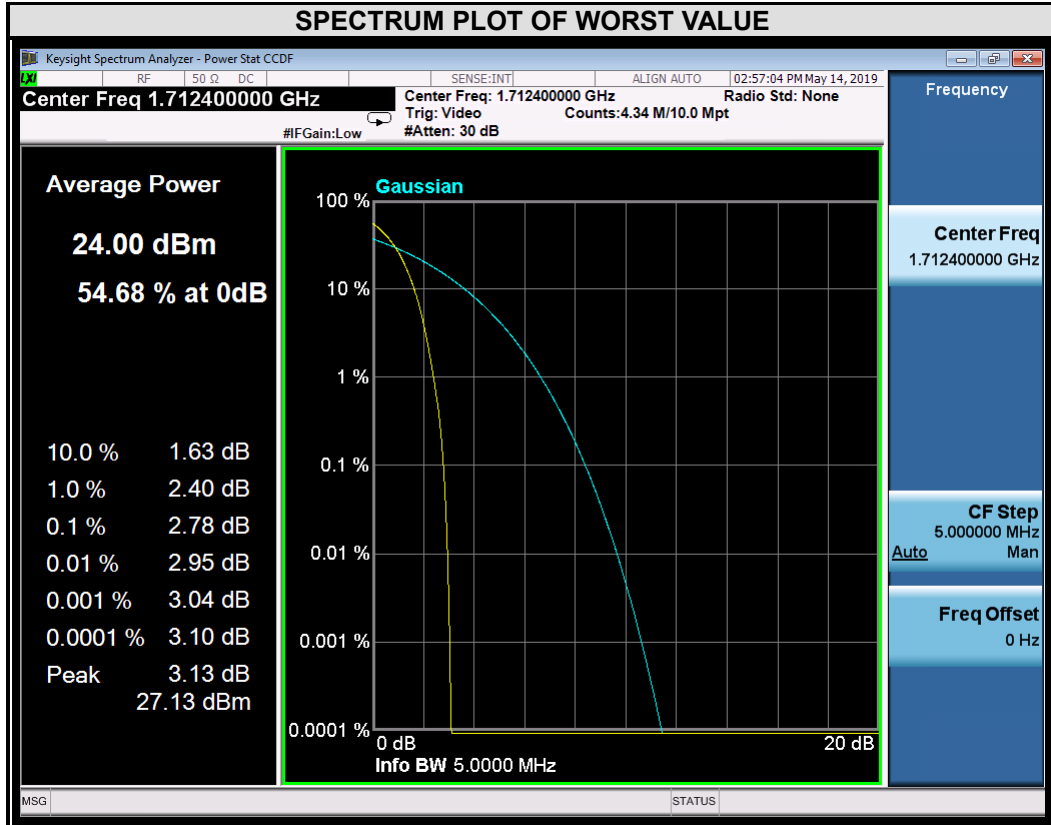



Test Report No.: RF190712W002-5

CHANNEL	FREQUENCY (MHz)	PEAK TO AVERAGE RATIO (dB)
1413	1732.6	3.00

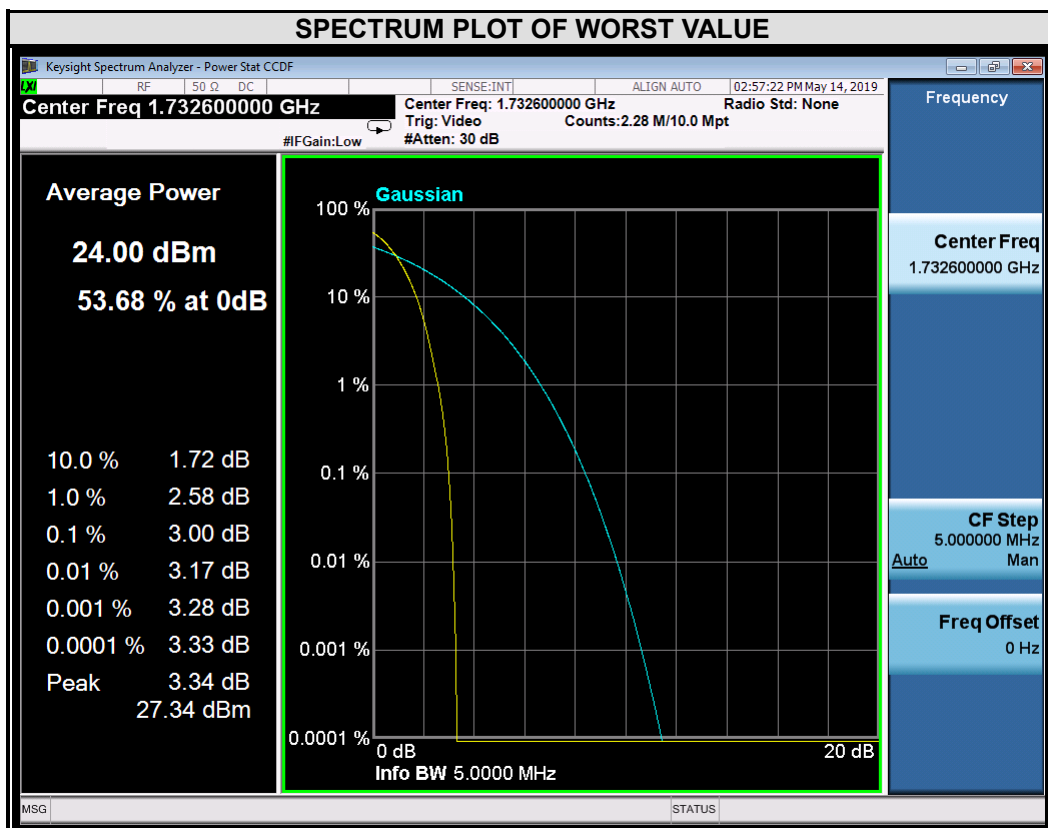



Test Report No.: RF190712W002-5

CHANNEL	FREQUENCY (MHz)	PEAK TO AVERAGE RATIO (dB)
1513	1752.6	3.00

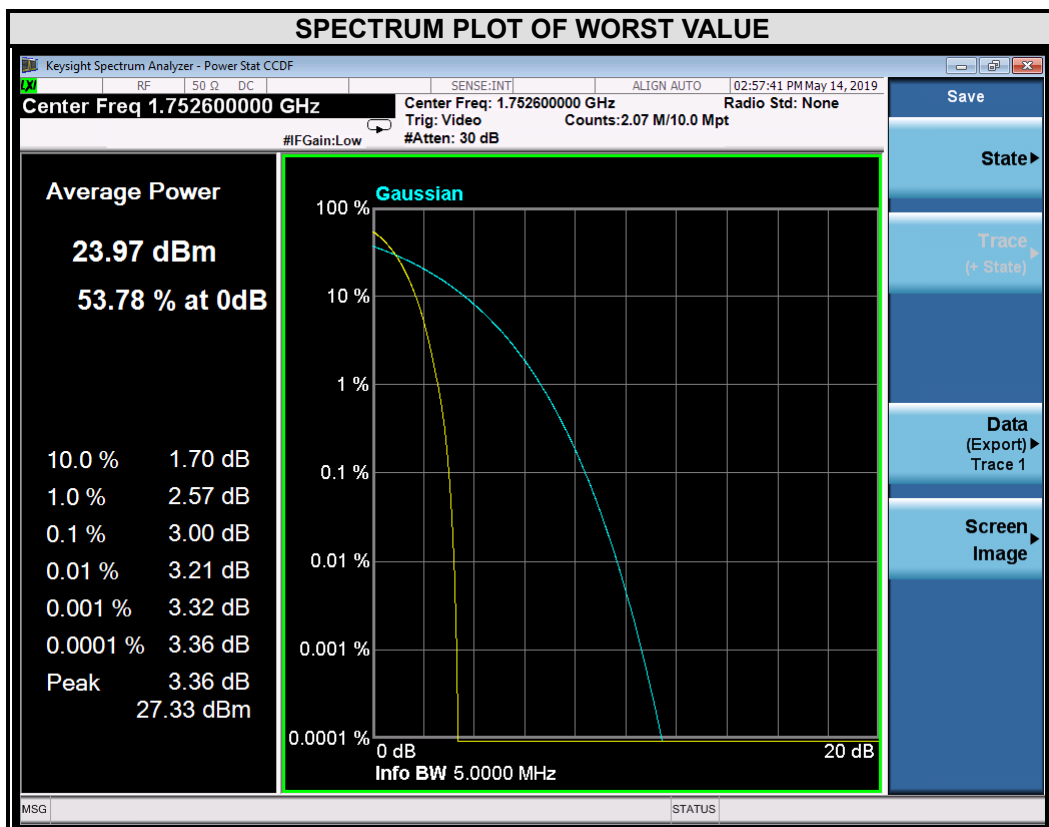

LTE BAND 4

CHANNEL BANDWIDTH: 1.4MHz				
CHANNEL	Frequency (MHz)	PEAK TO AVERAGE RATIO (dB)		
		QPSK	16QAM	64QAM
19957	1710.7	4.00	4.96	5.84
20175	1732.5	4.59	5.58	6.37
20393	1754.3	5.13	6.19	6.94

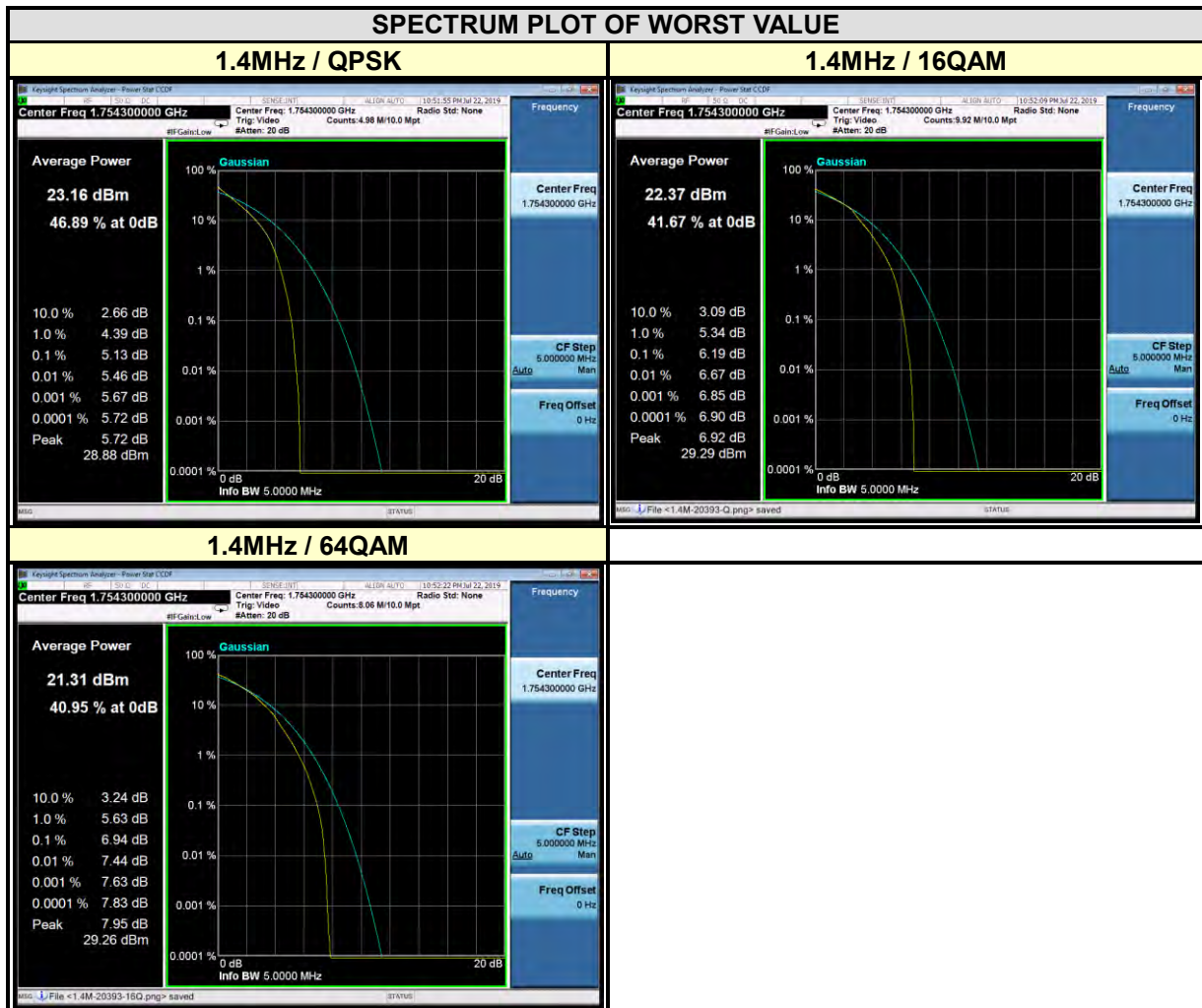

LTE BAND 4

CHANNEL BANDWIDTH: 3MHz				
CHANNEL	Frequency (MHz)	PEAK TO AVERAGE RATIO (dB)		
		QPSK	16QAM	64QAM
19965	1711.5	3.94	5.05	5.81
20175	1732.5	4.47	5.68	6.30
20385	1753.5	4.98	6.24	6.90

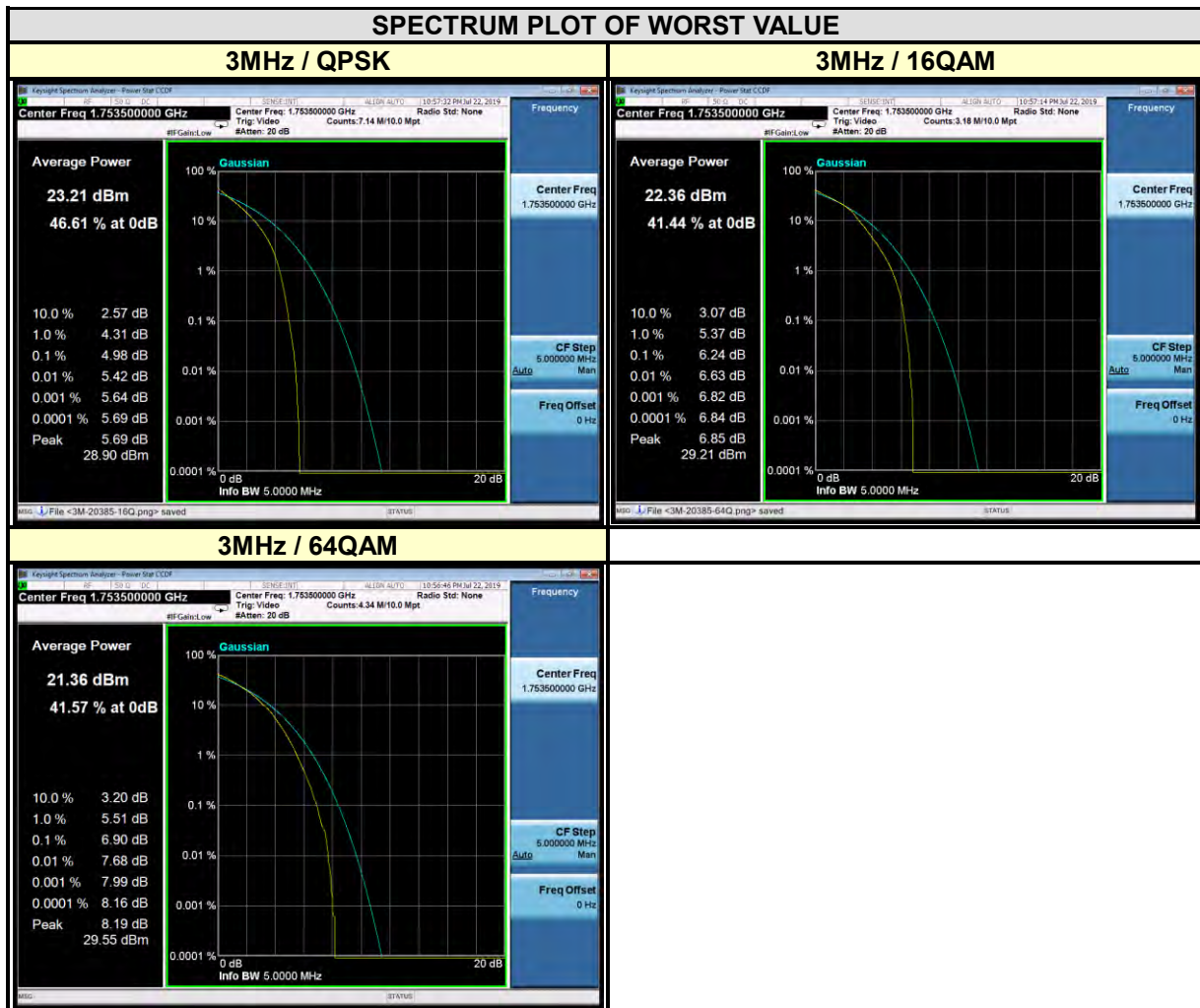

CHANNEL BANDWIDTH: 5MHz				
CHANNEL	Frequency (MHz)	PEAK TO AVERAGE RATIO (dB)		
		QPSK	16QAM	64QAM
19975	1712.5	4.30	5.29	6.01
20175	1732.5	4.72	5.75	6.39
20375	1752.5	5.07	6.16	6.84

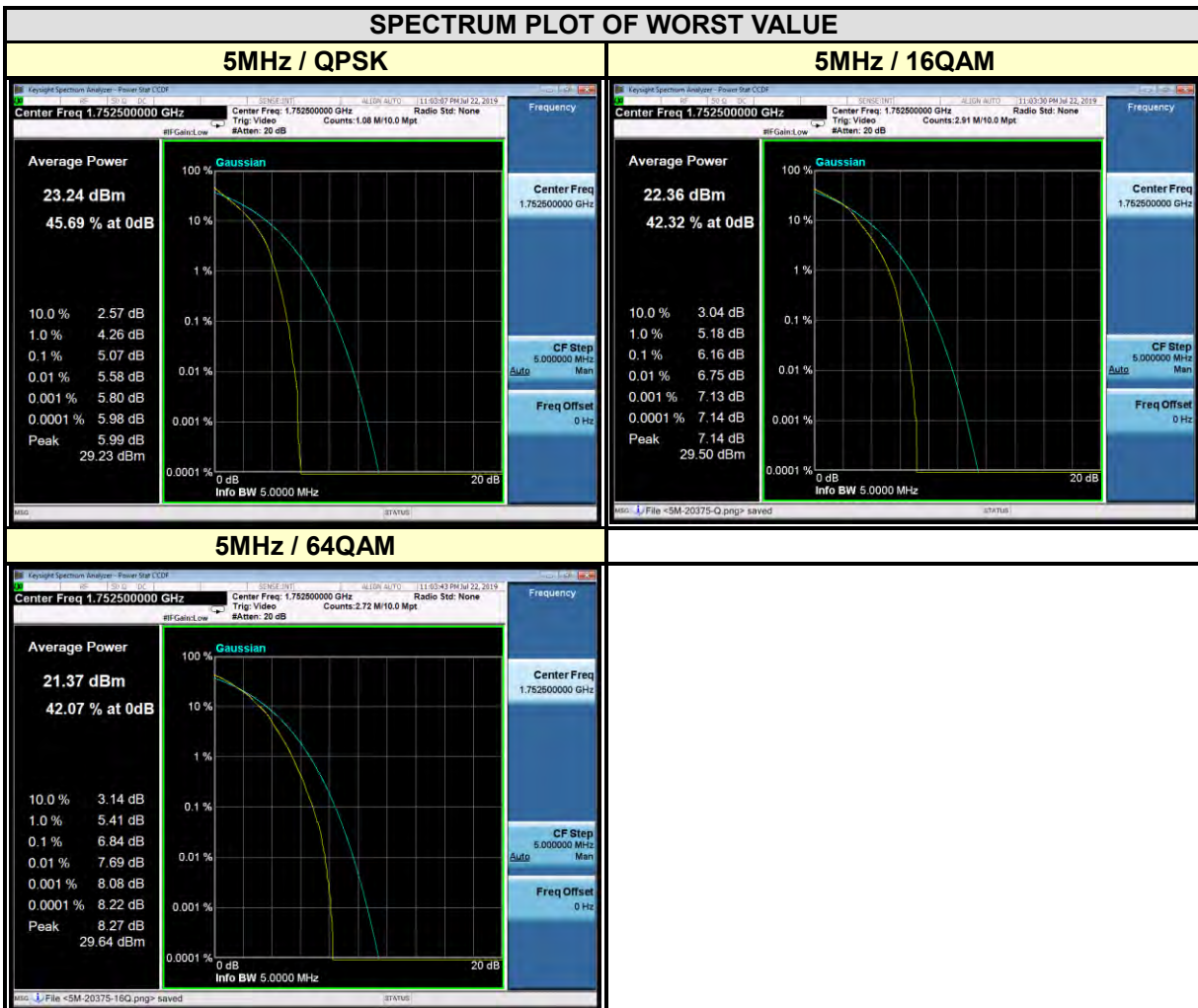



**BUREAU
VERITAS**

Test Report No.: RF190712W002-5

CHANNEL BANDWIDTH: 10MHz				
CHANNEL	Frequency (MHz)	PEAK TO AVERAGE RATIO (dB)		
		QPSK	16QAM	64QAM
20000	1715	4.18	5.19	5.90
20175	1732.5	4.53	5.60	6.25
20350	1750	4.98	6.03	6.66

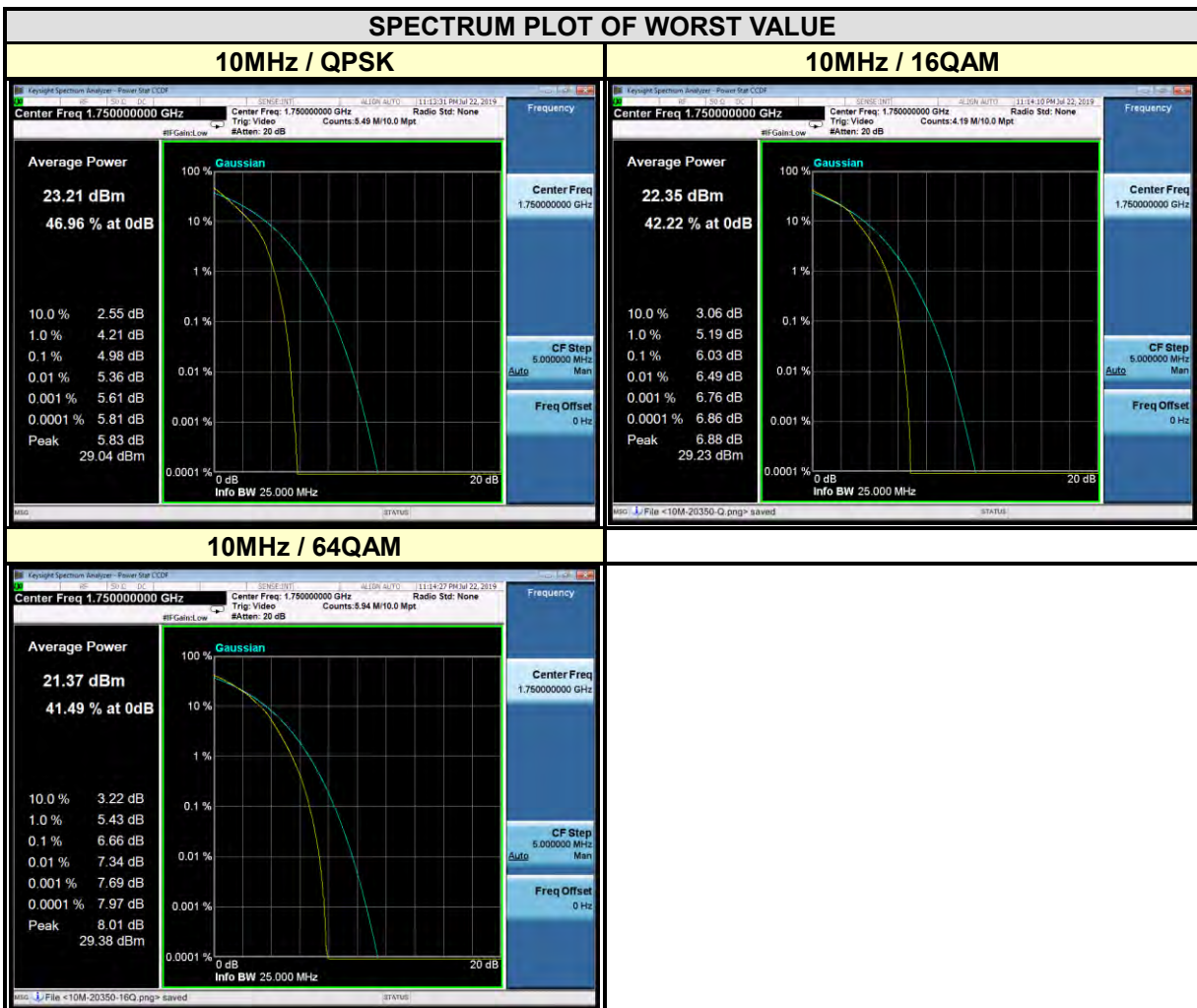



**BUREAU
VERITAS**

Test Report No.: RF190712W002-5

CHANNEL BANDWIDTH: 15MHz				
CHANNEL	Frequency (MHz)	PEAK TO AVERAGE RATIO (dB)		
		QPSK	16QAM	64QAM
20025	1717.5	4.53	5.55	6.25
20175	1732.5	4.67	5.78	6.46
20325	1747.5	4.85	5.92	6.60

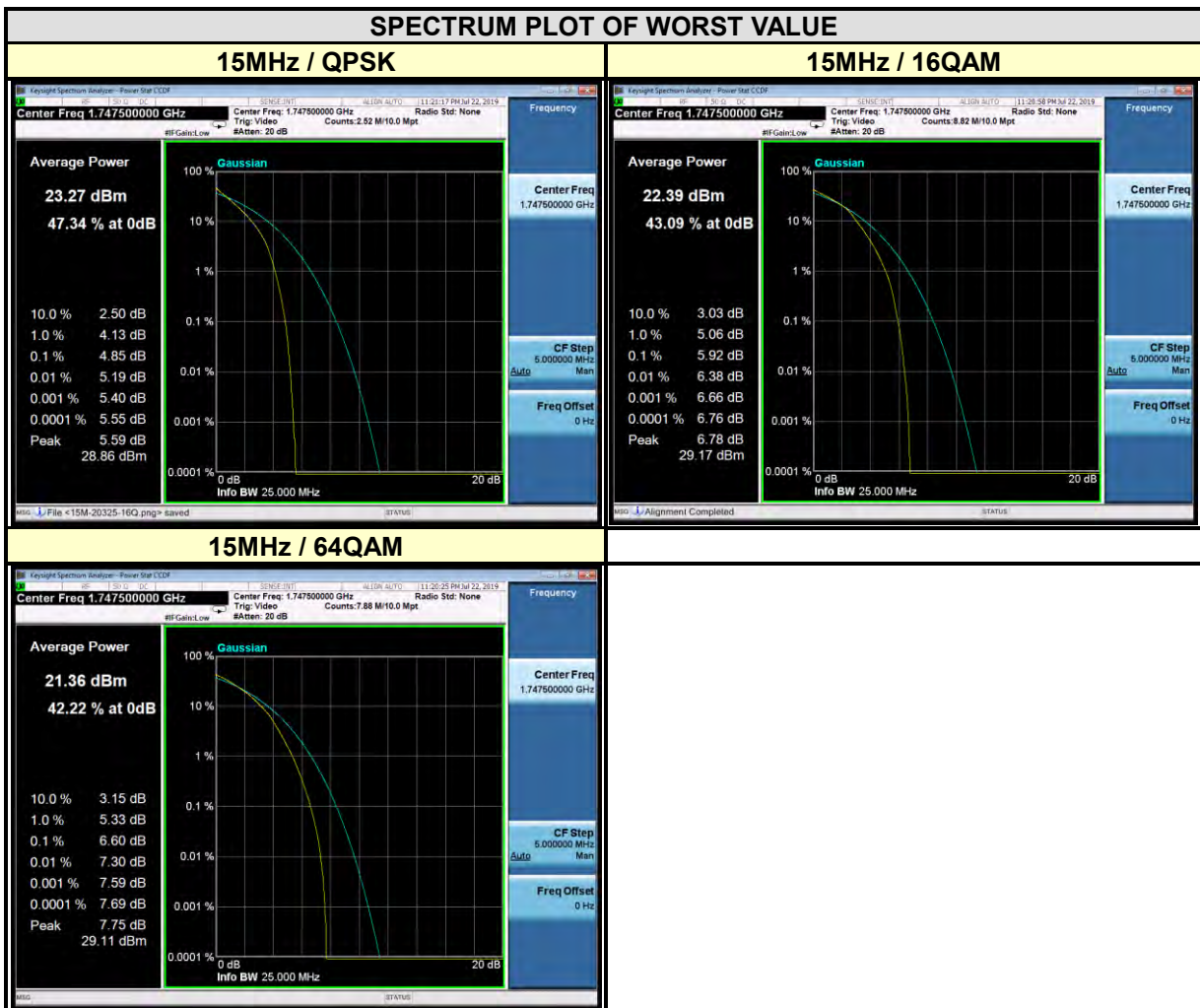



**BUREAU
VERITAS**

Test Report No.: RF190712W002-5

CHANNEL BANDWIDTH: 20MHz				
CHANNEL	Frequency (MHz)	PEAK TO AVERAGE RATIO (dB)		
		QPSK	16QAM	64QAM
20050	1720	4.72	5.80	6.42
20175	1732.5	4.62	5.81	6.43
20300	1745	4.79	5.89	6.47

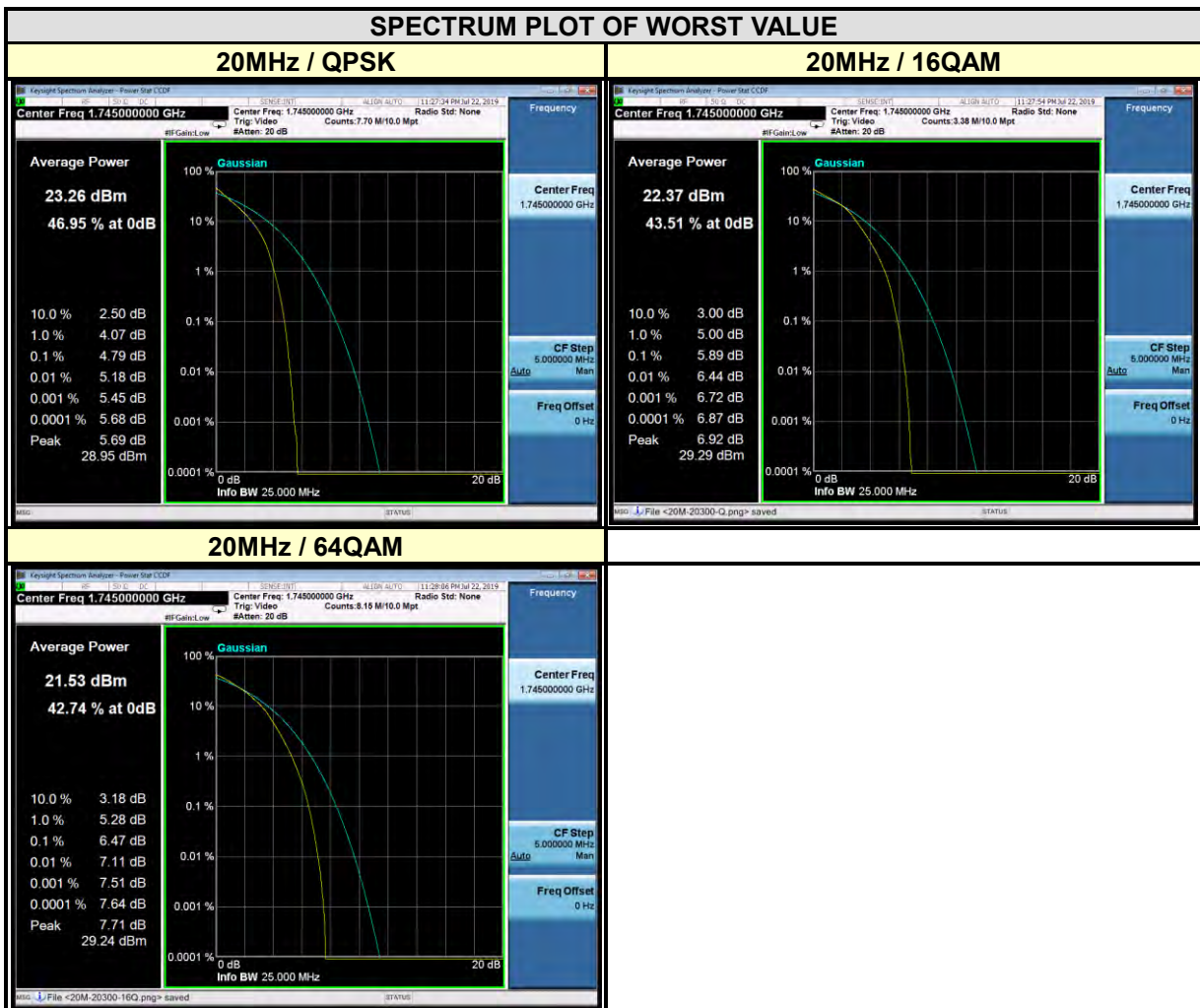

3.5 BAND EDGE MEASUREMENT

3.5.1 LIMITS OF BAND EDGE MEASUREMENT

The power of any emission outside a licensee's frequency band(s) of operation shall be attenuated below the transmitter power (P) within the licensed band(s) of operation, measured in watts, by at least $43 + 10 \log (P)$ dB. Compliance with this provision is based on the use of measurement instrumentation employing a resolution bandwidth of 100 kilohertz or greater.

However, in the 100 kilohertz bands immediately outside and adjacent to a licensee's frequency block, a resolution bandwidth of at least 30 kHz may be employed.

3.5.2 TEST SETUP

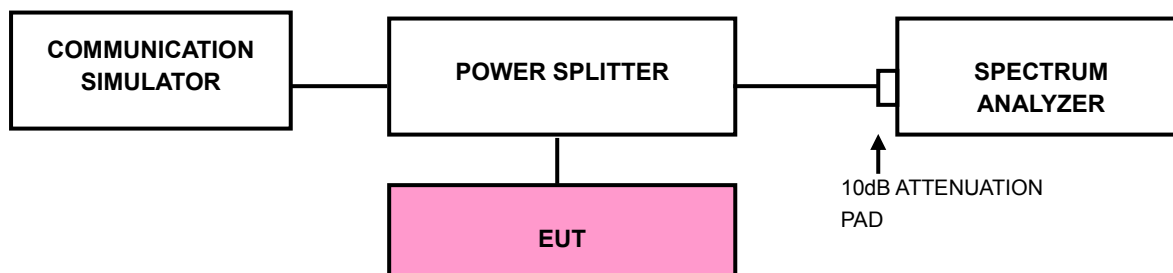



3.5.3 TEST PROCEDURES

- a. The EUT was set up for the maximum peak power with LTE link data modulation. The power was measured with R&S Spectrum Analyzer. All measurements were done at 2 channels (low and high operational frequency range.).
- b. The band edge measurement used the power splitter via EUT RF power connector between simulation base station and spectrum analyzer.
- c. The center frequency of spectrum is the band edge frequency and span is 10MHz. RBW of the spectrum is 100kHz and VBW of the spectrum is 300kHz (WCDMA).
- d. The center frequency of spectrum is the band edge frequency and span is 1~5 MHz. RBW of the spectrum is 20kHz and VBW of the spectrum is 100 kHz. (LTE bandwidth 1.4MHz)
- e. The center frequency of spectrum is the band edge frequency and span is 1~5 MHz. RBW of the spectrum is 30kHz and VBW of the spectrum is 100kHz. (LTE bandwidth 3MHz)
- f. The center frequency of spectrum is the band edge frequency and span is 1~5 MHz. RBW of the spectrum is 50kHz and VBW of the spectrum is 200kHz. (LTE bandwidth 5MHz)
- g. The center frequency of spectrum is the band edge frequency and span is 1~5 MHz. RBW of the spectrum is 100kHz and VBW of the spectrum is 300kHz. (LTE bandwidth 10MHz)
- h. The center frequency of spectrum is the band edge frequency and span is 1~5 MHz. RBW of the spectrum is 200kHz and VBW of the spectrum is 1MHz. (LTE bandwidth 15MHz)
- i. The center frequency of spectrum is the band edge frequency and span is 1~5 MHz. RBW of the spectrum is 200kHz and VBW of the spectrum is 1MHz. (LTE bandwidth 20MHz)
- j. Record the max trace plot into the test report.



BUREAU VERITAS

Test Report No.: RF190712W002-5

3.5.4 TEST RESULTS

WCDMA BAND 4

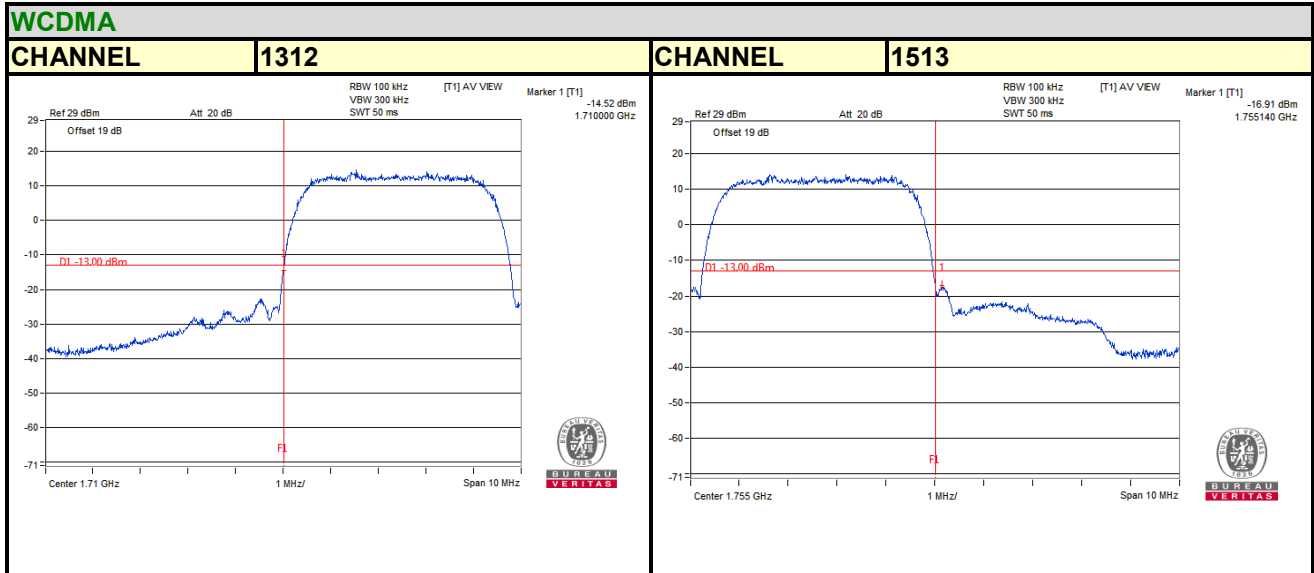



BUREAU VERITAS

Test Report No.: RF190712W002-5

LTE BAND 4

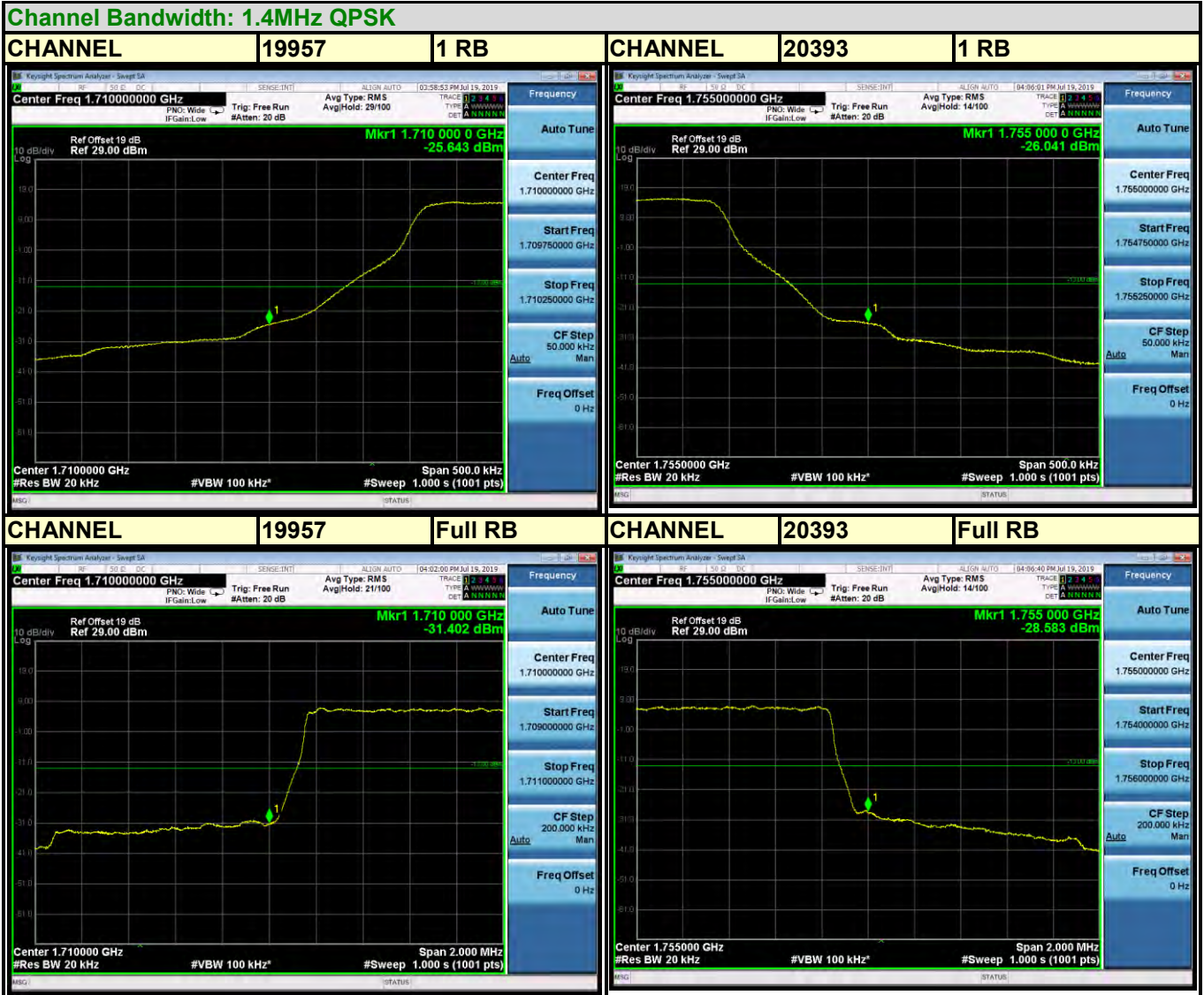



Test Report No.: RF190712W002-5

Channel Bandwidth: 1.4MHz 16QAM

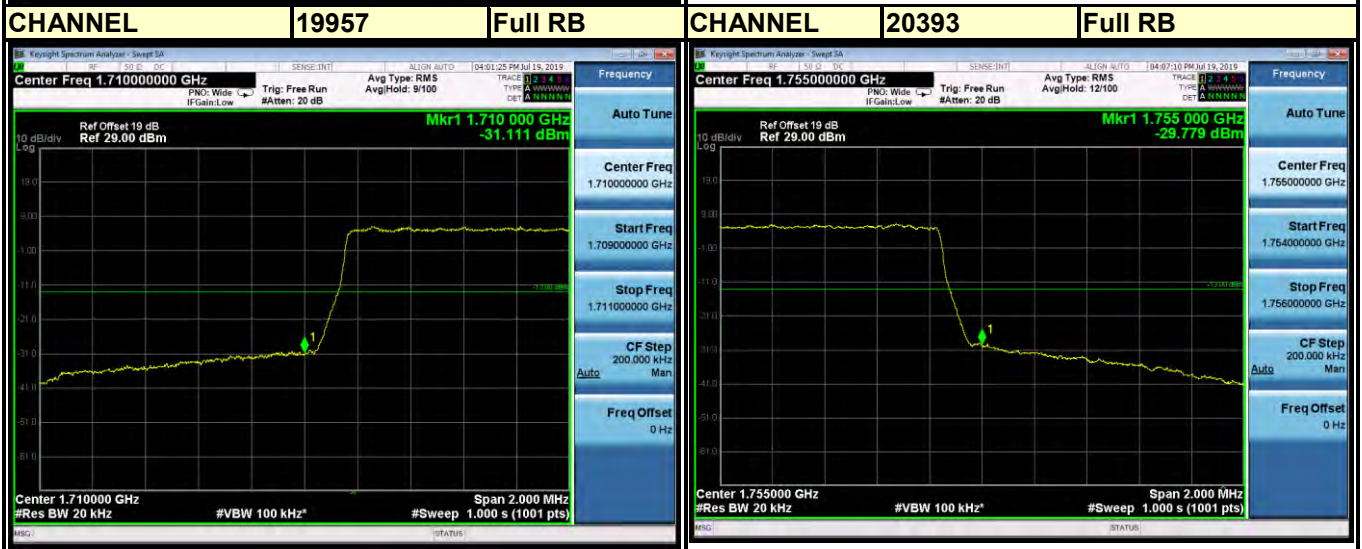



Test Report No.: RF190712W002-5

Channel Bandwidth: 1.4MHz 64QAM

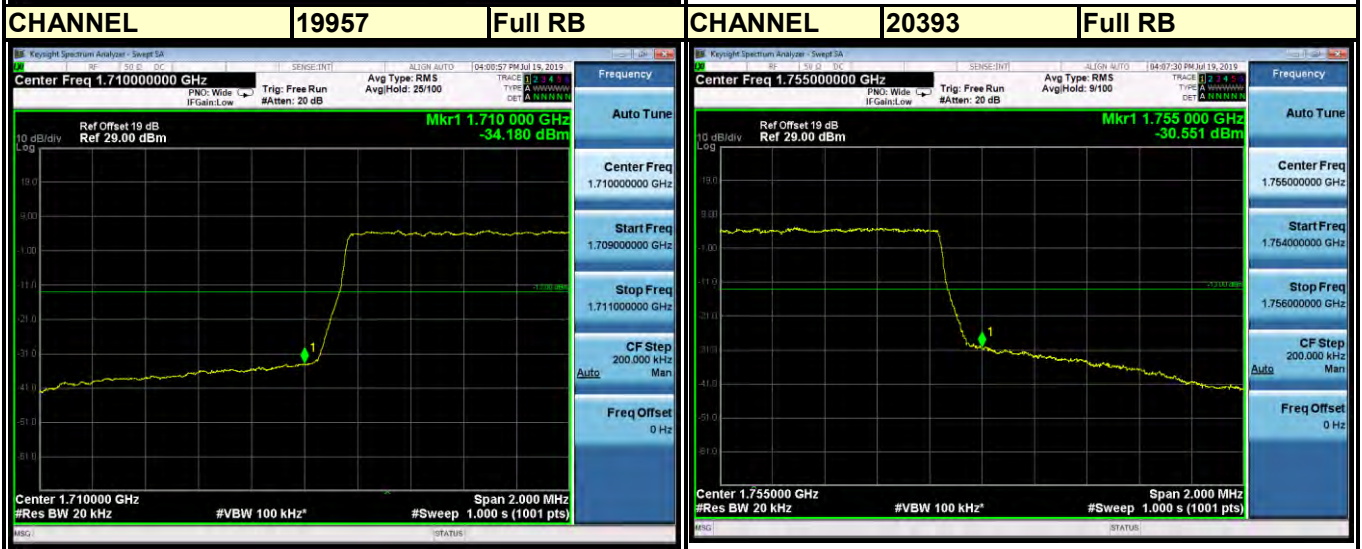



BUREAU VERITAS

Test Report No.: RF190712W002-5

LTE BAND 4

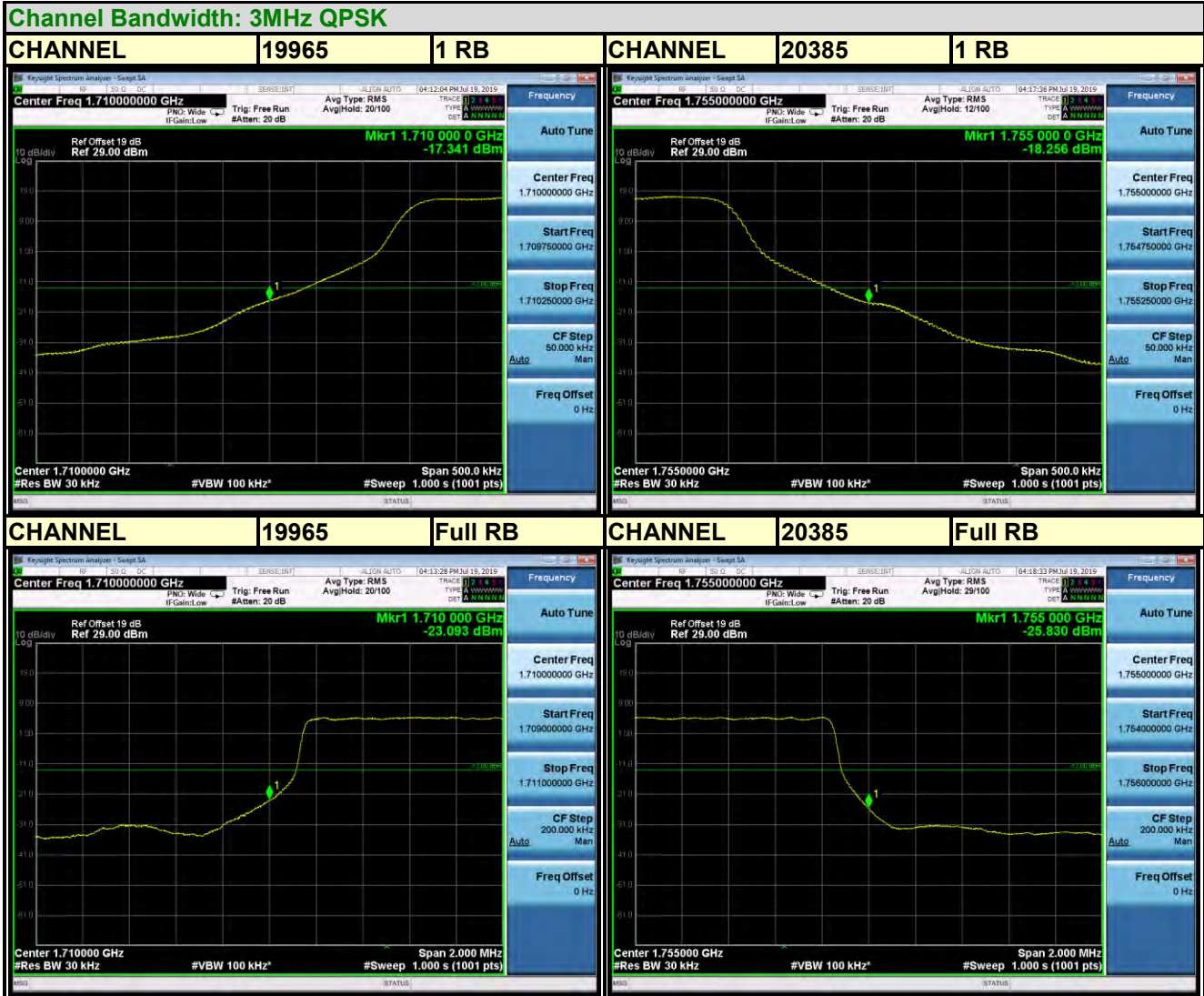



BUREAU VERITAS

Test Report No.: RF190712W002-5





BUREAU VERITAS

Test Report No.: RF190712W002-5

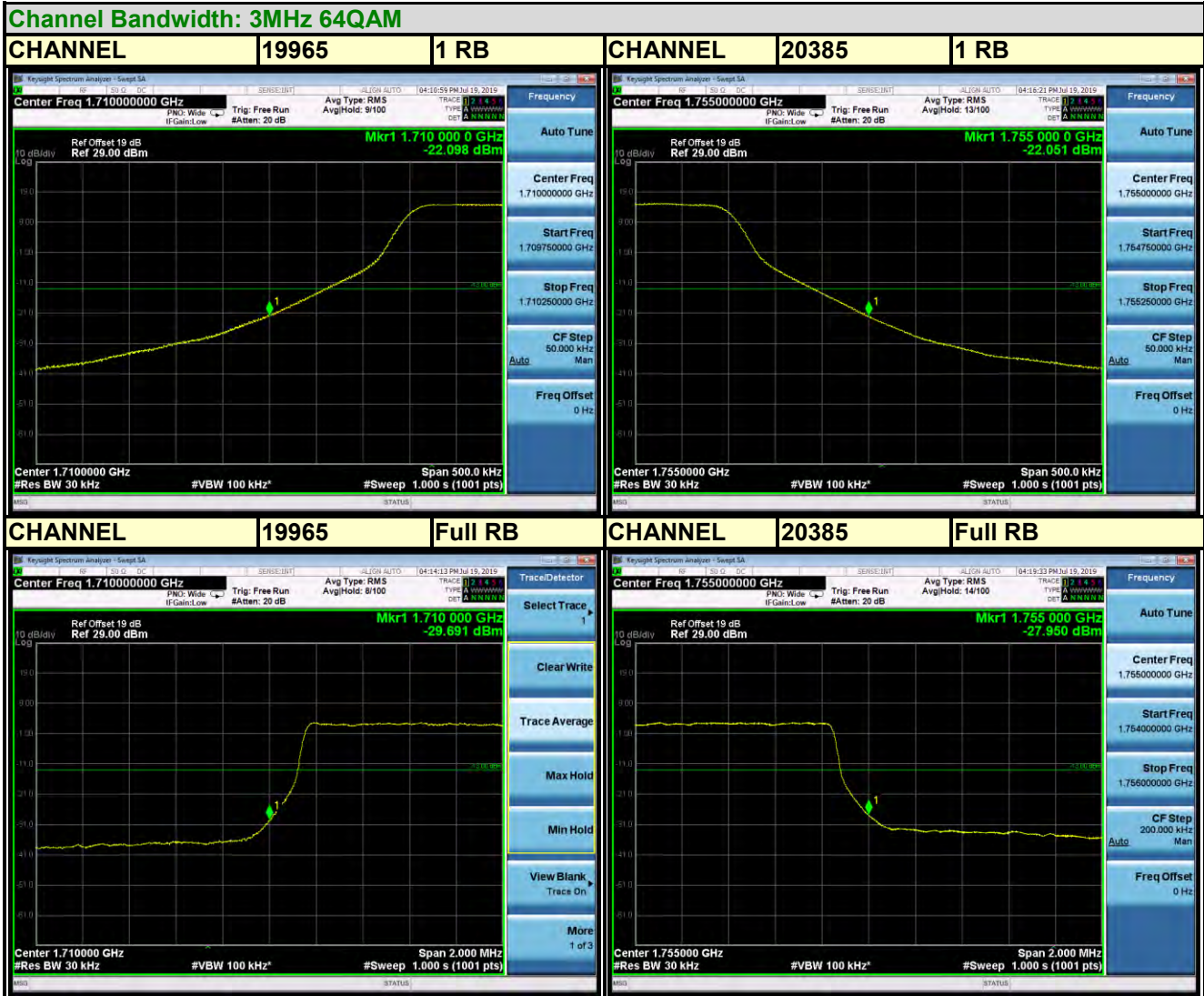



BUREAU VERITAS

Test Report No.: RF190712W002-5

LTE BAND 4

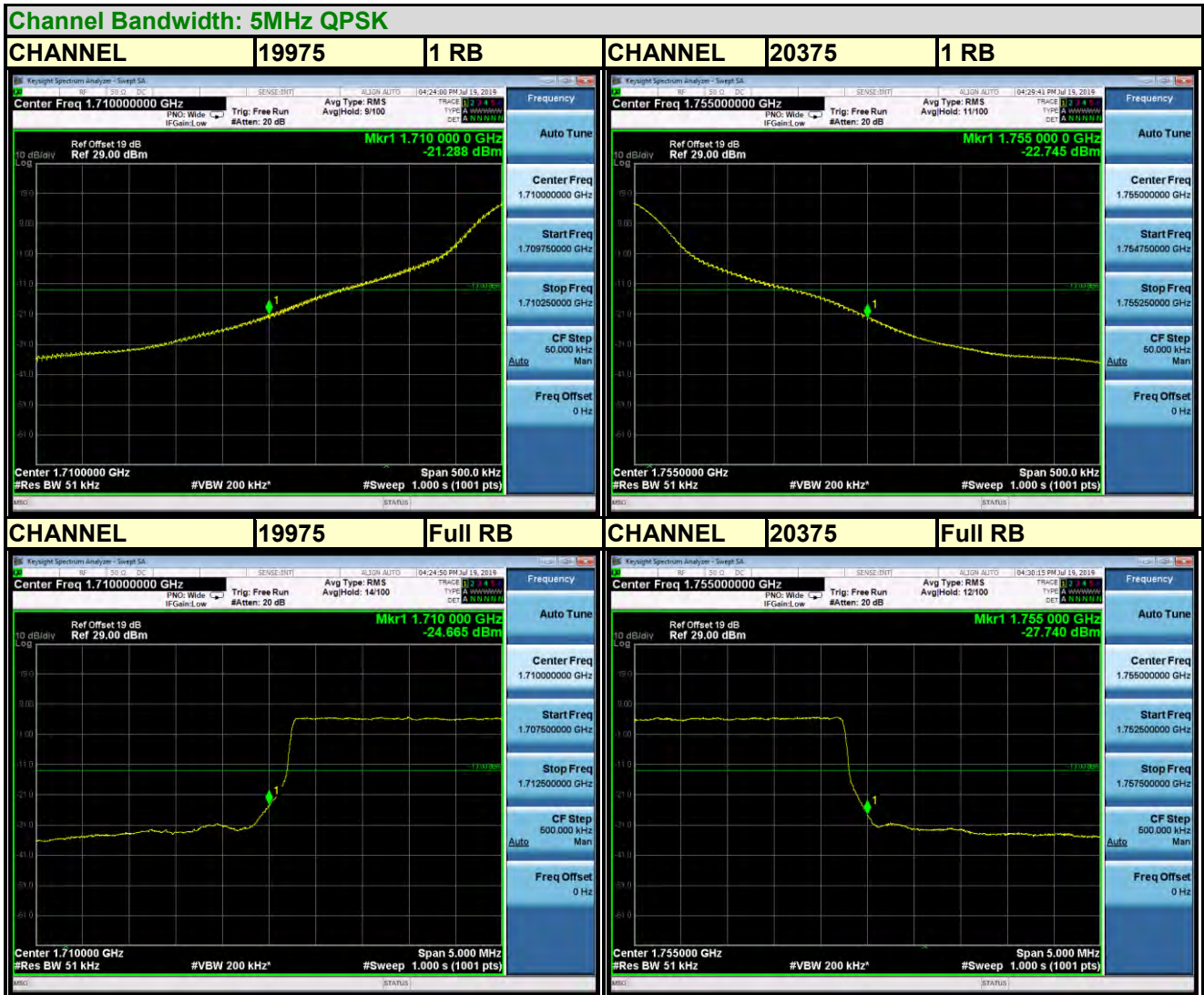



BUREAU VERITAS

Test Report No.: RF190712W002-5

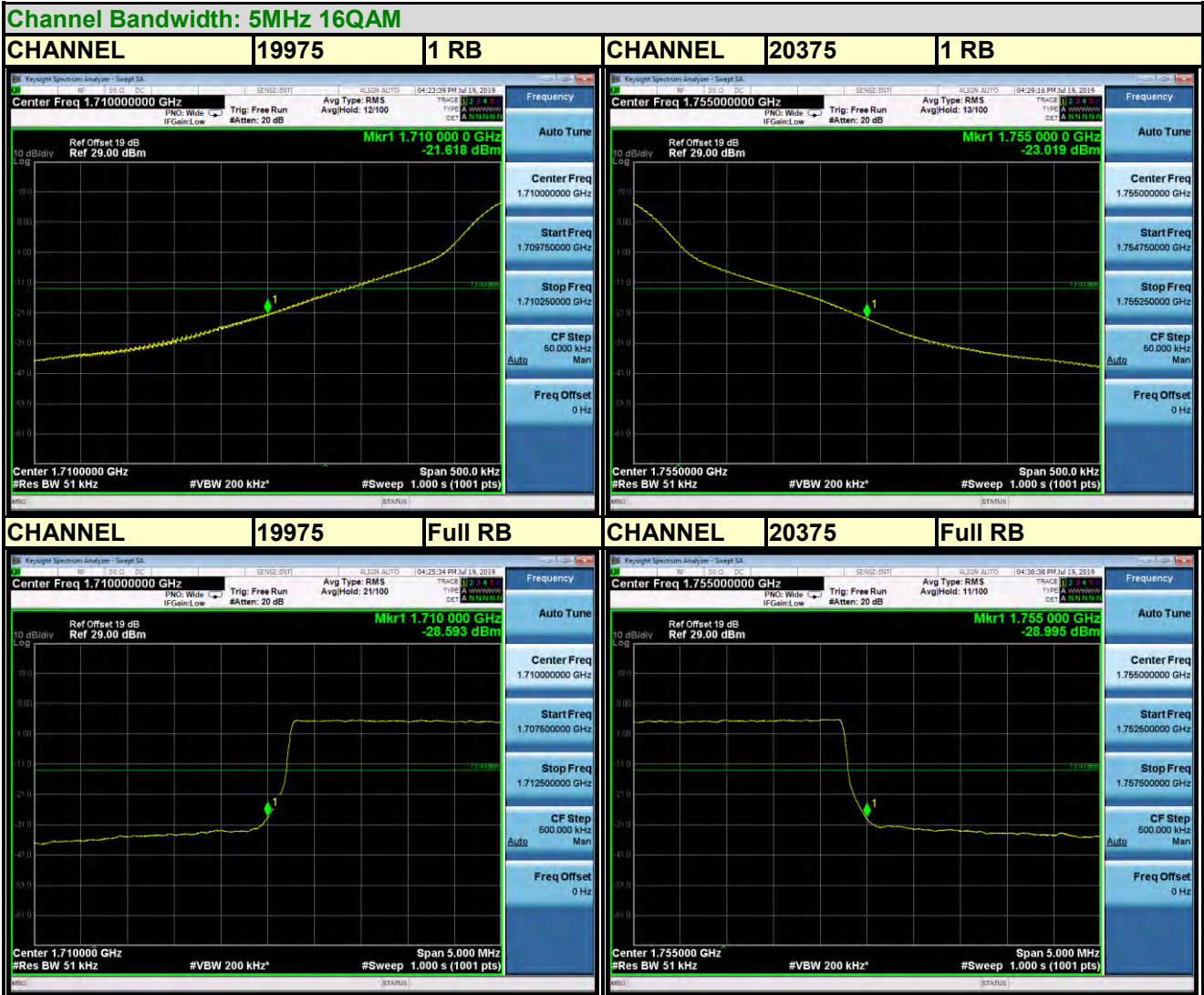



BUREAU VERITAS

Test Report No.: RF190712W002-5

Channel Bandwidth: 5MHz 64QAM





LTE BAND 4

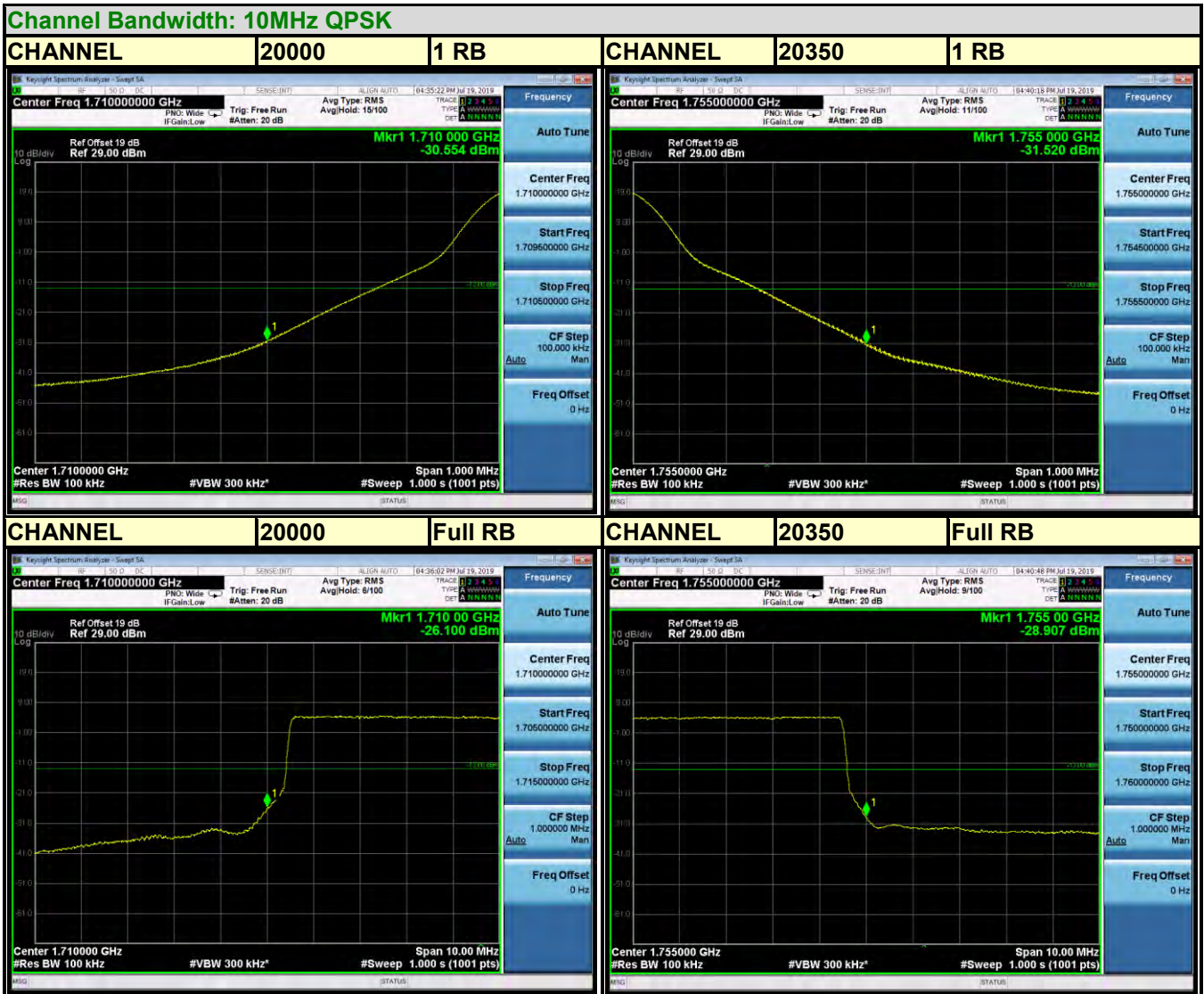



BUREAU VERITAS

Test Report No.: RF190712W002-5

Channel Bandwidth: 10MHz 16QAM

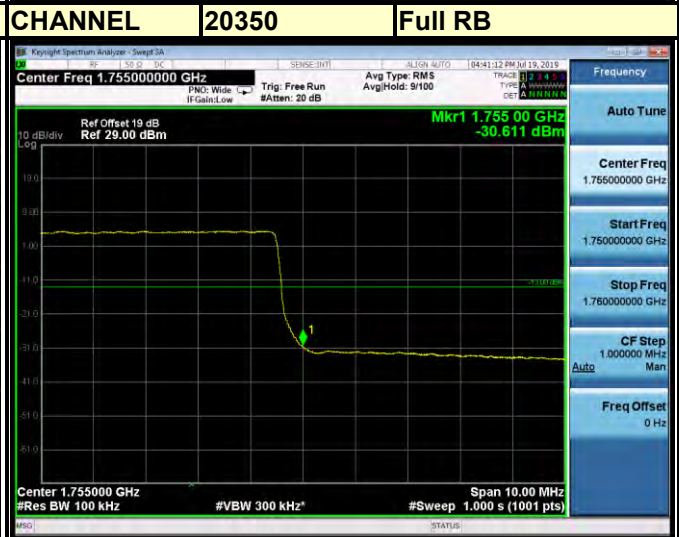
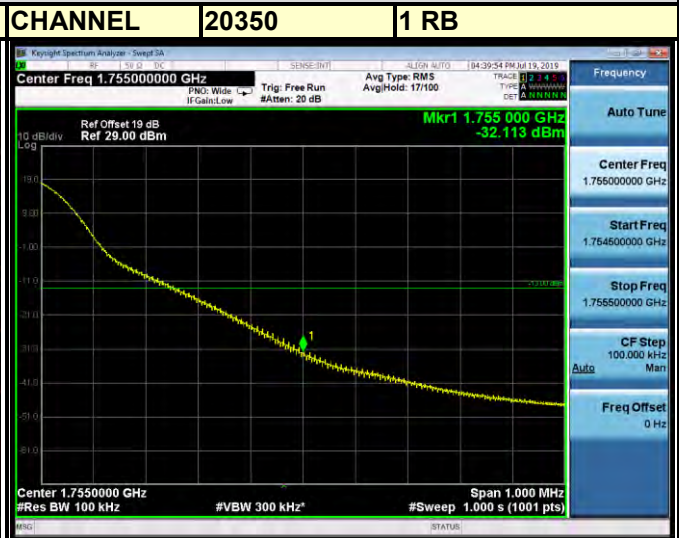
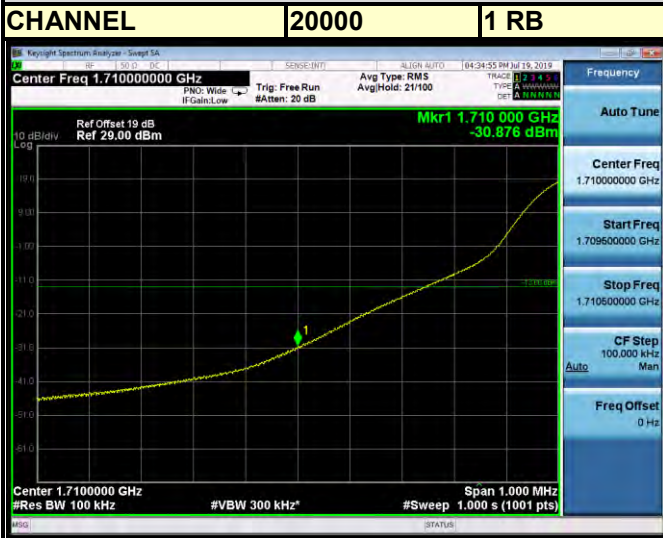



BUREAU VERITAS

Test Report No.: RF190712W002-5

Channel Bandwidth: 10MHz 64QAM

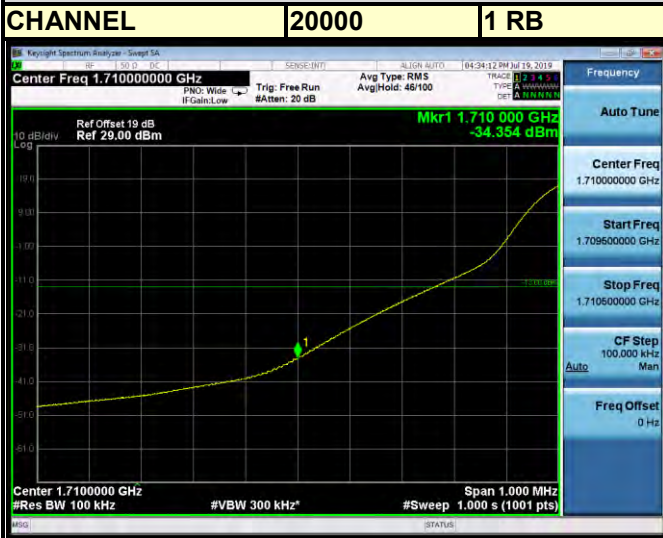



BUREAU VERITAS

Test Report No.: RF190712W002-5

LTE BAND 4

Channel Bandwidth: 15MHz QPSK





BUREAU VERITAS

Test Report No.: RF190712W002-5

Channel Bandwidth: 15MHz 16QAM

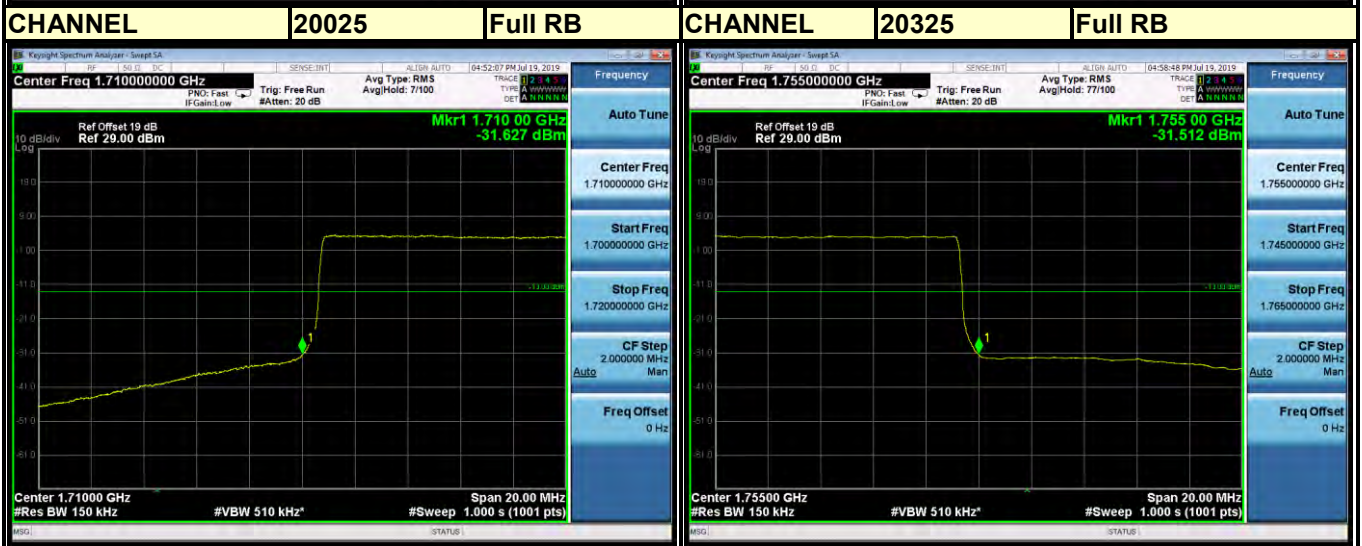
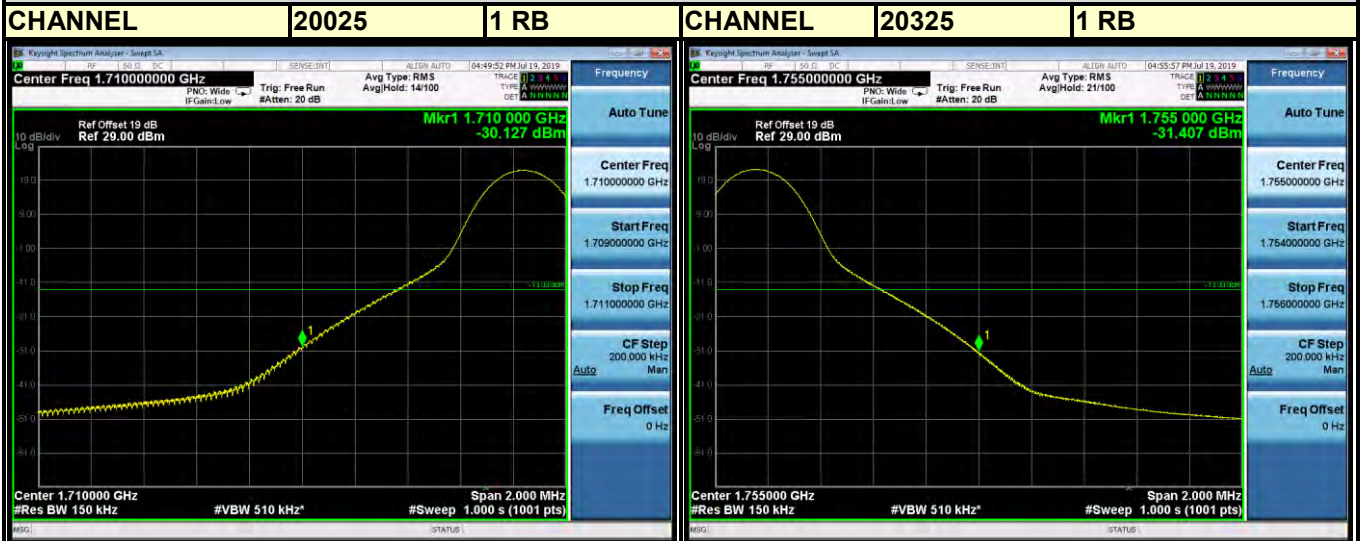



BUREAU VERITAS

Test Report No.: RF190712W002-5

Channel Bandwidth: 15MHz 64QAM

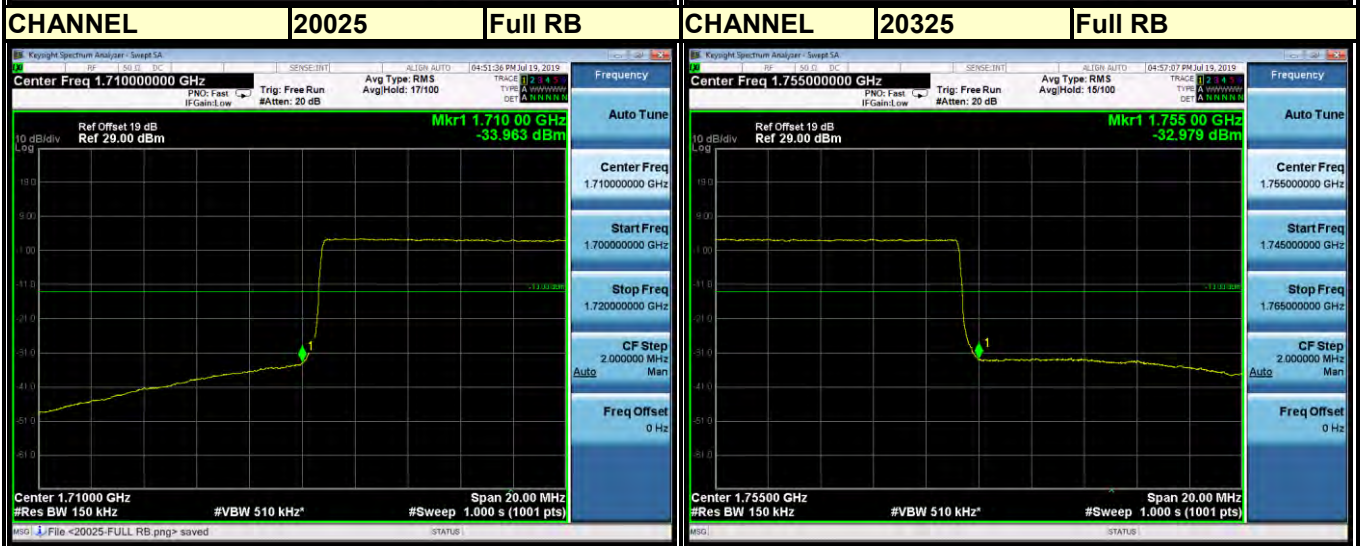
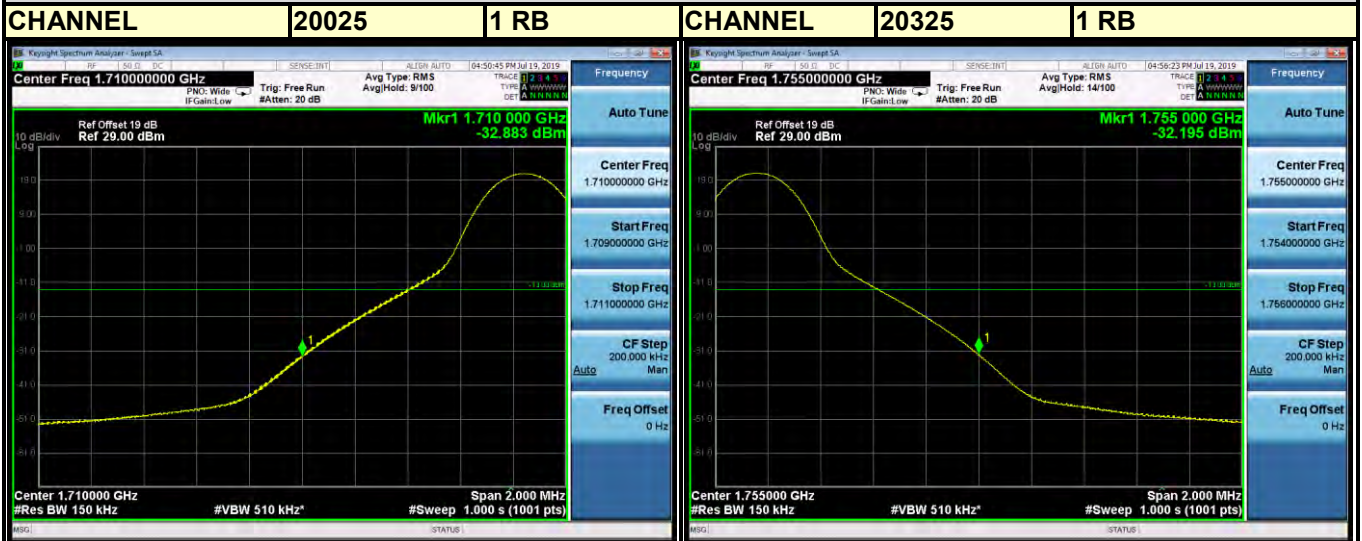



BUREAU VERITAS

Test Report No.: RF190712W002-5

LTE BAND 4

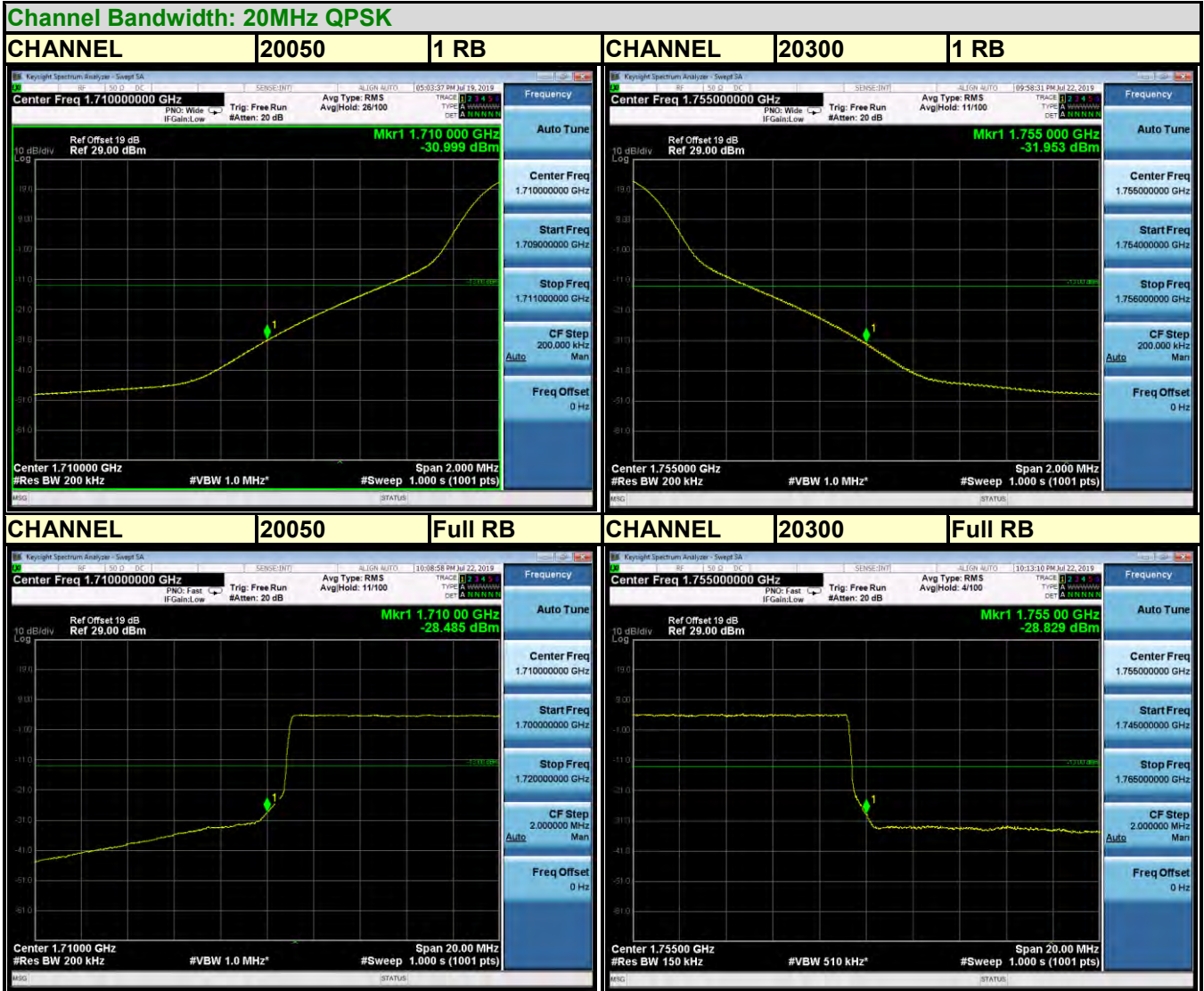



Test Report No.: RF190712W002-5

Channel Bandwidth: 20MHz 16QAM

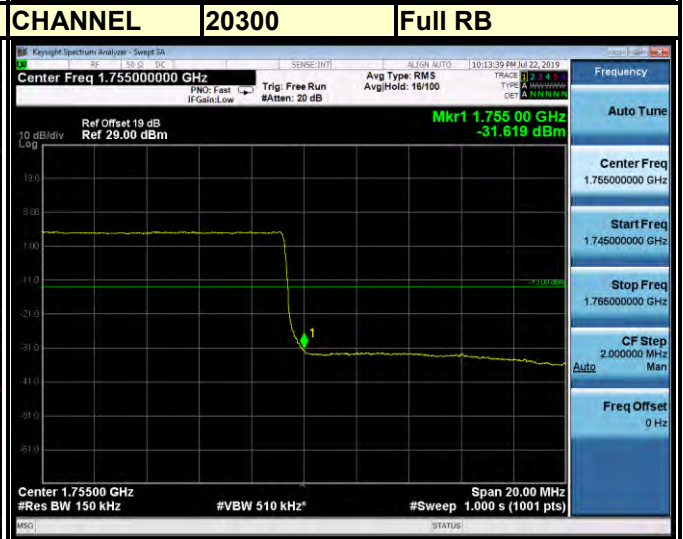
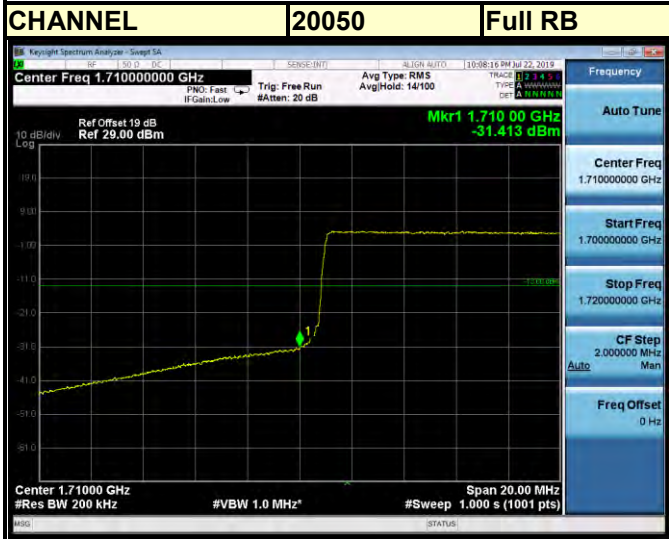
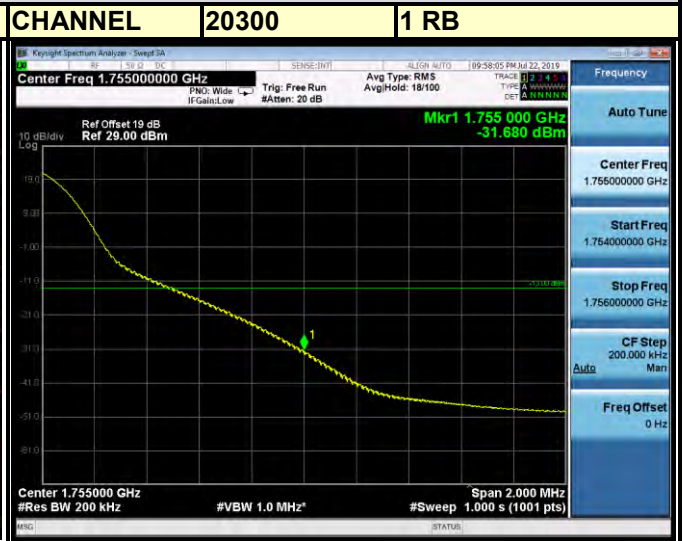
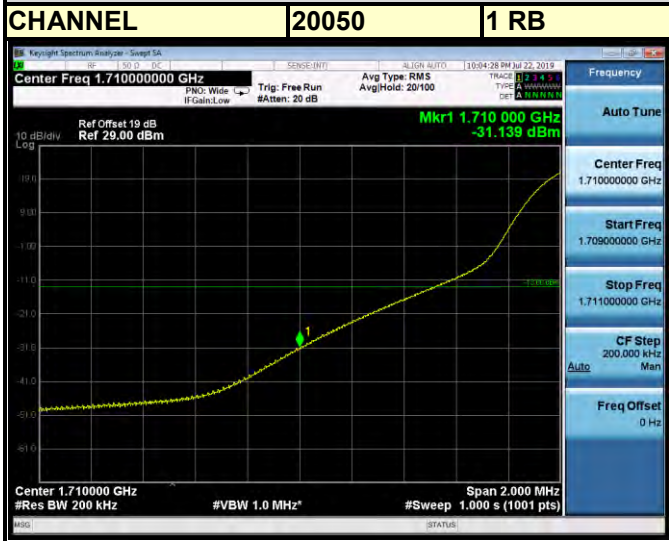



BUREAU VERITAS

Test Report No.: RF190712W002-5

Channel Bandwidth: 20MHz 64QAM

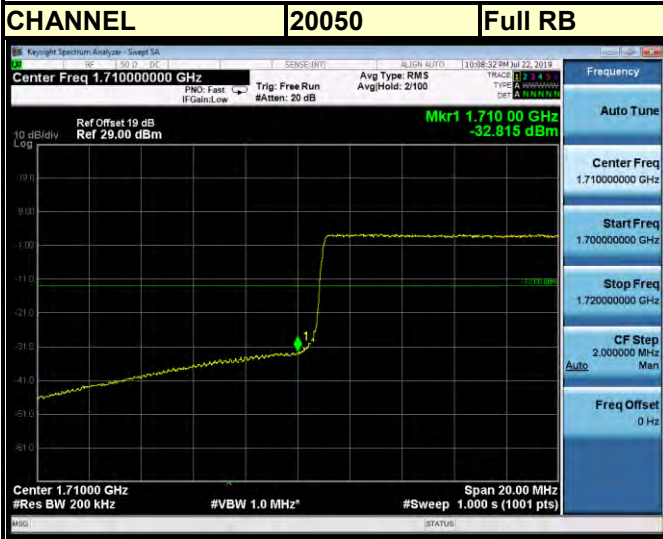
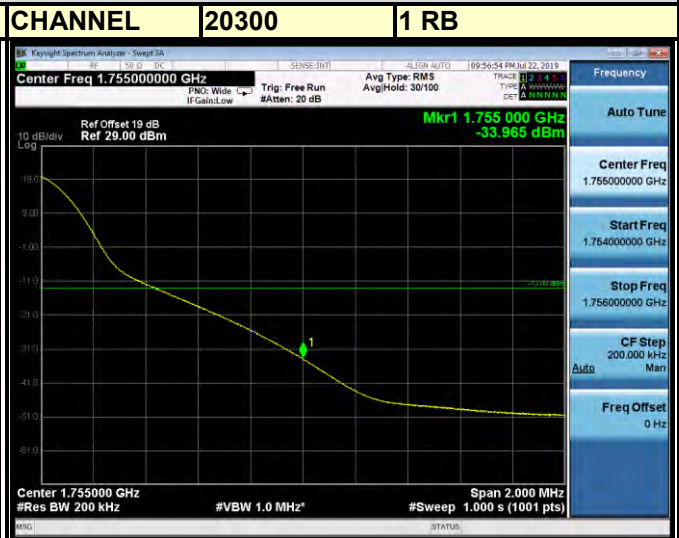
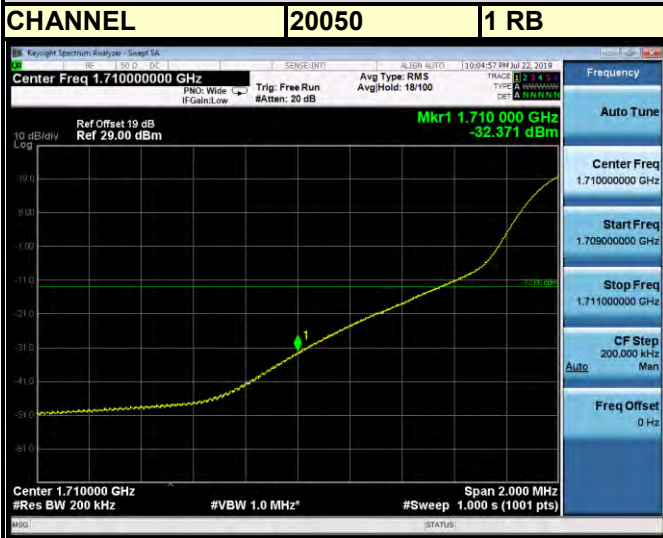

3.6 CONDUCTED SPURIOUS EMISSIONS

3.6.1 LIMITS OF CONDUCTED SPURIOUS EMISSIONS MEASUREMENT

The power of any emission outside a licensee's frequency block shall be attenuated below the transmitter power (P) by at least $43 + 10 \log_{10}(P)$ dB. The limit of emission equal to -13dBm

3.6.2 TEST PROCEDURE

- a. The EUT makes a phone call to the communication simulator. All measurements were done at middle operational frequency range.
- b. Measuring frequency range is from 30 MHz to 19.1GHz for WCDMA Band 4 & LTE Band 4. 10dB attenuation pad is connected with spectrum. RBW=1MHz and VBW=3MHz are used for conducted emission measurement.

3.6.3 TEST SETUP

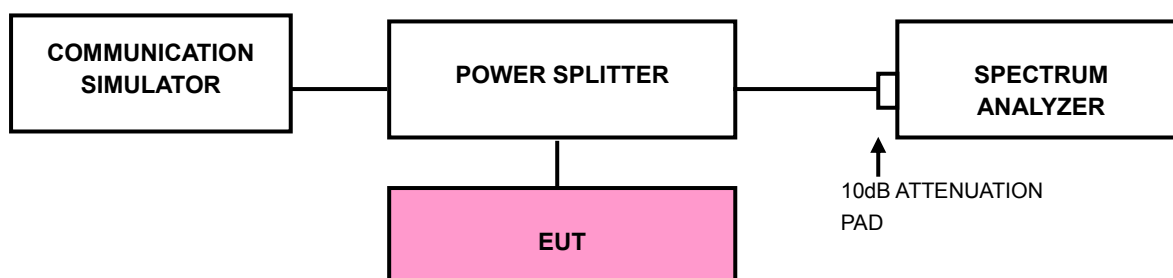



BUREAU VERITAS

Test Report No.: RF190712W002-5

3.6.4 TEST RESULTS

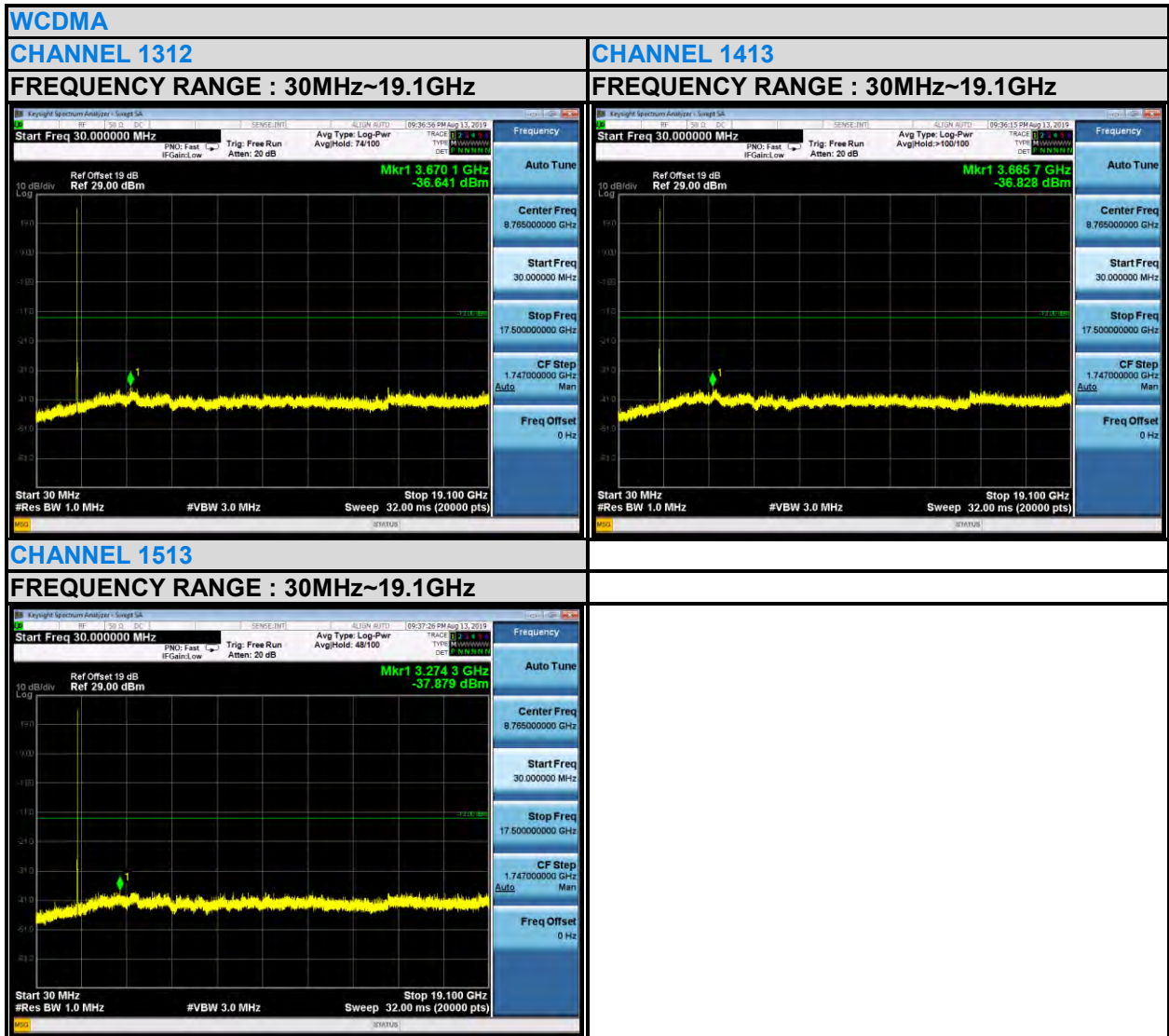



BUREAU VERITAS

Test Report No.: RF190712W002-5

LTE BAND 4

1.4MHz / QPSK

CHANNEL 19957

FREQUENCY RANGE : 30MHz~19.1GHz

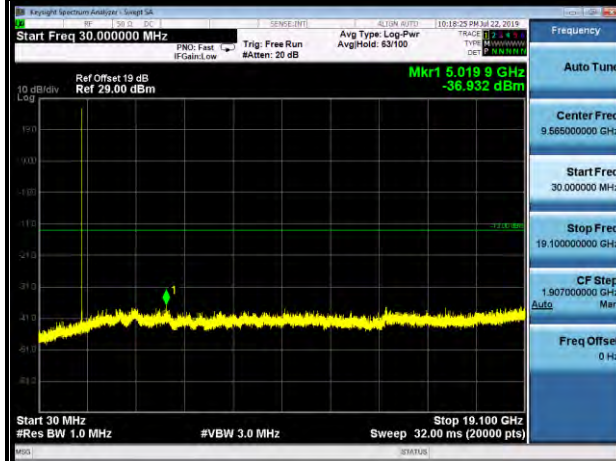

CHANNEL 20175

FREQUENCY RANGE : 30MHz~19.1GHz

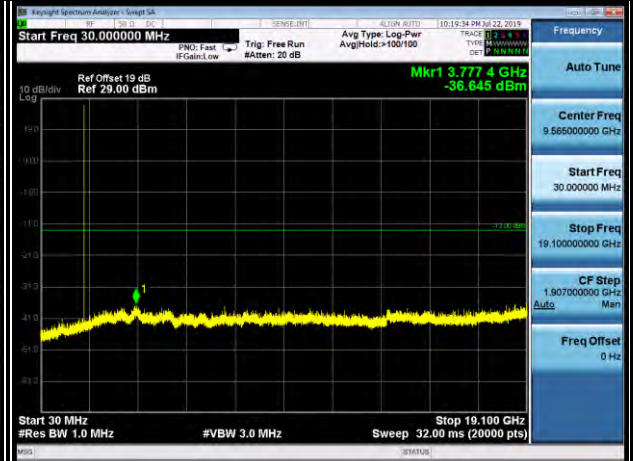

CHANNEL 20393

FREQUENCY RANGE : 30MHz~19.1GHz

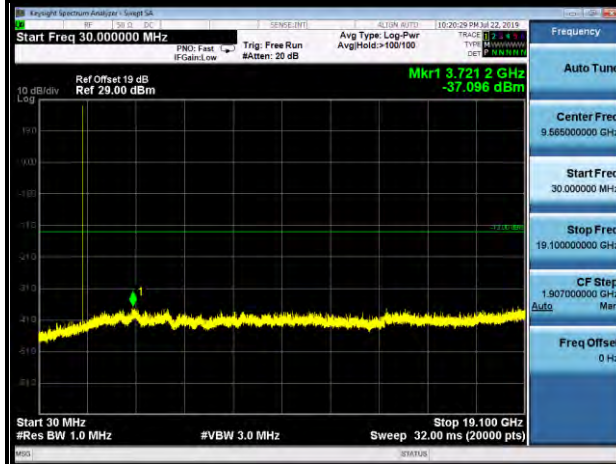



BUREAU VERITAS

Test Report No.: RF190712W002-5

3MHz / QPSK

CHANNEL 19965

FREQUENCY RANGE : 30MHz~19.1GHz

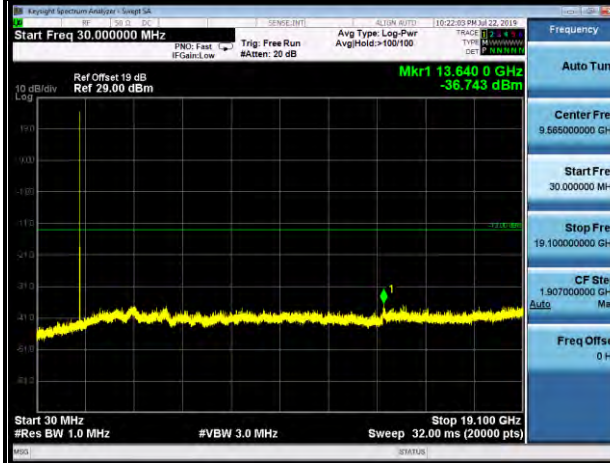

CHANNEL 20175

FREQUENCY RANGE : 30MHz~19.1GHz



CHANNEL 20385

FREQUENCY RANGE : 30MHz~19.1GHz

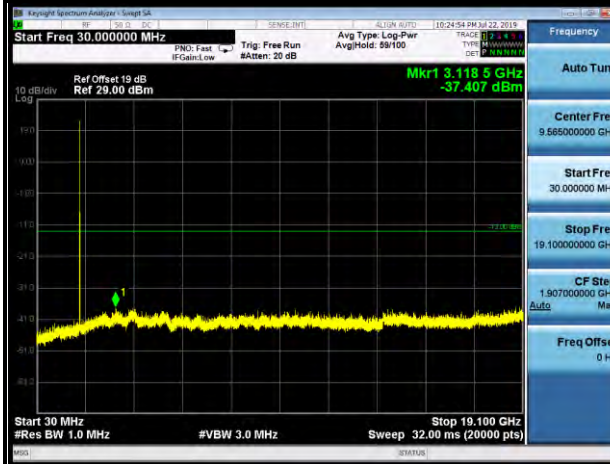



BUREAU VERITAS

Test Report No.: RF190712W002-5

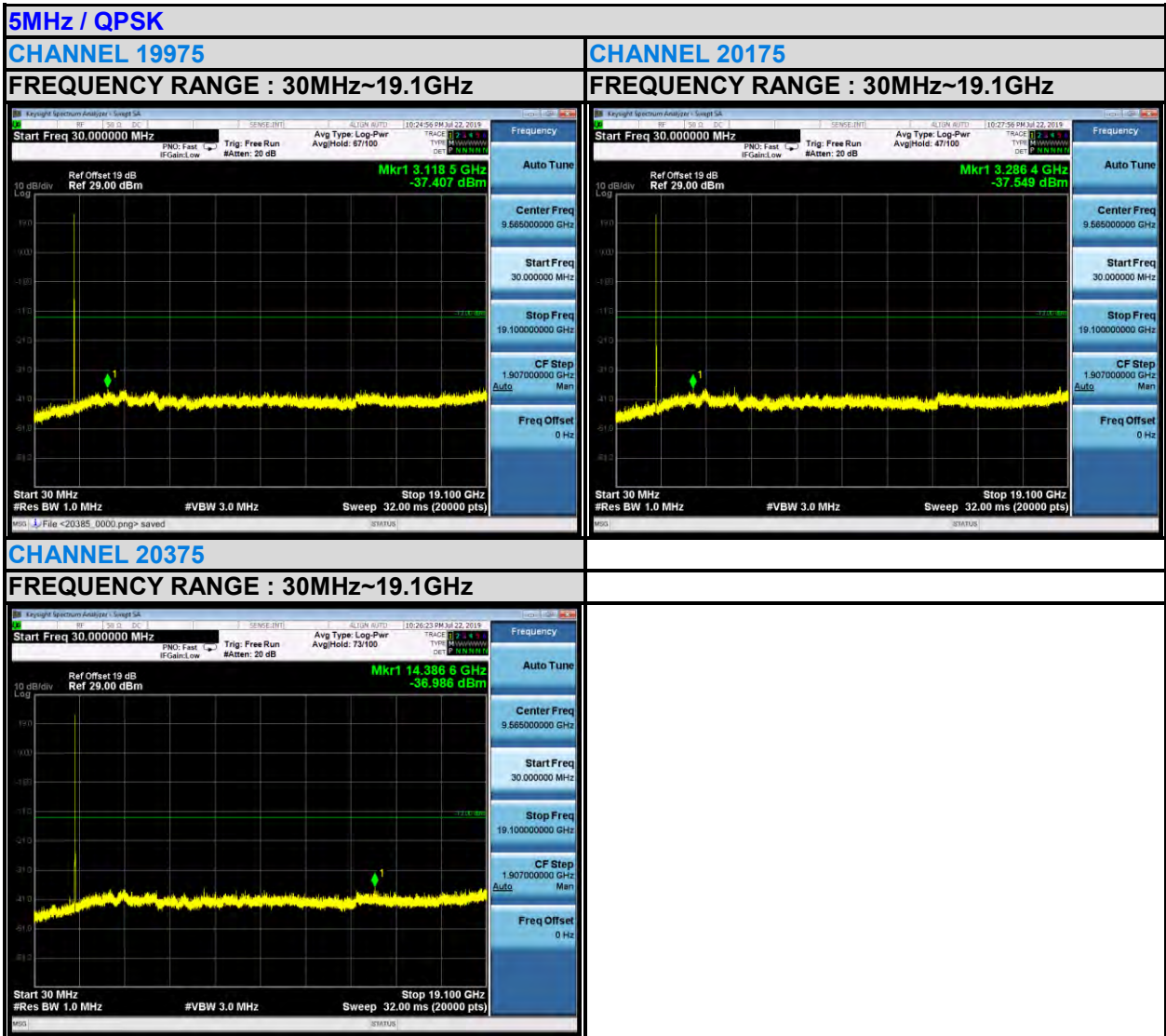



BUREAU VERITAS

Test Report No.: RF190712W002-5

10MHz / QPSK

CHANNEL 20000

FREQUENCY RANGE : 30MHz~19.1GHz

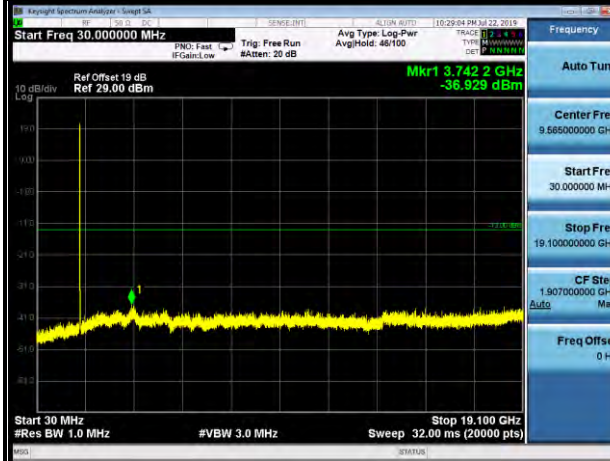

CHANNEL 20175

FREQUENCY RANGE : 30MHz~19.1GHz

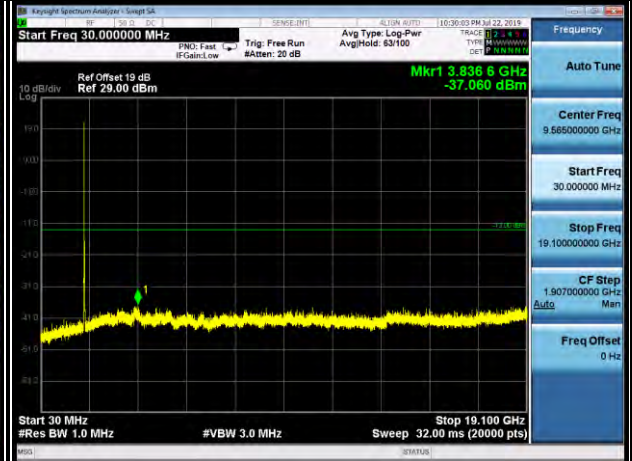

CHANNEL 20350

FREQUENCY RANGE : 30MHz~19.1GHz

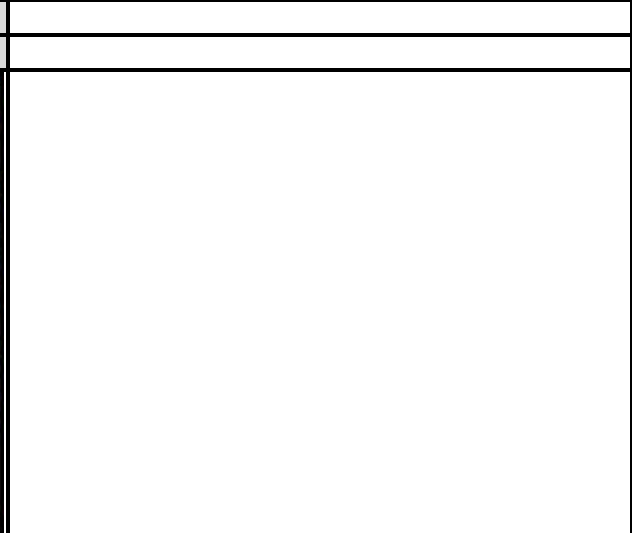
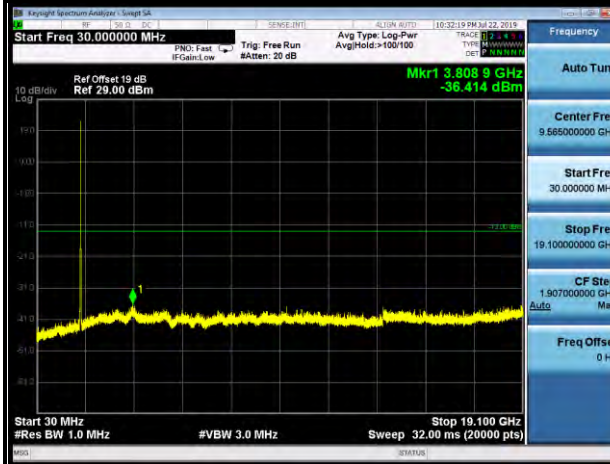



BUREAU VERITAS

Test Report No.: RF190712W002-5

15MHz / QPSK

CHANNEL 20025

FREQUENCY RANGE : 30MHz~19.1GHz

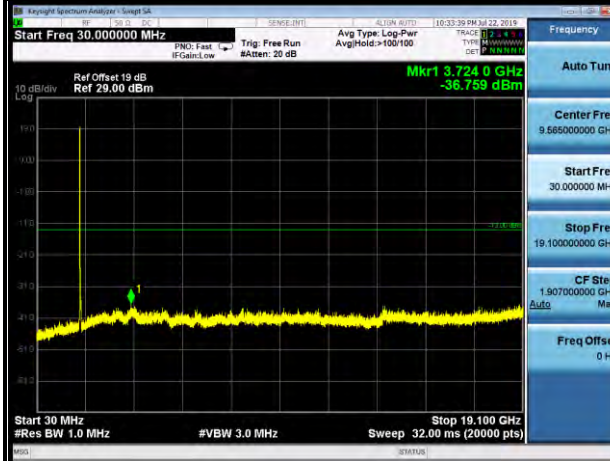

CHANNEL 20175

FREQUENCY RANGE : 30MHz~19.1GHz



CHANNEL 20325

FREQUENCY RANGE : 30MHz~19.1GHz

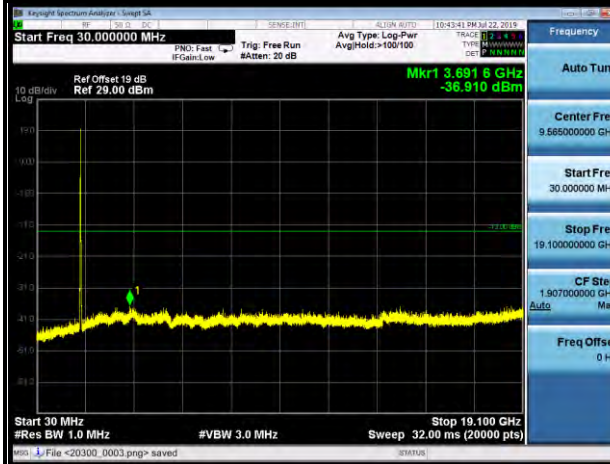



BUREAU VERITAS

Test Report No.: RF190712W002-5

20MHz / QPSK

CHANNEL 20050

FREQUENCY RANGE : 30MHz~19.1GHz

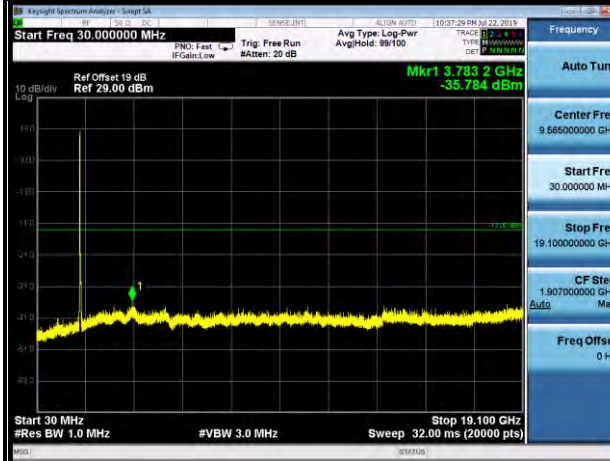

CHANNEL 20175

FREQUENCY RANGE : 30MHz~19.1GHz

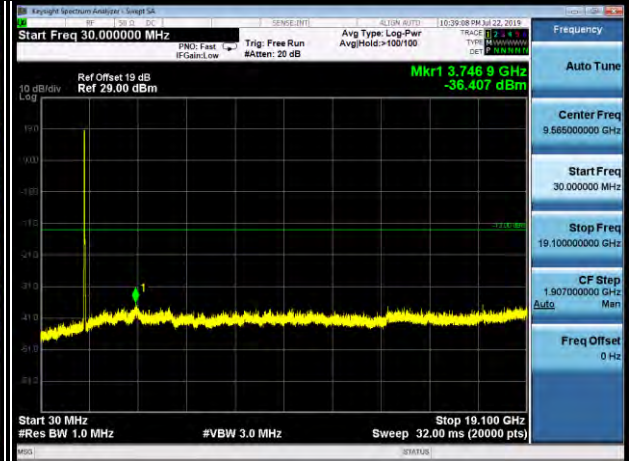

CHANNEL 20300

FREQUENCY RANGE : 30MHz~19.1GHz

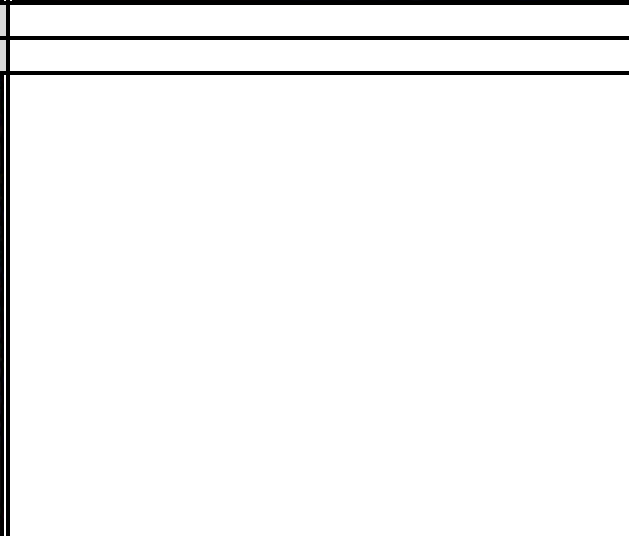
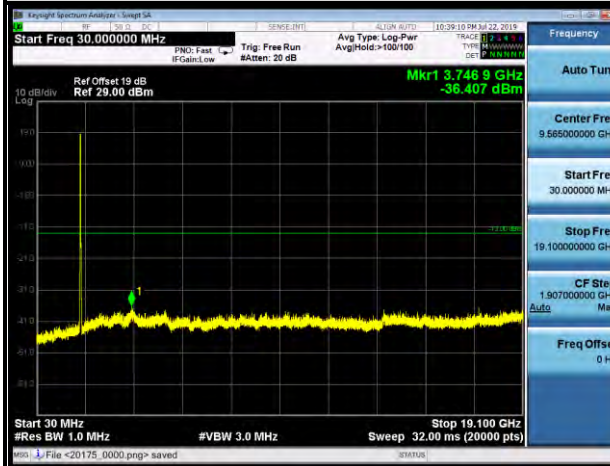



3.7 RADIATED EMISSION MEASUREMENT

3.7.1 LIMITS OF RADIATED EMISSION MEASUREMENT

The power of any emission outside a licensee's frequency block shall be attenuated below the transmitter power (P) by at least $43 + 10 \log_{10}(P)$ dB. The limit of emission equal to -13dBm

3.7.2 TEST PROCEDURES

- a. Substitution method is used for E.I.R.P measurement. In the semi-anechoic chamber, EUT placed on the 0.8m height of Turn Table, rotated the table around 360 degrees to search the maximum radiation power and receiver antenna shall be rotated vertical and horizontal polarization and moved height from 1m to 4m to find the maximum polar radiated power. The "Read Value" is the spectrum reading the maximum power value.
- b. The substitution horn antenna is substituted for EUT at the same position and signals generator export the CW signal to the substitution antenna via a TX cable. Rotated the Turn Table and moved receiving antenna to find the maximum radiation power. Adjust output power level of S.G to get a Value of spectrum reading equal to "Read Value" of step a. Record the power level of S.G
- c. $\text{EIRP} = \text{Output power level of S.G} - \text{TX cable loss} + \text{Antenna gain of substitution horn}$.
- d. E.R.P power can be calculated form E.I.R.P power by subtracting the gain of dipole, $\text{E.R.P power} = \text{E.I.P.R power} - 2.15\text{dBi}$.

NOTE: The resolution bandwidth of spectrum analyzer is 1 MHz and the video bandwidth is 3 MHz.

3.7.3 DEVIATION FROM TEST STANDARD

No deviation

3.7.4 TEST SETUP

< Frequency Range 30MHz~1GHz >

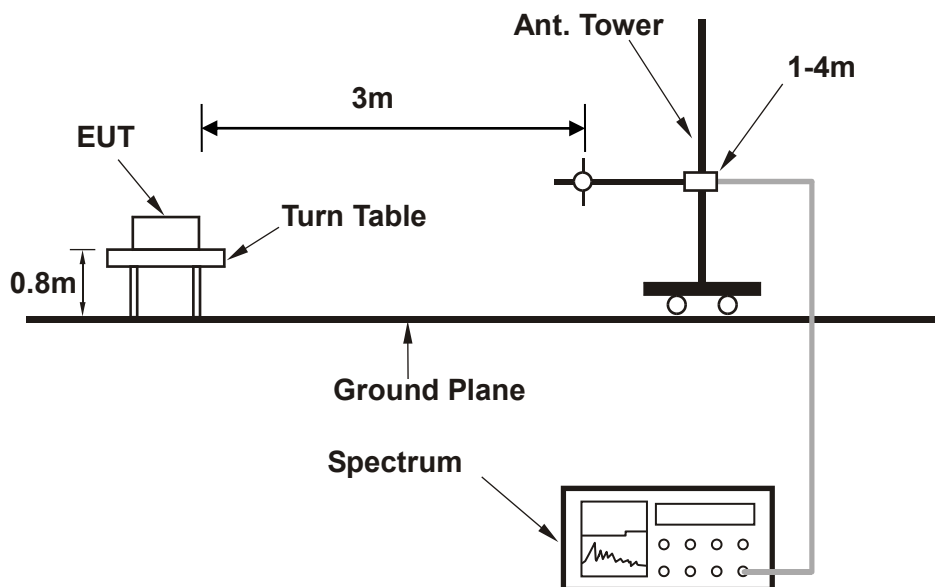

<Frequency Range above 1GHz>

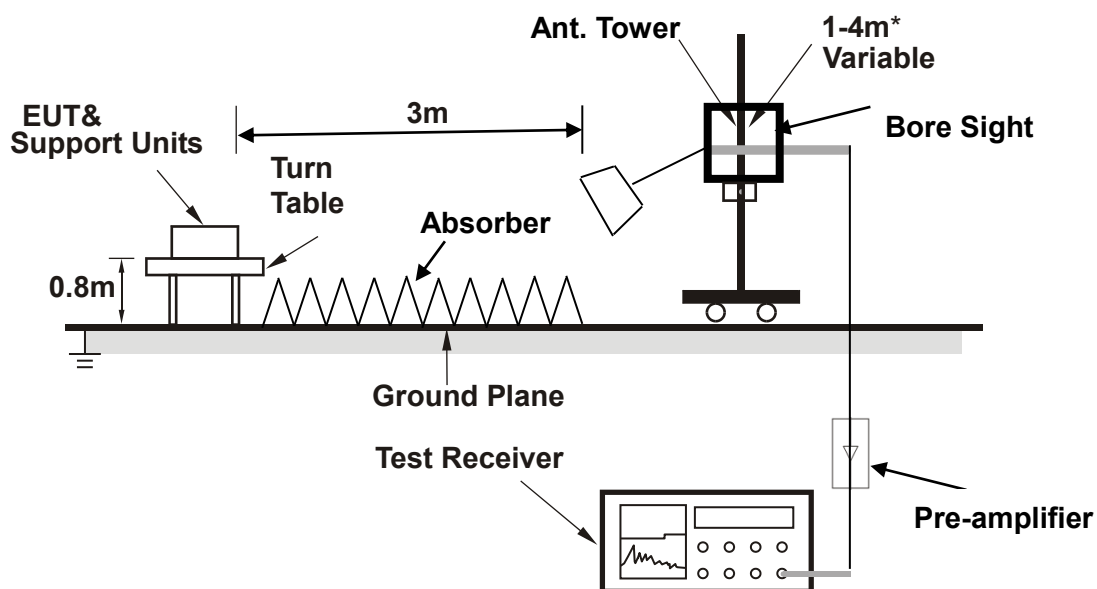

Note: Above 1G is a directional antenna

Depends on the EUT height and the antenna 3dB beamwidth both, refer to section 7.3 of CISPR 16-2-3.

For the actual test configuration, please refer to the attached file (Test Setup Photo).



3.7.5 TEST RESULTS

WWAN-ANT-0

BELOW 1GHz WORST-CASE DATA

30 MHz – 1GHz data:

LTE BAND 4

CHANNEL BANDWIDTH: 3MHz / QPSK

MODE	TX channel 20175	FREQUENCY RANGE	Below 1000MHz
ENVIRONMENTAL CONDITIONS	23deg. C, 70%RH	INPUT POWER	DC 5V/9V/12V from adapter
TESTED BY	Star Le		
ANTENNA POLARITY & TEST DISTANCE: HORIZONTAL AT 3 M			

	Freq	Level	Read Level	Limit Line	Over Limit	Factor	Remark	Pol/Phase
	MHz	dBm/m	dBm	dBm/m	dB	dB/m		
1	51.230	-33.04	-40.12	-13.00	-20.04	7.08	Peak	Horizontal
2	105.360	-45.94	-55.32	-13.00	-32.94	9.38	Peak	Horizontal
3	165.280	-34.77	-45.22	-13.00	-21.77	10.45	Peak	Horizontal
4	285.460	-38.67	-52.45	-13.00	-25.67	13.78	Peak	Horizontal
5	369.690	-39.86	-56.12	-13.00	-26.86	16.26	Peak	Horizontal
6	485.750	-44.04	-62.35	-13.00	-31.04	18.31	Peak	Horizontal

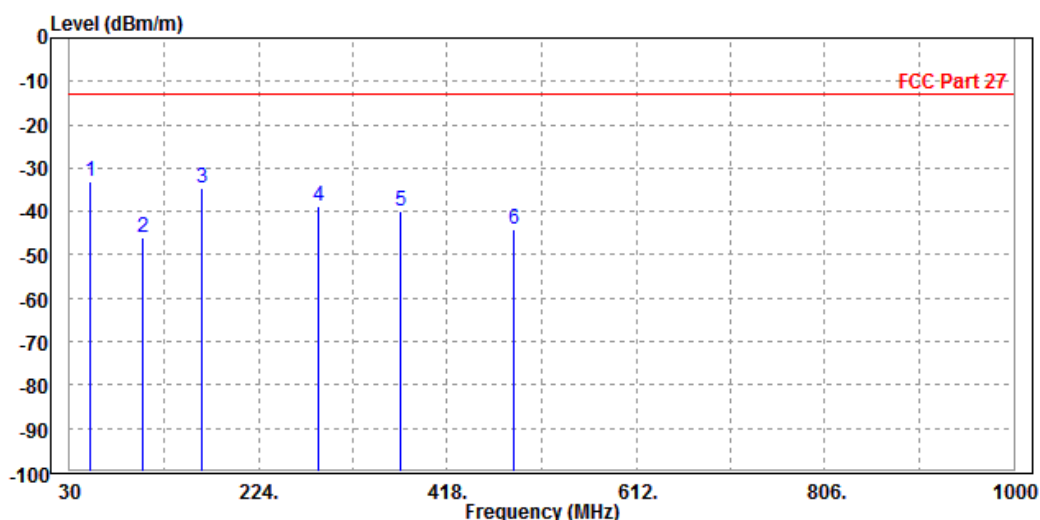



Test Report No.: RF190712W002-5

MODE	TX channel 20175	FREQUENCY RANGE	Below 1000MHz
ENVIRONMENTAL CONDITIONS	23deg. C, 70%RH	INPUT POWER	DC 5V/9V/12V from adapter
TESTED BY	Star Le		
ANTENNA POLARITY & TEST DISTANCE: VERTICAL AT 3 M			

	Freq	Level	Read Level	Limit Line	Over Limit	Factor	Remark	Pol/Phase
	MHz	dBm/m	dBm	dBm/m	dB	dB/m		
1	52.310	-30.16	-37.42	-13.00	-17.16	7.26	Peak	Vertical
2 PP	152.320	-26.00	-35.86	-13.00	-13.00	9.86	Peak	Vertical
3	186.450	-29.60	-40.13	-13.00	-16.60	10.53	Peak	Vertical
4	275.420	-37.31	-51.02	-13.00	-24.31	13.71	Peak	Vertical
5	355.240	-35.11	-51.02	-13.00	-22.11	15.91	Peak	Vertical
6	564.280	-35.76	-55.36	-13.00	-22.76	19.60	Peak	Vertical

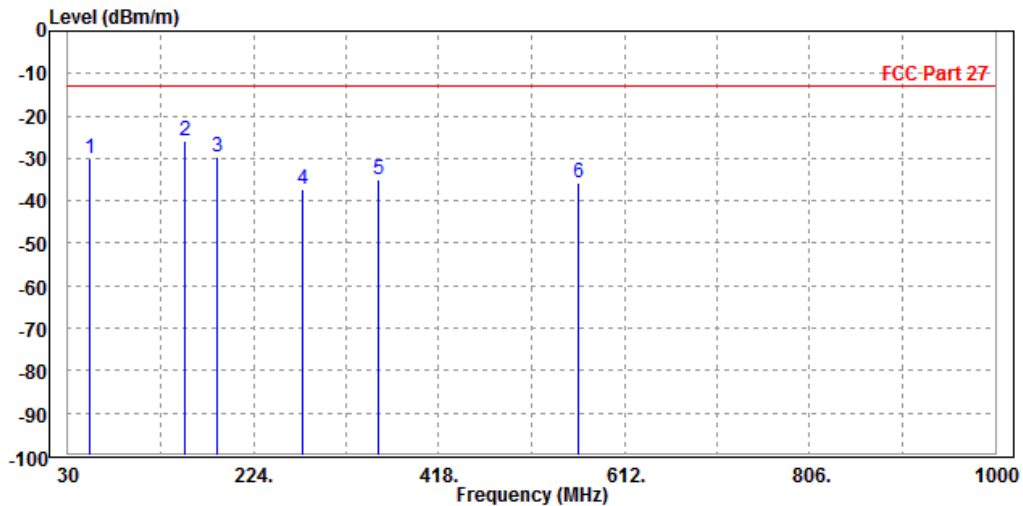



Test Report No.: RF190712W002-5

ABOVE 1GHz

Note: For higher frequency, the emission is too low to be detected.

WCDMA Band IV:

CH 1312

MODE	TX channel 1312	FREQUENCY RANGE	Above 1000MHz
ENVIRONMENTAL CONDITIONS	23deg. C, 70%RH	INPUT POWER	DC 5V/9V/12V from adapter
TESTED BY	Star Le		
ANTENNA POLARITY & TEST DISTANCE: HORIZONTAL AT 3 M			

	Freq	Level	Read Level	Limit Line	Over Limit	Factor	Remark	Pol/Phase
	MHz	dBm/m	dBm	dBm/m	dB	dB/m		
1	3418.000	-51.33	-53.18	-13.00	-38.33	1.85	Peak	Horizontal
2 PP	5137.000	-47.07	-55.61	-13.00	-34.07	8.54	Peak	Horizontal

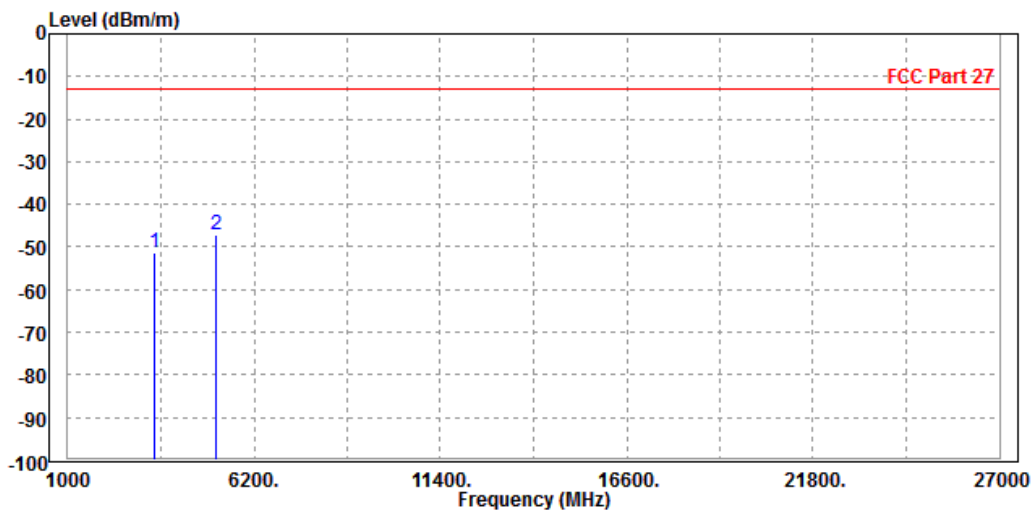



Test Report No.: RF190712W002-5

MODE	TX channel 1312	FREQUENCY RANGE	Above 1000MHz
ENVIRONMENTAL CONDITIONS	23deg. C, 70%RH	INPUT POWER	DC 5V/9V/12V from adapter
TESTED BY	Star Le		
ANTENNA POLARITY & TEST DISTANCE: VERTICAL AT 3 M			

	Freq	Level	Read Level	Limit Line	Over Limit	Factor	Remark	Pol/Phase
	MHz	dBm/m	dBm	dBm/m	dB	dB/m		
1	3418.000	-50.01	-52.48	-13.00	-37.01	2.47	Peak	Vertical
2 PP	5137.000	-48.44	-56.43	-13.00	-35.44	7.99	Peak	Vertical

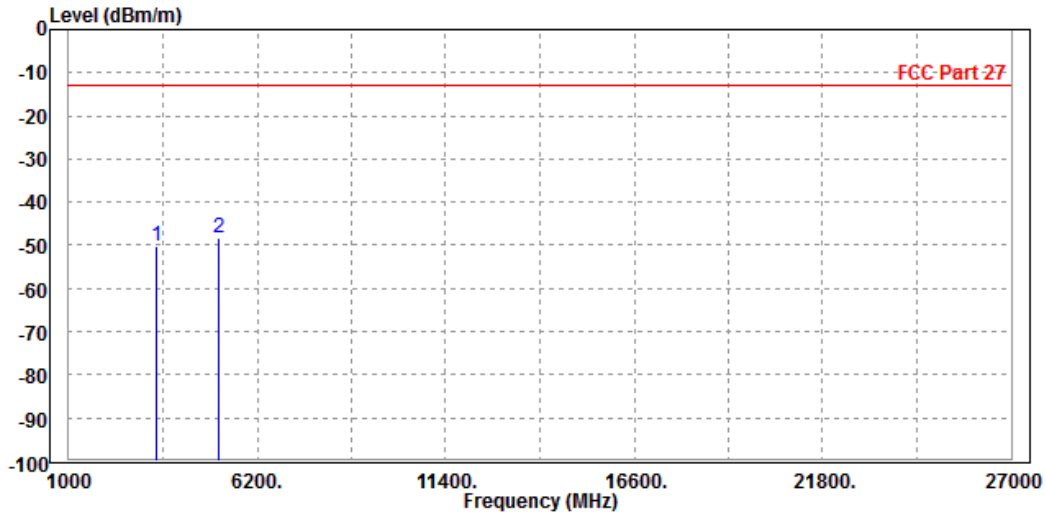



**BUREAU
VERITAS**

Test Report No.: RF190712W002-5

CH 1413

MODE	TX channel 1413	FREQUENCY RANGE	Above 1000MHz
ENVIRONMENTAL CONDITIONS	23deg. C, 70%RH	INPUT POWER	DC 5V/9V/12V from adapter
TESTED BY	Star Le		
ANTENNA POLARITY & TEST DISTANCE: HORIZONTAL AT 3 M			

	Freq	Level	Read Level	Limit Line	Over Limit	Factor	Remark	Pol/Phase
	MHz	dBm/m	dBm	dBm/m	dB	dB/m		
1	3470.000	-49.18	-51.23	-13.00	-36.18	2.05	Peak	Horizontal
2 PP	5197.000	-47.03	-55.64	-13.00	-34.03	8.61	Peak	Horizontal

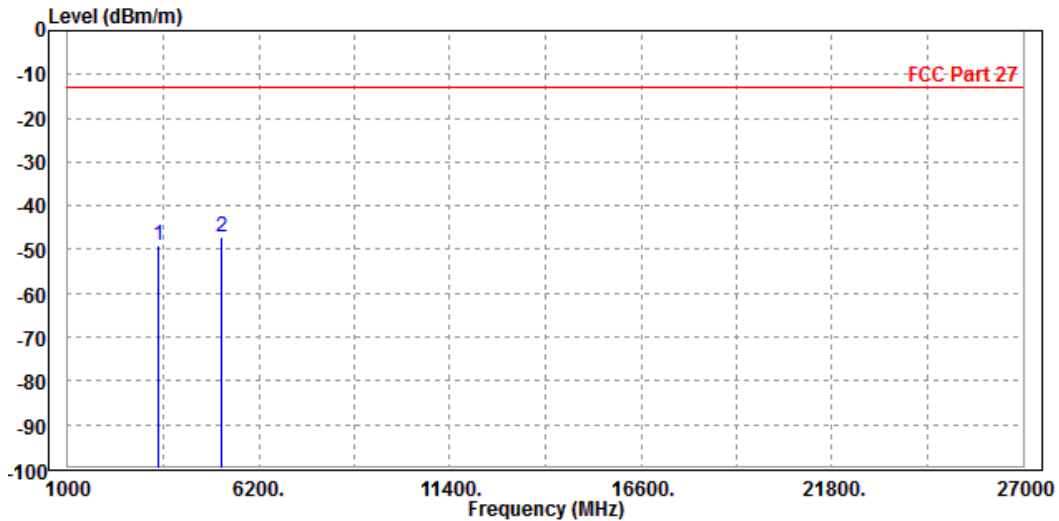



Test Report No.: RF190712W002-5

MODE	TX channel 1413	FREQUENCY RANGE	Above 1000MHz
ENVIRONMENTAL CONDITIONS	23deg. C, 70%RH	INPUT POWER	DC 5V/9V/12V from adapter
TESTED BY	Star Le		
ANTENNA POLARITY & TEST DISTANCE: VERTICAL AT 3 M			

	Freq	Level	Read Level	Limit Line	Over Limit	Factor	Remark	Pol/Phase
	MHz	dBm/m	dBm	dBm/m	dB	dB/m		
1	3470.000	-49.78	-52.31	-13.00	-36.78	2.53	Peak	Vertical
2 PP	5197.000	-46.87	-54.85	-13.00	-33.87	7.98	Peak	Vertical

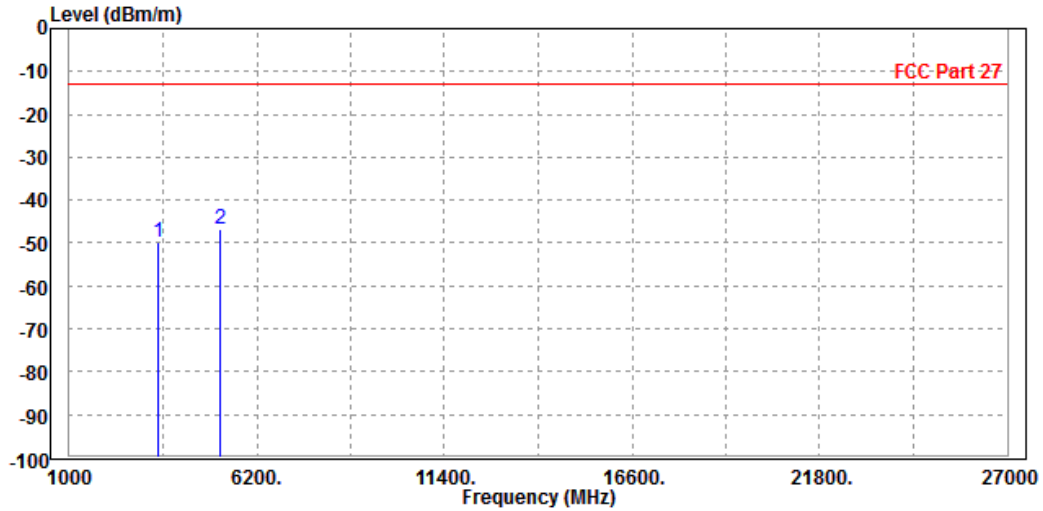



**BUREAU
VERITAS**

Test Report No.: RF190712W002-5

CH 1513

MODE	TX channel 1513	FREQUENCY RANGE	Above 1000MHz
ENVIRONMENTAL CONDITIONS	23deg. C, 70%RH	INPUT POWER	DC 5V/9V/12V from adapter
TESTED BY	Star Le		
ANTENNA POLARITY & TEST DISTANCE: HORIZONTAL AT 3 M			

	Freq	Level	Read Level	Limit Line	Over Limit	Factor	Remark	Pol/Phase
	MHz	dBm/m	dBm	dBm/m	dB	dB/m		
1	3505.000	-50.97	-53.16	-13.00	-37.97	2.19	Peak	Horizontal
2 PP	5257.000	-47.60	-56.28	-13.00	-34.60	8.68	Peak	Horizontal

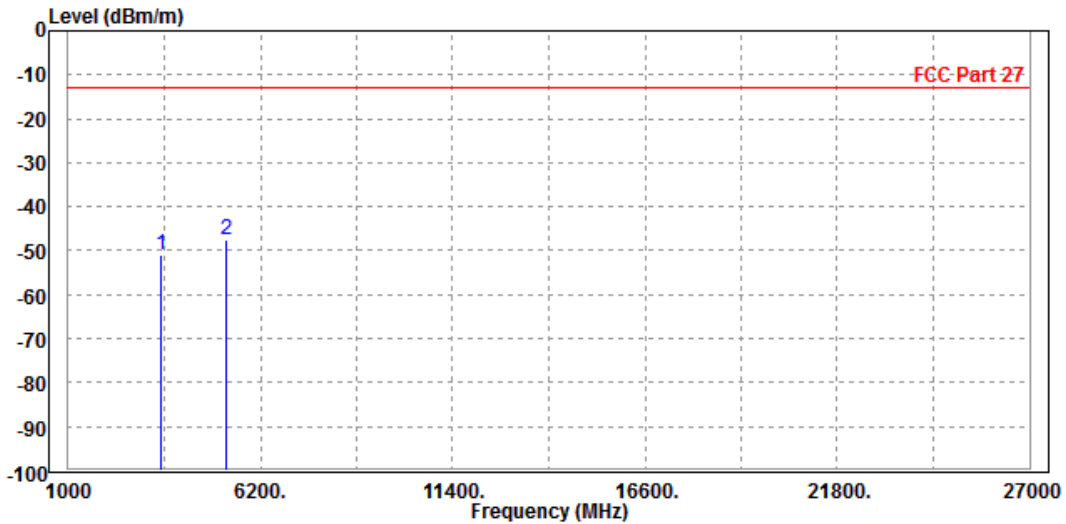



Test Report No.: RF190712W002-5

MODE	TX channel 1513	FREQUENCY RANGE	Above 1000MHz
ENVIRONMENTAL CONDITIONS	23deg. C, 70%RH	INPUT POWER	DC 5V/9V/12V from adapter
TESTED BY	Star Le		
ANTENNA POLARITY & TEST DISTANCE: VERTICAL AT 3 M			

	Freq	Level	Read Level	Limit Line	Over Limit	Factor	Remark	Pol/Phase
	MHz	dBm/m	dBm	dBm/m	dB	dB/m		
1	3505.000	-50.08	-52.68	-13.00	-37.08	2.60	Peak	Vertical
2 PP	5257.000	-48.50	-56.48	-13.00	-35.50	7.98	Peak	Vertical

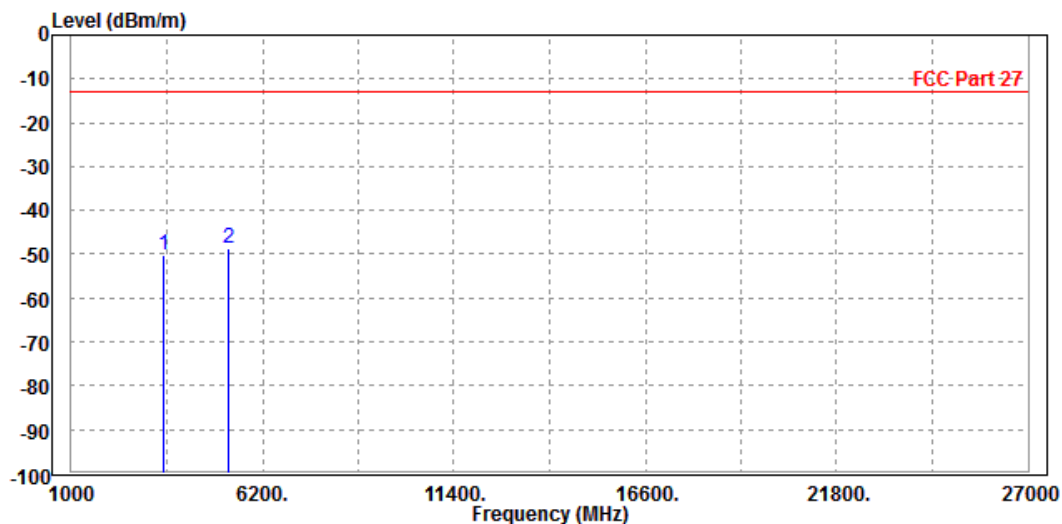



Test Report No.: RF190712W002-5

LTE BAND 4

CHANNEL BANDWIDTH: 1.4MHz / QPSK

MODE	TX channel 20175	FREQUENCY RANGE	Above 1000MHz
ENVIRONMENTAL CONDITIONS	23deg. C, 70%RH	INPUT POWER	DC 5V/9V/12V from adapter
TESTED BY	Star Le		
ANTENNA POLARITY & TEST DISTANCE: HORIZONTAL AT 3 M			

	Freq	Level	Read Level	Limit Line	Over Limit	Factor	Remark	Pol/Phase
	MHz	dBm/m	dBm	dBm/m	dB	dB/m		
1	3470.000	-50.63	-52.68	-13.00	-37.63	2.05	Peak	Horizontal
2 PP	5197.000	-48.51	-57.12	-13.00	-35.51	8.61	Peak	Horizontal

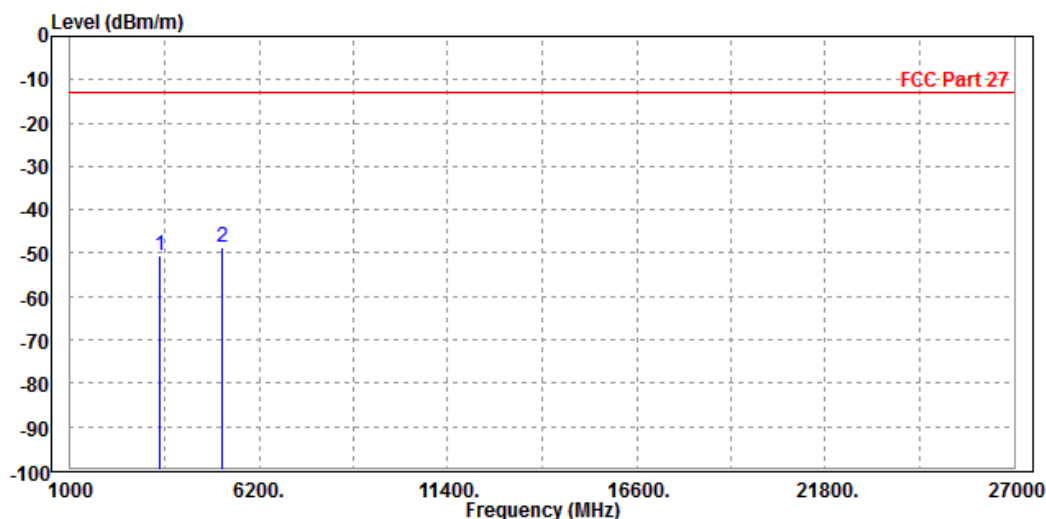



Test Report No.: RF190712W002-5

MODE	TX channel 20175	FREQUENCY RANGE	Above 1000MHz
ENVIRONMENTAL CONDITIONS	23deg. C, 70%RH	INPUT POWER	DC 5V/9V/12V from adapter
TESTED BY	Star Le		
ANTENNA POLARITY & TEST DISTANCE: VERTICAL AT 3 M			

	Freq	Level	Read Level	Limit Line	Over Limit	Factor	Remark	Pol/Phase
	MHz	dBm/m	dBm	dBm/m	dB	dB/m		
1	3470.000	-49.78	-52.31	-13.00	-36.78	2.53	Peak	Vertical
2 PP	5197.000	-48.45	-56.43	-13.00	-35.45	7.98	Peak	Vertical

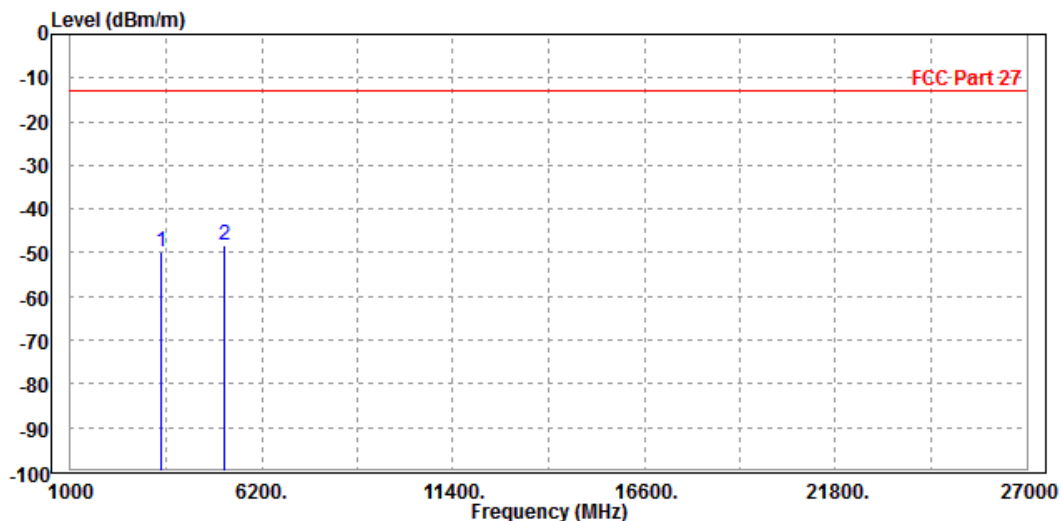



Test Report No.: RF190712W002-5

CHANNEL BANDWIDTH: 3MHz / QPSK

CH 19965

MODE	TX channel 19965	FREQUENCY RANGE	Above 1000MHz
ENVIRONMENTAL CONDITIONS	23deg. C, 70%RH	INPUT POWER	DC 5V/9V/12V from adapter
TESTED BY	Star Le		
ANTENNA POLARITY & TEST DISTANCE: HORIZONTAL AT 3 M			

	Freq	Level	Read Level	Limit	Over Limit	Factor	Remark	Pol/Phase
	MHz	dBm/m	dBm	dBm/m	dB	dB/m		
1	3418.000	-50.83	-52.68	-13.00	-37.83	1.85	Peak	Horizontal
2 PP	5132.000	-47.90	-56.43	-13.00	-34.90	8.53	Peak	Horizontal

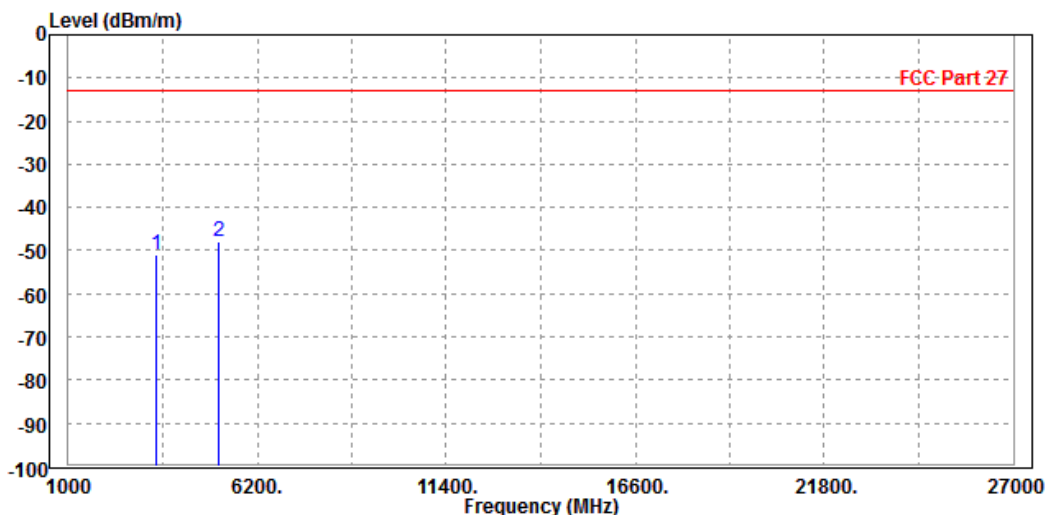



Test Report No.: RF190712W002-5

MODE	TX channel 19965	FREQUENCY RANGE	Above 1000MHz
ENVIRONMENTAL CONDITIONS	23deg. C, 70%RH	INPUT POWER	DC 5V/9V/12V from adapter
TESTED BY	Star Le		
ANTENNA POLARITY & TEST DISTANCE: VERTICAL AT 3 M			

	Freq	Level	Read Level	Limit Line	Over Limit	Factor	Remark	Pol/Phase
	MHz	dBm/m	dBm	dBm/m	dB	dB/m		
1	3418.000	-50.76	-53.23	-13.00	-37.76	2.47	Peak	Vertical
2 PP	5132.000	-49.15	-57.14	-13.00	-36.15	7.99	Peak	Vertical

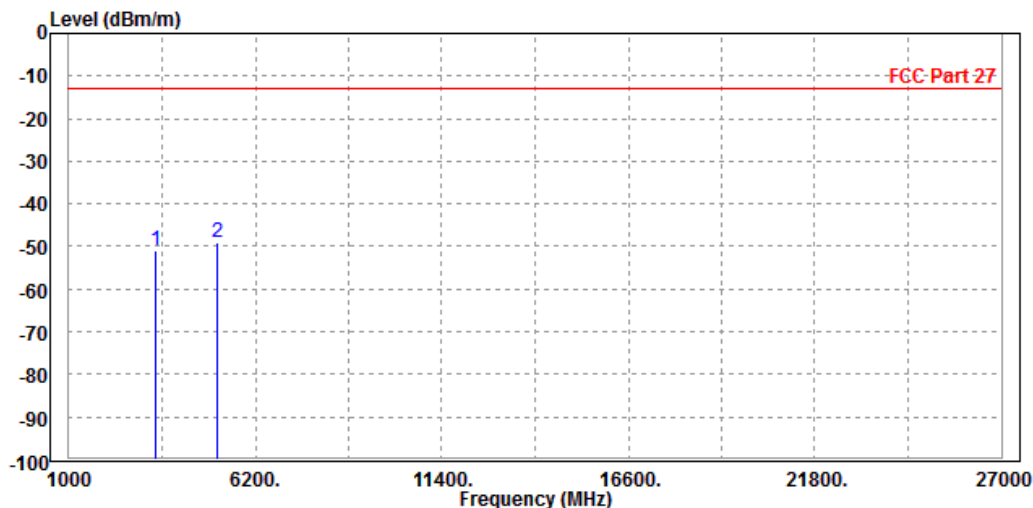



Test Report No.: RF190712W002-5

CH 20175

MODE	TX channel 20175	FREQUENCY RANGE	Above 1000MHz
ENVIRONMENTAL CONDITIONS	23deg. C, 70%RH	INPUT POWER	DC 5V/9V/12V from adapter
TESTED BY	Star Le		
ANTENNA POLARITY & TEST DISTANCE: HORIZONTAL AT 3 M			

	Freq	Level	Read Level	Limit Line	Over Limit	Factor	Remark	Pol/Phase
	MHz	dBm/m	dBm	dBm/m	dB	dB/m		
1	3470.000	-48.84	-50.89	-13.00	-35.84	2.05	Peak	Horizontal
2 PP	5197.000	-45.14	-53.75	-13.00	-32.14	8.61	Peak	Horizontal

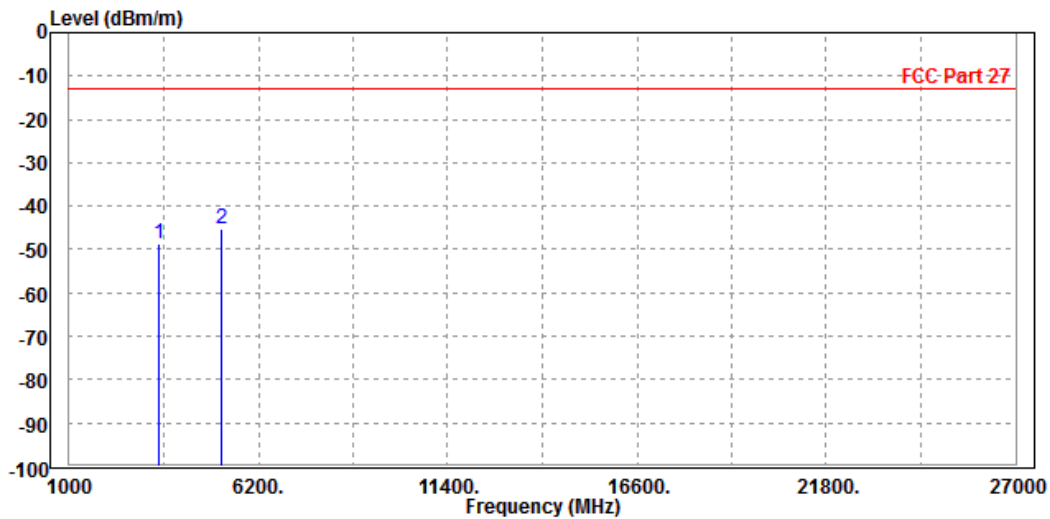



Test Report No.: RF190712W002-5

MODE	TX channel 20175	FREQUENCY RANGE	Above 1000MHz
ENVIRONMENTAL CONDITIONS	23deg. C, 70%RH	INPUT POWER	DC 5V/9V/12V from adapter
TESTED BY	Star Le		
ANTENNA POLARITY & TEST DISTANCE: VERTICAL AT 3 M			

	Freq	Level	Read Level	Limit Line	Over Limit	Factor	Remark	Pol/Phase
	MHz	dBm/m	dBm	dBm/m	dB	dB/m		
1	3470.000	-47.88	-50.41	-13.00	-34.88	2.53	Peak	Vertical
2 PP	5197.000	-46.86	-54.84	-13.00	-33.86	7.98	Peak	Vertical

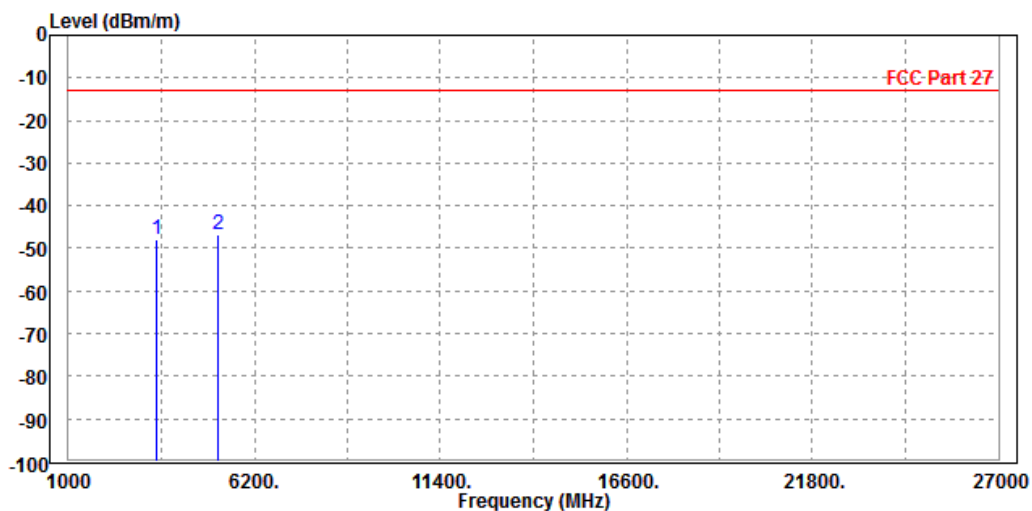



Test Report No.: RF190712W002-5

CH 20385

MODE	TX channel 20385	FREQUENCY RANGE	Above 1000MHz
ENVIRONMENTAL CONDITIONS	23deg. C, 70%RH	INPUT POWER	DC 5V/9V/12V from adapter
TESTED BY	Star Le		
ANTENNA POLARITY & TEST DISTANCE: HORIZONTAL AT 3 M			

	Freq	Level	Read Level	Limit Line	Over Limit	Factor	Remark	Pol/Phase
	MHz	dBm/m	dBm	dBm/m	dB	dB/m		
1	3502.000	-50.19	-52.36	-13.00	-37.19	2.17	Peak	Horizontal
2 PP	5266.000	-47.42	-56.11	-13.00	-34.42	8.69	Peak	Horizontal

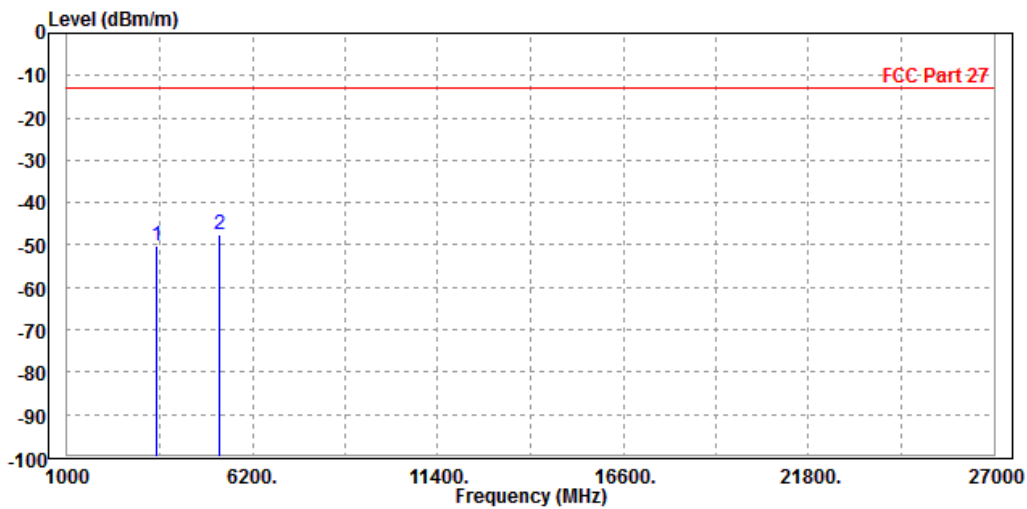



Test Report No.: RF190712W002-5

MODE	TX channel 20385	FREQUENCY RANGE	Above 1000MHz
ENVIRONMENTAL CONDITIONS	23deg. C, 70%RH	INPUT POWER	DC 5V/9V/12V from adapter
TESTED BY	Star Le		
ANTENNA POLARITY & TEST DISTANCE: VERTICAL AT 3 M			

	Freq	Level	Read Level	Limit Line	Over Limit	Factor	Remark	Pol/Phase
	MHz	dBm/m	dBm	dBm/m	dB	dB/m		
1	3502.000	-50.64	-53.22	-13.00	-37.64	2.58	Peak	Vertical
2 PP	5266.000	-47.41	-55.39	-13.00	-34.41	7.98	Peak	Vertical

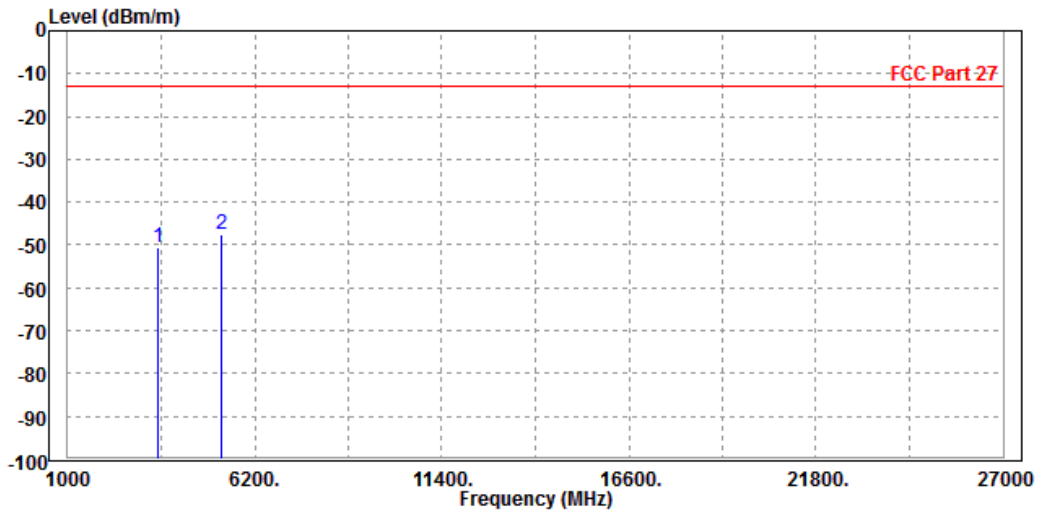



BUREAU VERITAS

Test Report No.: RF190712W002-5

CHANNEL BANDWIDTH: 5MHz / QPSK

MODE	TX channel 20175	FREQUENCY RANGE	Above 1000MHz
ENVIRONMENTAL CONDITIONS	23deg. C, 70%RH	INPUT POWER	DC 5V/9V/12V from adapter
TESTED BY	Star Le		
ANTENNA POLARITY & TEST DISTANCE: HORIZONTAL AT 3 M			

	Freq	Level	Read Level	Limit Line	Over Limit	Factor	Remark	Pol/Phase
	MHz	dBm/m	dBm	dBm/m	dB	dB/m		
1	3470.000	-51.21	-53.26	-13.00	-38.21	2.05	Peak	Horizontal
2 PP	5197.000	-47.81	-56.42	-13.00	-34.81	8.61	Peak	Horizontal

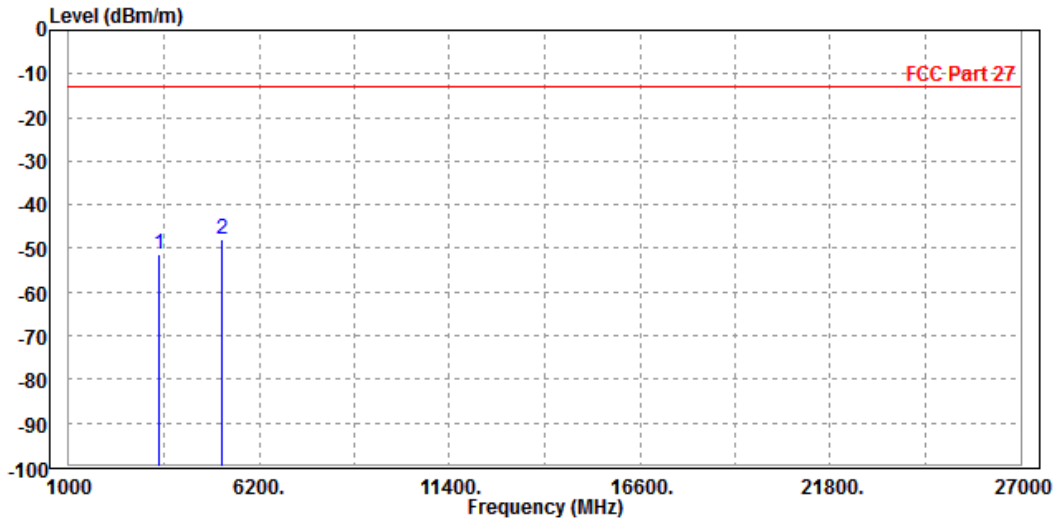



Test Report No.: RF190712W002-5

MODE	TX channel 20175	FREQUENCY RANGE	Above 1000MHz
ENVIRONMENTAL CONDITIONS	23deg. C, 70%RH	INPUT POWER	DC 5V/9V/12V from adapter
TESTED BY	Star Le		
ANTENNA POLARITY & TEST DISTANCE: VERTICAL AT 3 M			

	Freq	Level	Read Level	Limit Line	Over Limit	Factor	Remark	Pol/Phase
	MHz	dBm/m	dBm	dBm/m	dB	dB/m		
1	3470.000	-50.63	-53.16	-13.00	-37.63	2.53	Peak	Vertical
2 PP	5197.000	-48.47	-56.45	-13.00	-35.47	7.98	Peak	Vertical

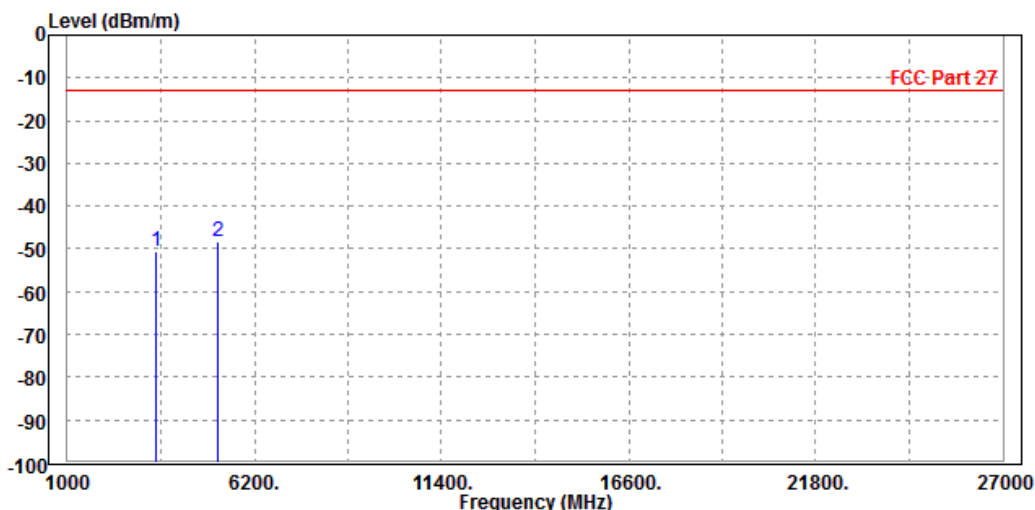



**BUREAU
VERITAS**

Test Report No.: RF190712W002-5

CHANNEL BANDWIDTH: 10MHz / QPSK

MODE	TX channel 20175	FREQUENCY RANGE	Above 1000MHz
ENVIRONMENTAL CONDITIONS	23deg. C, 70%RH	INPUT POWER	DC 5V/9V/12V from adapter
TESTED BY	Star Le		
ANTENNA POLARITY & TEST DISTANCE: HORIZONTAL AT 3 M			

	Freq	Level	Read Level	Limit Line	Over Limit	Factor	Remark	Pol/Phase
	MHz	dBm/m	dBm	dBm/m	dB	dB/m		
1	3470.000	-49.17	-51.22	-13.00	-36.17	2.05	Peak	Horizontal
2 PP	5197.000	-46.00	-54.61	-13.00	-33.00	8.61	Peak	Horizontal

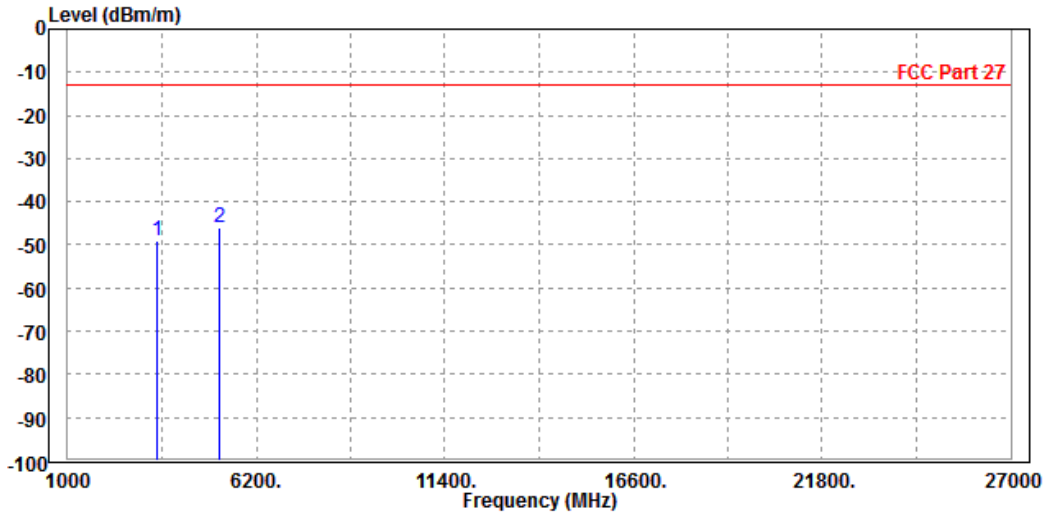



Test Report No.: RF190712W002-5

MODE	TX channel 20175	FREQUENCY RANGE	Above 1000MHz
ENVIRONMENTAL CONDITIONS	23deg. C, 70%RH	INPUT POWER	DC 5V/9V/12V from adapter
TESTED BY	Star Le		
ANTENNA POLARITY & TEST DISTANCE: VERTICAL AT 3 M			

	Freq	Level	Read Level	Limit Line	Over Limit	Factor	Remark	Pol/Phase
	MHz	dBm/m	dBm	dBm/m	dB	dB/m		
1	3470.000	-48.83	-51.36	-13.00	-35.83	2.53	Peak	Vertical
2 PP	5197.000	-47.23	-55.21	-13.00	-34.23	7.98	Peak	Vertical

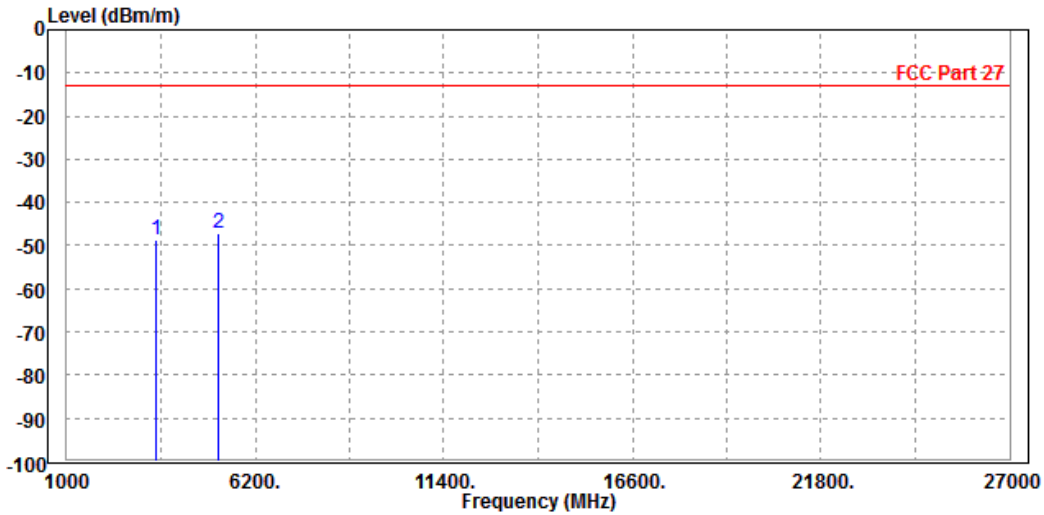



**BUREAU
VERITAS**

Test Report No.: RF190712W002-5

CHANNEL BANDWIDTH: 15MHz / QPSK

MODE	TX channel 20175	FREQUENCY RANGE	Above 1000MHz
ENVIRONMENTAL CONDITIONS	23deg. C, 70%RH	INPUT POWER	DC 5V/9V/12V from adapter
TESTED BY	Star Le		
ANTENNA POLARITY & TEST DISTANCE: HORIZONTAL AT 3 M			

	Freq	Level	Read Level	Limit Line	Over Limit	Factor	Remark	Pol/Phase
	MHz	dBm/m	dBm	dBm/m	dB	dB/m		
1	3470.000	-50.81	-52.86	-13.00	-37.81	2.05	Peak	Horizontal
2	PP 5197.000	-47.80	-56.41	-13.00	-34.80	8.61	Peak	Horizontal

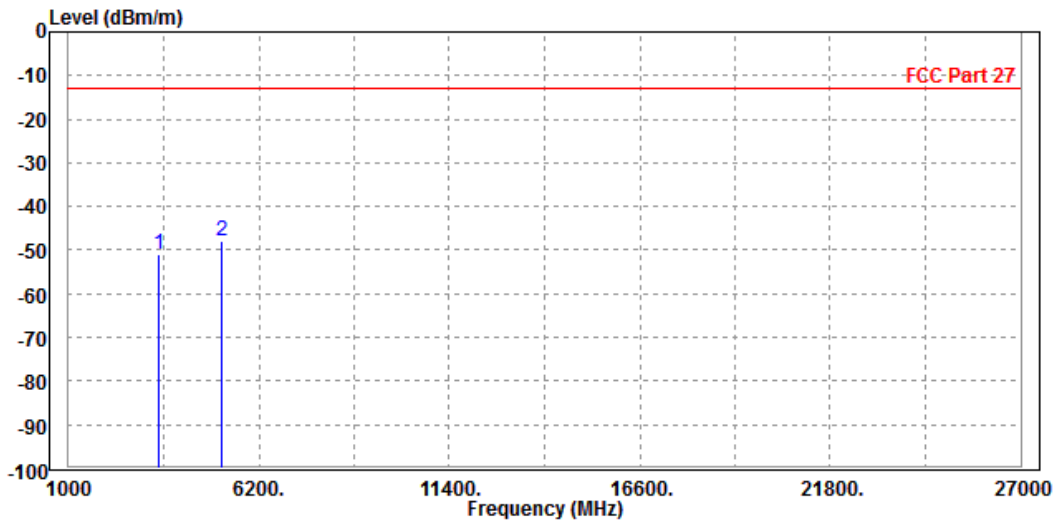



Test Report No.: RF190712W002-5

MODE	TX channel 20175	FREQUENCY RANGE	Above 1000MHz
ENVIRONMENTAL CONDITIONS	23deg. C, 70%RH	INPUT POWER	DC 5V/9V/12V from adapter
TESTED BY	Star Le		
ANTENNA POLARITY & TEST DISTANCE: VERTICAL AT 3 M			

	Freq	Level	Read Level	Limit Line	Over Limit	Factor	Remark	Pol/Phase
	MHz	dBm/m	dBm	dBm/m	dB	dB/m		
1	3470.000	-50.73	-53.26	-13.00	-37.73	2.53	Peak	Vertical
2 PP	5197.000	-49.23	-57.21	-13.00	-36.23	7.98	Peak	Vertical

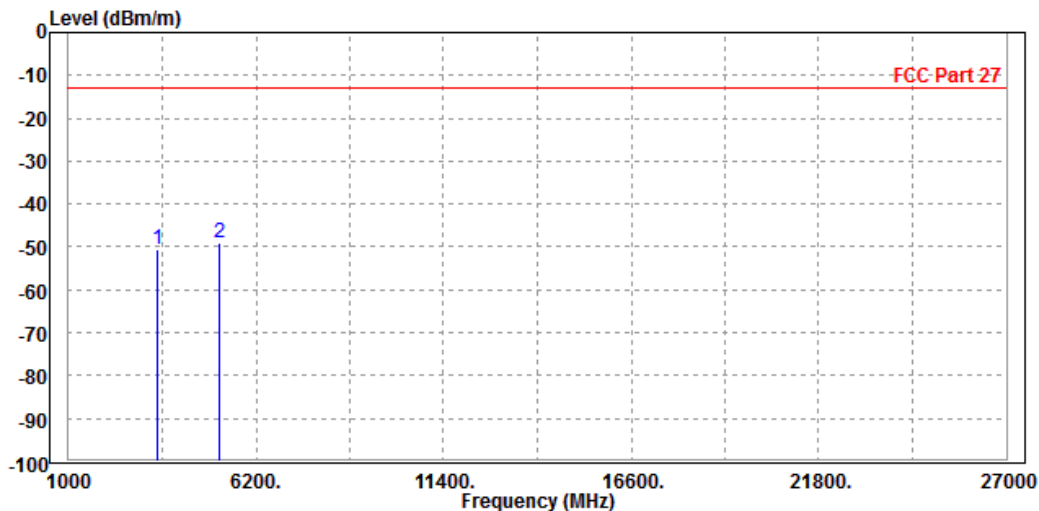



Test Report No.: RF190712W002-5

CHANNEL BANDWIDTH: 20MHz / QPSK

MODE	TX channel 20175	FREQUENCY RANGE	Above 1000MHz
ENVIRONMENTAL CONDITIONS	23deg. C, 70%RH	INPUT POWER	DC 5V/9V/12V from adapter
TESTED BY	Star Le		
ANTENNA POLARITY & TEST DISTANCE: HORIZONTAL AT 3 M			

	Freq	Level	Read Level	Limit Line	Over Limit	Factor	Remark	Pol/Phase
	MHz	dBm/m	dBm	dBm/m	dB	dB/m		
1	3470.000	-50.29	-52.34	-13.00	-37.29	2.05	Peak	Horizontal
2	5197.000	-48.67	-57.28	-13.00	-35.67	8.61	Peak	Horizontal

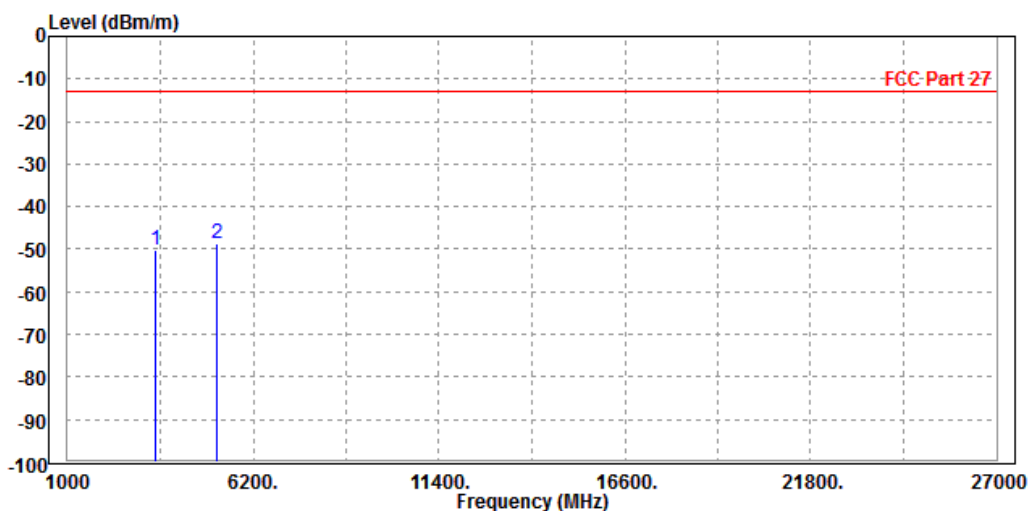



Test Report No.: RF190712W002-5

MODE	TX channel 20175	FREQUENCY RANGE	Above 1000MHz
ENVIRONMENTAL CONDITIONS	23deg. C, 70%RH	INPUT POWER	DC 5V/9V/12V from adapter
TESTED BY	Star Le		
ANTENNA POLARITY & TEST DISTANCE: VERTICAL AT 3 M			

	Freq	Level	Read Level	Limit Line	Over Limit	Factor	Remark	Pol/Phase
	MHz	dBm/m	dBm	dBm/m	dB	dB/m		
1	3470.000	-50.73	-53.26	-13.00	-37.73	2.53	Peak	Vertical
2 PP	5197.000	-48.77	-56.75	-13.00	-35.77	7.98	Peak	Vertical

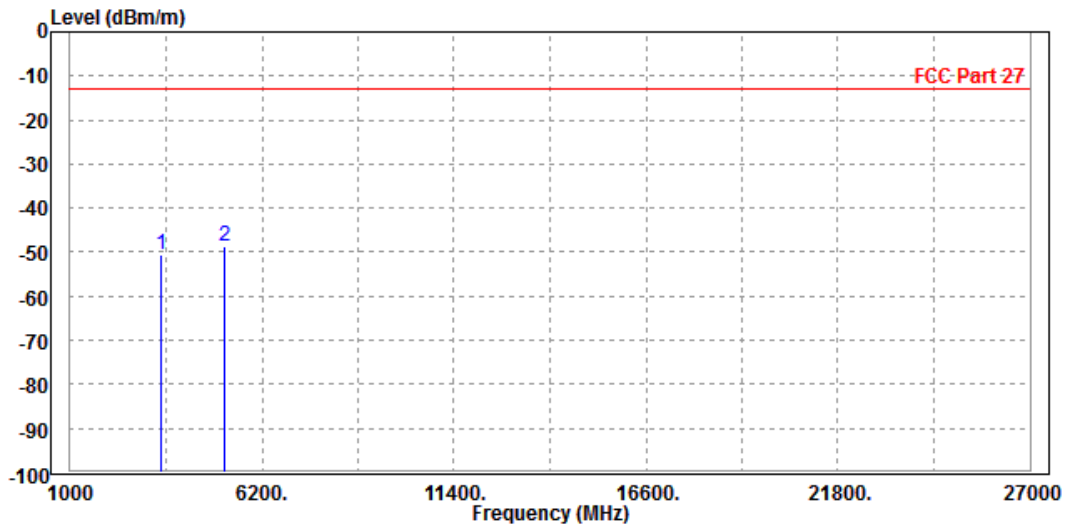



Test Report No.: RF190712W002-5

WWAN-ANT-1

BELOW 1GHz WORST-CASE DATA

30 MHz – 1GHz data:

LTE BAND 4

CHANNEL BANDWIDTH: 3MHz / QPSK

MODE	TX channel 20175	FREQUENCY RANGE	Below 1000MHz
ENVIRONMENTAL CONDITIONS	23deg. C, 70%RH	INPUT POWER	DC 5V/9V/12V from adapter
TESTED BY	Star Le		
ANTENNA POLARITY & TEST DISTANCE: HORIZONTAL AT 3 M			

	Freq	Level	Read Level	Limit Line	Over Limit	Factor	Remark	Pol/Phase
	MHz	dBm/m	dBm	dBm/m	dB	dB/m		
1	45.320	-35.04	-42.51	-13.00	-22.04	7.47	Peak	Horizontal
2	101.250	-55.57	-65.19	-13.00	-42.57	9.62	Peak	Horizontal
3 PP	158.640	-31.92	-42.31	-13.00	-18.92	10.39	Peak	Horizontal
4	255.360	-50.13	-63.25	-13.00	-37.13	13.12	Peak	Horizontal
5	358.690	-43.71	-59.63	-13.00	-30.71	15.92	Peak	Horizontal
6	452.320	-53.33	-71.21	-13.00	-40.33	17.88	Peak	Horizontal

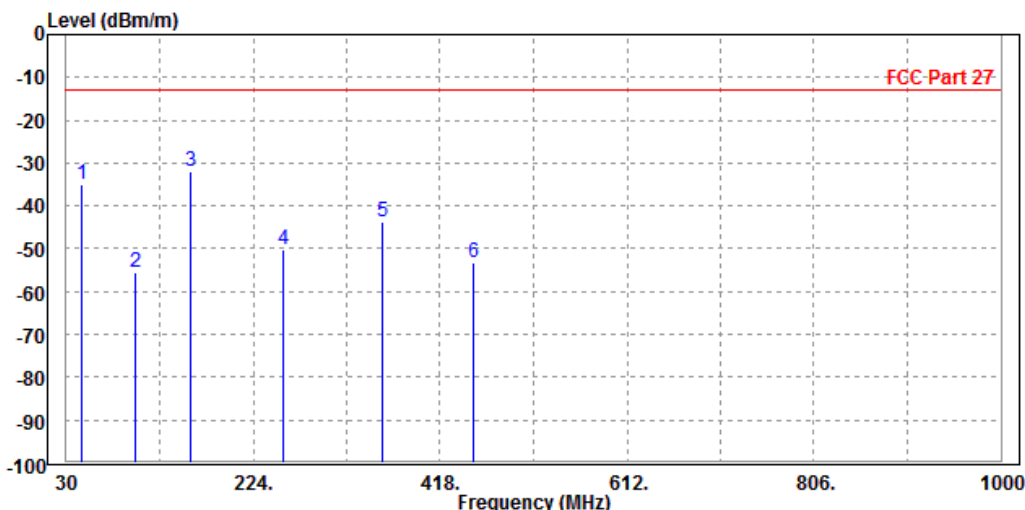



Test Report No.: RF190712W002-5

MODE	TX channel 20175	FREQUENCY RANGE	Below 1000MHz
ENVIRONMENTAL CONDITIONS	23deg. C, 70%RH	INPUT POWER	DC 5V/9V/12V from adapter
TESTED BY	Star Le		
ANTENNA POLARITY & TEST DISTANCE: VERTICAL AT 3 M			

	Freq	Level	Read Level	Limit Line	Over Limit	Factor	Remark	Pol/Phase
	MHz	dBm/m	dBm	dBm/m	dB	dB/m		
1	PP 45.230	-28.93	-36.52	-13.00	-15.93	7.59	Peak	Vertical
2	115.230	-32.06	-41.02	-13.00	-19.06	8.96	Peak	Vertical
3	156.980	-32.32	-42.51	-13.00	-19.32	10.19	Peak	Vertical
4	255.480	-43.11	-56.42	-13.00	-30.11	13.31	Peak	Vertical
5	365.280	-36.12	-52.34	-13.00	-23.12	16.22	Peak	Vertical
6	526.310	-35.21	-54.28	-13.00	-22.21	19.07	Peak	Vertical

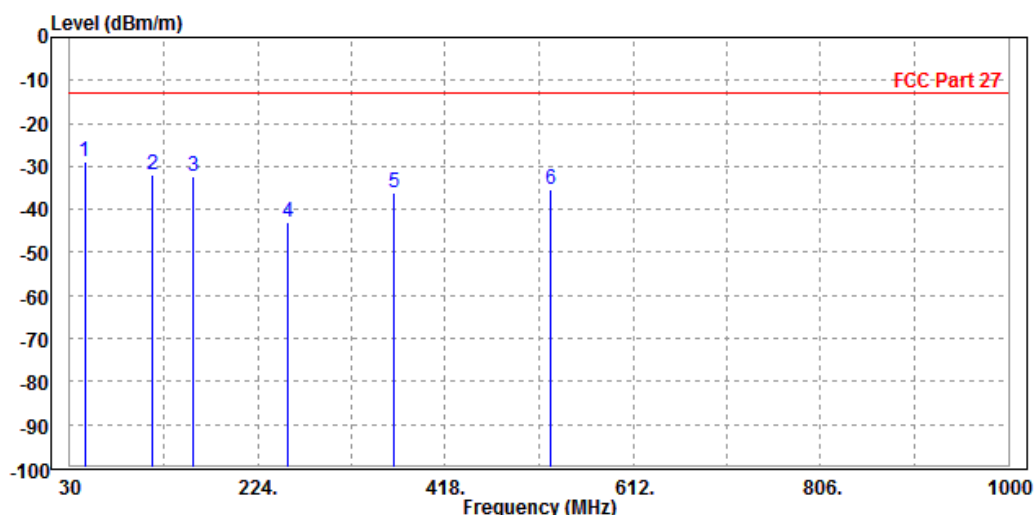



Test Report No.: RF190712W002-5

ABOVE 1GHz

Note: For higher frequency, the emission is too low to be detected.

WCDMA Band IV:

CH 1312

MODE	TX channel 1312	FREQUENCY RANGE	Above 1000MHz
ENVIRONMENTAL CONDITIONS	23deg. C, 70%RH	INPUT POWER	DC 5V/9V/12V from adapter
TESTED BY	Star Le		
ANTENNA POLARITY & TEST DISTANCE: HORIZONTAL AT 3 M			

	Freq	Level	Read Level	Limit Line	Over Limit	Factor	Remark	Pol/Phase
	MHz	dBm/m	dBm	dBm/m	dB	dB/m		
1	3418.000	-50.63	-52.48	-13.00	-37.63	1.85	Peak	Horizontal
2	PP 5137.000	-47.58	-56.12	-13.00	-34.58	8.54	Peak	Horizontal

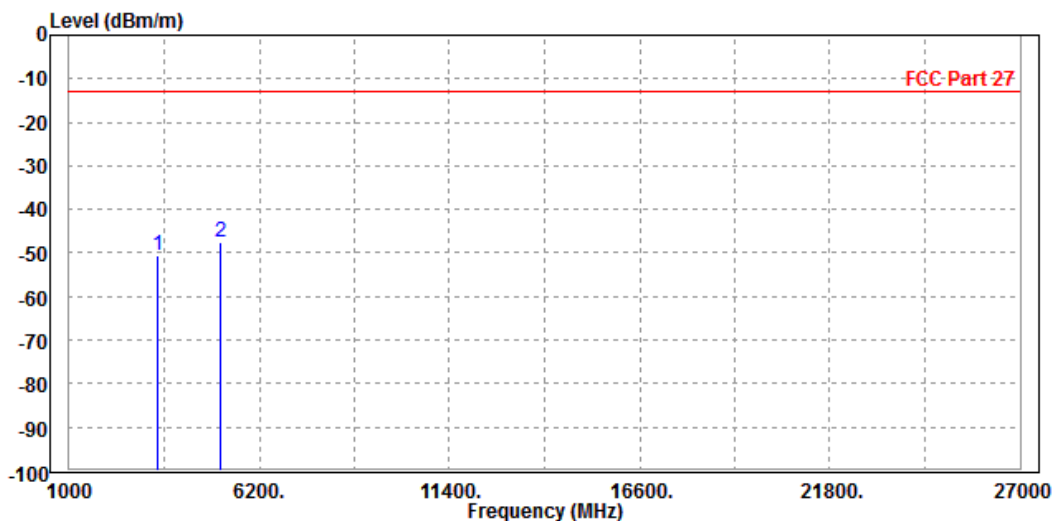



Test Report No.: RF190712W002-5

MODE	TX channel 1312	FREQUENCY RANGE	Above 1000MHz
ENVIRONMENTAL CONDITIONS	23deg. C, 70%RH	INPUT POWER	DC 5V/9V/12V from adapter
TESTED BY	Star Le		
ANTENNA POLARITY & TEST DISTANCE: VERTICAL AT 3 M			

	Freq	Level	Read Level	Limit Line	Over Limit	Factor	Remark	Pol/Phase
	MHz	dBm/m	dBm	dBm/m	dB	dB/m		
1	3418.000	-49.68	-52.15	-13.00	-36.68	2.47	Peak	Vertical
2 PP	5137.000	-47.35	-55.34	-13.00	-34.35	7.99	Peak	Vertical

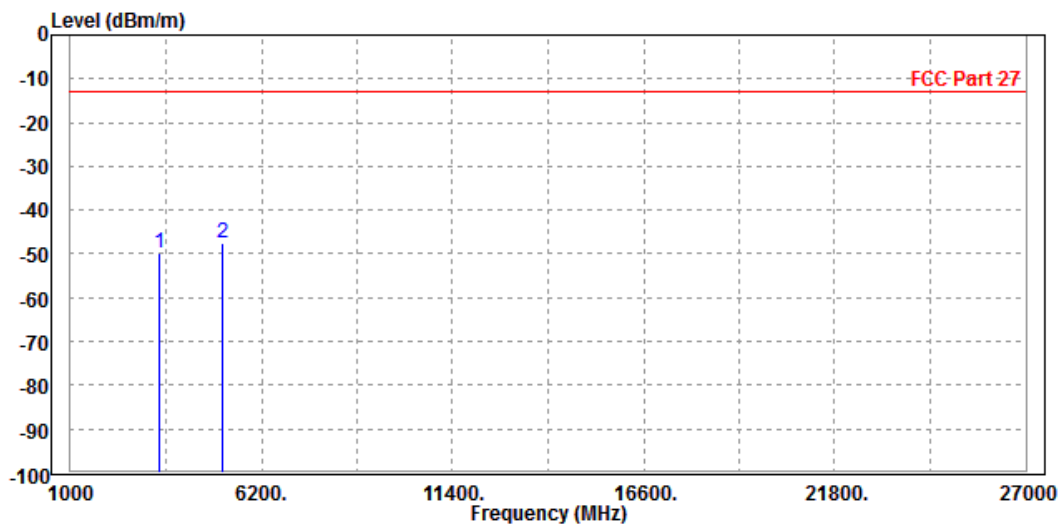



Test Report No.: RF190712W002-5

CH 1413

MODE	TX channel 1413	FREQUENCY RANGE	Above 1000MHz
ENVIRONMENTAL CONDITIONS	23deg. C, 70%RH	INPUT POWER	DC 5V/9V/12V from adapter
TESTED BY	Star Le		
ANTENNA POLARITY & TEST DISTANCE: HORIZONTAL AT 3 M			

	Freq	Level	Read Level	Limit Line	Over Limit	Factor	Remark	Pol/Phase
	MHz	dBm/m	dBm	dBm/m	dB	dB/m		
1	3470.000	-50.31	-52.36	-13.00	-37.31	2.05	Peak	Horizontal
2	PP 5197.000	-45.60	-54.21	-13.00	-32.60	8.61	Peak	Horizontal

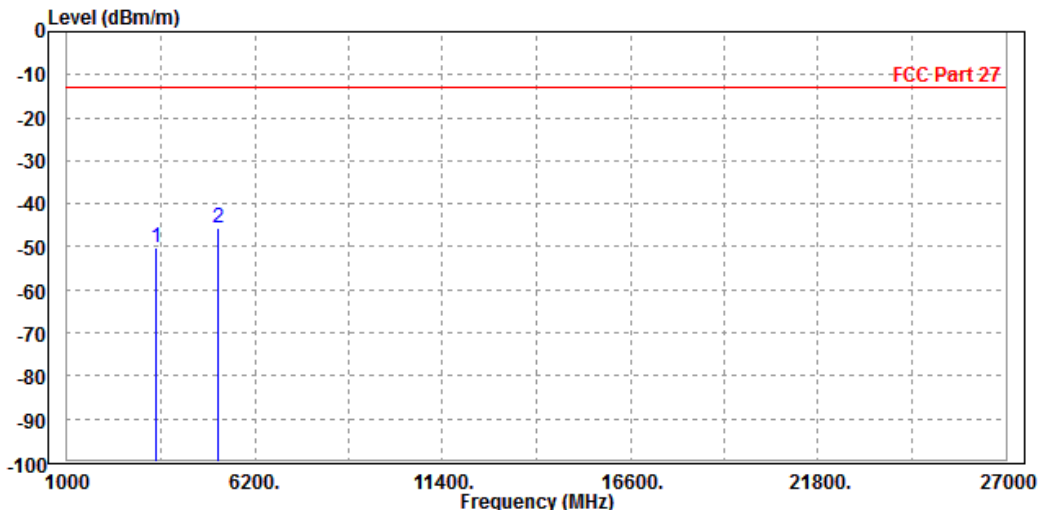



Test Report No.: RF190712W002-5

MODE	TX channel 1413	FREQUENCY RANGE	Above 1000MHz
ENVIRONMENTAL CONDITIONS	23deg. C, 70%RH	INPUT POWER	DC 5V/9V/12V from adapter
TESTED BY	Star Le		
ANTENNA POLARITY & TEST DISTANCE: VERTICAL AT 3 M			

	Freq	Level	Read Level	Limit Line	Over Limit	Factor	Remark	Pol/Phase
	MHz	dBm/m	dBm	dBm/m	dB	dB/m		
1	3470.000	-48.95	-51.48	-13.00	-35.95	2.53	Peak	Vertical
2 PP	5197.000	-47.69	-55.67	-13.00	-34.69	7.98	Peak	Vertical

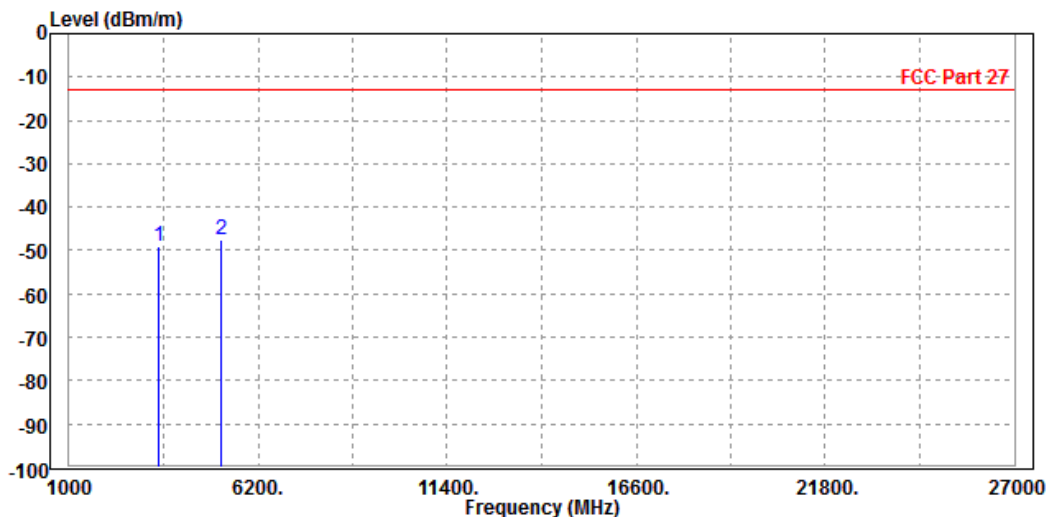



BUREAU VERITAS

Test Report No.: RF190712W002-5

CH 1513

MODE	TX channel 1513	FREQUENCY RANGE	Above 1000MHz
ENVIRONMENTAL CONDITIONS	23deg. C, 70%RH	INPUT POWER	DC 5V/9V/12V from adapter
TESTED BY	Star Le		
ANTENNA POLARITY & TEST DISTANCE: HORIZONTAL AT 3 M			

	Freq	Level	Read Level	Limit Line	Over Limit	Factor	Remark	Pol/Phase
	MHz	dBm/m	dBm	dBm/m	dB	dB/m		
1	3505.000	-50.16	-52.35	-13.00	-37.16	2.19	Peak	Horizontal
2 PP	5257.000	-48.96	-57.64	-13.00	-35.96	8.68	Peak	Horizontal

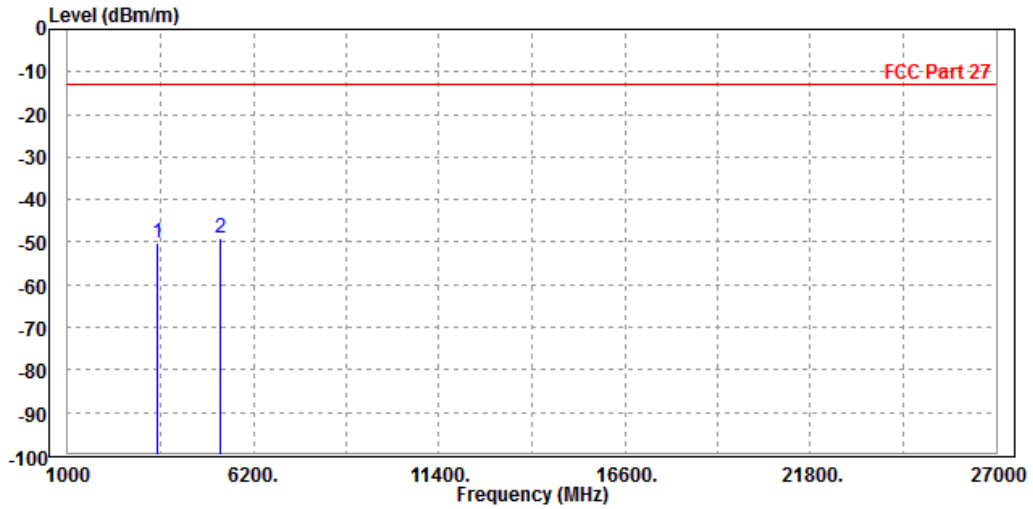



Test Report No.: RF190712W002-5

MODE	TX channel 1513	FREQUENCY RANGE	Above 1000MHz
ENVIRONMENTAL CONDITIONS	23deg. C, 70%RH	INPUT POWER	DC 5V/9V/12V from adapter
TESTED BY	Star Le		
ANTENNA POLARITY & TEST DISTANCE: VERTICAL AT 3 M			

	Freq	Level	Read Level	Limit Line	Over Limit	Factor	Remark	Pol/Phase
	MHz	dBm/m	dBm	dBm/m	dB	dB/m		
1	3505.000	-49.71	-52.31	-13.00	-36.71	2.60	Peak	Vertical
2	PP 5257.000	-47.28	-55.26	-13.00	-34.28	7.98	Peak	Vertical

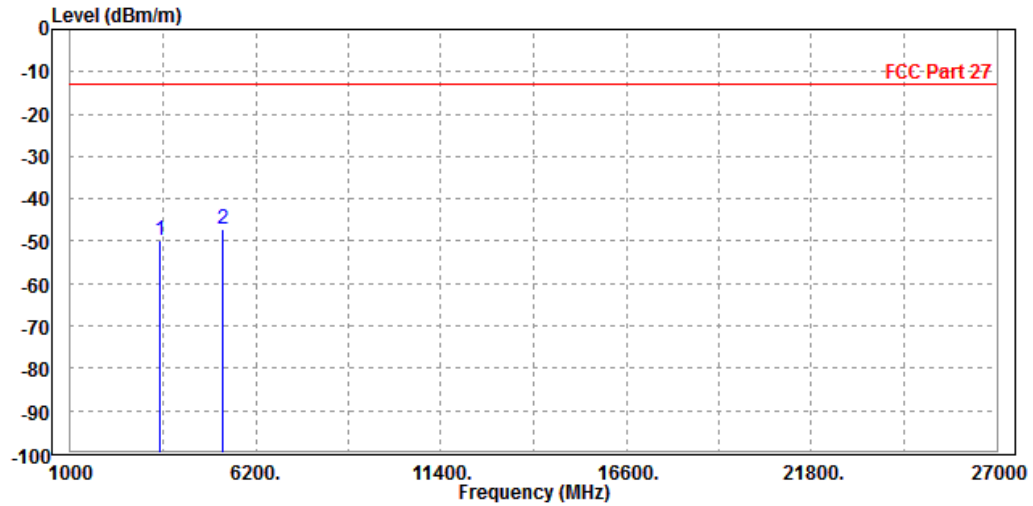



**BUREAU
VERITAS**

Test Report No.: RF190712W002-5

LTE BAND 4

CHANNEL BANDWIDTH: 1.4MHz / QPSK

MODE	TX channel 20175	FREQUENCY RANGE	Above 1000MHz
ENVIRONMENTAL CONDITIONS	23deg. C, 70%RH	INPUT POWER	DC 5V/9V/12V from adapter
TESTED BY	Star Le		
ANTENNA POLARITY & TEST DISTANCE: HORIZONTAL AT 3 M			

	Freq	Level	Read Level	Limit Line	Over Limit	Factor	Remark	Pol/Phase
	MHz	dBm/m	dBm	dBm/m	dB	dB/m		
1	3470.000	-51.57	-53.62	-13.00	-38.57	2.05	Peak	Horizontal
2 PP	5197.000	-48.81	-57.42	-13.00	-35.81	8.61	Peak	Horizontal

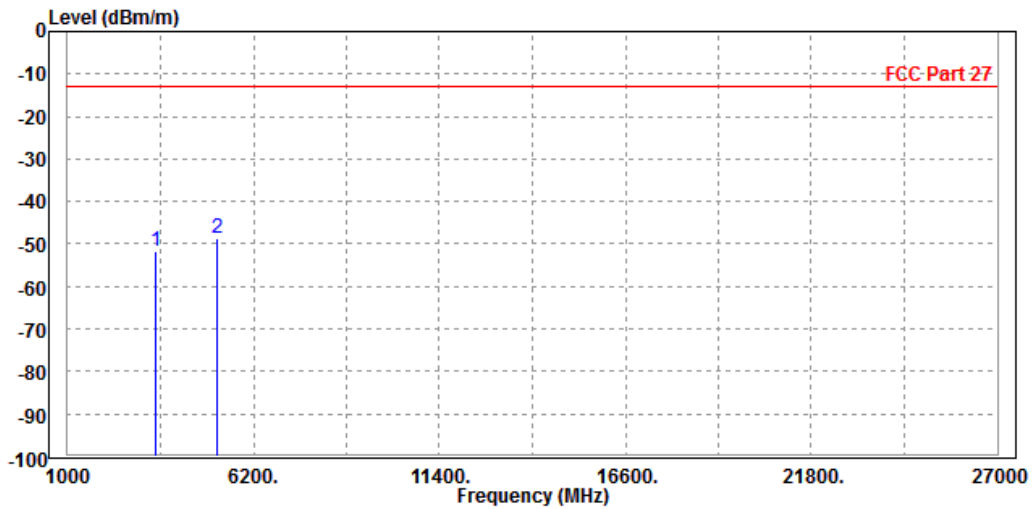



Test Report No.: RF190712W002-5

MODE	TX channel 20175	FREQUENCY RANGE	Above 1000MHz
ENVIRONMENTAL CONDITIONS	23deg. C, 70%RH	INPUT POWER	DC 5V/9V/12V from adapter
TESTED BY	Star Le		
ANTENNA POLARITY & TEST DISTANCE: VERTICAL AT 3 M			

	Freq	Level	Read Level	Limit Line	Over Limit	Factor	Remark	Pol/Phase
	MHz	dBm/m	dBm	dBm/m	dB	dB/m		
1	3470.000	-48.86	-51.39	-13.00	-35.86	2.53	Peak	Vertical
2 PP	5197.000	-48.44	-56.42	-13.00	-35.44	7.98	Peak	Vertical

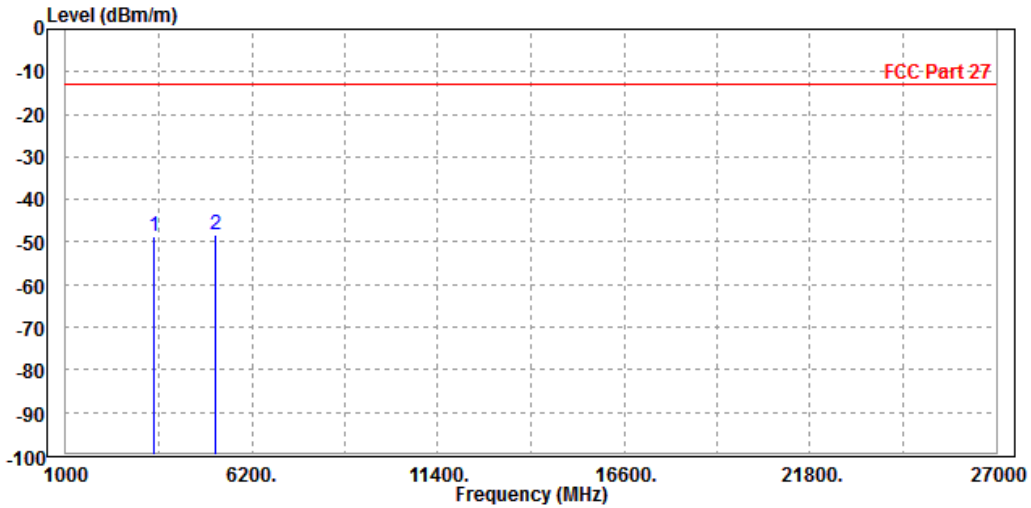



Test Report No.: RF190712W002-5

CHANNEL BANDWIDTH: 3MHz / QPSK

CH 19965

MODE	TX channel 19965	FREQUENCY RANGE	Above 1000MHz
ENVIRONMENTAL CONDITIONS	23deg. C, 70%RH	INPUT POWER	DC 5V/9V/12V from adapter
TESTED BY	Star Le		
ANTENNA POLARITY & TEST DISTANCE: HORIZONTAL AT 3 M			

	Freq	Level	Read Level	Limit Line	Over Limit	Factor	Remark	Pol/Phase
	MHz	dBm/m	dBm	dBm/m	dB	dB/m		
1	3418.000	-50.49	-52.34	-13.00	-37.49	1.85	Peak	Horizontal
2 PP	5132.000	-48.32	-56.85	-13.00	-35.32	8.53	Peak	Horizontal

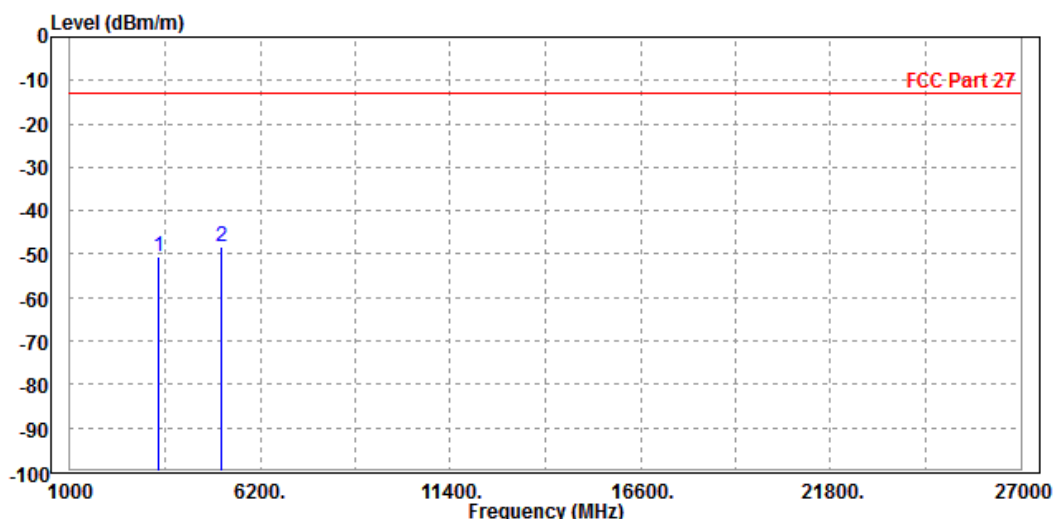



Test Report No.: RF190712W002-5

MODE	TX channel 19965	FREQUENCY RANGE	Above 1000MHz
ENVIRONMENTAL CONDITIONS	23deg. C, 70%RH	INPUT POWER	DC 5V/9V/12V from adapter
TESTED BY	Star Le		
ANTENNA POLARITY & TEST DISTANCE: VERTICAL AT 3 M			

	Freq	Level	Read Level	Limit Line	Over Limit	Factor	Remark	Pol/Phase
	MHz	dBm/m	dBm	dBm/m	dB	dB/m		
1	3418.000	-49.84	-52.31	-13.00	-36.84	2.47	Peak	Vertical
2	PP 5132.000	-48.85	-56.84	-13.00	-35.85	7.99	Peak	Vertical

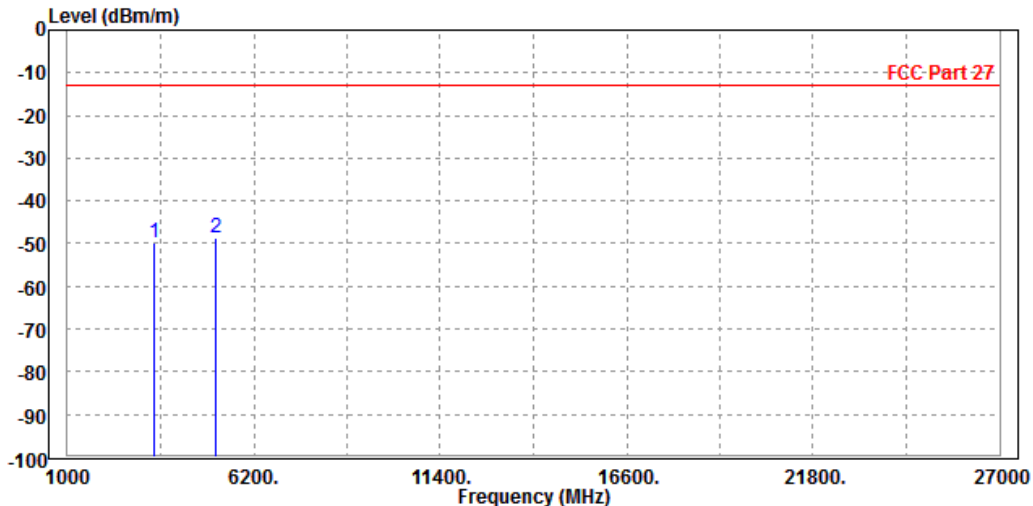



Test Report No.: RF190712W002-5

CH 20175

MODE	TX channel 20175	FREQUENCY RANGE	Above 1000MHz
ENVIRONMENTAL CONDITIONS	23deg. C, 70%RH	INPUT POWER	DC 5V/9V/12V from adapter
TESTED BY	Star Le		
ANTENNA POLARITY & TEST DISTANCE: HORIZONTAL AT 3 M			

	Freq	Level	Read Level	Limit Line	Over Limit	Factor	Remark	Pol/Phase
	MHz	dBm/m	dBm	dBm/m	dB	dB/m		
1	3470.000	-50.63	-52.68	-13.00	-37.63	2.05	Peak	Horizontal
2 PP	5197.000	-44.83	-53.44	-13.00	-31.83	8.61	Peak	Horizontal

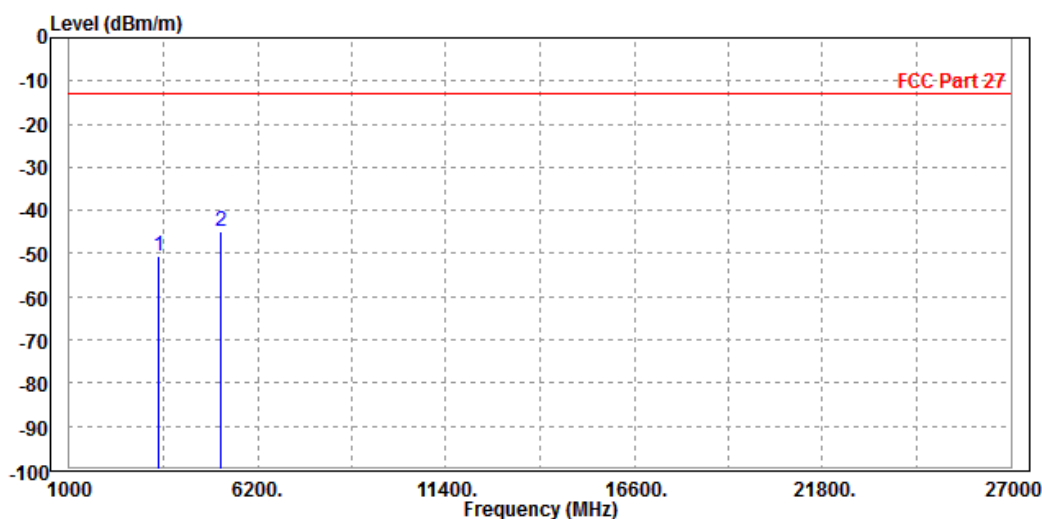



Test Report No.: RF190712W002-5

MODE	TX channel 20175	FREQUENCY RANGE	Above 1000MHz
ENVIRONMENTAL CONDITIONS	23deg. C, 70%RH	INPUT POWER	DC 5V/9V/12V from adapter
TESTED BY	Star Le		
ANTENNA POLARITY & TEST DISTANCE: VERTICAL AT 3 M			

	Freq	Level	Read Level	Limit Line	Over Limit	Factor	Remark	Pol/Phase
	MHz	dBm/m	dBm	dBm/m	dB	dB/m		
1	3470.000	-48.83	-51.36	-13.00	-35.83	2.53	Peak	Vertical
2 PP	5197.000	-48.47	-56.45	-13.00	-35.47	7.98	Peak	Vertical

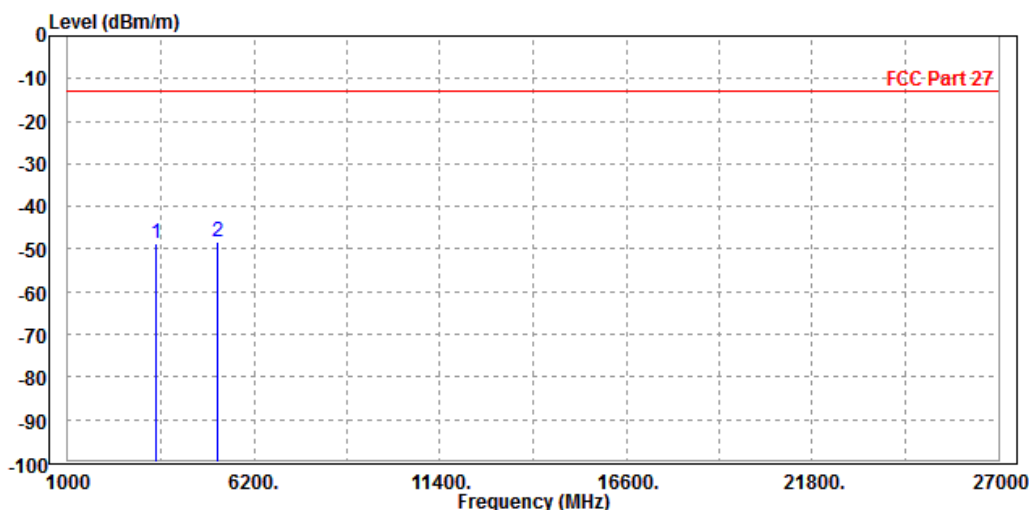



Test Report No.: RF190712W002-5

CH 20385

MODE	TX channel 20385	FREQUENCY RANGE	Above 1000MHz
ENVIRONMENTAL CONDITIONS	23deg. C, 70%RH	INPUT POWER	DC 5V/9V/12V from adapter
TESTED BY	Star Le		
ANTENNA POLARITY & TEST DISTANCE: HORIZONTAL AT 3 M			

	Freq	Level	Read Level	Limit Line	Over Limit	Factor	Remark	Pol/Phase
	MHz	dBm/m	dBm	dBm/m	dB	dB/m		
1	3502.000	-50.21	-52.38	-13.00	-37.21	2.17	Peak	Horizontal
2 PP	5266.000	-49.93	-58.62	-13.00	-36.93	8.69	Peak	Horizontal

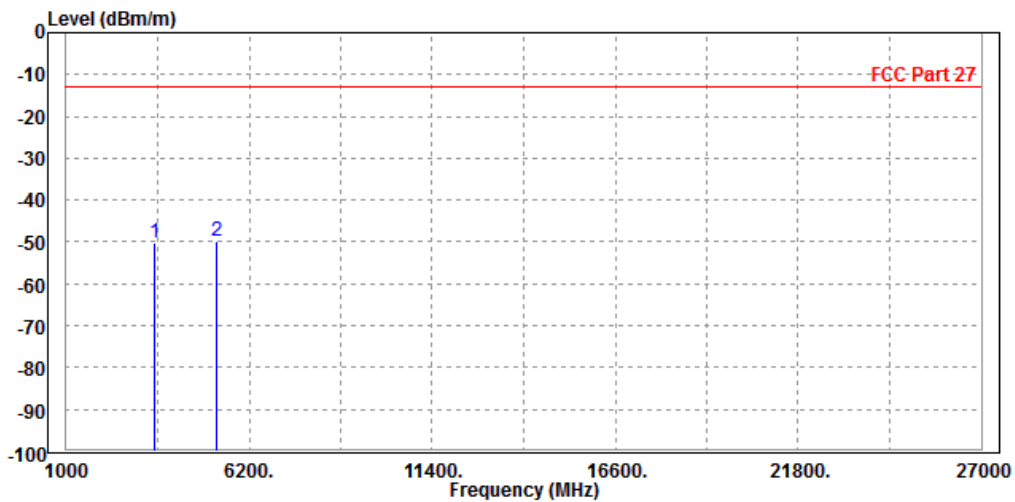



Test Report No.: RF190712W002-5

MODE	TX channel 20385	FREQUENCY RANGE	Above 1000MHz
ENVIRONMENTAL CONDITIONS	23deg. C, 70%RH	INPUT POWER	DC 5V/9V/12V from adapter
TESTED BY	Star Le		
ANTENNA POLARITY & TEST DISTANCE: VERTICAL AT 3 M			

	Freq	Level	Read Level	Limit Line	Over Limit	Factor	Remark	Pol/Phase
	MHz	dBm/m	dBm	dBm/m	dB	dB/m		
1	3502.000	-49.74	-52.32	-13.00	-36.74	2.58	Peak	Vertical
2 PP	5266.000	-49.66	-57.64	-13.00	-36.66	7.98	Peak	Vertical

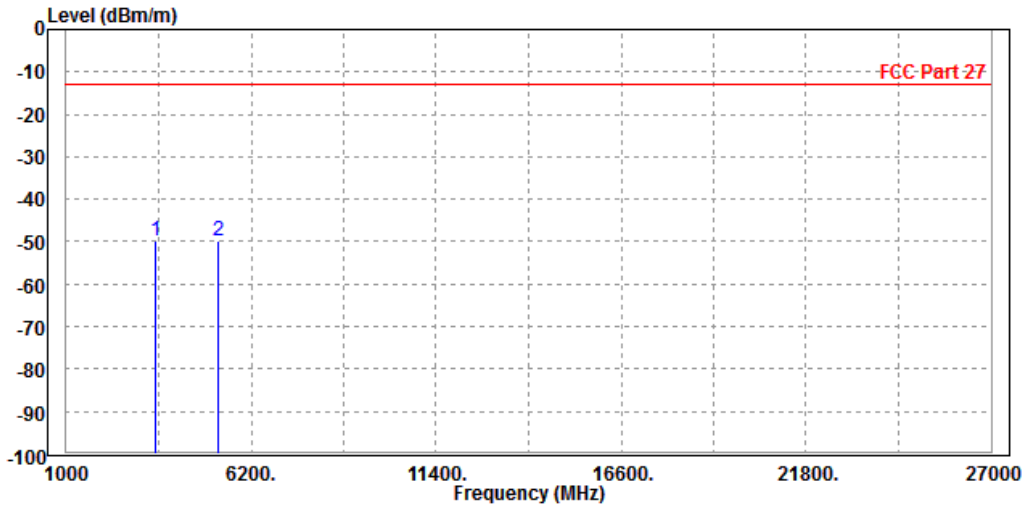



Test Report No.: RF190712W002-5

CHANNEL BANDWIDTH: 5MHz / QPSK

MODE	TX channel 20175	FREQUENCY RANGE	Above 1000MHz
ENVIRONMENTAL CONDITIONS	23deg. C, 70%RH	INPUT POWER	DC 5V/9V/12V from adapter
TESTED BY	Star Le		
ANTENNA POLARITY & TEST DISTANCE: HORIZONTAL AT 3 M			

	Freq	Level	Read Level	Limit Line	Over Limit	Factor	Remark	Pol/Phase
	MHz	dBm/m	dBm	dBm/m	dB	dB/m		
1	3470.000	-51.59	-53.64	-13.00	-38.59	2.05	Peak	Horizontal
2 PP	5197.000	-48.04	-56.65	-13.00	-35.04	8.61	Peak	Horizontal

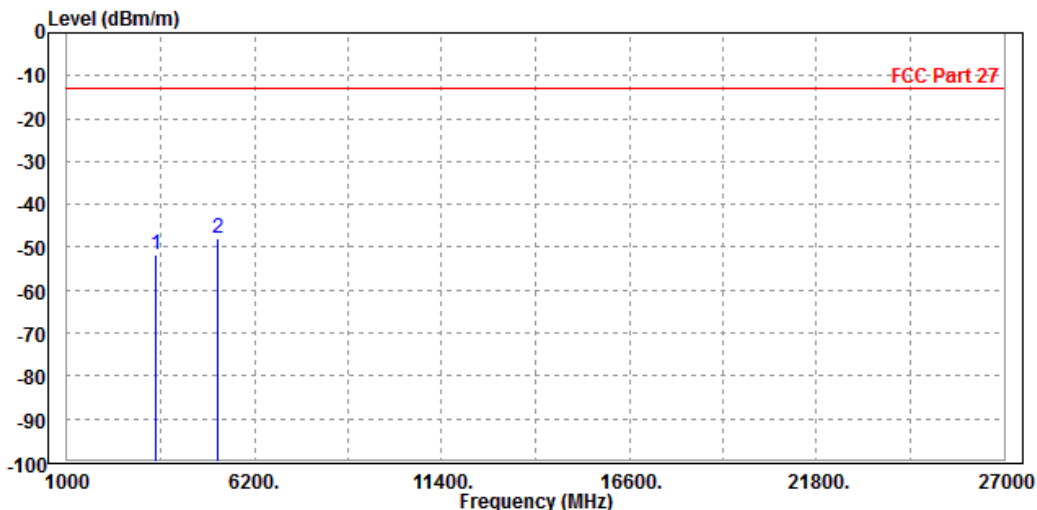



Test Report No.: RF190712W002-5

MODE	TX channel 20175	FREQUENCY RANGE	Above 1000MHz
ENVIRONMENTAL CONDITIONS	23deg. C, 70%RH	INPUT POWER	DC 5V/9V/12V from adapter
TESTED BY	Star Le		
ANTENNA POLARITY & TEST DISTANCE: VERTICAL AT 3 M			

	Freq	Level	Read Level	Limit Line	Over Limit	Factor	Remark	Pol/Phase
	MHz	dBm/m	dBm	dBm/m	dB	dB/m		
1	3470.000	-50.71	-53.24	-13.00	-37.71	2.53	Peak	Vertical
2	PP 5197.000	-48.91	-56.89	-13.00	-35.91	7.98	Peak	Vertical

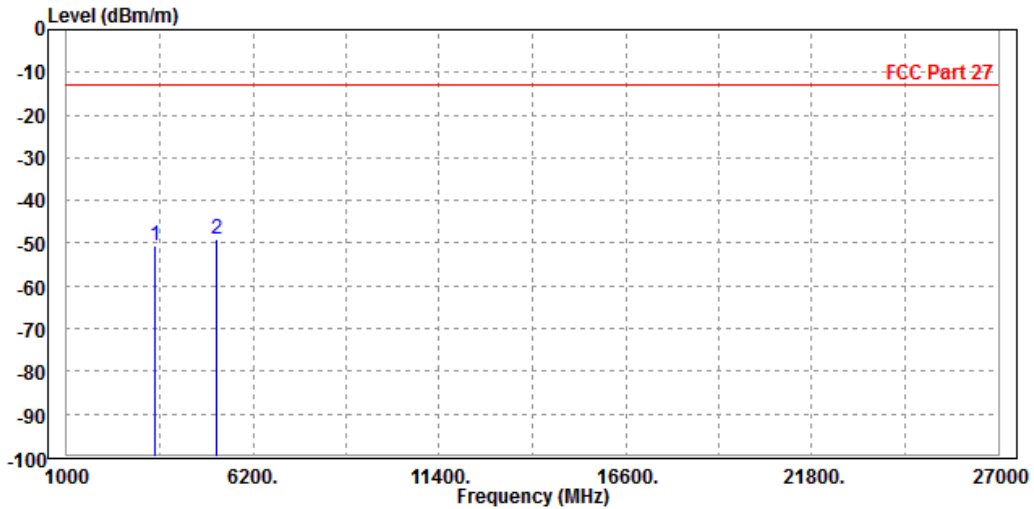



BUREAU VERITAS

Test Report No.: RF190712W002-5

CHANNEL BANDWIDTH: 10MHz / QPSK

MODE	TX channel 20175	FREQUENCY RANGE	Above 1000MHz
ENVIRONMENTAL CONDITIONS	23deg. C, 70%RH	INPUT POWER	DC 5V/9V/12V from adapter
TESTED BY	Star Le		
ANTENNA POLARITY & TEST DISTANCE: HORIZONTAL AT 3 M			

	Freq	Level	Read Level	Limit Line	Over Limit	Factor	Remark	Pol/Phase
	MHz	dBm/m	dBm	dBm/m	dB	dB/m		
1	3470.000	-47.58	-49.63	-13.00	-34.58	2.05	Peak	Horizontal
2 PP	5197.000	-45.65	-54.26	-13.00	-32.65	8.61	Peak	Horizontal

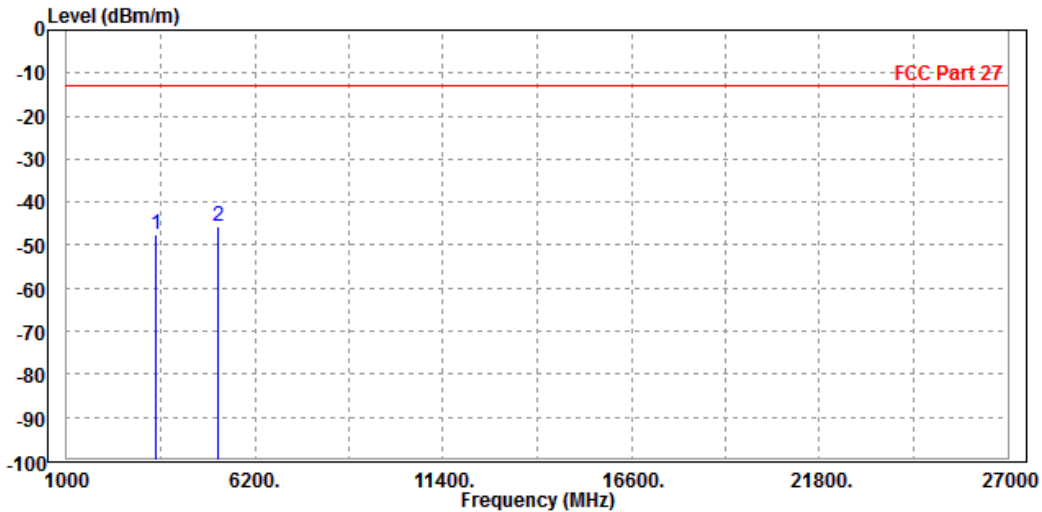



Test Report No.: RF190712W002-5

MODE	TX channel 20175	FREQUENCY RANGE	Above 1000MHz
ENVIRONMENTAL CONDITIONS	23deg. C, 70%RH	INPUT POWER	DC 5V/9V/12V from adapter
TESTED BY	Star Le		
ANTENNA POLARITY & TEST DISTANCE: VERTICAL AT 3 M			

	Freq	Level	Read Level	Limit Line	Over Limit	Factor	Remark	Pol/Phase
	MHz	dBm/m	dBm	dBm/m	dB	dB/m		
1	PP 3470.000	-47.68	-50.21	-13.00	-34.68	2.53	Peak	Vertical
2	5197.000	-47.70	-55.68	-13.00	-34.70	7.98	Peak	Vertical

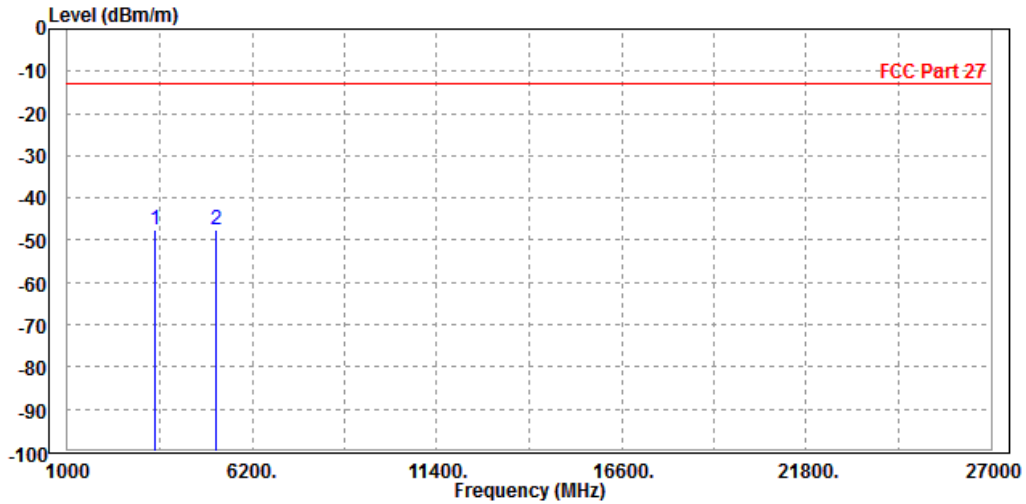



BUREAU VERITAS

Test Report No.: RF190712W002-5

CHANNEL BANDWIDTH: 15MHz / QPSK

MODE	TX channel 20175	FREQUENCY RANGE	Above 1000MHz
ENVIRONMENTAL CONDITIONS	23deg. C, 70%RH	INPUT POWER	DC 5V/9V/12V from adapter
TESTED BY	Star Le		
ANTENNA POLARITY & TEST DISTANCE: HORIZONTAL AT 3 M			

	Freq	Level	Read Level	Limit Line	Over Limit	Factor	Remark	Pol/Phase
	MHz	dBm/m	dBm	dBm/m	dB	dB/m		
1	3470.000	-50.44	-52.49	-13.00	-37.44	2.05	Peak	Horizontal
2 PP	5197.000	-47.97	-56.58	-13.00	-34.97	8.61	Peak	Horizontal

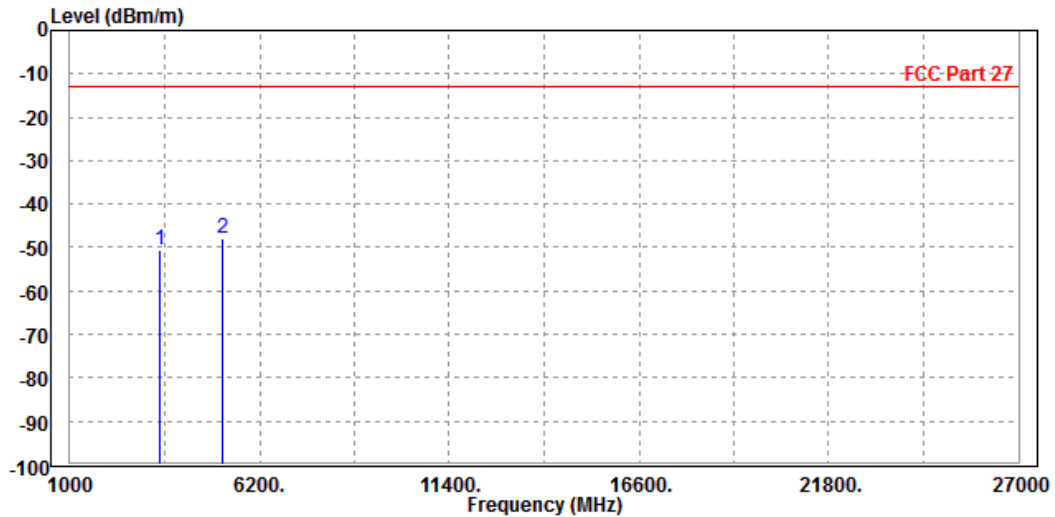



Test Report No.: RF190712W002-5

MODE	TX channel 20175	FREQUENCY RANGE	Above 1000MHz
ENVIRONMENTAL CONDITIONS	23deg. C, 70%RH	INPUT POWER	DC 5V/9V/12V from adapter
TESTED BY	Star Le		
ANTENNA POLARITY & TEST DISTANCE: VERTICAL AT 3 M			

	Freq	Level	Read Level	Limit Line	Over Limit	Factor	Remark	Pol/Phase
	MHz	dBm/m	dBm	dBm/m	dB	dB/m		
1	3470.000	-50.70	-53.23	-13.00	-37.70	2.53	Peak	Vertical
2 PP	5197.000	-50.23	-58.21	-13.00	-37.23	7.98	Peak	Vertical

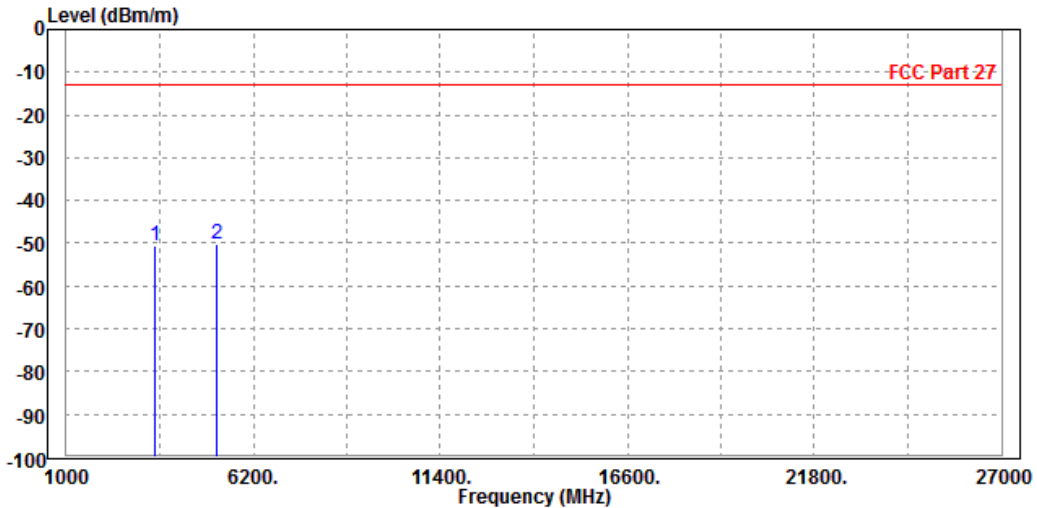



Test Report No.: RF190712W002-5

CHANNEL BANDWIDTH: 20MHz / QPSK

MODE	TX channel 20175	FREQUENCY RANGE	Above 1000MHz
ENVIRONMENTAL CONDITIONS	23deg. C, 70%RH	INPUT POWER	DC 5V/9V/12V from adapter
TESTED BY	Star Le		
ANTENNA POLARITY & TEST DISTANCE: HORIZONTAL AT 3 M			

	Freq	Level	Read Level	Limit Line	Over Limit	Factor	Remark	Pol/Phase
	MHz	dBm/m	dBm	dBm/m	dB	dB/m		
1	3470.000	-49.31	-51.36	-13.00	-36.31	2.05	Peak	Horizontal
2 PP	5197.000	-48.62	-57.23	-13.00	-35.62	8.61	Peak	Horizontal

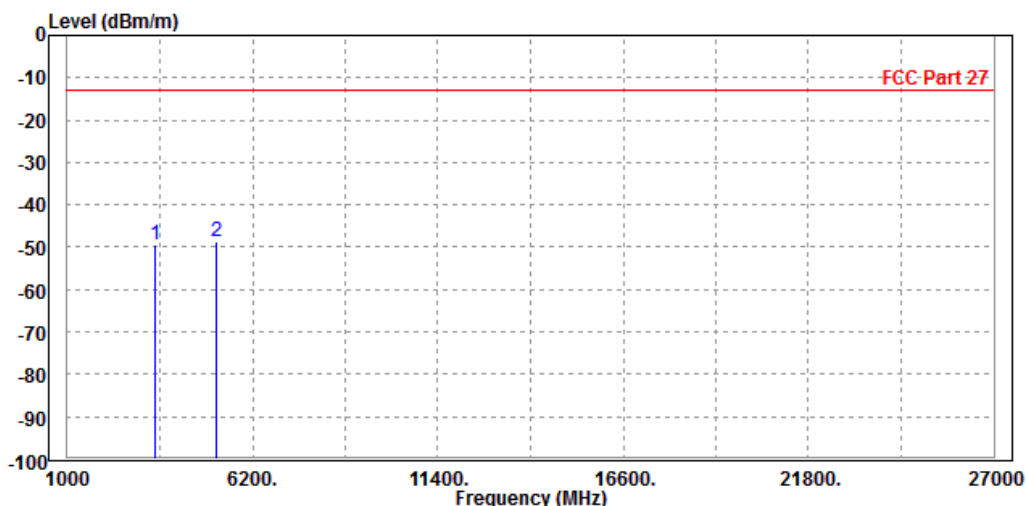



Test Report No.: RF190712W002-5

MODE	TX channel 20175	FREQUENCY RANGE	Above 1000MHz
ENVIRONMENTAL CONDITIONS	23deg. C, 70%RH	INPUT POWER	DC 5V/9V/12V from adapter
TESTED BY	Star Le		
ANTENNA POLARITY & TEST DISTANCE: VERTICAL AT 3 M			

	Freq	Level	Read Level	Limit Line	Over Limit	Factor	Remark	Pol/Phase
	MHz	dBm/m	dBm	dBm/m	dB	dB/m		
1	3470.000	-49.78	-52.31	-13.00	-36.78	2.53	Peak	Vertical
2 PP	5197.000	-48.30	-56.28	-13.00	-35.30	7.98	Peak	Vertical

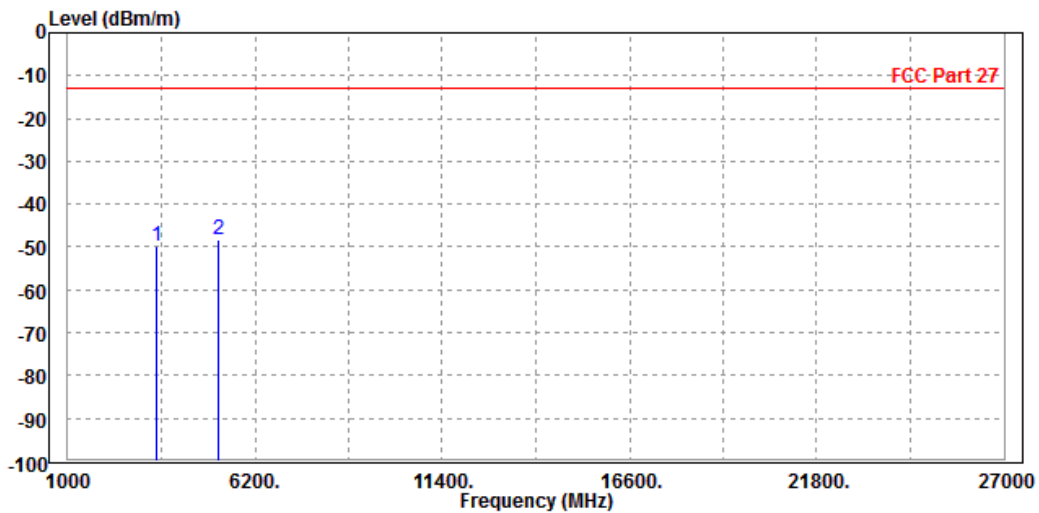



Test Report No.: RF190712W002-5

4 INFORMATION ON THE TESTING LABORATORIES

We, BV 7LAYERS COMMUNICATIONS TECHNOLOGY (SHENZHEN) CO. LTD., were founded in 2015 to provide our best service in EMC, Radio, Telecom and Safety consultation. Our laboratories are accredited and approved according to ISO/IEC 17025.

If you have any comments, please feel free to contact us at the following:

Shenzhen EMC/RF Lab:

Tel: +86-755-88696566

Fax: +86-755-88696577

Email: customerservice.dg@cn.bureauveritas.com

Web Site: www.adt.com.tw

The address and road map of all our labs can be found in our web site also.



Test Report No.: RF190712W002-5

5 APPENDIX A – MODIFICATIONS RECORDERS FOR ENGINEERING CHANGES TO THE EUT BY THE LAB

No modifications were made to the EUT by the lab during the test.

---END---