

FCC SAR Test Report

Report No. : SA190827C07
Applicant : Xiaomi Communications Co., Ltd.
Address : The Rainbow City of China Resources, NO.68, Qinghe Middle Street, Haidian District, Beijing, China
Product : Mobile Phone
FCC ID : 2AFZZC3XG
Brand : Redmi
Model No. : M1908C3XG
Standards : FCC 47 CFR Part 2 (2.1093), IEEE C95.1:1992, IEEE Std 1528:2013
KDB 865664 D01 v01r04, KDB 865664 D02 v01r02, KDB 248227 D01 v02r02,
KDB 447498 D01 v06, KDB 941225 D01 v03r01, KDB 941225 D05 v02r05, KDB
941225 D05A v01r02, KDB 941225 D06 v02r01,
Sample Received Date : Aug. 27, 2019
Date of Testing : Sep. 06, 2019 ~ Sep. 23, 2019
Lab Address : No. 47-2, 14th Ling, Chia Pau Vil., Lin Kou Dist., New Taipei City, Taiwan
Test Location : No. 19, Hwa Ya 2nd Rd., Wen Hwa Vil., Kwei Shan Dist., Taoyuan City, Taiwan

CERTIFICATION: The above equipment have been tested by **Bureau Veritas Consumer Products Services (H.K.) Ltd., Taoyuan Branch–Lin Kou Laboratories**, and found compliance with the requirement of the above standards. The test record, data evaluation & Equipment Under Test (EUT) configurations represented herein are true and accurate accounts of the measurements of the sample's SAR characteristics under the conditions specified in this report. It should not be reproduced except in full, without the written approval of our laboratory. The client should not use it to claim product certification, approval, or endorsement by TAF or any government agencies.

Prepared By : 
Rona Chen / Specialist

Approved By : 
Gordon Lin / Manager



FCC Accredited No.: TW0003

This report is for your exclusive use. Any copying or replication of this report to or for any other person or entity, or use of our name or trademark, is permitted only with our prior written permission. This report sets forth our findings solely with respect to the test samples identified herein. The results set forth in this report are not indicative or representative of the quality or characteristics of the lot from which a test sample was taken or any similar or identical product unless specifically and expressly noted. Our report includes all of the tests requested by you and the results thereof based upon the information that you provided to us. You have 60 days from date of issuance of this report to notify us of any material error or omission caused by our negligence, provided, however, that such notice shall be in writing and shall specifically address the issue you wish to raise. A failure to raise such issue within the prescribed time shall constitute your unqualified acceptance of the completeness of this report, the tests conducted and the correctness of the report contents. Unless specific mention, the uncertainty of measurement has been explicitly taken into account to declare the compliance or non-compliance to the specification.

Table of Contents

Release Control Record.....	3
1. Summary of Maximum SAR Value.....	4
2. Description of Equipment Under Test.....	5
3. SAR Measurement System.....	6
3.1 Definition of Specific Absorption Rate (SAR).....	6
3.2 SPEAG DASY6 System.....	6
3.2.1 Robot.....	7
3.2.2 Probes.....	8
3.2.3 Data Acquisition Electronics (DAE).....	8
3.2.4 Phantoms.....	8
3.2.5 Device Holder.....	9
3.2.6 System Validation Dipoles.....	9
3.2.7 Tissue Simulating Liquids.....	10
3.3 SAR System Verification.....	12
3.4 SAR Measurement Procedure.....	13
3.4.1 Area & Zoom Scan Procedure.....	13
3.4.2 Volume Scan Procedure.....	13
3.4.3 Power Drift Monitoring.....	14
3.4.4 Spatial Peak SAR Evaluation.....	14
3.4.5 SAR Averaged Methods.....	14
4. SAR Measurement Evaluation.....	15
4.1 EUT Configuration and Setting.....	15
4.2 EUT Testing Position.....	27
4.2.1 Head Exposure Conditions.....	27
4.2.2 Body-worn Accessory Exposure Conditions.....	29
4.2.3 Hotspot Mode Exposure Conditions.....	30
4.2.4 Product Specific (Phablet) Exposure Conditions.....	31
4.3 Tissue Verification.....	32
4.4 System Validation.....	33
4.5 System Verification.....	34
4.6 Maximum Output Power.....	36
4.6.1 Maximum Target Conducted Power.....	36
4.6.2 Measured Conducted Power Result.....	41
4.7 SAR Testing Results.....	56
4.7.1 SAR Test Reduction Considerations.....	56
4.7.2 SAR Results for Head Exposure Condition.....	61
4.7.3 SAR Results for Body-worn Exposure Condition (Test Separation Distance is 10 mm).....	64
4.7.4 SAR Results for Hotspot Exposure Condition (Test Separation Distance is 10 mm).....	67
4.7.5 SAR Results for Product Specific (Phablet) Exposure Condition (Test Separation Distance is 0 mm).....	71
4.7.6 SAR Measurement Variability.....	73
4.7.7 Simultaneous Multi-band Transmission Evaluation.....	75
5. Calibration of Test Equipment.....	81
6. Measurement Uncertainty.....	82
7. Information of the Testing Laboratories.....	83
Appendix A. SAR Plots of System Verification	
Appendix B. SAR Plots of SAR Measurement	
Appendix C. Calibration Certificate for Probe and Dipole	
Appendix D. Photographs of EUT and Setup	



Release Control Record

Report No.	Reason for Change	Date Issued
SA190827C07	Initial release	Oct. 02, 2019

1. Summary of Maximum SAR Value

Equipment Class	Mode	Highest SAR-1g Head (W/kg)	Highest SAR-1g Body-worn Tested at 10 mm (W/kg)	Highest SAR-1g Hotspot Tested at 10 mm (W/kg)	Highest SAR-10g Product Specific Tested at 0 mm (W/kg)
PCE	GSM850	0.17	0.34	0.34	N/A
	GSM1900	0.08	1.08	1.18	2.76
	WCDMA II	0.12	0.74	0.99	2.23
	WCDMA IV	0.14	0.94	0.96	2.90
	WCDMA V	0.14	0.27	0.27	N/A
	LTE 2	0.13	0.91	1.04	2.32
	LTE 4	0.16	0.80	0.87	2.24
	LTE 5	0.11	0.21	0.21	N/A
	LTE 7	0.15	0.62	0.71	2.33
LTE 38	0.08	0.84	0.92	N/A	
DTS	2.4G WLAN	0.80	0.48	0.48	N/A
NII	5.2G WLAN	N/A	N/A	0.17	N/A
	5.3G WLAN	1.02	0.41	N/A	0.58
	5.6G WLAN	0.92	0.36	N/A	0.54
	5.8G WLAN	0.78	0.36	0.36	N/A
DSS	Bluetooth	0.09	0.03	0.03	N/A
DXX	NFC	N/A	N/A	N/A	N/A

Highest Simultaneous Transmission SAR	Highest SAR-1g Head (W/kg)	Highest SAR-1g Body-worn Tested at 10 mm (W/kg)	Highest SAR-1g Hotspot Tested at 10 mm (W/kg)	Highest SAR-10g Product Specific Tested at 0 mm (W/kg)
		1.27	1.56	1.56

Note:

- The SAR criteria (Head & Body: SAR-1g 1.6 W/kg, and Extremity: SAR-10g 4.0 W/kg) for general population/uncontrolled exposure is specified in FCC 47 CFR part 2 (2.1093) and ANSI/IEEE C95.1-1992.

FCC SAR Test Report

2. Description of Equipment Under Test

EUT Type	Mobile Phone
FCC ID	2AFZZC3XG
Brand Name	Redmi
Model Name	M1908C3XG
Tx Frequency Bands (Unit: MHz)	GSM850 : 824.2 ~ 848.8 GSM1900 : 1850.2 ~ 1909.8 WCDMA Band II : 1852.4 ~ 1907.6 WCDMA Band IV : 1712.4 ~ 1752.6 WCDMA Band V : 826.4 ~ 846.6 LTE Band 2 : 1850.7 ~ 1909.3 (BW: 1.4M, 3M, 5M, 10M, 15M, 20M) LTE Band 4 : 1710.7 ~ 1754.3 (BW: 1.4M, 3M, 5M, 10M, 15M, 20M) LTE Band 5 : 824.7 ~ 848.3 (BW: 1.4M, 3M, 5M, 10M) LTE Band 7 : 2502.5 ~ 2567.5 (BW: 5M, 10M, 15M, 20M) LTE Band 38 : 2572.5 ~ 2617.5 (BW: 5M, 10M, 15M, 20M) WLAN : 2412 ~ 2462, 5180 ~ 5240, 5260 ~ 5320, 5500 ~ 5720, 5745 ~ 5805 Bluetooth : 2402 ~ 2480 NFC : 13.56
Uplink Modulations	GSM & GPRS : GMSK EDGE : 8PSK WCDMA : QPSK LTE : QPSK, 16QAM, 64QAM 802.11b : DSSS 802.11a/g/n/ac : OFDM Bluetooth : GFSK, $\pi/4$ -DQPSK, 8-DPSK NFC : ASK
Maximum Tune-up Conducted Power (Unit: dBm)	Please refer to section 4.6.1 of this report
Antenna Type	Fixed Internal Antenna
EUT Stage	Identical Prototype

Note:

- The above EUT information is declared by manufacturer and for more detailed features description please refers to the manufacturer's specifications or User's Manual.

WWAN scenarios:

Power Table	Test Scenario	SAR P-sensor
Full Power	Head	Off
	Body-Worn 10mm / Hotspot 10mm	Off
	Product Specific 0mm	Off
Reduction Power-1	Body-Worn 10mm / Hotspot 10mm	On
Reduction Power-2	Product Specific 0mm	On

List of Accessory:

Battery	Brand Name	MI
	Model Name	BN46
	Power Rating	3.85 Vdc, Min. 3900 mAh, Typ. 4000 mAh
	Type	Li-ion

3. SAR Measurement System

3.1 Definition of Specific Absorption Rate (SAR)

SAR is related to the rate at which energy is absorbed per unit mass in an object exposed to a radio field. The SAR distribution in a biological body is complicated and is usually carried out by experimental techniques or numerical modeling. The standard recommends limits for two tiers of groups, occupational/controlled and general population/uncontrolled, based on a person's awareness and ability to exercise control over his or her exposure. In general, occupational/controlled exposure limits are higher than the limits for general population/uncontrolled.

The SAR definition is the time derivative (rate) of the incremental energy (dW) absorbed by (dissipated in) an incremental mass (dm) contained in a volume element (dv) of a given density (ρ). The equation description is as below:

$$\text{SAR} = \frac{d}{dt} \left(\frac{dW}{dm} \right) = \frac{d}{dt} \left(\frac{dW}{\rho dv} \right)$$

SAR is expressed in units of Watts per kilogram (W/kg)

SAR measurement can be related to the electrical field in the tissue by

$$\text{SAR} = \frac{\sigma |E|^2}{\rho}$$

Where: σ is the conductivity of the tissue, ρ is the mass density of the tissue and E is the RMS electrical field strength.

3.2 SPEAG DASY6 System

DASY6 system consists of high precision robot, probe alignment sensor, phantom, robot controller, controlled measurement server and near-field probe. The robot includes six axes that can move to the precision position of the DASY6 software defined. The DASY6 software can define the area that is detected by the probe. The robot is connected to controlled box. Controlled measurement server is connected to the controlled robot box. The DAE includes amplifier, signal multiplexing, AD converter, offset measurement and surface detection. It is connected to the Electro-optical coupler (ECO). The ECO performs the conversion from the optical into digital electric signal of the DAE and transfers data to the PC.

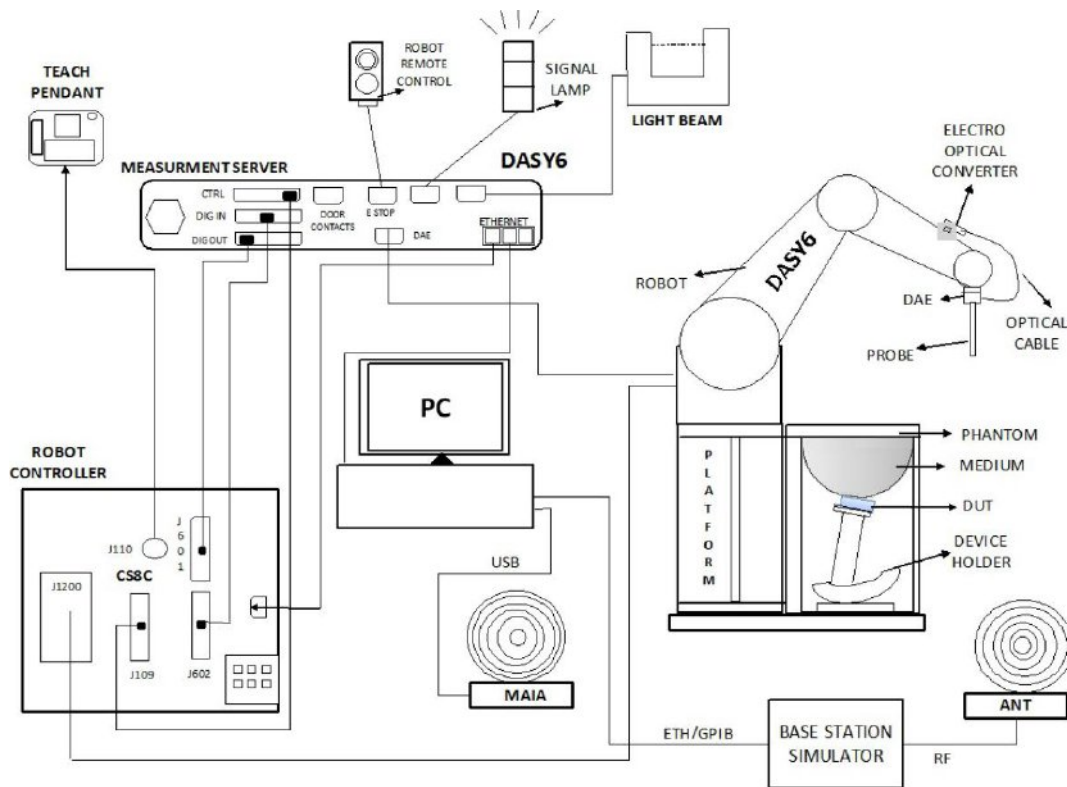

Fig-3.1 SPEAG DASY6 System Setup

3.2.1 Robot

The DASY6 systems use the high precision robots from Stäubli SA (France). For the 6-axis controller system, the robot controller version of CS8c from Stäubli is used. The Stäubli robot series have many features that are important for our application:

- High precision (repeatability ± 0.035 mm)
- High reliability (industrial design)
- Jerk-free straight movements
- Low ELF interference (the closed metallic construction shields against motor control fields)



Fig-3.2 SPEAG DASY6 System

FCC SAR Test Report

3.2.2 Probes

The SAR measurement is conducted with the dosimetric probe. The probe is specially designed and calibrated for use in liquid with high permittivity. The dosimetric probe has special calibration in liquid at different frequency.

Model	EX3DV4	
Construction	Symmetrical design with triangular core. Built-in shielding against static charges. PEEK enclosure material (resistant to organic solvents, e.g., DGBE).	
Frequency	4 MHz to 10 GHz Linearity: ± 0.2 dB	
Directivity	± 0.1 dB in TSL (rotation around probe axis) ± 0.3 dB in TSL (rotation normal to probe axis)	
Dynamic Range	10 μ W/g to 100 mW/g Linearity: ± 0.2 dB (noise: typically < 1 μ W/g)	
Dimensions	Overall length: 337 mm (Tip: 20 mm) Tip diameter: 2.5 mm (Body: 12 mm) Typical distance from probe tip to dipole centers: 1 mm	

3.2.3 Data Acquisition Electronics (DAE)

Model	DAE3, DAE4	
Construction	Signal amplifier, multiplexer, A/D converter and control logic. Serial optical link for communication with DASY embedded system (fully remote controlled). Two step probe touch detector for mechanical surface detection and emergency robot stop.	
Measurement Range	-100 to +300 mV (16 bit resolution and two range settings: 4mV, 400mV)	
Input Offset Voltage	< 5 μ V (with auto zero)	
Input Bias Current	< 50 fA	
Dimensions	60 x 60 x 68 mm	

3.2.4 Phantoms

Model	Twin SAM	
Construction	The shell corresponds to the specifications of the Specific Anthropomorphic Mannequin (SAM) phantom defined in IEEE 1528 and IEC 62209-1. It enables the dosimetric evaluation of left and right hand phone usage as well as body mounted usage at the flat phantom region. A cover prevents evaporation of the liquid. Reference markings on the phantom allow the complete setup of all predefined phantom positions and measurement grids by teaching three points with the robot.	
Material	Vinylester, glass fiber reinforced (VE-GF)	
Shell Thickness	2 ± 0.2 mm (6 ± 0.2 mm at ear point)	
Dimensions	Length: 1000 mm Width: 500 mm Height: adjustable feet	
Filling Volume	approx. 25 liters	

FCC SAR Test Report

Model	ELI	
Construction	Phantom for compliance testing of handheld and body-mounted wireless devices in the frequency range of 30 MHz to 6 GHz. ELI is fully compatible with the IEC 62209-2 standard and all known tissue simulating liquids. ELI has been optimized regarding its performance and can be integrated into our standard phantom tables. A cover prevents evaporation of the liquid. Reference markings on the phantom allow installation of the complete setup, including all predefined phantom positions and measurement grids, by teaching three points. The phantom is compatible with all SPEAG dosimetric probes and dipoles.	
Material	Vinylester, glass fiber reinforced (VE-GF)	
Shell Thickness	2.0 ± 0.2 mm (bottom plate)	
Dimensions	Major axis: 600 mm Minor axis: 400 mm	
Filling Volume	approx. 30 liters	

3.2.5 Device Holder

Model	Mounting Device	
Construction	In combination with the Twin SAM Phantom or ELI4, the Mounting Device enables the rotation of the mounted transmitter device in spherical coordinates. Rotation point is the ear opening point. Transmitter devices can be easily and accurately positioned according to IEC, IEEE, FCC or other specifications. The device holder can be locked for positioning at different phantom sections (left head, right head, flat).	
Material	POM	

Model	Laptop Extensions Kit	
Construction	Simple but effective and easy-to-use extension for Mounting Device that facilitates the testing of larger devices according to IEC 62209-2 (e.g., laptops, cameras, etc.). It is lightweight and fits easily on the upper part of the Mounting Device in place of the phone positioner.	
Material	POM, Acrylic glass, Foam	

3.2.6 System Validation Dipoles

Model	D-Serial	
Construction	Symmetrical dipole with 1/4 balun. Enables measurement of feedpoint impedance with NWA. Matched for use near flat phantoms filled with tissue simulating solutions.	
Frequency	750 MHz to 5800 MHz	
Return Loss	> 20 dB	
Power Capability	> 100 W (f < 1GHz), > 40 W (f > 1GHz)	

3.2.7 Tissue Simulating Liquids

For SAR measurement of the field distribution inside the phantom, the phantom must be filled with homogeneous tissue simulating liquid to a depth of at least 15 cm. For head SAR testing, the liquid height from the ear reference point (ERP) of the phantom to the liquid top surface is larger than 15 cm. For body SAR testing, the liquid height from the center of the flat phantom to the liquid top surface is larger than 15 cm. The nominal dielectric values of the tissue simulating liquids in the phantom and the tolerance of 5% are listed in Table-3.1.

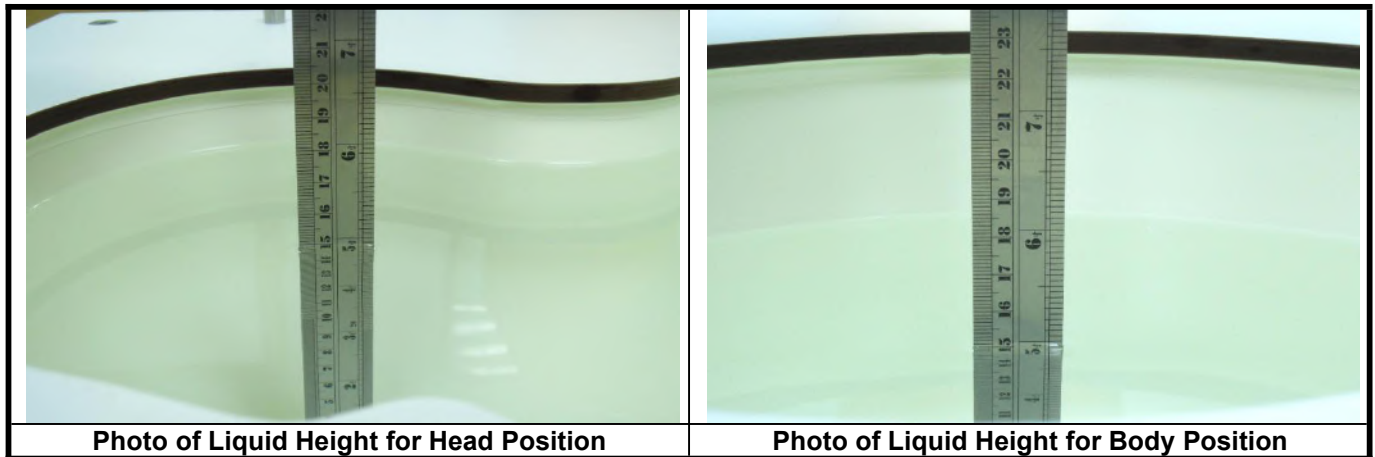

The dielectric properties of the head tissue simulating liquids are defined in IEEE1528, and KDB 865664 D01 Appendix A. For the body tissue simulating liquids, the dielectric properties are defined in KDB 865664 D01 Appendix A. The dielectric properties of the tissue simulating liquids were verified prior to the SAR evaluation using a dielectric assessment kit and a network analyzer.

Table-3.1 Targets of Tissue Simulating Liquid

Frequency (MHz)	Target Permittivity	Range of $\pm 5\%$	Target Conductivity	Range of $\pm 5\%$
750	41.9	39.8 ~ 44.0	0.89	0.85 ~ 0.93
835	41.5	39.4 ~ 43.6	0.90	0.86 ~ 0.95
900	41.5	39.4 ~ 43.6	0.97	0.92 ~ 1.02
1450	40.5	38.5 ~ 42.5	1.20	1.14 ~ 1.26
1640	40.3	38.3 ~ 42.3	1.29	1.23 ~ 1.35
1750	40.1	38.1 ~ 42.1	1.37	1.30 ~ 1.44
1800	40.0	38.0 ~ 42.0	1.40	1.33 ~ 1.47
1900	40.0	38.0 ~ 42.0	1.40	1.33 ~ 1.47
2000	40.0	38.0 ~ 42.0	1.40	1.33 ~ 1.47
2300	39.5	37.5 ~ 41.5	1.67	1.59 ~ 1.75
2450	39.2	37.2 ~ 41.2	1.80	1.71 ~ 1.89
2600	39.0	37.1 ~ 41.0	1.96	1.86 ~ 2.06
3500	37.9	36.0 ~ 39.8	2.91	2.76 ~ 3.06
5200	36.0	34.2 ~ 37.8	4.66	4.43 ~ 4.89
5300	35.9	34.1 ~ 37.7	4.76	4.52 ~ 5.00
5500	35.6	33.8 ~ 37.4	4.96	4.71 ~ 5.21
5600	35.5	33.7 ~ 37.3	5.07	4.82 ~ 5.32
5800	35.3	33.5 ~ 37.1	5.27	5.01 ~ 5.53

The following table gives the recipes for tissue simulating liquids.

Table-3.2 Recipes of Tissue Simulating Liquid

Tissue Type	Bactericide	DGBE	HEC	NaCl	Sucrose	Triton X-100	Water	Diethylene Glycol Mono-hexylether
H750	0.2	-	0.2	1.5	56.0	-	42.1	-
H835	0.2	-	0.2	1.5	57.0	-	41.1	-
H900	0.2	-	0.2	1.4	58.0	-	40.2	-
H1450	-	43.3	-	0.6	-	-	56.1	-
H1640	-	45.8	-	0.5	-	-	53.7	-
H1750	-	47.0	-	0.4	-	-	52.6	-
H1800	-	44.5	-	0.3	-	-	55.2	-
H1900	-	44.5	-	0.2	-	-	55.3	-
H2000	-	44.5	-	0.1	-	-	55.4	-
H2300	-	44.9	-	0.1	-	-	55.0	-
H2450	-	45.0	-	0.1	-	-	54.9	-
H2600	-	45.1	-	0.1	-	-	54.8	-
H3500	-	8.0	-	0.2	-	20.0	71.8	-
H5G	-	-	-	-	-	17.2	65.5	17.3

3.3 SAR System Verification

The system check verifies that the system operates within its specifications. It is performed daily or before every SAR measurement. The system check uses normal SAR measurements in the flat section of the phantom with a matched dipole at a specified distance. The system verification setup is shown as below.

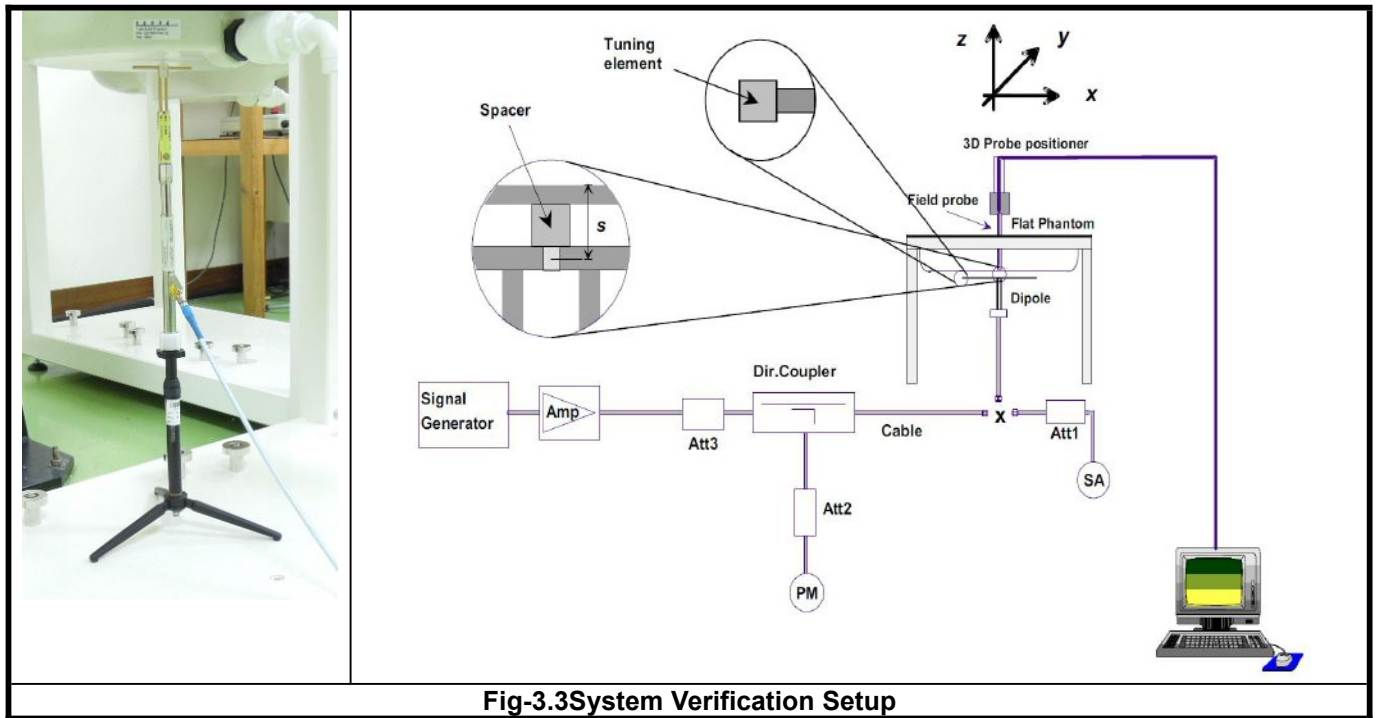

Fig-3.3 System Verification Setup

The validation dipole is placed beneath the flat phantom with the specific spacer in place. The distance spacer is touched to the phantom surface with a light pressure at the reference marking and is oriented parallel to the long side of the phantom. The spectrum analyzer measures the forward power at the location of the system check dipole connector. The signal generator is adjusted for the desired forward power (250 mW is used for 700 MHz to 3 GHz, 100 mW is used for 3.5 GHz to 6 GHz) at the dipole connector and the power meter is read at that level. After connecting the cable to the dipole, the signal generator is readjusted for the same reading at the power meter.

After system check testing, the SAR result will be normalized to 1W forward input power and compared with the reference SAR value derived from the validation dipole certificate report. The deviation of the system check should be within 10 %.

3.4 SAR Measurement Procedure

According to the SAR test standard, the recommended procedure for assessing the peak spatial-average SAR value consists of the following steps:

- (a) Power reference measurement
- (b) Area scan
- (c) Zoom scan
- (d) Power drift measurement

The SAR measurement procedures for each of test conditions are as follows:

- (a) Make EUT to transmit maximum output power
- (b) Measure conducted output power through RF cable
- (c) Place the EUT in the specific position of phantom
- (d) Perform SAR testing steps on the DASY system
- (e) Record the SAR value

3.4.1 Area & Zoom Scan Procedure

First Area Scan is used to locate the approximate location(s) of the local peak SAR value(s). The measurement grid within an Area Scan is defined by the grid extent, grid step size and grid offset. Next, in order to determine the EM field distribution in a three-dimensional spatial extension, Zoom Scan is required. The Zoom Scan is performed around the highest E-field value to determine the averaged SAR-distribution over 10 g. According to KDB 865664D01, the resolution for Area and Zoom scan is specified in the table below.

Items	<= 2 GHz	2-3 GHz	3-4 GHz	4-5 GHz	5-6 GHz
Area Scan ($\Delta x, \Delta y$)	<= 15 mm	<= 12 mm	<= 12 mm	<= 10 mm	<= 10 mm
Zoom Scan ($\Delta x, \Delta y$)	<= 8 mm	<= 5 mm	<= 5 mm	<= 4 mm	<= 4 mm
Zoom Scan (Δz)	<= 5 mm	<= 5 mm	<= 4 mm	<= 3 mm	<= 2 mm
Zoom Scan Volume	>= 30 mm	>= 30 mm	>= 28 mm	>= 25 mm	>= 22 mm

Note:

When zoom scan is required and report SAR is <=1.4 W/kg, the zoom scan resolution of $\Delta x / \Delta y$ (2-3GHz: <= 8 mm, 3-4GHz: <= 7 mm, 4-6GHz: <= 5 mm) may be applied.

3.4.2 Volume Scan Procedure

The volume scan is used for assess overlapping SAR distributions for antennas transmitting in different frequency bands. It is equivalent to an oversized zoom scan used in standalone measurements. The measurement volume will be used to enclose all the simultaneous transmitting antennas. For antennas transmitting simultaneously in different frequency bands, the volume scan is measured separately in each frequency band. In order to sum correctly to compute the 1g aggregate SAR, the EUT remain in the same test position for all measurements and all volume scan use the same spatial resolution and grid spacing. When all volume scan were completed, the software, SEMCAD postprocessor can combine and subsequently superpose these measurement data to calculating the multiband SAR.

3.4.3 Power Drift Monitoring

All SAR testing is under the EUT install full charged battery and transmit maximum output power. In DASYS measurement software, the power reference measurement and power drift measurement procedures are used for monitoring the power drift of EUT during SAR test. Both these procedures measure the field at a specified reference position before and after the SAR testing. The software will calculate the field difference in dB. If the power drift more than 5%, the SAR will be retested.

3.4.4 Spatial Peak SAR Evaluation

The procedure for spatial peak SAR evaluation has been implemented according to the test standard. It can be conducted for 1g and 10g, as well as for user-specific masses. The DASYS software includes all numerical procedures necessary to evaluate the spatial peak SAR value.

The base for the evaluation is a "cube" measurement. The measured volume must include the 1g and 10g cubes with the highest averaged SAR values. For that purpose, the center of the measured volume is aligned to the interpolated peak SAR value of a previously performed area scan.

The entire evaluation of the spatial peak values is performed within the post-processing engine (SEMCAD). The system always gives the maximum values for the 1g and 10g cubes. The algorithm to find the cube with highest averaged SAR is divided into the following stages:

- (a) Extraction of the measured data (grid and values) from the Zoom Scan
- (b) Calculation of the SAR value at every measurement point based on all stored data (A/D values and measurement parameters)
- (c) Generation of a high-resolution mesh within the measured volume
- (d) Interpolation of all measured values from the measurement grid to the high-resolution grid
- (e) Extrapolation of the entire 3-D field distribution to the phantom surface over the distance from sensor to surface
- (f) Calculation of the averaged SAR within masses of 1g and 10g

3.4.5 SAR Averaged Methods

In DASYS, the interpolation and extrapolation are both based on the modified Quadratic Shepard's method. The interpolation scheme combines a least-square fitted function method and a weighted average method which are the two basic types of computational interpolation and approximation.

Extrapolation routines are used to obtain SAR values between the lowest measurement points and the inner phantom surface. The extrapolation distance is determined by the surface detection distance and the probe sensor offset. The uncertainty increases with the extrapolation distance. To keep the uncertainty within 1% for the 1 g and 10 g cubes, the extrapolation distance should not be larger than 5 mm.

4. SAR Measurement Evaluation

4.1 EUT Configuration and Setting

<Considerations Related to Proximity Sensor>

The device supports WWAN, WLAN, and Bluetooth capabilities. It is designed with a proximity sensor which can trigger/not trigger power reduction for GSM 1900, WCDMA II/IV and LTE 2/4/7 on Front Face, Rear Face, and Bottom Side of EUT for SAR compliance. Others RF capability (WLAN and Bluetooth) have no power reduction. The power levels for all wireless technologies and the power reduction please refer to section 4.6 of this report.

Proximity Sensor Triggering Distances (KDB 616217 D04 §6.2)

The proximity sensor triggering distance was determined per KDB 616217 for rear face and applicable edge. Summary for power verification per distance was tabulated in the below table.

Output Power Verification in dBm for EUT Rear Face											
Distance (mm)	13	14	15	16	17	18	19	20	21	22	23
GSM1900. GSM	30.3	30.0	29.9	30.4	29.9	30.0	31.3	31.1	31.0	31.0	31.1
GSM1900. GPRS 1Tx	30.3	30.4	30.3	30.3	30.0	30.2	31.1	31.3	31.3	31.0	31.5
GSM1900. GPRS 2Tx	25.5	25.4	25.5	25.1	25.1	25.3	27.0	27.0	27.2	26.9	27.1
GSM1900. GPRS 3Tx	23.7	23.9	23.7	23.8	23.5	23.5	24.8	24.9	24.8	24.9	25.0
GSM1900. GPRS 4Tx	22.4	22.3	22.5	22.4	22.7	22.7	23.6	23.9	23.8	23.5	23.8
GSM1900. EDGE 1Tx	26.2	25.8	26.2	26.0	26.0	25.9	25.8	26.2	25.7	25.8	26.2
GSM1900. EDGE 2Tx	21.8	21.9	22.1	21.8	22.0	22.1	24.0	23.8	23.5	23.5	23.9
GSM1900. EDGE 3Tx	20.8	20.9	20.9	20.6	20.8	21.1	22.1	22.2	22.0	22.1	22.1
GSM1900. EDGE 4Tx	19.9	19.6	19.9	19.9	19.8	19.8	20.9	20.9	20.8	21.0	21.0
WCDMA II	19.6	19.8	19.5	19.3	19.4	19.5	24.3	24.3	24.5	24.3	24.3
WCDMA IV	20.1	20.4	20.3	20.3	20.4	20.5	24.5	24.2	24.2	24.3	24.4
LTE 2	19.2	19.3	19.4	19.4	19.4	19.4	24.4	24.4	24.0	24.2	24.3
LTE 4	20.2	20.0	19.9	20.2	20.0	19.8	24.1	24.0	24.0	24.2	23.9
LTE 7	21.0	20.5	20.9	20.6	20.5	20.9	24.0	24.1	23.9	23.7	24.2

Output Power Verification in dBm for EUT Bottom Edge											
Distance (mm)	14	15	16	17	18	19	20	21	22	23	24
GSM1900. GSM	30.2	30.1	29.9	30.0	29.9	30.4	31.4	31.4	31.5	31.1	31.3
GSM1900. GPRS 1Tx	30.2	29.9	29.9	30.3	30.3	30.1	31.5	31.1	31.1	31.3	31.5
GSM1900. GPRS 2Tx	25.2	25.5	25.4	25.4	25.2	25.0	27.4	27.0	27.1	27.4	27.2
GSM1900. GPRS 3Tx	23.5	24.0	23.5	23.5	23.8	23.6	25.1	24.8	24.6	25.1	24.8
GSM1900. GPRS 4Tx	22.6	22.8	22.3	22.6	22.6	22.3	23.4	23.8	23.8	23.8	23.7
GSM1900. EDGE 1Tx	25.9	26.2	26.3	25.8	26.2	26.3	26.0	26.1	26.1	26.2	26.2
GSM1900. EDGE 2Tx	22.0	21.9	22.3	22.1	22.1	21.8	23.9	23.6	23.7	24.0	24.0
GSM1900. EDGE 3Tx	21.0	20.6	20.7	20.6	21.0	20.6	22.3	22.1	22.2	22.1	22.3
GSM1900. EDGE 4Tx	19.8	19.5	19.8	19.5	20.0	20.0	21.3	21.1	20.9	20.9	20.8
WCDMA II	19.7	19.6	19.6	19.3	19.6	19.7	24.5	24.2	24.3	24.0	24.2
WCDMA IV	20.0	20.2	20.3	20.3	20.3	20.4	24.1	24.3	24.4	24.1	24.1
LTE 2	19.2	19.5	19.4	19.6	19.3	19.4	24.0	24.3	24.4	24.3	24.3
LTE 4	20.2	20.0	19.8	19.9	20.3	20.2	23.8	24.1	23.8	23.9	23.8
LTE 7	20.8	20.9	20.5	20.7	20.6	20.6	23.9	23.8	23.7	23.8	24.2

Output Power Verification in dBm for EUT Front Face											
Distance (mm)	9	10	11	12	13	14	15	16	17	18	19
GSM1900. GSM	29.9	30.3	29.9	30.3	30.3	30.0	31.4	31.0	31.5	31.5	31.3
GSM1900. GPRS 1Tx	30.0	29.9	30.1	30.3	30.4	30.1	31.5	31.0	31.1	31.2	31.0
GSM1900. GPRS 2Tx	25.2	25.4	25.1	25.3	25.4	25.1	27.0	26.9	27.0	27.0	27.3
GSM1900. GPRS 3Tx	23.6	23.5	23.8	23.5	23.7	24.0	24.7	24.6	25.1	24.8	24.6
GSM1900. GPRS 4Tx	22.7	22.6	22.6	22.7	22.5	22.8	23.6	23.8	23.5	23.7	23.7
GSM1900. EDGE 1Tx	25.9	26.2	26.2	26.2	25.8	26.2	26.1	25.9	25.7	26.2	25.7
GSM1900. EDGE 2Tx	22.0	21.9	22.2	22.2	22.3	21.9	23.6	23.9	24.0	23.6	23.7
GSM1900. EDGE 3Tx	20.6	20.9	20.6	21.1	20.8	20.7	22.1	22.3	22.3	22.2	21.9
GSM1900. EDGE 4Tx	19.7	19.5	19.6	20.0	19.9	20.0	21.3	21.3	21.3	20.9	20.8
WCDMA II	19.7	19.3	19.4	19.3	19.7	19.3	24.2	24.3	24.0	24.3	24.1
WCDMA IV	20.1	20.2	20.3	20.4	20.2	20.5	24.3	24.4	24.1	24.0	24.3
LTE 2	19.2	19.2	19.3	19.3	19.3	19.6	24.1	24.2	24.4	24.2	24.5
LTE 4	20.0	20.1	20.3	20.0	19.8	20.2	23.8	24.2	24.2	23.9	24.0
LTE 7	20.7	20.6	20.9	20.6	20.9	20.5	24.1	23.9	23.7	23.7	23.9

FCC SAR Test Report

Proximity Sensor Coverage (KDB 616217 D04 §6.3)

Since the proximity sensor is collocated with antenna in one component, the procedure for proximity sensor coverage is not required.

Proximity Sensor Tilt Angle Influences(KDB 616217 D04 §6.4)

The proximity sensor tilt angle influence was determined per KDB 616217 for applicable edge. Summary for proximity sensor tilt angle influence is shown in below.

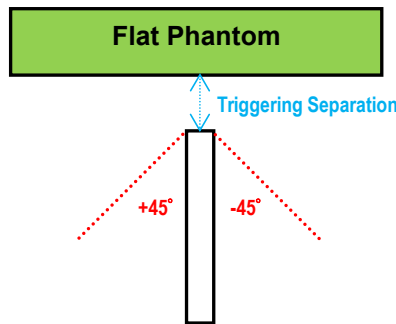

Orientation	Separation Distance (mm)	Tilt Angle										
		-45°	-40°	-30°	-20°	-10°	0°	10°	20°	30°	40°	45°
Bottom Edge	18	On	On	On	On	On	On	On	On	On	On	On

Summary for Proximity Sensor Triggering Test

According to the procedures noticed in KDB 616217 D04, the proximity sensor triggering distance is 18 mm for EUT Rear Face and 19 mm for EUT Bottom Side and 14 mm for EUT Front Face. The separation distance of 18 mm determined by the smallest triggering distance on Bottom Side is used to access the tilt angle influence and the sensor does not release during ± 45 degree. Therefore, the smallest separation distance for tilt angle influence is 17 mm for the Bottom Side. The conservation triggering distances based on the separation distance for the sensor trigger / not triggered as EUT with power reduction at 0 mm.

The power reduction is depends on the proximity sensor input. For a steady SAR test, the power reduction was enabled or disabled manually by engineering software during SAR testing.

FCC SAR Test Report

<Connections between EUT and System Simulator>

For WWAN SAR testing, the EUT was linked and controlled by base station emulator. Communication between the EUT and the emulator was established by air link. The distance between the EUT and the communicating antenna of the emulator is larger than 50 cm and the output power radiated from the emulator antenna is at least 30 dB smaller than the output power of EUT. The EUT was set from the emulator to radiate maximum output power during SAR testing.

<Considerations Related to GSM / GPRS / EDGE for Setup and Testing>

The maximum multi-slot capability supported by this device is as below.

1. This EUT is class B device
2. This EUT supports GPRS multi-slot class 12 (max. uplink: 4, max. downlink: 4, total timeslots: 5)
3. This EUT supports EDGE multi-slot class 12 (max. uplink: 4, max. downlink: 4, total timeslots: 5)

For GSM850 frequency band, the power control level is set to 5 for GSM mode and GPRS (GMSK: CS1), and set to 8 for EDGE (GMSK: MCS1, 8PSK: MCS9). For GSM1900 frequency band, the power control level is set to 0 for GSM mode and GPRS (GMSK: CS1), and set to 2 for EDGE (GMSK: MCS1, 8PSK: MCS9).

SAR test reduction for GPRS and EDGE modes is determined by the source-based time-averaged output power specified for production units, including tune-up tolerance. The data mode with highest specified time-averaged output power should be tested for SAR compliance in the applicable exposure conditions. For modes with the same specified maximum output power and tolerance, the higher number time-slot configuration should be tested.

<Considerations Related to WCDMA for Setup and Testing>

WCDMA Handsets Head SAR

SAR for next to the ear head exposure is measured using a 12.2 kbps RMC with TPC bits configured to all "1's". The 3G SAR test reduction procedure is applied to AMR configurations with 12.2 kbps RMC as the primary mode.

WCDMA Handsets Body-worn SAR

SAR for body-worn configurations is measured using a 12.2 kbps RMC with TPC bits configured to all "1's". The 3G SAR test reduction procedure is applied to other spreading codes and multiple DPDCH_n configurations supported by the handset with 12.2 kbps RMC as the primary mode.

Handsets with Release 5 HSDPA

The 3G SAR test reduction procedure is applied to HSDPA body-worn configurations with 12.2 kbps RMC as the primary mode. Otherwise, SAR is measured for HSDPA using the HSDPA body SAR procedures in the "Release 5 HSDPA Data Devices", for the highest reported SAR body-worn exposure configuration in 12.2 kbps RMC. Handsets with both HSDPA and HSUPA are tested according to Release 6 HSPA test procedures.

Handsets with Release 6 HSUPA

The 3G SAR test reduction procedure is applied to HSPA (HSUPA/HSDPA with RMC) body-worn configurations with 12.2 kbps RMC as the primary mode. Otherwise, SAR is measured for HSPA using the HSPA body SAR procedures in the “Release 6 HSPA Data Devices”, for the highest reported body-worn exposure SAR configuration in 12.2 kbps RMC. When VOIP is applicable for next to the ear head exposure in HSPA, the 3G SAR test reduction procedure is applied to HSPA with 12.2 kbps RMC as the primary mode; otherwise, the same HSPA configuration used for body-worn measurements is tested for next to the ear head exposure.

Release 5 HSDPA Data Devices

The 3G SAR test reduction procedure is applied to body SAR with 12.2 kbps RMC as the primary mode. Otherwise, body SAR for HSDPA is measured using an FRC with H-Set 1 in Sub-test 1 and a 12.2 kbps RMC configured in Test Loop Mode 1, for the highest reported SAR configuration in 12.2 kbps RMC without HSDPA. HSDPA is configured according to the applicable UE category of a test device. The number of HS-DSCH/HS-PDSCHs, HARQ processes, minimum inter-TTI interval, transport block sizes and RV coding sequence are defined by the H-set. To maintain a consistent test configuration and stable transmission conditions, QPSK is used in the H-set for SAR testing. HS-DPCCH should be configured with a CQI feedback cycle of 4 ms and a CQI repetition factor of 2 to maintain a constant rate of active CQI slots. DPCCH and DPDCH gain factors (β_c , β_d), and HS-DPCCH power offset parameters (Δ_{ACK} , Δ_{NACK} , Δ_{CQI}) are set according to values indicated in below. The CQI value is determined by the UE category, transport block size, number of HS-PDSCHs and modulation used in the H-set.

Sub-test	β_c	β_d	β_d (SF)	β_c/β_d	$\beta_{HS}^{(1/2)}$	CM ⁽³⁾ (dB)	MPR ⁽³⁾ (dB)
1	2/15	15/15	64	2/15	4/15	0.0	0.0
2	12/15 ⁽⁴⁾	15/15 ⁽⁴⁾	64	12/15 ⁽⁴⁾	24/15	1.0	0.0
3	15/15	8/15	64	15/8	30/15	1.5	0.5
4	15/15	4/15	64	15/4	30/15	1.5	0.5

Note 1: Δ_{ACK} , Δ_{NACK} and Δ_{CQI} = 30/15 with β_{HS} = 30/15* β_c .
 Note 2: For the HS-DPCCH power mask requirement test in clause 5.2C, 5.7A, and the Error Vector Magnitude (EVM) with HS-DPCCH test in clause 5.13.1A, and HSDPA EVM with phase discontinuity in clause 5.13.1AA, Δ_{ACK} and Δ_{NACK} = 30/15 with β_{HS} = 30/15* β_c , and Δ_{CQI} = 24/15 with β_{HS} = 24/15* β_c .
 Note 3: CM = 1 for β_c/β_d = 12/15, β_{HS}/β_c = 24/15. For all other combinations of DPDCH, DPCCH and HS-DPCCH the MPR is based on the relative CM difference. This is applicable for only UEs that support HSDPA in release 6 and later releases.
 Note 4: For subtest 2 the β_c/β_d ratio of 12/15 for the TFC during the measurement period (TF1, TF0) is achieved by setting the signalled gain factors for the reference TFC (TF1, TF1) to β_c = 11/15 and β_d = 15/15.

FCC SAR Test Report

Release 6 HSPA Data Devices

The 3G SAR test reduction procedure is applied to body SAR with 12.2 kbps RMC as the primary mode. Otherwise, body SAR for HSPA is measured with E-DCH Sub-test 5, using H-Set 1 and QPSK for FRC and a 12.2 kbps RMC configured in Test Loop Mode 1 and power control algorithm 2, according to the highest reported body SAR configuration in 12.2 kbps RMC without HSPA. When VOIP applies to head exposure, the 3G SAR test reduction procedure is applied with 12.2 kbps RMC as the primary mode. Otherwise, the same HSPA configuration used for body SAR measurements are applied to head exposure testing. Due to inner loop power control requirements in HSPA, a communication test set is required for output power and SAR tests. The 12.2 kbps RMC, FRC H-set 1 and E-DCH configurations for HSPA are configured according to the β values indicated in below.

Sub-test	β_c	β_d	β_d (SF)	β_c/β_d	$\beta_{HS}^{(1)}$	β_{ec}	$\beta_{ed}^{(4)(5)}$	β_{ed} (SF)	β_{ed} (Codes)	CM ⁽²⁾ (dB)	MPR ⁽²⁾⁽⁶⁾ (dB)	AG ⁽⁵⁾ Index	E-TFCI
1	11/15 ⁽³⁾	15/15 ⁽³⁾	64	11/15 ⁽³⁾	22/15	209/225	1309/225	4	1	1.0	0.0	20	75
2	6/15	15/15	64	6/15	12/15	12/15	94/75	4	1	3.0	2.0	12	67
3	15/15	9/15	64	15/9	30/15	30/15	$\beta_{ed1}: 47/15$ $\beta_{ed2}: 47/15$	4 4	2	2.0	1.0	15	92
4	2/15	15/15	64	2/15	4/15	2/15	56/75	4	1	3.0	2.0	17	71
5	15/15	0	-	-	5/15	5/15	47/15	4	1	1.0	0.0	12	67

Note 1: For sub-test 1 to 4, Δ_{ACK} , Δ_{NACK} and $\Delta_{CQI} = 30/15$ with $\beta_{HS} = 30/15 * \beta_c$. For sub-test 5, Δ_{ACK} , Δ_{NACK} and $\Delta_{CQI} = 5/15$ with $\beta_{HS} = 5/15 * \beta_c$.
 Note 2: CM = 1 for $\beta_c/\beta_d = 12/15$, $\beta_{HS}/\beta_c = 24/15$. For all other combinations of DPDCH, DPCCCH, HS-DPCCCH, E-DPDCH and E-DPCCCH the MPR is based on the relative CM difference.
 Note 3: For subtest 1 the β_c/β_d ratio of 11/15 for the TFC during the measurement period (TF1, TF0) is achieved by setting the signalled gain factors for the reference TFC (TF1, TF1) to $\beta_c = 10/15$ and $\beta_d = 15/15$.
 Note 4: In case of testing by UE using E-DPDCH Physical Layer category 1, Sub-test 3 is omitted according to TS25.306 Table 5.1g.
 Note 5: β_{ed} can not be set directly; it is set by Absolute Grant Value.
 Note 6: For subtests 2, 3 and 4, UE may perform E-DPDCH power scaling at max power which could results in slightly smaller MPR values.

HSPA+ SAR Guidance

The 3G SAR test reduction procedure is applied to HSPA+(uplink) with 12.2 kbps RMC as the primary mode. Otherwise, when SAR is required for Rel. 6 HSPA, SAR is required for Rel. 7 HSPA+. Power is measured for HSPA+ that supports uplink 16QAM according to configurations in Table C.11.1.4 of 3GPP TS 34.121-1 to determine SAR test reduction.

Sub-test	$\beta_c^{(3)}$	β_d	$\beta_{HS}^{(1)}$	β_{ec}	$\beta_{ed}^{(4)}$ (2xSF2)	$\beta_{ed}^{(4)}$ (2xSF4)	CM ⁽²⁾ (dB)	MPR ⁽²⁾ (dB)	AG ⁽⁴⁾ Index	E-TFCI ⁽⁵⁾	E-TFCI (boost)
1	1	0	30/15	30/15	$\beta_{ed1}: 30/15$ $\beta_{ed2}: 30/15$	$\beta_{ed3}: 24/15$ $\beta_{ed4}: 24/15$	3.5	2.5	14	105	105

Note 1: Δ_{ACK} , Δ_{NACK} and $\Delta_{CQI} = 30/15$ with $\beta_{HS} = 30/15 * \beta_c$.
 Note 2: CM = 3.5 and the MPR is based on the relative CM difference, MPR = MAX(CM-1,0).
 Note 3: DPDCH is not configured, therefore the β_c is set to 1 and $\beta_d = 0$ by default.
 Note 4: β_{ed} can not be set directly; it is set by Absolute Grant Value.
 Note 5: All the sub-tests require the UE to transmit 2SF2+2SF4 16QAM EDCH and they apply for UE using E-DPDCH category 7. E-DCH TTI is set to 2ms TTI and E-DCH table index = 2. To support these E-DCH configurations DPDCH is not allocated. The UE is signalled to use the extrapolation algorithm.

DC-HSDPA SAR Guidance

The 3G SAR test reduction procedure is applied to DC-HSDPA with 12.2 kbps RMC as the primary mode. Otherwise, when SAR is required for Rel. 5 HSDPA, SAR is required for Rel. 8 DC-HSDPA. Power is measured for DC-HSDPA according to the H-Set 12, FRC configuration in Table C.8.1.12 of 3GPP TS 34.121-1 to determine SAR test reduction. A primary and a secondary serving HS-DSCH Cell are required to perform the power measurement and for the results to be acceptable.

<Considerations Related to LTE for Setup and Testing>

This device contains LTE transmitter which follows 3GPP standards, is category 3, supports both QPSK and QAM modulations, and supported LTE band and channel bandwidth is listed in below. The output power was tested per 3GPP TS 36.521-1 maximum transmit procedures for both QPSK and QAM modulation. The results please refer to section 4.6 of this report.

EUT Supported LTE Band and Channel Bandwidth						
LTE Band	BW 1.4 MHz	BW 3 MHz	BW 5 MHz	BW 10 MHz	BW 15 MHz	BW 20 MHz
2	V	V	V	V	V	V
4	V	V	V	V	V	V
5	V	V	V	V		
7			V	V	V	V
38			V	V	V	V

The LTE maximum power reduction (MPR) in accordance with 3GPP TS 36.101 is active all times during LTE operation. The allowed MPR for the maximum output power is specified in below.

Modulation	Channel Bandwidth / RB Configurations						LTE MPR Setting (dB)
	BW 1.4 MHz	BW 3 MHz	BW 5 MHz	BW 10 MHz	BW 15 MHz	BW 20 MHz	
QPSK	> 5	> 4	> 8	> 12	> 16	> 18	1
16QAM	<= 5	<= 4	<= 8	<= 12	<= 16	<= 18	1
16QAM	> 5	> 4	> 8	> 12	> 16	> 18	2
64QAM	<= 5	<= 4	<= 8	<= 12	<= 16	<= 18	2

Note: MPR is according to the standard and implemented in the circuit (mandatory).

In addition, the device is compliant with additional maximum power reduction (A-MPR) requirements defined in 3GPP TS 36.101 section 6.2.4 that was disabled for all FCC compliance testing.

During LTE SAR testing, the related parameters of operating band, channel bandwidth, uplink channel number, modulation type, and RB was set in base station simulator. When the EUT has registered and communicated to base station simulator, the simulator set to make EUT transmitting the maximum radiated power.

FCC SAR Test Report

TDD-LTE Setup Configurations

According to KDB 941225 D05, SAR testing for TDD-LTE device must be tested using a fixed periodic duty factor according to the highest transmission duty factor implemented for the device and supported by the defined 3GPP TDD-LTE configurations. The TDD-LTE of this device supports frame structure type 2 defined in 3GPP TS 36.211 section 4.2, and the frame structure configuration can be referred to below.

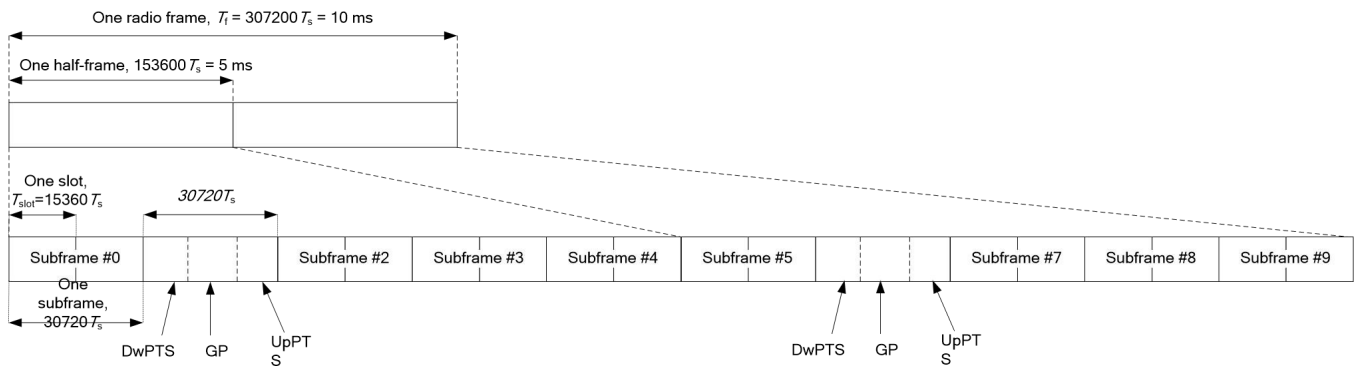

3GPP TS 36.211 Figure 4.2-1: Frame Structure Type 2

Special Subframe Configuration	Normal Cyclic Prefix in Downlink			Extended Cyclic Prefix in Downlink		
	DwPTS	UpPTS		DwPTS	UpPTS	
		Normal Cyclic Prefix in Uplink	Extended Cyclic Prefix in Uplink		Normal Cyclic Prefix in Uplink	Extended Cyclic Prefix in Uplink
0	6592·Ts	2192·Ts	2560·Ts	7680·Ts	2192·Ts	2560·Ts
1	19760·Ts			20480·Ts		
2	21952·Ts			23040·Ts		
3	24144·Ts			25600·Ts		
4	26336·Ts	4384·Ts	5120·Ts	7680·Ts	4384·Ts	5120·Ts
5	6592·Ts			20480·Ts		
6	19760·Ts			23040·Ts		
7	21952·Ts			12800·Ts		
8	24144·Ts	-	-	-	-	-
9	13168·Ts	-	-	-	-	-

3GPP TS 36.211 Table 4.2-1: Configuration of Special Subframe

Uplink-Downlink Configuration	Downlink-to-Uplink Switch-Point Periodicity	Subframe Number										
		0	1	2	3	4	5	6	7	8	9	
0	5 ms	D	S	U	U	U	D	S	U	U	U	
1	5 ms	D	S	U	U	D	D	S	U	U	D	
2	5 ms	D	S	U	D	D	D	S	U	D	D	
3	10 ms	D	S	U	U	U	D	D	D	D	D	
4	10 ms	D	S	U	U	D	D	D	D	D	D	
5	10 ms	D	S	U	D	D	D	D	D	D	D	
6	5 ms	D	S	U	U	U	D	S	U	U	D	

3GPP TS 36.211 Table 4.2-2: Uplink-Downlink Configurations

FCC SAR Test Report

The variety of different TD-LTE uplink-downlink configurations allows a network operator to allocate the network's capacity between uplink and downlink traffic to meet the needs of the network. The uplink duty cycle of these seven configurations can readily be computed and shown in below.

UL-DL Configuration	0	1	2	3	4	5	6
Highest Duty-Cycle	63.33%	43.33%	23.33%	31.67%	21.67%	11.67%	53.33%

Considering the highest transmission duty cycle, TDD-LTE was tested using Uplink-Downlink Configuration 0 with 6 uplink subframe and 2 special subframe. The special subframe was set to special subframe configuration 7 using extended cyclic prefix uplink. Therefore, SAR testing for TDD-LTE was performed at the maximum output power with highest transmission duty cycle of 63.33%.

LTE Downlink Carrier Aggregation(CA)Setup Configurations

LTE Carrier Aggregation (CA) was defined in 3GPP release 10 and higher. The LTE device in CA mode has one Primary Component Carrier (PCC) and one or more Secondary Component Carriers (SCC). PCC acts as the anchor carrier and can optionally cross-schedule data transmission on SCC. The RRC connection is only handled by one cell, the PCC for downlink and uplink communications. After making a data connection to the PCC, the LTE device adds the SCC on the downlink only. All uplink communications and acknowledgements remain identical to release 8 specifications on the PCC. The combinations of downlink carrier aggregation supported by this device are listed in below.

LTE CA Configurations and Bandwidth Combination Sets defined for Intra-Band Contiguous CA

Downlink CA Configuration	Component carriers in order of increasing carrier frequency			Maximum Aggregated Bandwidth (MHz)	Bandwidth Combination Set
	Channel bandwidths for carrier-1 (MHz)	Channel bandwidths for carrier-2 (MHz)	Channel bandwidths for carrier-3 (MHz)		
CA_7C	15	15		40	0
	20	20			
	10	20		40	1
	15	15, 20			
	20	10, 15, 20			
CA_38C	15	10, 15		40	2
	20	15, 20			
	15	15		40	0

LTE CA Configurations and Bandwidth Combination Sets defined for Inter-Band CA (Two Bands)

Downlink CA Configuration	LTE Bands	Channel Bandwidths for Carrier (MHz)	Maximum Aggregated Bandwidth (MHz)	Bandwidth Combination Set
CA_5A-7A	5	1.4, 3, 5, 10	30	0
	7	10, 15, 20		
	5	5, 10	30	1
	7	10, 15, 20		

FCC SAR Test Report

<SAR Test Exclusion Evaluations for LTE Downlink CA>

According to Nov 2017 TCB Workshop, SAR test exclusion for LTE downlink Carrier Aggregation is determined by power measurements according to the number of component carriers (CCs) supported by the product implementation. The downlink Carrier Aggregation configurations are tabulated in separate columns. DL CA would be listed in the columns corresponding to Intra Band contiguous, Intra Band Non-contiguous. The CA/CC combinations in each columns are sorted so that frequency bands listed in subsequent columns on each row are ascending subsets, as following LTE Downlink CA table and LTE Downlink CA table ; i.e., columns to the right correspond to increasing number of frequency bands and CCs.

LTE Downlink CA-Configure	Intra Band	Inter Band
	Contiguous	2 Bands / 2CC
	7C	5A-7A
	38C	

- Only yellow highlighted cells need power measurement.

LTE Uplink Carrier Aggregation (CA) Setup Configurations

This device supports LTE uplink CA for band 1/3/7/38/40 with a maximum of two 20 MHz carrier components in the uplink. The maximum output power for uplink intra-band contiguous CA specified in Table 6.2.2A-1 of 3GPP TS 36.101 is the same as single carrier specified in Table 6.2.2-1 of 3GPP TS 36.101. In Table 6.2.3A-1 of 3GPP TS 36.101, the MPR (maximum power reduction) for several dB is allowed due to modulation and contiguously aggregated transmit bandwidth configuration. All the RF parameters in this device have followed above 3GPP criteria.

LTE CA Configurations and Bandwidth Combination Sets defined for Intra-Band Contiguous CA

Uplink CA Configuration	Component carriers in order of increasing carrier frequency			Maximum Aggregated Bandwidth (MHz)	Bandwidth Combination Set
	Channel bandwidths for carrier-1 (MHz)	Channel bandwidths for carrier-2 (MHz)	Channel bandwidths for carrier-3 (MHz)		
CA_7C	15	15		40	0
	20	20			
	10	20		40	1
	15	15, 20			
	20	10, 15, 20			
CA_38C	15	10, 15		40	2
	20	15, 20			
	15	15		40	0

<Considerations Related to WLAN for Setup and Testing>

In general, various vendor specific external test software and chipset based internal test modes are typically used for SAR measurement. These chipset based test mode utilities are generally hardware and manufacturer dependent, and often include substantial flexibility to reconfigure or reprogram a device. A Wi-Fi device must be configured to transmit continuously at the required data rate, channel bandwidth and signal modulation, using the highest transmission duty factor supported by the test mode tools for SAR measurement. The test frequencies established using test mode must correspond to the actual channel frequencies. When 802.11 frame gaps are accounted for in the transmission, a maximum transmission duty factor of 92 - 96% is typically achievable in most test mode configurations. A minimum transmission duty factor of 85% is required to avoid certain hardware and device implementation issues related to wide range SAR scaling. In addition, a periodic transmission duty factor is required for current generation SAR systems to measure SAR correctly. The reported SAR must be scaled to 100% transmission duty factor to determine compliance at the maximum tune-up tolerance limit.

According to KDB 248227 D01, this device has installed WLAN engineering testing software which can provide continuous transmitting RF signal. During WLAN SAR testing, this device was operated to transmit continuously at the maximum transmission duty with specified transmission mode, operating frequency, lowest data rate, and maximum output power.

Initial Test Configuration

An initial test configuration is determined for OFDM transmission modes in 2.4 GHz and 5 GHz bands according to the channel bandwidth, modulation and data rate combination(s) with the highest maximum output power specified for production units in each standalone and aggregated frequency band. When the same maximum power is specified for multiple transmission modes in a frequency band, the largest channel bandwidth, lowest order modulation, lowest data rate and lowest order 802.11a/g/n/ac mode is used for SAR measurement, on the highest measured output power channel in the initial test configuration, for each frequency band.

Subsequent Test Configuration

SAR measurement requirements for the remaining 802.11 transmission mode configurations that have not been tested in the initial test configuration are determined separately for each standalone and aggregated frequency band, in each exposure condition, according to the maximum output power specified for production units. Additional power measurements may be required to determine if SAR measurements are required for subsequent highest output power channels in a subsequent test configuration. When the highest reported SAR for the initial test configuration according to the initial test position or fixed exposure position requirements, is adjusted by the ratio of the subsequent test configuration to initial test configuration specified maximum output power and the adjusted SAR is ≤ 1.2 W/kg, SAR is not required for that subsequent test configuration.

SAR Test Configuration and Channel Selection

When multiple channel bandwidth configurations in a frequency band have the same specified maximum output power, the initial test configuration is using largest channel bandwidth, lowest order modulation, lowest data rate, and lowest order 802.11 mode (i.e., 802.11a is chosen over 802.11n then 802.11ac or 802.11g is chosen over 802.11n). After an initial test configuration is determined, if multiple test channels have the same measured maximum output power, the channel chosen for SAR measurement is determined according to the following.

- 1) The channel closest to mid-band frequency is selected for SAR measurement.
- 2) For channels with equal separation from mid-band frequency; for example, high and low channels or two mid-band channels, the higher frequency (number) channel is selected for SAR measurement.

Test Reduction for U-NII-1 (5.2 GHz) and U-NII-2A (5.3 GHz) Bands

For devices that operate in both U-NII bands using the same transmitter and antenna(s), SAR test reduction is determined according to the following.

- 1) When the same maximum output power is specified for both bands, begin SAR measurement in U-NII-2A band by applying the OFDM SAR requirements. If the highest reported SAR for a test configuration is ≤ 1.2 W/kg, SAR is not required for U-NII-1 band for that configuration (802.11 mode and exposure condition).
- 2) When different maximum output power is specified for the bands, begin SAR measurement in the band with higher specified maximum output power. The highest reported SAR for the tested configuration is adjusted by the ratio of lower to higher specified maximum output power for the two bands. When the adjusted SAR is ≤ 1.2 W/kg, SAR is not required for the band with lower maximum output power in that test configuration.

<Considerations Related to Bluetooth for Setup and Testing>

This device has installed Bluetooth engineering testing software which can provide continuous transmitting RF signal. During Bluetooth SAR testing, this device was operated to transmit continuously at the maximum transmission duty with specified transmission mode, operating frequency, lowest data rate, and maximum output power.

FCC SAR Test Report

The Bluetooth call box has been used during SAR measurement and the EUT was set to DH5 mode at the maximum output power. Its duty factor was calculated as below and the measured SAR for Bluetooth would be scaled to the 100% transmission duty factor to determine compliance.



Time-domain plot for Bluetooth transmission signal

The duty factor of Bluetooth signal has been calculated as following.

$$\text{Duty Factor} = \text{Pulse Width} / \text{Total Period} = (10.83 - 7.950) / (11.70 - 7.950) = 76.80 \%$$

4.2 EUT Testing Position

According to KDB 648474 D04, handsets are tested for SAR compliance in head, body-worn accessory and other use configurations described in the following subsections.

4.2.1 Head Exposure Conditions

Head exposure is limited to next to the ear voice mode operations. Head SAR compliance is tested according to the test positions defined in IEEE Std 1528-2003 using the SAM phantom illustrated as below.

1. Define two imaginary lines on the handset
 - (a) The vertical centerline passes through two points on the front side of the handset - the midpoint of the width w_t of the handset at the level of the acoustic output, and the midpoint of the width w_b of the bottom of the handset.
 - (b) The horizontal line is perpendicular to the vertical centerline and passes through the center of the acoustic output. The horizontal line is also tangential to the face of the handset at point A.
 - (c) The two lines intersect at point A. Note that for many handsets, point A coincides with the center of the acoustic output; however, the acoustic output may be located elsewhere on the horizontal line. Also note that the vertical centerline is not necessarily parallel to the front face of the handset, especially for clamshell handsets, handsets with flip covers, and other irregularly shaped handsets.

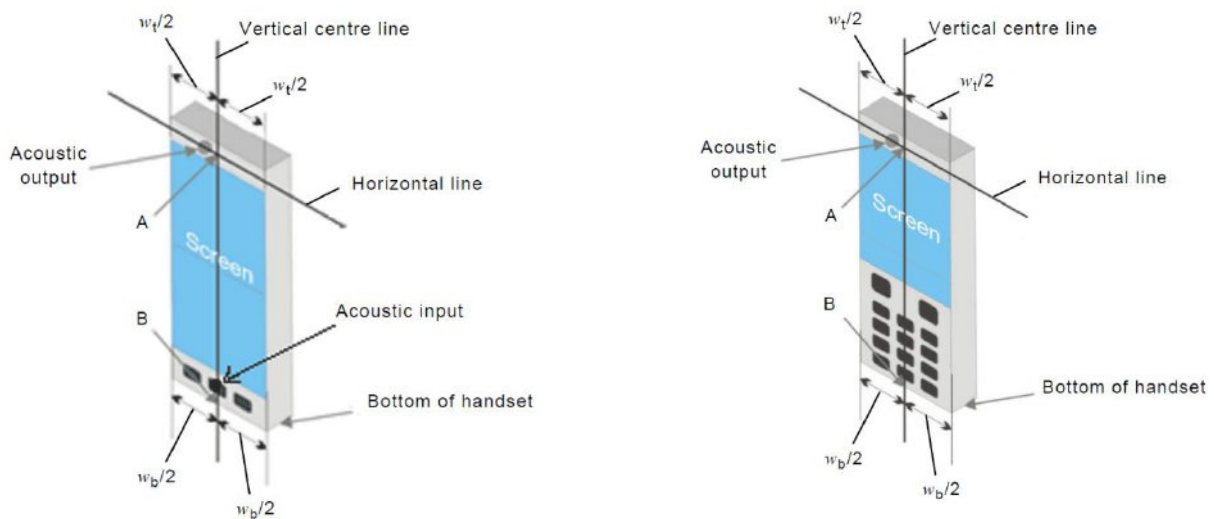

Fig-4.1 Illustration for Handset Vertical and Horizontal Reference Lines

2. Cheek Position

- (a) To position the device with the vertical center line of the body of the device and the horizontal line crossing the center piece in a plane parallel to the sagittal plane of the phantom. While maintaining the device in this plane, align the vertical center line with the reference plane containing the three ear and mouth reference point (M: Mouth, RE: Right Ear, and LE: Left Ear) and align the center of the ear piece with the line RE-LE.
- (b) To move the device towards the phantom with the ear piece aligned with the line LE-RE until the phone touched the ear. While maintaining the device in the reference plane and maintaining the phone contact with the ear, move the bottom of the phone until any point on the front side is in contact with the cheek of the phantom or until contact with the ear is lost (see Fig-4.2).

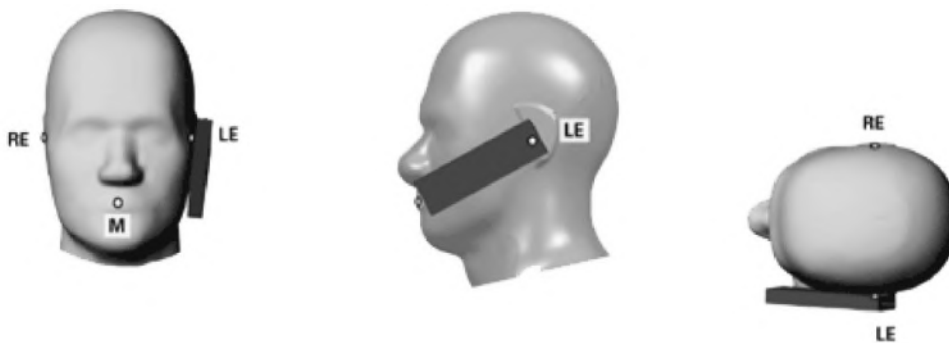

Fig-4.2 Illustration for Cheek Position

3. Tilted Position

- (a) To position the device in the “cheek” position described above.
- (b) While maintaining the device the reference plane described above and pivoting against the ear, moves it outward away from the mouth by an angle of 15 degrees or until contact with the ear is lost (see Fig-4.3).

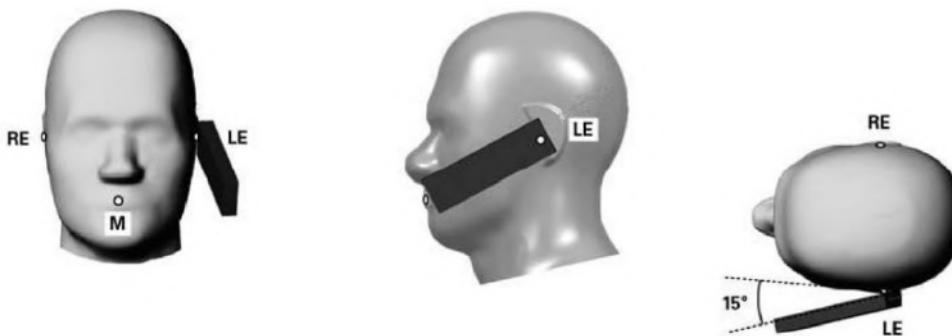

Fig-4.3 Illustration for Tilted Position

4.2.2 Body-worn Accessory Exposure Conditions

Body-worn accessory exposure is typically related to voice mode operations when handsets are carried in body-worn accessories. The body-worn accessory procedures in KDB 447498 D01 are used to test for body-worn accessory SAR compliance, without a headset connected to it. This enables the test results for such configuration to be compatible with that required for hotspot mode when the body-worn accessory test separation distance is greater than or equal to that required for hotspot mode. When the reported SAR for a body-worn accessory, measured without a headset connected to the handset, is $> 1.2 \text{ W/kg}$, the highest reported SAR configuration for that wireless mode and frequency band should be repeated for that body-worn accessory with a headset attached to the handset.

Body-worn accessories that do not contain metallic or conductive components may be tested according to worst-case exposure configurations, typically according to the smallest test separation distance required for the group of body-worn accessories with similar operating and exposure characteristics. All body-worn accessories containing metallic components are tested in conjunction with the host device.

Body-worn accessory SAR compliance is based on a single minimum test separation distance for all wireless and operating modes applicable to each body-worn accessory used by the host, and according to the relevant voice and/or data mode transmissions and operations. If a body-worn accessory supports voice only operations in its normal and expected use conditions, testing of data mode for body-worn compliance is not required.

A conservative minimum test separation distance for supporting off-the-shelf body-worn accessories that may be acquired by users of consumer handsets is used to test for body-worn accessory SAR compliance. This distance is determined by the handset manufacturer, according to the requirements of Supplement C 01-01. Devices that are designed to operate on the body of users using lanyards and straps, or without requiring additional body-worn accessories, will be tested using a conservative minimum test separation distance $\leq 5 \text{ mm}$ to support compliance.

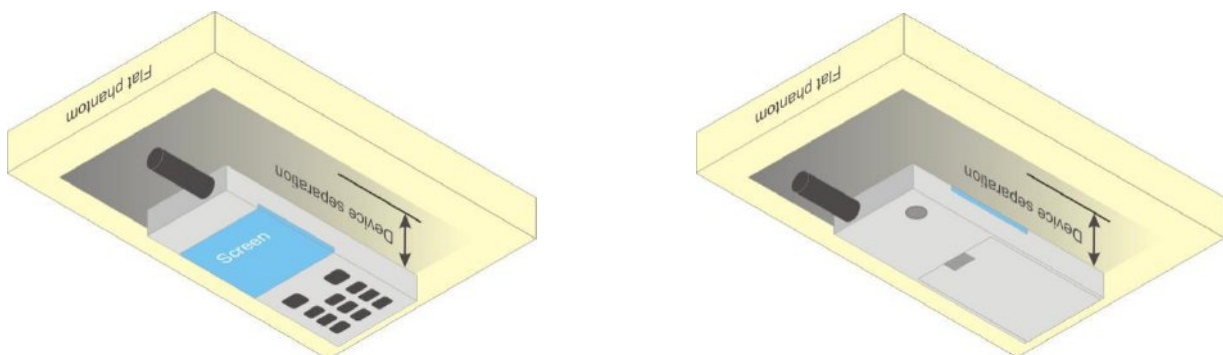
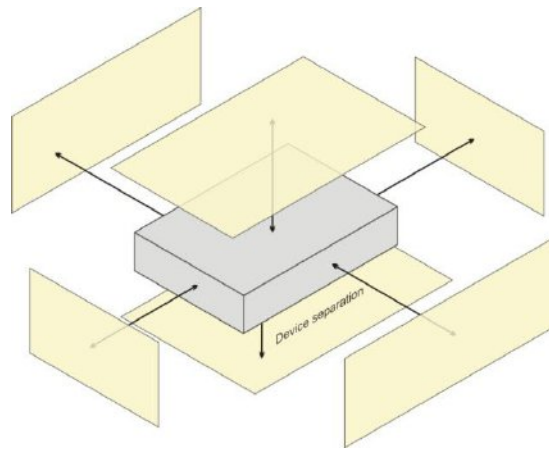

Fig-4.4 Illustration for Body Worn Position

4.2.3 Hotspot Mode Exposure Conditions

For handsets that support hotspot mode operations, with wireless router capabilities and various web browsing functions, the relevant hand and body exposure conditions are tested according to the hotspot SAR procedures in KDB 941225 D06. A test separation distance of 10 mm is required between the phantom and all surfaces and edges with a transmitting antenna located within 25 mm from that surface or edge. When the form factor of a handset is smaller than 9 cm x 5 cm, a test separation distance of 5 mm (instead of 10 mm) is required for testing hotspot mode. When the separation distance required for body-worn accessory testing is larger than or equal to that tested for hotspot mode, in the same wireless mode and for the same surface of the phone, the hotspot mode SAR data may be used to support body-worn accessory SAR compliance for that particular configuration (surface).



Based on the antenna location shown on appendix D of this report, the SAR testing required for hotspot mode is listed as below.

Antenna	Front Face	Rear Face	Left Side	Right Side	Top Side	Bottom Side
WWAN (Main) Ant-0	V	V	V			V
WLAN / BT	V	V		V	V	

4.2.4 Product Specific (Phablet) Exposure Conditions

For smart phones with a display diagonal dimension > 15 cm or an overall diagonal dimension > 16 cm that provide similar mobile web access and multimedia support found in mini-tablets or UMPC mini-tablets that support voice calls next to the ear, the following Phablet procedures should be applied to evaluate SAR compliance for each applicable wireless mode and frequency band. Devices marketed as Phablets, regardless of form factors and operating characteristics must be tested as a Phablet to determine SAR compliance.

1. The normally required head and body-worn accessory SAR test procedures for handsets, including hotspot mode, must be applied.
2. The UMPC mini-tablet procedures must also be applied to test the SAR of all surfaces and edges with an antenna located at ≤ 25 mm from that surface or edge, in direct contact with a flat phantom, for 10-g extremity SAR according to the body-equivalent tissue dielectric parameters in KDB 865664 to address interactive hand use exposure conditions. The UMPC mini-tablet 1-g SAR at 5 mm is not required. When hotspot mode applies, 10-g extremity SAR is required only for the surfaces and edges with hotspot mode 1-g SAR > 1.2 W/kg. The normal tablet procedures in KDB 616217 are required when the over diagonal dimension of the device is > 20 cm. Hotspot mode SAR is not required when normal tablet procedures are applied. Extremity 10-g SAR is also not required for the front (top) surface of large form factor full size tablets. The more conservative tablet SAR results can be used to support the 10-g extremity SAR for Phablet mode.
3. The simultaneous transmission operating configurations applicable to voice and data transmissions for both phone and mini-tablet modes must be taken into consideration separately for 1-g and 10-g SAR to determine the simultaneous transmission SAR test exclusion and measurement requirements for the relevant wireless mode and exposure conditions.

FCC SAR Test Report

4.3 Tissue Verification

The measuring results for tissue simulating liquid are shown as below.

<Head / Body / Hotspot >

Test Date	Frequency (MHz)	Liquid Temp. (°C)	Measured Conductivity (σ)	Measured Permittivity (ϵ_r)	Target Conductivity (σ)	Target Permittivity (ϵ_r)	Conductivity Deviation (%)	Permittivity Deviation (%)
Sep. 06, 2019	835	23.2	0.928	41.992	0.9	41.5	3.11	1.19
Sep. 10, 2019	835	23.1	0.919	41.747	0.9	41.5	2.11	0.60
Sep. 10, 2019	835	23.3	0.92	41.142	0.9	41.5	2.22	-0.86
Sep. 22, 2019	835	23.4	0.923	41.242	0.9	41.5	2.56	-0.62
Sep. 23, 2019	835	23.4	0.913	42.721	0.9	41.5	1.44	2.94
Sep. 06, 2019	1750	23.3	1.32	40.26	1.37	40.1	-3.65	0.40
Sep. 10, 2019	1750	23.1	1.325	40.425	1.37	40.1	-3.28	0.81
Sep. 10, 2019	1750	23.3	1.328	40.493	1.37	40.1	-3.07	0.98
Sep. 13, 2019	1750	23.3	1.318	39.352	1.37	40.1	-3.80	-1.87
Sep. 22, 2019	1750	23.4	1.326	40.434	1.37	40.1	-3.21	0.83
Sep. 06, 2019	1900	23.2	1.456	39.705	1.4	40	4.00	-0.74
Sep. 09, 2019	1900	23.3	1.456	39.753	1.4	40	4.00	-0.62
Sep. 10, 2019	1900	23.1	1.461	39.864	1.4	40	4.36	-0.34
Sep. 10, 2019	1900	23.3	1.459	39.97	1.4	40	4.21	-0.08
Sep. 13, 2019	1900	23.3	1.444	38.836	1.4	40	3.14	-2.91
Sep. 22, 2019	1900	23.4	1.462	39.843	1.4	40	4.43	-0.39
Sep. 10, 2019	2450	23.2	1.881	39.13	1.8	39.2	4.50	-0.18
Sep. 22, 2019	2450	23.4	1.882	38.31	1.8	39.2	4.56	-2.27
Sep. 07, 2019	2600	23.1	2.056	37.803	1.96	39	4.90	-3.07
Sep. 11, 2019	2600	23.2	2.032	37.412	1.96	39	3.67	-4.07
Sep. 14, 2019	2600	23.3	1.978	38.063	1.96	39	0.92	-2.40
Sep. 22, 2019	2600	23.4	2.043	37.882	1.96	39	4.23	-2.87
Sep. 08, 2019	5250	23.2	4.744	36.854	4.71	35.9	0.72	2.66
Sep. 10, 2019	5250	23.2	4.853	35.647	4.71	35.9	3.04	-0.70
Sep. 22, 2019	5250	23.4	4.703	36.115	4.71	35.9	-0.15	0.60
Sep. 11, 2019	5600	23.2	5.224	35.924	5.07	35.5	3.04	1.19
Sep. 22, 2019	5600	23.4	5.129	35.495	5.07	35.5	1.16	-0.01
Sep. 11, 2019	5750	23.2	5.364	35.91	5.22	35.4	2.76	1.44
Sep. 22, 2019	5750	23.4	5.303	35.218	5.22	35.4	1.59	-0.51

<Extremity>

Test Date	Frequency (MHz)	Liquid Temp. (°C)	Measured Conductivity (σ)	Measured Permittivity (ϵ_r)	Target Conductivity (σ)	Target Permittivity (ϵ_r)	Conductivity Deviation (%)	Permittivity Deviation (%)
Sep. 12, 2019	1750	23.2	1.323	38.973	1.37	40.1	-3.43	-2.81
Sep. 22, 2019	1750	23.4	1.326	40.434	1.37	40.1	-3.21	0.83
Sep. 12, 2019	1900	23.2	1.449	38.48	1.4	40	3.50	-3.80
Sep. 22, 2019	1900	23.4	1.462	39.843	1.4	40	4.43	-0.39
Sep. 14, 2019	2600	23.3	1.978	38.063	1.96	39	0.92	-2.40
Sep. 22, 2019	2600	23.4	2.043	37.822	1.96	39	4.23	-3.02
Sep. 08, 2019	5250	23.2	4.744	36.854	4.71	35.9	0.72	2.66
Sep. 22, 2019	5250	23.4	4.703	36.115	4.71	35.9	-0.15	0.60
Sep. 08, 2019	5600	23.2	5.182	36.105	5.07	35.5	2.21	1.70
Sep. 22, 2019	5600	23.4	5.129	35.495	5.07	35.5	1.16	-0.01

Note:

The dielectric properties of the tissue simulating liquid must be measured within 24 hours before the SAR testing and within $\pm 5\%$ of the target values. Liquid temperature during the SAR testing must be within ± 2 °C.

FCC SAR Test Report

4.4 System Validation

The SAR measurement system was validated according to procedures in KDB 865664 D01. The validation status in tabulated summary is as below.

<Head / Body / Hotspot>

Test Date	Probe S/N	Calibration Point	Measured Conductivity (σ)	Measured Permittivity (ϵ_r)	Validation for CW			Validation for Modulation		
					Sensitivity Range	Probe Linearity	Probe Isotropy	Modulation Type	Duty Factor	PAR
Sep. 06, 2019	7537	835	0.928	41.992	Pass	Pass	Pass	GMSK	Pass	N/A
Sep. 10, 2019	3971	835	0.919	41.747	Pass	Pass	Pass	GMSK	Pass	N/A
Sep. 10, 2019	7375	835	0.92	41.142	Pass	Pass	Pass	N/A	N/A	N/A
Sep. 22, 2019	3971	835	0.923	41.242	Pass	Pass	Pass	N/A	N/A	N/A
Sep. 23, 2019	3971	835	0.913	42.721	Pass	Pass	Pass	N/A	N/A	N/A
Sep. 06, 2019	7537	1750	1.32	40.26	Pass	Pass	Pass	N/A	N/A	N/A
Sep. 10, 2019	3971	1750	1.325	40.425	Pass	Pass	Pass	N/A	N/A	N/A
Sep. 10, 2019	7375	1750	1.328	40.493	Pass	Pass	Pass	N/A	N/A	N/A
Sep. 13, 2019	7537	1750	1.318	39.352	Pass	Pass	Pass	N/A	N/A	N/A
Sep. 22, 2019	3971	1750	1.326	40.434	Pass	Pass	Pass	N/A	N/A	N/A
Sep. 06, 2019	7537	1900	1.456	39.705	Pass	Pass	Pass	GMSK	Pass	N/A
Sep. 09, 2019	7375	1900	1.456	39.753	Pass	Pass	Pass	GMSK	Pass	N/A
Sep. 10, 2019	3971	1900	1.461	39.864	Pass	Pass	Pass	N/A	N/A	N/A
Sep. 10, 2019	7375	1900	1.459	39.97	Pass	Pass	Pass	N/A	N/A	N/A
Sep. 13, 2019	7537	1900	1.444	38.836	Pass	Pass	Pass	N/A	N/A	N/A
Sep. 22, 2019	3971	1900	1.462	39.843	Pass	Pass	Pass	N/A	N/A	N/A
Sep. 10, 2019	7537	2450	1.881	39.13	Pass	Pass	Pass	OFDM	N/A	Pass
Sep. 22, 2019	3971	2450	1.882	38.31	Pass	Pass	Pass	OFDM	N/A	Pass
Sep. 07, 2019	7537	2600	2.056	37.803	Pass	Pass	Pass	N/A	N/A	N/A
Sep. 11, 2019	7375	2600	2.032	37.412	Pass	Pass	Pass	N/A	N/A	N/A
Sep. 14, 2019	7537	2600	1.978	38.063	Pass	Pass	Pass	N/A	N/A	N/A
Sep. 22, 2019	3971	2600	2.043	37.882	Pass	Pass	Pass	N/A	N/A	N/A
Sep. 08, 2019	7537	5250	4.744	36.854	Pass	Pass	Pass	OFDM	N/A	Pass
Sep. 10, 2019	7537	5250	4.853	35.647	Pass	Pass	Pass	OFDM	N/A	Pass
Sep. 22, 2019	3971	5250	4.703	36.115	Pass	Pass	Pass	OFDM	N/A	Pass
Sep. 11, 2019	7537	5600	5.224	35.924	Pass	Pass	Pass	OFDM	N/A	Pass
Sep. 22, 2019	3971	5600	5.129	35.495	Pass	Pass	Pass	OFDM	N/A	Pass
Sep. 11, 2019	7537	5750	5.364	35.91	Pass	Pass	Pass	OFDM	N/A	Pass
Sep. 22, 2019	3971	5750	5.303	35.218	Pass	Pass	Pass	OFDM	N/A	Pass

<Extremity>

Test Date	Probe S/N	Calibration Point	Measured Conductivity (σ)	Measured Permittivity (ϵ_r)	Validation for CW			Validation for Modulation		
					Sensitivity Range	Probe Linearity	Probe Isotropy	Modulation Type	Duty Factor	PAR
Sep. 12, 2019	7375	1750	1.323	38.973	Pass	Pass	Pass	N/A	N/A	N/A
Sep. 22, 2019	3971	1750	1.326	40.434	Pass	Pass	Pass	N/A	N/A	N/A
Sep. 12, 2019	7375	1900	1.449	38.48	Pass	Pass	Pass	GMSK	Pass	GMSK
Sep. 22, 2019	3971	1900	1.462	39.843	Pass	Pass	Pass	N/A	N/A	N/A
Sep. 14, 2019	7537	2600	1.978	38.063	Pass	Pass	Pass	N/A	N/A	N/A
Sep. 22, 2019	3971	2600	2.043	37.822	Pass	Pass	Pass	N/A	N/A	N/A
Sep. 08, 2019	7537	5250	4.744	36.854	Pass	Pass	Pass	OFDM	N/A	Pass
Sep. 22, 2019	3971	5250	4.703	36.115	Pass	Pass	Pass	OFDM	N/A	Pass
Sep. 08, 2019	7537	5600	5.182	36.105	Pass	Pass	Pass	OFDM	N/A	Pass
Sep. 22, 2019	3971	5600	5.129	35.495	Pass	Pass	Pass	OFDM	N/A	Pass

FCC SAR Test Report

4.5 System Verification

The measuring result for system verification is tabulated as below.

<Head / Body / Hotspot >

Test Date	Frequency (MHz)	1W Target SAR-1g (W/kg)	Measured SAR-1g (W/kg)	Normalized to 1W SAR-1g (W/kg)	Deviation (%)	Dipole S/N	Probe S/N	DAE S/N
Sep. 06, 2019	835	9.50	2.43	9.72	2.32	4d092	7537	1585
Sep. 10, 2019	835	9.50	2.36	9.44	-0.63	4d092	3971	1431
Sep. 10, 2019	835	9.50	2.32	9.28	-2.32	4d092	7375	1277
Sep. 22, 2019	835	9.50	2.37	9.48	-0.21	4d092	3971	1431
Sep. 23, 2019	835	9.50	2.34	9.36	-1.47	4d092	3971	1431
Sep. 06, 2019	1750	36.10	9.06	36.24	0.39	1023	7537	1585
Sep. 10, 2019	1750	36.10	9.11	36.44	0.94	1023	3971	1431
Sep. 10, 2019	1750	36.10	9.5	38.00	5.26	1023	7375	1277
Sep. 13, 2019	1750	36.10	8.71	34.84	-3.49	1023	7537	1585
Sep. 22, 2019	1750	36.10	9.12	36.48	1.05	1023	3971	1431
Sep. 06, 2019	1900	40.20	10.7	42.80	6.47	5d036	7537	1585
Sep. 09, 2019	1900	40.20	10.2	40.80	1.49	5d036	7375	1277
Sep. 10, 2019	1900	40.20	10.1	40.40	0.50	5d036	3971	1431
Sep. 10, 2019	1900	40.20	9.63	38.52	-4.18	5d036	7375	1277
Sep. 13, 2019	1900	40.20	10.5	42.00	4.48	5d036	7537	1585
Sep. 22, 2019	1900	40.20	10.1	40.40	0.50	5d036	3971	1431
Sep. 10, 2019	2450	53.10	13.2	52.80	-0.56	835	7537	1585
Sep. 22, 2019	2450	53.10	13.3	53.20	0.19	835	3971	1431
Sep. 07, 2019	2600	58.10	15.1	60.40	3.96	1058	7537	1585
Sep. 11, 2019	2600	58.10	14.8	59.20	1.89	1058	7375	1277
Sep. 14, 2019	2600	58.10	14.5	58.00	-0.17	1058	7537	1585
Sep. 22, 2019	2600	58.10	14	56.00	-3.61	1058	3971	1431
Sep. 08, 2019	5250	80.70	8.06	80.60	-0.12	1019	7537	1585
Sep. 10, 2019	5250	80.70	7.88	78.80	-2.35	1019	7537	1585
Sep. 22, 2019	5250	80.70	8.01	80.10	-0.74	1019	3971	1431
Sep. 11, 2019	5600	85.80	8.79	87.90	2.45	1019	7537	1585
Sep. 22, 2019	5600	85.80	8.74	87.40	1.86	1019	3971	1431
Sep. 11, 2019	5750	81.50	8.16	81.60	0.12	1019	7537	1585
Sep. 22, 2019	5750	81.50	8.15	81.50	0.00	1019	3971	1431

FCC SAR Test Report

<Extremity>

Test Date	Frequency (MHz)	1W Target SAR-1g (W/kg)	Measured SAR-1g (W/kg)	Normalized to 1W SAR-1g (W/kg)	Deviation (%)	Dipole S/N	Probe S/N	DAE S/N
Sep. 12, 2019	1750	18.90	4.63	18.52	-2.01	1023	7375	1277
Sep. 22, 2019	1750	18.90	4.82	19.28	2.01	1023	3971	1431
Sep. 12, 2019	1900	20.90	5.48	21.92	4.88	5d036	7375	1277
Sep. 22, 2019	1900	20.90	5.26	21.04	0.67	5d036	3971	1431
Sep. 14, 2019	2600	26.00	6.51	26.04	0.15	1058	7537	1585
Sep. 22, 2019	2600	26.00	6.31	25.24	-2.92	1058	3971	1431
Sep. 08, 2019	5250	23.20	2.31	23.10	-0.43	1019	7537	1585
Sep. 22, 2019	5250	23.20	2.32	23.20	0.00	1019	3971	1431
Sep. 08, 2019	5600	24.50	2.45	24.50	0.00	1019	7537	1585
Sep. 22, 2019	5600	24.50	2.49	24.90	1.63	1019	3971	1431

Note:

Comparing to the reference SAR value provided by SPEAG, the validation data should be within its specification of 10 %. The result indicates the system check can meet the variation criterion and the plots can be referred to Appendix A of this report.

4.6 Maximum Output Power

4.6.1 Maximum Target Conducted Power

The maximum conducted average power (Unit: dBm) including tune-up tolerance is shown as below.

Mode		WWAN Ant	
		Head Body-worn w/ Sensor Off Hotspot w/ Sensor Off Extremity w/ Sensor Off	
2G Band	Power Reduction Scenario	Full Power	Full Power
	Tune-up Limit (dBm)	Maximum Burst-Averaged Output Power	Maximum Frame-Averaged Output Power
GSM850	GSM (GMSK, 1Tx-slot)	33.50	24.50
	GPRS (GMSK, 1Tx-slot)	33.50	24.50
	GPRS (GMSK, 2Tx-slot)	31.00	25.00
	GPRS (GMSK, 3Tx-slot)	29.00	24.74
	GPRS (GMSK, 4Tx-slot)	28.00	25.00
	EDGE (8PSK, 1Tx-slot)	28.50	19.50
	EDGE (8PSK, 2Tx-slot)	25.50	19.50
	EDGE (8PSK, 3Tx-slot)	24.00	19.74
	EDGE (8PSK, 4Tx-slot)	23.50	20.50

Mode		WWAN Ant					
		Head Body-worn w/ Sensor Off Hotspot w/ Sensor Off Extremity w/ Sensor Off		Body-worn w/ Sensor On Hotspot w/ Sensor On		Extremity w/ Sensor On	
2G Band	Power Reduction Scenario	Full Power	Full Power	Reduction Power-1	Reduction Power-1	Reduction Power-2	Reduction Power-2
	Tune-up Limit (dBm)	Maximum Burst-Averaged Output Power	Maximum Frame-Averaged Output Power	Maximum Burst-Averaged Output Power	Maximum Frame-Averaged Output Power	Maximum Burst-Averaged Output Power	Maximum Frame-Averaged Output Power
GSM1900	GSM (GMSK, 1Tx-slot)	31.50	22.50	30.50	21.50	30.50	21.50
	GPRS (GMSK, 1Tx-slot)	31.50	22.50	30.50	21.50	29.50	20.50
	GPRS (GMSK, 2Tx-slot)	27.50	21.50	25.50	19.50	25.50	19.50
	GPRS (GMSK, 3Tx-slot)	25.50	21.24	24.00	19.74	24.00	19.74
	GPRS (GMSK, 4Tx-slot)	24.50	21.50	23.00	20.00	23.00	20.00
	EDGE (8PSK, 1Tx-slot)	27.50	18.50	27.00	18.00	26.00	17.00
	EDGE (8PSK, 2Tx-slot)	24.50	18.50	22.50	16.50	22.50	16.50
	EDGE (8PSK, 3Tx-slot)	23.00	18.74	21.50	17.24	21.50	17.24
	EDGE (8PSK, 4Tx-slot)	22.00	19.00	20.50	17.50	20.50	17.50

FCC SAR Test Report

Note:

1. SAR testing was performed on the maximum frame-averaged power mode.
2. The frame-averaged power is linearly proportion to the slot number configured and it is linearly scaled the maximum burst-averaged power based on time slots. The calculated method is shown as below:

$$\text{Frame-averaged power} = 10 \times \log (\text{Burst-averaged power mW} \times \text{Slot used} / 8)$$

Mode		WWAN Ant		
		Head Body-worn w/ Sensor Off Hotspot w/ Sensor Off Extremity w/ Sensor Off	Body-worn w/ Sensor On Hotspot w/ Sensor On	Extremity w/ Sensor On
3G Band	Power Reduction Scenario	Full Power	Reduction Power-1	Reduction Power-2
	Tune-up Limit (dBm)			
WCDMA II	RMC 12.2K	24.50	20.00	20.00
	HSDPA Subtest-1	24.00	20.00	20.00
	HSUPA Subtest-1	24.00	20.00	20.00
	DC-HSDPA Subtest-1	24.00	20.00	20.00
	HSPA+ Subtest-1	21.50	17.50	17.50
WCDMA IV	RMC 12.2K	24.50	21.00	21.00
	HSDPA Subtest-1	24.00	21.00	21.00
	HSUPA Subtest-1	24.00	21.00	21.00
	DC-HSDPA Subtest-1	24.00	21.00	21.00
	HSPA+ Subtest-1	21.50	18.50	18.50

Mode		WWAN Ant
		Head Body-worn w/ Sensor Off Hotspot w/ Sensor Off Extremity w/ Sensor Off
3G Band	Power Reduction Scenario	Full Power
	Tune-up Limit (dBm)	
WCDMA V	RMC 12.2K	24.00
	HSDPA Subtest-1	23.00
	HSUPA Subtest-1	23.00
	DC-HSDPA Subtest-1	23.00
	HSPA+ Subtest-1	20.50

FCC SAR Test Report

Mode		WWAN Ant		
		Head Body-worn w/ Sensor Off Hotspot w/ Sensor Off Extremity w/ Sensor Off	Body-worn w/ Sensor On Hotspot w/ Sensor On	Extremity w/ Sensor On
4G Band	Power Reduction Scenario	Full Power	Reduction Power-1	Reduction Power-2
	Modulation			
LTE 2	QPSK / 16QAM / 64QAM	24.50	20.00	20.00
LTE 4	QPSK / 16QAM / 64QAM	24.50	20.50	19.50
LTE 7	QPSK / 16QAM / 64QAM	24.50	21.00	21.00

Mode		WWAN Ant
		Head Body-worn w/ Sensor Off Hotspot w/ Sensor Off Extremity w/ Sensor Off
4G Band	Power Reduction Scenario	Full Power
	Modulation	
LTE 5	QPSK / 16QAM / 64QAM	24.00
LTE 38	QPSK / 16QAM / 64QAM	24.00

FCC SAR Test Report

<WLAN 2.4G>

Mode	Channel	Frequency (MHz)	Tune-up Power
802.11b	1	2412	18.0
	6	2437	18.0
	11	2462	18.0
802.11g	1	2412	14.0
	6	2437	14.0
	11	2462	14.0
802.11n (HT20)	1	2412	12.0
	6	2437	12.0
	11	2462	12.0
802.11n (HT40)	3	2422	12.5
	6	2437	12.5
	9	2452	12.5

<WLAN 5.2G>

Mode	Channel	Frequency (MHz)	Tune-up Power
802.11a	36	5180	16.5
	40	5200	16.5
	44	5220	16.5
	48	5240	16.5
802.11n (HT20)	36	5180	13.5
	40	5200	13.5
	44	5220	13.5
	48	5240	13.5
802.11n (HT40)	38	5190	15.0
	46	5230	15.0
802.11ac (VHT80)	42	5210	13.0

<WLAN 5.3G>

Mode	Channel	Frequency (MHz)	Tune-up Power
802.11a	52	5260	16.5
	56	5280	16.5
	60	5300	16.5
	64	5320	16.5
802.11n (HT20)	52	5260	14.0
	56	5280	14.0
	60	5300	14.0
	64	5320	14.0
802.11n (HT40)	54	5270	15.0
	62	5310	15.0
802.11ac (VHT80)	58	5290	13.0

FCC SAR Test Report

<WLAN 5.6G>

Mode	Channel	Frequency (MHz)	Tune-up Power
802.11a	100	5500	16.5
	116	5580	16.5
	120	5600	16.5
	124	5620	16.5
	132	5660	16.5
	140	5700	16.5
	144	5720	16.5
802.11n (HT20)	100	5500	13.5
	116	5580	13.5
	120	5600	13.5
	124	5620	13.5
	132	5660	13.5
	140	5700	13.5
	144	5720	13.5
802.11n (HT40)	102	5510	16.0
	110	5550	16.0
	118	5590	16.0
	126	5630	16.0
	134	5670	16.0
	142	5710	16.0
802.11ac (VHT80)	106	5530	13.0
	122	5610	13.0
	138	5690	13.0

<WLAN 5.8G>

Mode	Channel	Frequency (MHz)	Tune-up Power
802.11a	149	5745	15.5
	153	5765	15.5
	157	5785	15.5
	161	5805	15.5
802.11n (HT20)	149	5745	13.0
	153	5765	13.0
	157	5785	13.0
	161	5805	13.0
802.11n (HT40)	151	5755	14.0
	159	5795	14.0
802.11ac (VHT80)	155	5775	12.0

<Bluetooth>

Mode	Channel	Frequency (MHz)	Average Power
Bluetooth EDR	0	2402	9.5
	39	2441	9.5
	78	2480	9.5
Bluetooth LE	0	2402	2.0
	19	2440	2.0
	39	2480	2.0

FCC SAR Test Report

4.6.2 Measured Conducted Power Result

The measuring conducted average power (Unit: dBm) is shown as below.

<Full Power>

Band	GSM850			GSM1900		
Channel	128	189	251	512	661	810
Frequency (MHz)	824.2	836.4	848.8	1850.2	1880.0	1909.8
Maximum Burst-Averaged Output Power						
GSM (GMSK, 1Tx-slot)	33.42	33.49	33.39	31.49	31.48	31.45
GPRS (GMSK, 1Tx-slot)	33.41	33.48	33.38	31.48	31.47	31.43
GPRS (GMSK, 2Tx-slot)	29.94	30.13	29.88	27.38	27.43	27.39
GPRS (GMSK, 3Tx-slot)	27.92	28.11	27.86	25.12	25.17	25.13
GPRS (GMSK, 4Tx-slot)	26.75	26.94	26.69	23.91	23.96	23.92
EDGE (8PSK, 1Tx-slot)	26.58	26.77	26.52	26.16	26.21	26.17
EDGE (8PSK, 2Tx-slot)	24.43	24.62	24.37	24.03	24.08	24.04
EDGE (8PSK, 3Tx-slot)	22.73	22.92	22.67	22.40	22.45	22.41
EDGE (8PSK, 4Tx-slot)	21.92	22.11	21.86	21.26	21.31	21.27

Band	WCDMA Band II			WCDMA Band IV			WCDMA Band V			3GPP MPR (dB)
Channel	9262	9400	9538	1312	1413	1513	4132	4182	4233	
Frequency (MHz)	1852.4	1880.0	1907.6	1712.4	1732.6	1752.6	826.4	836.4	846.6	
RMC 12.2K	24.45	24.43	24.49	24.37	24.34	24.48	23.58	23.57	23.71	-
HSDPA Subtest-1	23.47	23.49	23.38	23.34	23.39	23.42	22.57	22.62	22.68	0
HSDPA Subtest-2	23.45	23.47	23.37	23.32	23.38	23.41	22.55	22.61	22.67	0
HSDPA Subtest-3	23.01	23.05	23.02	22.85	22.92	23.06	22.09	22.11	22.23	0.5
HSDPA Subtest-4	22.98	23.03	23.01	22.84	22.91	23.05	22.06	22.18	22.21	0.5
DC-HSDPA Subtest-1	23.41	23.46	23.44	23.28	23.37	23.49	22.51	22.57	22.63	0
DC-HSDPA Subtest-2	23.39	23.45	23.41	23.25	23.34	23.47	22.47	22.55	22.60	0
DC-HSDPA Subtest-3	22.95	23.01	22.96	22.80	22.85	23.01	22.03	22.03	22.18	0.5
DC-HSDPA Subtest-4	22.89	22.99	22.92	22.78	22.86	23.00	21.99	22.11	22.15	0.5
HSUPA Subtest-1	23.45	23.47	23.50	23.32	23.36	23.48	22.52	22.62	22.68	0
HSUPA Subtest-2	21.43	21.56	21.46	21.35	21.31	21.50	20.59	20.63	20.75	2
HSUPA Subtest-3	22.44	22.44	22.50	22.34	22.35	22.52	21.55	21.57	21.76	1
HSUPA Subtest-4	21.44	21.46	21.51	21.31	21.36	21.50	20.58	20.58	20.68	2
HSUPA Subtest-5	23.49	23.50	23.53	23.40	23.41	23.51	22.61	22.51	22.72	0
HSPA+ Subtest-1	20.94	20.92	21.01	20.88	20.84	20.94	20.05	20.01	20.12	-

FCC SAR Test Report

LTE Band 2															
BW	MCS Index	RB Size	RB Offset	Low	Mid	High	3GPP MPR (dB)	BW	MCS Index	RB Size	RB Offset	Low	Mid	High	3GPP MPR (dB)
		Channel		18700	18900	19100				Channel		18675	18900	19125	
		Frequency (MHz)		1860.0	1880.0	1900.0				Frequency (MHz)		1857.5	1880.0	1902.5	
20M	QPSK	1	0	24.49	24.43	24.36	0	15M	QPSK	1	0	24.44	24.39	24.28	0
		1	50	24.37	24.31	24.24	0			1	37	24.34	24.23	24.14	0
		1	99	24.34	24.28	24.21	0			1	74	24.34	24.18	24.18	0
		50	0	22.73	22.67	22.60	1			36	0	22.65	22.67	22.56	1
		50	25	22.67	22.61	22.54	1			36	19	22.67	22.55	22.45	1
		50	50	22.65	22.59	22.52	1			36	39	22.61	22.59	22.47	1
		100	0	22.67	22.61	22.54	1			75	0	22.65	22.52	22.54	1
	16QAM	1	0	23.24	23.18	23.11	1		16QAM	1	0	23.18	23.18	23.10	1
		1	50	22.97	22.91	22.84	1			1	37	22.94	22.90	22.82	1
		1	99	22.91	22.85	22.78	1			1	74	22.90	22.80	22.77	1
		50	0	21.80	21.74	21.67	2			36	0	21.76	21.68	21.65	2
		50	25	21.78	21.72	21.65	2			36	19	21.74	21.66	21.56	2
		50	50	21.74	21.68	21.61	2			36	39	21.72	21.58	21.51	2
		100	0	21.75	21.69	21.62	2			75	0	21.72	21.59	21.62	2
	64QAM	1	0	22.43	22.48	22.41	2		64QAM	1	0	22.35	22.42	22.40	2
		1	50	22.42	22.47	22.40	2			1	37	22.37	22.41	22.39	2
		1	99	22.37	22.45	22.38	2			1	74	22.29	22.36	22.31	2
		50	0	21.82	21.76	21.69	2			36	0	21.79	21.71	21.59	2
		50	25	21.79	21.73	21.66	2			36	19	21.78	21.72	21.56	2
		50	50	21.77	21.71	21.64	2			36	39	21.74	21.62	21.54	2
		100	0	21.71	21.65	21.58	2			75	0	21.62	21.65	21.55	2
10M	QPSK	1	0	24.38	24.32	24.27	0	5M	QPSK	1	0	24.38	24.38	24.30	0
		1	24	24.29	24.14	24.11	0			1	12	24.18	24.17	24.06	0
		1	49	24.23	24.05	24.06	0			1	24	24.15	24.24	23.91	0
		25	0	22.63	22.48	22.41	1			12	0	22.62	22.49	22.37	1
		25	12	22.57	22.43	22.47	1			12	6	22.54	22.58	22.35	1
		25	25	22.57	22.44	22.38	1			12	13	22.48	22.45	22.26	1
		50	0	22.61	22.42	22.34	1			25	0	22.54	22.56	22.41	1
	16QAM	1	0	23.08	23.03	22.96	1		16QAM	1	0	23.05	23.01	22.86	1
		1	24	22.80	22.81	22.72	1			1	12	22.93	22.69	22.69	1
		1	49	22.75	22.68	22.65	1			1	24	22.70	22.83	22.68	1
		25	0	21.65	21.62	21.44	2			12	0	21.64	21.68	21.50	2
		25	12	21.71	21.69	21.52	2			12	6	21.58	21.63	21.61	2
		25	25	21.73	21.51	21.37	2			12	13	21.60	21.54	21.39	2
		50	0	21.58	21.55	21.54	2			25	0	21.57	21.64	21.49	2
	64QAM	1	0	22.36	22.37	22.23	2		64QAM	1	0	22.29	22.33	22.29	2
		1	24	22.20	22.44	22.25	2			1	12	22.36	22.35	22.25	2
		1	49	22.20	22.35	22.17	2			1	24	22.30	22.29	22.16	2
		25	0	21.70	21.67	21.50	2			12	0	21.68	21.64	21.53	2
		25	12	21.62	21.63	21.58	2			12	6	21.73	21.50	21.48	2
		25	25	21.57	21.52	21.59	2			12	13	21.64	21.64	21.53	2
		50	0	21.56	21.64	21.54	2			25	0	21.60	21.58	21.46	2
3M	QPSK	1	0	24.35	24.25	24.26	0	1.4M	QPSK	1	0	24.44	24.29	24.14	0
		1	7	24.37	24.19	24.14	0			1	2	24.25	24.07	24.03	0
		1	14	24.22	24.08	24.15	0			1	5	24.30	24.22	24.14	0
		8	0	22.66	22.55	22.49	1			3	0	23.63	23.55	23.55	0
		8	3	22.57	22.56	22.35	1			3	1	23.47	23.46	23.40	0
		8	7	22.50	22.43	22.33	1			3	3	23.46	23.54	23.37	0
		15	0	22.62	22.47	22.45	1			6	0	22.45	22.55	22.29	1
	16QAM	1	0	23.12	23.05	22.98	1		16QAM	1	0	23.10	23.10	22.92	1
		1	7	22.79	22.84	22.77	1			1	2	22.74	22.88	22.77	1
		1	14	22.79	22.82	22.64	1			1	5	22.76	22.66	22.67	1
		8	0	21.64	21.67	21.51	2			3	0	22.63	22.73	22.59	1
		8	3	21.55	21.57	21.46	2			3	1	22.59	22.58	22.55	1
		8	7	21.49	21.62	21.44	2			3	3	22.58	22.53	22.51	1
		15	0	21.66	21.55	21.46	2			6	0	21.51	21.61	21.50	2
	64QAM	1	0	22.43	22.26	22.29	2		64QAM	1	0	22.43	22.33	22.36	2
		1	7	22.25	22.26	22.28	2			1	2	22.37	22.32	22.21	2
		1	14	22.30	22.39	22.32	2			1	5	22.23	22.37	22.21	2
		8	0	21.71	21.53	21.61	2			3	0	22.39	22.34	22.35	2
		8	3	21.71	21.51	21.57	2			3	1	22.34	22.36	22.36	2
		8	7	21.59	21.65	21.57	2			3	3	22.31	22.35	22.42	2
		15	0	21.66	21.50	21.53	2			6	0	22.39	22.37	22.38	2

FCC SAR Test Report

LTE Band 4																	
BW	MCS Index	RB Size	RB Offset	Low	Mid	High	3GPP MPR (dB)	BW	MCS Index	RB Size	RB Offset	Low	Mid	High	3GPP MPR (dB)		
		Channel		20050	20175	20300				Channel		20025	20175	20325			
		Frequency (MHz)		1720.0	1732.5	1745.0				Frequency (MHz)		1717.5	1732.5	1747.5			
20M	QPSK	1	0	24.17	24.29	24.22	0	15M	QPSK	1	0	24.17	24.20	24.12	0		
		1	50	24.01	24.13	24.06	0			1	37	23.96	24.09	24.01	0		
		1	99	23.99	24.11	24.04	0			1	74	23.91	24.09	23.96	0		
		50	0	22.31	22.43	22.36	1			36	0	22.27	22.36	22.28	1		
		50	25	22.24	22.36	22.29	1			36	19	22.17	22.30	22.26	1		
		50	50	22.21	22.33	22.26	1			36	39	22.21	22.27	22.22	1		
	100	0	22.26	22.38	22.31	1	75		0	22.25	22.28	22.23	1				
	16QAM	1	0	22.17	22.32	22.23	1		16QAM	1	0	22.10	22.26	22.19	1		
		1	50	22.12	22.19	22.11	1			1	37	22.09	22.11	22.11	1		
		1	99	21.94	22.05	21.93	1			1	74	21.88	22.01	21.90	1		
		50	0	21.11	21.19	21.06	2			36	0	21.09	21.14	20.99	2		
		50	25	21.01	21.11	21.04	2			36	19	20.96	21.07	21.01	2		
		50	50	20.91	21.03	20.87	2			36	39	20.83	21.01	20.77	2		
	100	0	20.93	21.07	20.90	2	75		0	20.91	21.02	20.90	2				
	64QAM	1	0	22.28	22.32	22.25	2		64QAM	1	0	22.25	22.29	22.15	2		
		1	50	22.24	22.28	22.21	2			1	37	22.24	22.27	22.11	2		
		1	99	22.21	22.25	22.18	2			1	74	22.11	22.25	22.08	2		
		50	0	21.33	21.37	21.30	2			36	0	21.30	21.34	21.30	2		
		50	25	21.31	21.35	21.28	2			36	19	21.23	21.34	21.25	2		
		50	50	21.27	21.31	21.24	2			36	39	21.19	21.22	21.19	2		
	100	0	21.28	21.32	21.25	2	75		0	21.25	21.25	21.19	2				
	10M	QPSK	1	0	24.04	24.11	24.15		0	5M	QPSK	1	0	24.10	24.20	24.04	0
			1	24	23.96	24.02	24.04		0			1	12	23.92	24.09	23.80	0
			1	49	23.87	23.91	23.96		0			1	24	23.86	23.94	23.83	0
25			0	22.25	22.35	22.29	1	12	0			22.19	22.32	22.13	1		
25			12	21.99	22.27	22.13	1	12	6			22.10	22.25	22.08	1		
25			25	22.03	22.26	22.05	1	12	13			22.12	22.20	22.21	1		
50		0	22.12	22.23	22.12	1	25	0	22.16		22.33	22.15	1				
16QAM		1	0	22.01	22.22	22.00	1	16QAM	1		0	22.14	22.20	22.01	1		
		1	24	21.90	22.07	22.03	1		1		12	21.95	22.17	21.99	1		
		1	49	21.86	21.94	21.73	1		1		24	21.79	21.91	21.78	1		
		25	0	20.92	21.08	20.92	2		12		0	20.95	21.04	20.92	2		
		25	12	20.86	21.02	20.94	2		12		6	20.93	21.01	20.94	2		
		25	25	20.82	20.91	20.71	2		12		13	20.73	20.92	20.77	2		
50		0	20.71	21.02	20.71	2	25	0	20.77		20.94	20.75	2				
64QAM		1	0	22.23	22.19	22.10	2	64QAM	1		0	22.15	22.26	22.19	2		
		1	24	22.11	22.19	22.05	2		1		12	22.16	22.10	22.12	2		
		1	49	22.03	22.23	22.05	2		1		24	22.06	22.09	22.05	2		
		25	0	21.19	21.25	21.21	2		12		0	21.18	21.16	21.22	2		
		25	12	21.13	21.18	21.10	2		12		6	21.16	21.27	21.19	2		
		25	25	21.07	21.18	21.19	2		12		13	21.23	21.13	21.07	2		
50		0	21.22	21.18	21.09	2	25	0	21.16		21.16	21.09	2				
3M		QPSK	1	0	24.08	24.19	24.08	0	1.4M		QPSK	1	0	24.17	24.27	24.09	0
			1	7	23.91	24.01	23.91	0				1	2	23.94	23.98	23.85	0
			1	14	23.87	23.92	23.92	0				1	5	23.79	24.01	23.94	0
	8		0	22.27	22.33	22.30	1	3		0		23.20	23.28	23.35	0		
	8		3	22.15	22.26	22.18	1	3		1		23.18	23.26	23.10	0		
	8		7	22.11	22.18	22.09	1	3		3		23.01	23.29	23.10	0		
	15	0	22.14	22.27	22.06	1	6	0		22.16	22.27	22.21	1				
	16QAM	1	0	22.06	22.28	22.07	1	16QAM		1	0	21.99	22.11	22.04	1		
		1	7	21.94	22.14	22.11	1			1	2	22.07	22.12	21.90	1		
		1	14	21.77	21.94	21.81	1			1	5	21.80	21.86	21.83	1		
		8	0	20.87	20.96	21.02	2			3	0	21.97	21.97	21.86	1		
		8	3	20.98	21.01	20.99	2			3	1	21.87	21.94	21.92	1		
		8	7	20.78	20.92	20.75	2			3	3	21.86	21.88	21.70	1		
	15	0	20.82	20.87	20.75	2	6	0		20.76	21.04	20.78	2				
	64QAM	1	0	22.16	22.14	22.18	2	64QAM		1	0	22.12	22.16	22.13	2		
		1	7	22.11	22.17	22.13	2			1	2	22.20	22.16	22.07	2		
		1	14	22.20	22.07	22.07	2			1	5	22.11	22.10	22.05	2		
		8	0	21.26	21.19	21.17	2			3	0	22.25	22.28	22.13	2		
		8	3	21.10	21.28	21.16	2			3	1	22.18	22.23	22.15	2		
		8	7	21.22	21.18	21.14	2			3	3	22.11	22.29	22.06	2		
	15	0	21.10	21.25	21.18	2	6	0		21.17	21.27	21.12	2				

FCC SAR Test Report

LTE Band 5															
BW	MCS Index	RB Size	RB Offset	Low	Mid	High	3GPP MPR (dB)	BW	MCS Index	RB Size	RB Offset	Low	Mid	High	3GPP MPR (dB)
		Channel		20450	20525	20600				Channel		20425	20525	20625	
		Frequency (MHz)		829.0	836.5	844.0				Frequency (MHz)		826.5	836.5	846.5	
10M	QPSK	1	0	23.45	23.51	23.38	0	5M	QPSK	1	0	23.44	23.44	23.36	0
		1	24	23.41	23.47	23.34	0			1	12	23.36	23.42	23.24	0
		1	49	23.39	23.45	23.32	0			1	24	23.35	23.36	23.24	0
		25	0	22.07	22.13	22.00	1			12	0	22.04	22.04	21.91	1
		25	12	22.05	22.11	21.98	1			12	6	21.98	22.02	21.97	1
		25	25	22.02	22.08	21.95	1			12	13	22.01	22.01	21.88	1
		50	0	22.06	22.12	21.99	1			25	0	21.97	22.04	21.99	1
	16QAM	1	0	22.28	22.37	22.17	1		16QAM	1	0	22.20	22.28	22.12	1
		1	24	22.28	22.35	22.22	1			1	12	22.20	22.29	22.15	1
		1	49	22.26	22.36	22.17	1			1	24	22.23	22.28	22.13	1
		25	0	21.12	21.27	21.05	2			12	0	21.10	21.22	20.97	2
		25	12	21.14	21.22	21.02	2			12	6	21.08	21.19	20.92	2
		25	25	21.06	21.18	21.01	2			12	13	21.02	21.11	20.99	2
		50	0	21.07	21.21	21.02	2			25	0	21.03	21.14	20.92	2
	64QAM	1	0	20.23	20.32	20.18	2		64QAM	1	0	20.19	20.30	20.14	2
		1	24	20.27	20.36	20.14	2			1	12	20.22	20.29	20.07	2
		1	49	20.16	20.27	20.11	2			1	24	20.09	20.27	20.04	2
		25	0	20.10	20.25	20.12	2			12	0	20.05	20.20	20.10	2
		25	12	20.09	20.23	20.04	2			12	6	20.08	20.18	20.05	2
		25	25	20.10	20.18	20.05	2			12	13	20.05	20.09	20.03	2
		50	0	20.01	20.16	20.03	2			25	0	20.01	20.13	20.01	2
3M	QPSK	1	0	23.33	23.37	23.24	0	1.4M	QPSK	1	0	23.38	23.48	23.35	0
		1	7	23.40	23.36	23.24	0			1	2	23.28	23.33	23.29	0
		1	14	23.20	23.41	23.24	0			1	5	23.21	23.36	23.28	0
		8	0	21.97	22.01	21.93	1			3	0	22.90	23.01	22.85	0
		8	3	21.93	22.01	21.80	1			3	1	22.81	23.01	22.94	0
		8	7	21.89	22.04	21.94	1			3	3	22.83	22.95	22.75	0
		15	0	21.93	22.00	21.96	1			6	0	21.89	21.96	21.92	1
	16QAM	1	0	22.15	22.26	22.10	1		16QAM	1	0	22.11	22.32	22.01	1
		1	7	22.09	22.18	22.19	1			1	2	22.15	22.32	22.16	1
		1	14	22.07	22.29	22.02	1			1	5	22.19	22.28	21.95	1
		8	0	20.97	21.11	20.85	2			3	0	22.01	22.21	21.84	1
		8	3	20.94	21.12	20.91	2			3	1	22.01	22.08	21.87	1
		8	7	20.93	21.03	20.88	2			3	3	21.97	22.14	21.93	1
		15	0	20.94	21.11	20.93	2			6	0	20.95	21.13	20.96	2
	64QAM	1	0	20.08	20.26	20.11	2		64QAM	1	0	20.09	20.14	20.05	2
		1	7	20.21	20.25	20.01	2			1	2	20.18	20.22	20.04	2
		1	14	20.12	20.09	20.08	2			1	5	20.15	20.11	20.01	2
		8	0	20.07	20.12	20.07	2			3	0	20.07	20.14	20.11	2
		8	3	20.04	20.10	20.02	2			3	1	20.09	20.15	20.05	2
		8	7	20.01	20.03	20.05	2			3	3	20.08	20.08	20.04	2
		15	0	20.02	20.01	20.04	2			6	0	20.04	20.11	20.01	2

FCC SAR Test Report

LTE Band 7															
BW	MCS Index	RB Size	RB Offset	Low	Mid	High	3GPP MPR (dB)	BW	MCS Index	RB Size	RB Offset	Low	Mid	High	3GPP MPR (dB)
		Channel		20850	21100	21350				Channel		20825	21100	21375	
		Frequency (MHz)		2510.0	2535.0	2560.0				Frequency (MHz)		2507.5	2535.0	2562.5	
20M	QPSK	1	0	24.08	24.15	24.19	0	15M	QPSK	1	0	23.98	24.15	24.19	0
		1	50	24.04	24.11	24.15	0			1	37	23.95	24.10	24.14	0
		1	99	24.02	24.09	24.13	0			1	74	23.97	23.99	24.08	0
		50	0	22.24	22.31	22.35	1			36	0	22.15	22.31	22.25	1
		50	25	22.21	22.28	22.32	1			36	19	22.11	22.27	22.29	1
		50	50	22.16	22.23	22.27	1			36	39	22.13	22.17	22.17	1
	100	0	22.22	22.29	22.33	1	75		0	22.17	22.20	22.29	1		
	16QAM	1	0	22.26	22.38	22.38	1		16QAM	1	0	22.21	22.37	22.38	1
		1	50	22.35	22.46	22.44	1			1	37	22.32	22.43	22.39	1
		1	99	22.20	22.35	22.37	1			1	74	22.20	22.30	22.29	1
		50	0	21.23	21.31	21.35	2			36	0	21.19	21.29	21.28	2
		50	25	21.28	21.36	21.37	2			36	19	21.26	21.28	21.27	2
		50	50	21.24	21.37	21.40	2			36	39	21.16	21.28	21.40	2
	100	0	21.22	21.33	21.28	2	75		0	21.13	21.24	21.23	2		
	64QAM	1	0	22.21	22.28	22.32	2		64QAM	1	0	22.15	22.26	22.28	2
		1	50	22.18	22.25	22.29	2			1	37	22.18	22.16	22.20	2
		1	99	22.16	22.23	22.27	2			1	74	22.12	22.16	22.23	2
		50	0	21.21	21.28	21.32	2			36	0	21.14	21.25	21.29	2
		50	25	21.16	21.23	21.27	2			36	19	21.06	21.19	21.27	2
		50	50	21.15	21.22	21.26	2			36	39	21.11	21.16	21.20	2
	100	0	21.19	21.26	21.30	2	75		0	21.17	21.23	21.28	2		
BW	MCS Index	RB Size	RB Offset	Low	Mid	High	3GPP MPR (dB)	BW	MCS Index	RB Size	RB Offset	Low	Mid	High	3GPP MPR (dB)
		Channel		20800	21100	21400				Channel		20775	21100	21425	
		Frequency (MHz)		2505.0	2535.0	2565.0				Frequency (MHz)		2502.5	2535.0	2567.5	
10M	QPSK	1	0	24.04	24.10	24.05	0	5M	QPSK	1	0	24.00	24.03	24.12	0
		1	24	23.89	23.91	23.92	0			1	12	23.93	24.08	23.93	0
		1	49	23.87	23.89	23.97	0			1	24	23.95	24.03	23.96	0
		25	0	22.06	22.11	22.25	1			12	0	22.20	22.08	22.14	1
		25	12	22.10	22.09	22.32	1			12	6	22.17	22.17	21.95	1
		25	25	22.07	22.06	22.24	1			12	13	22.09	22.07	22.15	1
	50	0	22.10	22.09	22.19	1	25		0	22.11	22.17	22.18	1		
	16QAM	1	0	22.18	22.17	22.27	1		16QAM	1	0	22.02	22.38	22.22	1
		1	24	22.13	22.24	22.37	1			1	12	22.17	22.31	22.27	1
		1	49	22.13	22.22	22.31	1			1	24	22.04	22.12	22.33	1
		25	0	21.11	21.15	21.27	2			12	0	21.13	21.27	21.28	2
		25	12	21.18	21.24	21.29	2			12	6	21.09	21.25	21.22	2
		25	25	21.07	21.27	21.23	2			12	13	21.10	21.28	21.30	2
	50	0	21.11	21.19	21.14	2	25		0	21.04	21.18	21.24	2		
	64QAM	1	0	22.11	22.09	22.21	2		64QAM	1	0	22.09	22.17	22.11	2
		1	24	22.13	22.13	22.20	2			1	12	21.99	22.16	22.15	2
		1	49	22.09	22.19	22.15	2			1	24	22.04	22.20	22.19	2
		25	0	21.02	21.24	21.25	2			12	0	21.05	21.16	21.23	2
		25	12	20.95	21.06	21.12	2			12	6	20.95	21.00	21.11	2
		25	25	20.92	21.08	21.22	2			12	13	21.04	21.09	21.03	2
	50	0	20.97	21.17	21.23	2	25		0	21.09	21.09	21.18	2		

FCC SAR Test Report

LTE Band 38																	
BW	MCS Index	RB Size	RB Offset	Low	Mid	High	3GPP MPR (dB)	BW	MCS Index	RB Size	RB Offset	Low	Mid	High	3GPP MPR (dB)		
		Channel		37850	38000	38150				Channel		37825	38000	38175			
		Frequency (MHz)		2580	2595	2610				Frequency (MHz)		2577.5	2595	2612.5			
20M	QPSK	1	0	23.76	23.78	23.81	0	15M	QPSK	1	0	23.76	23.78	23.73	0		
		1	50	23.74	23.76	23.79	0			1	37	23.71	23.71	23.74	0		
		1	99	23.65	23.67	23.70	0			1	74	23.60	23.58	23.63	0		
		50	0	22.33	22.35	22.38	1			36	0	22.26	22.31	22.36	1		
		50	25	22.30	22.32	22.35	1			36	19	22.29	22.30	22.34	1		
		50	50	22.26	22.28	22.31	1			36	39	22.26	22.28	22.28	1		
	100	0	22.24	22.26	22.29	1	75		0	22.24	22.25	22.19	1				
	16QAM	1	0	22.48	22.55	22.54	1		16QAM	1	0	22.45	22.55	22.50	1		
		1	50	22.49	22.53	22.55	1			1	37	22.49	22.45	22.46	1		
		1	99	22.33	22.41	22.42	1			1	74	22.24	22.38	22.37	1		
		50	0	21.49	21.51	21.48	2			36	0	21.45	21.50	21.47	2		
		50	25	21.38	21.48	21.45	2			36	19	21.35	21.39	21.38	2		
		50	50	21.32	21.42	21.44	2			36	39	21.29	21.38	21.37	2		
	100	0	21.33	21.41	21.39	2	75		0	21.28	21.32	21.31	2				
	64QAM	1	0	20.07	20.15	20.09	2		64QAM	1	0	20.08	20.14	20.03	2		
		1	50	20.10	20.12	20.07	2			1	37	20.08	20.04	20.03	2		
		1	99	20.05	20.08	20.05	2			1	74	20.05	20.03	20.02	2		
		50	0	20.41	20.48	20.42	2			36	0	20.33	20.43	20.40	2		
		50	25	20.48	20.51	20.50	2			36	19	20.41	20.45	20.48	2		
		50	50	20.37	20.39	20.38	2			36	39	20.30	20.30	20.28	2		
	100	0	20.42	20.46	20.46	2	75		0	20.34	20.41	20.43	2				
	10M	QPSK	1	0	23.62	23.67	23.63		0	5M	QPSK	1	0	23.71	23.74	23.62	0
			1	24	23.56	23.65	23.63		0			1	12	23.68	23.66	23.47	0
			1	49	23.52	23.47	23.68		0			1	24	23.50	23.51	23.60	0
25			0	22.17	22.12	22.28	1	12	0			22.24	22.23	22.26	1		
25			12	22.15	22.09	22.27	1	12	6			22.15	22.19	22.11	1		
25			25	22.10	22.24	22.10	1	12	13			22.12	22.24	22.15	1		
50		0	22.16	22.11	22.11	1	25	0	22.06		22.11	22.08	1				
16QAM		1	0	22.38	22.47	22.35	1	16QAM	1		0	22.42	22.33	22.44	1		
		1	24	22.44	22.35	22.48	1		1		12	22.33	22.37	22.37	1		
		1	49	22.26	22.34	22.30	1		1		24	22.09	22.24	22.22	1		
		25	0	21.40	21.36	21.29	2		12		0	21.38	21.40	21.38	2		
		25	12	21.22	21.40	21.31	2		12		6	21.30	21.38	21.37	2		
		25	25	21.30	21.23	21.28	2		12		13	21.19	21.37	21.34	2		
50		0	21.24	21.25	21.28	2	25	0	21.19		21.25	21.24	2				
64QAM		1	0	20.01	20.04	20.03	2	64QAM	1		0	20.05	20.04	20.06	2		
		1	24	20.30	20.08	20.04	2		1		12	20.01	20.08	20.01	2		
		1	49	20.07	20.05	20.06	2		1		24	20.03	20.05	20.03	2		
		25	0	20.24	20.45	20.26	2		12		0	20.25	20.45	20.31	2		
		25	12	20.37	20.44	20.45	2		12		6	20.29	20.35	20.38	2		
		25	25	20.14	20.32	20.13	2		12		13	20.17	20.34	20.35	2		
50		0	20.17	20.43	20.28	2	25	0	20.37		20.29	20.26	2				

FCC SAR Test Report

<Reduction Power-1>

Band Channel	GSM1900		
	512	661	810
Frequency (MHz)	1850.2	1880.0	1909.8
Maximum Burst-Averaged Output Power			
GSM (GMSK, 1Tx-slot)	30.26	30.29	30.39
GPRS (GMSK, 1Tx-slot)	30.31	30.28	30.38
GPRS (GMSK, 2Tx-slot)	25.41	25.42	25.48
GPRS (GMSK, 3Tx-slot)	23.95	23.92	23.98
GPRS (GMSK, 4Tx-slot)	22.72	22.69	22.79
EDGE (8PSK, 1Tx-slot)	26.27	26.24	26.34
EDGE (8PSK, 2Tx-slot)	22.19	22.16	22.26
EDGE (8PSK, 3Tx-slot)	21.05	21.02	21.12
EDGE (8PSK, 4Tx-slot)	19.92	19.89	19.99

Band Channel	WCDMA Band II			WCDMA Band IV			3GPP MPR (dB)
	9262	9400	9538	1312	1413	1513	
Frequency (MHz)	1852.4	1880.0	1907.6	1712.4	1732.6	1752.6	
RMC 12.2K	19.75	19.81	19.72	20.56	20.62	20.88	-
HSDPA Subtest-1	18.73	18.79	18.70	19.66	19.72	19.98	0
HSDPA Subtest-2	18.69	18.75	18.66	19.64	19.70	19.96	0
HSDPA Subtest-3	18.28	18.34	18.25	19.13	19.19	19.45	0.5
HSDPA Subtest-4	18.25	18.31	18.22	19.11	19.17	19.43	0.5
DC-HSDPA Subtest-1	18.65	18.71	18.62	19.55	19.61	19.87	0
DC-HSDPA Subtest-2	18.61	18.67	18.58	19.53	19.59	19.85	0
DC-HSDPA Subtest-3	18.20	18.26	18.17	19.02	19.08	19.34	0.5
DC-HSDPA Subtest-4	18.17	18.23	18.14	19.00	19.06	19.32	0.5
HSUPA Subtest-1	18.72	18.78	18.69	19.62	19.68	19.94	0
HSUPA Subtest-2	16.71	16.77	16.68	17.57	17.63	17.89	2
HSUPA Subtest-3	17.72	17.78	17.69	18.62	18.68	18.94	1
HSUPA Subtest-4	16.75	16.81	16.72	17.65	17.71	17.97	2
HSUPA Subtest-5	18.76	18.82	18.73	19.66	19.72	19.98	0
HSPA+ Subtest-1	16.23	16.32	16.21	17.24	17.27	17.41	-

FCC SAR Test Report

LTE Band 2																	
BW	MCS Index	RB Size	RB Offset	Low	Mid	High	3GPP MPR (dB)	BW	MCS Index	RB Size	RB Offset	Low	Mid	High	3GPP MPR (dB)		
		Channel		18700	18900	19100				Channel		18675	18900	19125			
		Frequency (MHz)		1860.0	1880.0	1900.0				Frequency (MHz)		1857.5	1880.0	1902.5			
20M	QPSK	1	0	19.55	19.69	19.39	0	15M	QPSK	1	0	19.50	19.61	19.29	0		
		1	50	19.40	19.54	19.24	0			1	37	19.32	19.53	19.22	0		
		1	99	19.35	19.49	19.19	0			1	74	19.26	19.45	19.12	0		
		50	0	19.42	19.56	19.26	0			36	0	19.33	19.55	19.26	0		
		50	25	19.41	19.55	19.25	0			36	19	19.39	19.49	19.21	0		
		50	50	19.33	19.47	19.17	0			36	39	19.23	19.37	19.16	0		
	100	0	19.35	19.49	19.19	0	75		0	19.32	19.45	19.18	0				
	16QAM	1	0	19.40	19.54	19.24	0		16QAM	1	0	19.40	19.54	19.22	0		
		1	50	19.38	19.52	19.22	0			1	37	19.35	19.49	19.12	0		
		1	99	19.33	19.47	19.17	0			1	74	19.28	19.42	19.12	0		
		50	0	19.41	19.55	19.25	0			36	0	19.40	19.52	19.24	0		
		50	25	19.39	19.53	19.23	0			36	19	19.36	19.51	19.18	0		
		50	50	19.33	19.47	19.17	0			36	39	19.28	19.46	19.09	0		
	100	0	19.31	19.45	19.15	0	75		0	19.29	19.43	19.12	0				
	64QAM	1	0	19.39	19.53	19.23	0		64QAM	1	0	19.29	19.46	19.16	0		
		1	50	19.35	19.49	19.19	0			1	37	19.34	19.43	19.13	0		
		1	99	19.33	19.47	19.17	0			1	74	19.27	19.47	19.13	0		
		50	0	19.38	19.52	19.22	0			36	0	19.28	19.44	19.21	0		
		50	25	19.31	19.45	19.15	0			36	19	19.31	19.35	19.11	0		
		50	50	19.29	19.43	19.13	0			36	39	19.28	19.41	19.12	0		
	100	0	19.27	19.41	19.11	0	75		0	19.19	19.33	19.06	0				
	10M	QPSK	1	0	19.54	19.53	19.20		0	5M	QPSK	1	0	19.51	19.63	19.29	0
			1	24	19.39	19.43	19.05		0			1	12	19.32	19.38	19.09	0
			1	49	19.11	19.26	18.97		0			1	24	19.28	19.33	18.99	0
25			0	19.26	19.50	19.10	0	12	0			19.34	19.34	19.08	0		
25			12	19.35	19.47	19.07	0	12	6			19.27	19.38	19.01	0		
25			25	19.14	19.37	19.11	0	12	13			19.24	19.43	19.00	0		
50		0	19.15	19.35	18.97	0	25	0	19.33		19.34	18.95	0				
16QAM		1	0	19.27	19.36	19.09	0	16QAM	1		0	19.26	19.43	19.07	0		
		1	24	19.29	19.35	19.08	0		1		12	19.28	19.42	19.06	0		
		1	49	19.22	19.39	18.98	0		1		24	19.23	19.35	19.10	0		
		25	0	19.29	19.42	19.11	0		12		0	19.29	19.47	19.24	0		
		25	12	19.27	19.36	19.10	0		12		6	19.27	19.40	19.11	0		
		25	25	19.24	19.34	19.06	0		12		13	19.29	19.38	19.03	0		
50		0	19.29	19.26	19.01	0	25	0	19.15		19.24	19.02	0				
64QAM		1	0	19.23	19.30	19.17	0	64QAM	1		0	19.23	19.48	19.06	0		
		1	24	19.33	19.40	19.05	0		1		12	19.30	19.34	19.01	0		
		1	49	19.25	19.37	18.95	0		1		24	19.21	19.43	19.07	0		
		25	0	19.28	19.29	19.03	0		12		0	19.32	19.40	19.08	0		
		25	12	19.12	19.26	18.97	0		12		6	19.15	19.39	19.01	0		
		25	25	19.11	19.25	18.90	0		12		13	19.09	19.26	19.00	0		
50		0	19.11	19.33	18.96	0	25	0	19.05		19.27	18.91	0				
3M		QPSK	1	0	19.43	19.60	19.22	0	1.4M		QPSK	1	0	19.34	19.50	19.36	0
			1	7	19.32	19.43	19.08	0				1	2	19.26	19.45	19.12	0
			1	14	19.25	19.28	19.10	0				1	5	19.19	19.43	19.13	0
	8		0	19.34	19.48	19.08	0	3		0		19.29	19.46	19.20	0		
	8		3	19.24	19.46	19.16	0	3		1		19.25	19.39	19.16	0		
	8		7	19.25	19.39	19.06	0	3		3		19.23	19.37	19.07	0		
	15	0	19.17	19.42	19.11	0	6	0		19.24	19.32	19.13	0				
	16QAM	1	0	19.30	19.35	19.18	0	16QAM		1	0	19.24	19.44	19.07	0		
		1	7	19.20	19.41	19.14	0			1	2	19.35	19.43	19.09	0		
		1	14	19.16	19.43	19.03	0			1	5	19.28	19.27	19.13	0		
		8	0	19.26	19.50	19.09	0			3	0	19.21	19.45	19.10	0		
		8	3	19.35	19.40	19.03	0			3	1	19.17	19.37	19.10	0		
		8	7	19.23	19.32	19.05	0			3	3	19.33	19.37	19.07	0		
	15	0	19.23	19.25	18.96	0	6	0		19.17	19.26	19.08	0				
	64QAM	1	0	19.27	19.44	19.19	0	64QAM		1	0	19.32	19.39	19.04	0		
		1	7	19.26	19.38	19.13	0			1	2	19.25	19.44	19.06	0		
		1	14	19.26	19.38	19.14	0			1	5	19.31	19.37	19.09	0		
		8	0	19.31	19.40	19.05	0			3	0	19.19	19.28	19.10	0		
		8	3	19.19	19.37	19.08	0			3	1	19.23	19.33	19.01	0		
		8	7	19.24	19.32	19.06	0			3	3	19.08	19.26	18.88	0		
	15	0	19.18	19.36	18.92	0	6	0		19.13	19.20	18.93	0				

FCC SAR Test Report

LTE Band 4																	
BW	MCS Index	RB Size	RB Offset	Low	Mid	High	3GPP MPR (dB)	BW	MCS Index	RB Size	RB Offset	Low	Mid	High	3GPP MPR (dB)		
		Channel		20050	20175	20300				Channel		20025	20175	20325			
		Frequency (MHz)		1720.0	1732.5	1745.0				Frequency (MHz)		1717.5	1732.5	1747.5			
20M	QPSK	1	0	20.25	20.23	20.32	0	15M	QPSK	1	0	20.23	20.13	20.28	0		
		1	50	20.18	20.16	20.25	0			1	37	20.09	20.08	20.24	0		
		1	99	20.15	20.13	20.22	0			1	74	20.06	20.07	20.13	0		
		50	0	20.21	20.19	20.28	0			36	0	20.14	20.19	20.22	0		
		50	25	20.18	20.16	20.25	0			36	19	20.16	20.13	20.21	0		
		50	50	20.13	20.11	20.20	0			36	39	20.03	20.05	20.20	0		
	100	0	20.14	20.12	20.21	0	75		0	20.11	20.07	20.17	0				
	16QAM	1	0	20.23	20.21	20.30	0		1	0	20.23	20.20	20.21	0			
		1	50	20.17	20.15	20.24	0		1	37	20.15	20.06	20.24	0			
		1	99	20.14	20.12	20.21	0		1	74	20.05	20.10	20.14	0			
		50	0	20.20	20.18	20.27	0		36	0	20.19	20.14	20.23	0			
		50	25	20.17	20.15	20.24	0		36	19	20.14	20.06	20.17	0			
		50	50	20.15	20.13	20.22	0		36	39	20.05	20.03	20.14	0			
	100	0	20.16	20.14	20.23	0	75		0	20.09	20.06	20.13	0				
	64QAM	1	0	20.21	20.19	20.28	0		1	0	20.13	20.17	20.28	0			
		1	50	20.19	20.17	20.26	0		1	37	20.14	20.17	20.21	0			
		1	99	20.15	20.13	20.22	0		1	74	20.06	20.08	20.12	0			
		50	0	20.17	20.15	20.24	0		36	0	20.13	20.09	20.20	0			
		50	25	20.14	20.12	20.21	0		36	19	20.11	20.02	20.11	0			
		50	50	20.10	20.08	20.17	0		36	39	20.01	19.98	20.10	0			
	100	0	20.11	20.09	20.18	0	75		0	20.02	20.04	20.08	0				
	10M	QPSK	1	0	20.21	20.12	20.12		0	5M	QPSK	1	0	20.05	20.09	20.03	0
			1	24	20.08	19.96	20.18		0			1	12	19.98	19.96	20.05	0
			1	49	20.05	20.09	20.14		0			1	24	19.94	19.99	19.94	0
25			0	20.02	20.12	20.09	0	12	0			20.05	19.99	20.26	0		
25			12	20.10	20.04	20.18	0	12	6			20.04	20.07	20.02	0		
25			25	19.95	20.05	20.06	0	12	13			20.01	19.97	19.97	0		
50		0	20.02	20.01	20.08	0	25	0	19.94		20.05	19.99	0				
16QAM		1	0	20.08	20.12	20.10	0	1	0		20.08	20.08	20.16	0			
		1	24	20.07	20.12	20.12	0	1	12		20.08	20.01	20.07	0			
		1	49	20.01	20.08	19.98	0	1	24		20.07	20.00	20.10	0			
		25	0	20.10	20.10	20.09	0	12	0		20.19	20.07	20.10	0			
		25	12	20.15	20.05	20.12	0	12	6		20.09	19.97	20.06	0			
		25	25	19.95	19.98	20.04	0	12	13		20.09	19.93	20.11	0			
50		0	20.05	20.01	20.05	0	25	0	20.00		19.94	20.15	0				
64QAM		1	0	19.99	19.95	20.14	0	1	0		20.14	20.11	20.23	0			
		1	24	20.01	20.05	20.09	0	1	12		20.03	20.08	20.10	0			
		1	49	20.05	19.98	20.20	0	1	24		20.01	20.02	20.11	0			
		25	0	20.10	20.05	20.14	0	12	0		20.02	20.08	20.20	0			
		25	12	19.97	19.88	20.03	0	12	6		20.03	20.01	20.13	0			
		25	25	20.02	19.93	20.09	0	12	13		19.91	19.96	20.00	0			
50		0	19.97	19.94	20.01	0	25	0	19.96		19.94	20.03	0				
3M		QPSK	1	0	20.20	20.07	20.14	0	1.4M		QPSK	1	0	20.10	20.05	20.26	0
			1	7	20.05	20.01	20.18	0				1	2	20.06	20.03	20.15	0
			1	14	20.00	20.02	20.15	0				1	5	20.04	19.94	20.03	0
	8		0	20.09	20.07	20.13	0	3		0		20.11	19.98	20.18	0		
	8		3	20.08	19.96	20.07	0	3		1		20.03	20.02	20.10	0		
	8		7	20.07	19.93	20.09	0	3		3		20.08	20.01	20.11	0		
	15	0	20.02	19.92	20.04	0	6	0		20.10	19.98	20.01	0				
	16QAM	1	0	20.22	20.07	20.24	0	1		0	20.03	19.98	20.13	0			
		1	7	19.98	19.96	20.16	0	1		2	20.07	19.96	20.15	0			
		1	14	19.97	19.99	20.11	0	1		5	19.99	20.03	20.10	0			
		8	0	20.06	20.05	20.09	0	3		0	20.10	19.95	20.14	0			
		8	3	20.11	20.05	20.04	0	3		1	20.05	19.99	20.10	0			
		8	7	20.07	20.03	20.05	0	3		3	20.01	20.02	20.11	0			
	15	0	20.09	20.01	20.09	0	6	0		19.94	20.03	20.22	0				
	64QAM	1	0	20.10	20.04	20.24	0	1		0	20.01	19.97	20.25	0			
		1	7	20.00	20.01	20.11	0	1		2	20.09	20.00	20.18	0			
		1	14	20.02	19.90	20.02	0	1		5	19.94	20.03	20.09	0			
		8	0	20.12	20.04	20.16	0	3		0	20.05	19.99	20.10	0			
		8	3	20.04	19.93	19.99	0	3		1	20.03	19.99	20.06	0			
		8	7	20.05	19.89	20.11	0	3		3	19.91	19.89	19.97	0			
	15	0	19.92	19.99	20.03	0	6	0		19.93	19.94	20.08	0				

FCC SAR Test Report

LTE Band 7															
BW	MCS Index	RB Size	RB Offset	Low	Mid	High	3GPP MPR (dB)	BW	MCS Index	RB Size	RB Offset	Low	Mid	High	3GPP MPR (dB)
		Channel		20850	21100	21350				Channel		20825	21100	21375	
		Frequency (MHz)		2510.0	2535.0	2560.0				Frequency (MHz)		2507.5	2535.0	2562.5	
20M	QPSK	1	0	20.95	20.97	20.99	0	15M	QPSK	1	0	20.88	20.91	20.92	0
		1	50	20.89	20.95	20.95	0			1	37	20.80	20.89	20.93	0
		1	99	20.90	20.93	20.93	0			1	74	20.87	20.83	20.92	0
		50	0	20.85	20.95	20.96	0			36	0	20.76	20.89	20.80	0
		50	25	20.90	20.93	20.90	0			36	19	20.83	20.85	20.84	0
		50	50	20.84	20.92	20.91	0			36	39	20.77	20.82	20.86	0
		100	0	20.86	20.95	20.96	0			75	0	20.85	20.90	20.96	0
	16QAM	1	0	20.89	20.95	20.92	0		16QAM	1	0	20.83	20.88	20.92	0
		1	50	20.88	20.93	20.85	0			1	37	20.83	20.91	20.78	0
		1	99	20.89	20.92	20.90	0			1	74	20.89	20.87	20.84	0
		50	0	20.84	20.93	20.86	0			36	0	20.76	20.83	20.76	0
		50	25	20.88	20.92	20.88	0			36	19	20.86	20.91	20.82	0
		50	50	20.82	20.89	20.90	0			36	39	20.82	20.89	20.85	0
		100	0	20.78	20.87	20.88	0			75	0	20.72	20.78	20.85	0
	64QAM	1	0	20.44	20.55	20.49	0		64QAM	1	0	20.44	20.51	20.40	0
		1	50	20.43	20.48	20.40	0			1	37	20.36	20.47	20.33	0
		1	99	20.38	20.45	20.45	0			1	74	20.34	20.42	20.41	0
		50	0	20.46	20.53	20.52	0			36	0	20.39	20.51	20.42	0
		50	25	20.42	20.51	20.45	0			36	19	20.38	20.47	20.40	0
		50	50	20.40	20.46	20.41	0			36	39	20.35	20.41	20.34	0
		100	0	20.48	20.52	20.47	0			75	0	20.46	20.48	20.37	0
BW	MCS Index	RB Size	RB Offset	Low	Mid	High	3GPP MPR (dB)	BW	MCS Index	RB Size	RB Offset	Low	Mid	High	3GPP MPR (dB)
		Channel		20800	21100	21400				Channel		20775	21100	21425	
		Frequency (MHz)		2505.0	2535.0	2565.0				Frequency (MHz)		2502.5	2535.0	2567.5	
10M	QPSK	1	0	20.87	20.84	20.94	0	5M	QPSK	1	0	20.89	20.75	20.79	0
		1	24	20.78	20.89	20.76	0			1	12	20.72	20.87	20.73	0
		1	49	20.79	20.69	20.74	0			1	24	20.72	20.74	20.81	0
		25	0	20.84	20.79	20.79	0			12	0	20.71	20.82	20.65	0
		25	12	20.78	20.77	20.79	0			12	6	20.76	20.81	20.71	0
		25	25	20.80	20.88	20.82	0			12	13	20.75	20.73	20.81	0
		50	0	20.73	20.81	20.72	0			25	0	20.69	20.88	20.71	0
	16QAM	1	0	20.76	20.77	20.82	0		16QAM	1	0	20.76	20.94	20.86	0
		1	24	20.73	20.75	20.83	0			1	12	20.71	20.75	20.65	0
		1	49	20.74	20.80	20.70	0			1	24	20.74	20.86	20.81	0
		25	0	20.76	20.88	20.73	0			12	0	20.67	20.79	20.79	0
		25	12	20.80	20.85	20.80	0			12	6	20.74	20.74	20.66	0
		25	25	20.68	20.73	20.80	0			12	13	20.75	20.69	20.81	0
		50	0	20.72	20.79	20.67	0			25	0	20.65	20.79	20.69	0
	64QAM	1	0	20.28	20.38	20.32	0		64QAM	1	0	20.38	20.44	20.35	0
		1	24	20.41	20.36	20.24	0			1	12	20.32	20.37	20.29	0
		1	49	20.26	20.30	20.30	0			1	24	20.15	20.29	20.32	0
		25	0	20.41	20.50	20.37	0			12	0	20.30	20.31	20.31	0
		25	12	20.31	20.42	20.32	0			12	6	20.28	20.40	20.24	0
		25	25	20.30	20.38	20.37	0			12	13	20.36	20.30	20.33	0
		50	0	20.31	20.37	20.28	0			25	0	20.24	20.39	20.36	0

FCC SAR Test Report

<Reduction Power-2>

Band Channel	GSM1900		
	512	661	810
Frequency (MHz)	1850.2	1880.0	1909.8
Maximum Burst-Averaged Output Power			
GSM (GMSK, 1Tx-slot)	29.50	29.47	29.52
GPRS (GMSK, 1Tx-slot)	29.48	29.45	29.50
GPRS (GMSK, 2Tx-slot)	25.44	25.41	25.48
GPRS (GMSK, 3Tx-slot)	23.92	23.89	23.94
GPRS (GMSK, 4Tx-slot)	22.77	22.74	22.79
EDGE (8PSK, 1Tx-slot)	25.79	25.76	25.81
EDGE (8PSK, 2Tx-slot)	22.18	22.15	22.20
EDGE (8PSK, 3Tx-slot)	21.09	21.06	21.11
EDGE (8PSK, 4Tx-slot)	19.97	19.94	19.99

Band Channel	WCDMA Band II			WCDMA Band IV			3GPP MPR (dB)
	9262	9400	9538	1312	1413	1513	
Frequency (MHz)	1852.4	1880.0	1907.6	1712.4	1732.6	1752.6	
RMC 12.2K	19.75	19.81	19.72	20.56	20.62	20.88	-
HSDPA Subtest-1	18.73	18.79	18.70	19.66	19.72	19.98	0
HSDPA Subtest-2	18.69	18.75	18.66	19.64	19.70	19.96	0
HSDPA Subtest-3	18.28	18.34	18.25	19.13	19.19	19.45	0.5
HSDPA Subtest-4	18.25	18.31	18.22	19.11	19.17	19.43	0.5
DC-HSDPA Subtest-1	18.65	18.71	18.62	19.55	19.61	19.87	0
DC-HSDPA Subtest-2	18.61	18.67	18.58	19.53	19.59	19.85	0
DC-HSDPA Subtest-3	18.20	18.26	18.17	19.02	19.08	19.34	0.5
DC-HSDPA Subtest-4	18.17	18.23	18.14	19.00	19.06	19.32	0.5
HSUPA Subtest-1	18.72	18.78	18.69	19.62	19.68	19.94	0
HSUPA Subtest-2	16.71	16.77	16.68	17.57	17.63	17.89	2
HSUPA Subtest-3	17.72	17.78	17.69	18.62	18.68	18.94	1
HSUPA Subtest-4	16.75	16.81	16.72	17.65	17.71	17.97	2
HSUPA Subtest-5	18.76	18.82	18.73	19.66	19.72	19.98	0
HSPA+ Subtest-1	16.15	16.22	16.14	17.24	17.27	17.41	-

FCC SAR Test Report

LTE Band 2															
BW	MCS Index	RB Size	RB Offset	Low	Mid	High	3GPP MPR (dB)	BW	MCS Index	RB Size	RB Offset	Low	Mid	High	3GPP MPR (dB)
		Channel		18700	18900	19100				Channel		18675	18900	19125	
		Frequency (MHz)		1860.0	1880.0	1900.0				Frequency (MHz)		1857.5	1880.0	1902.5	
20M	QPSK	1	0	19.56	19.71	19.39	0	15M	QPSK	1	0	19.54	19.63	19.35	0
		1	50	19.28	19.43	19.11	0			1	37	19.18	19.40	19.07	0
		1	99	19.46	19.61	19.29	0			1	74	19.41	19.61	19.24	0
		50	0	19.47	19.62	19.30	0			36	0	19.38	19.58	19.20	0
		50	25	19.26	19.41	19.09	0			36	19	19.16	19.34	19.04	0
		50	50	19.34	19.49	19.17	0			36	39	19.34	19.43	19.10	0
	100	0	19.41	19.56	19.24	0	75		0	19.34	19.47	19.20	0		
	16QAM	1	0	19.52	19.67	19.35	0		16QAM	1	0	19.50	19.67	19.25	0
		1	50	19.44	19.59	19.27	0			1	37	19.38	19.51	19.22	0
		1	99	19.40	19.55	19.23	0			1	74	19.35	19.55	19.14	0
		50	0	19.34	19.49	19.17	0			36	0	19.33	19.42	19.11	0
		50	25	19.26	19.41	19.09	0			36	19	19.22	19.41	19.03	0
		50	50	19.23	19.38	19.06	0			36	39	19.18	19.35	18.96	0
	100	0	19.25	19.40	19.08	0	75		0	19.25	19.39	19.03	0		
	64QAM	1	0	19.47	19.62	19.30	0		64QAM	1	0	19.42	19.52	19.24	0
		1	50	19.43	19.58	19.26	0			1	37	19.33	19.54	19.23	0
		1	99	19.37	19.52	19.20	0			1	74	19.32	19.51	19.17	0
		50	0	19.33	19.48	19.16	0			36	0	19.31	19.45	19.15	0
50		25	19.27	19.42	19.10	0	36	19		19.18	19.40	19.08	0		
50		50	19.26	19.41	19.09	0	36	39		19.24	19.37	18.99	0		
100	0	19.21	19.36	19.04	0	75	0	19.14	19.31	18.95	0				
10M	QPSK	1	0	19.32	19.61	19.18	0	5M	QPSK	1	0	19.42	19.55	19.21	0
		1	24	19.07	19.33	18.96	0			1	12	19.20	19.41	18.99	0
		1	49	19.31	19.46	19.16	0			1	24	19.31	19.52	19.10	0
		25	0	19.32	19.60	19.15	0			12	0	19.34	19.53	18.93	0
		25	12	19.17	19.33	18.99	0			12	6	19.08	19.27	18.94	0
		25	25	19.31	19.31	19.10	0			12	13	19.11	19.40	19.00	0
	50	0	19.30	19.41	19.17	0	25		0	19.31	19.41	19.02	0		
	16QAM	1	0	19.35	19.56	19.12	0		16QAM	1	0	19.34	19.49	19.13	0
		1	24	19.36	19.53	19.22	0			1	12	19.37	19.39	19.11	0
		1	49	19.39	19.49	19.18	0			1	24	19.26	19.47	19.18	0
		25	0	19.13	19.34	18.97	0			12	0	19.22	19.37	19.11	0
		25	12	19.14	19.33	19.01	0			12	6	19.14	19.34	18.94	0
		25	25	19.12	19.27	19.03	0			12	13	19.00	19.18	18.98	0
	50	0	19.14	19.27	19.06	0	25		0	19.08	19.21	18.95	0		
	64QAM	1	0	19.23	19.58	19.09	0		64QAM	1	0	19.38	19.51	19.19	0
		1	24	19.42	19.39	19.17	0			1	12	19.31	19.51	19.12	0
		1	49	19.29	19.40	19.01	0			1	24	19.15	19.42	19.14	0
		25	0	19.19	19.46	19.01	0			12	0	19.15	19.38	19.01	0
25		12	19.07	19.27	18.93	0	12	6		19.05	19.33	18.97	0		
25		25	19.23	19.25	19.01	0	12	13		19.12	19.30	18.86	0		
50	0	19.21	19.31	18.89	0	25	0	18.96	19.21	18.89	0				
3M	QPSK	1	0	19.52	19.64	19.26	0	1.4M	QPSK	1	0	19.41	19.54	19.24	0
		1	7	19.15	19.35	19.06	0			1	2	19.18	19.28	18.97	0
		1	14	19.38	19.45	19.12	0			1	5	19.33	19.54	19.16	0
		8	0	19.25	19.54	19.18	0			3	0	19.40	19.49	19.16	0
		8	3	19.12	19.27	18.89	0			3	1	19.13	19.32	18.79	0
		8	7	19.11	19.40	19.03	0			3	3	19.17	19.36	18.93	0
	15	0	19.25	19.38	19.09	0	6		0	19.28	19.51	19.02	0		
	16QAM	1	0	19.38	19.57	19.21	0		16QAM	1	0	19.32	19.64	19.27	0
		1	7	19.42	19.47	19.18	0			1	2	19.19	19.37	19.10	0
		1	14	19.26	19.31	19.18	0			1	5	19.19	19.40	19.17	0
		8	0	19.20	19.28	19.07	0			3	0	19.17	19.38	19.05	0
		8	3	19.13	19.33	18.89	0			3	1	19.21	19.24	18.86	0
		8	7	19.16	19.38	18.96	0			3	3	19.07	19.26	18.91	0
	15	0	19.22	19.34	18.93	0	6		0	19.11	19.34	19.02	0		
	64QAM	1	0	19.27	19.49	19.15	0		64QAM	1	0	19.36	19.49	19.15	0
		1	7	19.34	19.38	19.20	0			1	2	19.27	19.37	19.14	0
		1	14	19.20	19.37	19.12	0			1	5	19.23	19.35	19.20	0
		8	0	19.27	19.31	19.01	0			3	0	19.28	19.39	18.93	0
8		3	19.10	19.38	19.02	0	3	1		19.10	19.36	18.95	0		
8		7	19.10	19.26	18.88	0	3	3		19.12	19.20	19.03	0		
15	0	19.19	19.19	18.87	0	6	0	19.20	19.24	18.85	0				

FCC SAR Test Report

LTE Band 4																	
BW	MCS Index	RB Size	RB Offset	Low	Mid	High	3GPP MPR (dB)	BW	MCS Index	RB Size	RB Offset	Low	Mid	High	3GPP MPR (dB)		
		Channel		20050	20175	20300				Channel		20025	20175	20325			
		Frequency (MHz)		1720.0	1732.5	1745.0				Frequency (MHz)		1717.5	1732.5	1747.5			
20M	QPSK	1	0	18.92	18.95	18.98	0	15M	QPSK	1	0	18.87	18.89	18.96	0		
		1	50	18.77	18.80	18.83	0			1	37	18.68	18.76	18.77	0		
		1	99	18.75	18.78	18.81	0			1	74	18.70	18.78	18.78	0		
		50	0	18.87	18.90	18.93	1			36	0	18.86	18.86	18.85	1		
		50	25	18.82	18.85	18.88	1			36	19	18.82	18.78	18.88	1		
		50	50	18.78	18.81	18.84	1			36	39	18.73	18.78	18.78	1		
		100	0	18.80	18.83	18.86	1			75	0	18.73	18.77	18.85	1		
	16QAM	1	0	18.87	18.90	18.93	1		16QAM	1	0	18.79	18.89	18.83	1		
		1	50	18.81	18.84	18.87	1			1	37	18.75	18.77	18.82	1		
		1	99	18.78	18.81	18.84	1			1	74	18.77	18.74	18.84	1		
		50	0	18.82	18.85	18.88	2			36	0	18.76	18.79	18.83	2		
		50	25	18.79	18.82	18.85	2			36	19	18.77	18.75	18.84	2		
		50	50	18.77	18.80	18.83	2			36	39	18.71	18.79	18.74	2		
		100	0	18.75	18.78	18.81	2			75	0	18.66	18.73	18.77	2		
	64QAM	1	0	18.85	18.88	18.91	2		64QAM	1	0	18.81	18.81	18.90	2		
		1	50	18.82	18.85	18.88	2			1	37	18.74	18.81	18.84	2		
		1	99	18.81	18.84	18.87	2			1	74	18.77	18.82	18.81	2		
		50	0	18.80	18.83	18.86	3			36	0	18.77	18.81	18.82	3		
		50	25	18.78	18.81	18.84	3			36	19	18.73	18.77	18.84	3		
		50	50	18.77	18.80	18.83	3			36	39	18.76	18.80	18.77	3		
		100	0	18.73	18.76	18.79	3			75	0	18.68	18.69	18.78	3		
	10M	QPSK	1	0	18.89	18.91	18.86		0	5M	QPSK	1	0	18.83	18.75	18.66	0
			1	24	18.68	18.58	18.68		0			1	12	18.67	18.58	18.58	0
			1	49	18.59	18.64	18.60		0			1	24	18.68	18.76	18.50	0
25			0	18.77	18.69	18.77	1	12	0			18.68	18.76	18.62	1		
25			12	18.70	18.76	18.82	1	12	6			18.65	18.78	18.59	1		
25			25	18.65	18.71	18.66	1	12	13			18.64	18.66	18.56	1		
50			0	18.66	18.68	18.68	1	25	0			18.73	18.68	18.58	1		
16QAM		1	0	18.68	18.77	18.87	1	16QAM	1		0	18.69	18.66	18.88	1		
		1	24	18.69	18.79	18.87	1		1		12	18.73	18.66	18.70	1		
		1	49	18.67	18.68	18.74	1		1		24	18.60	18.63	18.64	1		
		25	0	18.72	18.66	18.79	2		12		0	18.64	18.63	18.70	2		
		25	12	18.63	18.65	18.71	2		12		6	18.55	18.65	18.72	2		
		25	25	18.77	18.77	18.61	2		12		13	18.66	18.74	18.78	2		
		50	0	18.74	18.63	18.69	2		25		0	18.63	18.64	18.70	2		
64QAM		1	0	18.75	18.74	18.75	2	64QAM	1		0	18.84	18.75	18.82	2		
		1	24	18.66	18.68	18.80	2		1		12	18.65	18.66	18.70	2		
		1	49	18.72	18.62	18.70	2		1		24	18.66	18.62	18.63	2		
		25	0	18.74	18.73	18.70	3		12		0	18.78	18.69	18.70	3		
		25	12	18.63	18.78	18.69	3		12		6	18.68	18.74	18.65	3		
		25	25	18.72	18.58	18.67	3		12		13	18.64	18.67	18.64	3		
		50	0	18.61	18.68	18.62	3		25		0	18.58	18.69	18.73	3		
3M		QPSK	1	0	18.76	18.78	18.90	0	1.4M		QPSK	1	0	18.74	18.74	18.84	0
			1	7	18.61	18.60	18.78	0				1	2	18.64	18.62	18.69	0
			1	14	18.53	18.66	18.72	0				1	5	18.52	18.70	18.71	0
	8		0	18.70	18.84	18.73	1	3		0		18.72	18.79	18.85	0		
	8		3	18.63	18.82	18.74	1	3		1		18.72	18.76	18.82	0		
	8		7	18.70	18.58	18.69	1	3		3		18.67	18.64	18.73	0		
	15		0	18.73	18.71	18.71	1	6		0		18.69	18.64	18.62	1		
	16QAM	1	0	18.69	18.74	18.82	1	16QAM		1	0	18.69	18.77	18.82	1		
		1	7	18.60	18.72	18.79	1			1	2	18.71	18.75	18.73	1		
		1	14	18.68	18.67	18.68	1			1	5	18.59	18.80	18.70	1		
		8	0	18.65	18.70	18.78	2			3	0	18.69	18.76	18.79	1		
		8	3	18.64	18.74	18.65	2			3	1	18.70	18.68	18.71	1		
		8	7	18.71	18.56	18.77	2			3	3	18.61	18.58	18.66	1		
		15	0	18.72	18.58	18.73	2			6	0	18.57	18.60	18.77	2		
	64QAM	1	0	18.81	18.70	18.82	2	64QAM		1	0	18.80	18.77	18.71	2		
		1	7	18.60	18.75	18.78	2			1	2	18.63	18.68	18.72	2		
		1	14	18.69	18.65	18.73	2			1	5	18.65	18.68	18.70	2		
		8	0	18.65	18.70	18.63	3			3	0	18.59	18.74	18.73	2		
		8	3	18.61	18.65	18.76	3			3	1	18.73	18.73	18.60	2		
		8	7	18.53	18.68	18.70	3			3	3	18.57	18.67	18.67	2		
		15	0	18.66	18.61	18.64	3			6	0	18.58	18.65	18.67	3		

FCC SAR Test Report

LTE Band 7															
BW	MCS Index	RB Size	RB Offset	Low	Mid	High	3GPP MPR (dB)	BW	MCS Index	RB Size	RB Offset	Low	Mid	High	3GPP MPR (dB)
		Channel		20850	21100	21350				Channel		20825	21100	21375	
		Frequency (MHz)		2510.0	2535.0	2560.0				Frequency (MHz)		2507.5	2535.0	2562.5	
20M	QPSK	1	0	20.95	20.97	20.99	0	15M	QPSK	1	0	20.88	20.91	20.92	0
		1	50	20.89	20.95	20.95	0			1	37	20.80	20.89	20.93	0
		1	99	20.90	20.93	20.93	0			1	74	20.87	20.83	20.92	0
		50	0	20.85	20.95	20.96	0			36	0	20.76	20.89	20.80	0
		50	25	20.90	20.93	20.90	0			36	19	20.83	20.85	20.84	0
		50	50	20.84	20.92	20.91	0			36	39	20.77	20.82	20.86	0
		100	0	20.86	20.95	20.96	0			75	0	20.85	20.90	20.96	0
	16QAM	1	0	20.89	20.95	20.92	0		16QAM	1	0	20.83	20.88	20.92	0
		1	50	20.88	20.93	20.85	0			1	37	20.83	20.91	20.78	0
		1	99	20.89	20.92	20.90	0			1	74	20.89	20.87	20.84	0
		50	0	20.84	20.93	20.86	0			36	0	20.76	20.83	20.76	0
		50	25	20.88	20.92	20.88	0			36	19	20.86	20.91	20.82	0
		50	50	20.82	20.89	20.90	0			36	39	20.82	20.89	20.85	0
		100	0	20.78	20.87	20.88	0			75	0	20.72	20.78	20.85	0
	64QAM	1	0	20.44	20.55	20.49	0		64QAM	1	0	20.44	20.51	20.40	0
		1	50	20.43	20.48	20.40	0			1	37	20.36	20.47	20.33	0
		1	99	20.38	20.45	20.45	0			1	74	20.34	20.42	20.41	0
		50	0	20.46	20.53	20.52	0			36	0	20.39	20.51	20.42	0
		50	25	20.42	20.51	20.45	0			36	19	20.38	20.47	20.40	0
		50	50	20.40	20.46	20.41	0			36	39	20.35	20.41	20.34	0
		100	0	20.48	20.52	20.47	0			75	0	20.46	20.48	20.37	0
10M	QPSK	1	0	20.87	20.84	20.94	0	5M	QPSK	1	0	20.89	20.75	20.79	0
		1	24	20.78	20.89	20.76	0			1	12	20.72	20.87	20.73	0
		1	49	20.79	20.69	20.74	0			1	24	20.72	20.74	20.81	0
		25	0	20.84	20.79	20.79	0			12	0	20.71	20.82	20.65	0
		25	12	20.78	20.77	20.79	0			12	6	20.76	20.81	20.71	0
		25	25	20.80	20.88	20.82	0			12	13	20.75	20.73	20.81	0
		50	0	20.73	20.81	20.72	0			25	0	20.69	20.88	20.71	0
	16QAM	1	0	20.76	20.77	20.82	0		16QAM	1	0	20.76	20.94	20.86	0
		1	24	20.73	20.75	20.83	0			1	12	20.71	20.75	20.65	0
		1	49	20.74	20.80	20.70	0			1	24	20.74	20.86	20.81	0
		25	0	20.76	20.88	20.73	0			12	0	20.67	20.79	20.79	0
		25	12	20.80	20.85	20.80	0			12	6	20.74	20.74	20.66	0
		25	25	20.68	20.73	20.80	0			12	13	20.75	20.69	20.81	0
		50	0	20.72	20.79	20.67	0			25	0	20.65	20.79	20.69	0
	64QAM	1	0	20.28	20.38	20.32	0		64QAM	1	0	20.38	20.44	20.35	0
		1	24	20.41	20.36	20.24	0			1	12	20.32	20.37	20.29	0
		1	49	20.26	20.30	20.30	0			1	24	20.15	20.29	20.32	0
		25	0	20.41	20.50	20.37	0			12	0	20.30	20.31	20.31	0
		25	12	20.31	20.42	20.32	0			12	6	20.28	20.40	20.24	0
		25	25	20.30	20.38	20.37	0			12	13	20.36	20.30	20.33	0
		50	0	20.31	20.37	20.28	0			25	0	20.24	20.39	20.36	0

FCC SAR Test Report

<WLAN 2.4G>

Mode	Channel	Frequency (MHz)	Average Power
802.11b	1	2412	17.45
	6	2437	16.43
	11	2462	17.02

<WLAN 5.2G>

Mode	Channel	Frequency (MHz)	Average Power
802.11a	36	5180	15.57
	40	5200	15.51
	44	5220	15.01
	48	5240	15.44

<WLAN 5.3G>

Mode	Channel	Frequency (MHz)	Average Power
802.11a	52	5260	15.45
	56	5280	15.12
	60	5300	15.54
	64	5320	15.35

<WLAN 5.6G>

Mode	Channel	Frequency (MHz)	Average Power
802.11a	100	5500	14.76
	116	5580	14.98
	120	5600	14.96
	124	5620	14.92
	132	5660	14.88
	140	5700	14.71
	144	5720	14.78

<WLAN 5.8G>

Mode	Channel	Frequency (MHz)	Average Power
802.11a	149	5745	14.41
	153	5765	14.42
	157	5785	14.44
	161	5805	14.47

<Bluetooth>

Mode	Channel	Frequency (MHz)	Average Power
Bluetooth EDR	0	2402	8.53
	39	2441	9.11
	78	2480	8.31
Bluetooth LE	0	2402	1.47
	19	2440	1.63
	39	2480	0.91

4.7 SAR Testing Results

4.7.1 SAR Test Reduction Considerations

<KDB 447498 D01, General RF Exposure Guidance>

Testing of other required channels within the operating mode of a frequency band is not required when the reported SAR for the mid-band or highest output power channel is:

- (1) ≤ 0.8 W/kg or 2.0 W/kg, for 1-g or 10-g respectively, when the transmission band is ≤ 100 MHz
- (2) ≤ 0.6 W/kg or 1.5 W/kg, for 1-g or 10-g respectively, when the transmission band is between 100 MHz and 200 MHz
- (3) ≤ 0.4 W/kg or 1.0 W/kg, for 1-g or 10-g respectively, when the transmission band is ≥ 200 MHz

When SAR is not measured at the maximum power level allowed for production units, the measured SAR will be scaled to the maximum tune-up tolerance limit to determine compliance. The scaling factor for the tune-up power is defined as maximum tune-up limit (mW) / measured conducted power (mW). The reported SAR would be calculated by measured SAR x tune-up power scaling factor.

The SAR has been measured with highest transmission duty factor supported by the test mode tools for WLAN and/or Bluetooth. When the transmission duty factor could not achieve 100%, the reported SAR will be scaled to 100% transmission duty factor to determine compliance at the maximum tune-up power. The scaling factor for the duty factor is defined as 100% / transmission duty cycle (%). The reported SAR would be calculated by measured SAR x tune-up power scaling factor x duty cycle scaling factor.

<KDB 941225 D01, 3G SAR Measurement Procedures>

The mode tested for SAR is referred to as the primary mode. The equivalent modes considered for SAR test reduction are denoted as secondary modes. Both primary and secondary modes must be in the same frequency band. When the maximum output power and tune-up tolerance specified for production units in a secondary mode is $\leq 1/4$ dB higher than the primary mode or when the highest reported SAR of the primary mode is scaled by the ratio of specified maximum output power and tune-up tolerance of secondary to primary mode and the adjusted SAR is ≤ 1.2 W/kg, SAR measurement is not required for the secondary mode.

<KDB 941225 D05, SAR Evaluation Considerations for LTE Devices>

- (1) QPSK with 1 RB and 50% RB allocation

Start with the largest channel bandwidth and measure SAR, using the RB offset and required test channel combination with the highest maximum output power among RB offsets at the upper edge, middle and lower edge of each required test channel. When the reported SAR is ≤ 0.8 W/kg, testing of the remaining RB offset configurations and required test channels is not required; otherwise, SAR is required for the remaining required test channels and only for the RB offset configuration with the highest output power for that channel. When the reported SAR of a required test channel is > 1.45 W/kg, SAR is required for all three RB offset configurations for that required test channel.

FCC SAR Test Report

(2) QPSK with 100% RB allocation

SAR is not required when the highest maximum output power for 100% RB allocation is less than the highest maximum output power in 50% and 1 RB allocations and the highest reported SAR for 1 RB and 50% RB allocation are ≤ 0.8 W/kg. Otherwise, SAR is measured for the highest output power channel; and if the reported SAR is > 1.45 W/kg, the remaining required test channels must also be tested.

(3) Higher order modulations

SAR is required only when the highest maximum output power for the configuration in the higher order modulation is $> 1/2$ dB higher than the same configuration in QPSK or when the reported SAR for the QPSK configuration is > 1.45 W/kg.

(4) Other channel bandwidth

SAR is required when the highest maximum output power of the smaller channel bandwidth is $> 1/2$ dB higher than the equivalent channel configurations in the largest channel bandwidth configuration or the reported SAR of a configuration for the largest channel bandwidth is > 1.45 W/kg.

<Power Confirmation for SAR Test Exclusion for LTE Downlink CA>

According to KDB 941225 D05A, the uplink maximum output power below was measured with downlink CA active on the channel with highest measured maximum output power when downlink CA is inactive. The downlink SCC channel was paired with the uplink channel as normal operation. For intra-band contiguous CA, the downlink channel spacing between the component carriers was set to multiple of 300 kHz less than the nominal channel spacing per section 5.4.1A of 3GPP TS36.521. For intra-band non-contiguous CA, the downlink channel spacing between the component carriers was set to maximum separation from PCC and remain fully within the downlink transmission band. For Inter-band CA, the SCC downlink channel was set to near the middle of its transmission band.

Power Measurements for Intra-Band Contiguous Downlink CA

<Full Power>

CA Combination	PCC								SCC1				Power	
	LTE Band	BW (MHz)	UL Channel	UL Freq. (MHz)	RB Size	RB Offset	DL Channel	DL Freq. (MHz)	LTE Band	BW (MHz)	DL Channel	DL Freq. (MHz)	Tx Power with DL-CA Active (dBm)	Single Carrier Tx Power (dBm)
7C	7	20	21350	2560	1	0	3350	2680	7	20	3152	2660.2	24.19	24.16
38C	38	20	38150	2610	1	0	38150	2610	38	20	37952	2590.2	23.81	23.78

<Reduction Power-1>

CA Combination	PCC								SCC1				Power	
	LTE Band	BW (MHz)	UL Channel	UL Freq. (MHz)	RB Size	RB Offset	DL Channel	DL Freq. (MHz)	LTE Band	BW (MHz)	DL Channel	DL Freq. (MHz)	Tx Power with DL-CA Active (dBm)	Single Carrier Tx Power (dBm)
7C	7	20	21350	2560	1	0	3350	2680	7	20	3152	2660.2	20.99	20.82

<Reduction Power-2>

CA Combination	PCC								SCC1				Power	
	LTE Band	BW (MHz)	UL Channel	UL Freq. (MHz)	RB Size	RB Offset	DL Channel	DL Freq. (MHz)	LTE Band	BW (MHz)	DL Channel	DL Freq. (MHz)	Tx Power with DL-CA Active (dBm)	Single Carrier Tx Power (dBm)
7C	7	20	20850	2510	1	0	2850	2630	7	20	3048	2649.8	20.99	20.82

FCC SAR Test Report

Power Measurements for Inter-Band Downlink CA

<Full Power>

CA Combination	PCC								SCC1				Power	
	LTE Band	BW (MHz)	UL Channel	UL Freq. (MHz)	RB Size	RB Offset	DL Channel	DL Freq. (MHz)	LTE Band	BW (MHz)	DL Channel	DL Freq. (MHz)	Tx Power with DL-CA Active (dBm)	Single Carrier Tx Power (dBm)
CA-5A-7A	5	10	20525	836.5	1	0	2525	881.5	7	20	3100	2655	23.51	23.49

Summary for SAR Test Exclusion for LTE Downlink CA

Per power confirmation results in above, the uplink maximum output power with downlink CA active remains within the specified tune-up tolerance and not more than 0.25 dB higher than the maximum output power with downlink CA inactive. According to KDB 941225 D05A, the SAR test exclusion applies to LTE downlink CA operation.

FCC SAR Test Report

<Power Confirmation for SAR Testing for LTE Uplink CA>

The conducted power for uplink CA active was measured on the highest reported SAR configuration for each exposure condition with both two carrier components was set to largest channel bandwidth.

<Full Power>

PCC							SCC							Power	
Band	BW (MHz)	Modulation	RB Size	RB Offset	UL Channel	UL Frequency (MHz)	Band	BW (MHz)	Modulation	RB Size	RB Offset	UL Channel	UL Frequency (MHz)	Single Carrier Tx Power (dBm)	Tx Power with DL-CA Active (dBm)
7	20	QPSK	1	0	20850	2510	7	20	QPSK	1	99	21048	2529.8	24.08	15.87
			1	99						24.02	24.01				
7	20	QPSK	1	0	21100	2535	7	20	QPSK	1	99	21298	2554.8	24.15	15.76
			1	99						24.09	24.07				
7	20	QPSK	1	0	21152	2540.2	7	20	QPSK	1	99	21350	2560	24.19	15.74
			1	99						24.13	24.11				
38	20	QPSK	1	0	37850	2580	38	20	QPSK	1	99	38048	2599.8	23.76	15.23
			1	99						23.65	23.63				
38	20	QPSK	1	0	37901	2585.1	38	20	QPSK	1	99	38099	2604.9	23.78	15.22
			1	99						23.67	23.65				
38	20	QPSK	1	0	37952	2590.2	38	20	QPSK	1	99	38150	2610	23.81	15.15
			1	99						23.7	23.68				

<Reduction Power-1>

PCC							SCC							Power	
Band	BW (MHz)	Modulation	RB Size	RB Offset	UL Channel	UL Frequency (MHz)	Band	BW (MHz)	Modulation	RB Size	RB Offset	UL Channel	UL Frequency (MHz)	Single Carrier Tx Power (dBm)	Tx Power with DL-CA Active (dBm)
7	20	QPSK	1	0	20850	2510	7	20	QPSK	1	99	21048	2529.8	20.95	15.90
			1	99						20.9	20.85				
7	20	QPSK	1	0	21100	2535	7	20	QPSK	1	99	21298	2554.8	20.97	15.69
			1	99						20.93	20.85				
7	20	QPSK	1	0	21152	2540.2	7	20	QPSK	1	99	21350	2560	20.99	15.56
			1	99						20.93	20.86				

<Reduction Power-2>

PCC							SCC							Power	
Band	BW (MHz)	Modulation	RB Size	RB Offset	UL Channel	UL Frequency (MHz)	Band	BW (MHz)	Modulation	RB Size	RB Offset	UL Channel	UL Frequency (MHz)	Single Carrier Tx Power (dBm)	Tx Power with DL-CA Active (dBm)
7	20	QPSK	1	0	20850	2510	7	20	QPSK	1	99	21048	2529.8	20.95	15.90
			1	99						20.9	20.85				
7	20	QPSK	1	0	21100	2535	7	20	QPSK	1	99	21298	2554.8	20.97	15.69
			1	99						20.93	20.85				
7	20	QPSK	1	0	21152	2540.2	7	20	QPSK	1	99	21350	2560	20.99	15.56
			1	99						20.93	20.86				

SAR Measurements for Intra-Band Contiguous CA

The SAR testing was performed with the single carrier (uplink CA is inactive) for all test positions for each exposure condition. The LTE uplink CA active was verified with maximum output power on the highest SAR configuration of single carrier for each exposure condition. For intra-band contiguous CA, the SCC channel was set to closest available contiguous channel.

<KDB 248227 D01, SAR Guidance for Wi-Fi Transmitters>

- (1) For handsets operating next to ear, hotspot mode or mini-tablet configurations, the initial test position procedures were applied. The test position with the highest extrapolated peak SAR will be used as the initial test position. When the reported SAR of initial test position is ≤ 0.4 W/kg, SAR testing for remaining test positions is not required. Otherwise, SAR is evaluated at the subsequent highest peak SAR positions until the reported SAR result is ≤ 0.8 W/kg or all test positions are measured.
- (2) For WLAN 2.4 GHz, the highest measured maximum output power channel for DSSS was selected for SAR measurement. When the reported SAR is ≤ 0.8 W/kg, no further SAR testing is required. Otherwise, SAR is evaluated at the next highest measured output power channel. When any reported SAR is >1.2 W/kg, SAR is required for the third channel. For OFDM modes (802.11g/n), SAR is not required when the highest reported SAR for DSSS is adjusted by the ratio of OFDM to DSSS specified maximum output power and it is ≤ 1.2 W/kg.
- (3) For WLAN 5GHz, the initial test configuration was selected according to the transmission mode with the highest maximum output power. When the reported SAR of initial test configuration is > 0.8 W/kg, SAR is required for the subsequent highest measured output power channel until the reported SAR result is ≤ 1.2 W/kg or all required channels are measured. For other transmission modes, SAR is not required when the highest reported SAR for initial test configuration is adjusted by the ratio of subsequent test configuration to initial test configuration specified maximum output power and it is ≤ 1.2 W/kg.

FCC SAR Test Report

4.7.2 SAR Results for Head Exposure Condition

Plot No.	Band	Mode	Test Position	Ch.	P-Sensor	Max. Tune-up Power (dBm)	Measured Conducted Power (dBm)	Scaling Factor	Power Drift (dB)	Measured SAR-1g (W/kg)	Scaled SAR-1g (W/kg)
	GSM850	GPRS12	Right Cheek	189	OFF	28.0	26.94	1.28	-0.08	0.105	0.13
	GSM850	GPRS12	Right Tilted	189	OFF	28.0	26.94	1.28	0.17	0.045	0.06
	GSM850	GPRS12	Left Cheek	189	OFF	28.0	26.94	1.28	0.01	0.066	0.08
	GSM850	GPRS12	Left Tilted	189	OFF	28.0	26.94	1.28	-0.05	0.041	0.05
	GSM850	GPRS12	Right Cheek	128	OFF	28.0	26.75	1.33	0.08	0.075	0.10
01	GSM850	GPRS12	Right Cheek	251	OFF	28.0	26.69	1.35	-0.16	0.125	0.17
	GSM1900	GPRS8	Right Cheek	512	OFF	31.5	31.48	1.00	-0.17	0.058	0.06
	GSM1900	GPRS8	Right Tilted	512	OFF	31.5	31.48	1.00	0.16	0.043	0.04
02	GSM1900	GPRS8	Left Cheek	512	OFF	31.5	31.48	1.00	0.17	0.083	0.08
	GSM1900	GPRS8	Left Tilted	512	OFF	31.5	31.48	1.00	-0.05	0.051	0.05
	GSM1900	GPRS8	Left Cheek	661	OFF	31.5	31.47	1.01	0.13	0.063	0.06
	GSM1900	GPRS8	Left Cheek	810	OFF	31.5	31.43	1.02	-0.03	0.055	0.06
03	WCDMA II	RMC12.2K	Right Cheek	9538	OFF	24.5	24.49	1.00	0.10	0.124	0.12
	WCDMA II	RMC12.2K	Right Tilted	9538	OFF	24.5	24.49	1.00	0.03	0.087	0.09
	WCDMA II	RMC12.2K	Left Cheek	9538	OFF	24.5	24.49	1.00	-0.10	0.111	0.11
	WCDMA II	RMC12.2K	Left Tilted	9538	OFF	24.5	24.49	1.00	-0.13	0.065	0.07
	WCDMA II	RMC12.2K	Right Cheek	9262	OFF	24.5	24.45	1.01	-0.08	0.121	0.12
	WCDMA II	RMC12.2K	Right Cheek	9400	OFF	24.5	24.43	1.02	0.01	0.117	0.12
	WCDMA IV	RMC12.2K	Right Cheek	1513	OFF	24.5	24.48	1.00	0.02	0.111	0.11
	WCDMA IV	RMC12.2K	Right Tilted	1513	OFF	24.5	24.48	1.00	-0.08	0.067	0.07
04	WCDMA IV	RMC12.2K	Left Cheek	1513	OFF	24.5	24.48	1.00	0.05	0.137	0.14
	WCDMA IV	RMC12.2K	Left Tilted	1513	OFF	24.5	24.48	1.00	-0.11	0.062	0.06
	WCDMA IV	RMC12.2K	Left Cheek	1312	OFF	24.5	24.37	1.03	0.02	0.131	0.13
	WCDMA IV	RMC12.2K	Left Cheek	1413	OFF	24.5	24.34	1.04	-0.18	0.117	0.12
05	WCDMA V	RMC12.2K	Right Cheek	4233	OFF	24.0	23.71	1.07	-0.03	0.135	0.14
	WCDMA V	RMC12.2K	Right Tilted	4233	OFF	24.0	23.71	1.07	0.11	0.081	0.09
	WCDMA V	RMC12.2K	Left Cheek	4233	OFF	24.0	23.71	1.07	0.02	0.098	0.10
	WCDMA V	RMC12.2K	Left Tilted	4233	OFF	24.0	23.71	1.07	0.07	0.066	0.07
	WCDMA V	RMC12.2K	Right Cheek	4132	OFF	24.0	23.58	1.10	0.06	0.105	0.12
	WCDMA V	RMC12.2K	Right Cheek	4182	OFF	24.0	23.57	1.10	-0.09	0.121	0.13

FCC SAR Test Report

Plot No.	Band	Mode	Test Position	Ch.	RB#	RB Offset	P-Sensor	Max. Tune-up Power (dBm)	Measured Conducted Power (dBm)	Scaling Factor	Power Drift (dB)	Measured SAR-1g (W/kg)	Scaled SAR-1g (W/kg)
06	LTE 2	QPSK20M	Right Cheek	18700	1	0	OFF	24.5	24.49	1.00	-0.12	0.130	0.13
	LTE 2	QPSK20M	Right Tilted	18700	1	0	OFF	24.5	24.49	1.00	-0.11	0.112	0.11
	LTE 2	QPSK20M	Left Cheek	18700	1	0	OFF	24.5	24.49	1.00	0.02	0.121	0.12
	LTE 2	QPSK20M	Left Tilted	18700	1	0	OFF	24.5	24.49	1.00	0.03	0.123	0.12
	LTE 2	QPSK20M	Right Cheek	18700	50	0	OFF	23.5	22.73	1.19	0.01	0.076	0.09
	LTE 2	QPSK20M	Right Tilted	18700	50	0	OFF	23.5	22.73	1.19	-0.11	0.071	0.08
	LTE 2	QPSK20M	Left Cheek	18700	50	0	OFF	23.5	22.73	1.19	0.05	0.075	0.09
	LTE 2	QPSK20M	Left Tilted	18700	50	0	OFF	23.5	22.73	1.19	0.02	0.072	0.09
	LTE 2	QPSK20M	Right Cheek	18900	1	0	OFF	24.5	24.43	1.02	-0.14	0.122	0.12
	LTE 2	QPSK20M	Right Cheek	19100	1	0	OFF	24.5	24.36	1.03	0.11	0.103	0.11
	LTE 4	QPSK20M	Right Cheek	20175	1	0	OFF	24.5	24.29	1.05	0.03	0.123	0.13
	LTE 4	QPSK20M	Right Tilted	20175	1	0	OFF	24.5	24.29	1.05	-0.05	0.055	0.06
	LTE 4	QPSK20M	Left Cheek	20175	1	0	OFF	24.5	24.29	1.05	0.12	0.136	0.14
	LTE 4	QPSK20M	Left Tilted	20175	1	0	OFF	24.5	24.29	1.05	-0.16	0.069	0.07
	LTE 4	QPSK20M	Right Cheek	20175	50	0	OFF	23.5	22.43	1.28	0.10	0.081	0.10
	LTE 4	QPSK20M	Right Tilted	20175	50	0	OFF	23.5	22.43	1.28	-0.06	0.033	0.04
	LTE 4	QPSK20M	Left Cheek	20175	50	0	OFF	23.5	22.43	1.28	-0.18	0.085	0.11
	LTE 4	QPSK20M	Left Tilted	20175	50	0	OFF	23.5	22.43	1.28	-0.09	0.045	0.06
07	LTE 4	QPSK20M	Left Cheek	20050	1	0	OFF	24.5	24.17	1.08	0.11	0.150	0.16
	LTE 4	QPSK20M	Left Cheek	20300	1	0	OFF	24.5	24.22	1.07	0.02	0.126	0.13
08	LTE 5	QPSK10M	Right Cheek	20525	1	0	OFF	24.0	23.51	1.12	-0.07	0.102	0.11
	LTE 5	QPSK10M	Right Tilted	20525	1	0	OFF	24.0	23.51	1.12	0.19	0.044	0.05
	LTE 5	QPSK10M	Left Cheek	20525	1	0	OFF	24.0	23.51	1.12	0.13	0.068	0.08
	LTE 5	QPSK10M	Left Tilted	20525	1	0	OFF	24.0	23.51	1.12	-0.02	0.052	0.06
	LTE 5	QPSK10M	Right Cheek	20525	25	0	OFF	23.0	22.13	1.22	0.02	0.069	0.08
	LTE 5	QPSK10M	Right Tilted	20525	25	0	OFF	23.0	22.13	1.22	0.00	<0.001	0.00
	LTE 5	QPSK10M	Left Cheek	20525	25	0	OFF	23.0	22.13	1.22	0.03	0.049	0.06
	LTE 5	QPSK10M	Left Tilted	20525	25	0	OFF	23.0	22.13	1.22	0.00	<0.001	0.00
	LTE 5	QPSK10M	Right Cheek	20450	1	0	OFF	24.0	23.45	1.14	-0.08	0.078	0.09
	LTE 5	QPSK10M	Right Cheek	20600	1	0	OFF	24.0	23.38	1.15	0.13	0.091	0.10

Note: The "< 0.001" means there is no SAR value or the SAR is too low to be measured.

Plot No.	Uplink Mode	Band	Mode	Test Position	Ch.	RB#	RB Offset	P-Sensor	Max. Tune-up Power (dBm)	Measured Conducted Power (dBm)	Scaling Factor	Power Drift (dB)	Measured SAR-1g (W/kg)	Scaled SAR-1g (W/kg)
	Single Carrier (CA inactive)	LTE 7	QPSK20M	Right Cheek	21350	1	0	OFF	24.5	24.19	1.07	-0.05	0.102	0.11
		LTE 7	QPSK20M	Right Tilted	21350	1	0	OFF	24.5	24.19	1.07	0.02	0.099	0.11
		LTE 7	QPSK20M	Left Cheek	21350	1	0	OFF	24.5	24.19	1.07	-0.04	0.128	0.14
		LTE 7	QPSK20M	Left Tilted	21350	1	0	OFF	24.5	24.19	1.07	0.00	0.065	0.07
		LTE 7	QPSK20M	Right Cheek	21350	50	0	OFF	23.5	22.35	1.30	-0.16	0.072	0.09
		LTE 7	QPSK20M	Right Tilted	21350	50	0	OFF	23.5	22.35	1.30	-0.15	0.068	0.09
		LTE 7	QPSK20M	Left Cheek	21350	50	0	OFF	23.5	22.35	1.30	-0.11	0.083	0.11
		LTE 7	QPSK20M	Left Tilted	21350	50	0	OFF	23.5	22.35	1.30	0.07	0.048	0.06
09	2 CC (CA active)	LTE 7	QPSK20M	Left Cheek	20850	1	0	OFF	24.5	24.08	1.10	0.11	0.136	0.15
		LTE 7	QPSK20M	Left Cheek	21100	1	0	OFF	24.5	24.15	1.08	0.02	0.122	0.13
	2 CC (CA active)	LTE 7	QPSK20M	Left Cheek	PCC:21152 SCC:21350	PCC:1 SCC:1	PCC:99 SCC:0	OFF	24.5	24.11	1.09	-0.08	0.125	0.14

FCC SAR Test Report

Plot No.	Uplink Mode	Band	Mode	Test Position	Ch.	RB#	RB Offset	P-Sensor	Max. Tune-up Power (dBm)	Measured Conducted Power (dBm)	Scaling Factor	Power Drift (dB)	Measured SAR-1g (W/kg)	Scaled SAR-1g (W/kg)
	Single Carrier (CA inactive)	LTE 38	QPSK20M	Right Cheek	38150	1	0	OFF	24.0	23.81	1.04	-0.09	0.043	0.04
		LTE 38	QPSK20M	Right Tilted	38150	1	0	OFF	24.0	23.81	1.04	0.01	0.041	0.04
		LTE 38	QPSK20M	Left Cheek	38150	1	0	OFF	24.0	23.81	1.04	-0.18	0.069	0.07
		LTE 38	QPSK20M	Left Tilted	38150	1	0	OFF	24.0	23.81	1.04	0.13	0.031	0.03
		LTE 38	QPSK20M	Right Cheek	38150	50	0	OFF	23.0	22.38	1.15	0.04	0.032	0.04
		LTE 38	QPSK20M	Right Tilted	38150	50	0	OFF	23.0	22.38	1.15	-0.02	0.031	0.04
		LTE 38	QPSK20M	Left Cheek	38150	50	0	OFF	23.0	22.38	1.15	0.17	0.053	0.06
		LTE 38	QPSK20M	Left Tilted	38150	50	0	OFF	23.0	22.38	1.15	-0.10	0.017	0.02
10		LTE 38	QPSK20M	Left Cheek	37850	1	0	OFF	24.0	23.76	1.06	0.03	0.073	0.08
	LTE 38	QPSK20M	Left Cheek	38000	1	0	OFF	24.0	23.78	1.05	0.05	0.067	0.07	
	2 CC (CA active)	LTE 38	QPSK20M	Left Cheek	PCC:37952 SCC:38150	PCC:1 SCC:1	PCC:99 SCC:0	OFF	24.0	23.68	1.08	-0.09	0.069	0.07

Plot No.	Band	Mode	Test Position	Ch.	Duty Cycle	Crest Factor	Max. Tune-up Power (dBm)	Measured Conducted Power (dBm)	Scaling Factor	Power Drift (dB)	Measured SAR-1g (W/kg)	Scaled SAR-1g (W/kg)
	WLAN2.4G	802.11b	Right Cheek	1	100.00	1.00	18.0	17.45	1.14	-0.07	0.271	0.31
	WLAN2.4G	802.11b	Right Tilted	1	100.00	1.00	18.0	17.45	1.14	0.16	0.264	0.30
	WLAN2.4G	802.11b	Left Cheek	1	100.00	1.00	18.0	17.45	1.14	0.05	0.403	0.46
	WLAN2.4G	802.11b	Left Tilted	1	100.00	1.00	18.0	17.45	1.14	-0.18	0.382	0.44
11	WLAN2.4G	802.11b	Left Cheek	6	100.00	1.00	18.0	16.43	1.44	-0.10	0.555	0.80
	WLAN2.4G	802.11b	Left Cheek	11	100.00	1.00	18.0	17.02	1.25	0.03	0.389	0.49
	WLAN5.3G	802.11a	Right Cheek	60	97.97	1.02	16.5	15.54	1.25	-0.07	0.311	0.40
	WLAN5.3G	802.11a	Right Tilted	60	97.97	1.02	16.5	15.54	1.25	-0.01	0.307	0.39
12	WLAN5.3G	802.11a	Left Cheek	60	97.97	1.02	16.5	15.54	1.25	-0.05	0.801	1.02
	WLAN5.3G	802.11a	Left Tilted	60	97.97	1.02	16.5	15.54	1.25	0.03	0.794	1.01
	WLAN5.3G	802.11a	Left Cheek	52	97.97	1.02	16.5	15.45	1.27	-0.10	0.724	0.94
	WLAN5.3G	802.11a	Left Cheek	56	97.97	1.02	16.5	15.12	1.37	-0.16	0.711	0.99
	WLAN5.3G	802.11a	Left Cheek	64	97.97	1.02	16.5	15.35	1.30	-0.19	0.752	1.00
	WLAN5.3G	802.11a	Left Tilted	52	97.97	1.02	16.5	15.45	1.27	0.08	0.713	0.92
	WLAN5.3G	802.11a	Left Tilted	56	97.97	1.02	16.5	15.12	1.37	-0.13	0.703	0.98
	WLAN5.3G	802.11a	Left Tilted	64	97.97	1.02	16.5	15.35	1.30	0.09	0.719	0.95
	WLAN5.3G	802.11a	Left Cheek	60	97.97	1.02	16.5	15.54	1.25	0.11	0.785	1.00
	WLAN5.6G	802.11a	Right Cheek	116	97.70	1.02	16.5	14.98	1.42	0.05	0.283	0.41
	WLAN5.6G	802.11a	Right Tilted	116	97.70	1.02	16.5	14.98	1.42	0.01	0.271	0.39
13	WLAN5.6G	802.11a	Left Cheek	116	97.70	1.02	16.5	14.98	1.42	-0.05	0.635	0.92
	WLAN5.6G	802.11a	Left Tilted	116	97.70	1.02	16.5	14.98	1.42	0.16	0.586	0.85
	WLAN5.6G	802.11a	Left Cheek	100	97.70	1.02	16.5	14.76	1.49	-0.10	0.601	0.91
	WLAN5.6G	802.11a	Left Cheek	120	97.70	1.02	16.5	14.96	1.43	-0.04	0.592	0.86
	WLAN5.6G	802.11a	Left Cheek	124	97.70	1.02	16.5	14.92	1.44	0.03	0.555	0.82
	WLAN5.6G	802.11a	Left Cheek	132	97.70	1.02	16.5	14.88	1.45	0.15	0.554	0.82
	WLAN5.6G	802.11a	Left Cheek	140	97.70	1.02	16.5	14.71	1.51	0.13	0.587	0.90
	WLAN5.6G	802.11a	Left Cheek	144	97.70	1.02	16.5	14.78	1.49	0.13	0.593	0.90
	WLAN5.6G	802.11a	Left Tilted	100	97.70	1.02	16.5	14.76	1.49	-0.01	0.480	0.73
	WLAN5.6G	802.11a	Left Tilted	120	97.70	1.02	16.5	14.96	1.43	-0.04	0.451	0.66
	WLAN5.6G	802.11a	Left Tilted	124	97.70	1.02	16.5	14.92	1.44	0.07	0.402	0.59
	WLAN5.6G	802.11a	Left Tilted	132	97.70	1.02	16.5	14.88	1.45	0.02	0.396	0.59
	WLAN5.6G	802.11a	Left Tilted	140	97.70	1.02	16.5	14.71	1.51	-0.03	0.448	0.69
	WLAN5.6G	802.11a	Left Tilted	144	97.70	1.02	16.5	14.78	1.49	-0.09	0.454	0.69

FCC SAR Test Report

Plot No.	Band	Mode	Test Position	Ch.	Duty Cycle	Crest Factor	Max. Tune-up Power (dBm)	Measured Conducted Power (dBm)	Scaling Factor	Power Drift (dB)	Measured SAR-1g (W/kg)	Scaled SAR-1g (W/kg)
	WLAN5.8G	802.11a	Right Cheek	161	97.97	1.02	15.5	14.47	1.27	-0.09	0.213	0.28
	WLAN5.8G	802.11a	Right Tilted	161	97.97	1.02	15.5	14.47	1.27	-0.04	0.208	0.27
	WLAN5.8G	802.11a	Left Cheek	161	97.97	1.02	15.5	14.47	1.27	0.01	0.578	0.75
	WLAN5.8G	802.11a	Left Tilted	161	97.97	1.02	15.5	14.47	1.27	-0.03	0.569	0.74
14	WLAN5.8G	802.11a	Left Cheek	149	97.97	1.02	15.5	14.41	1.29	-0.05	0.590	0.78
	WLAN5.8G	802.11a	Left Cheek	157	97.97	1.02	15.5	14.44	1.28	0.05	0.547	0.71
	WLAN5.8G	802.11a	Left Cheek	153	97.97	1.02	15.5	14.42	1.28	0.03	0.483	0.63
	BT	BDR	Right Cheek	39	76.80	1.30	9.5	9.11	1.09	0.02	0.039	0.06
	BT	BDR	Right Tilted	39	76.80	1.30	9.5	9.11	1.09	0.02	0.037	0.05
15	BT	BDR	Left Cheek	39	76.80	1.30	9.5	9.11	1.09	-0.10	0.064	0.09
	BT	BDR	Left Tilted	39	76.80	1.30	9.5	9.11	1.09	0.01	0.060	0.09
	BT	BDR	Left Cheek	0	76.80	1.30	9.5	8.53	1.25	0.02	0.050	0.08
	BT	BDR	Left Cheek	78	76.80	1.30	9.5	8.31	1.32	0.09	0.045	0.08

4.7.3 SAR Results for Body-worn Exposure Condition (Test Separation Distance is 10 mm)

Plot No.	Band	Mode	Test Position	Ch.	P-Sensor	Max. Tune-up Power (dBm)	Measured Conducted Power (dBm)	Scaling Factor	Power Drift (dB)	Measured SAR-1g (W/kg)	Scaled SAR-1g (W/kg)
	GSM850	GPRS12	Front Face	189	OFF	28.0	26.94	1.28	0.11	0.223	0.29
	GSM850	GPRS12	Rear Face	189	OFF	28.0	26.94	1.28	0.05	0.234	0.30
	GSM850	GPRS12	Rear Face	128	OFF	28.0	26.75	1.33	0.01	0.160	0.21
16	GSM850	GPRS12	Rear Face	251	OFF	28.0	26.69	1.35	-0.01	0.253	0.34
	GSM1900	GPRS8	Front Face	810	ON	30.5	30.38	1.03	-0.03	0.541	0.56
	GSM1900	GPRS8	Rear Face	810	ON	30.5	30.38	1.03	0.12	0.901	0.93
17	GSM1900	GPRS8	Rear Face	512	ON	30.5	30.31	1.04	0.01	1.04	1.08
	GSM1900	GPRS8	Rear Face	661	ON	30.5	30.28	1.05	0.11	1.01	1.06
	GSM1900	GPRS8	Rear Face	512	ON	30.5	30.31	1.04	0.11	1.02	1.06
	WCDMA II	RMC12.2K	Front Face	9400	ON	20.0	19.81	1.04	0.02	0.414	0.43
18	WCDMA II	RMC12.2K	Rear Face	9400	ON	20.0	19.81	1.04	-0.04	0.707	0.74
	WCDMA II	RMC12.2K	Rear Face	9262	ON	20.0	19.75	1.06	-0.08	0.684	0.73
	WCDMA II	RMC12.2K	Rear Face	9538	ON	20.0	19.72	1.07	0.03	0.654	0.70
	WCDMA IV	RMC12.2K	Front Face	1513	ON	21.0	20.88	1.03	-0.01	0.639	0.66
19	WCDMA IV	RMC12.2K	Rear Face	1513	ON	21.0	20.88	1.03	-0.09	0.909	0.94
	WCDMA IV	RMC12.2K	Rear Face	1312	ON	21.0	20.56	1.11	-0.03	0.839	0.93
	WCDMA IV	RMC12.2K	Rear Face	1413	ON	21.0	20.62	1.09	0.02	0.848	0.92
	WCDMA IV	RMC12.2K	Rear Face	1513	ON	21.0	20.88	1.03	-0.05	0.889	0.92
	WCDMA V	RMC12.2K	Front Face	4233	OFF	24.0	23.71	1.07	0.03	0.232	0.25
20	WCDMA V	RMC12.2K	Rear Face	4233	OFF	24.0	23.71	1.07	0.16	0.248	0.27
	WCDMA V	RMC12.2K	Rear Face	4132	OFF	24.0	23.58	1.10	-0.12	0.206	0.23
	WCDMA V	RMC12.2K	Rear Face	4182	OFF	24.0	23.57	1.10	0.05	0.238	0.26

FCC SAR Test Report

Plot No.	Band	Mode	Test Position	Ch.	RB#	RB Offset	P-Sensor	Max. Tune-up Power (dBm)	Measured Conducted Power (dBm)	Scaling Factor	Power Drift (dB)	Measured SAR-1g (W/kg)	Scaled SAR-1g (W/kg)
21	LTE 2	QPSK20M	Front Face	18900	1	0	ON	20.0	19.69	1.07	-0.03	0.498	0.53
	LTE 2	QPSK20M	Rear Face	18900	1	0	ON	20.0	19.69	1.07	-0.08	0.847	0.91
	LTE 2	QPSK20M	Front Face	18900	50	0	ON	20.0	19.56	1.11	-0.05	0.481	0.53
	LTE 2	QPSK20M	Rear Face	18900	50	0	ON	20.0	19.56	1.11	-0.06	0.806	0.89
	LTE 2	QPSK20M	Rear Face	18700	1	0	ON	20.0	19.55	1.11	0.03	0.812	0.90
	LTE 2	QPSK20M	Rear Face	19100	1	0	ON	20.0	19.39	1.15	0.07	0.783	0.90
	LTE 2	QPSK20M	Rear Face	18700	50	0	ON	20.0	19.42	1.14	-0.02	0.781	0.89
	LTE 2	QPSK20M	Rear Face	19100	50	0	ON	20.0	19.26	1.19	-0.08	0.755	0.90
	LTE 2	QPSK20M	Rear Face	18900	100	0	ON	20.0	19.49	1.12	-0.05	0.753	0.84
	LTE 2	QPSK20M	Rear Face	18900	1	0	ON	20.0	19.69	1.07	-0.03	0.827	0.88
22	LTE 4	QPSK20M	Front Face	20300	1	0	ON	20.5	20.32	1.04	0.02	0.488	0.51
	LTE 4	QPSK20M	Rear Face	20300	1	0	ON	20.5	20.32	1.04	-0.13	0.766	0.80
	LTE 4	QPSK20M	Front Face	20300	50	0	ON	20.5	20.28	1.05	0.06	0.479	0.50
	LTE 4	QPSK20M	Rear Face	20300	50	0	ON	20.5	20.28	1.05	0.01	0.757	0.79
	LTE 4	QPSK20M	Rear Face	20050	1	0	ON	20.5	20.25	1.06	0.13	0.738	0.78
	LTE 4	QPSK20M	Rear Face	20175	1	0	ON	20.5	20.23	1.06	0.05	0.727	0.77
	LTE 4	QPSK20M	Rear Face	20300	100	0	ON	20.5	20.21	1.07	-0.06	0.742	0.79
23	LTE 5	QPSK10M	Front Face	20525	1	0	OFF	24.0	23.51	1.12	0.18	0.141	0.16
	LTE 5	QPSK10M	Rear Face	20525	1	0	OFF	24.0	23.51	1.12	0.14	0.189	0.21
	LTE 5	QPSK10M	Front Face	20525	25	0	OFF	23.0	22.13	1.22	0.07	0.104	0.13
	LTE 5	QPSK10M	Rear Face	20525	25	0	OFF	23.0	22.13	1.22	0.15	0.122	0.15
	LTE 5	QPSK10M	Rear Face	20450	1	0	OFF	24.0	23.45	1.14	-0.13	0.164	0.19
	LTE 5	QPSK10M	Rear Face	20600	1	0	OFF	24.0	23.38	1.15	0.18	0.178	0.20

Plot No.	Uplink Mode	Band	Mode	Test Position	Ch.	RB#	RB Offset	P-Sensor	Max. Tune-up Power (dBm)	Measured Conducted Power (dBm)	Scaling Factor	Power Drift (dB)	Measured SAR-1g (W/kg)	Scaled SAR-1g (W/kg)
24	Single Carrier (CA inactive)	LTE 7	QPSK20M	Front Face	21350	1	0	ON	21.0	20.99	1.00	-0.03	0.306	0.31
		LTE 7	QPSK20M	Rear Face	21350	1	0	ON	21.0	20.99	1.00	0.08	0.561	0.56
		LTE 7	QPSK20M	Front Face	21350	50	0	ON	21.0	20.96	1.01	0.01	0.295	0.30
		LTE 7	QPSK20M	Rear Face	21350	50	0	ON	21.0	20.96	1.01	0.07	0.552	0.56
		LTE 7	QPSK20M	Rear Face	20850	1	0	ON	21.0	20.95	1.01	0.05	0.602	0.61
		LTE 7	QPSK20M	Rear Face	21100	1	0	ON	21.0	20.97	1.01	-0.06	0.609	0.62
25	Single Carrier (CA inactive)	LTE 7	QPSK20M	Rear Face	PCC:21152 SCC:21350	PCC:1 SCC:1	PCC:99 SCC:0	ON	21.0	20.86	1.03	-0.05	0.579	0.60
		LTE 38	QPSK20M	Front Face	38150	1	0	OFF	24.0	23.81	1.04	0.02	0.451	0.47
		LTE 38	QPSK20M	Rear Face	38150	1	0	OFF	24.0	23.81	1.04	-0.05	0.809	0.84
		LTE 38	QPSK20M	Front Face	38150	50	0	OFF	23.0	22.38	1.15	-0.11	0.327	0.38
		LTE 38	QPSK20M	Rear Face	38150	50	0	OFF	23.0	22.38	1.15	0.05	0.591	0.68
		LTE 38	QPSK20M	Rear Face	37850	1	0	OFF	24.0	23.76	1.06	0.12	0.787	0.83
		LTE 38	QPSK20M	Rear Face	38000	1	0	OFF	24.0	23.78	1.05	-0.08	0.782	0.82
	LTE 38	QPSK20M	Rear Face	38150	100	0	OFF	23.0	22.29	1.18	0.02	0.587	0.69	
LTE 38	QPSK20M	Rear Face	38150	1	0	OFF	24.0	23.81	1.04	-0.03	0.798	0.83		
2 CC (CA active)	LTE 38	QPSK20M	Rear Face	PCC:37952 SCC:38150	PCC:1 SCC:1	PCC:99 SCC:0	OFF	24.0	23.68	1.08	-0.02	0.699	0.75	

FCC SAR Test Report

Plot No.	Band	Mode	Test Position	Ch.	Duty Cycle	Crest Factor	Max. Tune-up Power (dBm)	Measured Conducted Power (dBm)	Scaling Factor	Power Drift (dB)	Measured SAR-1g (W/kg)	Scaled SAR-1g (W/kg)
	WLAN2.4G	802.11b	Front Face	1	100.00	1.00	18.0	17.45	1.14	0.03	0.163	0.19
	WLAN2.4G	802.11b	Rear Face	1	100.00	1.00	18.0	17.45	1.14	0.05	0.264	0.30
26	WLAN2.4G	802.11b	Rear Face	6	100.00	1.00	18.0	16.43	1.44	-0.06	0.333	0.48
	WLAN2.4G	802.11b	Rear Face	11	100.00	1.00	18.0	17.02	1.25	-0.11	0.259	0.32
	WLAN5.3G	802.11a	Front Face	60	97.70	1.02	16.5	15.54	1.25	0.03	0.151	0.19
27	WLAN5.3G	802.11a	Rear Face	60	97.70	1.02	16.5	15.54	1.25	-0.03	0.325	0.41
	WLAN5.3G	802.11a	Rear Face	52	97.70	1.02	16.5	15.45	1.27	0.05	0.294	0.38
	WLAN5.3G	802.11a	Rear Face	56	97.70	1.02	16.5	15.12	1.37	0.12	0.281	0.39
	WLAN5.3G	802.11a	Rear Face	64	97.70	1.02	16.5	15.35	1.30	0.09	0.281	0.37
	WLAN5.6G	802.11a	Front Face	116	97.70	1.02	16.5	14.98	1.42	0.02	0.094	0.14
28	WLAN5.6G	802.11a	Rear Face	116	97.70	1.02	16.5	14.98	1.42	0.03	0.252	0.36
	WLAN5.6G	802.11a	Rear Face	100	97.70	1.02	16.5	14.76	1.49	0.13	0.177	0.27
	WLAN5.6G	802.11a	Rear Face	120	97.70	1.02	16.5	14.96	1.43	0.09	0.215	0.31
	WLAN5.6G	802.11a	Rear Face	124	97.70	1.02	16.5	14.92	1.44	0.01	0.226	0.33
	WLAN5.6G	802.11a	Rear Face	132	97.70	1.02	16.5	14.88	1.45	0.05	0.224	0.33
	WLAN5.6G	802.11a	Rear Face	140	97.70	1.02	16.5	14.71	1.51	0.01	0.221	0.34
	WLAN5.6G	802.11a	Rear Face	144	97.70	1.02	16.5	14.78	1.49	0.01	0.231	0.35
	WLAN5.8G	802.11a	Front Face	161	97.70	1.02	15.5	14.47	1.27	0.02	0.096	0.12
29	WLAN5.8G	802.11a	Rear Face	161	97.70	1.02	15.5	14.47	1.27	-0.04	0.276	0.36
	WLAN5.8G	802.11a	Rear Face	149	97.70	1.02	15.5	14.41	1.29	0.01	0.229	0.30
	WLAN5.8G	802.11a	Rear Face	153	97.70	1.02	15.5	14.42	1.28	-0.13	0.206	0.27
	WLAN5.8G	802.11a	Rear Face	157	97.70	1.02	15.5	14.44	1.28	0.08	0.232	0.30
	BT	BDR	Front Face	39	76.80	1.30	9.5	9.11	1.09	0.13	0.012	0.02
30	BT	BDR	Rear Face	39	76.80	1.30	9.5	9.11	1.09	0.03	0.022	0.03
	BT	BDR	Rear Face	0	76.80	1.30	9.5	8.53	1.25	0.11	0.018	0.03
	BT	BDR	Rear Face	78	76.80	1.30	9.5	8.31	1.32	0.09	0.017	0.03

FCC SAR Test Report

4.7.4 SAR Results for Hotspot Exposure Condition (Test Separation Distance is 10 mm)

Plot No.	Band	Mode	Test Position	Ch.	P-Sensor	Max. Tune-up Power (dBm)	Measured Conducted Power (dBm)	Scaling Factor	Power Drift (dB)	Measured SAR-1g (W/kg)	Scaled SAR-1g (W/kg)
	GSM850	GPRS12	Front Face	189	OFF	28.0	26.94	1.28	0.11	0.223	0.29
	GSM850	GPRS12	Rear Face	189	OFF	28.0	26.94	1.28	0.05	0.234	0.30
	GSM850	GPRS12	Left Side	189	OFF	28.0	26.94	1.28	0.11	0.042	0.05
	GSM850	GPRS12	Bottom Side	189	OFF	28.0	26.94	1.28	-0.03	0.144	0.18
	GSM850	GPRS12	Rear Face	128	OFF	28.0	26.75	1.33	0.01	0.160	0.21
16	GSM850	GPRS12	Rear Face	251	OFF	28.0	26.69	1.35	-0.01	0.253	0.34
	GSM1900	GPRS8	Front Face	810	ON	30.5	30.38	1.03	-0.03	0.541	0.56
	GSM1900	GPRS8	Rear Face	810	ON	30.5	30.38	1.03	0.12	0.901	0.93
	GSM1900	GPRS8	Left Side	512	OFF	31.5	31.48	1.00	0.14	0.200	0.20
31	GSM1900	GPRS8	Bottom Side	810	ON	30.5	30.38	1.03	0.03	1.15	1.18
	GSM1900	GPRS8	Rear Face	512	ON	30.5	30.31	1.04	0.11	1.04	1.08
	GSM1900	GPRS8	Rear Face	661	ON	30.5	30.28	1.05	0.11	1.01	1.06
	GSM1900	GPRS8	Bottom Side	512	ON	30.5	30.31	1.04	0.11	1.13	1.18
	GSM1900	GPRS8	Bottom Side	661	ON	30.5	30.28	1.05	0.11	1.02	1.07
	GSM1900	GPRS8	Bottom Side	810	ON	30.5	30.38	1.03	-0.05	1.11	1.14
	WCDMA II	RMC12.2K	Front Face	9400	ON	20.0	19.81	1.04	0.02	0.414	0.43
	WCDMA II	RMC12.2K	Rear Face	9400	ON	20.0	19.81	1.04	-0.04	0.707	0.74
	WCDMA II	RMC12.2K	Left Side	9538	OFF	24.5	24.49	1.00	-0.02	0.244	0.24
32	WCDMA II	RMC12.2K	Bottom Side	9400	ON	20.0	19.81	1.04	-0.07	0.954	0.99
	WCDMA II	RMC12.2K	Bottom Side	9262	ON	20.0	19.75	1.06	-0.02	0.908	0.96
	WCDMA II	RMC12.2K	Bottom Side	9538	ON	20.0	19.72	1.07	0.01	0.919	0.98
	WCDMA II	RMC12.2K	Bottom Side	9400	ON	20.0	19.81	1.04	-0.02	0.939	0.98
	WCDMA IV	RMC12.2K	Front Face	1513	ON	21.0	20.88	1.03	-0.01	0.639	0.66
	WCDMA IV	RMC12.2K	Rear Face	1513	ON	21.0	20.88	1.03	-0.09	0.909	0.94
	WCDMA IV	RMC12.2K	Left Side	1513	OFF	24.5	24.48	1.00	-0.12	0.272	0.27
33	WCDMA IV	RMC12.2K	Bottom Side	1513	ON	21.0	20.88	1.03	-0.05	0.928	0.96
	WCDMA IV	RMC12.2K	Rear Face	1312	ON	21.0	20.56	1.11	-0.03	0.839	0.93
	WCDMA IV	RMC12.2K	Rear Face	1413	ON	21.0	20.62	1.09	0.02	0.848	0.92
	WCDMA IV	RMC12.2K	Bottom Side	1312	ON	21.0	20.56	1.11	0.11	0.852	0.95
	WCDMA IV	RMC12.2K	Bottom Side	1413	ON	21.0	20.62	1.09	0.05	0.866	0.94
	WCDMA IV	RMC12.2K	Bottom Side	1513	ON	21.0	20.88	1.03	-0.07	0.908	0.94
	WCDMA V	RMC12.2K	Front Face	4233	OFF	24.0	23.71	1.07	-0.03	0.232	0.25
34	WCDMA V	RMC12.2K	Rear Face	4233	OFF	24.0	23.71	1.07	0.16	0.248	0.27
	WCDMA V	RMC12.2K	Left Side	4233	OFF	24.0	23.71	1.07	-0.19	0.038	0.04
	WCDMA V	RMC12.2K	Bottom Side	4233	OFF	24.0	23.71	1.07	0.02	0.132	0.14
	WCDMA V	RMC12.2K	Rear Face	4132	OFF	24.0	23.58	1.10	-0.12	0.206	0.23
	WCDMA V	RMC12.2K	Rear Face	4182	OFF	24.0	23.57	1.10	0.05	0.238	0.26

Note: The "< 0.001" means there is no SAR value or the SAR is too low to be measured.

FCC SAR Test Report

Plot No.	Band	Mode	Test Position	Ch.	RB#	RB Offset	P-Sensor	Max. Tune-up Power (dBm)	Measured Conducted Power (dBm)	Scaling Factor	Power Drift (dB)	Measured SAR-1g (W/kg)	Scaled SAR-1g (W/kg)
	LTE 2	QPSK20M	Front Face	18900	1	0	ON	20.0	19.69	1.07	-0.03	0.498	0.53
	LTE 2	QPSK20M	Rear Face	18900	1	0	ON	20.0	19.69	1.07	-0.08	0.847	0.91
	LTE 2	QPSK20M	Left Side	18700	1	0	OFF	24.5	24.49	1.00	-0.01	0.278	0.28
35	LTE 2	QPSK20M	Bottom Side	18900	1	0	ON	20.0	19.69	1.07	-0.01	0.972	1.04
	LTE 2	QPSK20M	Front Face	18900	50	0	ON	20.0	19.56	1.11	-0.05	0.481	0.53
	LTE 2	QPSK20M	Rear Face	18900	50	0	ON	20.0	19.56	1.11	-0.06	0.806	0.89
	LTE 2	QPSK20M	Left Side	18700	50	0	OFF	23.5	22.73	1.19	0.13	0.175	0.21
	LTE 2	QPSK20M	Bottom Side	18900	50	0	ON	20.0	19.56	1.11	0.02	0.924	1.03
	LTE 2	QPSK20M	Rear Face	18700	1	0	ON	20.0	19.55	1.11	0.03	0.812	0.90
	LTE 2	QPSK20M	Rear Face	19100	1	0	ON	20.0	19.39	1.15	0.07	0.783	0.90
	LTE 2	QPSK20M	Bottom Side	18700	1	0	ON	20.0	19.55	1.11	0.11	0.922	1.02
	LTE 2	QPSK20M	Bottom Side	19100	1	0	ON	20.0	19.39	1.15	0.05	0.898	1.03
	LTE 2	QPSK20M	Rear Face	18700	50	0	ON	20.0	19.42	1.14	-0.02	0.781	0.89
	LTE 2	QPSK20M	Rear Face	19100	50	0	ON	20.0	19.26	1.19	-0.08	0.755	0.90
	LTE 2	QPSK20M	Bottom Side	18700	50	0	ON	20.0	19.42	1.14	0.06	0.896	1.02
	LTE 2	QPSK20M	Bottom Side	19100	50	0	ON	20.0	19.26	1.19	0.03	0.865	1.03
	LTE 2	QPSK20M	Rear Face	18900	100	0	ON	20.0	19.49	1.12	-0.05	0.753	0.84
	LTE 2	QPSK20M	Bottom Side	18900	100	0	ON	20.0	19.49	1.12	0.04	0.917	1.03
	LTE 2	QPSK20M	Bottom Side	18900	1	0	ON	20.0	19.69	1.07	-0.03	0.961	1.03
	LTE 4	QPSK20M	Front Face	20300	1	0	ON	20.5	20.32	1.04	0.02	0.488	0.51
	LTE 4	QPSK20M	Rear Face	20300	1	0	ON	20.5	20.32	1.04	-0.13	0.766	0.80
	LTE 4	QPSK20M	Left Side	20175	1	0	OFF	24.5	24.29	1.05	-0.05	0.244	0.26
36	LTE 4	QPSK20M	Bottom Side	20300	1	0	ON	20.5	20.32	1.04	-0.11	0.839	0.87
	LTE 4	QPSK20M	Front Face	20300	50	0	ON	20.5	20.28	1.05	0.06	0.479	0.50
	LTE 4	QPSK20M	Rear Face	20300	50	0	ON	20.5	20.28	1.05	0.01	0.757	0.79
	LTE 4	QPSK20M	Left Side	20175	50	0	OFF	23.5	22.43	1.28	-0.08	0.158	0.20
	LTE 4	QPSK20M	Bottom Side	20300	50	0	ON	20.5	20.28	1.05	0.14	0.815	0.86
	LTE 4	QPSK20M	Rear Face	20050	1	0	ON	20.5	20.25	1.06	0.13	0.738	0.78
	LTE 4	QPSK20M	Rear Face	20175	1	0	ON	20.5	20.23	1.06	0.05	0.727	0.77
	LTE 4	QPSK20M	Bottom Side	20050	1	0	ON	20.5	20.25	1.06	0.02	0.779	0.83
	LTE 4	QPSK20M	Bottom Side	20175	1	0	ON	20.5	20.23	1.06	0.05	0.789	0.84
	LTE 4	QPSK20M	Bottom Side	20050	50	0	ON	20.5	20.21	1.07	0.03	0.805	0.86
	LTE 4	QPSK20M	Bottom Side	20175	50	0	ON	20.5	20.19	1.07	0.05	0.807	0.86
	LTE 4	QPSK20M	Rear Face	20300	100	0	ON	20.5	20.21	1.07	-0.06	0.742	0.79
	LTE 4	QPSK20M	Bottom Side	20300	100	0	ON	20.5	20.21	1.07	0.05	0.793	0.85
	LTE 4	QPSK20M	Bottom Side	20300	1	0	ON	20.5	20.32	1.04	-0.02	0.817	0.85

FCC SAR Test Report

Plot No.	Band	Mode	Test Position	Ch.	RB#	RB Offset	P-Sensor	Max. Tune-up Power (dBm)	Measured Conducted Power (dBm)	Scaling Factor	Power Drift (dB)	Measured SAR-1g (W/kg)	Scaled SAR-1g (W/kg)
37	LTE 5	QPSK10M	Front Face	20525	1	0	OFF	24.0	23.51	1.12	0.18	0.141	0.16
	LTE 5	QPSK10M	Rear Face	20525	1	0	OFF	24.0	23.51	1.12	0.14	0.189	0.21
	LTE 5	QPSK10M	Left Side	20525	1	0	OFF	24.0	23.51	1.12	0.06	0.041	0.05
	LTE 5	QPSK10M	Bottom Side	20525	1	0	OFF	24.0	23.51	1.12	0.03	0.109	0.12
	LTE 5	QPSK10M	Front Face	20525	25	0	OFF	23.0	22.13	1.22	0.07	0.104	0.13
	LTE 5	QPSK10M	Rear Face	20525	25	0	OFF	23.0	22.13	1.22	0.15	0.122	0.15
	LTE 5	QPSK10M	Left Side	20525	25	0	OFF	23.0	22.13	1.22	0	<0.001	0.00
	LTE 5	QPSK10M	Bottom Side	20525	25	0	OFF	23.0	22.13	1.22	0.15	0.085	0.10
	LTE 5	QPSK10M	Rear Face	20450	1	0	OFF	24.0	23.45	1.14	-0.13	0.164	0.19
	LTE 5	QPSK10M	Rear Face	20600	1	0	OFF	24.0	23.38	1.15	0.18	0.178	0.20

Note: The "< 0.001" means there is no SAR value or the SAR is too low to be measured.

Plot No.	Uplink Mode	Band	Mode	Test Position	Ch.	RB#	RB Offset	P-Sensor	Max. Tune-up Power (dBm)	Measured Conducted Power (dBm)	Scaling Factor	Power Drift (dB)	Measured SAR-1g (W/kg)	Scaled SAR-1g (W/kg)
38	Single Carrier (CA inactive)	LTE 7	QPSK20M	Front Face	21350	1	0	ON	21.0	20.99	1.00	-0.03	0.306	0.31
		LTE 7	QPSK20M	Rear Face	21350	1	0	ON	21.0	20.99	1.00	0.08	0.561	0.56
		LTE 7	QPSK20M	Left Side	21350	1	0	OFF	24.5	24.19	1.07	-0.02	0.273	0.29
		LTE 7	QPSK20M	Bottom Side	21350	1	0	ON	21.0	20.99	1.00	0.01	0.679	0.68
		LTE 7	QPSK20M	Front Face	21350	50	0	ON	21.0	20.96	1.01	0.01	0.295	0.30
		LTE 7	QPSK20M	Rear Face	20850	50	0	ON	21.0	20.96	1.01	0.07	0.552	0.56
		LTE 7	QPSK20M	Left Side	21350	50	0	OFF	23.5	22.35	1.30	-0.03	0.188	0.24
		LTE 7	QPSK20M	Bottom Side	20850	50	0	ON	21.0	20.96	1.01	-0.03	0.671	0.68
		LTE 7	QPSK20M	Bottom Side	20850	1	0	ON	21.0	20.95	1.01	-0.05	0.704	0.71
		LTE 7	QPSK20M	Bottom Side	21100	1	0	ON	21.0	20.97	1.01	0.01	0.692	0.70
38	2 CC (CA active)	LTE 7	QPSK20M	Bottom Side	PCC:21152 SCC:21350	PCC:1 SCC:1	PCC:99 SCC:0	ON	21.0	20.86	1.03	-0.04	0.684	0.70

Note: The "< 0.001" means there is no SAR value or the SAR is too low to be measured.

Plot No.	Uplink Mode	Band	Mode	Test Position	Ch.	RB#	RB Offset	P-Sensor	Max. Tune-up Power (dBm)	Measured Conducted Power (dBm)	Scaling Factor	Power Drift (dB)	Measured SAR-1g (W/kg)	Scaled SAR-1g (W/kg)
39	Single Carrier (CA inactive)	LTE 38	QPSK20M	Front Face	38150	1	0	OFF	24.0	23.81	1.04	0.02	0.451	0.47
		LTE 38	QPSK20M	Rear Face	38150	1	0	OFF	24.0	23.81	1.04	-0.05	0.809	0.84
		LTE 38	QPSK20M	Left Side	38150	1	0	OFF	24.0	23.81	1.04	0.06	0.161	0.17
		LTE 38	QPSK20M	Bottom Side	38150	1	0	OFF	24.0	23.81	1.04	0.05	0.848	0.88
		LTE 38	QPSK20M	Front Face	38150	50	0	OFF	23.0	22.38	1.15	-0.11	0.327	0.38
		LTE 38	QPSK20M	Rear Face	38150	50	0	OFF	23.0	22.38	1.15	0.05	0.591	0.68
		LTE 38	QPSK20M	Left Side	38150	50	0	OFF	23.0	22.38	1.15	-0.13	0.131	0.15
		LTE 38	QPSK20M	Bottom Side	38150	50	0	OFF	23.0	22.38	1.15	-0.01	0.621	0.71
		LTE 38	QPSK20M	Rear Face	37850	1	0	OFF	24.0	23.76	1.06	0.12	0.787	0.83
		LTE 38	QPSK20M	Rear Face	38000	1	0	OFF	24.0	23.78	1.05	-0.08	0.782	0.82
		LTE 38	QPSK20M	Bottom Side	37850	1	0	OFF	24.0	23.76	1.06	0.16	0.870	0.92
		LTE 38	QPSK20M	Bottom Side	38000	1	0	OFF	24.0	23.78	1.05	0.02	0.855	0.90
		LTE 38	QPSK20M	Rear Face	38150	100	0	OFF	23.0	22.29	1.18	0.02	0.587	0.69
		LTE 38	QPSK20M	Bottom Side	38150	100	0	OFF	23.0	22.29	1.18	0.05	0.623	0.74
		LTE 38	QPSK20M	Bottom Side	37850	1	0	OFF	24.0	23.76	1.06	0.12	0.862	0.91
39	2 CC (CA active)	LTE 38	QPSK20M	Bottom Side	PCC:37952 SCC:38150	PCC:1 SCC:1	PCC:99 SCC:0	OFF	24.0	23.68	1.08	-0.04	0.771	0.83
		LTE 38	QPSK20M	Bottom Side	PCC:37850 SCC:38048	PCC:1 SCC:1	PCC:99 SCC:0	OFF	24.0	23.63	1.09	0.06	0.762	0.83
		LTE 38	QPSK20M	Bottom Side	PCC:37901 SCC:38099	PCC:1 SCC:1	PCC:99 SCC:0	OFF	24.0	23.65	1.08	0.08	0.753	0.81

Note: The "< 0.001" means there is no SAR value or the SAR is too low to be measured.

FCC SAR Test Report

Plot No.	Band	Mode	Test Position	Ch.	Duty Cycle	Crest Factor	Max. Tune-up Power (dBm)	Measured Conducted Power (dBm)	Scaling Factor	Power Drift (dB)	Measured SAR-1g (W/kg)	Scaled SAR-1g (W/kg)
	WLAN2.4G	802.11b	Front Face	1	100.00	1.00	18.0	17.45	1.14	0.03	0.163	0.19
	WLAN2.4G	802.11b	Rear Face	1	100.00	1.00	18.0	17.45	1.14	0.05	0.264	0.30
	WLAN2.4G	802.11b	Right Side	1	100.00	1.00	18.0	17.45	1.14	0.09	0.118	0.13
	WLAN2.4G	802.11b	Top Side	1	100.00	1.00	18.0	17.45	1.14	0.06	0.237	0.27
26	WLAN2.4G	802.11b	Rear Face	6	100.00	1.00	18.0	16.43	1.44	-0.06	0.333	0.48
	WLAN2.4G	802.11b	Rear Face	11	100.00	1.00	18.0	17.02	1.25	-0.11	0.259	0.32
	WLAN5.2G	802.11a	Front Face	36	97.97	1.02	16.5	15.57	1.24	0.11	0.064	0.08
	WLAN5.2G	802.11a	Rear Face	36	97.97	1.02	16.5	15.57	1.24	0.19	0.114	0.14
	WLAN5.2G	802.11a	Right Side	36	97.97	1.02	16.5	15.57	1.24	0.02	0.037	0.05
	WLAN5.2G	802.11a	Top Side	36	97.97	1.02	16.5	15.57	1.24	-0.16	0.121	0.15
	WLAN5.2G	802.11a	Top Side	40	97.97	1.02	16.5	15.51	1.26	0.02	0.119	0.15
	WLAN5.2G	802.11a	Top Side	44	97.97	1.02	16.5	15.01	1.41	-0.16	0.111	0.16
40	WLAN5.2G	802.11a	Top Side	48	97.97	1.02	16.5	15.44	1.28	-0.04	0.133	0.17
	WLAN5.8G	802.11a	Front Face	161	97.97	1.02	15.5	14.47	1.27	0.02	0.096	0.12
29	WLAN5.8G	802.11a	Rear Face	161	97.97	1.02	15.5	14.47	1.27	-0.04	0.276	0.36
	WLAN5.8G	802.11a	Right Side	161	97.97	1.02	15.5	14.47	1.27	0.013	0.080	0.10
	WLAN5.8G	802.11a	Top Side	161	97.97	1.02	15.5	14.47	1.27	0.09	0.024	0.03
	WLAN5.8G	802.11a	Rear Face	149	97.97	1.02	15.5	14.41	1.29	0.01	0.229	0.30
	WLAN5.8G	802.11a	Rear Face	153	97.97	1.02	15.5	14.42	1.28	-0.13	0.206	0.27
	WLAN5.8G	802.11a	Rear Face	157	97.97	1.02	15.5	14.44	1.28	0.08	0.232	0.30
	BT	BDR	Front Face	39	76.80	1.30	9.5	9.11	1.09	0.13	0.012	0.02
30	BT	BDR	Rear Face	39	76.80	1.30	9.5	9.11	1.09	0.03	0.022	0.03
	BT	BDR	Right Side	39	76.80	1.30	9.5	9.11	1.09	0	<0.001	0.00
	BT	BDR	Top Side	39	76.80	1.30	9.5	9.11	1.09	0.02	0.019	0.03
	BT	BDR	Rear Face	0	76.80	1.30	9.5	8.53	1.25	0.11	0.018	0.03
	BT	BDR	Rear Face	78	76.80	1.30	9.5	8.31	1.32	0.09	0.017	0.03

Note: The "< 0.001" means there is no SAR value or the SAR is too low to be measured.

FCC SAR Test Report

4.7.5 SAR Results for Product Specific (Phablet) Exposure Condition (Test Separation Distance is 0 mm)

Plot No.	Band	Mode	Test Position	Ch.	P-Sensor	Max. Tune-up Power (dBm)	Measured Conducted Power (dBm)	Scaling Factor	Power Drift (dB)	Measured SAR-10g (W/kg)	Scaled SAR-10g (W/kg)
	GSM1900	GSM	Rear Face	810	ON	30.5	29.52	1.25	0.11	1.33	1.66
	GSM1900	GSM	Bottom Side	810	ON	30.5	29.52	1.25	0.12	1.89	2.36
41	GSM1900	GSM	Bottom Side	512	ON	30.5	29.50	1.26	0.15	2.19	2.76
	GSM1900	GSM	Bottom Side	661	ON	30.5	29.47	1.27	0.14	2.02	2.57
	GSM1900	GSM	Bottom Side	512	ON	30.5	29.50	1.26	0.05	2.15	2.71
	WCDMA II	RMC12.2K	Front Face	9400	ON	20.0	19.81	1.04	-0.06	0.671	0.70
	WCDMA II	RMC12.2K	Rear Face	9400	ON	20.0	19.81	1.04	0.12	1.5	1.56
	WCDMA II	RMC12.2K	Bottom Side	9400	ON	20.0	19.81	1.04	0.11	2.08	2.16
42	WCDMA II	RMC12.2K	Bottom Side	9262	ON	20.0	19.75	1.06	0.15	2.1	2.23
	WCDMA II	RMC12.2K	Bottom Side	9538	ON	20.0	19.72	1.07	0.14	1.95	2.09
	WCDMA II	RMC12.2K	Bottom Side	9262	ON	20.0	19.75	1.06	0.15	2.05	2.17
	WCDMA IV	RMC12.2K	Front Face	1513	ON	21.0	20.88	1.03	-0.03	0.995	1.02
	WCDMA IV	RMC12.2K	Rear Face	1513	ON	21.0	20.88	1.03	0.12	1.93	1.99
43	WCDMA IV	RMC12.2K	Bottom Side	1513	ON	21.0	20.88	1.03	0.06	2.82	2.90
	WCDMA IV	RMC12.2K	Bottom Side	1312	ON	21.0	20.56	1.11	0.05	2.59	2.87
	WCDMA IV	RMC12.2K	Bottom Side	1413	ON	21.0	20.62	1.09	0.11	2.55	2.78
	WCDMA IV	RMC12.2K	Bottom Side	1513	ON	21.0	20.88	1.03	-0.03	2.76	2.84

Plot No.	Band	Mode	Test Position	Ch.	RB#	RB Offset	P-Sensor	Max. Tune-up Power (dBm)	Measured Conducted Power (dBm)	Scaling Factor	Power Drift (dB)	Measured SAR-10g (W/kg)	Scaled SAR-10g (W/kg)
	LTE 2	QPSK20M	Front Face	18900	1	0	ON	20.0	19.69	1.07	-0.08	1.13	1.21
	LTE 2	QPSK20M	Rear Face	18900	1	0	ON	20.0	19.69	1.07	0.11	1.7	1.82
	LTE 2	QPSK20M	Bottom Side	18900	1	0	ON	20.0	19.69	1.07	0.12	2.08	2.23
	LTE 2	QPSK20M	Front Face	18900	50	0	ON	20.0	19.56	1.11	0.05	1.08	1.20
	LTE 2	QPSK20M	Rear Face	18900	50	0	ON	20.0	19.56	1.11	0.14	1.56	1.73
	LTE 2	QPSK20M	Bottom Side	18900	50	0	ON	20.0	19.56	1.11	0.13	2.02	2.24
44	LTE 2	QPSK20M	Bottom Side	18700	1	0	ON	20.0	19.55	1.11	0.16	2.09	2.32
	LTE 2	QPSK20M	Bottom Side	19100	1	0	ON	20.0	19.39	1.15	0.15	1.86	2.14
	LTE 2	QPSK20M	Bottom Side	18700	50	0	ON	20.0	19.42	1.14	0.09	2.04	2.33
	LTE 2	QPSK20M	Bottom Side	19100	50	0	ON	20.0	19.26	1.19	0.11	1.82	2.17
	LTE 2	QPSK20M	Bottom Side	18900	100	0	ON	20.0	19.49	1.12	0.14	2	2.24
	LTE 2	QPSK20M	Bottom Side	18700	1	0	ON	20.0	19.55	1.11	-0.05	2.06	2.29
	LTE 4	QPSK20M	Front Face	20300	1	0	ON	19.5	18.98	1.13	-0.02	0.905	1.02
	LTE 4	QPSK20M	Rear Face	20300	1	0	ON	19.5	18.98	1.13	0.1	1.62	1.83
45	LTE 4	QPSK20M	Bottom Side	20300	1	0	ON	19.5	18.98	1.13	0.08	1.98	2.24
	LTE 4	QPSK20M	Front Face	20300	50	0	ON	19.5	18.93	1.14	-0.06	0.874	1.00
	LTE 4	QPSK20M	Rear Face	20300	50	0	ON	19.5	18.93	1.14	0.03	1.59	1.81
	LTE 4	QPSK20M	Bottom Side	20300	50	0	ON	19.5	18.93	1.14	0.06	1.95	2.22
	LTE 4	QPSK20M	Bottom Side	20050	1	0	ON	19.5	18.92	1.14	0.14	1.9	2.17
	LTE 4	QPSK20M	Bottom Side	20175	1	0	ON	19.5	18.95	1.14	0.08	1.94	2.21
	LTE 4	QPSK20M	Bottom Side	20050	50	0	ON	19.5	18.87	1.16	0.12	1.89	2.19
	LTE 4	QPSK20M	Bottom Side	20175	50	0	ON	19.5	18.90	1.15	0.11	1.92	2.21
	LTE 4	QPSK20M	Bottom Side	20300	100	0	ON	19.5	18.86	1.16	0.11	1.92	2.23

FCC SAR Test Report

Plot No.	Uplink Mode	Band	Mode	Test Position	Ch.	RB#	RB Offset	P-Sensor	Max. Tune-up Power (dBm)	Measured Conducted Power (dBm)	Scaling Factor	Power Drift (dB)	Measured SAR-10g (W/kg)	Scaled SAR-10g (W/kg)
46	Single Carrier (CA inactive)	LTE 7	QPSK20M	Rear Face	21350	1	0	ON	21.0	20.99	1.00	0.08	2.21	2.21
		LTE 7	QPSK20M	Bottom Side	21350	1	0	ON	21.0	20.99	1.00	0.01	1.36	1.36
		LTE 7	QPSK20M	Rear Face	21350	50	0	ON	21.0	20.96	1.01	-0.06	2.16	2.18
		LTE 7	QPSK20M	Bottom Side	21350	50	0	ON	21.0	20.96	1.01	0.11	1.29	1.30
		LTE 7	QPSK20M	Rear Face	20850	1	0	ON	21.0	20.95	1.01	0.03	2.23	2.25
		LTE 7	QPSK20M	Rear Face	21100	1	0	ON	21.0	20.97	1.01	0.01	2.31	2.33
		LTE 7	QPSK20M	Rear Face	20850	50	25	ON	21.0	20.90	1.02	-0.09	2.19	2.23
		LTE 7	QPSK20M	Rear Face	21100	50	0	ON	21.0	20.95	1.01	0.12	2.21	2.23
		LTE 7	QPSK20M	Rear Face	21350	100	0	ON	21.0	20.96	1.01	0.05	2.17	2.19
		LTE 7	QPSK20M	Rear Face	21100	1	0	ON	21.0	20.97	1.01	-0.03	2.26	2.28
	2 CC (CA active)	LTE 7	QPSK20M	Rear Face	PCC:21152 SCC:21350	PCC:1 SCC:1	PCC:99 SCC:0	ON	21.0	20.86	1.03	-0.02	2.25	2.32
		LTE 7	QPSK20M	Rear Face	PCC:20850 SCC:21048	PCC:1 SCC:1	PCC:99 SCC:0	ON	21.0	20.85	1.04	0.11	2.18	2.27
		LTE 7	QPSK20M	Rear Face	PCC:21100 SCC:21298	PCC:1 SCC:1	PCC:99 SCC:0	ON	21.0	20.85	1.04	0.03	2.20	2.29

Plot No.	Band	Mode	Test Position	Ch.	Duty Cycle	Crest Factor	Max. Tune-up Power (dBm)	Measured Conducted Power (dBm)	Scaling Factor	Power Drift (dB)	Measured SAR-10g (W/kg)	Scaled SAR-10g (W/kg)
47	WLAN5.3G	802.11a	Front Face	60	97.97	1.02	16.5	15.54	1.25	0.02	0.322	0.41
	WLAN5.3G	802.11a	Rear Face	60	97.97	1.02	16.5	15.54	1.25	0.13	0.337	0.43
	WLAN5.3G	802.11a	Right Side	60	97.97	1.02	16.5	15.54	1.25	0.09	0.057	0.07
	WLAN5.3G	802.11a	Top Side	60	97.97	1.02	16.5	15.54	1.25	-0.03	0.458	0.58
	WLAN5.3G	802.11a	Top Side	52	97.97	1.02	16.5	15.45	1.27	0.02	0.445	0.58
	WLAN5.3G	802.11a	Top Side	56	97.97	1.02	16.5	15.12	1.37	-0.15	0.412	0.58
	WLAN5.3G	802.11a	Top Side	64	97.97	1.02	16.5	15.35	1.30	0.02	0.425	0.56
48	WLAN5.6G	802.11a	Front Face	116	97.97	1.02	16.5	14.98	1.42	0.02	0.239	0.35
	WLAN5.6G	802.11a	Rear Face	116	97.97	1.02	16.5	14.98	1.42	0.19	0.327	0.47
	WLAN5.6G	802.11a	Right Side	116	97.97	1.02	16.5	14.98	1.42	0.03	0.059	0.09
	WLAN5.6G	802.11a	Top Side	116	97.97	1.02	16.5	14.98	1.42	0.10	0.374	0.54
	WLAN5.6G	802.11a	Top Side	100	97.97	1.02	16.5	14.76	1.49	0.02	0.347	0.53
	WLAN5.6G	802.11a	Top Side	120	97.97	1.02	16.5	14.96	1.43	-0.13	0.352	0.51
	WLAN5.6G	802.11a	Top Side	124	97.97	1.02	16.5	14.92	1.44	0.02	0.330	0.48
	WLAN5.6G	802.11a	Top Side	132	97.97	1.02	16.5	14.88	1.45	-0.11	0.328	0.49
	WLAN5.6G	802.11a	Top Side	140	97.97	1.02	16.5	14.71	1.51	0.01	0.346	0.53
	WLAN5.6G	802.11a	Top Side	144	97.97	1.02	16.5	14.78	1.49	0.01	0.337	0.51

Note: The "< 0.001" means there is no SAR value or the SAR is too low to be measured.

FCC SAR Test Report

4.7.6 SAR Measurement Variability

According to KDB 865664 D01, SAR measurement variability was assessed for each frequency band, which is determined by the SAR probe calibration point and tissue-equivalent medium used for the device measurements. When both head and body tissue-equivalent media are required for SAR measurements in a frequency band, the variability measurement procedures should be applied to the tissue medium with the highest measured SAR, using the highest measured SAR configuration for that tissue-equivalent medium. Alternatively, if the highest measured SAR for both head and body tissue-equivalent media are ≤ 1.45 W/kg and the ratio of these highest SAR values, i.e., largest divided by smallest value, is ≤ 1.10 , the highest SAR configuration for either head or body tissue-equivalent medium maybe used to perform the repeated measurement. These additional measurements are repeated after the completion of all measurements requiring the same head or body tissue-equivalent medium in a frequency band. The test device should be returned to ambient conditions (normal room temperature) with the battery fully charged before it is re-mounted on the device holder for the repeated measurement(s) to minimize any unexpected variations in the repeated results.

SAR repeated measurement procedure:

1. When the highest measured SAR is < 0.80 W/kg, repeated measurement is not required.
2. When the highest measured SAR is ≥ 0.80 W/kg, repeat that measurement once.
3. If the ratio of largest to smallest SAR for the original and first repeated measurements is > 1.20 , or when the original or repeated measurement is ≥ 1.45 W/kg, perform a second repeated measurement.
4. If the ratio of largest to smallest SAR for the original, first and second repeated measurements is > 1.20 , and the original, first or second repeated measurement is ≥ 1.5 W/kg, perform a third repeated measurement.

<Head>

Band	Mode	Test Position	Ch.	Original Measured SAR-1g (W/kg)	1st Repeated SAR-1g (W/kg)	L/S Ratio	2nd Repeated SAR-1g (W/kg)	L/S Ratio	3rd Repeated SAR-1g (W/kg)	L/S Ratio
WLAN5.3G	802.11a	Left Cheek	60	0.801	0.785	1.02	N/A	N/A	N/A	N/A

<Body-worn>

Band	Mode	Test Position	Ch.	Original Measured SAR-1g (W/kg)	1st Repeated SAR-1g (W/kg)	L/S Ratio	2nd Repeated SAR-1g (W/kg)	L/S Ratio	3rd Repeated SAR-1g (W/kg)	L/S Ratio
GSM1900	GPRS8	Rear Face	512	1.04	1.02	1.02	N/A	N/A	N/A	N/A
WCDMA IV	RMC12.2K	Rear Face	1513	0.909	0.889	1.02	N/A	N/A	N/A	N/A
LTE 2	QPSK20M	Rear Face	18900	0.847	0.827	1.02	N/A	N/A	N/A	N/A
LTE 38	QPSK20M	Rear Face	38150	0.809	0.798	1.01	N/A	N/A	N/A	N/A

FCC SAR Test Report

<Hotspot>

Band	Mode	Test Position	Ch.	Original Measured SAR-1g (W/kg)	1st Repeated SAR-1g (W/kg)	L/S Ratio	2nd Repeated SAR-1g (W/kg)	L/S Ratio	3rd Repeated SAR-1g (W/kg)	L/S Ratio
GSM1900	GPRS8	Bottom Side	810	1.15	1.11	1.04	N/A	N/A	N/A	N/A
WCDMA II	RMC12.2K	Bottom Side	9400	0.954	0.939	1.02	N/A	N/A	N/A	N/A
WCDMA IV	RMC12.2K	Bottom Side	1513	0.928	0.908	1.02	N/A	N/A	N/A	N/A
LTE 2	QPSK20M	Bottom Side	18900	0.972	0.961	1.01	N/A	N/A	N/A	N/A
LTE 4	QPSK20M	Bottom Side	20300	0.839	0.817	1.03	N/A	N/A	N/A	N/A
LTE 38	QPSK20M	Bottom Side	37850	0.870	0.862	1.01	N/A	N/A	N/A	N/A

<Extremity>

Band	Mode	Test Position	Ch.	Original Measured SAR-10g (W/kg)	1st Repeated SAR-10g (W/kg)	L/S Ratio	2nd Repeated SAR-1g (W/kg)	L/S Ratio	3rd Repeated SAR-1g (W/kg)	L/S Ratio
GSM1900	GPRS8	Bottom Side	512	2.19	2.15	1.02	N/A	N/A	N/A	N/A
WCDMA II	RMC12.2K	Bottom Side	9262	2.1	2.05	1.02	N/A	N/A	N/A	N/A
WCDMA IV	RMC12.2K	Bottom Side	512	2.82	2.76	1.02	N/A	N/A	N/A	N/A
LTE 2	QPSK20M	Bottom Side	18700	2.09	2.06	1.01	N/A	N/A	N/A	N/A
LTE 7	QPSK20M	Bottom Side	21100	2.31	2.26	1.02	N/A	N/A	N/A	N/A

FCC SAR Test Report

4.7.7 Simultaneous Multi-band Transmission Evaluation

<Possibilities of Simultaneous Transmission>

The simultaneous transmission possibilities for this device are listed as below.

Simultaneous TX Combination	Capable Transmit Configurations	Head Exposure Condition	Body Exposure Condition	Hotspot Exposure Condition
1	WWAN + WLAN 2.4G	Yes	Yes	Yes
2	WWAN + WLAN 5G	Yes	Yes	Yes
3	WWAN + BT	Yes	Yes	Yes
4	WLAN 5G + BT	Yes	Yes	Yes
5	WWAN + WLAN 5G + BT	Yes	Yes	Yes

Note :

1. The WLAN 2.4G and WLAN 5G cannot transmit simultaneously.
2. Plot 2 is covered by Plot 5.
2. Plot 3 is covered by Plot 5.
3. Plot 4 is covered by Plot 5.

FCC SAR Test Report

<SAR Summation Analysis>

Simultaneous transmission SAR test exclusion is determined for each operating configuration and exposure condition according to the reported standalone SAR of each applicable simultaneous transmitting antenna. When the sum of SAR_{1g} of all simultaneously transmitting antennas in an operating mode and exposure condition combination is within the SAR limit(SAR_{1g} 1.6 W/kg), the simultaneous transmission SAR is not required. When the sum of SAR_{1g} is greater than the SAR limit (SAR_{1g} 1.6 W/kg), SAR test exclusion is determined by the SPLSR.

Band	Mode	Position	1g SAR W/kg				Summing result 1g SAR W/kg	
			1	2	3	4	1+2	1+3+4
			Max WWAN	Max WLAN 2.4GHz	Max WLAN 5GHz	BT		
GSM850	Head	Right Cheek	0.17	0.31	0.41	0.06	0.48	0.64
		Right Tilted	0.06	0.30	0.39	0.05	0.36	0.50
		Left Cheek	0.08	0.80	1.02	0.09	0.88	1.19
		Left Tilted	0.05	0.44	1.01	0.09	0.49	1.15
GSM1900	Head	Right Cheek	0.06	0.31	0.41	0.06	0.37	0.53
		Right Tilted	0.04	0.30	0.39	0.05	0.34	0.48
		Left Cheek	0.08	0.80	1.02	0.09	0.88	1.19
		Left Tilted	0.05	0.44	1.01	0.09	0.49	1.15
WCDMA II	Head	Right Cheek	0.12	0.31	0.41	0.06	0.43	0.59
		Right Tilted	0.09	0.30	0.39	0.05	0.39	0.53
		Left Cheek	0.11	0.80	1.02	0.09	0.91	1.22
		Left Tilted	0.07	0.44	1.01	0.09	0.51	1.17
WCDMA IV	Head	Right Cheek	0.11	0.31	0.41	0.06	0.42	0.58
		Right Tilted	0.07	0.30	0.39	0.05	0.37	0.51
		Left Cheek	0.14	0.80	1.02	0.09	0.94	1.25
		Left Tilted	0.06	0.44	1.01	0.09	0.50	1.16
WCDMA V	Head	Right Cheek	0.14	0.31	0.41	0.06	0.45	0.61
		Right Tilted	0.09	0.30	0.39	0.05	0.39	0.53
		Left Cheek	0.10	0.80	1.02	0.09	0.90	1.21
		Left Tilted	0.07	0.44	1.01	0.09	0.51	1.17
LTE 2	Head	Right Cheek	0.13	0.31	0.41	0.06	0.44	0.60
		Right Tilted	0.11	0.30	0.39	0.05	0.41	0.55
		Left Cheek	0.12	0.80	1.02	0.09	0.92	1.23
		Left Tilted	0.12	0.44	1.01	0.09	0.56	1.22
LTE 4	Head	Right Cheek	0.13	0.31	0.41	0.06	0.44	0.60
		Right Tilted	0.06	0.30	0.39	0.05	0.36	0.50
		Left Cheek	0.16	0.80	1.02	0.09	0.96	1.27
		Left Tilted	0.07	0.44	1.01	0.09	0.51	1.17
LTE 5	Head	Right Cheek	0.11	0.31	0.41	0.06	0.42	0.58
		Right Tilted	0.05	0.30	0.39	0.05	0.35	0.49
		Left Cheek	0.08	0.80	1.02	0.09	0.88	1.19
		Left Tilted	0.06	0.44	1.01	0.09	0.50	1.16

FCC SAR Test Report

Band	Mode	Position	1g SAR W/kg				Summing result 1g SAR W/kg	
			1	2	3	4	1+2	1+3+4
			Max WWAN	Max WLAN 2.4GHz	Max WLAN 5GHz	BT		
LTE 7	Head	Right Cheek	0.11	0.31	0.41	0.06	0.42	0.58
		Right Tilted	0.11	0.30	0.39	0.05	0.41	0.55
		Left Cheek	0.15	0.80	1.02	0.09	0.95	1.26
		Left Tilted	0.07	0.44	1.01	0.09	0.51	1.17
LTE 38	Head	Right Cheek	0.04	0.31	0.41	0.06	0.35	0.51
		Right Tilted	0.04	0.30	0.39	0.05	0.34	0.48
		Left Cheek	0.08	0.80	1.02	0.09	0.88	1.19
		Left Tilted	0.03	0.44	1.01	0.09	0.47	1.13

Band	Mode	Position	1g SAR W/kg				Summing result 1g SAR W/kg	
			1	2	3	4	1+2	1+3+4
			Max WWAN	Max WLAN 2.4GHz	Max WLAN 5GHz	BT		
GSM850	Body-worn	Front Face	0.29	0.19	0.19	0.02	0.48	0.50
		Rear Face	0.34	0.48	0.41	0.03	0.82	0.78
GSM1900	Body-worn	Front Face	0.56	0.19	0.19	0.02	0.75	0.77
		Rear Face	1.08	0.48	0.41	0.03	1.56	1.52
WCDMA II	Body-worn	Front Face	0.43	0.19	0.19	0.02	0.62	0.64
		Rear Face	0.74	0.48	0.41	0.03	1.22	1.18
WCDMA IV	Body-worn	Front Face	0.66	0.19	0.19	0.02	0.85	0.87
		Rear Face	0.94	0.48	0.41	0.03	1.42	1.38
WCDMA V	Body-worn	Front Face	0.25	0.19	0.19	0.02	0.44	0.46
		Rear Face	0.27	0.48	0.41	0.03	0.75	0.71
LTE 2	Body-worn	Front Face	0.53	0.19	0.19	0.02	0.72	0.74
		Rear Face	0.91	0.48	0.41	0.03	1.39	1.35
LTE 4	Body-worn	Front Face	0.51	0.19	0.19	0.02	0.70	0.72
		Rear Face	0.80	0.48	0.41	0.03	1.28	1.24
LTE 5	Body-worn	Front Face	0.16	0.19	0.19	0.02	0.35	0.37
		Rear Face	0.21	0.48	0.41	0.03	0.69	0.65
LTE 7	Body-worn	Front Face	0.31	0.19	0.19	0.02	0.50	0.52
		Rear Face	0.62	0.48	0.41	0.03	1.10	1.06
LTE 38	Body-worn	Front Face	0.47	0.19	0.19	0.02	0.66	0.68
		Rear Face	0.84	0.48	0.41	0.03	1.32	1.28

FCC SAR Test Report

Band	Mode	Position	1g SAR W/kg				Summing result 1g SAR W/kg	
			1	2	3	4	1+2	1+3+4
			Max WWAN	Max WLAN 2.4GHz	Max WLAN 5GHz	BT		
GSM850	Hotspot	Front Face	0.29	0.19	0.12	0.02	0.48	0.43
		Rear Face	0.34	0.48	0.36	0.03	0.82	0.73
		Left Side	0.05	0.00	0.00	0.00	0.05	0.05
		Right Side	0.00	0.13	0.10	0.00	0.13	0.10
		Top Side	0.00	0.27	0.17	0.03	0.27	0.20
		Bottom Side	0.18	0.00	0.00	0.00	0.18	0.18
GSM1900	Hotspot	Front Face	0.56	0.19	0.12	0.02	0.75	0.70
		Rear Face	1.08	0.48	0.36	0.03	1.56	1.47
		Left Side	0.20	0.00	0.00	0.00	0.20	0.20
		Right Side	0.00	0.13	0.10	0.00	0.13	0.10
		Top Side	0.00	0.27	0.17	0.03	0.27	0.20
		Bottom Side	1.18	0.00	0.00	0.00	1.18	1.18
WCDMA II	Hotspot	Front Face	0.43	0.19	0.12	0.02	0.62	0.57
		Rear Face	0.74	0.48	0.36	0.03	1.22	1.13
		Left Side	0.24	0.00	0.00	0.00	0.24	0.24
		Right Side	0.00	0.13	0.10	0.00	0.13	0.10
		Top Side	0.00	0.27	0.17	0.03	0.27	0.20
		Bottom Side	0.99	0.00	0.00	0.00	0.99	0.99
WCDMA IV	Hotspot	Front Face	0.66	0.19	0.12	0.02	0.85	0.80
		Rear Face	0.94	0.48	0.36	0.03	1.42	1.33
		Left Side	0.27	0.00	0.00	0.00	0.27	0.27
		Right Side	0.00	0.13	0.10	0.00	0.13	0.10
		Top Side	0.00	0.27	0.17	0.03	0.27	0.20
		Bottom Side	0.96	0.00	0.00	0.00	0.96	0.96
WCDMA V	Hotspot	Front Face	0.25	0.19	0.12	0.02	0.44	0.39
		Rear Face	0.27	0.48	0.36	0.03	0.75	0.66
		Left Side	0.04	0.00	0.00	0.00	0.04	0.04
		Right Side	0.00	0.13	0.10	0.00	0.13	0.10
		Top Side	0.00	0.27	0.17	0.03	0.27	0.20
		Bottom Side	0.14	0.00	0.00	0.00	0.14	0.14
LTE 2	Hotspot	Front Face	0.53	0.19	0.12	0.02	0.72	0.67
		Rear Face	0.91	0.48	0.36	0.03	1.39	1.30
		Left Side	0.28	0.00	0.00	0.00	0.28	0.28
		Right Side	0.00	0.13	0.10	0.00	0.13	0.10
		Top Side	0.00	0.27	0.17	0.03	0.27	0.20
		Bottom Side	1.04	0.00	0.00	0.00	1.04	1.04

FCC SAR Test Report

Band	Mode	Position	1g SAR W/kg				Summing result 1g SAR W/kg	
			1	2	3	4	1+2	1+3+4
			Max WWAN	Max WLAN 2.4GHz	Max WLAN 5GHz	BT		
LTE 4	Hotspot	Front Face	0.51	0.19	0.12	0.02	0.70	0.65
		Rear Face	0.80	0.48	0.36	0.03	1.28	1.19
		Left Side	0.26	0.00	0.00	0.00	0.26	0.26
		Right Side	0.00	0.13	0.10	0.00	0.13	0.10
		Top Side	0.00	0.27	0.17	0.03	0.27	0.20
		Bottom Side	0.87	0.00	0.00	0.00	0.87	0.87
LTE 5	Hotspot	Front Face	0.16	0.19	0.12	0.02	0.35	0.30
		Rear Face	0.21	0.48	0.36	0.03	0.69	0.60
		Left Side	0.05	0.00	0.00	0.00	0.05	0.05
		Right Side	0.00	0.13	0.10	0.00	0.13	0.10
		Top Side	0.00	0.27	0.17	0.03	0.27	0.20
		Bottom Side	0.12	0.00	0.00	0.00	0.12	0.12
LTE 7	Hotspot	Front Face	0.31	0.19	0.12	0.02	0.50	0.45
		Rear Face	0.56	0.48	0.36	0.03	1.04	0.95
		Left Side	0.29	0.00	0.00	0.00	0.29	0.29
		Right Side	0.00	0.13	0.10	0.00	0.13	0.10
		Top Side	0.00	0.27	0.17	0.03	0.27	0.20
		Bottom Side	0.71	0.00	0.00	0.00	0.71	0.71
LTE 38	Hotspot	Front Face	0.47	0.19	0.12	0.02	0.66	0.61
		Rear Face	0.84	0.48	0.36	0.03	1.32	1.23
		Left Side	0.17	0.00	0.00	0.00	0.17	0.17
		Right Side	0.00	0.13	0.10	0.00	0.13	0.10
		Top Side	0.00	0.27	0.17	0.03	0.27	0.20
		Bottom Side	0.92	0.00	0.00	0.00	0.92	0.92

FCC SAR Test Report

Band	Mode	Position	10g SAR W/kg		Summing result
			1	2	10g SAR W/kg
			Max WWAN	Max WLAN 5GHz	1+2
GSM1900	Product Specific	Rear Face	1.66	0.47	2.13
		Bottom Side	2.76	0.00	2.76
WCDMA II	Product Specific	Front Face	0.70	0.41	1.11
		Rear Face	1.56	0.47	2.03
		Bottom Side	2.23	0.00	2.23
WCDMA IV	Product Specific	Front Face	1.02	0.41	1.43
		Rear Face	1.99	0.47	2.46
		Bottom Side	2.90	0.00	2.90
LTE 2	Product Specific	Front Face	1.21	0.41	1.62
		Rear Face	1.82	0.47	2.29
		Bottom Side	2.32	0.00	2.32
LTE 4	Product Specific	Front Face	1.02	0.41	1.43
		Rear Face	1.83	0.47	2.30
		Bottom Side	2.24	0.00	2.24
LTE 7	Product Specific	Rear Face	2.33	0.47	2.80
		Bottom Side	1.36	0.00	1.36

Test Engineer: Eric Wu, and Willy Chang

5. Calibration of Test Equipment

Equipment	Manufacturer	Model	SN	Cal. Date	Cal. Interval
System Validation Dipole	SPEAG	D835V2	4d092	Jun. 20, 2019	1 Year
System Validation Dipole	SPEAG	D1750V2	1023	Jun. 20, 2019	1 Year
System Validation Dipole	SPEAG	D1900V2	5d036	Jan. 25, 2019	1 Year
System Validation Dipole	SPEAG	D2450V2	835	Jun. 27, 2019	1 Year
System Validation Dipole	SPEAG	D2600V2	1058	Jun. 27, 2019	1 Year
System Validation Dipole	SPEAG	D5GHzV2	1019	Mar. 21, 2019	1 Year
Dosimetric E-Field Probe	SPEAG	EX3DV4	3971	Mar. 29, 2019	1 Year
Dosimetric E-Field Probe	SPEAG	EX3DV4	7375	Dec. 13, 2018	1 Year
Dosimetric E-Field Probe	SPEAG	EX3DV4	7537	Jun. 18, 2019	1 Year
Data Acquisition Electronics	SPEAG	DAE4	1431	Mar. 25, 2019	1 Year
Data Acquisition Electronics	SPEAG	DAE4	1277	Jan. 24, 2019	1 Year
Data Acquisition Electronics	SPEAG	DAE4	1585	Jun. 07, 2019	1 Year
Radio Communication Analyzer	Anritsu	MT8820C	6201300638	Jun. 27, 2019	1 Year
Universal Radio Communication Tester	Anritsu	MT8821C	6261786083	Jun. 27, 2019	1 Year
Spectrum Analyzer	R&S	FSL6	102006	Mar. 26, 2019	1 Year
ENA Series Network Analyzer	Agilent	E5071C	MY46214281	Jun. 17, 2019	1 Year
MXG Analog Signal Generator	Agilent	N5181A	MY50143868	Jun. 27, 2019	1 Year
Power Meter	Anritsu	ML2495A	1218009	Jun. 28, 2019	1 Year
Power Sensor	Anritsu	MA2411B	1207252	Jun. 28, 2019	1 Year
Thermometer	YFE	YF-160A	130504591	Mar. 22, 2019	1 Year

6. Measurement Uncertainty

According to KDB 865664 D01, SAR measurement uncertainty analysis is required in SAR reports only when the highest measured SAR in a frequency band is ≥ 1.5 W/kg for 1-g SAR, and ≥ 3.75 W/kg for 10-g SAR. The procedures described in IEEE Std 1528-2013 should be applied. The expanded SAR measurement uncertainty must be $\leq 30\%$, for a confidence interval of $k = 2$. When the highest measured SAR within a frequency band is < 1.5 W/kg for 1-g and < 3.75 W/kg for 10-g, the extensive SAR measurement uncertainty analysis described in IEEE Std 1528-2013 is not required in SAR reports submitted for equipment approval. Hence, the measurement uncertainty analysis is not required in this SAR report because the test result met the condition.

7. Information of the Testing Laboratories

We, Bureau Veritas Consumer Products Services (H.K.) Ltd., Taoyuan Branch, were founded in 1988 to provide our best service in EMC, Radio, Telecom and Safety consultation. Our laboratories are accredited and approved according to ISO/IEC 17025.

If you have any comments, please feel free to contact us at the following:

Taiwan Huaya Lab:

Add: No. 19, Huaya 2nd Rd., Guishan Dist., Taoyuan City 333, Taiwan

Tel: +886-(0)3-318-3232

Fax: +886-(0)3-211-5834

Taiwan Linkou Lab:

Add: No. 47-2, Baodoucuokeng, Linkou Dist., New Taipei City 244, Taiwan

Tel: +886-(0)2-2605-2180

Fax: +886-(0)2-2605-2943

Taiwan Hsinchu Lab1:

Add: E-2, No. 1, Lixing 1st Rd., East Dist., Hsinchu City 300, Taiwan

Tel: +886-(0)3-666-8565

Fax: +886-(0)3-666-8323

Taiwan Hsinchu Lab2:

Add: No. 49, Ln. 206, Wende Rd., Qionglin Township, Hsinchu County 307, Taiwan

Tel: +886-(0)3-512-0595

Fax: +886-(0)3-512-0568

Taiwan Xindian Lab:

Add: B2F., No. 215, Sec. 3, Beixin Rd., Xindian Dist., New Taipei City 231, Taiwan

Tel: +886-(0)2-8914-5882

Fax: +886-(0)2-8914-5840

Email: service.adt@tw.bureauveritas.com

Web Site: <https://ee.bureauveritas.com.tw/BVInternet/Default>

The road map of all our labs can be found in our web site also.

---END---



Appendix A. SAR Plots of System Verification

The plots for system verification with largest deviation for each SAR system combination are shown as follows.

System Check_H835_190906

DUT: Dipole 835 MHz; Type: D835V2; SN: 4d092

Communication System: CW; Frequency: 835 MHz; Duty Cycle: 1:1

Medium: H07T10N1_0906 Medium parameters used: $f = 835 \text{ MHz}$; $\sigma = 0.928 \text{ S/m}$; $\epsilon_r = 41.992$; $\rho = 1000 \text{ kg/m}^3$

Ambient Temperature : 23.7 °C ; Liquid Temperature : 23.2 °C

DASY5 Configuration:

- Probe: EX3DV4 - SN7537; ConvF(10.48, 10.48, 10.48); Calibrated: 2019/06/18
- Sensor-Surface: 1.4mm (Mechanical Surface Detection)
- Electronics: DAE4 Sn1585; Calibrated: 2019/06/07
- Phantom: SAM Phantom_1982; Type: QD 000 P41 Ax; Serial: 1982
- Measurement SW: DASY52, Version 52.10 (2); SEMCAD X Version 14.6.12 (7470)

Pin=250mW/Area Scan (61x61x1): Interpolated grid: $dx=1.500 \text{ mm}$, $dy=1.500 \text{ mm}$
Maximum value of SAR (interpolated) = 3.24 W/kg

Pin=250mW/Zoom Scan (5x5x7)/Cube 0: Measurement grid: $dx=8\text{mm}$, $dy=8\text{mm}$, $dz=5\text{mm}$
Reference Value = 55.89 V/m; Power Drift = -0.08 dB
Peak SAR (extrapolated) = 3.66 W/kg
SAR(1 g) = 2.43 W/kg; SAR(10 g) = 1.6 W/kg
Maximum value of SAR (measured) = 3.25 W/kg

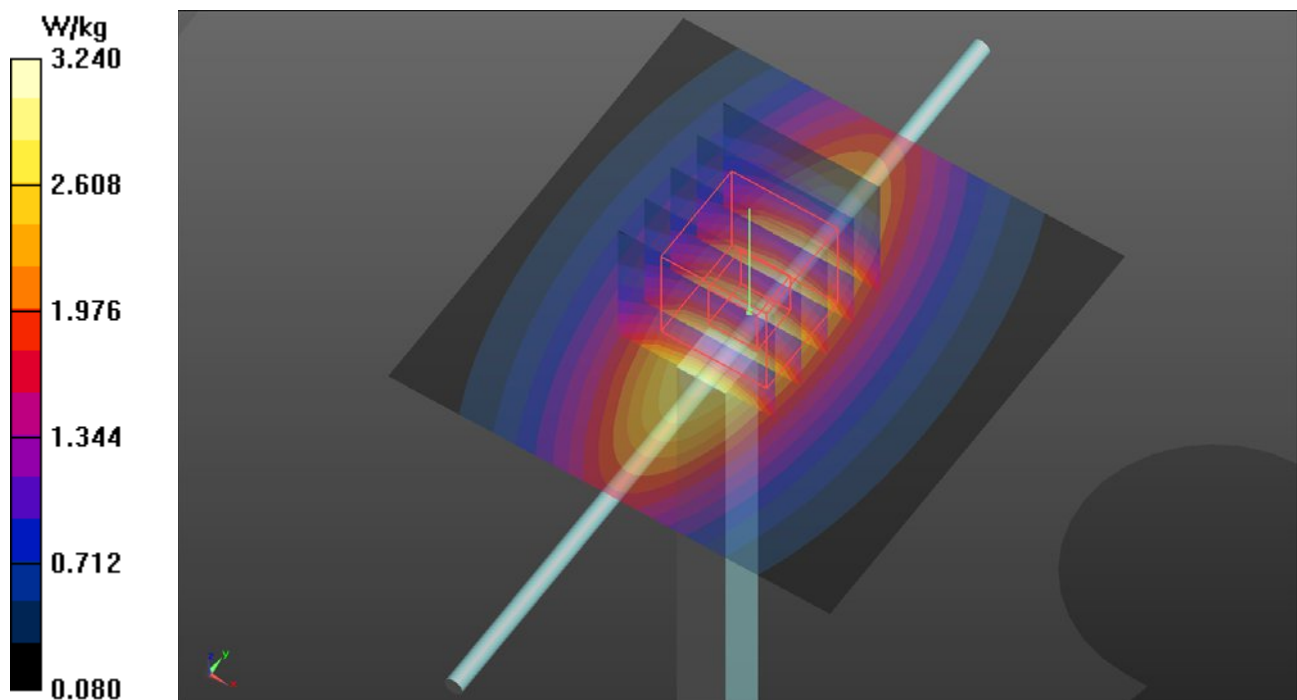

System Check_H1750_190910

DUT: Dipole 1750 MHz; Type: D1750V2; SN: 1023

Communication System: CW; Frequency: 1750 MHz; Duty Cycle: 1:1

Medium: H16T20N4_0910 Medium parameters used: $f = 1750$ MHz; $\sigma = 1.328$ S/m; $\epsilon_r = 40.493$; $\rho = 1000$ kg/m³

Ambient Temperature : 23.7 °C ; Liquid Temperature : 23.3 °C

DASY5 Configuration:

- Probe: EX3DV4 - SN7375; ConvF(8.58, 8.58, 8.58); Calibrated: 2018/12/13
- Sensor-Surface: 1.4mm (Mechanical Surface Detection)
- Electronics: DAE4 Sn1277; Calibrated: 2019/01/24
- Phantom: Twin SAM Phantom_1823; Type: QD000P40CD;
- Measurement SW: DASY52, Version 52.10 (2); SEMCAD X Version 14.6.12 (7470)

Pin=250mW/Area Scan (61x61x1): Interpolated grid: dx=1.500 mm, dy=1.500 mm
Maximum value of SAR (interpolated) = 15.0 W/kg

Pin=250mW/Zoom Scan (5x5x7)/Cube 0: Measurement grid: dx=8mm, dy=8mm, dz=5mm
Reference Value = 105.2 V/m; Power Drift = 0.09 dB
Peak SAR (extrapolated) = 18.3 W/kg
SAR(1 g) = 9.5 W/kg; SAR(10 g) = 5.02 W/kg
Maximum value of SAR (measured) = 14.9 W/kg

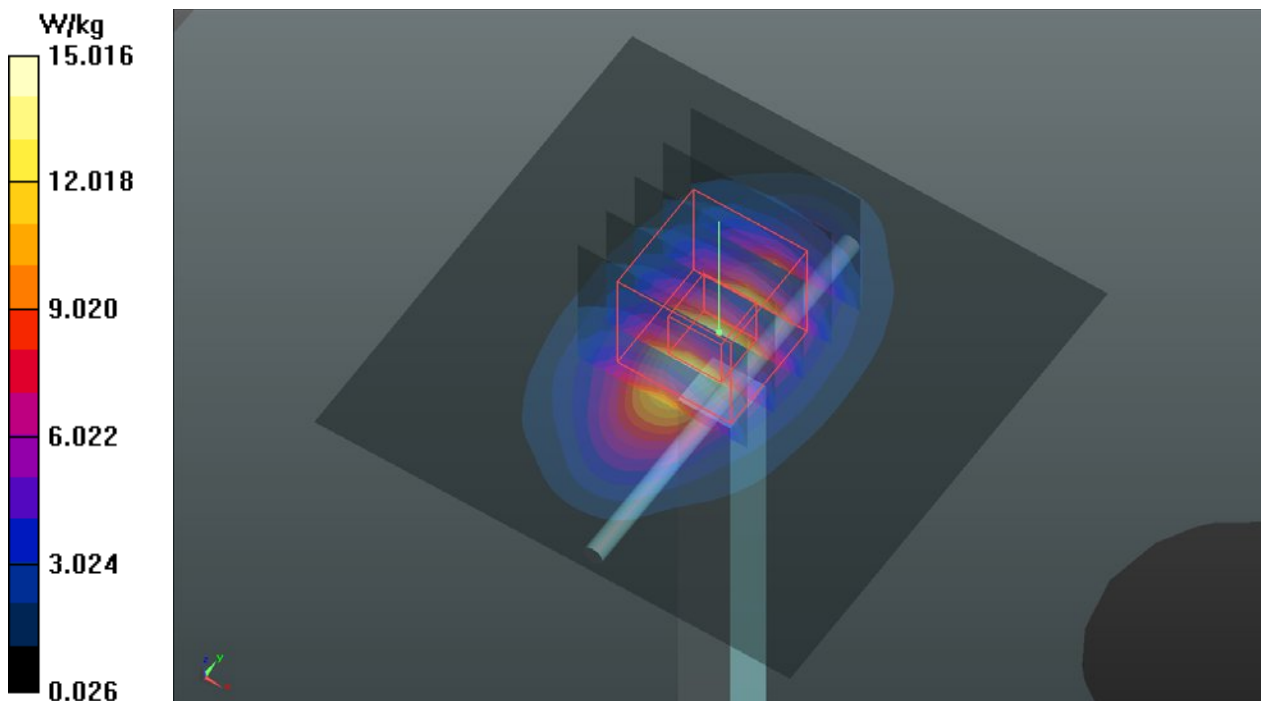

System Check_H1900_190906

DUT: Dipole 1900 MHz; Type: D1900V2; SN: 5d036

Communication System: CW; Frequency: 1900 MHz; Duty Cycle: 1:1

Medium: H16T20N1_0906 Medium parameters used: $f = 1900$ MHz; $\sigma = 1.456$ S/m; $\epsilon_r = 39.705$; $\rho = 1000$ kg/m³

Ambient Temperature : 23.7 °C ; Liquid Temperature : 23.2 °C

DASY5 Configuration:

- Probe: EX3DV4 - SN7537; ConvF(8.13, 8.13, 8.13); Calibrated: 2019/06/18
- Sensor-Surface: 1.4mm (Mechanical Surface Detection)
- Electronics: DAE4 Sn1585; Calibrated: 2019/06/07
- Phantom: SAM Phantom_1982; Type: QD 000 P41 Ax; Serial: 1982
- Measurement SW: DASY52, Version 52.10 (2); SEMCAD X Version 14.6.12 (7470)

Pin=250mW/Area Scan (61x61x1): Interpolated grid: dx=1.500 mm, dy=1.500 mm
Maximum value of SAR (interpolated) = 17.0 W/kg

Pin=250mW/Zoom Scan (5x5x7)/Cube 0: Measurement grid: dx=8mm, dy=8mm, dz=5mm
Reference Value = 111.4 V/m; Power Drift = -0.15 dB
Peak SAR (extrapolated) = 20.3 W/kg
SAR(1 g) = 10.7 W/kg; SAR(10 g) = 5.53 W/kg
Maximum value of SAR (measured) = 16.8 W/kg

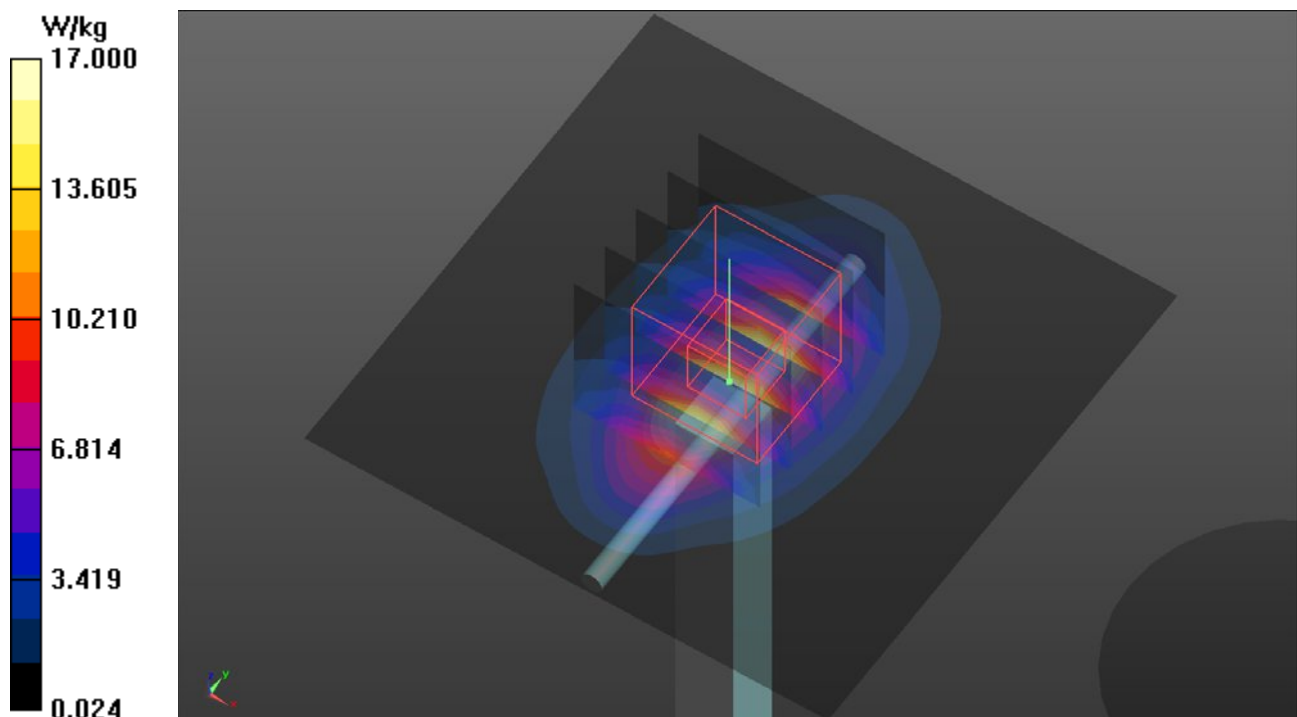

System Check_H2450_190910

DUT: Dipole 2450 MHz; Type: D2450V2; SN: 835

Communication System: CW; Frequency: 2450 MHz; Duty Cycle: 1:1

Medium: H19T27N1_0910 Medium parameters used: $f = 2450$ MHz; $\sigma = 1.881$ S/m; $\epsilon_r = 39.13$; $\rho = 1000$ kg/m³

Ambient Temperature : 23.5 °C ; Liquid Temperature : 23.2 °C

DASY5 Configuration:

- Probe: EX3DV4 - SN7537; ConvF(7.39, 7.39, 7.39); Calibrated: 2019/06/18
- Sensor-Surface: 1.4mm (Mechanical Surface Detection)
- Electronics: DAE4 Sn1585; Calibrated: 2019/06/07
- Phantom: SAM Phantom_1982; Type: QD 000 P41 Ax; Serial: 1982
- Measurement SW: DASY52, Version 52.10 (2); SEMCAD X Version 14.6.12 (7470)

Pin=250mW/Area Scan (81x81x1): Interpolated grid: dx=1.200 mm, dy=1.200 mm
Maximum value of SAR (interpolated) = 22.0 W/kg

Pin=250mW/Zoom Scan (7x7x7)/Cube 0: Measurement grid: dx=5mm, dy=5mm, dz=5mm
Reference Value = 109.6 V/m; Power Drift = -0.09 dB
Peak SAR (extrapolated) = 27.2 W/kg
SAR(1 g) = 13.2 W/kg; SAR(10 g) = 6.13 W/kg
Maximum value of SAR (measured) = 22.0 W/kg

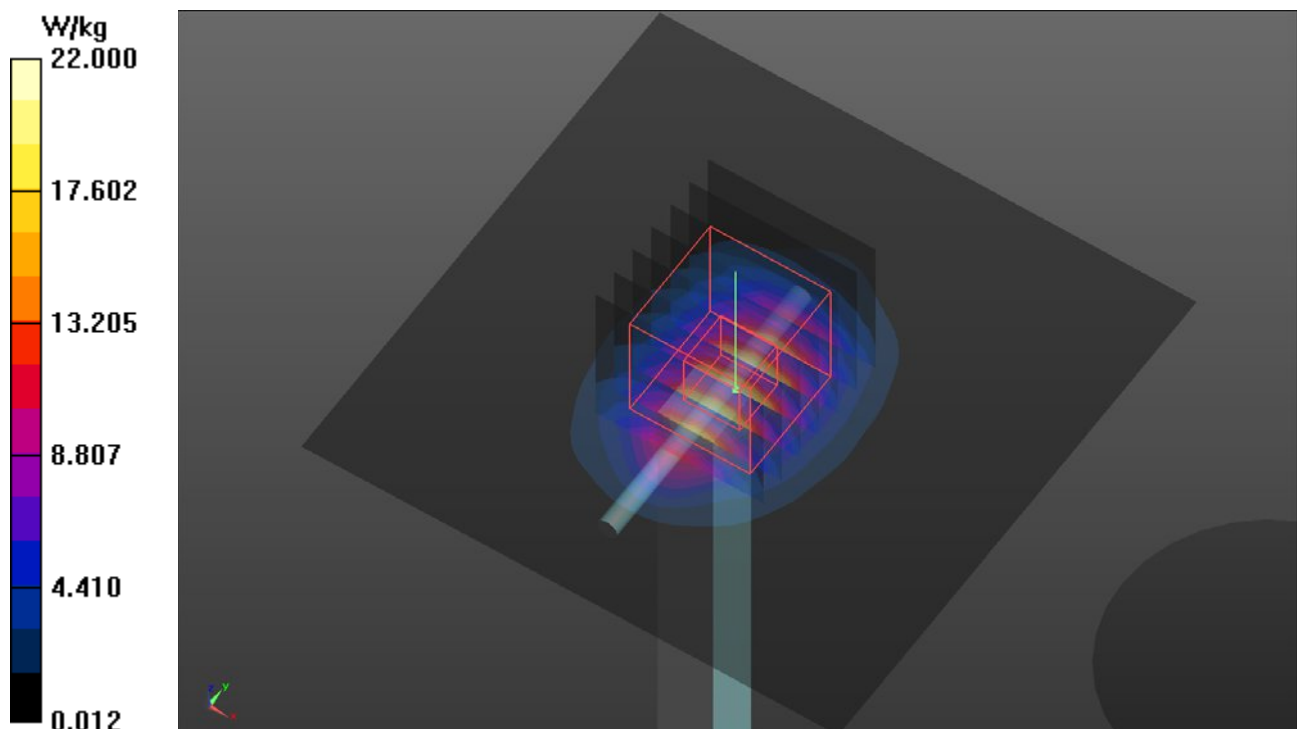

System Check_H2600_190907

DUT: Dipole 2600 MHz; Type: D2600V2; SN: 1058

Communication System: CW; Frequency: 2600 MHz; Duty Cycle: 1:1

Medium: H19T27N1_0907 Medium parameters used: $f = 2600$ MHz; $\sigma = 2.056$ S/m; $\epsilon_r = 37.803$; $\rho = 1000$ kg/m³

Ambient Temperature : 23.7 °C ; Liquid Temperature : 23.1 °C

DASY5 Configuration:

- Probe: EX3DV4 - SN7537; ConvF(7.19, 7.19, 7.19); Calibrated: 2019/06/18
- Sensor-Surface: 1.4mm (Mechanical Surface Detection)
- Electronics: DAE4 Sn1585; Calibrated: 2019/06/07
- Phantom: SAM Phantom_1982; Type: QD 000 P41 Ax; Serial: 1982
- Measurement SW: DASY52, Version 52.10 (2); SEMCAD X Version 14.6.12 (7470)

Pin=250mW/Area Scan (81x81x1): Interpolated grid: dx=1.200 mm, dy=1.200 mm
Maximum value of SAR (interpolated) = 26.4 W/kg

Pin=250mW/Zoom Scan (7x7x7)/Cube 0: Measurement grid: dx=5mm, dy=5mm, dz=5mm
Reference Value = 108.4 V/m; Power Drift = 0.06 dB
Peak SAR (extrapolated) = 33.4 W/kg
SAR(1 g) = 15.1 W/kg; SAR(10 g) = 6.64 W/kg
Maximum value of SAR (measured) = 26.5 W/kg

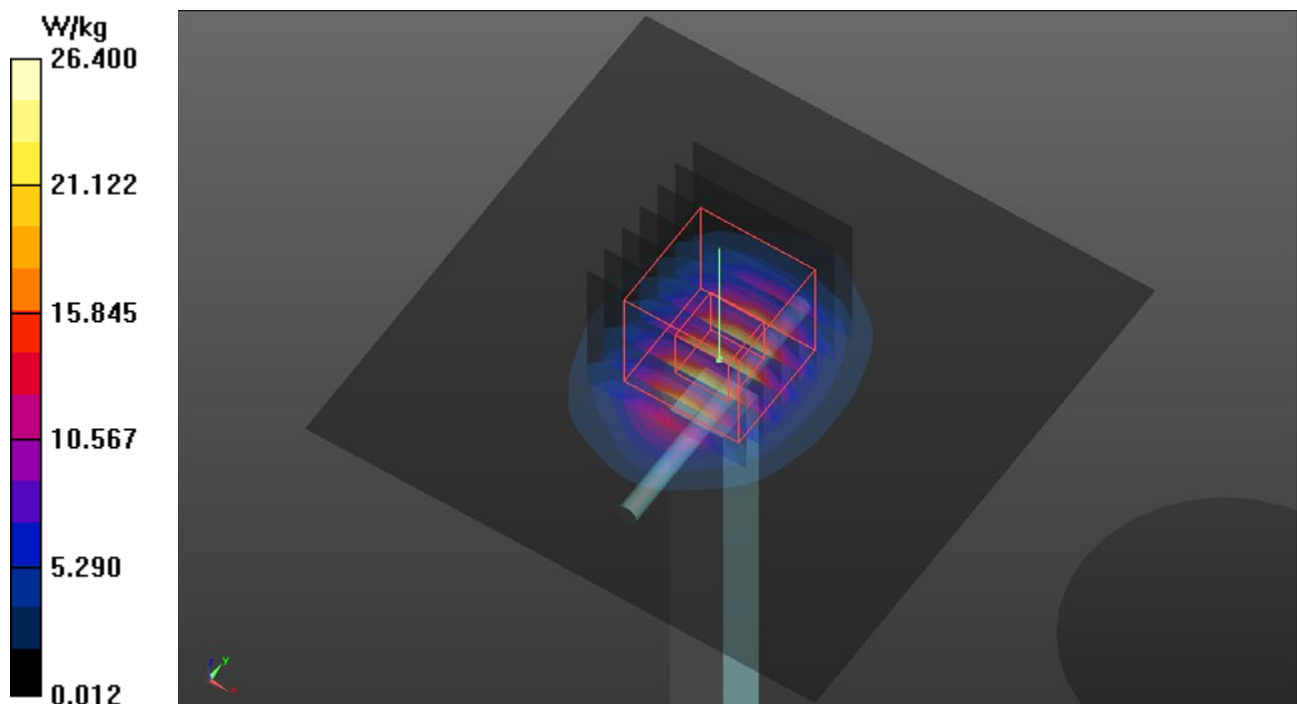

System Check_H5250_190910

DUT: Dipole 5 GHz; Type: D5GHzV2; SN: 1019

Communication System: CW; Frequency: 5250 MHz; Duty Cycle: 1:1

Medium: H34T60N1_0910 Medium parameters used: $f = 5250$ MHz; $\sigma = 4.853$ S/m; $\epsilon_r = 35.647$; $\rho = 1000$ kg/m³

Ambient Temperature : 23.5 °C ; Liquid Temperature : 23.2 °C

DASY5 Configuration:

- Probe: EX3DV4 - SN7537; ConvF(5.36, 5.36, 5.36); Calibrated: 2019/06/18
- Sensor-Surface: 1.4mm (Mechanical Surface Detection)
- Electronics: DAE4 Sn1585; Calibrated: 2019/06/07
- Phantom: SAM Phantom_1982; Type: QD 000 P41 Ax; Serial: 1982
- Measurement SW: DASY52, Version 52.10 (2); SEMCAD X Version 14.6.12 (7470)

Pin=100mW/Area Scan (91x91x1): Interpolated grid: dx=1.000 mm, dy=1.000 mm
Maximum value of SAR (interpolated) = 18.2 W/kg

Pin=100mW/Zoom Scan (7x7x12)/Cube 0: Measurement grid: dx=4mm, dy=4mm, dz=2mm
Reference Value = 69.60 V/m; Power Drift = 0.01 dB
Peak SAR (extrapolated) = 31.8 W/kg
SAR(1 g) = 7.88 W/kg; SAR(10 g) = 2.27 W/kg
Maximum value of SAR (measured) = 19.9 W/kg

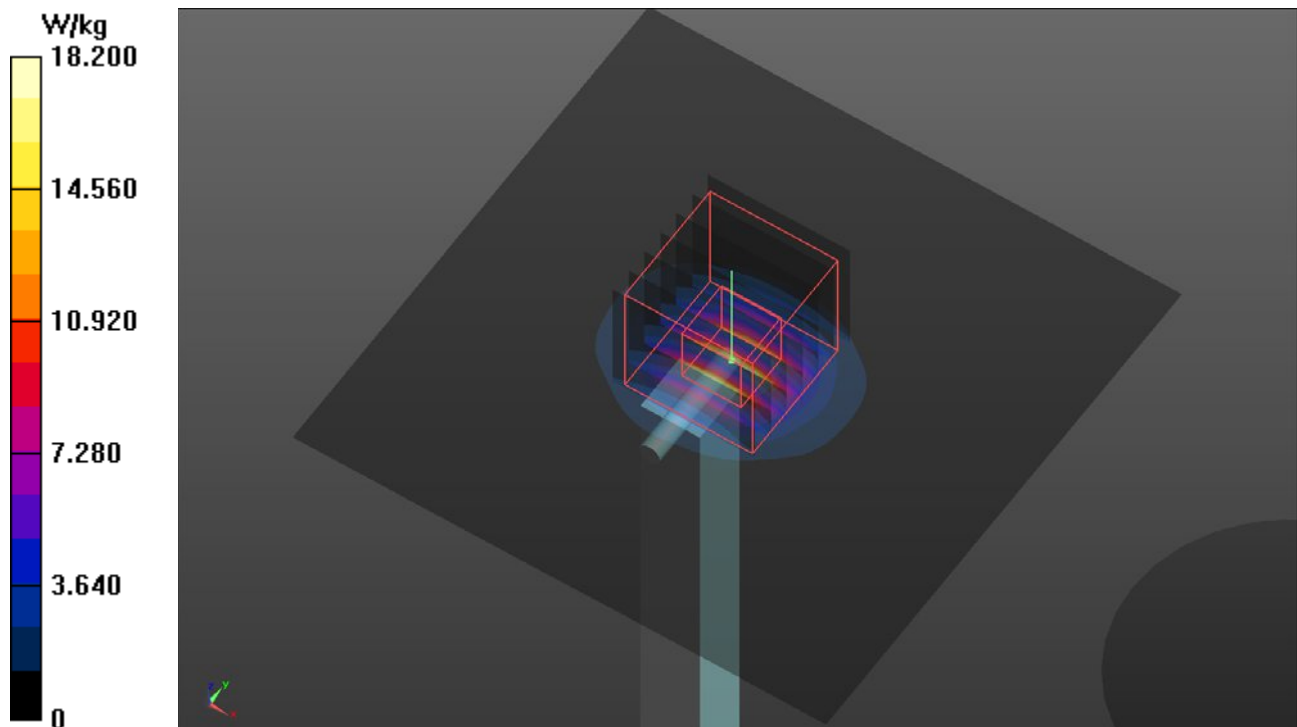

System Check_H5600_190911

DUT: Dipole 5 GHz; Type: D5GHzV2; SN: 1019

Communication System: CW; Frequency: 5600 MHz; Duty Cycle: 1:1

Medium: H34T60N1_0911 Medium parameters used: $f = 5600$ MHz; $\sigma = 5.224$ S/m; $\epsilon_r = 35.924$; $\rho = 1000$ kg/m³

Ambient Temperature : 23.5 °C ; Liquid Temperature : 23.2 °C

DASY5 Configuration:

- Probe: EX3DV4 - SN7537; ConvF(4.75, 4.75, 4.75); Calibrated: 2019/06/18
- Sensor-Surface: 1.4mm (Mechanical Surface Detection)
- Electronics: DAE4 Sn1585; Calibrated: 2019/06/07
- Phantom: SAM Phantom_1982; Type: QD 000 P41 Ax; Serial: 1982
- Measurement SW: DASY52, Version 52.10 (2); SEMCAD X Version 14.6.12 (7470)

Pin=100mW/Area Scan (91x91x1): Interpolated grid: dx=1.000 mm, dy=1.000 mm
Maximum value of SAR (interpolated) = 21.4 W/kg

Pin=100mW/Zoom Scan (7x7x12)/Cube 0: Measurement grid: dx=4mm, dy=4mm, dz=2mm
Reference Value = 63.89 V/m; Power Drift = 0.03 dB
Peak SAR (extrapolated) = 37.9 W/kg
SAR(1 g) = 8.79 W/kg; SAR(10 g) = 2.5 W/kg
Maximum value of SAR (measured) = 22.8 W/kg

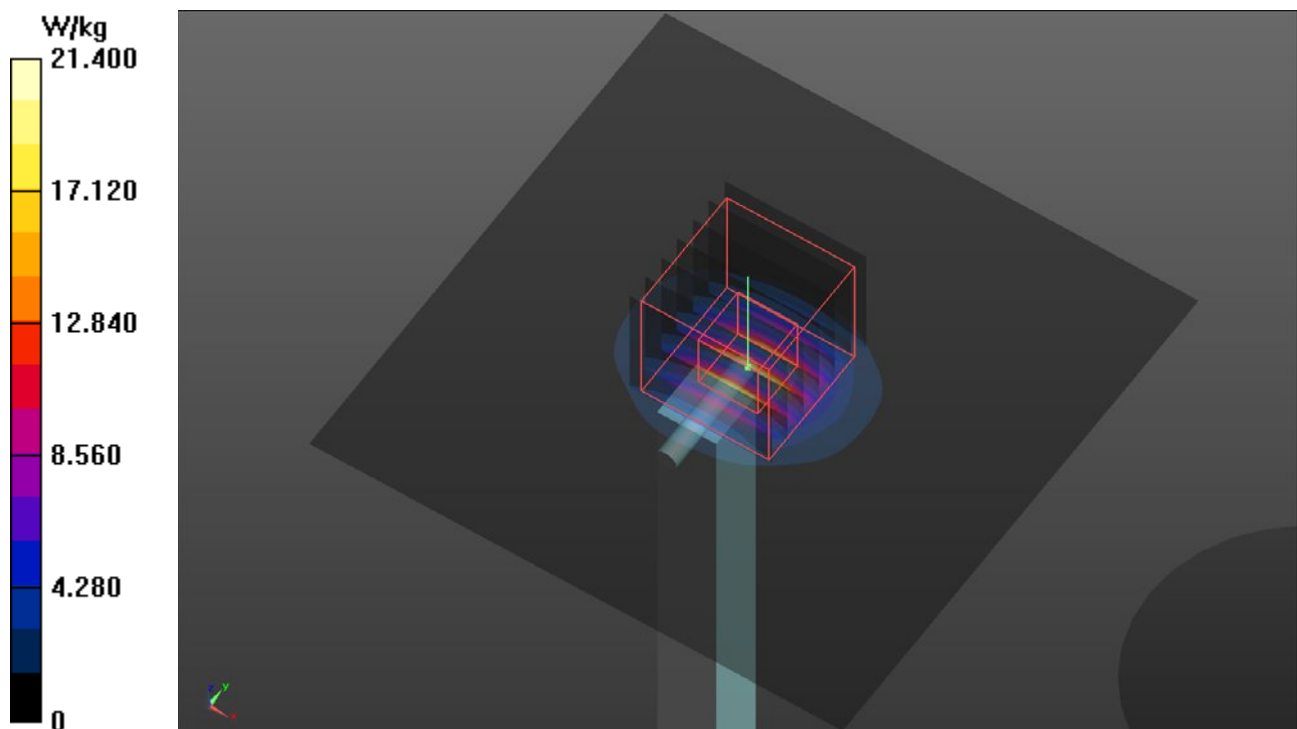

System Check_H5750_190911

DUT: Dipole 5 GHz; Type: D5GHzV2; SN: 1019

Communication System: CW; Frequency: 5750 MHz; Duty Cycle: 1:1

Medium: H34T60N1_0911 Medium parameters used: $f = 5750$ MHz; $\sigma = 5.364$ S/m; $\epsilon_r = 35.91$; $\rho = 1000$ kg/m³

Ambient Temperature : 23.5 °C ; Liquid Temperature : 23.2 °C

DASY5 Configuration:

- Probe: EX3DV4 - SN7537; ConvF(4.99, 4.99, 4.99); Calibrated: 2019/06/18
- Sensor-Surface: 1.4mm (Mechanical Surface Detection)
- Electronics: DAE4 Sn1585; Calibrated: 2019/06/07
- Phantom: SAM Phantom_1982; Type: QD 000 P41 Ax; Serial: 1982
- Measurement SW: DASY52, Version 52.10 (2); SEMCAD X Version 14.6.12 (7470)

Pin=100mW/Area Scan (91x91x1): Interpolated grid: dx=1.000 mm, dy=1.000 mm
Maximum value of SAR (interpolated) = 19.9 W/kg

Pin=100mW/Zoom Scan (7x7x12)/Cube 0: Measurement grid: dx=4mm, dy=4mm, dz=2mm
Reference Value = 70.17 V/m; Power Drift = 0.04 dB
Peak SAR (extrapolated) = 36.5 W/kg
SAR(1 g) = 8.16 W/kg; SAR(10 g) = 2.33 W/kg
Maximum value of SAR (measured) = 21.4 W/kg

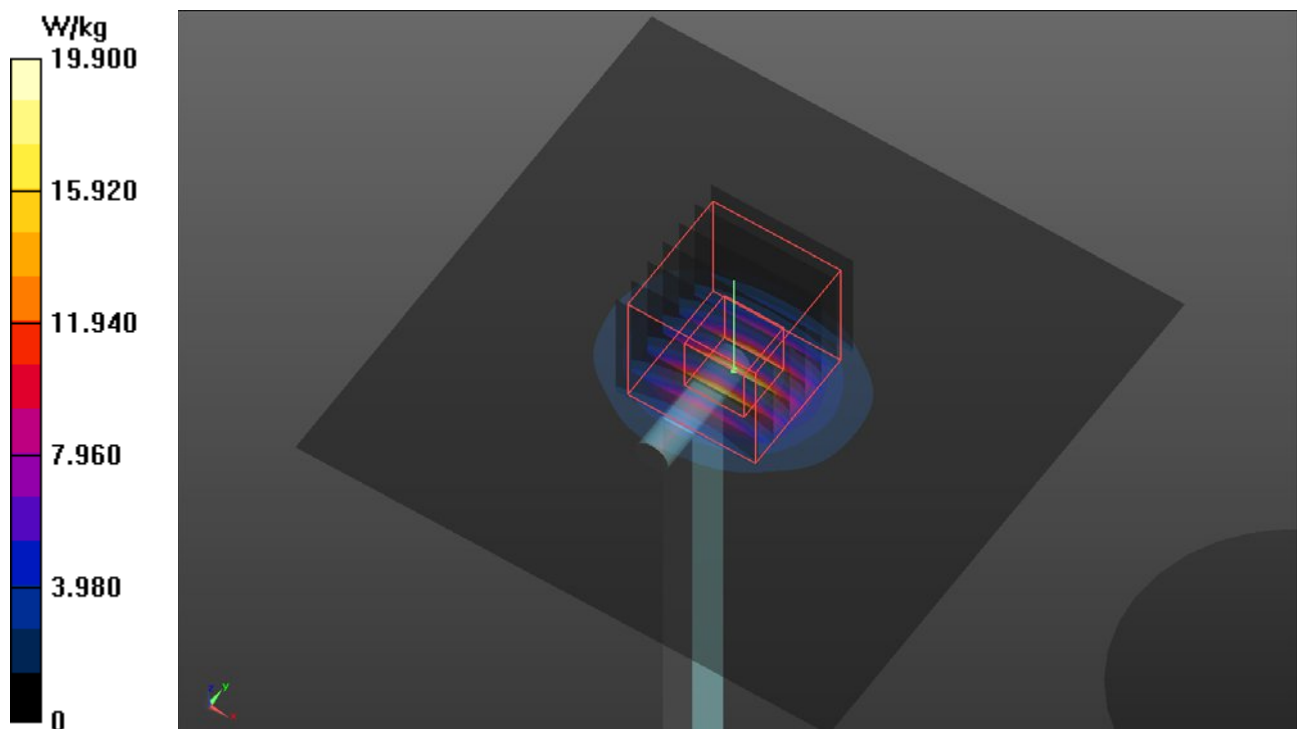

System Check_H1750_190912

DUT: Dipole 1750 MHz; Type: D1750V2; SN: 1023

Communication System: CW; Frequency: 1750 MHz; Duty Cycle: 1:1

Medium: H16T20N1_0912 Medium parameters used: $f = 1750$ MHz; $\sigma = 1.323$ S/m; $\epsilon_r = 38.973$; $\rho = 1000$ kg/m³

Ambient Temperature : 23.8 °C ; Liquid Temperature : 23.2 °C

DASY5 Configuration:

- Probe: EX3DV4 - SN7375; ConvF(8.58, 8.58, 8.58); Calibrated: 2018/12/13
- Sensor-Surface: 1.4mm (Mechanical Surface Detection)
- Electronics: DAE4 Sn1277; Calibrated: 2019/01/24
- Phantom: Twin SAM Phantom_1823; Type: QD000P40CD;
- Measurement SW: DASY52, Version 52.10 (2); SEMCAD X Version 14.6.12 (7470)

Pin=250mW/Area Scan (61x61x1): Interpolated grid: dx=1.500 mm, dy=1.500 mm

Maximum value of SAR (interpolated) = 13.5 W/kg

Pin=250mW/Zoom Scan (5x5x7)/Cube 0: Measurement grid: dx=8mm, dy=8mm, dz=5mm

Reference Value = 104.9 V/m; Power Drift = -0.02 dB

Peak SAR (extrapolated) = 16.1 W/kg

SAR(1 g) = 8.75 W/kg; SAR(10 g) = 4.63 W/kg

Maximum value of SAR (measured) = 13.6 W/kg

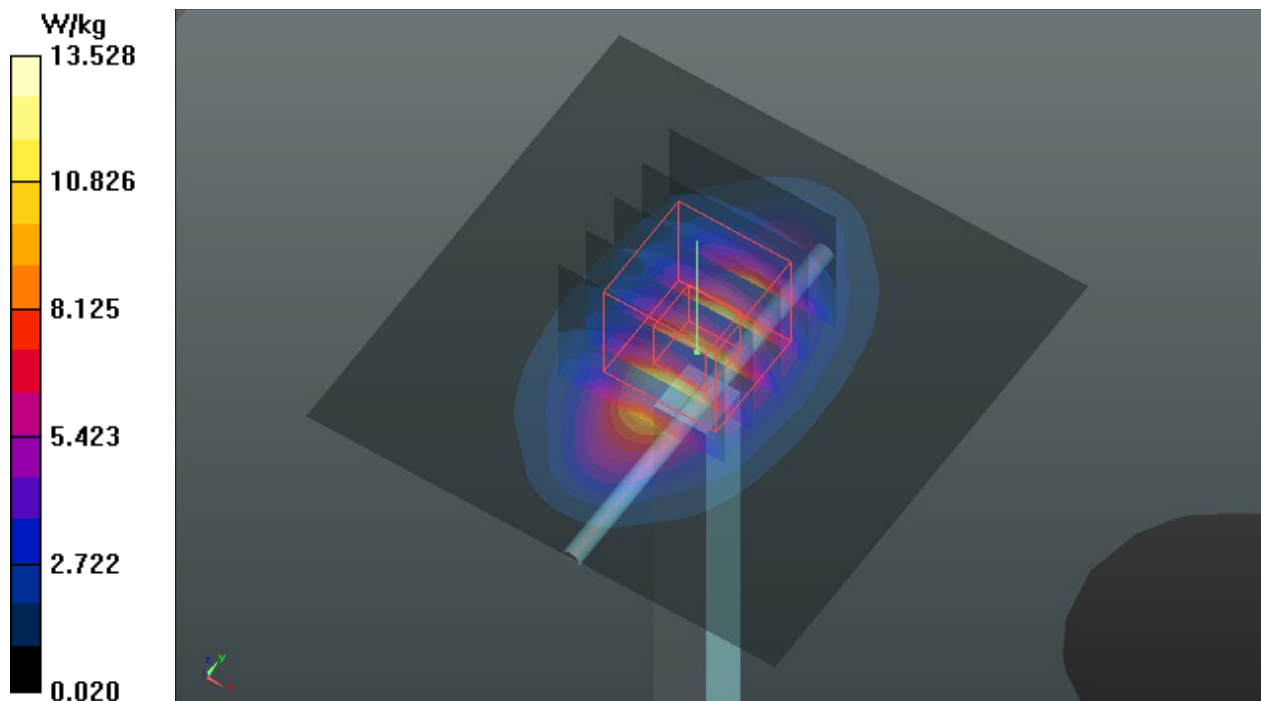

System Check_H1900_190912

DUT: Dipole 1900 MHz; Type: D1900V2; SN: 5d036

Communication System: CW; Frequency: 1900 MHz; Duty Cycle: 1:1

Medium: H16T20N1_0912 Medium parameters used: $f = 1900$ MHz; $\sigma = 1.449$ S/m; $\epsilon_r = 38.48$; $\rho = 1000$ kg/m³

Ambient Temperature : 23.8 °C ; Liquid Temperature : 23.2 °C

DASY5 Configuration:

- Probe: EX3DV4 - SN7375; ConvF(8.26, 8.26, 8.26); Calibrated: 2018/12/13
- Sensor-Surface: 1.4mm (Mechanical Surface Detection)
- Electronics: DAE4 Sn1277; Calibrated: 2019/01/24
- Phantom: Twin SAM Phantom_1823; Type: QD000P40CD;
- Measurement SW: DASY52, Version 52.10 (2); SEMCAD X Version 14.6.12 (7470)

Pin=250mW/Area Scan (61x61x1): Interpolated grid: dx=1.500 mm, dy=1.500 mm

Maximum value of SAR (interpolated) = 17.3 W/kg

Pin=250mW/Zoom Scan (5x5x7)/Cube 0: Measurement grid: dx=8mm, dy=8mm, dz=5mm

Reference Value = 102.2 V/m; Power Drift = -0.05 dB

Peak SAR (extrapolated) = 19.6 W/kg

SAR(1 g) = 10.5 W/kg; SAR(10 g) = 5.48 W/kg

Maximum value of SAR (measured) = 16.4 W/kg

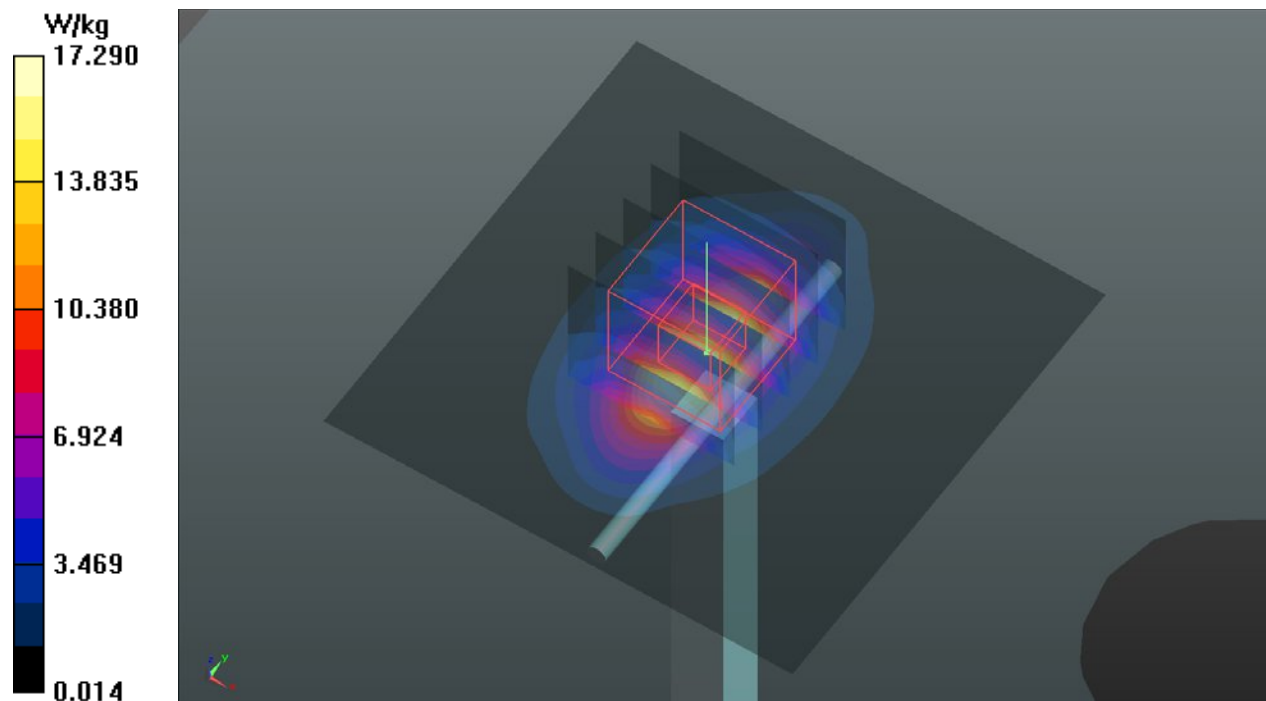

System Check_H2600_190922

DUT: Dipole 2600 MHz; Type: D2600V2; SN: 1058

Communication System: CW; Frequency: 2600 MHz; Duty Cycle: 1:1

Medium: H19T27N1_0922 Medium parameters used: $f = 2600$ MHz; $\sigma = 2.043$ S/m; $\epsilon_r = 37.822$; $\rho = 1000$ kg/m³

Ambient Temperature : 23.7 °C ; Liquid Temperature : 23.4 °C

DASY5 Configuration:

- Probe: EX3DV4 - SN3971; ConvF(7.48, 7.48, 7.48); Calibrated: 2019/03/29
- Sensor-Surface: 1.4mm (Mechanical Surface Detection)
- Electronics: DAE4 Sn1431; Calibrated: 2019/03/25
- Phantom: Twin SAM Phantom_1496; Type: QD000P40CB;
- Measurement SW: DASY52, Version 52.10 (2); SEMCAD X Version 14.6.12 (7470)

Pin=250mW/Area Scan (81x81x1): Interpolated grid: dx=1.200 mm, dy=1.200 mm
Maximum value of SAR (interpolated) = 24.4 W/kg

Pin=250mW/Zoom Scan (7x7x7)/Cube 0: Measurement grid: dx=5mm, dy=5mm, dz=5mm
Reference Value = 105.0 V/m; Power Drift = 0.00 dB
Peak SAR (extrapolated) = 30.7 W/kg
SAR(1 g) = 14 W/kg; SAR(10 g) = 6.31 W/kg
Maximum value of SAR (measured) = 24.3 W/kg

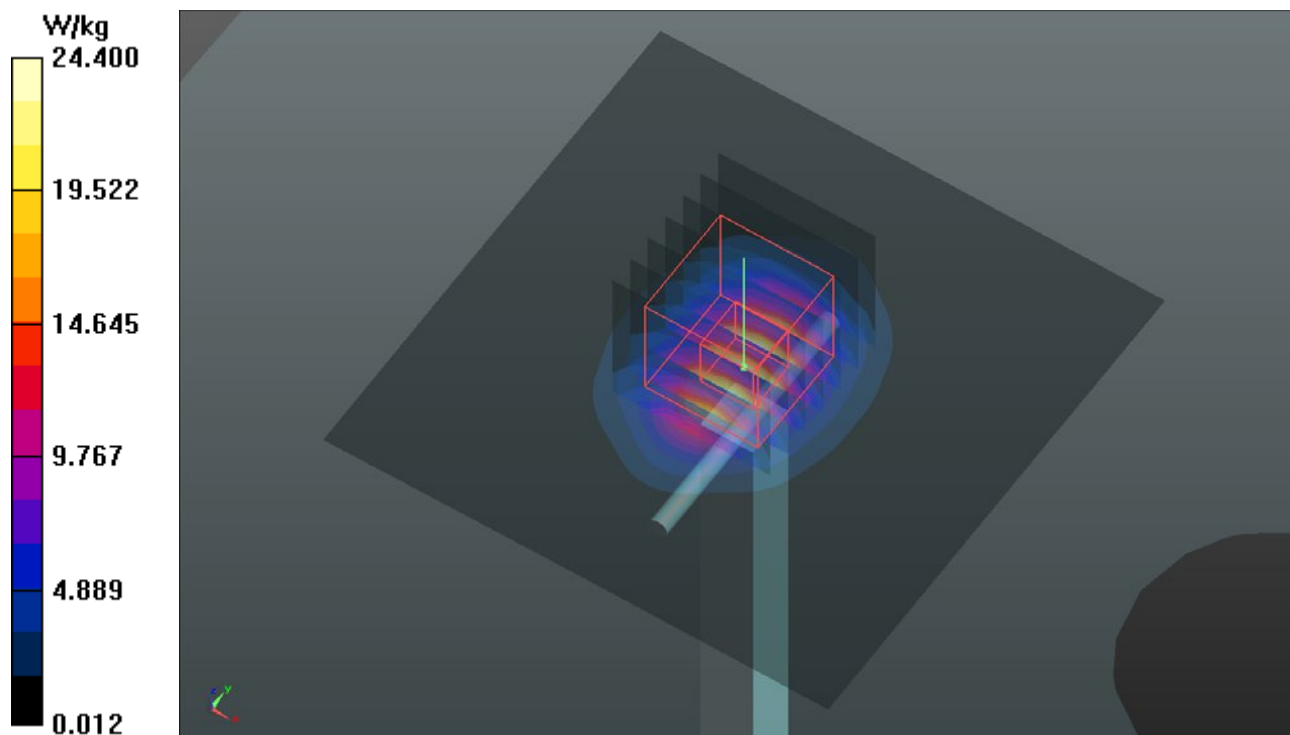

System Check_H5250_190908

DUT: Dipole 5 GHz; Type: D5GHzV2; SN: 1019

Communication System: CW; Frequency: 5250 MHz; Duty Cycle: 1:1

Medium: H34T60N1_0908 Medium parameters used: $f = 5250$ MHz; $\sigma = 4.744$ S/m; $\epsilon_r = 36.854$; $\rho = 1000$ kg/m³

Ambient Temperature : 23.4 °C ; Liquid Temperature : 23.2 °C

DASY5 Configuration:

- Probe: EX3DV4 - SN7537; ConvF(5.36, 5.36, 5.36); Calibrated: 2019/06/18
- Sensor-Surface: 1.4mm (Mechanical Surface Detection)
- Electronics: DAE4 Sn1585; Calibrated: 2019/06/07
- Phantom: SAM Phantom_1982; Type: QD 000 P41 Ax; Serial: 1982
- Measurement SW: DASY52, Version 52.10 (2); SEMCAD X Version 14.6.12 (7470)

Pin=100mW/Area Scan (91x91x1): Interpolated grid: dx=1.000 mm, dy=1.000 mm
Maximum value of SAR (interpolated) = 18.5 W/kg

Pin=100mW/Zoom Scan (7x7x12)/Cube 0: Measurement grid: dx=4mm, dy=4mm, dz=2mm
Reference Value = 71.15 V/m; Power Drift = 0.04 dB
Peak SAR (extrapolated) = 34.8 W/kg
SAR(1 g) = 8.06 W/kg; SAR(10 g) = 2.31 W/kg
Maximum value of SAR (measured) = 20.6 W/kg

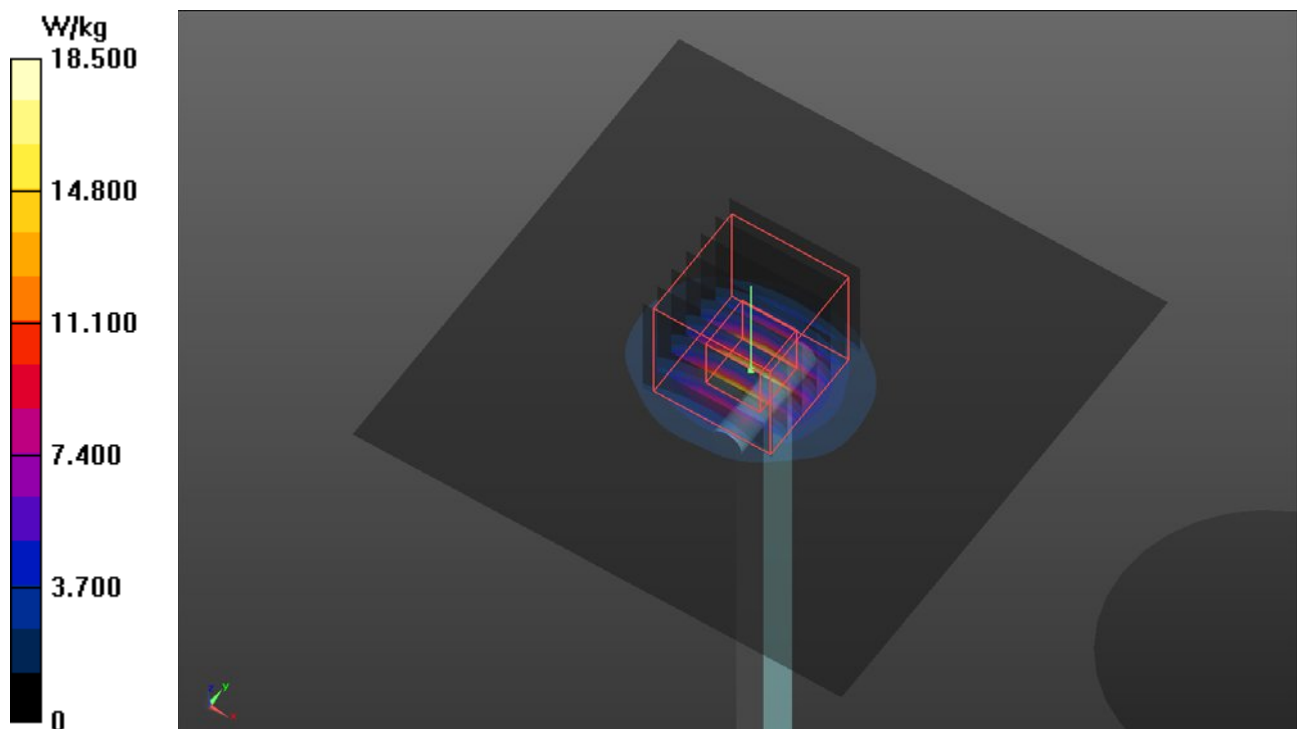

System Check_H5600_190922

DUT: Dipole 5 GHz; Type: D5GHzV2; SN: 1019

Communication System: CW; Frequency: 5600 MHz; Duty Cycle: 1:1

Medium: H34T60N2_0922 Medium parameters used: $f = 5600$ MHz; $\sigma = 5.129$ S/m; $\epsilon_r = 35.495$; $\rho = 1000$ kg/m³

Ambient Temperature : 23.7 °C ; Liquid Temperature : 23.4 °C

DASY5 Configuration:

- Probe: EX3DV4 - SN3971; ConvF(4.78, 4.78, 4.78); Calibrated: 2019/03/29
- Sensor-Surface: 1.4mm (Mechanical Surface Detection)
- Electronics: DAE4 Sn1431; Calibrated: 2019/03/25
- Phantom: Twin SAM Phantom_1496; Type: QD000P40CB;
- Measurement SW: DASY52, Version 52.10 (2); SEMCAD X Version 14.6.12 (7470)

Pin=100mW/Area Scan (91x91x1): Interpolated grid: dx=1.000 mm, dy=1.000 mm
Maximum value of SAR (interpolated) = 21.6 W/kg

Pin=100mW/Zoom Scan (7x7x12)/Cube 0: Measurement grid: dx=4mm, dy=4mm, dz=2mm
Reference Value = 74.09 V/m; Power Drift = -0.14 dB
Peak SAR (extrapolated) = 39.5 W/kg
SAR(1 g) = 8.74 W/kg; SAR(10 g) = 2.49 W/kg
Maximum value of SAR (measured) = 22.7 W/kg

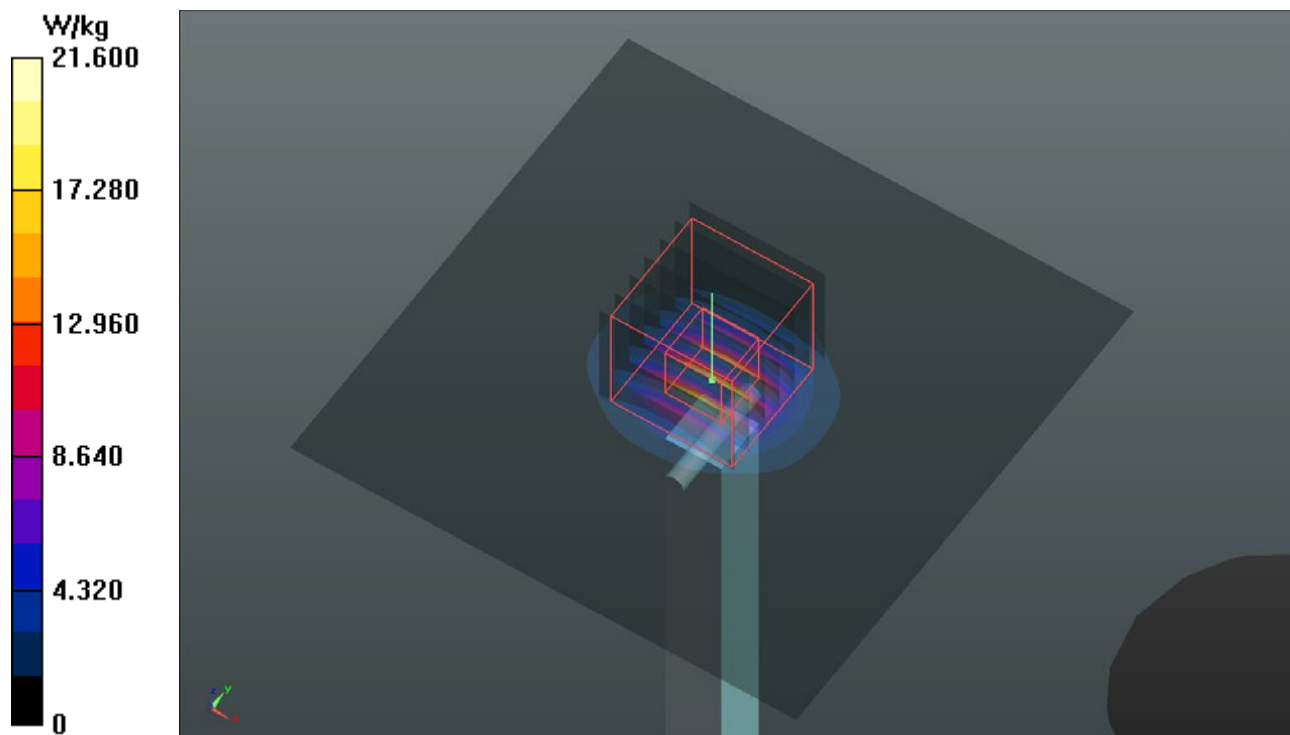

Appendix B. SAR Plots of SAR Measurement

The SAR plots for highest measured SAR in each exposure configuration, wireless mode and frequency band combination, and measured SAR > 1.5 W/kg are shown as follows.

P01 GSM850_GPRS12_Right Cheek_Ch251_Ant0_Sensor OFF

DUT: 190827C07

Communication System: GPRS12; Frequency: 848.8 MHz; Duty Cycle: 1:2

Medium: H07T10N1_0906 Medium parameters used: $f = 849$ MHz; $\sigma = 0.941$ S/m; $\epsilon_r = 41.809$; $\rho = 1000$ kg/m³

Ambient Temperature : 23.7 °C ; Liquid Temperature : 23.2 °C

DASY5 Configuration:

- Probe: EX3DV4 - SN7537; ConvF(10.48, 10.48, 10.48); Calibrated: 2019/06/18
- Sensor-Surface: 1.4mm (Mechanical Surface Detection)
- Electronics: DAE4 Sn1585; Calibrated: 2019/06/07
- Phantom: SAM Phantom_1982; Type: QD 000 P41 Ax; Serial: 1982
- Measurement SW: DASY52, Version 52.10 (2); SEMCAD X Version 14.6.12 (7470)

- **Area Scan (81x141x1)**: Interpolated grid: dx=1.500 mm, dy=1.500 mm
Maximum value of SAR (interpolated) = 0.149 W/kg

- **Zoom Scan (5x5x7)/Cube 0**: Measurement grid: dx=8mm, dy=8mm, dz=5mm
Reference Value = 4.396 V/m; Power Drift = -0.16 dB
Peak SAR (extrapolated) = 0.167 W/kg
SAR(1 g) = 0.125 W/kg; SAR(10 g) = 0.094 W/kg
Maximum value of SAR (measured) = 0.151 W/kg

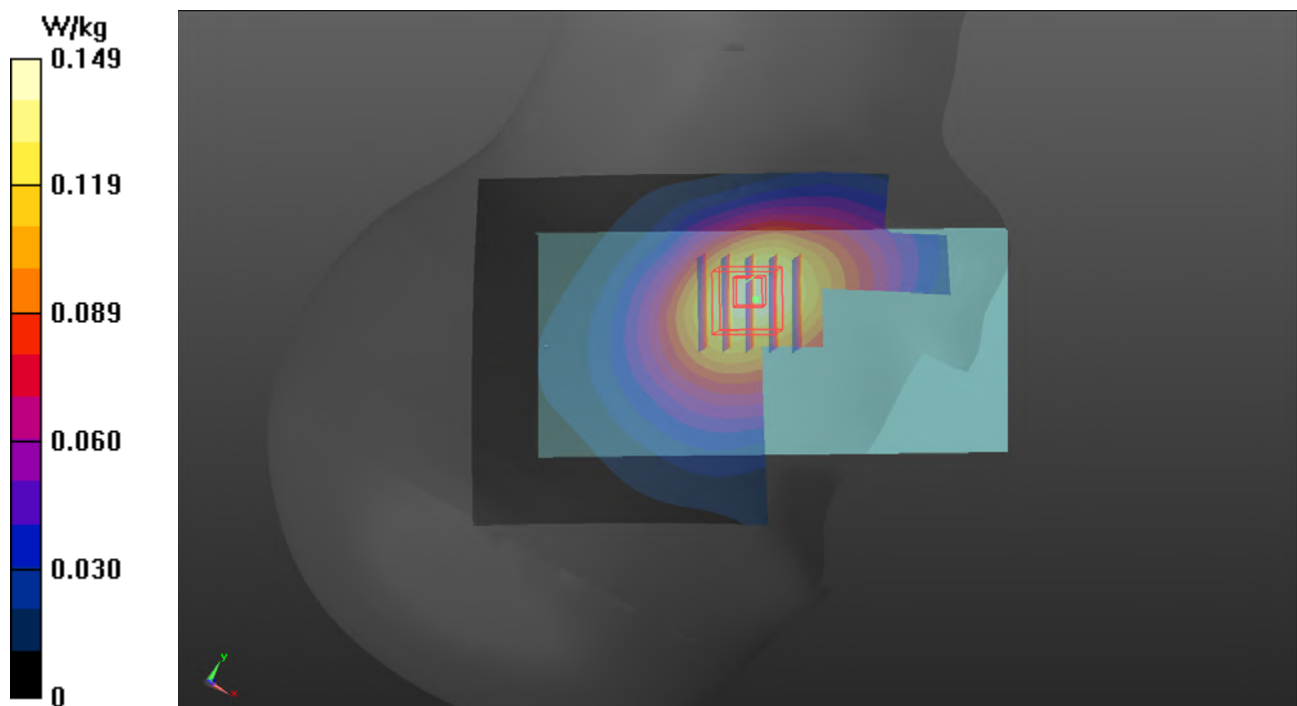

P02 GSM1900_GPRS8_Left Cheek_Ch512_Ant0_Sensor OFF

DUT: 190827C07

Communication System: GPRS8; Frequency: 1850.2 MHz; Duty Cycle: 1:8.3

Medium: H16T20N1_0906 Medium parameters used: $f = 1850.2$ MHz; $\sigma = 1.412$ S/m; $\epsilon_r = 39.87$; $\rho = 1000$ kg/m³

Ambient Temperature : 23.7 °C ; Liquid Temperature : 23.2 °C

DASY5 Configuration:

- Probe: EX3DV4 - SN7537; ConvF(8.13, 8.13, 8.13); Calibrated: 2019/06/18

- Sensor-Surface: 1.4mm (Mechanical Surface Detection)

- Electronics: DAE4 Sn1585; Calibrated: 2019/06/07

- Phantom: SAM Phantom_1982; Type: QD 000 P41 Ax; Serial: 1982

- Measurement SW: DASY52, Version 52.10 (2); SEMCAD X Version 14.6.12 (7470)

- **Area Scan (81x141x1)**: Interpolated grid: dx=1.500 mm, dy=1.500 mm

Maximum value of SAR (interpolated) = 0.128 W/kg

- **Zoom Scan (5x5x7)/Cube 0**: Measurement grid: dx=8mm, dy=8mm, dz=5mm

Reference Value = 3.676 V/m; Power Drift = 0.17 dB

Peak SAR (extrapolated) = 0.131 W/kg

SAR(1 g) = 0.083 W/kg; SAR(10 g) = 0.053 W/kg

Maximum value of SAR (measured) = 0.108 W/kg

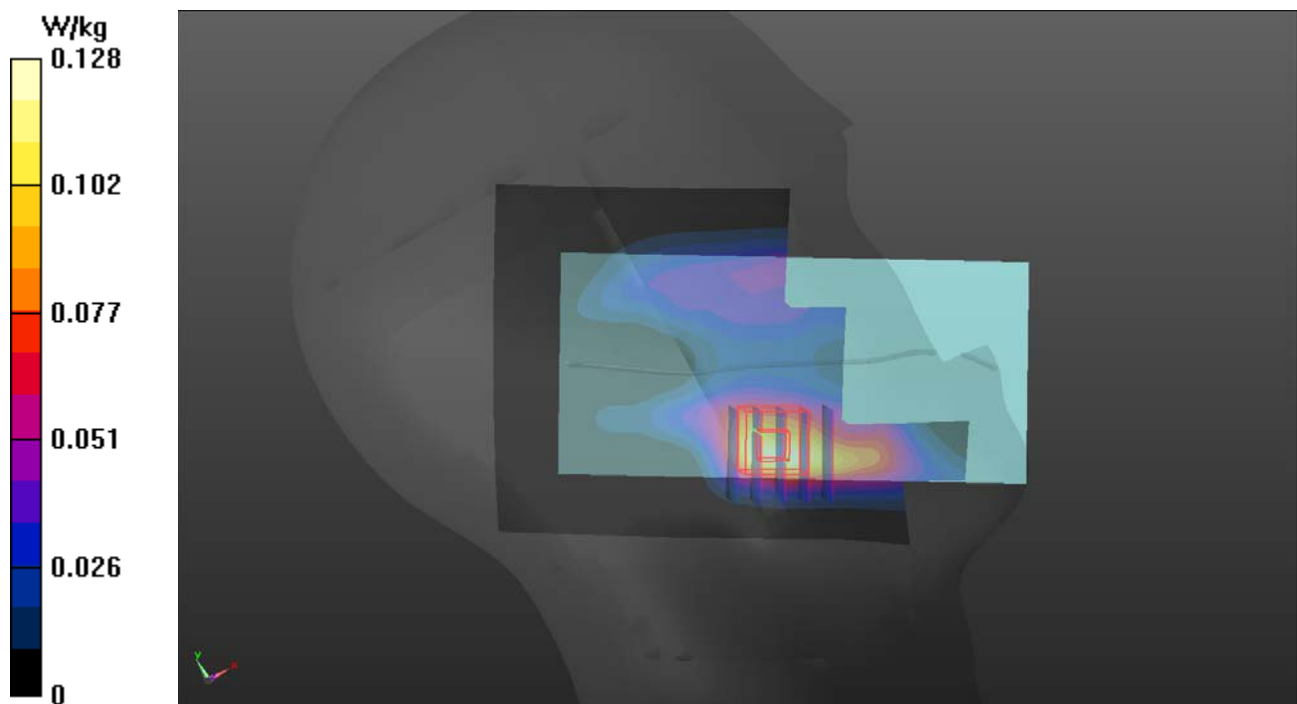

P03 WCDMA II_RMC12.2K_Right Cheek_Ant0_Sensor OFF

DUT: 190827C07

Communication System: WCDMA; Frequency: 1907.6 MHz; Duty Cycle: 1:1

Medium: H16T20N1_0906 Medium parameters used: $f = 1908$ MHz; $\sigma = 1.463$ S/m; $\epsilon_r = 39.674$; $\rho = 1000$ kg/m³

Ambient Temperature : 23.8 °C ; Liquid Temperature : 23.3 °C

DASY5 Configuration:

- Probe: EX3DV4 - SN7537; ConvF(8.13, 8.13, 8.13); Calibrated: 2019/06/18

- Sensor-Surface: 1.4mm (Mechanical Surface Detection)

- Electronics: DAE4 Sn1585; Calibrated: 2019/06/07

- Phantom: SAM Phantom_1982; Type: QD 000 P41 Ax; Serial: 1982

- Measurement SW: DASY52, Version 52.10 (2); SEMCAD X Version 14.6.12 (7470)

- **Area Scan (81x141x1)**: Interpolated grid: dx=1.500 mm, dy=1.500 mm

Maximum value of SAR (interpolated) = 0.150 W/kg

- **Zoom Scan (5x5x7)/Cube 0**: Measurement grid: dx=8mm, dy=8mm, dz=5mm

Reference Value = 4.718 V/m; Power Drift = 0.10 dB

Peak SAR (extrapolated) = 0.202 W/kg

SAR(1 g) = 0.124 W/kg; SAR(10 g) = 0.077 W/kg

Maximum value of SAR (measured) = 0.167 W/kg

- **Zoom Scan (5x5x7)/Cube 1**: Measurement grid: dx=8mm, dy=8mm, dz=5mm

Reference Value = 4.718 V/m; Power Drift = 0.10 dB

Peak SAR (extrapolated) = 0.197 W/kg

SAR(1 g) = 0.124 W/kg; SAR(10 g) = 0.077 W/kg

Maximum value of SAR (measured) = 0.167 W/kg

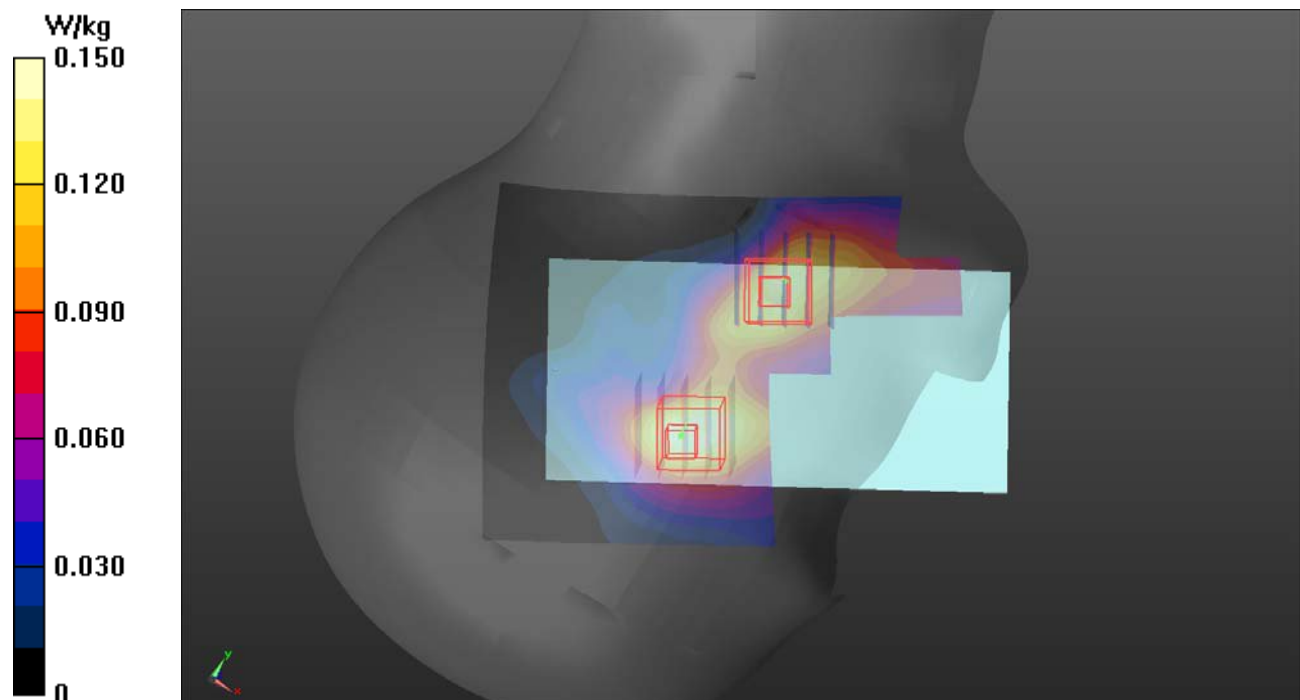

P04 WCDMA IV_RMC12.2K_Left Cheek_Ant0_Sensor OFF

DUT: 190827C07

Communication System: WCDMA; Frequency: 1752.6 MHz; Duty Cycle: 1:1

Medium: H16T20N1_0906 Medium parameters used: $f = 1753$ MHz; $\sigma = 1.323$ S/m; $\epsilon_r = 40.248$; $\rho = 1000$ kg/m³

Ambient Temperature : 23.8 °C ; Liquid Temperature : 23.3 °C

DASY5 Configuration:

- Probe: EX3DV4 - SN7537; ConvF(8.44, 8.44, 8.44); Calibrated: 2019/06/18

- Sensor-Surface: 1.4mm (Mechanical Surface Detection)

- Electronics: DAE4 Sn1585; Calibrated: 2019/06/07

- Phantom: SAM Phantom_1982; Type: QD 000 P41 Ax; Serial: 1982

- Measurement SW: DASY52, Version 52.10 (2); SEMCAD X Version 14.6.12 (7470)

- **Area Scan (81x141x1)**: Interpolated grid: dx=1.500 mm, dy=1.500 mm

Maximum value of SAR (interpolated) = 0.191 W/kg

- **Zoom Scan (5x5x7)/Cube 0**: Measurement grid: dx=8mm, dy=8mm, dz=5mm

Reference Value = 6.034 V/m; Power Drift = 0.05 dB

Peak SAR (extrapolated) = 0.209 W/kg

SAR(1 g) = 0.137 W/kg; SAR(10 g) = 0.088 W/kg

Maximum value of SAR (measured) = 0.181 W/kg

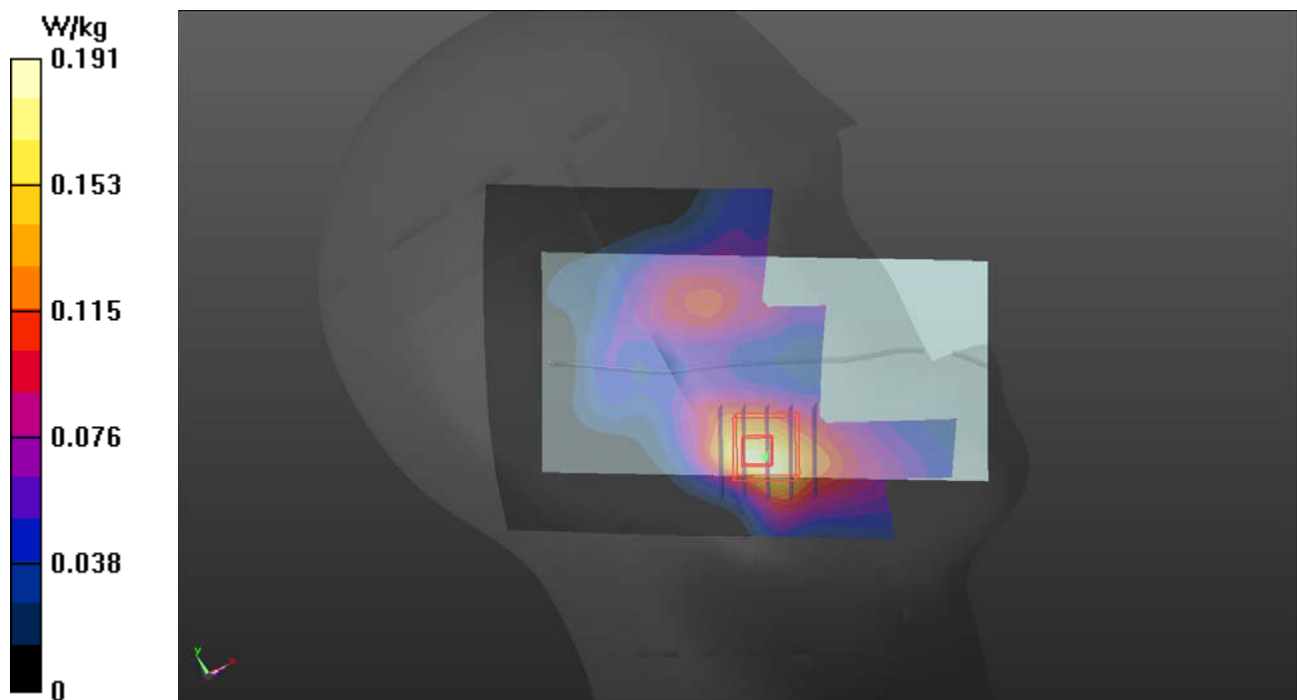

P05 WCDMA V_RMC12.2K_Right Cheek_Ch4233_Ant 0_Sensor OFF

DUT: 190827C07

Communication System: WCDMA; Frequency: 846.6 MHz; Duty Cycle: 1:1

Medium: H07T10N1_0923 Medium parameters used: $f = 847$ MHz; $\sigma = 0.924$ S/m; $\epsilon_r = 42.579$; $\rho = 1000$ kg/m³

Ambient Temperature : 23.7 °C ; Liquid Temperature : 23.4 °C

DASY5 Configuration:

- Probe: EX3DV4 - SN3971; ConvF(10.18, 10.18, 10.18); Calibrated: 2019/03/29
- Sensor-Surface: 1.4mm (Mechanical Surface Detection)
- Electronics: DAE4 Sn1431; Calibrated: 2019/03/25
- Phantom: Twin SAM Phantom_1496; Type: QD000P40CA;
- Measurement SW: DASY52, Version 52.10 (2); SEMCAD X Version 14.6.12 (7470)

- **Area Scan (81x141x1):** Interpolated grid: dx=1.500 mm, dy=1.500 mm

Maximum value of SAR (interpolated) = 0.171 W/kg

- **Zoom Scan (5x5x7)/Cube 0:** Measurement grid: dx=8mm, dy=8mm, dz=5mm

Reference Value = 13.22 V/m; Power Drift = -0.03 dB

Peak SAR (extrapolated) = 0.179 W/kg

SAR(1 g) = 0.135 W/kg; SAR(10 g) = 0.104 W/kg

Maximum value of SAR (measured) = 0.162 W/kg

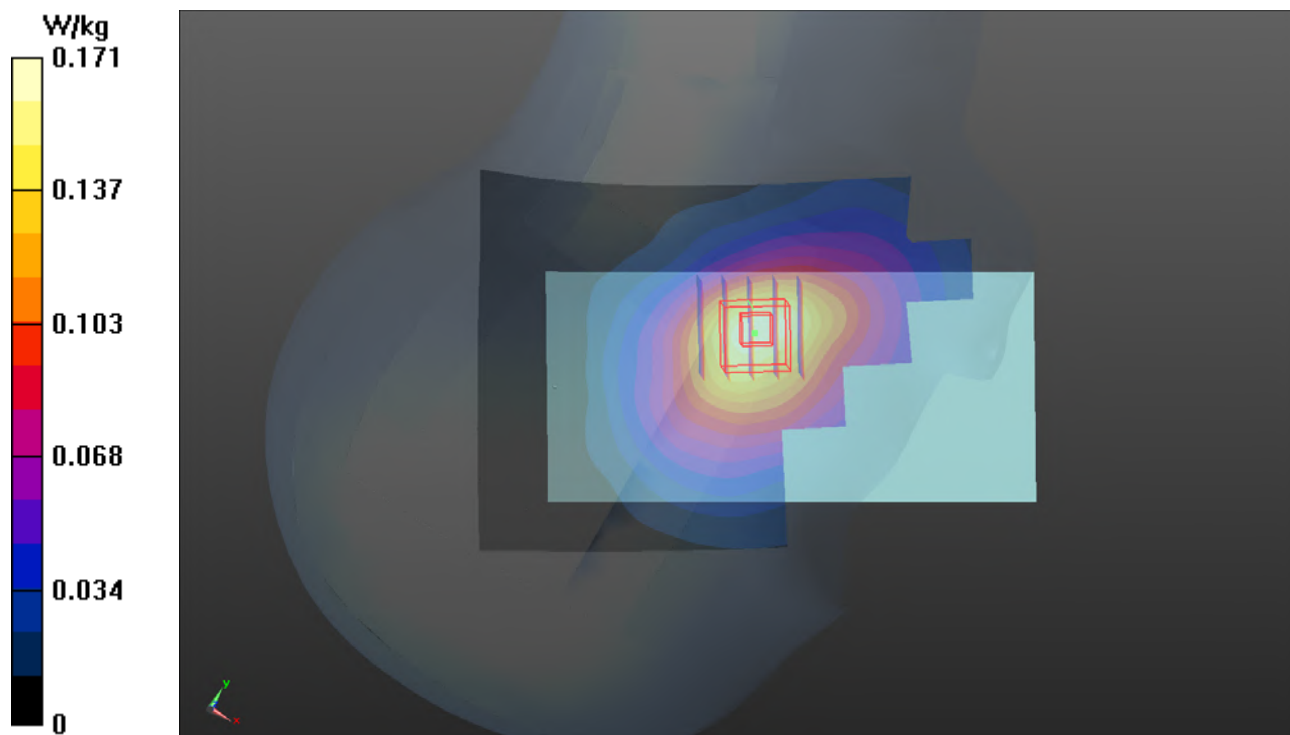

P06 LTE 2_QPSK20M_Right Cheek_Ch18700_1RB_OS0_Ant0_Sensor OFF

DUT: 190827C07

Communication System: LTE; Frequency: 1860 MHz; Duty Cycle: 1:1

Medium: H16T20N1_0906 Medium parameters used: $f = 1860$ MHz; $\sigma = 1.421$ S/m; $\epsilon_r = 39.839$; $\rho = 1000$ kg/m³

Ambient Temperature : 23.8 °C ; Liquid Temperature : 23.3 °C

DASY5 Configuration:

- Probe: EX3DV4 - SN7537; ConvF(8.13, 8.13, 8.13); Calibrated: 2019/06/18
- Sensor-Surface: 1.4mm (Mechanical Surface Detection)
- Electronics: DAE4 Sn1585; Calibrated: 2019/06/07
- Phantom: SAM Phantom_1982; Type: QD 000 P41 Ax; Serial: 1982
- Measurement SW: DASY52, Version 52.10 (2); SEMCAD X Version 14.6.12 (7470)

- **Area Scan (81x141x1):** Interpolated grid: dx=1.500 mm, dy=1.500 mm
 Maximum value of SAR (interpolated) = 0.162 W/kg

- **Zoom Scan (5x5x7)/Cube 0:** Measurement grid: dx=8mm, dy=8mm, dz=5mm
 Reference Value = 4.402 V/m; Power Drift = -0.12 dB
 Peak SAR (extrapolated) = 0.211 W/kg
SAR(1 g) = 0.130 W/kg; SAR(10 g) = 0.081 W/kg
 Maximum value of SAR (measured) = 0.174 W/kg

- **Zoom Scan (5x5x7)/Cube 1:** Measurement grid: dx=8mm, dy=8mm, dz=5mm
 Reference Value = 4.402 V/m; Power Drift = -0.12 dB
 Peak SAR (extrapolated) = 0.198 W/kg
SAR(1 g) = 0.105 W/kg; SAR(10 g) = 0.054 W/kg
 Maximum value of SAR (measured) = 0.162 W/kg

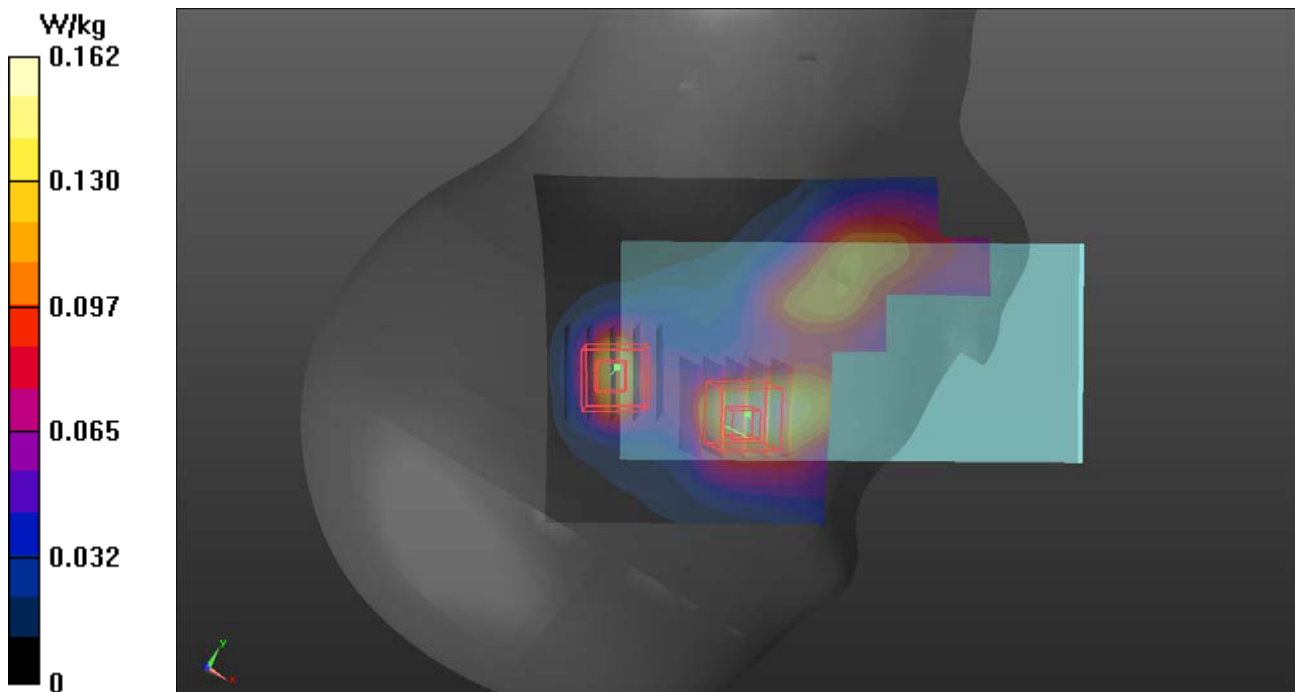

P07 LTE 4_QPSK20M_Left Cheek_Ch20050_1RB_OS0_Ant0_Sensor OFF

DUT: 190827C07

Communication System: LTE; Frequency: 1720 MHz; Duty Cycle: 1:1

Medium: H16T20N1_0906 Medium parameters used: $f = 1720$ MHz; $\sigma = 1.292$ S/m; $\epsilon_r = 40.374$; $\rho = 1000$ kg/m³

Ambient Temperature : 23.8 °C ; Liquid Temperature : 23.3 °C

DASY5 Configuration:

- Probe: EX3DV4 - SN7537; ConvF(8.44, 8.44, 8.44); Calibrated: 2019/06/18
- Sensor-Surface: 1.4mm (Mechanical Surface Detection)
- Electronics: DAE4 Sn1585; Calibrated: 2019/06/07
- Phantom: SAM Phantom_1982; Type: QD 000 P41 Ax; Serial: 1982
- Measurement SW: DASY52, Version 52.10 (2); SEMCAD X Version 14.6.12 (7470)

- **Area Scan (81x141x1)**: Interpolated grid: dx=1.500 mm, dy=1.500 mm
Maximum value of SAR (interpolated) = 0.178 W/kg

- **Zoom Scan (5x5x7)/Cube 0**: Measurement grid: dx=8mm, dy=8mm, dz=5mm
Reference Value = 5.891 V/m; Power Drift = 0.11 dB
Peak SAR (extrapolated) = 0.232 W/kg
SAR(1 g) = 0.150 W/kg; SAR(10 g) = 0.095 W/kg
Maximum value of SAR (measured) = 0.197 W/kg

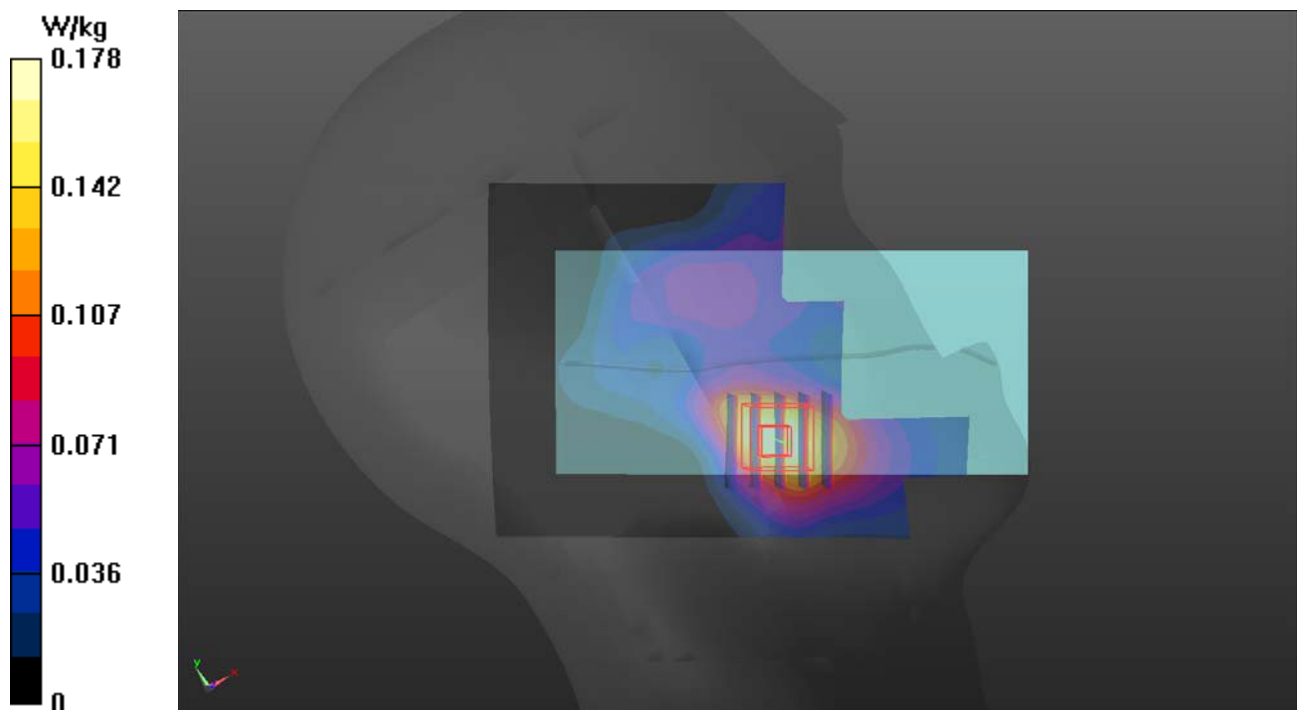

P08 LTE 5_QPSK10M_Right Cheek_Ch20525_1RB_OS0_Ant 0_Sensor OFF

DUT: 190827C07

Communication System: LTE; Frequency: 836.5 MHz; Duty Cycle: 1:1

Medium: H07T10N1_0923 Medium parameters used: $f = 836.5$ MHz; $\sigma = 0.914$ S/m; $\epsilon_r = 42.701$; $\rho = 1000$ kg/m³

Ambient Temperature : 23.7 °C ; Liquid Temperature : 23.4 °C

DASY5 Configuration:

- Probe: EX3DV4 - SN3971; ConvF(10.18, 10.18, 10.18); Calibrated: 2019/03/29
- Sensor-Surface: 1.4mm (Mechanical Surface Detection)
- Electronics: DAE4 Sn1431; Calibrated: 2019/03/25
- Phantom: Twin SAM Phantom_1496; Type: QD000P40CA;
- Measurement SW: DASY52, Version 52.10 (2); SEMCAD X Version 14.6.12 (7470)

- **Area Scan (81x141x1):** Interpolated grid: dx=1.500 mm, dy=1.500 mm

Maximum value of SAR (interpolated) = 0.128 W/kg

- **Zoom Scan (5x5x7)/Cube 0:** Measurement grid: dx=8mm, dy=8mm, dz=5mm

Reference Value = 11.56 V/m; Power Drift = -0.07 dB

Peak SAR (extrapolated) = 0.130 W/kg

SAR(1 g) = 0.102 W/kg; SAR(10 g) = 0.079 W/kg

Maximum value of SAR (measured) = 0.120 W/kg

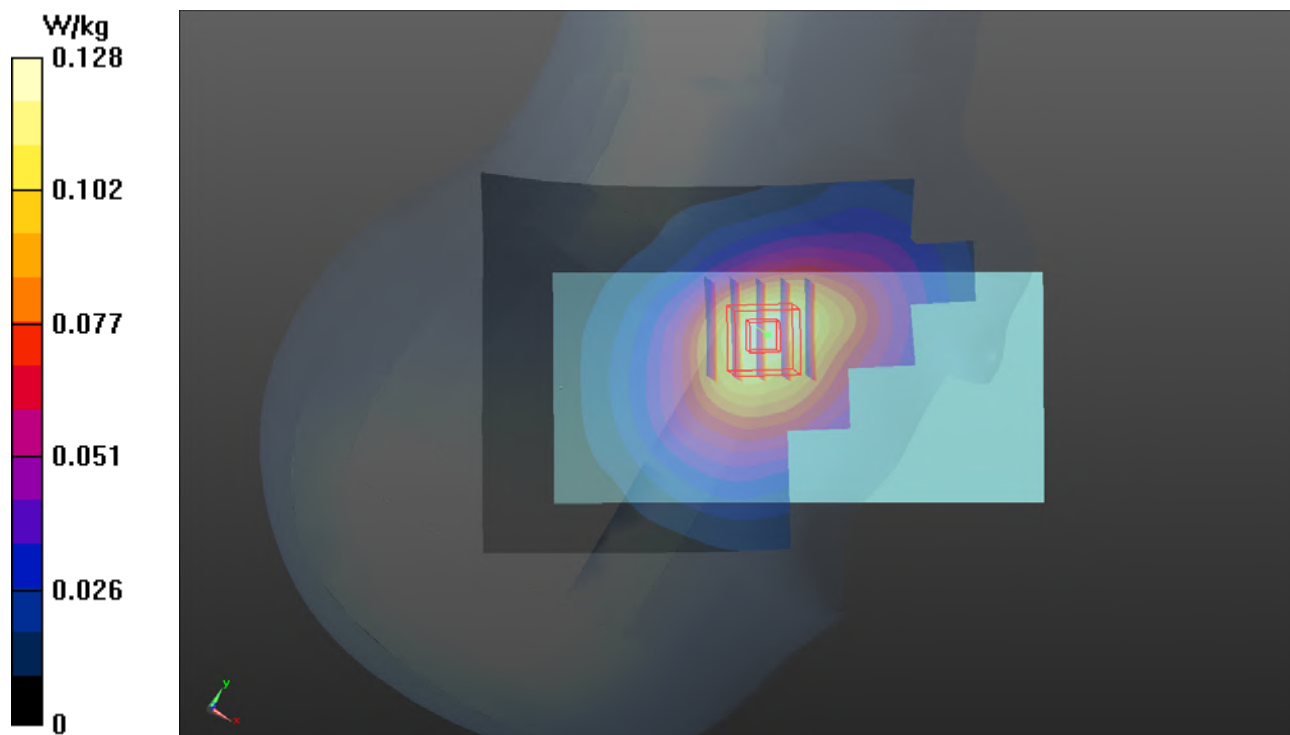

P09 LTE 7_QPSK20M_Left Cheek_Ch20850_1RB_OS0_Ant0_Sensor OFF

DUT: 190827C07

Communication System: LTE; Frequency: 2510 MHz; Duty Cycle: 1:1

Medium: H19T27N1_0907 Medium parameters used: $f = 2510$ MHz; $\sigma = 1.959$ S/m; $\epsilon_r = 38.148$; $\rho = 1000$ kg/m³

Ambient Temperature : 23.8 °C ; Liquid Temperature : 23.3 °C

DASY5 Configuration:

- Probe: EX3DV4 - SN7537; ConvF(7.19, 7.19, 7.19); Calibrated: 2019/06/18
- Sensor-Surface: 1.4mm (Mechanical Surface Detection)
- Electronics: DAE4 Sn1585; Calibrated: 2019/06/07
- Phantom: SAM Phantom_1982; Type: QD 000 P41 Ax; Serial: 1982
- Measurement SW: DASY52, Version 52.10 (2); SEMCAD X Version 14.6.12 (7470)

- **Area Scan (101x171x1)**: Interpolated grid: dx=1.200 mm, dy=1.200 mm
Maximum value of SAR (interpolated) = 0.230 W/kg

- **Zoom Scan (5x5x7)/Cube 0**: Measurement grid: dx=8mm, dy=8mm, dz=5mm
Reference Value = 5.637 V/m; Power Drift = 0.11 dB
Peak SAR (extrapolated) = 0.243 W/kg
SAR(1 g) = 0.136 W/kg; SAR(10 g) = 0.076 W/kg
Maximum value of SAR (measured) = 0.200 W/kg

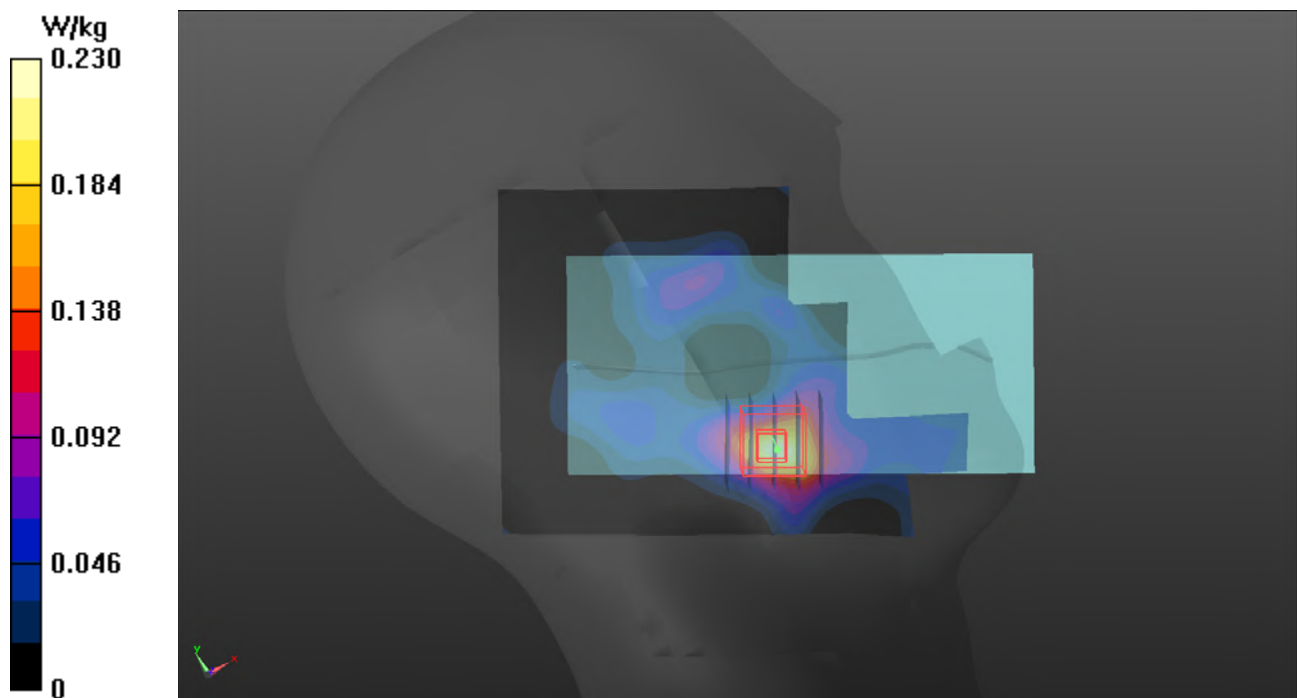

P10 LTE 38_QPSK20M_Left Cheek_Ch37850_1RB_OS0_Ant0_Sensor OFF

DUT: 190827C07

Communication System: LTE TDD CF0; Frequency: 2580 MHz; Duty Cycle: 1:1.58

Medium: H19T27N1_0907 Medium parameters used: $f = 2580$ MHz; $\sigma = 2.031$ S/m; $\epsilon_r = 37.876$; $\rho = 1000$ kg/m³

Ambient Temperature : 23.8 °C ; Liquid Temperature : 23.1 °C

DASY5 Configuration:

- Probe: EX3DV4 - SN7537; ConvF(7.19, 7.19, 7.19); Calibrated: 2019/06/18
- Sensor-Surface: 1.4mm (Mechanical Surface Detection)
- Electronics: DAE4 Sn1585; Calibrated: 2019/06/07
- Phantom: SAM Phantom_1982; Type: QD 000 P41 Ax; Serial: 1982
- Measurement SW: DASY52, Version 52.10 (2); SEMCAD X Version 14.6.12 (7470)

- **Area Scan (101x171x1)**: Interpolated grid: $dx=1.200$ mm, $dy=1.200$ mm
Maximum value of SAR (interpolated) = 0.196 W/kg

- **Zoom Scan (5x5x7)/Cube 0**: Measurement grid: $dx=8$ mm, $dy=8$ mm, $dz=5$ mm
Reference Value = 3.855 V/m; Power Drift = 0.03 dB
Peak SAR (extrapolated) = 0.131 W/kg
SAR(1 g) = 0.073 W/kg; SAR(10 g) = 0.040 W/kg
Maximum value of SAR (measured) = 0.105 W/kg

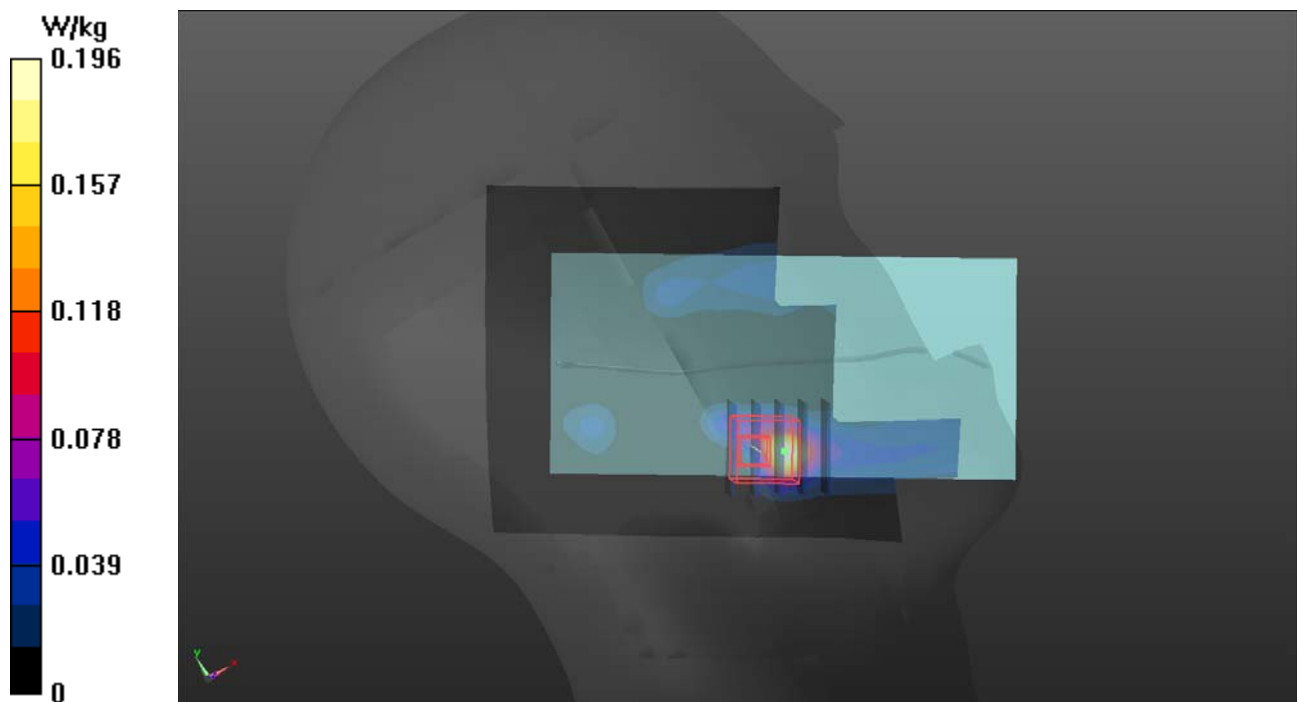

P11 WLAN2.4G_802.11b_Left Cheek_Ch6_Ant0

DUT: 190827C07

Communication System: WLAN_2.4G; Frequency: 2437 MHz; Duty Cycle: 1:1

Medium: H19T27N1_0910 Medium parameters used: $f = 2437$ MHz; $\sigma = 1.863$ S/m; $\epsilon_r = 39.179$; $\rho = 1000$ kg/m³

Ambient Temperature : 23.5 °C ; Liquid Temperature : 23.2 °C

DASY5 Configuration:

- Probe: EX3DV4 - SN7537; ConvF(7.39, 7.39, 7.39); Calibrated: 2019/06/18
- Sensor-Surface: 1.4mm (Mechanical Surface Detection)
- Electronics: DAE4 Sn1585; Calibrated: 2019/06/07
- Phantom: SAM Phantom_1982; Type: QD 000 P41 Ax; Serial: 1982
- Measurement SW: DASY52, Version 52.10 (2); SEMCAD X Version 14.6.12 (7470)

- **Area Scan (101x171x1)**: Interpolated grid: dx=1.200 mm, dy=1.200 mm
Maximum value of SAR (interpolated) = 1.34 W/kg

- **Zoom Scan (5x5x7)/Cube 0**: Measurement grid: dx=8mm, dy=8mm, dz=5mm
Reference Value = 21.99 V/m; Power Drift = -0.10 dB
Peak SAR (extrapolated) = 1.24 W/kg
SAR(1 g) = 0.555 W/kg; SAR(10 g) = 0.289 W/kg
Maximum value of SAR (measured) = 0.879 W/kg

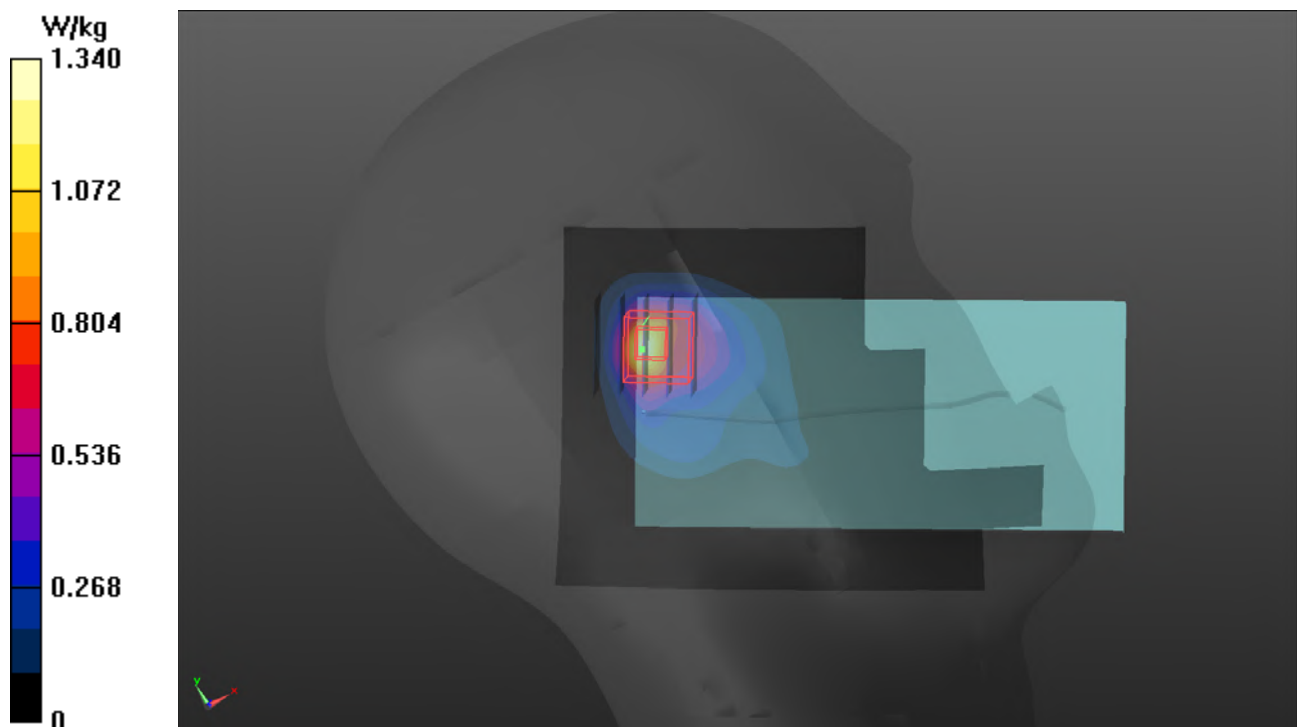

P12 WLAN5.3G_802.11a_Left Cheek_Ch60_Ant0

DUT: 190827C07

Communication System: WLAN_5G; Frequency: 5300 MHz; Duty Cycle: 1:1.02

Medium: H34T60N1_0910 Medium parameters used: $f = 5300$ MHz; $\sigma = 4.896$ S/m; $\epsilon_r = 35.546$; $\rho = 1000$ kg/m³

Ambient Temperature : 23.5 °C ; Liquid Temperature : 23.2 °C

DASY5 Configuration:

- Probe: EX3DV4 - SN7537; ConvF(5.36, 5.36, 5.36); Calibrated: 2019/06/18

- Sensor-Surface: 1.4mm (Mechanical Surface Detection)

- Electronics: DAE4 Sn1585; Calibrated: 2019/06/07

- Phantom: SAM Phantom_1982; Type: QD 000 P41 Ax; Serial: 1982

- Measurement SW: DASY52, Version 52.10 (2); SEMCAD X Version 14.6.12 (7470)

- **Area Scan (121x201x1):** Interpolated grid: dx=1.000 mm, dy=1.000 mm

Maximum value of SAR (interpolated) = 1.39 W/kg

- **Zoom Scan (6x6x12)/Cube 0:** Measurement grid: dx=5mm, dy=5mm, dz=2mm

Reference Value = 15.88 V/m; Power Drift = -0.05 dB

Peak SAR (extrapolated) = 3.62 W/kg

SAR(1 g) = 0.801 W/kg; SAR(10 g) = 0.223 W/kg

Maximum value of SAR (measured) = 2.14 W/kg

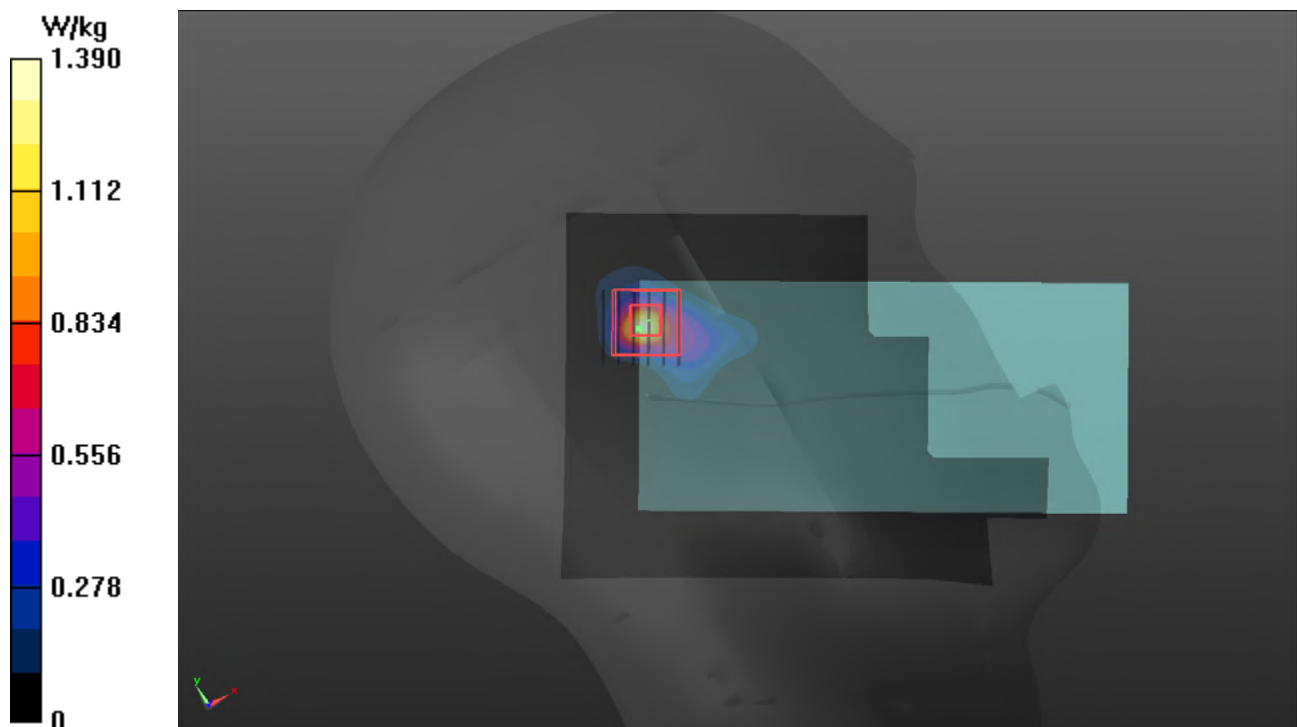

P13 WLAN5.6G_802.11a_Left Cheek_Ch116_Ant0

DUT: 190827C07

Communication System: WLAN_5G; Frequency: 5580 MHz; Duty Cycle: 1:1.02

Medium: H34T60N1_0911 Medium parameters used: $f = 5580$ MHz; $\sigma = 5.156$ S/m; $\epsilon_r = 35.884$; $\rho = 1000$ kg/m³

Ambient Temperature : 23.5 °C ; Liquid Temperature : 23.2 °C

DASY5 Configuration:

- Probe: EX3DV4 - SN7537; ConvF(4.75, 4.75, 4.75); Calibrated: 2019/06/18
- Sensor-Surface: 1.4mm (Mechanical Surface Detection)
- Electronics: DAE4 Sn1585; Calibrated: 2019/06/07
- Phantom: SAM Phantom_1982; Type: QD 000 P41 Ax; Serial: 1982
- Measurement SW: DASY52, Version 52.10 (2); SEMCAD X Version 14.6.12 (7470)

- **Area Scan (121x201x1):** Interpolated grid: dx=1.000 mm, dy=1.000 mm
Maximum value of SAR (interpolated) = 1.05 W/kg

- **Zoom Scan (6x6x12)/Cube 0:** Measurement grid: dx=5mm, dy=5mm, dz=2mm
Reference Value = 14.41 V/m; Power Drift = -0.05 dB
Peak SAR (extrapolated) = 3.14 W/kg
SAR(1 g) = 0.635 W/kg; SAR(10 g) = 0.173 W/kg
Maximum value of SAR (measured) = 1.73 W/kg

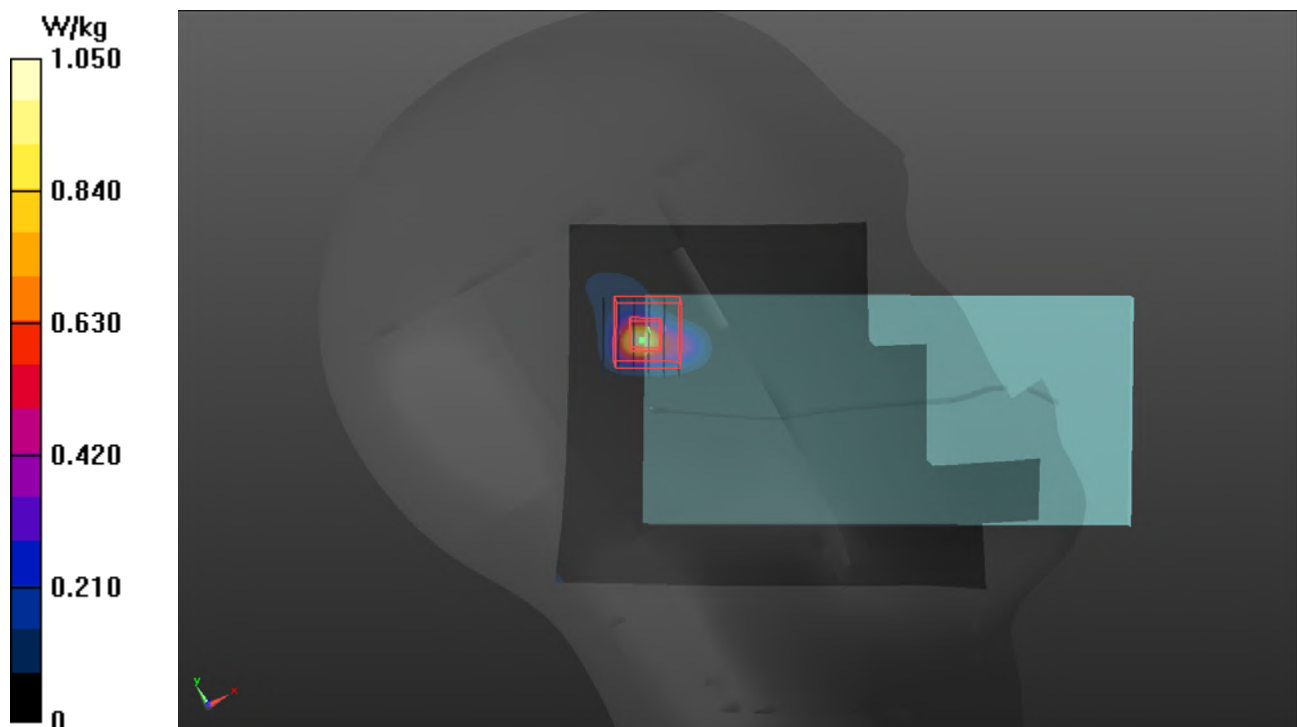

P14 WLAN5.8G_802.11a_Left Cheek_Ch149_Ant0

DUT: 190827C07

Communication System: WLAN_5G; Frequency: 5745 MHz; Duty Cycle: 1:1.02

Medium: H34T60N1_0911 Medium parameters used: $f = 5745$ MHz; $\sigma = 5.372$ S/m; $\epsilon_r = 35.901$; $\rho = 1000$ kg/m³

Ambient Temperature : 23.5 °C ; Liquid Temperature : 23.2 °C

DASY5 Configuration:

- Probe: EX3DV4 - SN7537; ConvF(4.99, 4.99, 4.99); Calibrated: 2019/06/18
- Sensor-Surface: 1.4mm (Mechanical Surface Detection)
- Electronics: DAE4 Sn1585; Calibrated: 2019/06/07
- Phantom: SAM Phantom_1982; Type: QD 000 P41 Ax; Serial: 1982
- Measurement SW: DASY52, Version 52.10 (2); SEMCAD X Version 14.6.12 (7470)

- **Area Scan (121x201x1)**: Interpolated grid: dx=1.000 mm, dy=1.000 mm
Maximum value of SAR (interpolated) = 1.19 W/kg

- **Zoom Scan (6x6x12)/Cube 0**: Measurement grid: dx=5mm, dy=5mm, dz=2mm
Reference Value = 14.71 V/m; Power Drift = -0.05 dB
Peak SAR (extrapolated) = 2.95 W/kg
SAR(1 g) = 0.590 W/kg; SAR(10 g) = 0.163 W/kg
Maximum value of SAR (measured) = 1.57 W/kg

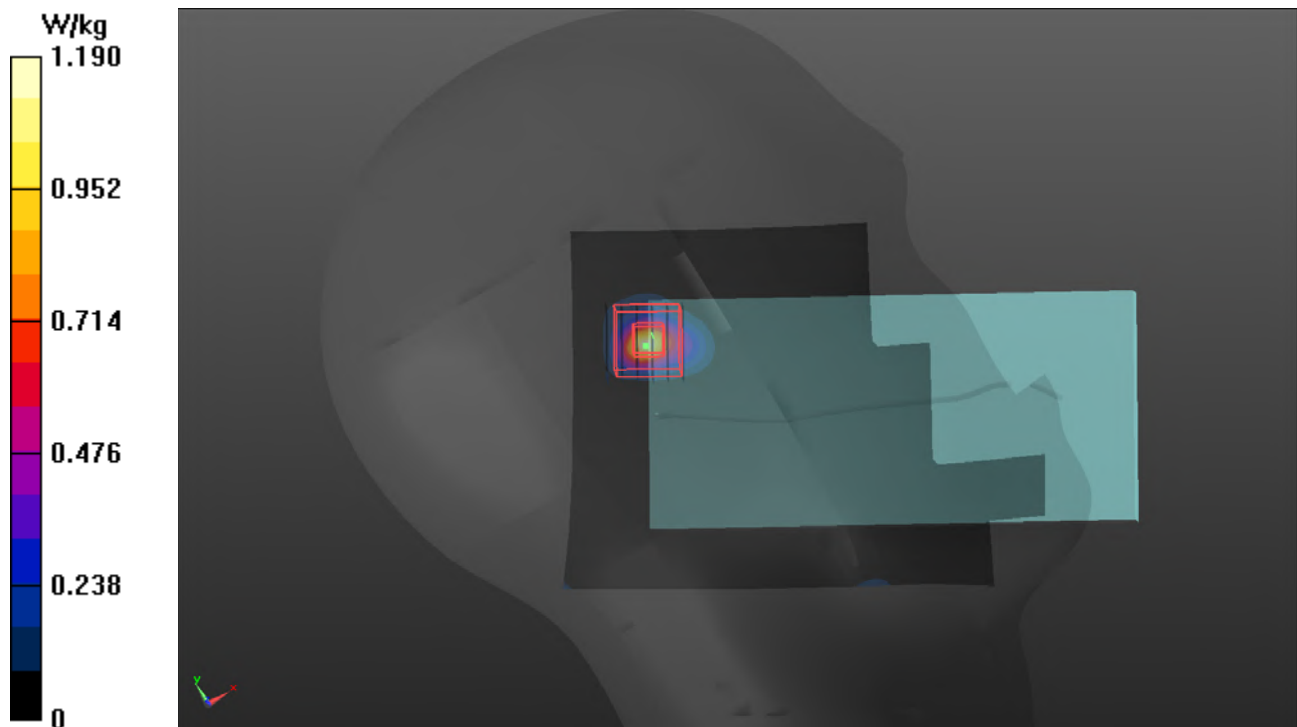

P15 BT_BDR_Left Cheek_Ch39_Ant0

DUT: 190827C07

Communication System: BT; Frequency: 2441 MHz; Duty Cycle: 1:1.3

Medium: H19T27N1_0910 Medium parameters used: $f = 2441$ MHz; $\sigma = 1.868$ S/m; $\epsilon_r = 39.162$; $\rho = 1000$ kg/m³

Ambient Temperature : 23.5 °C ; Liquid Temperature : 23.2 °C

DASY5 Configuration:

- Probe: EX3DV4 - SN7537; ConvF(7.39, 7.39, 7.39); Calibrated: 2019/06/18
- Sensor-Surface: 1.4mm (Mechanical Surface Detection)
- Electronics: DAE4 Sn1585; Calibrated: 2019/06/07
- Phantom: SAM Phantom_1982; Type: QD 000 P41 Ax; Serial: 1982
- Measurement SW: DASY52, Version 52.10 (2); SEMCAD X Version 14.6.12 (7470)

- **Area Scan (101x171x1)**: Interpolated grid: dx=1.200 mm, dy=1.200 mm
Maximum value of SAR (interpolated) = 0.171 W/kg

- **Zoom Scan (5x5x7)/Cube 0**: Measurement grid: dx=8mm, dy=8mm, dz=5mm
Reference Value = 6.870 V/m; Power Drift = -0.10 dB
Peak SAR (extrapolated) = 0.126 W/kg
SAR(1 g) = 0.064 W/kg; SAR(10 g) = 0.032 W/kg
Maximum value of SAR (measured) = 0.0997 W/kg

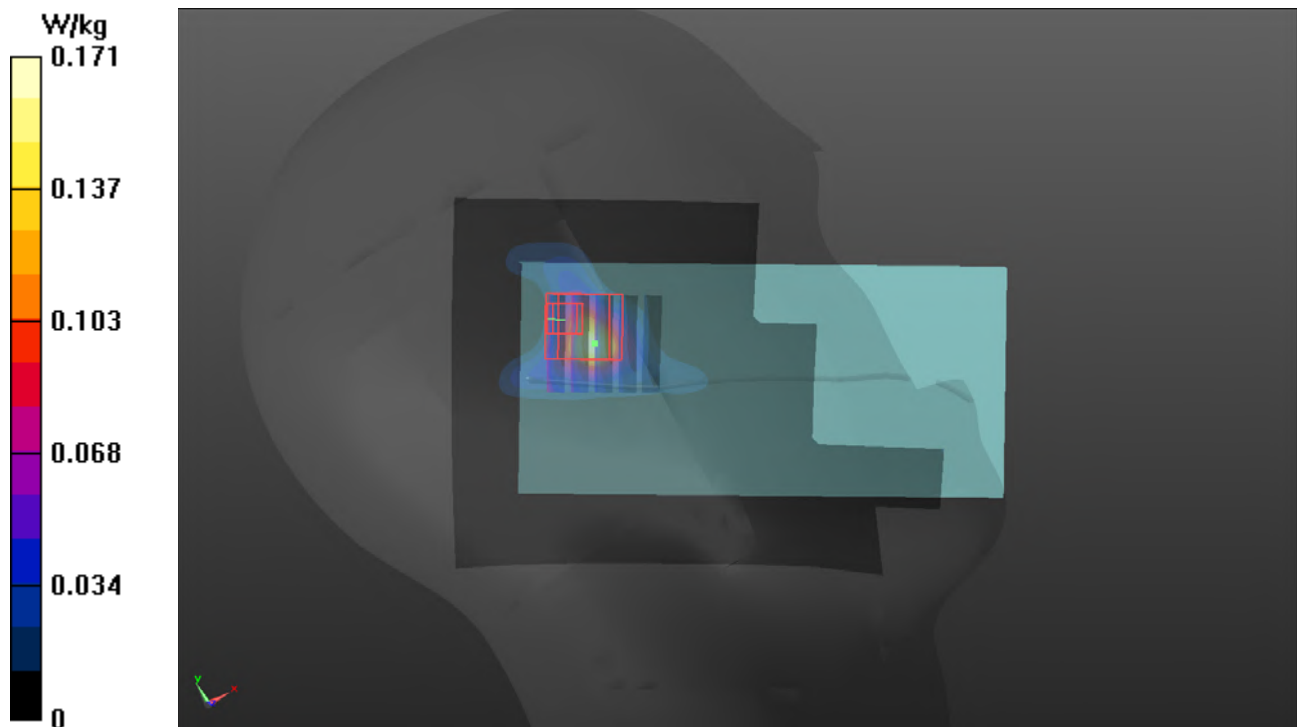

P16 GSM850_GPRS12_Rear Face_10mm_Ch251_Ant0_Sensor OFF

DUT: 190827C07

Communication System: GPRS12; Frequency: 848.8 MHz; Duty Cycle: 1:2

Medium: H07T10N4_0910 Medium parameters used: $f = 849 \text{ MHz}$; $\sigma = 0.934 \text{ S/m}$; $\epsilon_r = 40.983$; $\rho = 1000 \text{ kg/m}^3$

Ambient Temperature : $23.7 \text{ }^\circ\text{C}$; Liquid Temperature : $23.3 \text{ }^\circ\text{C}$

DASY5 Configuration:

- Probe: EX3DV4 - SN7375; ConvF(10.13, 10.13, 10.13); Calibrated: 2018/12/13
- Sensor-Surface: 1.4mm (Mechanical Surface Detection)
- Electronics: DAE4 Sn1277; Calibrated: 2019/01/24
- Phantom: Twin SAM Phantom_1823; Type: QD000P40CD;
- Measurement SW: DASY52, Version 52.10 (2); SEMCAD X Version 14.6.12 (7470)

- **Area Scan (81x141x1):** Interpolated grid: $dx=1.500 \text{ mm}$, $dy=1.500 \text{ mm}$

Maximum value of SAR (interpolated) = 0.406 W/kg

- **Zoom Scan (5x5x7)/Cube 0:** Measurement grid: $dx=8\text{mm}$, $dy=8\text{mm}$, $dz=5\text{mm}$

Reference Value = 20.97 V/m ; Power Drift = -0.01 dB

Peak SAR (extrapolated) = 0.457 W/kg

SAR(1 g) = 0.253 W/kg ; SAR(10 g) = 0.145 W/kg

Maximum value of SAR (measured) = 0.371 W/kg

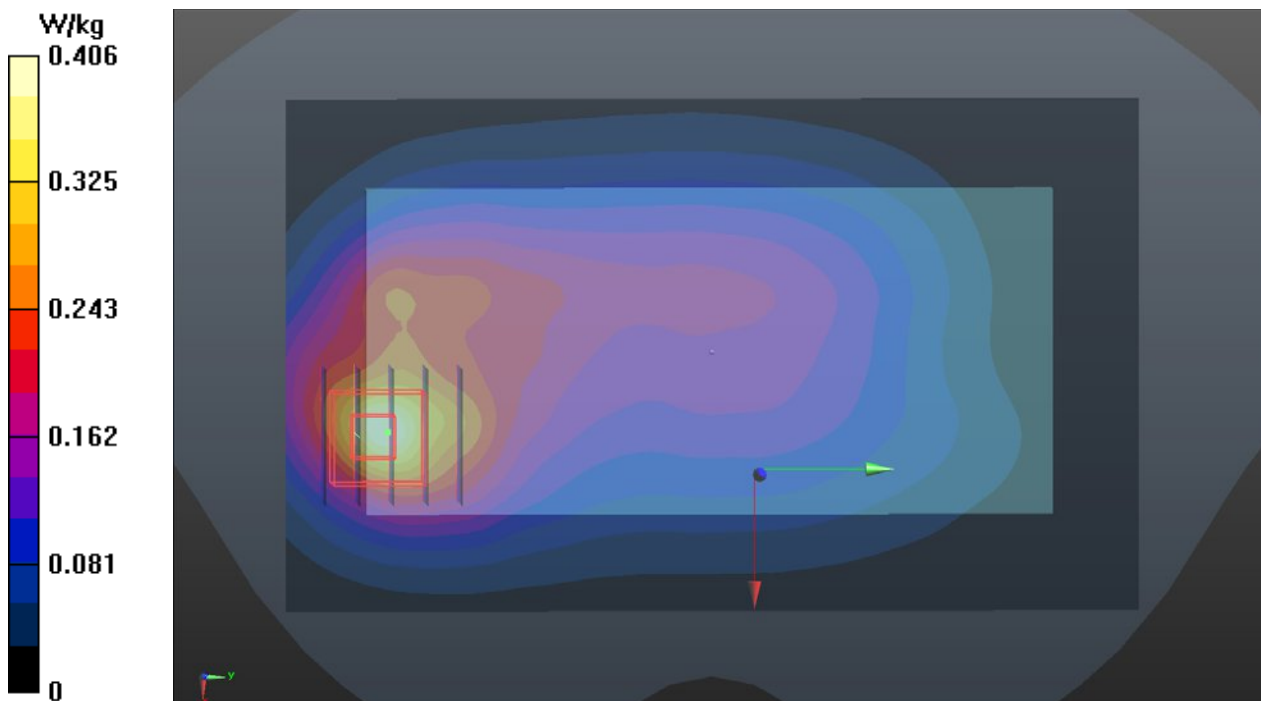

P17 GSM1900_GPRS8_Rear Face_10mm_Ch512_Ant0_Sensor ON

DUT: 190827C07

Communication System: GPRS8; Frequency: 1850.2 MHz; Duty Cycle: 1:8.3
Medium: H16T20N4_0909 Medium parameters used: $f = 1850.2$ MHz; $\sigma = 1.413$ S/m; $\epsilon_r = 39.876$;
 $\rho = 1000$ kg/m³
Ambient Temperature : 23.6 °C ; Liquid Temperature : 23.3 °C

DASY5 Configuration:

- Probe: EX3DV4 - SN7375; ConvF(8.26, 8.26, 8.26); Calibrated: 2018/12/13
- Sensor-Surface: 1.4mm (Mechanical Surface Detection)
- Electronics: DAE4 Sn1277; Calibrated: 2019/01/24
- Phantom: Twin SAM Phantom_1823; Type: QD000P40CD;
- Measurement SW: DASY52, Version 52.10 (2); SEMCAD X Version 14.6.12 (7470)

- **Area Scan (81x141x1):** Interpolated grid: dx=1.500 mm, dy=1.500 mm
Maximum value of SAR (interpolated) = 1.50 W/kg

- **Zoom Scan (5x5x7)/Cube 0:** Measurement grid: dx=8mm, dy=8mm, dz=5mm
Reference Value = 33.57 V/m; Power Drift = 0.01 dB
Peak SAR (extrapolated) = 1.79 W/kg
SAR(1 g) = 1.04 W/kg; SAR(10 g) = 0.562 W/kg
Maximum value of SAR (measured) = 1.50 W/kg

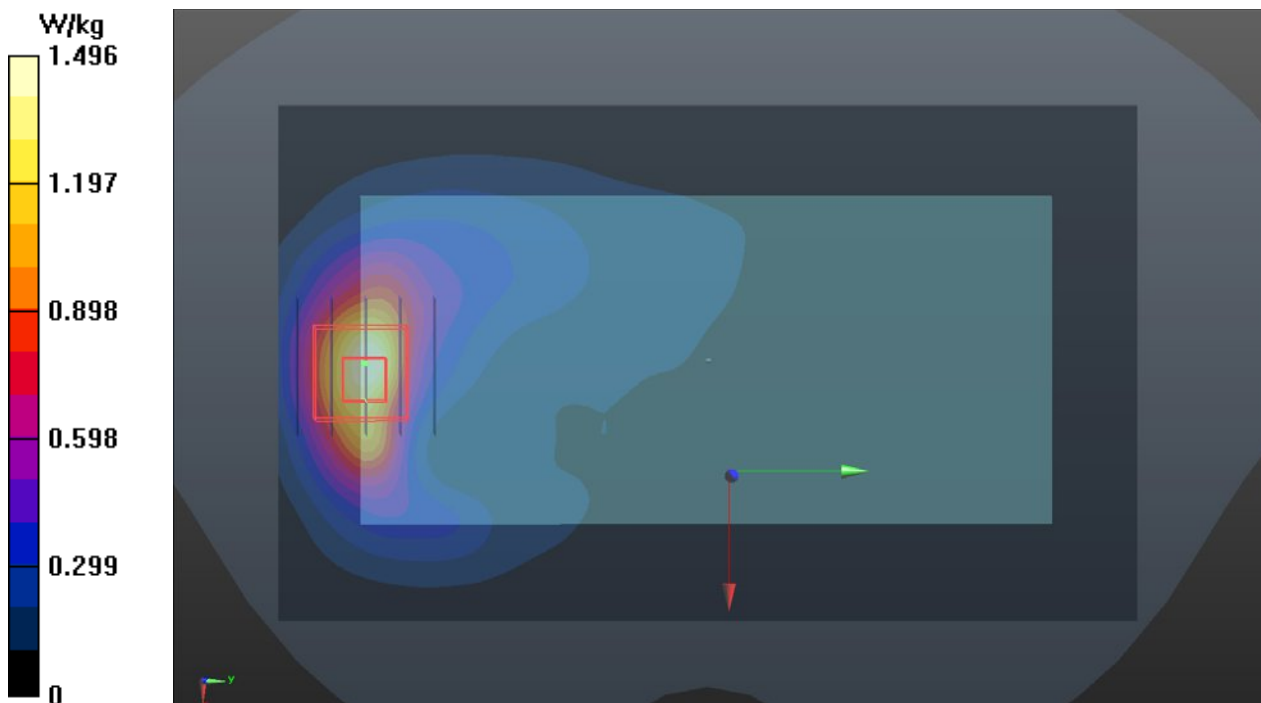

P18 WCDMA II_RMC12.2K_Rear Face_10mm_Ch9400_Ant0_Sensor ON

DUT: 190827C07

Communication System: WCDMA; Frequency: 1880 MHz; Duty Cycle: 1:1

Medium: H16T20N1_0913 Medium parameters used: $f = 1880$ MHz; $\sigma = 1.425$ S/m; $\epsilon_r = 38.929$; $\rho = 1000$ kg/m³

Ambient Temperature : 23.6 °C ; Liquid Temperature : 23.3 °C

DASY5 Configuration:

- Probe: EX3DV4 - SN7537; ConvF(8.13, 8.13, 8.13); Calibrated: 2019/06/18
- Sensor-Surface: 1.4mm (Mechanical Surface Detection)
- Electronics: DAE4 Sn1585; Calibrated: 2019/06/07
- Phantom: SAM Phantom_1982; Type: QD 000 P41 Ax; Serial: 1982
- Measurement SW: DASY52, Version 52.10 (2); SEMCAD X Version 14.6.12 (7470)

- **Area Scan (81x141x1)**: Interpolated grid: $dx=1.500$ mm, $dy=1.500$ mm
Maximum value of SAR (interpolated) = 1.04 W/kg

- **Zoom Scan (5x5x7)/Cube 0**: Measurement grid: $dx=8$ mm, $dy=8$ mm, $dz=5$ mm
Reference Value = 27.79 V/m; Power Drift = -0.04 dB
Peak SAR (extrapolated) = 1.25 W/kg
SAR(1 g) = 0.707 W/kg; SAR(10 g) = 0.385 W/kg
Maximum value of SAR (measured) = 1.03 W/kg

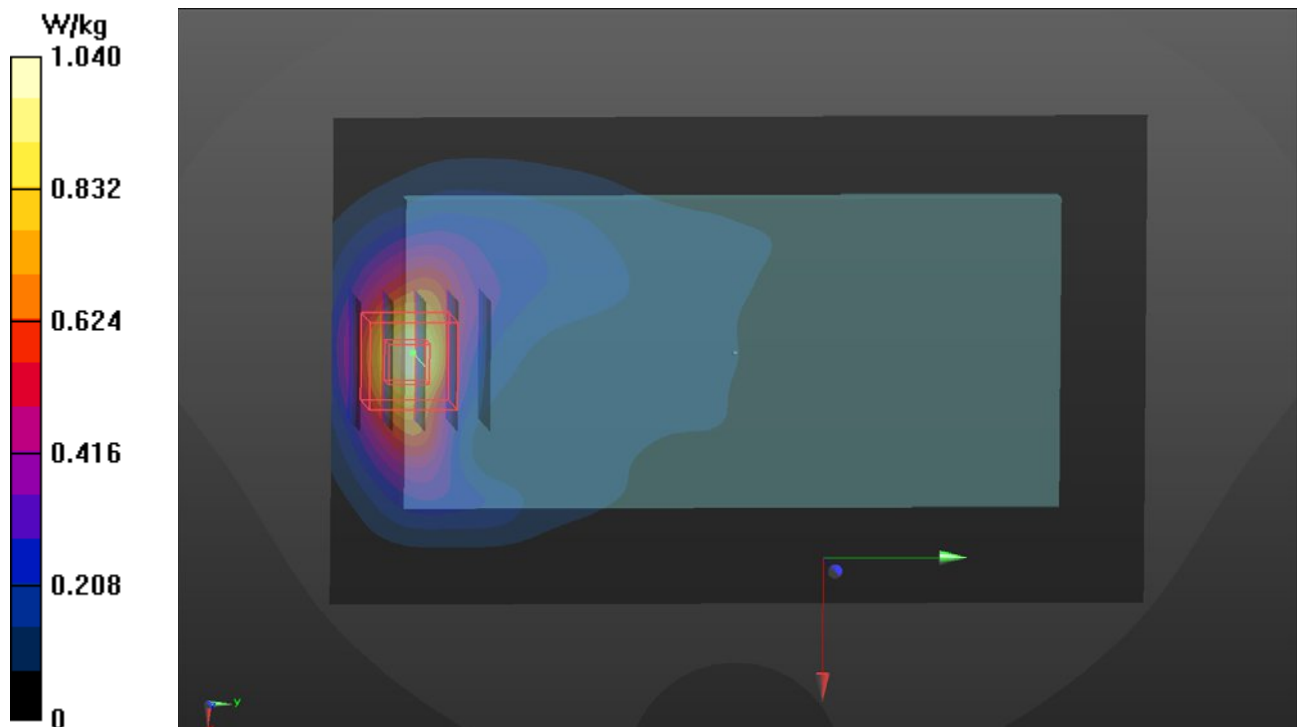

P19 WCDMA IV_RMC12.2K_Rear Face_10mm_Ch1513_Ant0_Sensor ON

DUT: 190827C07

Communication System: WCDMA; Frequency: 1752.6 MHz; Duty Cycle: 1:1

Medium: H16T20N1_0910 Medium parameters used: $f = 1753$ MHz; $\sigma = 1.328$ S/m; $\epsilon_r = 40.413$; $\rho = 1000$ kg/m³

Ambient Temperature : 23.6 °C ; Liquid Temperature : 23.1 °C

DASY5 Configuration:

- Probe: EX3DV4 - SN3971; ConvF(8.8, 8.8, 8.8); Calibrated: 2019/03/29
- Sensor-Surface: 1.4mm (Mechanical Surface Detection)
- Electronics: DAE4 Sn1431; Calibrated: 2019/03/25
- Phantom: Twin SAM Phantom_1496; Type: QD000P40CB;
- Measurement SW: DASY52, Version 52.10 (2); SEMCAD X Version 14.6.12 (7470)

- **Area Scan (81x141x1):** Interpolated grid: dx=1.500 mm, dy=1.500 mm

Maximum value of SAR (interpolated) = 1.26 W/kg

- **Zoom Scan (5x5x7)/Cube 0:** Measurement grid: dx=8mm, dy=8mm, dz=5mm

Reference Value = 31.92 V/m; Power Drift = -0.09 dB

Peak SAR (extrapolated) = 1.47 W/kg

SAR(1 g) = 0.909 W/kg; SAR(10 g) = 0.525 W/kg

Maximum value of SAR (measured) = 1.26 W/kg

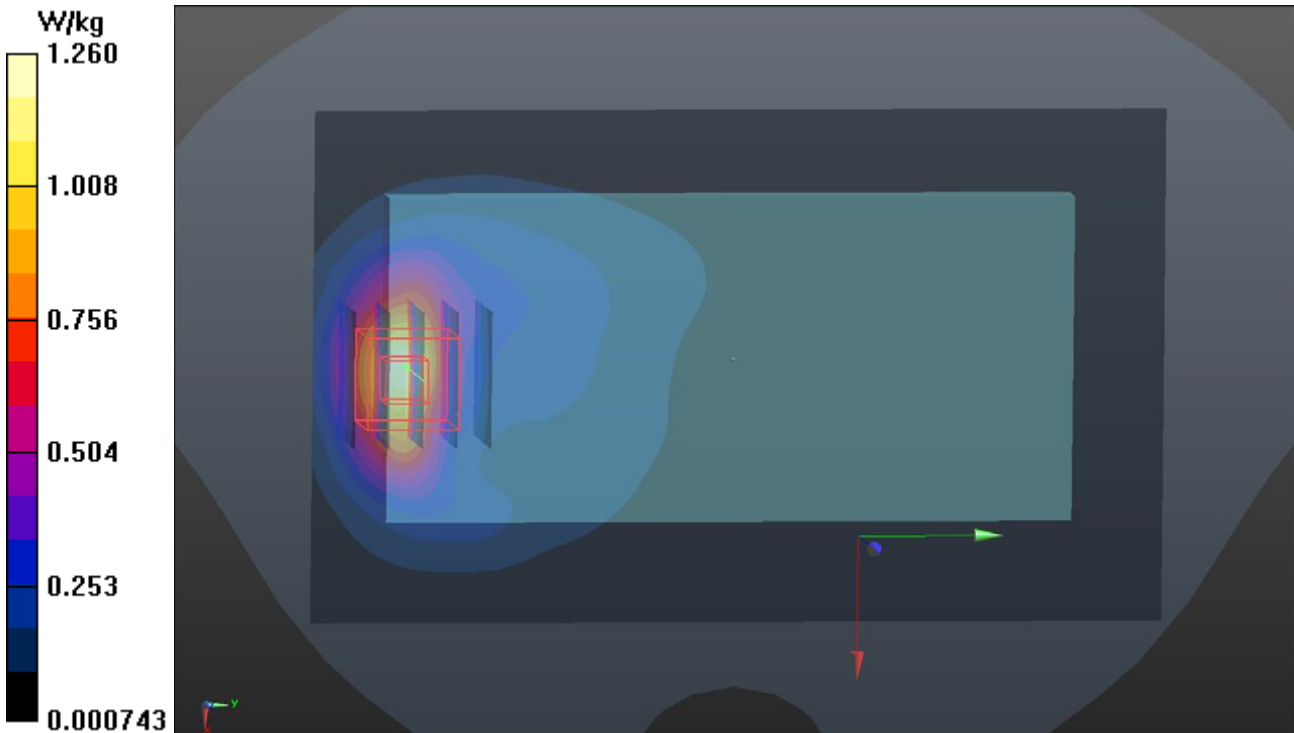

P20 WCDMA V_RMC12.2K_Rear Face_10mm_Ch4233_Ant 0_Sensor OFF

DUT: 190827C07

Communication System: WCDMA; Frequency: 846.6 MHz; Duty Cycle: 1:1

Medium: H07T10N1_0923 Medium parameters used: $f = 847$ MHz; $\sigma = 0.924$ S/m; $\epsilon_r = 42.579$; $\rho = 1000$ kg/m³

Ambient Temperature : 23.7 °C ; Liquid Temperature : 23.4 °C

DASY5 Configuration:

- Probe: EX3DV4 - SN3971; ConvF(10.18, 10.18, 10.18); Calibrated: 2019/03/29
- Sensor-Surface: 1.4mm (Mechanical Surface Detection)
- Electronics: DAE4 Sn1431; Calibrated: 2019/03/25
- Phantom: Twin SAM Phantom_1496; Type: QD000P40CA;
- Measurement SW: DASY52, Version 52.10 (2); SEMCAD X Version 14.6.12 (7470)

- **Area Scan (81x141x1):** Interpolated grid: dx=1.500 mm, dy=1.500 mm

Maximum value of SAR (interpolated) = 0.391 W/kg

- **Zoom Scan (5x5x7)/Cube 0:** Measurement grid: dx=8mm, dy=8mm, dz=5mm

Reference Value = 19.44 V/m; Power Drift = 0.16 dB

Peak SAR (extrapolated) = 0.458 W/kg

SAR(1 g) = 0.248 W/kg; SAR(10 g) = 0.144 W/kg

Maximum value of SAR (measured) = 0.376 W/kg

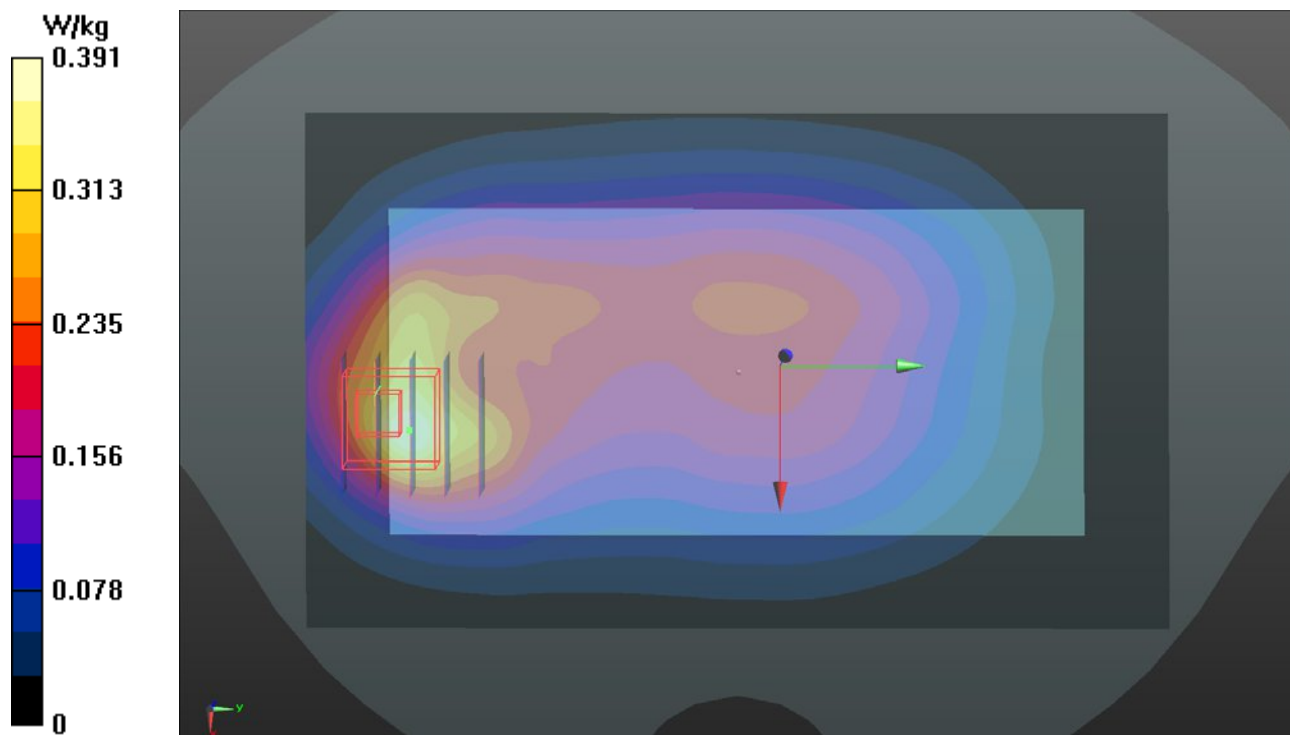

P21 LTE 2_QPSK20M_Rear Face_10mm_Ch18900_1RB_OS0_Ant0_Sensor ON

DUT: 190827C07

Communication System: LTE; Frequency: 1880 MHz; Duty Cycle: 1:1

Medium: H16T20N1_0910 Medium parameters used: $f = 1880$ MHz; $\sigma = 1.443$ S/m; $\epsilon_r = 39.938$; $\rho = 1000$ kg/m³

Ambient Temperature : 23.6 °C ; Liquid Temperature : 23.1 °C

DASY5 Configuration:

- Probe: EX3DV4 - SN3971; ConvF(8.47, 8.47, 8.47); Calibrated: 2019/03/29
- Sensor-Surface: 1.4mm (Mechanical Surface Detection)
- Electronics: DAE4 Sn1431; Calibrated: 2019/03/25
- Phantom: Twin SAM Phantom_1496; Type: QD000P40CB;
- Measurement SW: DASY52, Version 52.10 (2); SEMCAD X Version 14.6.12 (7470)

- **Area Scan (81x141x1):** Interpolated grid: dx=1.500 mm, dy=1.500 mm

Maximum value of SAR (interpolated) = 1.18 W/kg

- **Zoom Scan (5x5x7)/Cube 0:** Measurement grid: dx=8mm, dy=8mm, dz=5mm

Reference Value = 28.96 V/m; Power Drift = -0.08 dB

Peak SAR (extrapolated) = 1.39 W/kg

SAR(1 g) = 0.847 W/kg; SAR(10 g) = 0.488 W/kg

Maximum value of SAR (measured) = 1.18 W/kg

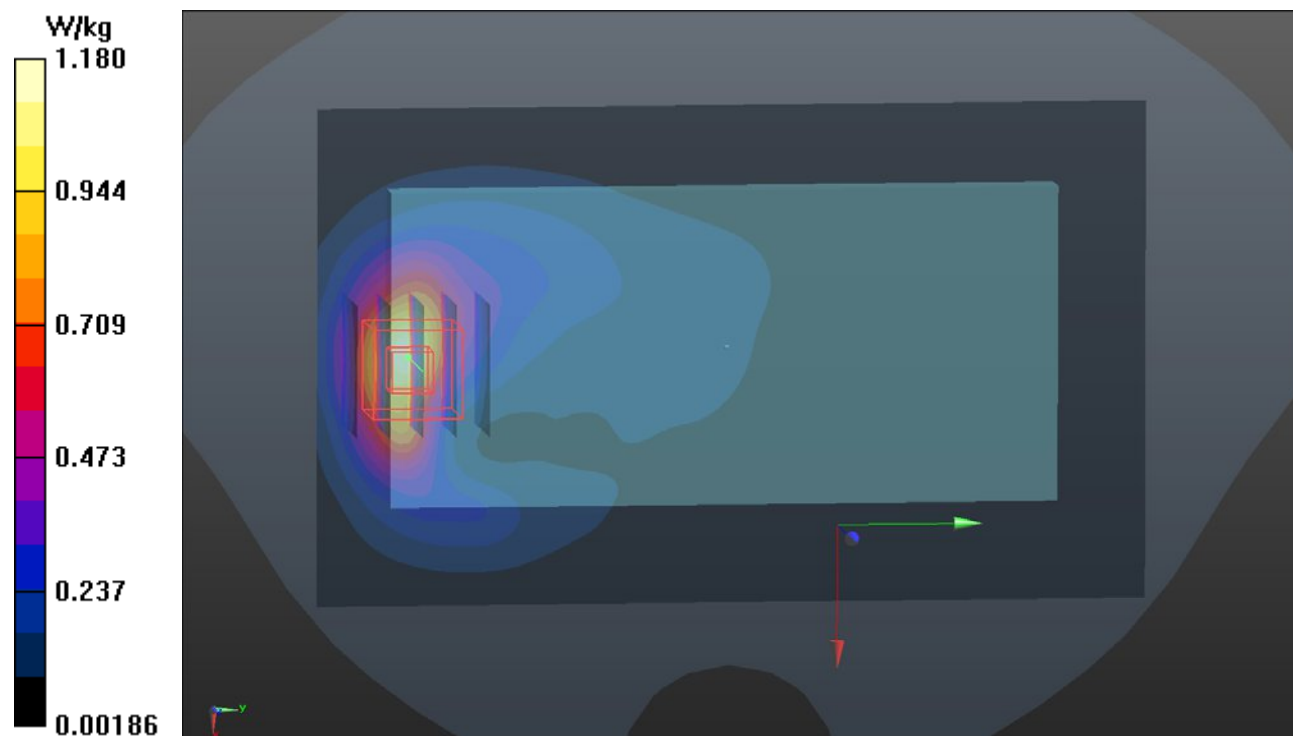

P22 LTE 4_QPSK20M_Rear Face_10mm_Ch20300_1RB_OS0_Ant0_Sensor ON

DUT: 190827C07

Communication System: LTE; Frequency: 1745 MHz; Duty Cycle: 1:1

Medium: H16T20N1_0910 Medium parameters used: $f = 1745$ MHz; $\sigma = 1.32$ S/m; $\epsilon_r = 40.442$; $\rho = 1000$ kg/m³

Ambient Temperature : 23.6 °C ; Liquid Temperature : 23.1 °C

DASY5 Configuration:

- Probe: EX3DV4 - SN3971; ConvF(8.8, 8.8, 8.8); Calibrated: 2019/03/29
- Sensor-Surface: 1.4mm (Mechanical Surface Detection)
- Electronics: DAE4 Sn1431; Calibrated: 2019/03/25
- Phantom: Twin SAM Phantom_1496; Type: QD000P40CB;
- Measurement SW: DASY52, Version 52.10 (2); SEMCAD X Version 14.6.12 (7470)

- **Area Scan (81x141x1):** Interpolated grid: dx=1.500 mm, dy=1.500 mm

Maximum value of SAR (interpolated) = 1.08 W/kg

- **Zoom Scan (5x5x7)/Cube 0:** Measurement grid: dx=8mm, dy=8mm, dz=5mm

Reference Value = 29.02 V/m; Power Drift = -0.13 dB

Peak SAR (extrapolated) = 1.23 W/kg

SAR(1 g) = 0.766 W/kg; SAR(10 g) = 0.445 W/kg

Maximum value of SAR (measured) = 1.05 W/kg

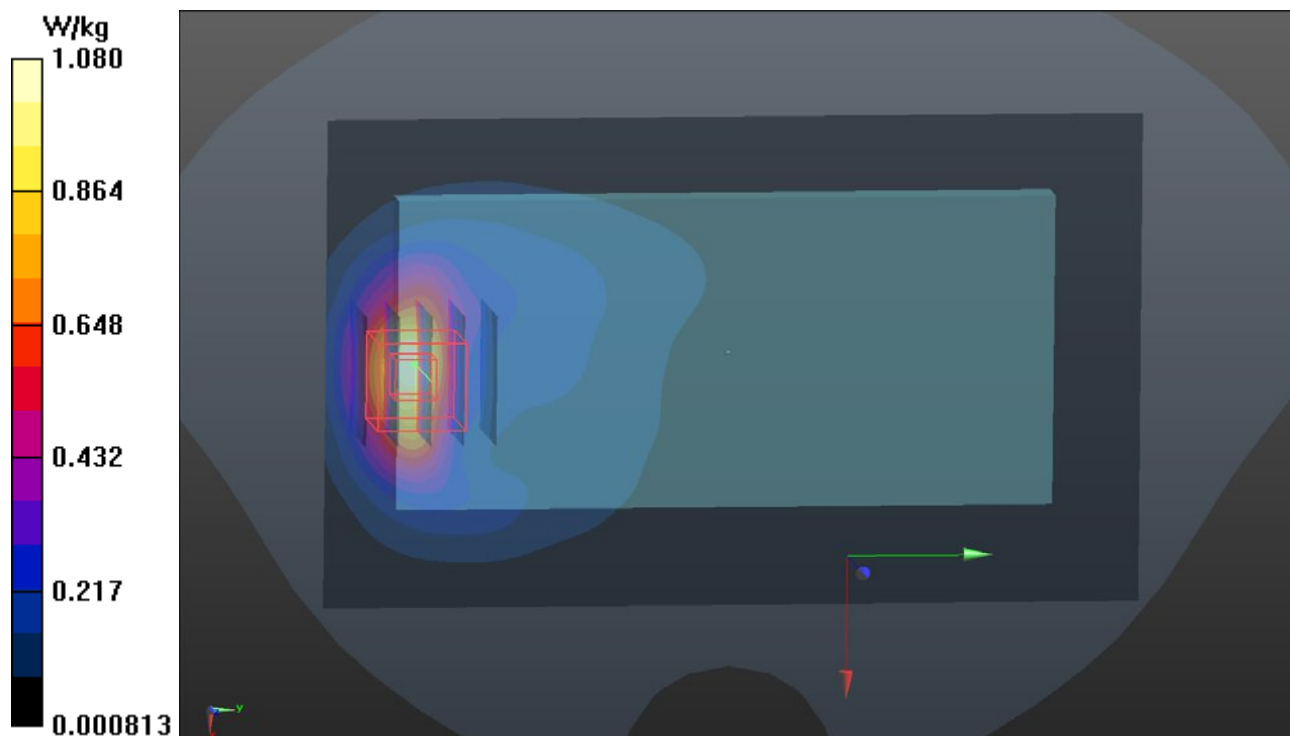

P23 LTE 5_QPSK10M_Rear Face_10mm_Ch20525_1RB_OS0_Ant 0_Sensor OFF

DUT: 190827C07

Communication System: LTE; Frequency: 836.5 MHz; Duty Cycle: 1:1

Medium: H07T10N1_0923 Medium parameters used: $f = 836.5$ MHz; $\sigma = 0.914$ S/m; $\epsilon_r = 42.701$; $\rho = 1000$ kg/m³

Ambient Temperature : 23.7 °C ; Liquid Temperature : 23.4 °C

DASY5 Configuration:

- Probe: EX3DV4 - SN3971; ConvF(10.18, 10.18, 10.18); Calibrated: 2019/03/29

- Sensor-Surface: 1.4mm (Mechanical Surface Detection)

- Electronics: DAE4 Sn1431; Calibrated: 2019/03/25

- Phantom: Twin SAM Phantom_1496; Type: QD000P40CA;

- Measurement SW: DASY52, Version 52.10 (2); SEMCAD X Version 14.6.12 (7470)

- **Area Scan (81x141x1):** Interpolated grid: dx=1.500 mm, dy=1.500 mm

Maximum value of SAR (interpolated) = 0.300 W/kg

- **Zoom Scan (5x5x7)/Cube 0:** Measurement grid: dx=8mm, dy=8mm, dz=5mm

Reference Value = 17.16 V/m; Power Drift = 0.14 dB

Peak SAR (extrapolated) = 0.350 W/kg

SAR(1 g) = 0.189 W/kg; SAR(10 g) = 0.111 W/kg

Maximum value of SAR (measured) = 0.284 W/kg

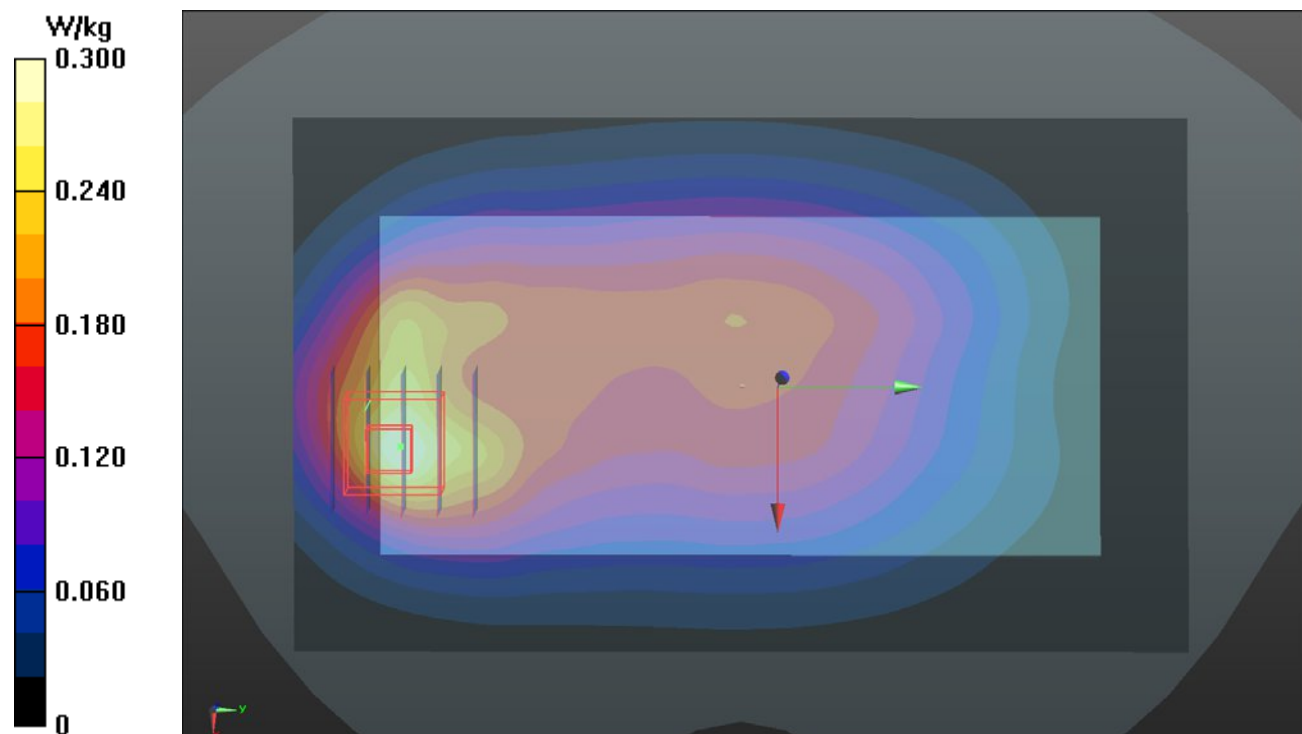

P24 LTE 7_QPSK20M_Rear Face_10mm_Ch21100_1RB_OS0_Ant0_Sensor ON

DUT: 190827C07

Communication System: LTE; Frequency: 2535 MHz; Duty Cycle: 1:1

Medium: H19T27N1_0914 Medium parameters used: $f = 2535$ MHz; $\sigma = 1.914$ S/m; $\epsilon_r = 38.292$; $\rho = 1000$ kg/m³

Ambient Temperature : 23.6 °C ; Liquid Temperature : 23.3 °C

DASY5 Configuration:

- Probe: EX3DV4 - SN7537; ConvF(7.19, 7.19, 7.19); Calibrated: 2019/06/18
- Sensor-Surface: 1.4mm (Mechanical Surface Detection)
- Electronics: DAE4 Sn1585; Calibrated: 2019/06/07
- Phantom: SAM Phantom_1982; Type: QD 000 P41 Ax; Serial: 1982
- Measurement SW: DASY52, Version 52.10 (2); SEMCAD X Version 14.6.12 (7470)

- **Area Scan (101x171x1)**: Interpolated grid: dx=1.200 mm, dy=1.200 mm

Maximum value of SAR (interpolated) = 0.843 W/kg

- **Zoom Scan (5x5x7)/Cube 0**: Measurement grid: dx=8mm, dy=8mm, dz=5mm

Reference Value = 18.95 V/m; Power Drift = -0.06 dB

Peak SAR (extrapolated) = 1.18 W/kg

SAR(1 g) = 0.609 W/kg; SAR(10 g) = 0.324 W/kg

Maximum value of SAR (measured) = 0.954 W/kg

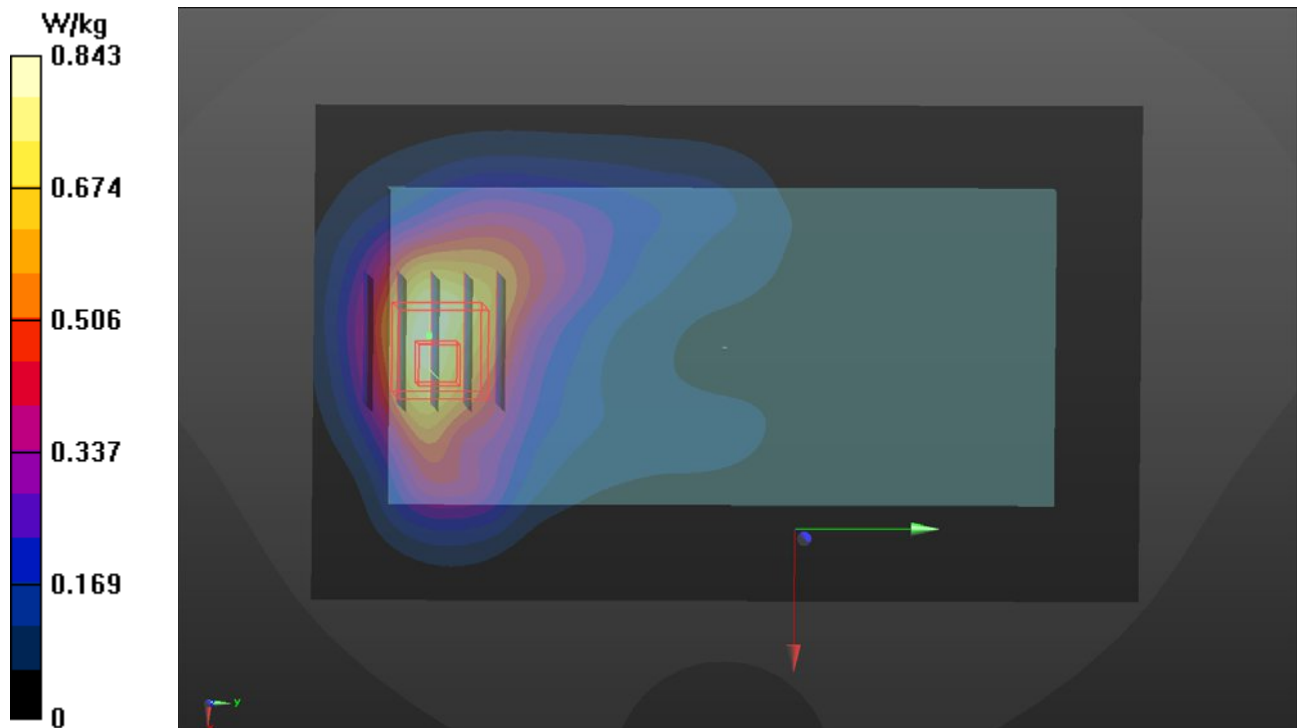

P25 LTE 38_QPSK20M_Rear Face_10mm_Ch38150_1RB_OS0_Ant0_Sensor OFF

DUT: 190827C07

Communication System: LTE TDD CF0; Frequency: 2610 MHz; Duty Cycle: 1:1.58
Medium: H19T27N1_0911 Medium parameters used: $f = 2610$ MHz; $\sigma = 2.043$ S/m; $\epsilon_r = 37.382$; $\rho = 1000$ kg/m³
Ambient Temperature : 23.8 °C ; Liquid Temperature : 23.2 °C

DASY5 Configuration:

- Probe: EX3DV4 - SN7375; ConvF(7.42, 7.42, 7.42); Calibrated: 2018/12/13
- Sensor-Surface: 1.4mm (Mechanical Surface Detection)
- Electronics: DAE4 Sn1277; Calibrated: 2019/01/24
- Phantom: Twin SAM Phantom_1823; Type: QD000P40CD;
- Measurement SW: DASY52, Version 52.10 (2); SEMCAD X Version 14.6.12 (7470)

- **Area Scan (101x171x1):** Interpolated grid: dx=1.200 mm, dy=1.200 mm
Maximum value of SAR (interpolated) = 1.13 W/kg

- **Zoom Scan (5x5x7)/Cube 0:** Measurement grid: dx=8mm, dy=8mm, dz=5mm
Reference Value = 22.96 V/m; Power Drift = -0.05 dB
Peak SAR (extrapolated) = 1.59 W/kg
SAR(1 g) = 0.809 W/kg; SAR(10 g) = 0.416 W/kg
Maximum value of SAR (measured) = 1.23 W/kg

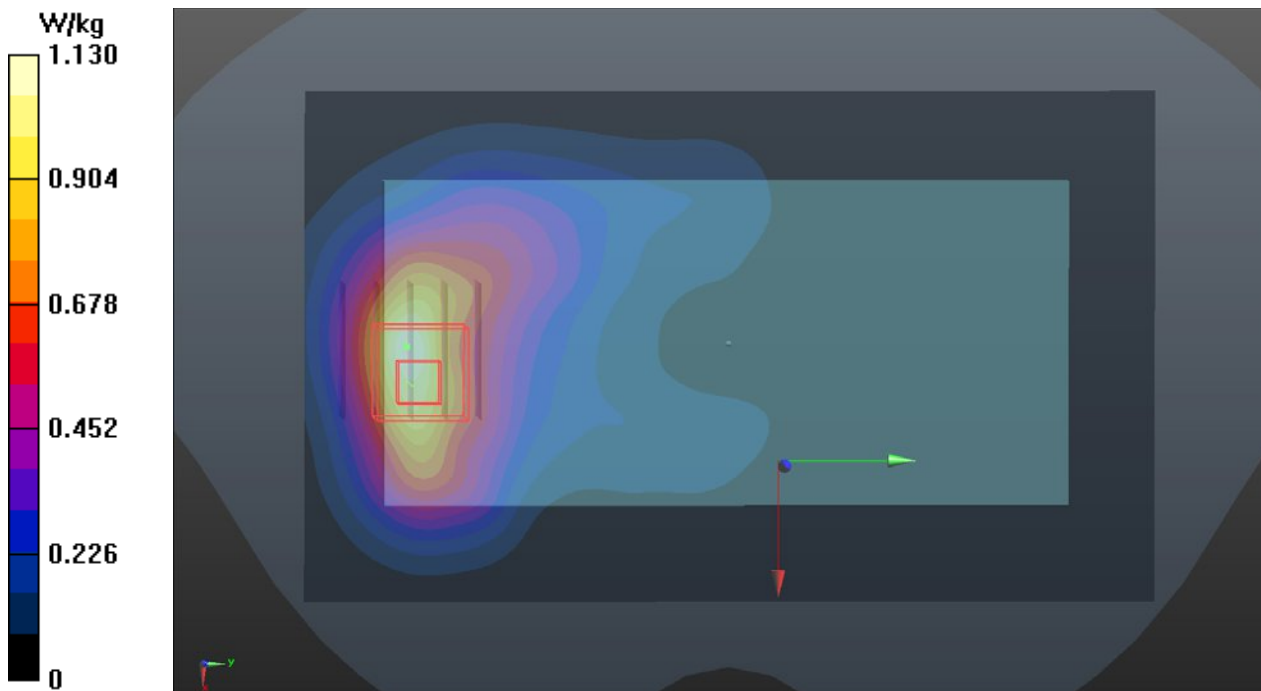

P26 WLAN2.4G_802.11b_Rear Face_10mm_Ch6_Ant0

DUT: 190827C07

Communication System: WLAN_2.4G; Frequency: 2437 MHz; Duty Cycle: 1:1

Medium: H19T27N1_0910 Medium parameters used: $f = 2437$ MHz; $\sigma = 1.863$ S/m; $\epsilon_r = 39.179$; $\rho = 1000$ kg/m³

Ambient Temperature : 23.5 °C ; Liquid Temperature : 23.2 °C

DASY5 Configuration:

- Probe: EX3DV4 - SN7537; ConvF(7.39, 7.39, 7.39); Calibrated: 2019/06/18

- Sensor-Surface: 1.4mm (Mechanical Surface Detection)

- Electronics: DAE4 Sn1585; Calibrated: 2019/06/07

- Phantom: SAM Phantom_1982; Type: QD 000 P41 Ax; Serial: 1982

- Measurement SW: DASY52, Version 52.10 (2); SEMCAD X Version 14.6.12 (7470)

- **Area Scan (101x171x1):** Interpolated grid: dx=1.200 mm, dy=1.200 mm

Maximum value of SAR (interpolated) = 0.483 W/kg

- **Zoom Scan (5x5x7)/Cube 0:** Measurement grid: dx=8mm, dy=8mm, dz=5mm

Reference Value = 14.50 V/m; Power Drift = -0.06 dB

Peak SAR (extrapolated) = 0.673 W/kg

SAR(1 g) = 0.333 W/kg; SAR(10 g) = 0.166 W/kg

Maximum value of SAR (measured) = 0.498 W/kg

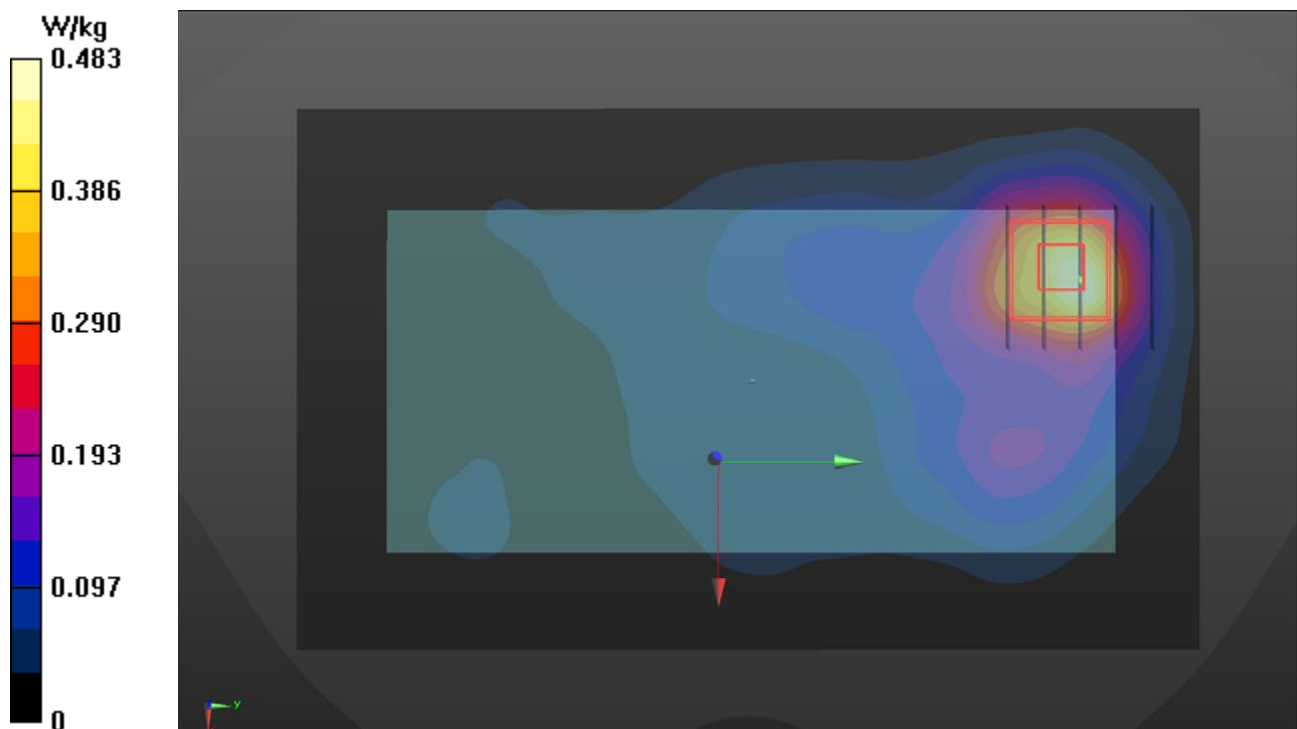

P27 WLAN5.3G_802.11a_Rear Face_10mm_Ch60_Ant0

DUT: 190827C07

Communication System: WLAN_5G; Frequency: 5300 MHz; Duty Cycle: 1:1.02

Medium: H34T60N1_0910 Medium parameters used: $f = 5300$ MHz; $\sigma = 4.896$ S/m; $\epsilon_r = 35.546$; $\rho = 1000$ kg/m³

Ambient Temperature : 23.5 °C ; Liquid Temperature : 23.2 °C

DASY5 Configuration:

- Probe: EX3DV4 - SN7537; ConvF(5.36, 5.36, 5.36); Calibrated: 2019/06/18
- Sensor-Surface: 1.4mm (Mechanical Surface Detection)
- Electronics: DAE4 Sn1585; Calibrated: 2019/06/07
- Phantom: SAM Phantom_1982; Type: QD 000 P41 Ax; Serial: 1982
- Measurement SW: DASY52, Version 52.10 (2); SEMCAD X Version 14.6.12 (7470)

- **Area Scan (121x201x1):** Interpolated grid: dx=1.000 mm, dy=1.000 mm
Maximum value of SAR (interpolated) = 0.679 W/kg

- **Zoom Scan (6x6x12)/Cube 0:** Measurement grid: dx=5mm, dy=5mm, dz=2mm
Reference Value = 12.49 V/m; Power Drift = -0.03 dB
Peak SAR (extrapolated) = 1.24 W/kg
SAR(1 g) = 0.325 W/kg; SAR(10 g) = 0.103 W/kg
Maximum value of SAR (measured) = 0.741 W/kg

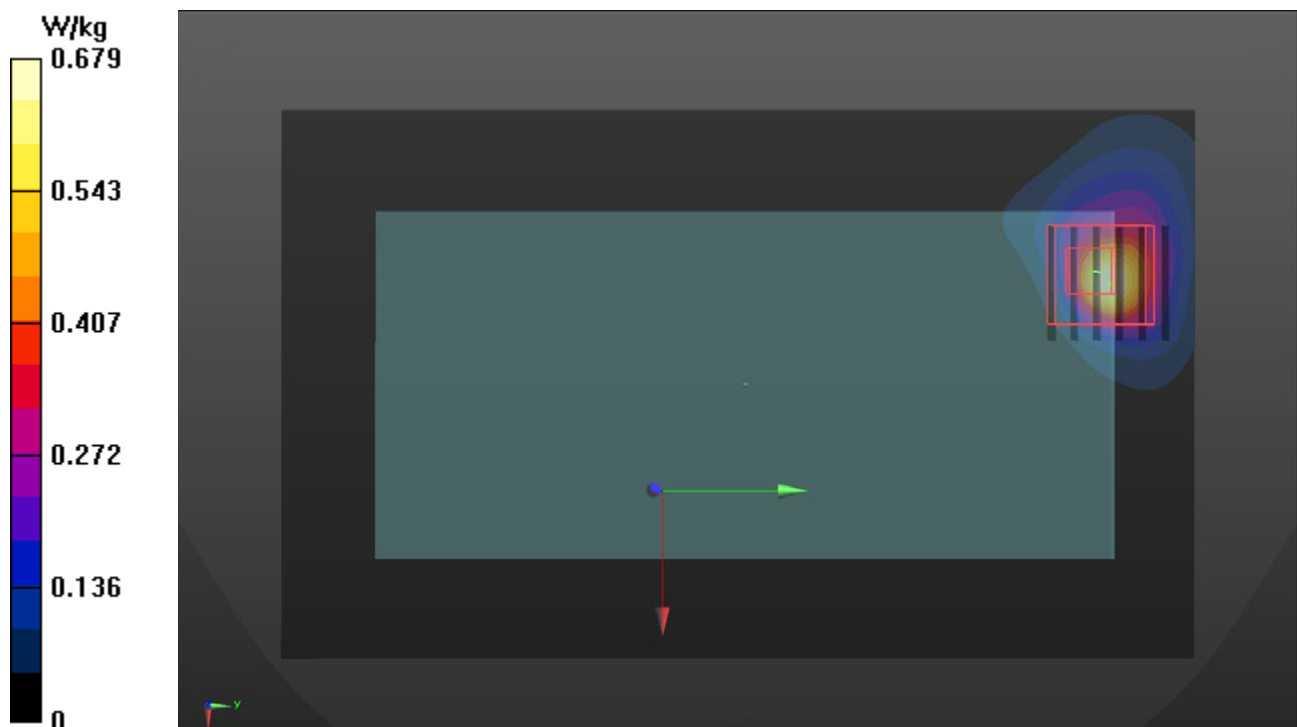

P28 WLAN5.6G_802.11a_Rear Face_10mm_Ch116_Ant0

DUT: 190827C07

Communication System: WLAN_5G; Frequency: 5580 MHz; Duty Cycle: 1:1.02

Medium: H34T60N1_0911 Medium parameters used: $f = 5580 \text{ MHz}$; $\sigma = 5.156 \text{ S/m}$; $\epsilon_r = 35.884$; $\rho = 1000 \text{ kg/m}^3$

Ambient Temperature : 23.5 °C ; Liquid Temperature : 23.2 °C

DASY5 Configuration:

- Probe: EX3DV4 - SN7537; ConvF(4.75, 4.75, 4.75); Calibrated: 2019/06/18
- Sensor-Surface: 1.4mm (Mechanical Surface Detection)
- Electronics: DAE4 Sn1585; Calibrated: 2019/06/07
- Phantom: SAM Phantom_1982; Type: QD 000 P41 Ax; Serial: 1982
- Measurement SW: DASY52, Version 52.10 (2); SEMCAD X Version 14.6.12 (7470)

- **Area Scan (121x201x1):** Interpolated grid: $dx=1.000 \text{ mm}$, $dy=1.000 \text{ mm}$
 Maximum value of SAR (interpolated) = 0.318 W/kg

- **Zoom Scan (6x6x12)/Cube 0:** Measurement grid: $dx=5\text{mm}$, $dy=5\text{mm}$, $dz=2\text{mm}$
 Reference Value = 8.512 V/m; Power Drift = 0.03 dB
 Peak SAR (extrapolated) = 0.416 W/kg
SAR(1 g) = 0.252 W/kg; SAR(10 g) = 0.109 W/kg
 Maximum value of SAR (measured) = 0.363 W/kg

- **Zoom Scan (6x6x12)/Cube 1:** Measurement grid: $dx=5\text{mm}$, $dy=5\text{mm}$, $dz=2\text{mm}$
 Reference Value = 8.512 V/m; Power Drift = 0.03 dB
 Peak SAR (extrapolated) = 0.222 W/kg
SAR(1 g) = 0.156 W/kg; SAR(10 g) = 0.096 W/kg
 Maximum value of SAR (measured) = 0.208 W/kg

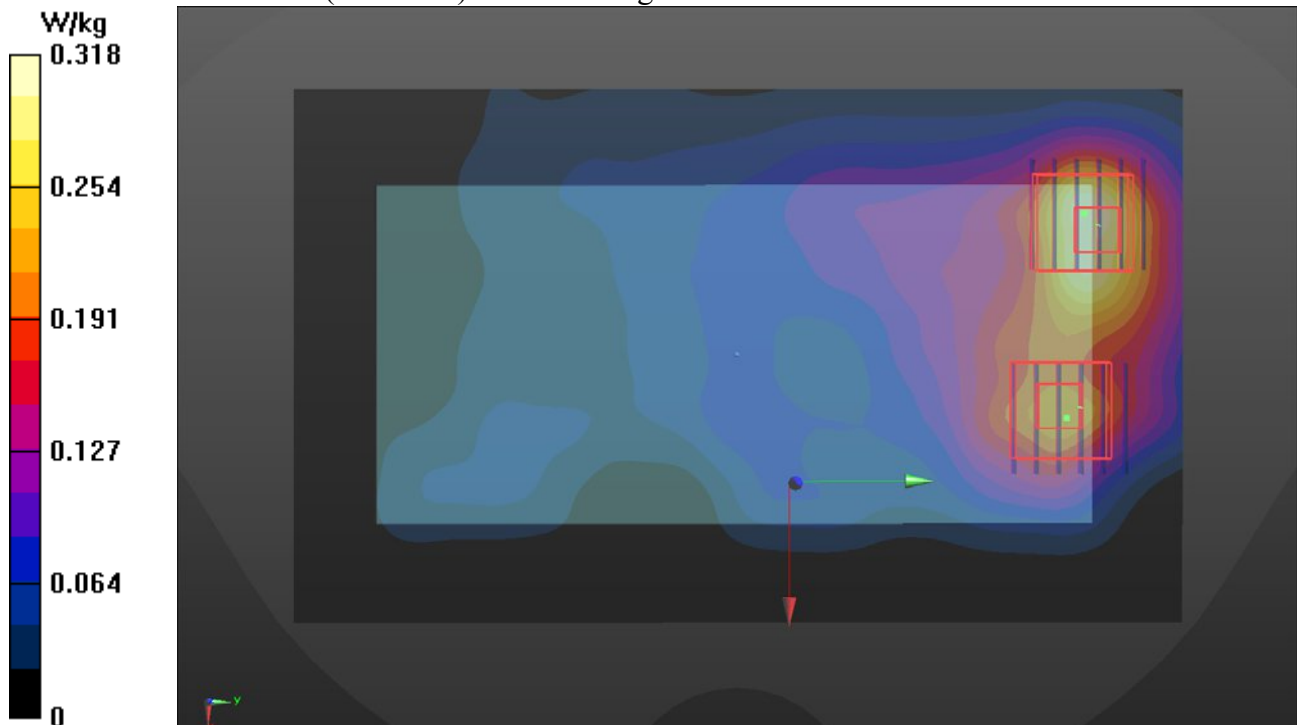

P29 WLAN5.8G_802.11a_Rear Face_10mm_Ch161_Ant0

DUT: 190827C07

Communication System: WLAN_5G; Frequency: 5805 MHz; Duty Cycle: 1:1.02

Medium: H34T60N1_0911 Medium parameters used: $f = 5805$ MHz; $\sigma = 5.393$ S/m; $\epsilon_r = 35.625$; $\rho = 1000$ kg/m³

Ambient Temperature : 23.5 °C ; Liquid Temperature : 23.2 °C

DASY5 Configuration:

- Probe: EX3DV4 - SN7537; ConvF(4.99, 4.99, 4.99); Calibrated: 2019/06/18
- Sensor-Surface: 1.4mm (Mechanical Surface Detection)
- Electronics: DAE4 Sn1585; Calibrated: 2019/06/07
- Phantom: SAM Phantom_1982; Type: QD 000 P41 Ax; Serial: 1982
- Measurement SW: DASY52, Version 52.10 (2); SEMCAD X Version 14.6.12 (7470)

- **Area Scan (121x201x1):** Interpolated grid: dx=1.000 mm, dy=1.000 mm
Maximum value of SAR (interpolated) = 0.497 W/kg

- **Zoom Scan (6x6x12)/Cube 0:** Measurement grid: dx=5mm, dy=5mm, dz=2mm
Reference Value = 9.860 V/m; Power Drift = -0.04 dB
Peak SAR (extrapolated) = 1.11 W/kg
SAR(1 g) = 0.276 W/kg; SAR(10 g) = 0.097 W/kg
Maximum value of SAR (measured) = 0.630 W/kg

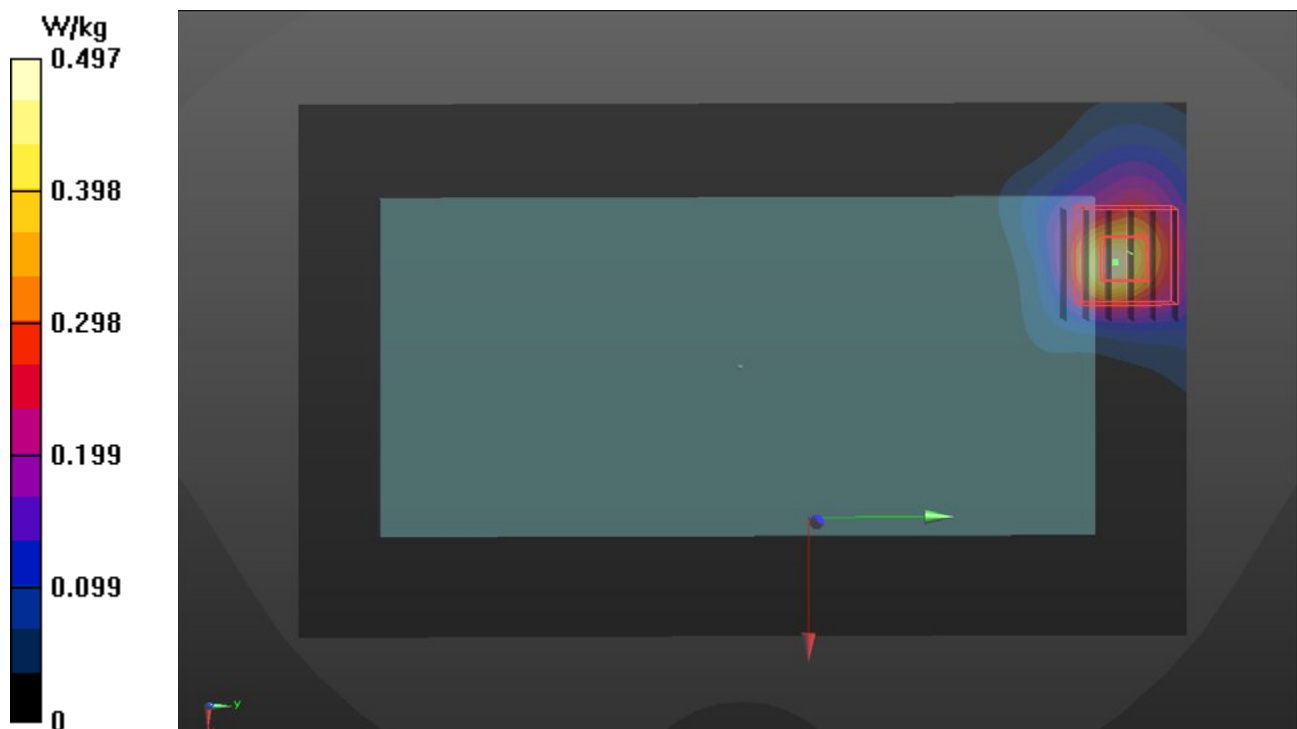

P30 BT_BDR_Rear Face_10mm_Ch39_Ant0

DUT: 190827C07

Communication System: BT; Frequency: 2441 MHz; Duty Cycle: 1:1.3

Medium: H19T27N1_0910 Medium parameters used: $f = 2441$ MHz; $\sigma = 1.868$ S/m; $\epsilon_r = 39.162$; $\rho = 1000$ kg/m³

Ambient Temperature : 23.5 °C ; Liquid Temperature : 23.2 °C

DASY5 Configuration:

- Probe: EX3DV4 - SN7537; ConvF(7.39, 7.39, 7.39); Calibrated: 2019/06/18
- Sensor-Surface: 1.4mm (Mechanical Surface Detection)
- Electronics: DAE4 Sn1585; Calibrated: 2019/06/07
- Phantom: SAM Phantom_1982; Type: QD 000 P41 Ax; Serial: 1982
- Measurement SW: DASY52, Version 52.10 (2); SEMCAD X Version 14.6.12 (7470)

- **Area Scan (101x171x1):** Interpolated grid: dx=1.200 mm, dy=1.200 mm
Maximum value of SAR (interpolated) = 0.0451 W/kg

- **Zoom Scan (5x5x7)/Cube 1:** Measurement grid: dx=8mm, dy=8mm, dz=5mm
Reference Value = 4.097 V/m; Power Drift = 0.03 dB
Peak SAR (extrapolated) = 0.0450 W/kg
SAR(1 g) = 0.022 W/kg; SAR(10 g) = 0.012 W/kg
Maximum value of SAR (measured) = 0.0343 W/kg

- **Zoom Scan (5x5x7)/Cube 0:** Measurement grid: dx=8mm, dy=8mm, dz=5mm
Reference Value = 4.097 V/m; Power Drift = 0.03 dB
Peak SAR (extrapolated) = 0.0240 W/kg
SAR(1 g) = 0.015 W/kg; SAR(10 g) = 0.00977 W/kg
Maximum value of SAR (measured) = 0.0198 W/kg

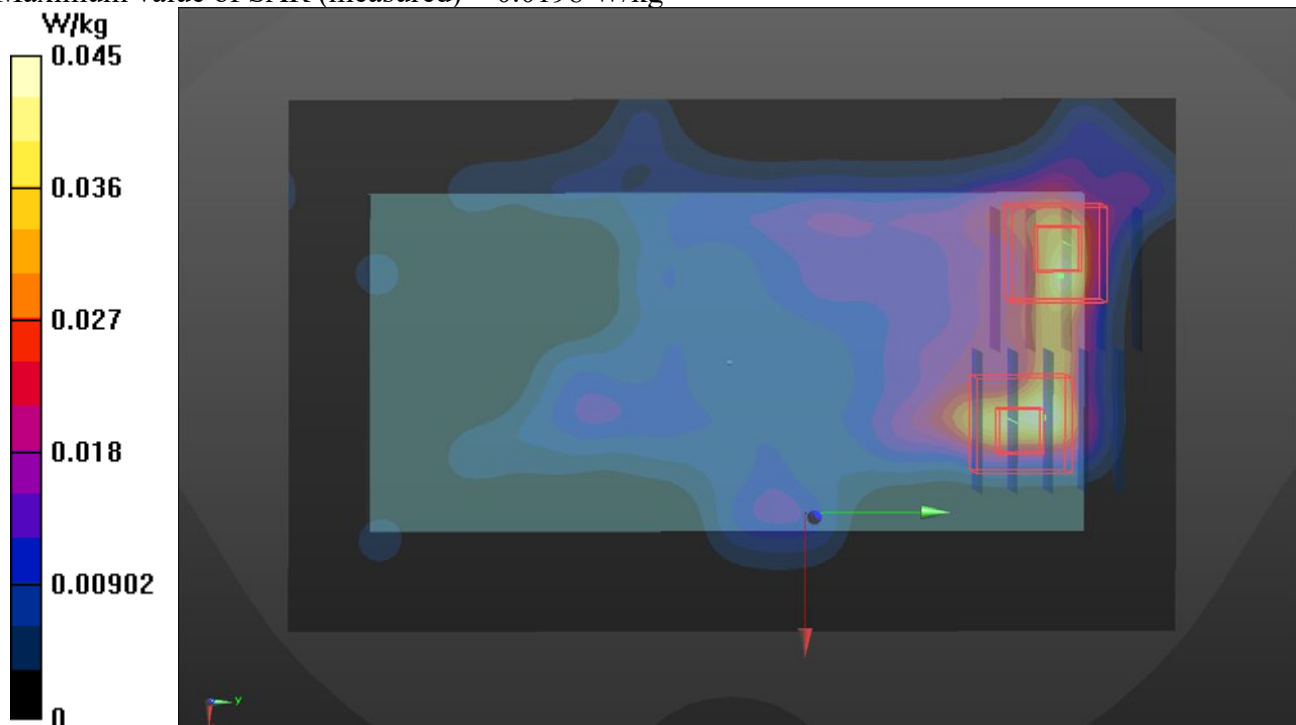

P31 GSM1900_GPRS8_Bottom Side_10mm_Ch810_Ant0_Sensor OFF

DUT: 190827C07

Communication System: GPRS8; Frequency: 1909.8 MHz; Duty Cycle: 1:8.3

Medium: H16T20N4_0910 Medium parameters used: $f = 1910$ MHz; $\sigma = 1.471$ S/m; $\epsilon_r = 39.924$; $\rho = 1000$ kg/m³

Ambient Temperature : 23.8 °C ; Liquid Temperature : 23.2 °C

DASY5 Configuration:

- Probe: EX3DV4 - SN7375; ConvF(8.26, 8.26, 8.26); Calibrated: 2018/12/13
- Sensor-Surface: 1.4mm (Mechanical Surface Detection)
- Electronics: DAE4 Sn1277; Calibrated: 2019/01/24
- Phantom: Twin SAM Phantom_1823; Type: QD000P40CD;
- Measurement SW: DASY52, Version 52.10 (2); SEMCAD X Version 14.6.12 (7470)

- **Area Scan (61x71x1):** Interpolated grid: dx=1.500 mm, dy=1.500 mm

Maximum value of SAR (interpolated) = 1.85 W/kg

- **Zoom Scan (5x5x7)/Cube 0:** Measurement grid: dx=8mm, dy=8mm, dz=5mm

Reference Value = 31.95 V/m; Power Drift = 0.03 dB

Peak SAR (extrapolated) = 2.15 W/kg

SAR(1 g) = 1.15 W/kg; SAR(10 g) = 0.631 W/kg

Maximum value of SAR (measured) = 1.83 W/kg

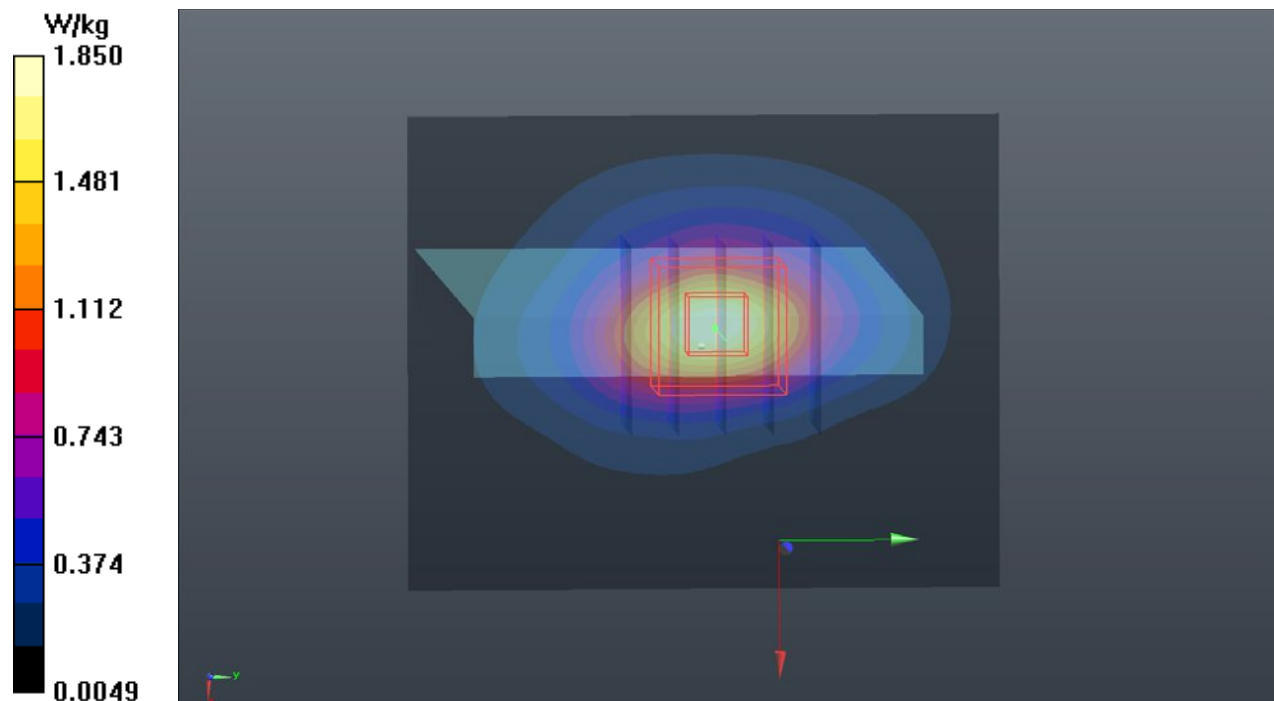

P32 WCDMA II_RMC12.2K_Bottom Side_10mm_Ch9400_Ant0_Sensor ON

DUT: 190827C07

Communication System: WCDMA; Frequency: 1880 MHz; Duty Cycle: 1:1

Medium: H16T20N1_0913 Medium parameters used: $f = 1880$ MHz; $\sigma = 1.425$ S/m; $\epsilon_r = 38.929$; $\rho = 1000$ kg/m³

Ambient Temperature : 23.6 °C ; Liquid Temperature : 23.3 °C

DASY5 Configuration:

- Probe: EX3DV4 - SN7537; ConvF(8.13, 8.13, 8.13); Calibrated: 2019/06/18
- Sensor-Surface: 1.4mm (Mechanical Surface Detection)
- Electronics: DAE4 Sn1585; Calibrated: 2019/06/07
- Phantom: SAM Phantom_1982; Type: QD 000 P41 Ax; Serial: 1982
- Measurement SW: DASY52, Version 52.10 (2); SEMCAD X Version 14.6.12 (7470)

- **Area Scan (41x81x1):** Interpolated grid: $dx=1.500$ mm, $dy=1.500$ mm

Maximum value of SAR (interpolated) = 1.29 W/kg

- **Zoom Scan (5x5x7)/Cube 0:** Measurement grid: $dx=8$ mm, $dy=8$ mm, $dz=5$ mm

Reference Value = 27.85 V/m; Power Drift = -0.07 dB

Peak SAR (extrapolated) = 1.73 W/kg

SAR(1 g) = 0.954 W/kg; SAR(10 g) = 0.506 W/kg

Maximum value of SAR (measured) = 1.43 W/kg

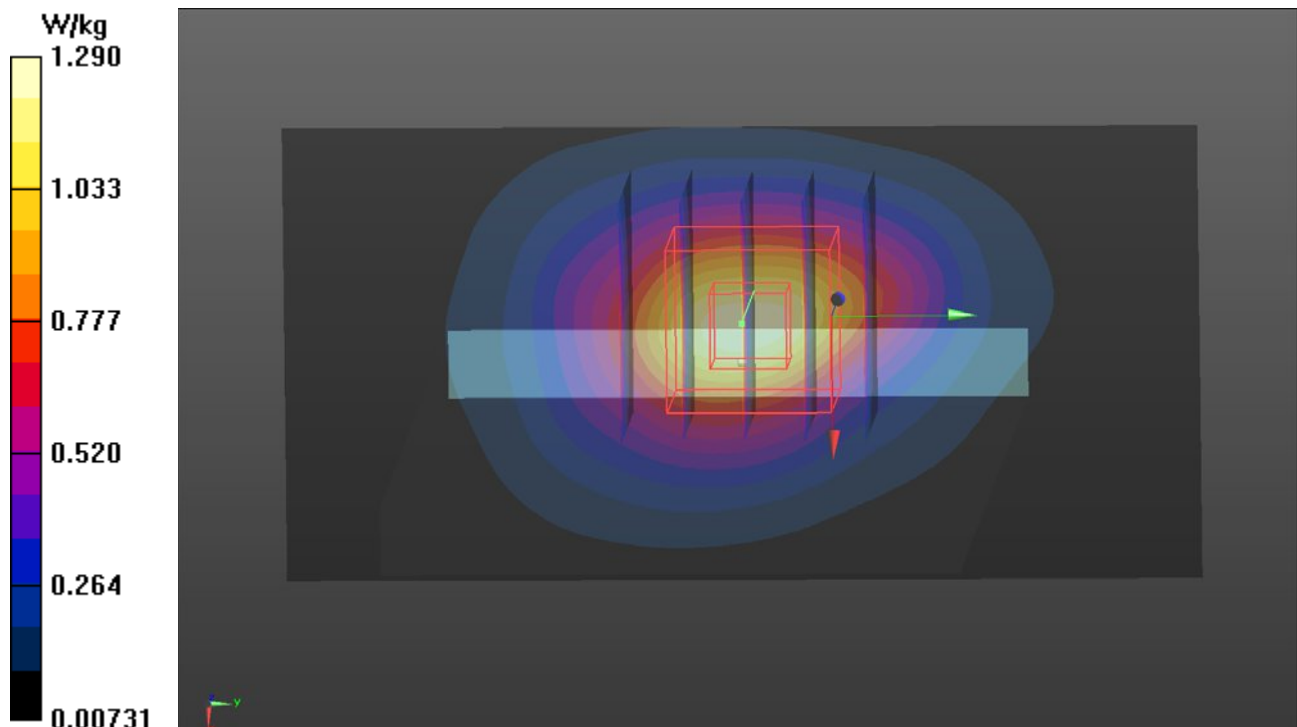

P33 WCDMA IV_RMC12.2K_Bottom Side_10mm_Ch1513_Ant0_Sensor ON

DUT: 190827C07

Communication System: WCDMA; Frequency: 1752.6 MHz; Duty Cycle: 1:1
Medium: H16T20N4_0910 Medium parameters used: $f = 1753$ MHz; $\sigma = 1.33$ S/m; $\epsilon_r = 40.481$; $\rho = 1000$ kg/m³
Ambient Temperature : 23.7 °C ; Liquid Temperature : 23.3 °C

DASY5 Configuration:

- Probe: EX3DV4 - SN7375; ConvF(8.58, 8.58, 8.58); Calibrated: 2018/12/13
- Sensor-Surface: 1.4mm (Mechanical Surface Detection)
- Electronics: DAE4 Sn1277; Calibrated: 2019/01/24
- Phantom: Twin SAM Phantom_1823; Type: QD000P40CD;
- Measurement SW: DASY52, Version 52.10 (2); SEMCAD X Version 14.6.12 (7470)

- **Area Scan (61x71x1):** Interpolated grid: dx=1.500 mm, dy=1.500 mm
Maximum value of SAR (interpolated) = 1.40 W/kg

- **Zoom Scan (5x5x7)/Cube 0:** Measurement grid: dx=8mm, dy=8mm, dz=5mm
Reference Value = 32.73 V/m; Power Drift = -0.05 dB
Peak SAR (extrapolated) = 1.67 W/kg
SAR(1 g) = 0.928 W/kg; SAR(10 g) = 0.505 W/kg
Maximum value of SAR (measured) = 1.43 W/kg

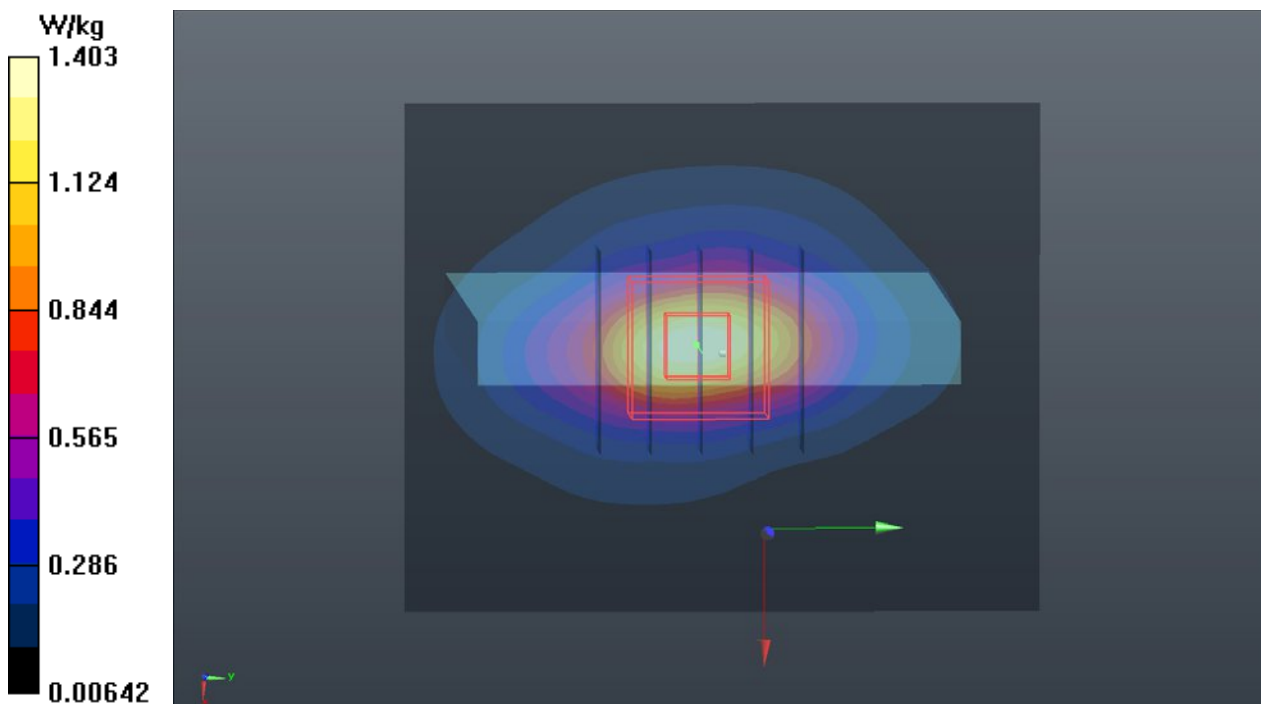

P34 WCDMA V_RMC12.2K_Rear Face_10mm_Ch4233_Ant 0_Sensor OFF

DUT: 190827C07

Communication System: WCDMA; Frequency: 846.6 MHz; Duty Cycle: 1:1

Medium: H07T10N1_0923 Medium parameters used: $f = 847 \text{ MHz}$; $\sigma = 0.924 \text{ S/m}$; $\epsilon_r = 42.579$; $\rho = 1000 \text{ kg/m}^3$

Ambient Temperature : $23.7 \text{ }^\circ\text{C}$; Liquid Temperature : $23.4 \text{ }^\circ\text{C}$

DASY5 Configuration:

- Probe: EX3DV4 - SN3971; ConvF(10.18, 10.18, 10.18); Calibrated: 2019/03/29
- Sensor-Surface: 1.4mm (Mechanical Surface Detection)
- Electronics: DAE4 Sn1431; Calibrated: 2019/03/25
- Phantom: Twin SAM Phantom_1496; Type: QD000P40CA;
- Measurement SW: DASY52, Version 52.10 (2); SEMCAD X Version 14.6.12 (7470)

- **Area Scan (81x141x1):** Interpolated grid: $dx=1.500 \text{ mm}$, $dy=1.500 \text{ mm}$

Maximum value of SAR (interpolated) = 0.391 W/kg

- **Zoom Scan (5x5x7)/Cube 0:** Measurement grid: $dx=8\text{mm}$, $dy=8\text{mm}$, $dz=5\text{mm}$

Reference Value = 19.44 V/m ; Power Drift = 0.16 dB

Peak SAR (extrapolated) = 0.458 W/kg

SAR(1 g) = 0.248 W/kg ; SAR(10 g) = 0.144 W/kg

Maximum value of SAR (measured) = 0.376 W/kg

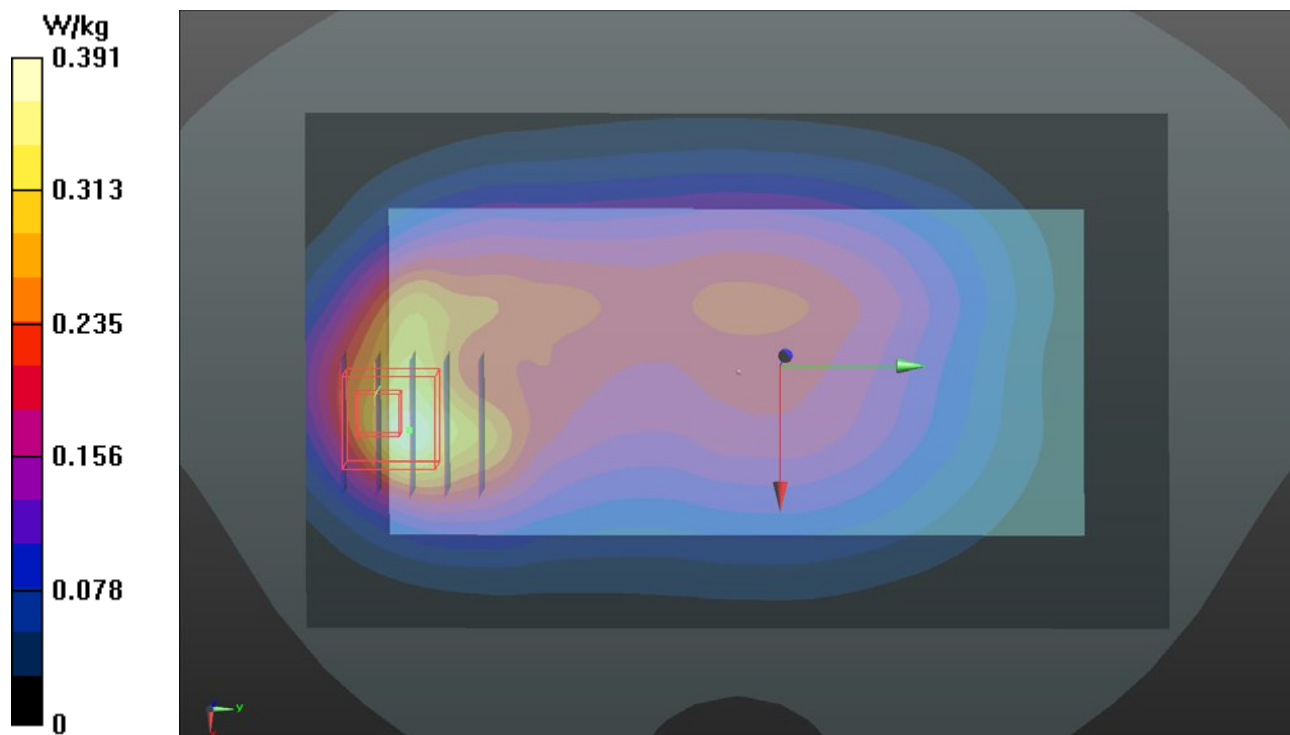

P35 LTE 2_QPSK20M_Bottom Side_10mm_Ch18900_1RB_OS0_Ant0_Sensor ON

DUT: 190827C07

Communication System: LTE; Frequency: 1880 MHz; Duty Cycle: 1:1
Medium: H16T20N4_0910 Medium parameters used: $f = 1880$ MHz; $\sigma = 1.437$ S/m; $\epsilon_r = 40.035$; $\rho = 1000$ kg/m³
Ambient Temperature : 23.7 °C ; Liquid Temperature : 23.3 °C

DASY5 Configuration:

- Probe: EX3DV4 - SN7375; ConvF(8.26, 8.26, 8.26); Calibrated: 2018/12/13
- Sensor-Surface: 1.4mm (Mechanical Surface Detection)
- Electronics: DAE4 Sn1277; Calibrated: 2019/01/24
- Phantom: Twin SAM Phantom_1823; Type: QD000P40CD;
- Measurement SW: DASY52, Version 52.10 (2); SEMCAD X Version 14.6.12 (7470)

- **Area Scan (61x71x1):** Interpolated grid: dx=1.500 mm, dy=1.500 mm
Maximum value of SAR (interpolated) = 1.47 W/kg

- **Zoom Scan (5x5x7)/Cube 0:** Measurement grid: dx=8mm, dy=8mm, dz=5mm
Reference Value = 31.69 V/m; Power Drift = -0.01 dB
Peak SAR (extrapolated) = 1.72 W/kg
SAR(1 g) = 0.972 W/kg; SAR(10 g) = 0.516 W/kg
Maximum value of SAR (measured) = 1.46 W/kg

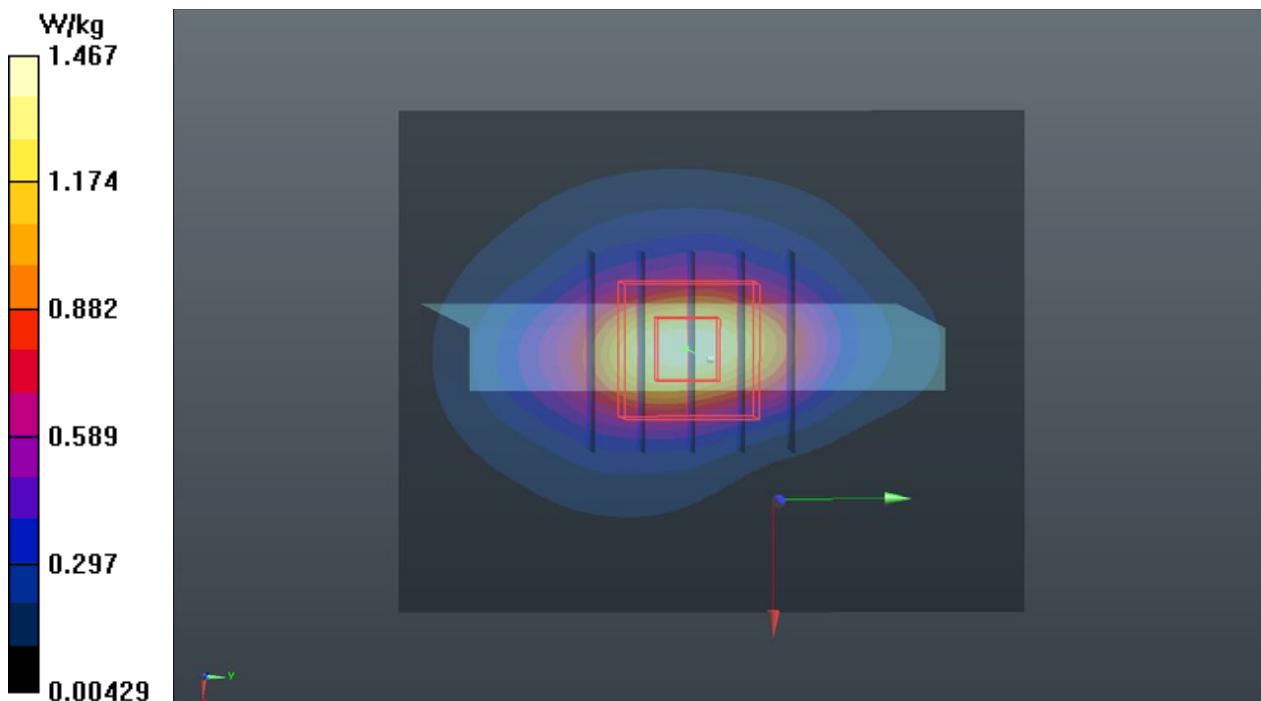

P36 LTE 4_QPSK20M_Bottom Side_10mm_Ch20300_1RB_OS0_Ant0_Sensor ON

DUT: 190827C07

Communication System: LTE; Frequency: 1745 MHz; Duty Cycle: 1:1
Medium: H16T20N4_0910 Medium parameters used: $f = 1745$ MHz; $\sigma = 1.324$ S/m; $\epsilon_r = 40.519$; $\rho = 1000$ kg/m³
Ambient Temperature : 23.7 °C ; Liquid Temperature : 23.3 °C

DASY5 Configuration:

- Probe: EX3DV4 - SN7375; ConvF(8.58, 8.58, 8.58); Calibrated: 2018/12/13
- Sensor-Surface: 1.4mm (Mechanical Surface Detection)
- Electronics: DAE4 Sn1277; Calibrated: 2019/01/24
- Phantom: Twin SAM Phantom_1823; Type: QD000P40CD;
- Measurement SW: DASY52, Version 52.10 (2); SEMCAD X Version 14.6.12 (7470)

- **Area Scan (61x71x1):** Interpolated grid: dx=1.500 mm, dy=1.500 mm
Maximum value of SAR (interpolated) = 1.24 W/kg

- **Zoom Scan (5x5x7)/Cube 0:** Measurement grid: dx=8mm, dy=8mm, dz=5mm
Reference Value = 30.57 V/m; Power Drift = -0.11 dB
Peak SAR (extrapolated) = 1.46 W/kg
SAR(1 g) = 0.839 W/kg; SAR(10 g) = 0.450 W/kg
Maximum value of SAR (measured) = 1.25 W/kg

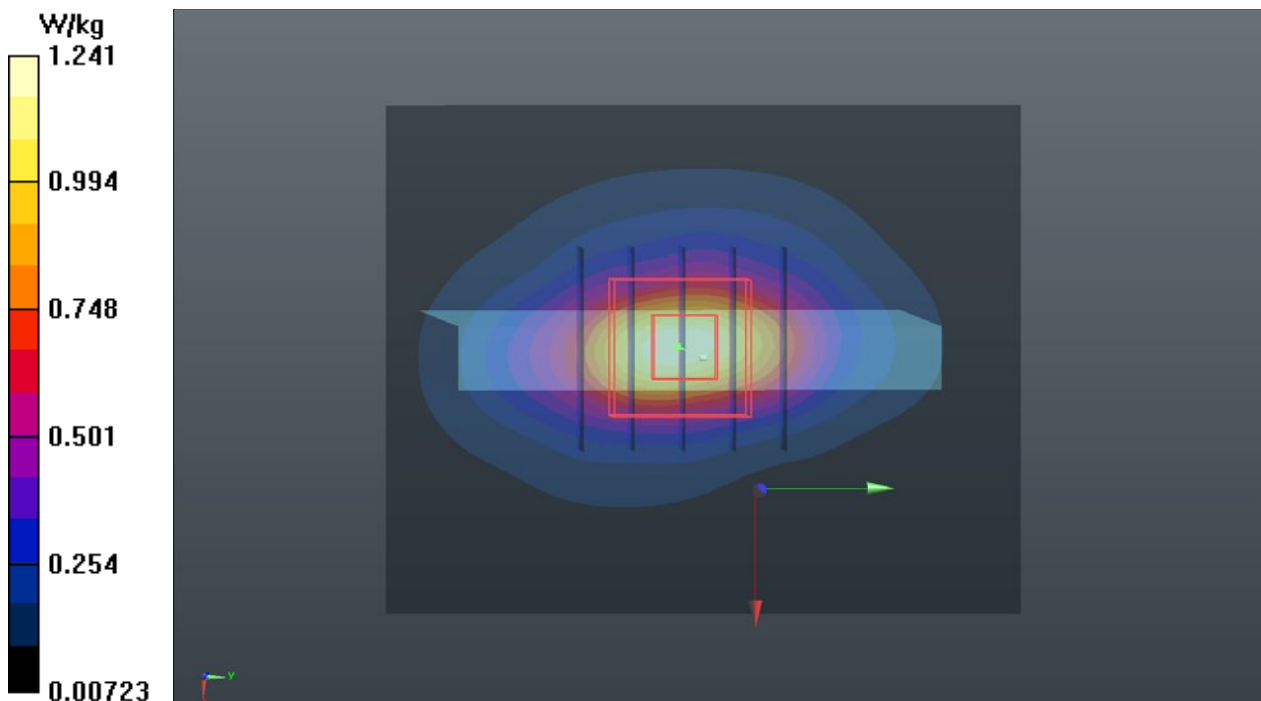

P37 LTE 5_QPSK10M_Rear Face_10mm_Ch20525_1RB_OS0_Ant 0_Sensor OFF

DUT: 190827C07

Communication System: LTE; Frequency: 836.5 MHz; Duty Cycle: 1:1

Medium: H07T10N1_0923 Medium parameters used: $f = 836.5$ MHz; $\sigma = 0.914$ S/m; $\epsilon_r = 42.701$; $\rho = 1000$ kg/m³

Ambient Temperature : 23.7 °C ; Liquid Temperature : 23.4 °C

DASY5 Configuration:

- Probe: EX3DV4 - SN3971; ConvF(10.18, 10.18, 10.18); Calibrated: 2019/03/29
- Sensor-Surface: 1.4mm (Mechanical Surface Detection)
- Electronics: DAE4 Sn1431; Calibrated: 2019/03/25
- Phantom: Twin SAM Phantom_1496; Type: QD000P40CA;
- Measurement SW: DASY52, Version 52.10 (2); SEMCAD X Version 14.6.12 (7470)

- **Area Scan (81x141x1):** Interpolated grid: dx=1.500 mm, dy=1.500 mm

Maximum value of SAR (interpolated) = 0.300 W/kg

- **Zoom Scan (5x5x7)/Cube 0:** Measurement grid: dx=8mm, dy=8mm, dz=5mm

Reference Value = 17.16 V/m; Power Drift = 0.14 dB

Peak SAR (extrapolated) = 0.350 W/kg

SAR(1 g) = 0.189 W/kg; SAR(10 g) = 0.111 W/kg

Maximum value of SAR (measured) = 0.284 W/kg

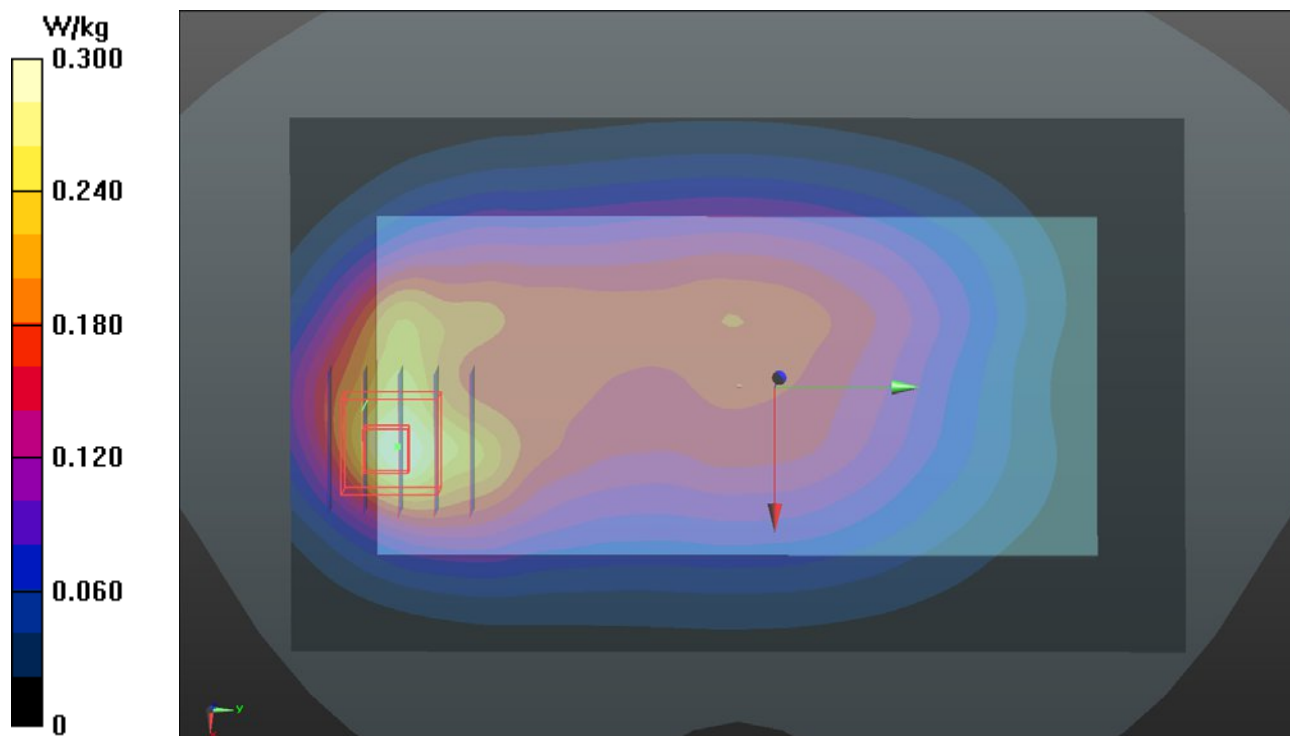

P38 LTE 7_QPSK20M_Bottom Side_10mm_Ch20850_1RB_OS0_Ant0_Sensor ON

DUT: 190827C07

Communication System: LTE; Frequency: 2510 MHz; Duty Cycle: 1:1

Medium: H19T27N1_0914 Medium parameters used: $f = 2510$ MHz; $\sigma = 1.891$ S/m; $\epsilon_r = 38.387$; $\rho = 1000$ kg/m³

Ambient Temperature : 23.6 °C ; Liquid Temperature : 23.3 °C

DASY5 Configuration:

- Probe: EX3DV4 - SN7537; ConvF(7.19, 7.19, 7.19); Calibrated: 2019/06/18
- Sensor-Surface: 1.4mm (Mechanical Surface Detection)
- Electronics: DAE4 Sn1585; Calibrated: 2019/06/07
- Phantom: SAM Phantom_1982; Type: QD 000 P41 Ax; Serial: 1982
- Measurement SW: DASY52, Version 52.10 (2); SEMCAD X Version 14.6.12 (7470)

- **Area Scan (51x101x1):** Interpolated grid: dx=1.200 mm, dy=1.200 mm

Maximum value of SAR (interpolated) = 1.00 W/kg

- **Zoom Scan (5x5x7)/Cube 0:** Measurement grid: dx=8mm, dy=8mm, dz=5mm

Reference Value = 22.22 V/m; Power Drift = -0.05 dB

Peak SAR (extrapolated) = 1.37 W/kg

SAR(1 g) = 0.704 W/kg; SAR(10 g) = 0.361 W/kg

Maximum value of SAR (measured) = 1.11 W/kg

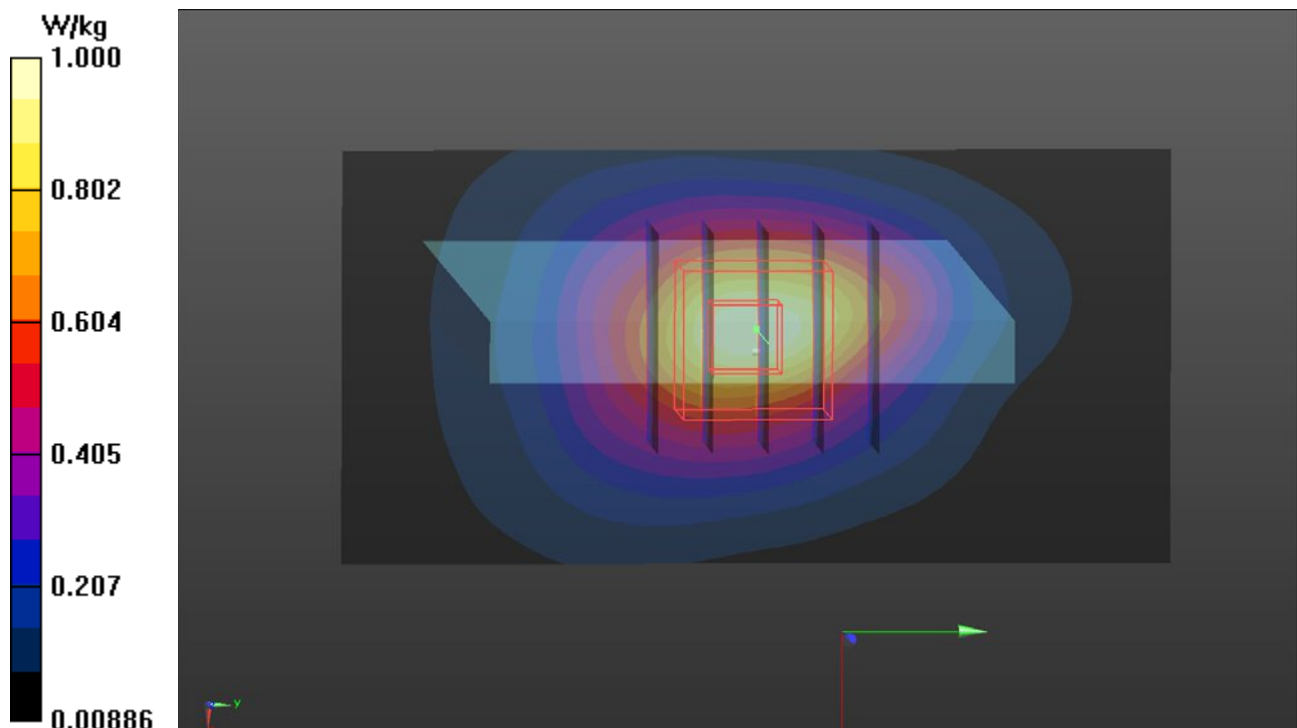

P39 LTE 38_QPSK20M_Bottom Side_10mm_Ch37850_1RB_OS0_Ant0_Sensor OFF

DUT: 190827C07

Communication System: LTE TDD CF0; Frequency: 2580 MHz; Duty Cycle: 1:1.58
Medium: H19T27N1_0911 Medium parameters used: $f = 2580$ MHz; $\sigma = 2.009$ S/m; $\epsilon_r = 37.474$; $\rho = 1000$ kg/m³
Ambient Temperature : 23.8 °C ; Liquid Temperature : 23.2 °C

DASY5 Configuration:

- Probe: EX3DV4 - SN7375; ConvF(7.42, 7.42, 7.42); Calibrated: 2018/12/13
- Sensor-Surface: 1.4mm (Mechanical Surface Detection)
- Electronics: DAE4 Sn1277; Calibrated: 2019/01/24
- Phantom: Twin SAM Phantom_1823; Type: QD000P40CD;
- Measurement SW: DASY52, Version 52.10 (2); SEMCAD X Version 14.6.12 (7470)

- **Area Scan (71x91x1):** Interpolated grid: dx=1.200 mm, dy=1.200 mm
Maximum value of SAR (interpolated) = 1.38 W/kg

- **Zoom Scan (5x5x7)/Cube 0:** Measurement grid: dx=8mm, dy=8mm, dz=5mm
Reference Value = 24.22 V/m; Power Drift = 0.16 dB
Peak SAR (extrapolated) = 1.67 W/kg
SAR(1 g) = 0.870 W/kg; SAR(10 g) = 0.445 W/kg
Maximum value of SAR (measured) = 1.34 W/kg

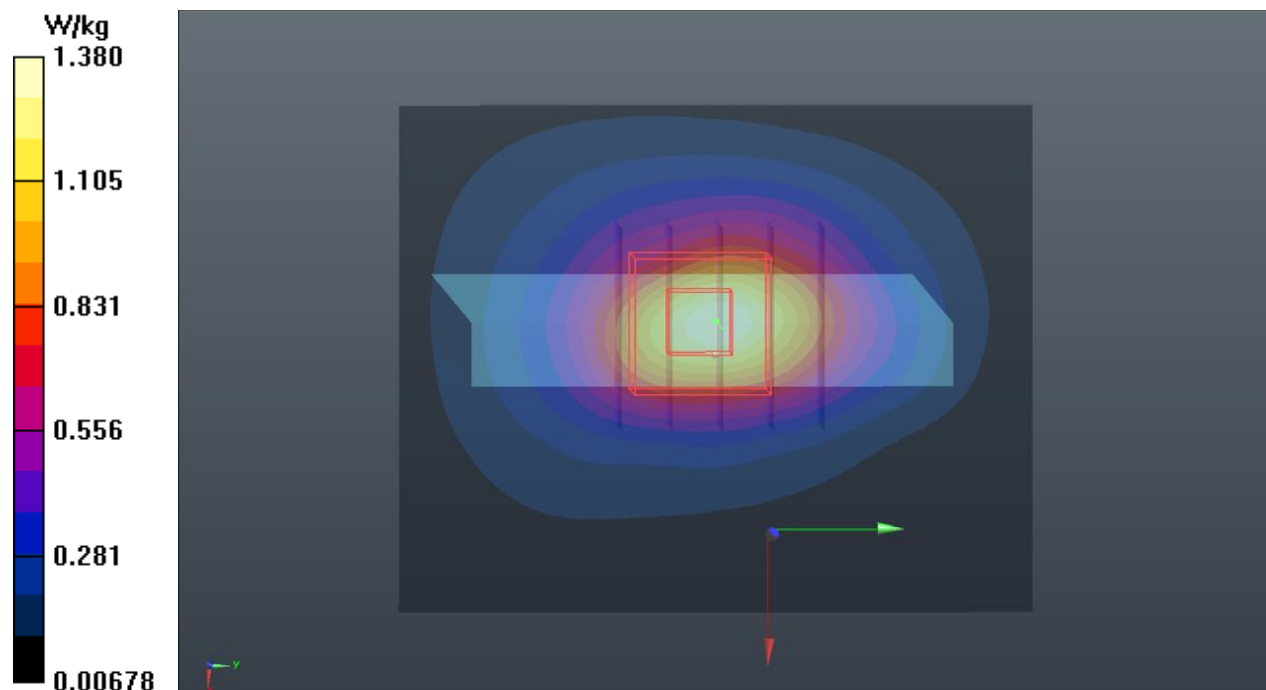

P40 WLAN5.2G_802.11a_Top Side_10mm_Ch48_Ant0

DUT: 190827C07

Communication System: WLAN_5G; Frequency: 5240 MHz; Duty Cycle: 1:1.02

Medium: H34T60N1_0908 Medium parameters used: $f = 5240$ MHz; $\sigma = 4.73$ S/m; $\epsilon_r = 36.881$; $\rho = 1000$ kg/m³

Ambient Temperature : 23.4 °C ; Liquid Temperature : 23.2 °C

DASY5 Configuration:

- Probe: EX3DV4 - SN7537; ConvF(5.36, 5.36, 5.36); Calibrated: 2019/06/18
- Sensor-Surface: 1.4mm (Mechanical Surface Detection)
- Electronics: DAE4 Sn1585; Calibrated: 2019/06/07
- Phantom: SAM Phantom_1982; Type: QD 000 P41 Ax; Serial: 1982
- Measurement SW: DASY52, Version 52.10 (2); SEMCAD X Version 14.6.12 (7470)

- **Area Scan (61x141x1)**: Interpolated grid: dx=1.000 mm, dy=1.000 mm
Maximum value of SAR (interpolated) = 0.285 W/kg

- **Zoom Scan (6x6x12)/Cube 0**: Measurement grid: dx=5mm, dy=5mm, dz=2mm
Reference Value = 8.299 V/m; Power Drift = -0.04 dB
Peak SAR (extrapolated) = 0.457 W/kg
SAR(1 g) = 0.133 W/kg; SAR(10 g) = 0.055 W/kg
Maximum value of SAR (measured) = 0.292 W/kg

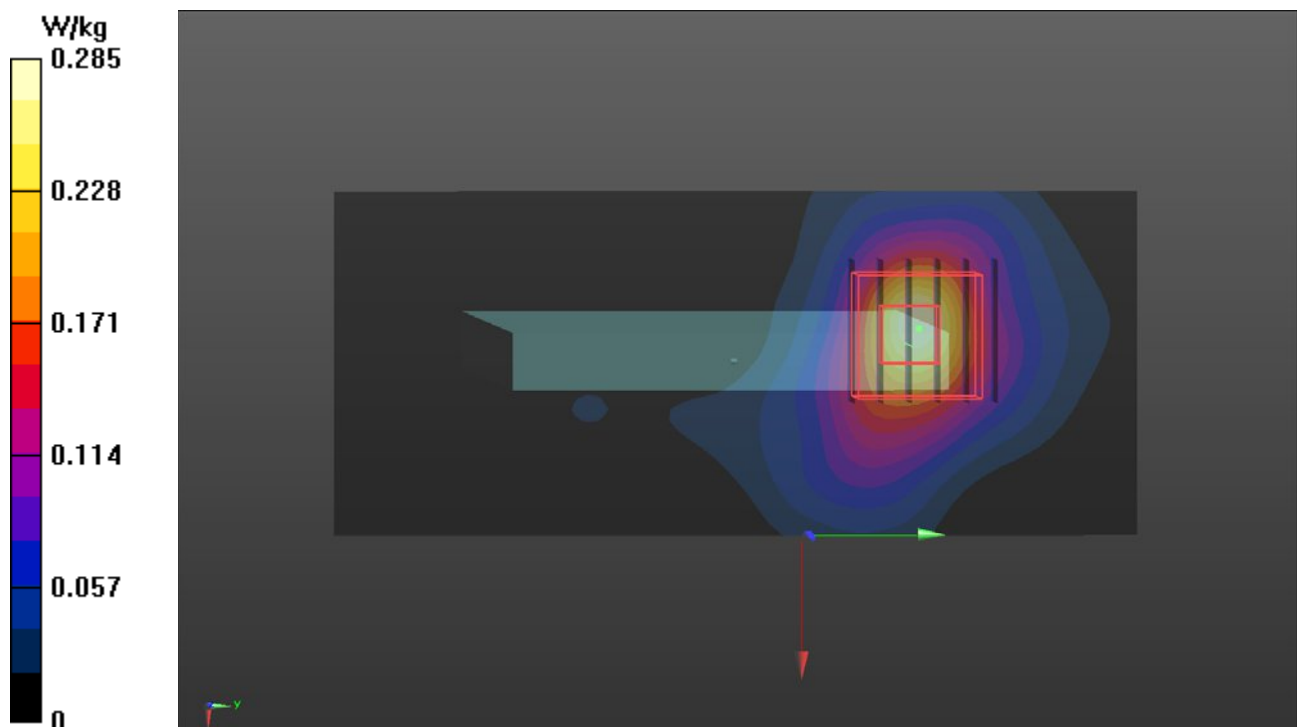

P41 GSM1900_GSM_Bottom Side_0mm_Ch512_Ant0_Sensor ON

DUT: 190827C07

Communication System: GSM; Frequency: 1850.2 MHz; Duty Cycle: 1:8.3
Medium: H16T20N1_0912 Medium parameters used: $f = 1850.2$ MHz; $\sigma = 1.41$ S/m; $\epsilon_r = 38.601$; $\rho = 1000$ kg/m³
Ambient Temperature : 23.8 °C ; Liquid Temperature : 23.2 °C

DASY5 Configuration:

- Probe: EX3DV4 - SN7375; ConvF(8.26, 8.26, 8.26); Calibrated: 2018/12/13
- Sensor-Surface: 1.4mm (Mechanical Surface Detection)
- Electronics: DAE4 Sn1277; Calibrated: 2019/01/24
- Phantom: Twin SAM Phantom_1823; Type: QD000P40CD;
- Measurement SW: DASY52, Version 52.10 (2); SEMCAD X Version 14.6.12 (7470)

- **Area Scan (61x71x1):** Interpolated grid: dx=1.500 mm, dy=1.500 mm
Maximum value of SAR (interpolated) = 8.16 W/kg

- **Zoom Scan (5x5x7)/Cube 0:** Measurement grid: dx=8mm, dy=8mm, dz=5mm
Reference Value = 73.39 V/m; Power Drift = 0.15 dB
Peak SAR (extrapolated) = 10.9 W/kg
SAR(1 g) = 4.81 W/kg; SAR(10 g) = 2.19 W/kg
Maximum value of SAR (measured) = 8.92 W/kg

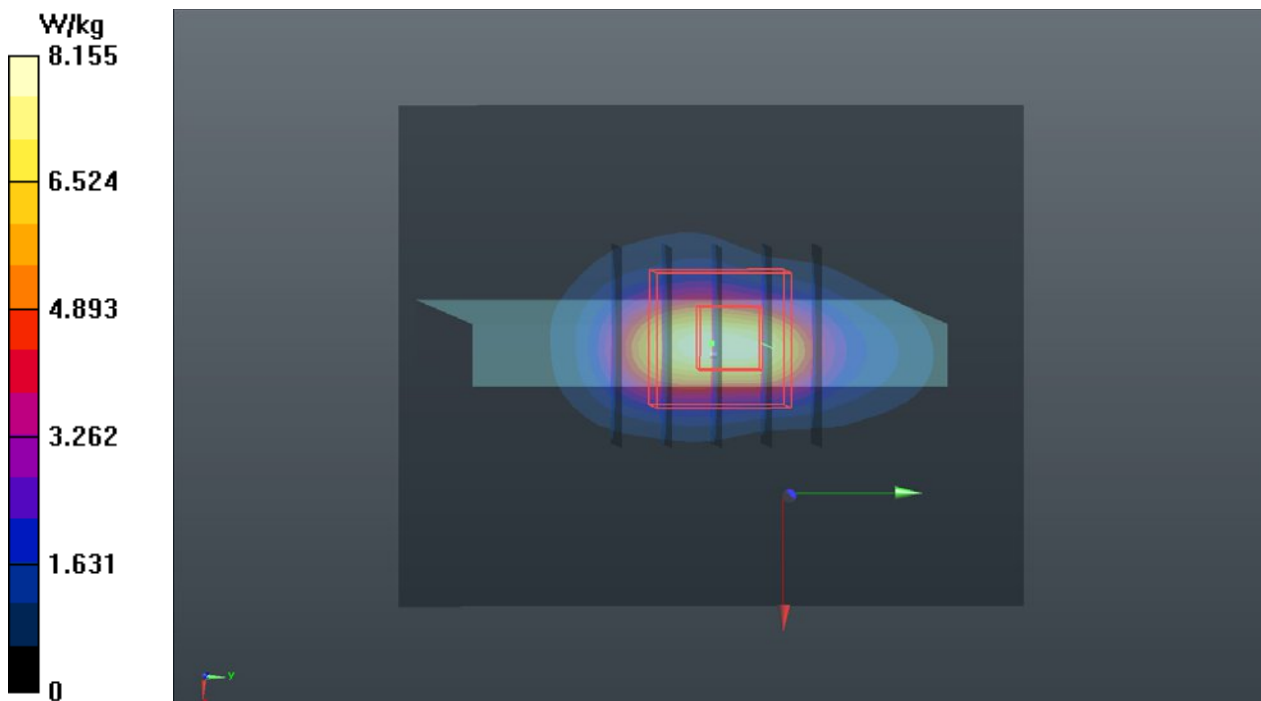

P42 WCDMA II_RMC12.2K_Bottom Side_0mm_Ch9262_Ant0_Sensor ON

DUT: 190827C07

Communication System: WCDMA; Frequency: 1852.4 MHz; Duty Cycle: 1:1
Medium: H16T20N1_0912 Medium parameters used: $f = 1852.4$ MHz; $\sigma = 1.411$ S/m; $\epsilon_r = 38.59$; $\rho = 1000$ kg/m³
Ambient Temperature : 23.8 °C ; Liquid Temperature : 23.2 °C

DASY5 Configuration:

- Probe: EX3DV4 - SN7375; ConvF(8.26, 8.26, 8.26); Calibrated: 2018/12/13
- Sensor-Surface: 1.4mm (Mechanical Surface Detection)
- Electronics: DAE4 Sn1277; Calibrated: 2019/01/24
- Phantom: Twin SAM Phantom_1823; Type: QD000P40CD;
- Measurement SW: DASY52, Version 52.10 (2); SEMCAD X Version 14.6.12 (7470)

- **Area Scan (61x71x1):** Interpolated grid: dx=1.500 mm, dy=1.500 mm
Maximum value of SAR (interpolated) = 7.89 W/kg

- **Zoom Scan (5x5x7)/Cube 0:** Measurement grid: dx=8mm, dy=8mm, dz=5mm
Reference Value = 72.65 V/m; Power Drift = 0.15 dB
Peak SAR (extrapolated) = 10.7 W/kg
SAR(1 g) = 4.66 W/kg; SAR(10 g) = 2.1 W/kg
Maximum value of SAR (measured) = 8.71 W/kg

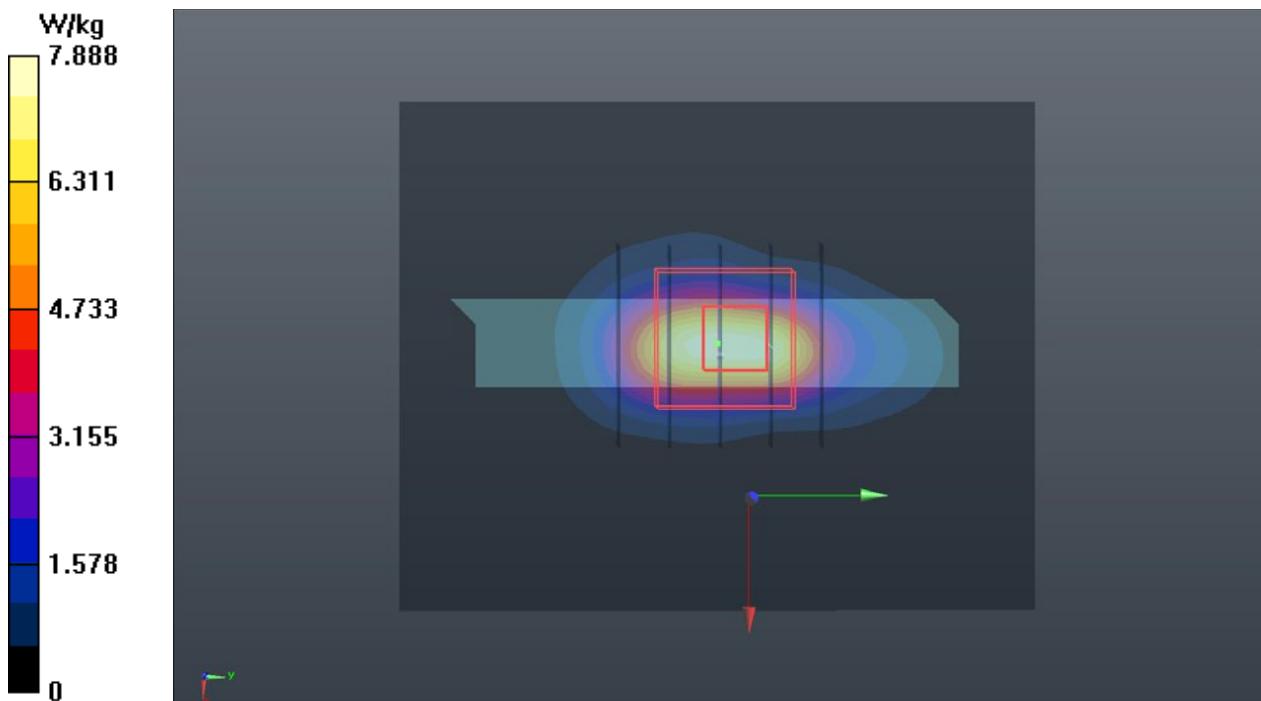

P43 WCDMA IV_RMC12.2K_Bottom Side_0mm_Ch1513_Ant0_Sensor ON

DUT: 190827C07

Communication System: WCDMA; Frequency: 1752.6 MHz; Duty Cycle: 1:1
Medium: H16T20N1_0912 Medium parameters used: $f = 1753$ MHz; $\sigma = 1.326$ S/m; $\epsilon_r = 38.961$; $\rho = 1000$ kg/m³
Ambient Temperature : 23.8 °C ; Liquid Temperature : 23.2 °C

DASY5 Configuration:

- Probe: EX3DV4 - SN7375; ConvF(8.58, 8.58, 8.58); Calibrated: 2018/12/13
- Sensor-Surface: 1.4mm (Mechanical Surface Detection)
- Electronics: DAE4 Sn1277; Calibrated: 2019/01/24
- Phantom: Twin SAM Phantom_1823; Type: QD000P40CD;
- Measurement SW: DASY52, Version 52.10 (2); SEMCAD X Version 14.6.12 (7470)

- **Area Scan (61x71x1):** Interpolated grid: dx=1.500 mm, dy=1.500 mm
Maximum value of SAR (interpolated) = 11.7 W/kg

- **Zoom Scan (5x5x7)/Cube 0:** Measurement grid: dx=8mm, dy=8mm, dz=5mm
Reference Value = 87.58 V/m; Power Drift = 0.06 dB
Peak SAR (extrapolated) = 13.6 W/kg
SAR(1 g) = 6.27 W/kg; SAR(10 g) = 2.82 W/kg
Maximum value of SAR (measured) = 11.2 W/kg

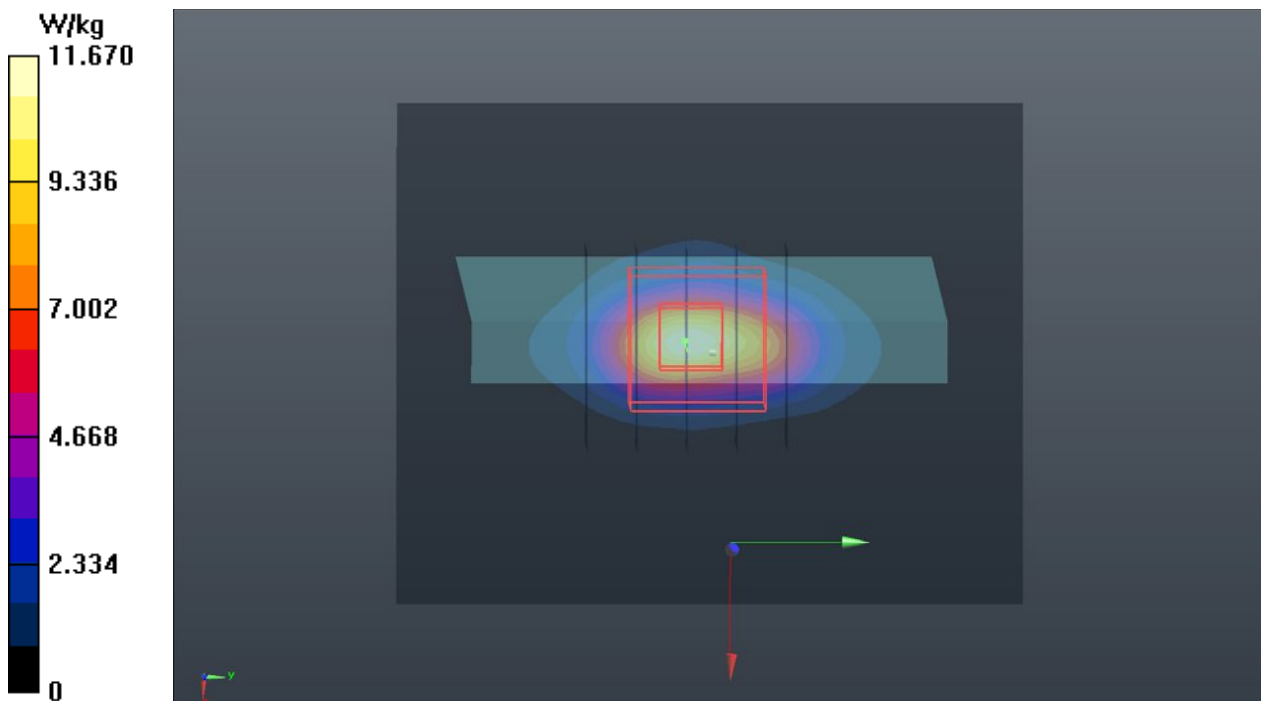

P44 LTE 2_QPSK20M_Bottom Side_0mm_Ch18700_1RB_OS0_Ant0_Sensor ON

DUT: 190827C07

Communication System: LTE; Frequency: 1860 MHz; Duty Cycle: 1:1

Medium: H16T20N1_0912 Medium parameters used: $f = 1860$ MHz; $\sigma = 1.418$ S/m; $\epsilon_r = 38.559$; $\rho = 1000$ kg/m³

Ambient Temperature : 23.8 °C ; Liquid Temperature : 23.2 °C

DASY5 Configuration:

- Probe: EX3DV4 - SN7375; ConvF(8.26, 8.26, 8.26); Calibrated: 2018/12/13
- Sensor-Surface: 1.4mm (Mechanical Surface Detection)
- Electronics: DAE4 Sn1277; Calibrated: 2019/01/24
- Phantom: Twin SAM Phantom_1823; Type: QD000P40CD;
- Measurement SW: DASY52, Version 52.10 (2); SEMCAD X Version 14.6.12 (7470)

- **Area Scan (61x71x1):** Interpolated grid: dx=1.500 mm, dy=1.500 mm
Maximum value of SAR (interpolated) = 7.79 W/kg

- **Zoom Scan (5x5x7)/Cube 0:** Measurement grid: dx=8mm, dy=8mm, dz=5mm

Reference Value = 72.20 V/m; Power Drift = 0.16 dB

Peak SAR (extrapolated) = 10.3 W/kg

SAR(1 g) = 4.59 W/kg; SAR(10 g) = 2.09 W/kg

Maximum value of SAR (measured) = 8.35 W/kg

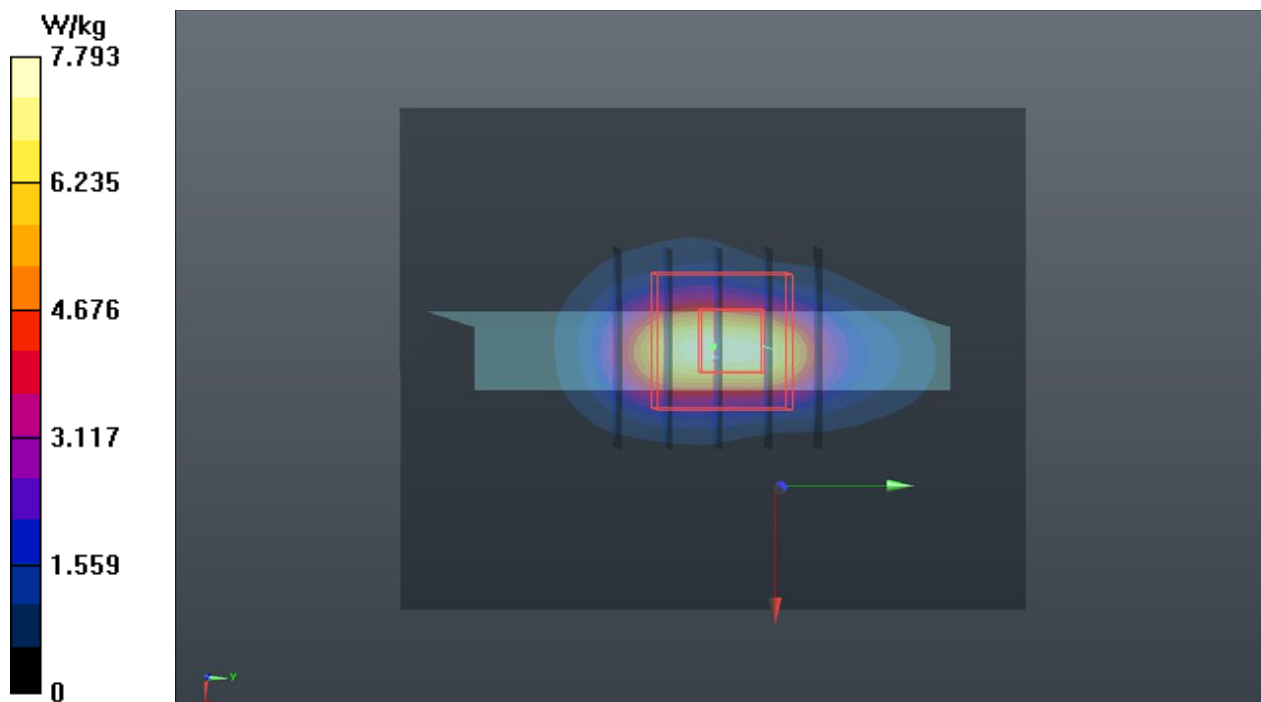

P45 LTE 4_QPSK20M_Bottom Side_0mm_Ch20300_1RB_OS0_Ant0_Sensor ON

DUT: 190827C07

Communication System: LTE; Frequency: 1745 MHz; Duty Cycle: 1:1
Medium: H16T20N1_0912 Medium parameters used: $f = 1745 \text{ MHz}$; $\sigma = 1.318 \text{ S/m}$; $\epsilon_r = 38.993$; $\rho = 1000 \text{ kg/m}^3$
Ambient Temperature : $23.8 \text{ }^\circ\text{C}$; Liquid Temperature : $23.2 \text{ }^\circ\text{C}$

DASY5 Configuration:

- Probe: EX3DV4 - SN7375; ConvF(8.58, 8.58, 8.58); Calibrated: 2018/12/13
- Sensor-Surface: 1.4mm (Mechanical Surface Detection)
- Electronics: DAE4 Sn1277; Calibrated: 2019/01/24
- Phantom: Twin SAM Phantom_1823; Type: QD000P40CD;
- Measurement SW: DASY52, Version 52.10 (2); SEMCAD X Version 14.6.12 (7470)

- **Area Scan (61x71x1):** Interpolated grid: $dx=1.500 \text{ mm}$, $dy=1.500 \text{ mm}$
Maximum value of SAR (interpolated) = 8.26 W/kg

- **Zoom Scan (5x5x7)/Cube 0:** Measurement grid: $dx=8\text{mm}$, $dy=8\text{mm}$, $dz=5\text{mm}$
Reference Value = 73.23 V/m ; Power Drift = 0.08 dB
Peak SAR (extrapolated) = 9.20 W/kg
SAR(1 g) = 4.36 W/kg ; SAR(10 g) = 1.98 W/kg
Maximum value of SAR (measured) = 7.59 W/kg

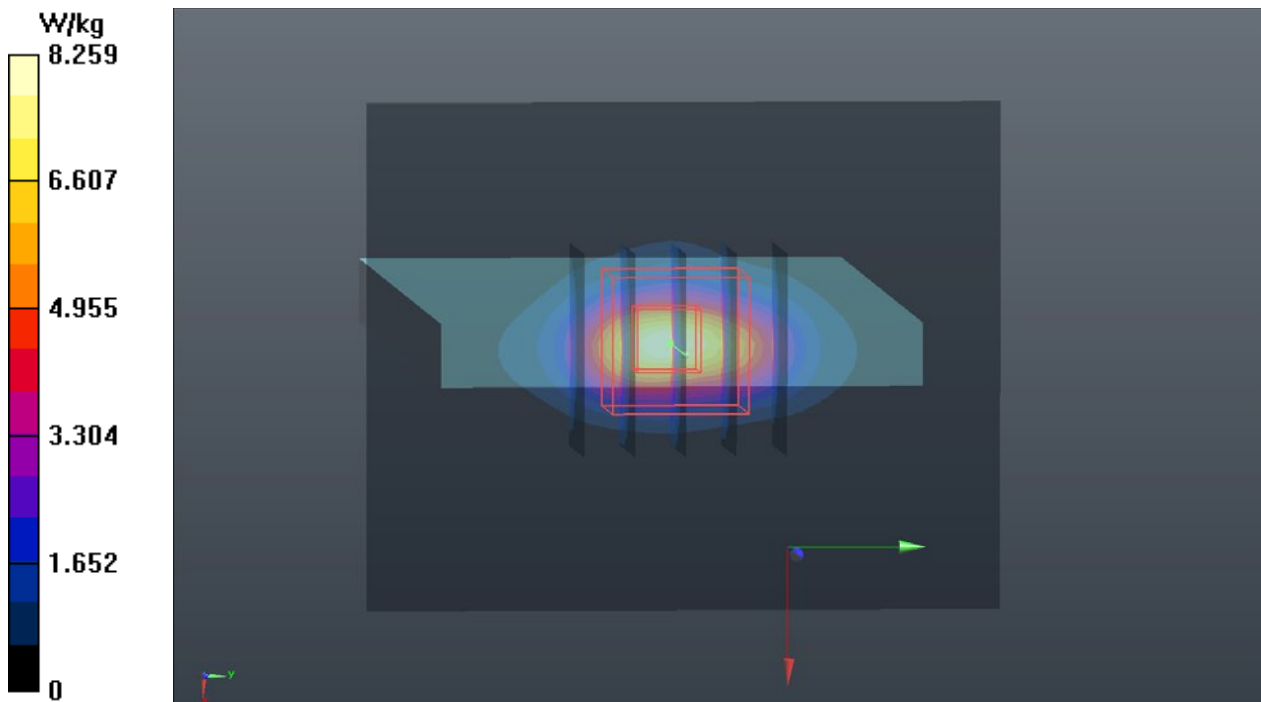

P46 LTE 7_QPSK20M_Rear Face_0mm_Ch21100_1RB_OS0_Ant0_Sensor ON

DUT: 190827C07

Communication System: LTE; Frequency: 2535 MHz; Duty Cycle: 1:1

Medium: H19T27N1_0914 Medium parameters used: $f = 2535$ MHz; $\sigma = 1.914$ S/m; $\epsilon_r = 38.292$; $\rho = 1000$ kg/m³

Ambient Temperature : 23.6 °C ; Liquid Temperature : 23.3 °C

DASY5 Configuration:

- Probe: EX3DV4 - SN7537; ConvF(7.19, 7.19, 7.19); Calibrated: 2019/06/18
- Sensor-Surface: 1.4mm (Mechanical Surface Detection)
- Electronics: DAE4 Sn1585; Calibrated: 2019/06/07
- Phantom: SAM Phantom_1982; Type: QD 000 P41 Ax; Serial: 1982
- Measurement SW: DASY52, Version 52.10 (2); SEMCAD X Version 14.6.12 (7470)

- **Area Scan (101x171x1):** Interpolated grid: dx=1.200 mm, dy=1.200 mm
Maximum value of SAR (interpolated) = 5.94 W/kg

- **Zoom Scan (5x5x7)/Cube 0:** Measurement grid: dx=8mm, dy=8mm, dz=5mm
Reference Value = 43.35 V/m; Power Drift = 0.01 dB
Peak SAR (extrapolated) = 17.7 W/kg
SAR(1 g) = 6.25 W/kg; SAR(10 g) = 2.31 W/kg
Maximum value of SAR (measured) = 12.0 W/kg

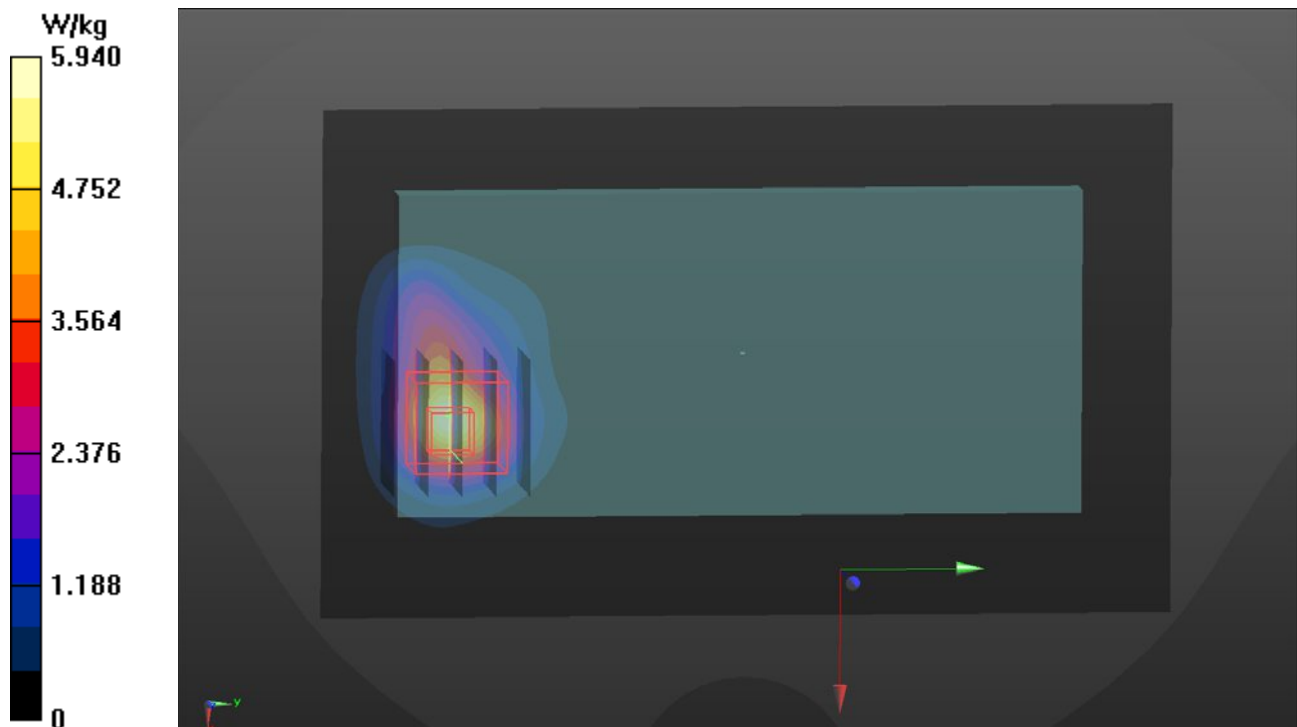

P47 WLAN5.3G_802.11a_Top Side_0mm_Ch60_Ant0

DUT: 190827C07

Communication System: WLAN_5G; Frequency: 5300 MHz; Duty Cycle: 1:1.02

Medium: H34T60N1_0908 Medium parameters used: $f = 5300$ MHz; $\sigma = 4.805$ S/m; $\epsilon_r = 36.763$; $\rho = 1000$ kg/m³

Ambient Temperature : 23.4 °C ; Liquid Temperature : 23.2 °C

DASY5 Configuration:

- Probe: EX3DV4 - SN7537; ConvF(5.36, 5.36, 5.36); Calibrated: 2019/06/18
- Sensor-Surface: 1.4mm (Mechanical Surface Detection)
- Electronics: DAE4 Sn1585; Calibrated: 2019/06/07
- Phantom: SAM Phantom_1982; Type: QD 000 P41 Ax; Serial: 1982
- Measurement SW: DASY52, Version 52.10 (2); SEMCAD X Version 14.6.12 (7470)

- **Area Scan (61x141x1)**: Interpolated grid: dx=1.000 mm, dy=1.000 mm
Maximum value of SAR (interpolated) = 2.22 W/kg

- **Zoom Scan (6x6x12)/Cube 0**: Measurement grid: dx=5mm, dy=5mm, dz=2mm
Reference Value = 23.29 V/m; Power Drift = -0.03 dB
Peak SAR (extrapolated) = 9.06 W/kg
SAR(1 g) = 1.98 W/kg; SAR(10 g) = 0.458 W/kg
Maximum value of SAR (measured) = 4.83 W/kg

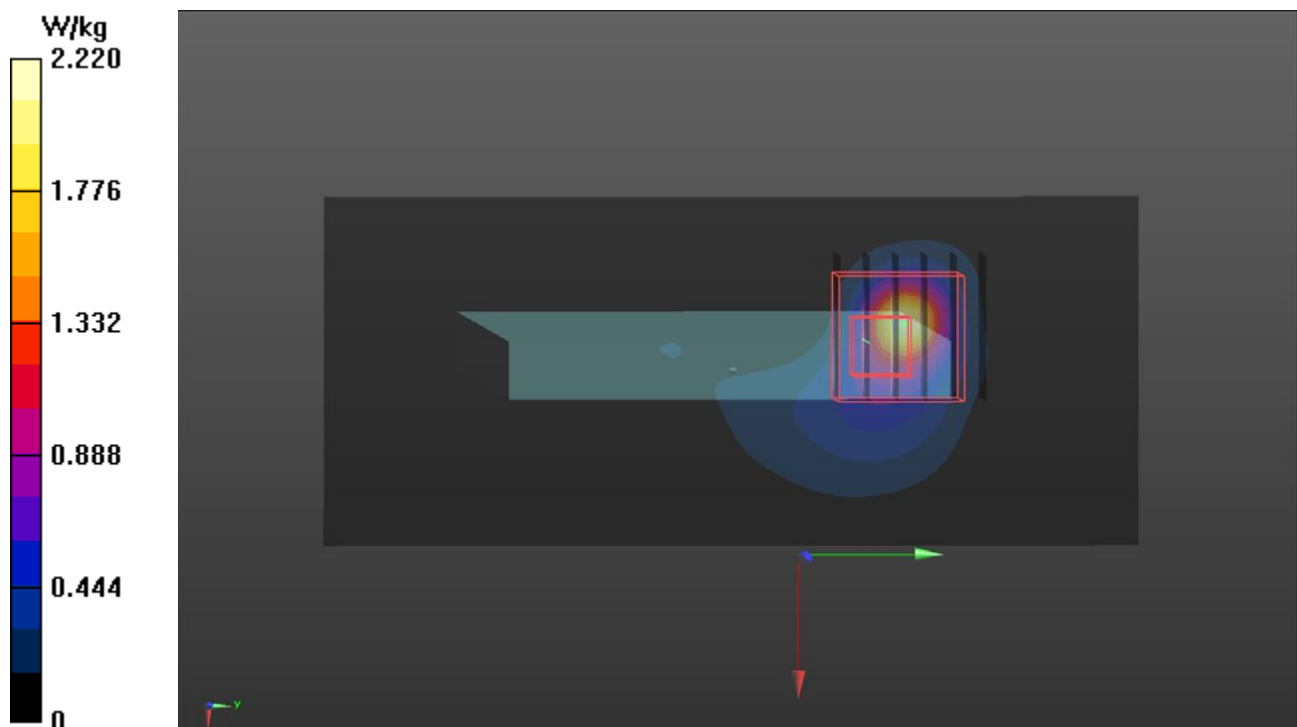

P48 WLAN5.6G_802.11a_Top Side_0mm_Ch116_Ant0

DUT: 190827C07

Communication System: WLAN_5G; Frequency: 5580 MHz; Duty Cycle: 1:1.02

Medium: H34T60N1_0908 Medium parameters used: $f = 5580$ MHz; $\sigma = 5.148$ S/m; $\epsilon_r = 36.136$; $\rho = 1000$ kg/m³

Ambient Temperature : 23.4 °C ; Liquid Temperature : 23.2 °C

DASY5 Configuration:

- Probe: EX3DV4 - SN7537; ConvF(4.75, 4.75, 4.75); Calibrated: 2019/06/18
- Sensor-Surface: 1.4mm (Mechanical Surface Detection)
- Electronics: DAE4 Sn1585; Calibrated: 2019/06/07
- Phantom: SAM Phantom_1982; Type: QD 000 P41 Ax; Serial: 1982
- Measurement SW: DASY52, Version 52.10 (2); SEMCAD X Version 14.6.12 (7470)

- **Area Scan (61x141x1)**: Interpolated grid: dx=1.000 mm, dy=1.000 mm
Maximum value of SAR (interpolated) = 1.69 W/kg

- **Zoom Scan (6x6x12)/Cube 0**: Measurement grid: dx=5mm, dy=5mm, dz=2mm
Reference Value = 19.56 V/m; Power Drift = 0.10 dB
Peak SAR (extrapolated) = 8.66 W/kg
SAR(1 g) = 1.74 W/kg; SAR(10 g) = 0.374 W/kg
Maximum value of SAR (measured) = 4.96 W/kg

