

# FCC TEST REPORT

## (Part 15, Subpart E)

Applicant:	Xiaomi Communications Co., Ltd.
Address:	The Rainbow City of China Resources, NO.68, Qinghe Middle Street, Haidian District, Beijing, China

Manufacturer or Supplier:	Xiaomi Communications Co., Ltd.
Address:	The Rainbow City of China Resources, NO.68, Qinghe Middle Street, Haidian District, Beijing, China
Product:	Mobile Phone
Brand Name:	Redmi
Model Name:	M1908C3XG
FCC ID:	2AFZZC3XG
Date of tests:	Aug. 24, 2019 ~ Sep. 17, 2019

The tests have been carried out according to the requirements of the following standard:

**FCC Part 15, Subpart E, Section 15.407**

**CONCLUSION: The submitted sample was found to COMPLY with the test requirement**

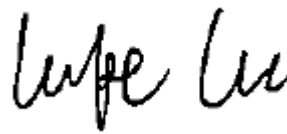
Prepared by Alex Chen Engineer / Mobile Department	Approved by Luke Lu Manager / Mobile Department
 Date: Sep. 24, 2019	 Date: Sep. 24, 2019

This report is governed by, and incorporates by reference, CPS Conditions of Service as posted at the date of issuance of this report at <http://www.bureauveritas.com/home/about-us/our-business/cps/about-us/terms-conditions/> and is intended for your exclusive use. Any copying or replication of this report to or for any other person or entity, or use of our name or trademark, is permitted only with our prior written permission. This report sets forth our findings solely with respect to the test samples identified herein. The results set forth in this report are not indicative or representative of the quality or characteristics of the lot from which a test sample was taken or any similar or identical product unless specifically and expressly noted. Our report includes all of the tests requested by you and the results thereof based upon the information that you provided to us. Measurement uncertainty is only provided upon request for accredited tests. You have 60 days from date of issuance of this report to notify us of any material error or omission caused by our negligence or if you require measurement uncertainty; provided, however, that such notice shall be in writing and shall specifically address the issue you wish to raise. A failure to raise such issue within the prescribed time shall constitute you unqualified acceptance of the completeness of this report, the tests conducted and the correctness of the report contents.



# TABLE OF CONTENTS

**RELEASE CONTROL RECORD ..... 4**

1 SUMMARY OF TEST RESULTS ..... 5

1.1 MEASUREMENT UNCERTAINTY ..... 5

2 GENERAL INFORMATION..... 6

2.1 GENERAL DESCRIPTION OF EUT ..... 6

2.2 DESCRIPTION OF TEST MODES ..... 8

    2.2.1 TEST MODE APPLICABILITY AND TESTED CHANNEL DETAIL..... 10

2.3 DUTY CYCLE OF TEST SIGNAL ..... 15

2.4 DESCRIPTION OF SUPPORT UNITS ..... 16

    2.4.1 CONFIGURATION OF SYSTEM UNDER TEST ..... 17

2.5 GENERAL DESCRIPTION OF APPLIED STANDARDS ..... 17

**3 TEST TYPES AND RESULTS..... 18**

3.1 RADIATED EMISSION AND BANDEDGE MEASUREMENT ..... 18

    3.1.1 LIMITS OF RADIATED EMISSION AND BANDEDGE MEASUREMENT..... 18

    3.1.2 LIMITS OF UNWANTED EMISSION..... 18

    3.1.3 TEST INSTRUMENTS..... 19

    3.1.4 TEST PROCEDURES ..... 20

    3.1.5 DEVIATION FROM TEST STANDARD ..... 20

    3.1.6 TEST SETUP ..... 21

    3.1.7 EUT OPERATING CONDITION ..... 22

    3.1.8 TEST RESULTS ..... 23

3.2 CONDUCTED EMISSION MEASUREMENT ..... 75

    3.2.1 LIMITS OF CONDUCTED EMISSION MEASUREMENT ..... 75

    3.2.2 TEST INSTRUMENTS..... 75

    3.2.3 TEST PROCEDURES ..... 75

    3.2.4 DEVIATION FROM TEST STANDARD ..... 76

    3.2.5 TEST SETUP ..... 76

    3.2.6 EUT OPERATING CONDITIONS ..... 76

    3.2.7 TEST RESULTS ..... 77

3.3 MAXIMUM CONDUCTED OUTPUT POWER MEASUREMENT ..... 79

    3.3.1 LIMITS OF MAXIMUM CONDUCTED OUTPUT POWER MEASUREMENT ..... 79

    3.3.2 TEST SETUP ..... 80

    3.3.3 TEST INSTRUMENTS..... 80



3.3.4	TEST PROCEDURE .....	81
3.3.5	DEVIATION FROM TEST STANDARD .....	83
3.3.6	EUT OPERATING CONDITIONS .....	83
3.3.7	TEST RESULTS .....	84
3.4	MAXIMUM POWER SPECTRAL DENSITY MEASUREMENT.....	98
3.4.1	LIMITS OF MAXIMUM POWER SPECTRAL DENSITY MEASUREMENT .....	98
3.4.2	TEST SETUP .....	98
3.4.3	TEST INSTRUMENTS.....	98
3.4.4	TEST PROCEDURES .....	99
3.4.5	DEVIATION FROM TEST STANDARD .....	99
3.4.6	EUT OPERATING CONDITIONS .....	99
3.4.7	TEST RESULTS .....	100
<b>4</b>	<b>PHOTOGRAPHS OF THE TEST CONFIGURATION .....</b>	<b>108</b>
<b>5</b>	<b>APPENDIX A – MODIFICATIONS RECORDERS FOR ENGINEERING CHANGES TO THE EUT BY THE LAB .....</b>	<b>109</b>



Test Report No.: RF190823W003-3

## RELEASE CONTROL RECORD

ISSUE NO.	REASON FOR CHANGE	DATE ISSUED
RF190823W003-3	Original release	Sep. 24, 2019



# 1 SUMMARY OF TEST RESULTS

The EUT has been tested according to the following specifications:

APPLIED STANDARD: FCC PART 15, SUBPART E		
STANDARD SECTION	TEST TYPE AND LIMIT	RESULT
15.407(b)(6)	AC Power Conducted Emission	Compliance
15.407(b) (1/2/3/4/5)	Radiated Emission & Band Edge Measurement	Compliance
15.407(a/1/2/3)	Maximum conducted output Power	Compliance
15.407(a/1/2/3)	Peak Power Spectral Density	Compliance
15.403(i)	26 dB Bandwidth	Compliance
15.407(e)	6 dB Bandwidth	Compliance
15.203	Antenna Requirement	Compliance

## 1.1 MEASUREMENT UNCERTAINTY

Where relevant, the following measurement uncertainty levels have been estimated for tests performed on the EUT as specified in CISPR 16-4-2:

MEASUREMENT	UNCERTAINTY
AC Power Conducted emissions	±2.70dB
Radiated emissions (30MHz~1GMHz)	±4.98dB
Radiated emissions (1GMHz ~6GMHz)	±4.70dB
Radiated emissions (6GMHz ~18GMHz)	±4.60dB
Radiated emissions (18GMHz ~40GMHz)	±4.12dB
Conducted emissions	±4.01dB
Occupied Channel Bandwidth	±43.58KHz
Conducted Output power	±2.06dB
Power Spectral Density	±0.85 dB

This uncertainty represents an expanded uncertainty expressed at approximately the 95% confidence level using a coverage factor of k = 2.



## 2 GENERAL INFORMATION

### 2.1 GENERAL DESCRIPTION OF EUT

<b>PRODUCT</b>	Mobile Phone
<b>BRAND NAME</b>	Redmi
<b>MODEL NAME</b>	M1908C3XG
<b>NOMINAL VOLTAGE</b>	5V/9V/12V (adapter or host equipment) 3.85Vdc (Li-ion, battery)
<b>MODULATION</b>	OFDM
<b>TRANSFER RATE</b>	802.11a: 54.0/ 48.0/ 36.0/ 24.0/ 18.0/ 12.0/ 9.0/ 6.0Mbps 802.11n: up to MCS7 802.11ac: up to 390.0Mbps
<b>OPERATING FREQUENCY</b>	5180 ~ 5240MHz, 5260 ~ 5320MHz, 5500 ~ 5720MHz, 5745 ~ 5805MHz
<b>NUMBER OF CHANNEL</b>	5180 ~ 5240MHz: 4 for 802.11a, 802.11n, 802.11ac (20MHz) 2 for 802.11n, 802.11ac (40MHz) 1 for 802.11ac (80MHz) 5260 ~ 5320MHz: 4 for 802.11a, 802.11n, 802.11ac (20MHz) 2 for 802.11n, 802.11ac (40MHz) 1 for 802.11ac (80MHz) 5500 ~ 5720MHz: 12 for 802.11a, 802.11n, 802.11ac(20MHz) 6 for 802.11n, 802.11ac (40MHz) 3 for 802.11ac (80MHz) 5745 ~ 5805MHz: 5 for 802.11a, 802.11n, 802.11ac (20MHz) 3 for 802.11n, 802.11ac (40MHz) 2 for 802.11ac (80MHz)
<b>AVERAGE POWER</b>	35.318mW for 5180 ~ 5240MHz 35.075mW for 5260 ~ 5320MHz 29.309mW for 5500 ~ 5720MHz 27.797mW for 5745 ~ 5805MHz
<b>ANTENNA TYPE</b>	5180 ~ 5240MHz: Fixed Internal Antenna with -2.02dBi gain 5260 ~ 5320MHz: Fixed Internal Antenna with -2dBi gain 5500 ~ 5720MHz: Fixed Internal Antenna with -1.14dBi gain 5745 ~ 5805MHz: Fixed Internal Antenna with -0.02dBi gain
<b>HW VERSION</b>	P2
<b>SW VERSION</b>	MIUI 10
<b>I/O PORTS</b>	Refer to user's manual



**NOTE:**

1. For a more detailed features description, please refer to the manufacturer’s specifications or the user's manual.
2. The EUT incorporates a SISO function. Physically, the EUT provides one completed transmitter and one receiver.

MODULATION MODE	TX FUNCTION
802.11a	1TX/1RX
802.11n/802.11ac (20MHz)	1TX/1RX
802.11n/802.11ac (40MHz)	1TX/1RX
802.11ac (80MHz)	1TX/1RX

3. For the test results, the EUT had been tested with all conditions. But only the worst case was shown in test report.
4. The device will automatically discontinue transmission in case of either absence of information to transmit or operational failure.

**List of Accessory:**

ACCESSORIES	BRAND	MODEL	MANUFACTURER	SPECIFICATION
AC Adapter	MI	MDY-10-ED	Chenyang	I/P: 100 - 240Vac,500mA, O/P: 5Vdc, 3000mA/9V,2A/12V,1.5A
Battery	MI	BN46	CosMX	Rating: 3.85Vdc, Min. 3900mAh,Typ.4000 mAh, Li-ion, Y
USB Cable 1	MI	L23312	LUXSHARE Precision Industry Co., Ltd.	1.0 meter, shielded cable, without ferrite core
USB Cable 2	MI	K23312	SU ZHOU KELI SCIENCE&TECHNOLOGY DEVELOPMENT CO.,LTD	1.0 meter, shielded cable, without ferrite core



## 2.2 DESCRIPTION OF TEST MODES

### FOR 5150 ~ 5250MHz

4 channels are provided for 802.11a, 802.11n, 802.11ac (20MHz):

CHANNEL	FREQUENCY	CHANNEL	FREQUENCY
36	5180 MHz	44	5220 MHz
40	5200 MHz	48	5240 MHz

2 channels are provided for 802.11n, 802.11ac (40MHz):

CHANNEL	FREQUENCY	CHANNEL	FREQUENCY
38	5190 MHz	46	5230 MHz

1 channel is provided for 802.11ac (80MHz):

CHANNEL	FREQUENCY	CHANNEL	FREQUENCY
42	5210 MHz		

### FOR 5250 ~ 5350MHz

4 channels are provided for 802.11a, 802.11n, 802.11ac (20MHz):

CHANNEL	FREQUENCY	CHANNEL	FREQUENCY
52	5260 MHz	60	5300 MHz
56	5280 MHz	64	5320 MHz

2 channels are provided for 802.11n, 802.11ac (40MHz):

CHANNEL	FREQUENCY	CHANNEL	FREQUENCY
54	5270 MHz	62	5310 MHz

1 channel is provided for 802.11ac (80MHz):

CHANNEL	FREQUENCY	CHANNEL	FREQUENCY
58	5290 MHz		





**FOR 5470 ~ 5725MHz**

12 channels are provided for 802.11a, 802.11n, 802.11ac (20MHz):

CHANNEL	FREQUENCY	CHANNEL	FREQUENCY
100	5500 MHz	124	5620MHz
104	5520 MHz	128	5640MHz
108	5540 MHz	132	5660 MHz
112	5560 MHz	136	5680 MHz
116	5580 MHz	140	5700 MHz
120	5600 MHz	144	5720MHz

6 channels are provided for 802.11n, 802.11ac (40MHz):

CHANNEL	FREQUENCY	CHANNEL	FREQUENCY
102	5510 MHz	126	5630MHz
110	5550 MHz	134	5670 MHz
118	5590 MHz	142	5710 MHz

3 channel is provided for 802.11ac (80MHz):

CHANNEL	FREQUENCY	CHANNEL	FREQUENCY
106	5530 MHz	138	5690 MHz
122	5610 MHz		

**FOR 5725 ~ 5850MHz**

5 channels are provided for 802.11a, 802.11n, 802.11ac (20MHz):

CHANNEL	FREQUENCY	CHANNEL	FREQUENCY
144	5720MHz	157	5785 MHz
149	5745 MHz	161	5805 MHz
153	5765 MHz		

3 channels are provided for 802.11n, 802.11ac (40MHz):

CHANNEL	FREQUENCY	CHANNEL	FREQUENCY
142	5710 MHz	159	5795 MHz
151	5755 MHz		

2 channel is provided for 802.11ac (80MHz):

CHANNEL	FREQUENCY	CHANNEL	FREQUENCY
138	5690 MHz	155	5775 MHz



## 2.2.1 TEST MODE APPLICABILITY AND TESTED CHANNEL DETAIL

EUT CONFIGURE MODE	APPLICABLE TO				DESCRIPTION
	RE≥1G	RE<1G	PLC	APCM	
A	√	√	√	-	Powered by Adapter with wifi(5G) link
B	-	-	-	√	Powered by Battery with wifi(5G) link
C	-	-	-	-	Powered by USB with wifi(5G) link

Where

**RE≥1G:** Radiated Emission above 1GHz

**RE<1G:** Radiated Emission below 1GHz

**PLC:** Power Line Conducted Emission

**APCM:** Antenna Port Conducted Measurement

**NOTE:**

The EUT had been pre-tested on the positioned of each 3 axis. The worst case was found when positioned on **X-plane**.

**NOTE:** "-" means no effect.



**RADIATED EMISSION TEST (ABOVE 1GHz):**

- Pre-Scan has been conducted to determine the worst-case mode from all possible combinations between available modulations, data rates and antenna ports (if EUT with antenna diversity architecture).
- Following channel(s) was (were) selected for the final test as listed below.

EUT CONFIGURE MODE	MODE	FREQ. BAND (MHz)	AVAILABLE CHANNEL	TESTED CHANNEL	MODULATION	DATA RATE (Mbps)
A	802.11a	5180-5240	36 to 48	36, 40, 48	OFDM	6.0
A	802.11n (20MHz)		36 to 48	36, 40, 48	OFDM	MCS0
A	802.11n (40MHz)		38 to 46	38, 46	OFDM	MCS0
A	802.11ac (80MHz)		42	42	OFDM	MCS0
A	802.11a	5260-5320	52 to 64	52, 60, 64	OFDM	6.0
A	802.11n (20MHz)		52 to 64	52, 60, 64	OFDM	MCS0
A	802.11n (40MHz)		54 to 62	54, 62	OFDM	MCS0
A	802.11ac (80MHz)		58	58	OFDM	MCS0
A	802.11a	5500-5720	100 to 144	100, 116, 140, 144	OFDM	6.0
A	802.11n (20MHz)		100 to 144	100, 116, 140, 144	OFDM	MCS0
A	802.11n (40MHz)		102 to 142	102, 110, 134, 142	OFDM	MCS0
A	802.11ac (80MHz)		106 to 138	106, 138	OFDM	MCS0
A	802.11a	5745-5805	144 to 161	144, 149, 157,161	OFDM	6.0
A	802.11n (20MHz)		144 to 161	144, 149, 157,161	OFDM	MCS0
A	802.11n (40MHz)		142 to 159	142, 151, 159	OFDM	MCS0
A	802.11ac (80MHz)		138 to 155	138, 155	OFDM	MCS0



**RADIATED EMISSION TEST (BELOW 1GHz):**

- Pre-Scan has been conducted to determine the worst-case mode from all possible combinations between available modulations, data rates and antenna ports (if EUT with antenna diversity architecture).
- Following channel(s) was (were) selected for the final test as listed below.

EUT CONFIGURE MODE	MODE	FREQ. BAND (MHz)	AVAILABLE CHANNEL	TESTED CHANNEL	MODULATION	DATA RATE (Mbps)
A	802.11n40	5180-5240	38 to 46	38	OFDM	MCS0

**POWER LINE CONDUCTED EMISSION TEST:**

- Pre-Scan has been conducted to determine the worst-case mode from all possible combinations between available modulations, data rates and antenna ports (if EUT with antenna diversity architecture).
- Following channel(s) was (were) selected for the final test as listed below.

EUT CONFIGURE MODE	MODE	FREQ. BAND (MHz)	AVAILABLE CHANNEL	TESTED CHANNEL	MODULATION	DATA RATE (Mbps)
A	802.11n40	5180-5240	38 to 46	38	OFDM	MCS0



**BANDEDGE MEASUREMENT:**

- Pre-Scan has been conducted to determine the worst-case mode from all possible combinations between available modulations, data rates and antenna ports (if EUT with antenna diversity architecture).
- Following channel(s) was (were) selected for the final test as listed below.

EUT CONFIGURE MODE	MODE	FREQ. BAND (MHz)	AVAILABLE CHANNEL	TESTED CHANNEL	MODULATION	DATA RATE (Mbps)
A	802.11a	5180-5240	36 to 48	36, 48	OFDM	6.0
A	802.11n (20MHz)		36 to 48	36, 48	OFDM	MCS0
A	802.11n (40MHz)		38 to 46	38, 46	OFDM	MCS0
A	802.11ac (80MHz)		42	42	OFDM	MCS0
A	802.11a	5260-5320	52 to 64	52, 64	OFDM	6.0
A	802.11n (20MHz)		52 to 64	52, 64	OFDM	MCS0
A	802.11n (40MHz)		54 to 62	54, 62	OFDM	MCS0
A	802.11ac (80MHz)		58	58	OFDM	MCS0
A	802.11a	5500-5720	100 to 144	100, 116, 140, 144	OFDM	6.0
A	802.11n (20MHz)		100 to 144	100, 116, 140, 144	OFDM	MCS0
A	802.11n (40MHz)		102 to 142	102, 110, 134, 142	OFDM	MCS0
A	802.11ac (80MHz)		106 to 138	106, 138	OFDM	MCS0
A	802.11a	5745-5805	144 to 161	144, 149, 157,161	OFDM	6.0
A	802.11n (20MHz)		144 to 161	144, 149, 157,161	OFDM	MCS0
A	802.11n (40MHz)		142 to 159	142, 151, 159	OFDM	MCS0
A	802.11ac (80MHz)		138 to 155	138, 155	OFDM	MCS0



**ANTENNA PORT CONDUCTED MEASUREMENT:**

- This item includes all test value of each mode, but only includes spectrum plot of worst value of each mode.
- Pre-Scan has been conducted to determine the worst-case mode from all possible combinations between available modulations, data rates and antenna ports (if EUT with antenna diversity architecture).
- Following channel(s) was (were) selected for the final test as listed below.

EUT CONFIGURE MODE	MODE	FREQ. BAND (MHz)	AVAILABLE CHANNEL	TESTED CHANNEL	MODULATION TECHNOLOGY	DATA RATE (Mbps)
B	802.11a	5180-5240	36 to 48	36, 40, 48	OFDM	6.0
B	802.11n (20MHz)		36 to 48	36, 40, 48	OFDM	MCS0
B	802.11n (40MHz)		38 to 46	38, 46	OFDM	MCS0
B	802.11ac (80MHz)		42	42	OFDM	MCS0
B	802.11a	5260-5320	52 to 64	52, 60, 64	OFDM	6.0
B	802.11n (20MHz)		52 to 64	52, 60, 64	OFDM	MCS0
B	802.11n (40MHz)		54 to 62	54, 62	OFDM	MCS0
B	802.11ac (80MHz)		58	58	OFDM	MCS0
B	802.11a	5500-5720	100 to 144	100, 116, 140, 144	OFDM	6.0
B	802.11n (20MHz)		100 to 144	100, 116, 140, 144	OFDM	MCS0
B	802.11n (40MHz)		102 to 142	102, 110, 134, 142	OFDM	MCS0
B	802.11ac (80MHz)		106 to 138	106, 138	OFDM	MCS0
B	802.11a	5745-5805	144 to 161	144, 149, 157,161	OFDM	6.0
B	802.11n (20MHz)		144 to 161	144, 149, 157,161	OFDM	MCS0
B	802.11n (40MHz)		142 to 159	142, 151, 159	OFDM	MCS0
B	802.11ac (80MHz)		138 to 155	138, 155	OFDM	MCS0

**TEST CONDITION:**

APPLICABLE TO	ENVIRONMENTAL CONDITIONS	INPUT POWER	TESTED BY
RE<1G	23deg. C, 70%RH	DC 5/9/12V By Adapter	Star Le
RE≥1G	23deg. C, 70%RH	DC 5/9/12V By Adapter	Star Le
PLC	25deg. C, 52%RH	DC 5/9/12V By Adapter	Jimmy Liu
APCM	25deg. C, 60%RH	DC 3.85V from battery	Kevin Zhang



### 2.3 DUTY CYCLE OF TEST SIGNAL

Duty cycle of test signal is < 98%, duty factor shall be considered.

**802.11a:** Duty cycle = 2.025/2.066 = 0.980, duty factor shall not be considered.

**802.11n (20MHz):** Duty cycle = 1.886/1.925 = 0.980, duty factor shall not be considered.

**802.11n (40MHz):** Duty cycle = 0.925/0.973 = 0.951, Duty factor = 10 \* log(1/ 0.951) = 0.220

**802.11ac (80MHz):** Duty cycle = 0.454/0.511 = 0.888, Duty factor = 10 \* log( 1/ 0.888) = 0.514

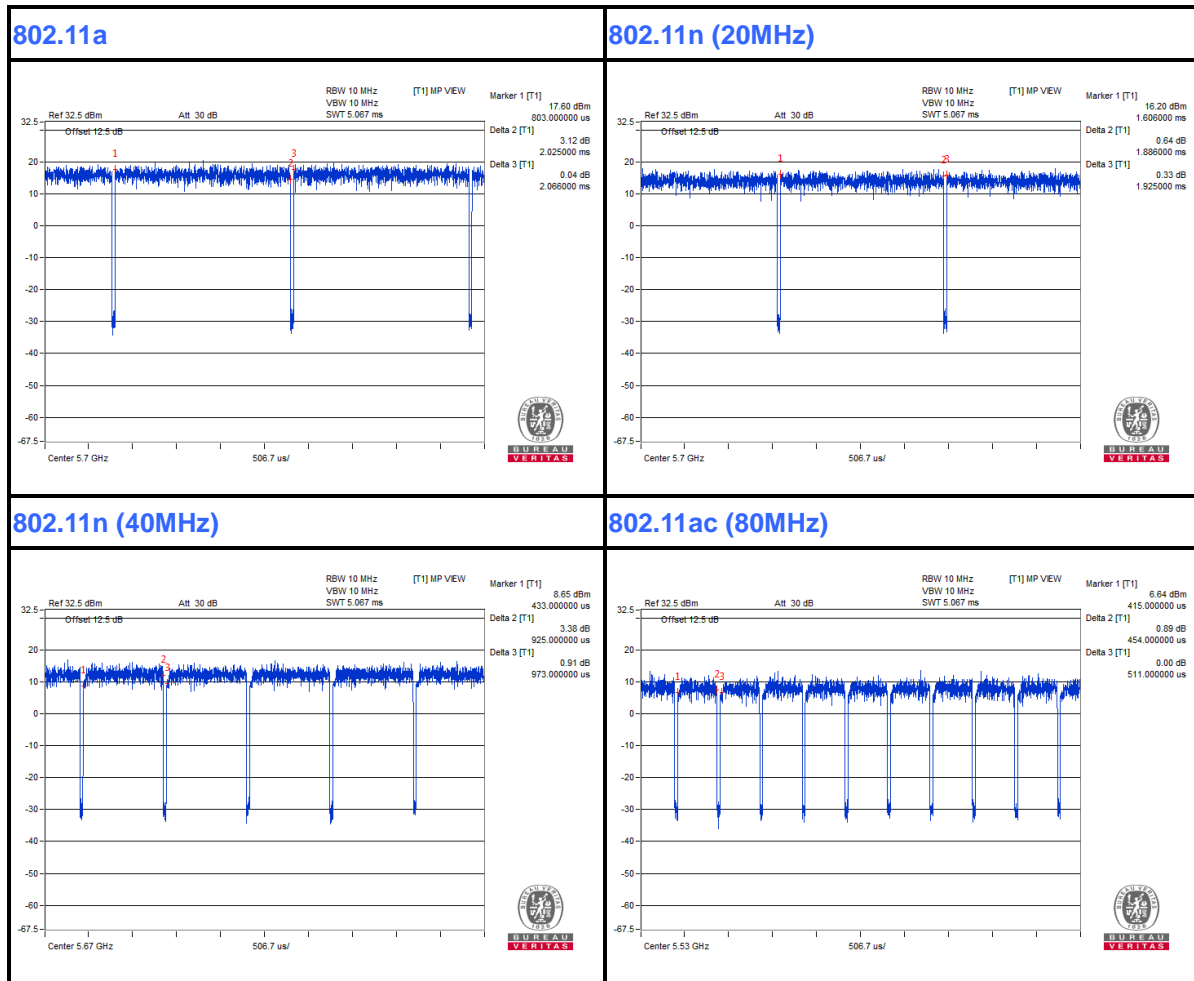



## 2.4 DESCRIPTION OF SUPPORT UNITS

The EUT has been tested as an independent unit together with other necessary accessories or support units. The following support units or accessories were used to form a representative test configuration during the tests.

NO.	PRODUCT	BRAND	MODEL NO.	SERIAL NO.	FCC ID
1	Desktop	Lenovo	M73 SFF	PC04GRQV	N/A
2	Desktop	Lenovo	M73 SFF	PC06CS27	N/A
3	Laptop	Lenovo	Thnikpad L440	R90FTFKN	N/A

NO.	SIGNAL CABLE DESCRIPTION OF THE ABOVE SUPPORT UNITS
1	AC Line: Unshielded, Detachable 1.5m
2	AC Line: Unshielded, Detachable 1.5m
3	AC Line: Unshielded, Detachable 1.5m





## 2.4.1 CONFIGURATION OF SYSTEM UNDER TEST

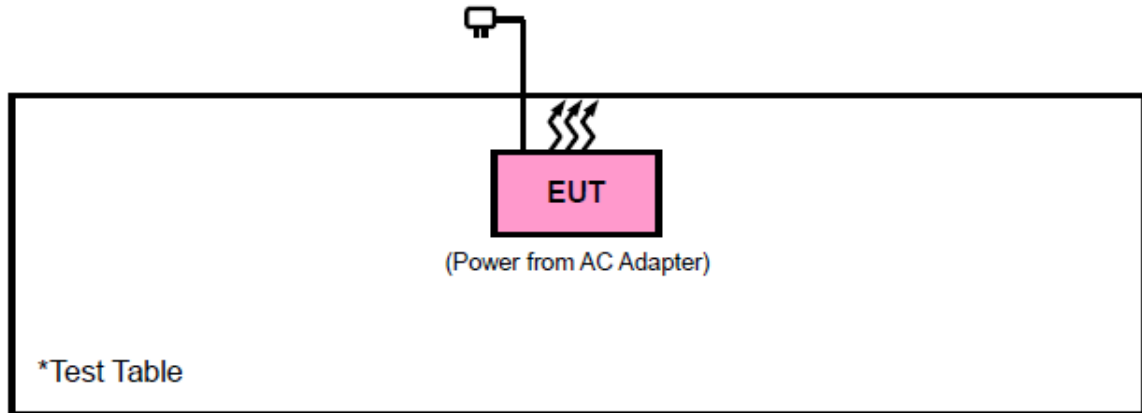

## 2.5 GENERAL DESCRIPTION OF APPLIED STANDARDS

The EUT is a RF Product. According to the specifications of the manufacturer, it must comply with the requirements of the following standards:

**FCC Part 15, Subpart E (15.407)**

**KDB 789033 D02 General U-NII Test Procedures New Rules v02r01**

ANSI C63.10-2013

All test items have been performed and recorded as per the above standards.

**NOTE:** The EUT is also considered as a kind of computer peripheral, because the connection to computer is necessary for typical use. It has been verified to comply with the requirements of FCC Part 15, Subpart B, Class B (Certification). The test report has been issued separately.



### 3 TEST TYPES AND RESULTS

#### 3.1 RADIATED EMISSION AND BANDEDGE MEASUREMENT

##### 3.1.1 LIMITS OF RADIATED EMISSION AND BANDEDGE MEASUREMENT

Radiated emissions which fall in the restricted bands must comply with the radiated emission limits specified as below table:

FREQUENCIES (MHz)	FIELD STRENGTH (microvolts/meter)	MEASUREMENT DISTANCE (meters)
0.009 ~ 0.490	2400/F(kHz)	300
0.490 ~ 1.705	24000/F(kHz)	30
1.705 ~ 30.0	30	30
30 ~ 88	100	3
88 ~ 216	150	3
216 ~ 960	200	3
Above 960	500	3

**NOTE:**

1. The lower limit shall apply at the transition frequencies.
2. Emission level (dBuV/m) = 20 log Emission level (uV/m).
3. For frequencies above 1000MHz, the field strength limits are based on average detector, however, the peak field strength of any emission shall not exceed the maximum permitted average limits, specified above by more than 20dB under any condition of modulation.

##### 3.1.2 LIMITS OF UNWANTED EMISSION

RESTRICTED BANDS	APPLICABLE TO	LIMIT	
	789033 D02 General UNII Test Procedures New Rules v02r01	FIELD STRENGTH AT 3m (dBµV/m)	
	PK : 74	AV : 54	
OUT OF THE RESTRICTED BANDS	APPLICABLE TO	EIRP LIMIT (dBm/MHz)	EQUIVALENT FIELD STRENGTH AT 3m (dBµV/m)
	15.407(b)(1)	PK : -27	PK : 68.3
	15.407(b)(2)		
	15.407(b)(3)		
15.407(b)(4)	See note 2 (FCC 16-24)		



**NOTE:** The following formula is used to convert the equipment isotropic radiated power (eirp) to field strength:

$$E = \frac{1000000}{3} \sqrt{30 P} \quad \mu\text{V/m, where P is the eirp (Watts).}$$

2. All emissions shall be limited to a level of -27 dBm/MHz at 75 MHz or more above or below the band edge increasing linearly to 10 dBm/MHz at 25 MHz above or below the band edge, and from 25 MHz above or below the band edge increasing linearly to a level of 15.6 dBm/MHz at 5 MHz above or below the band edge, and from 5 MHz above or below the band edge increasing linearly to a level of 27 dBm/MHz at the band edge.

### 3.1.3 TEST INSTRUMENTS

Equipment	Manufacturer	Model No.	Serial No.	Last Cal.	Next Cal.
3m Semi-anechoic Chamber	ETS-LINDGREN	9m*6m*6m	Euroshieldpn-CT0001143-1216	Feb. 26,19	Feb. 25,20
Bilog Antenna	ETS-LINDGREN	3143B	00161965	Feb. 26,19	Feb. 25,20
Horn Antenna	ETS-LINDGREN	3117	00168728	Feb. 26,19	Feb. 25,20
Horn Antenna (18GHz-40GHz)	N/A	QWH-SL-18-40-K-SG/QMS-00361	15433	Nov. 21, 18	Nov. 20, 19
Test Software	E3	V 9.160323	N/A	N/A	N/A
Test Software	ADT	ADT_Radiated_V7.6.15.9.2	N/A	N/A	N/A
10dB Attenuator	JFW/USA	50HF-010-SMA	1505	Jun. 24,19	Jun. 23,20
MXE EMI Receiver	KEYSIGHT	N9038A-544	MY54450026	Feb. 26,19	Feb. 25,20
Signal Pre-Amplifier	EMSI	EMC 9135	980249	Jun. 24,19	Jun. 23,20
Signal Pre-Amplifier	EMSI	EMC 012645B	980257	Jun. 24,19	Jun. 23,20
Signal Pre-Amplifier	EMSI	EMC 184045B	980259	Jun. 24,19	Jun. 23,20

**NOTE:**

1. The calibration interval of the above test instruments is 12 months and the calibrations are traceable to CEPREI/CHINA, GRGT/CHINA and NIM/CHINA.
2. The test was performed in 3m Chamber.
3. The FCC Site Registration No. is 525120; The Designation No. is CN1171.



### 3.1.4 TEST PROCEDURES

- a. The EUT was placed on the top of a rotating table 0.8 meters (for below 1GHz) / 1.5 meters (for above 1GHz) above the ground at 3 meter chamber room for test. The table was rotated 360 degrees to determine the position of the highest radiation.
- b. The EUT was set 3 meters away from the interference-receiving antenna, which was mounted on the top of a variable-height antenna tower.
- c. The antenna is a broadband antenna, and its height is varied from one meter to four meters above the ground to determine the maximum value of the field strength. Both horizontal and vertical polarizations of the antenna are set to make the measurement.
- d. For each suspected emission, the EUT was arranged to its worst case and then the antenna was tuned to heights from 1 meter to 4 meters and the rotatable table was turned from 0 degrees to 360 degrees to find the maximum reading.
- e. The test-receiver system was set to Peak Detect Function and Specified Bandwidth with Maximum Hold Mode.
- f. If the emission level of the EUT in peak mode was 10dB lower than the limit specified, then testing could be stopped and the peak values of the EUT would be reported. Otherwise the emissions that did not have 10dB margin would be re-tested one by one using peak, quasi-peak or average method as specified and then reported in a data sheet.

#### **NOTE:**

1. The resolution bandwidth and video bandwidth of test receiver/spectrum analyzer is 120kHz for Peak detection (PK) and Quasi-peak detection (QP) at frequency below 1GHz.
2. The resolution bandwidth of test receiver/spectrum analyzer is 1MHz and video bandwidth is 3MHz for Peak detection at frequency above 1GHz.
3. The resolution bandwidth of test receiver/spectrum analyzer is 1MHz and the video bandwidth is 3MHz for RMS Average (Duty cycle < 98%) for Average detection (AV) at frequency above 1GHz, then the measurement results was added to a correction factor (10 log(1/duty cycle)).
4. The resolution bandwidth of test receiver/spectrum analyzer is 1MHz and the video bandwidth is 10Hz (Duty cycle ≥ 98%) for Average detection (AV) at frequency above 1GHz.
5. All modes of operation were investigated and the worst-case emissions are reported.

### 3.1.5 DEVIATION FROM TEST STANDARD

No deviation.



### 3.1.6 TEST SETUP

#### < Frequency Range 30MHz~1GHz >

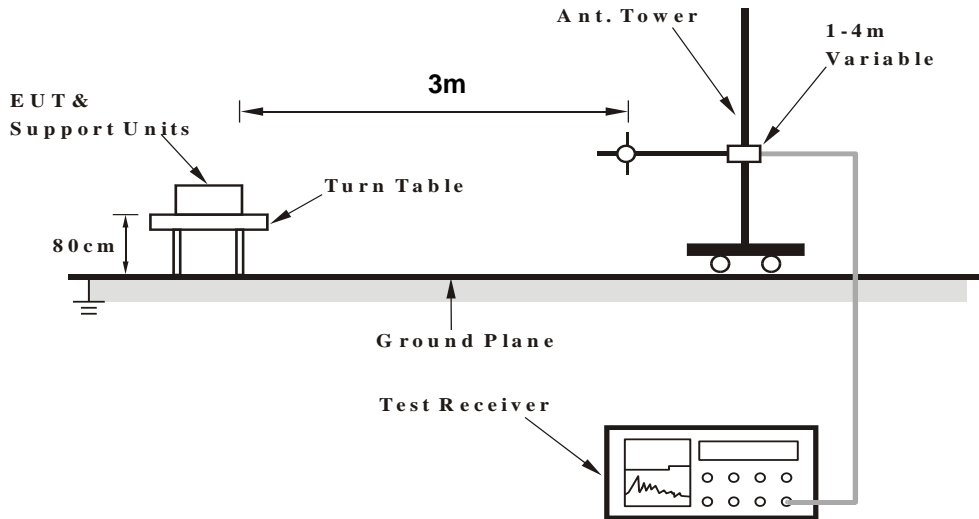

#### <Frequency Range above 1GHz>

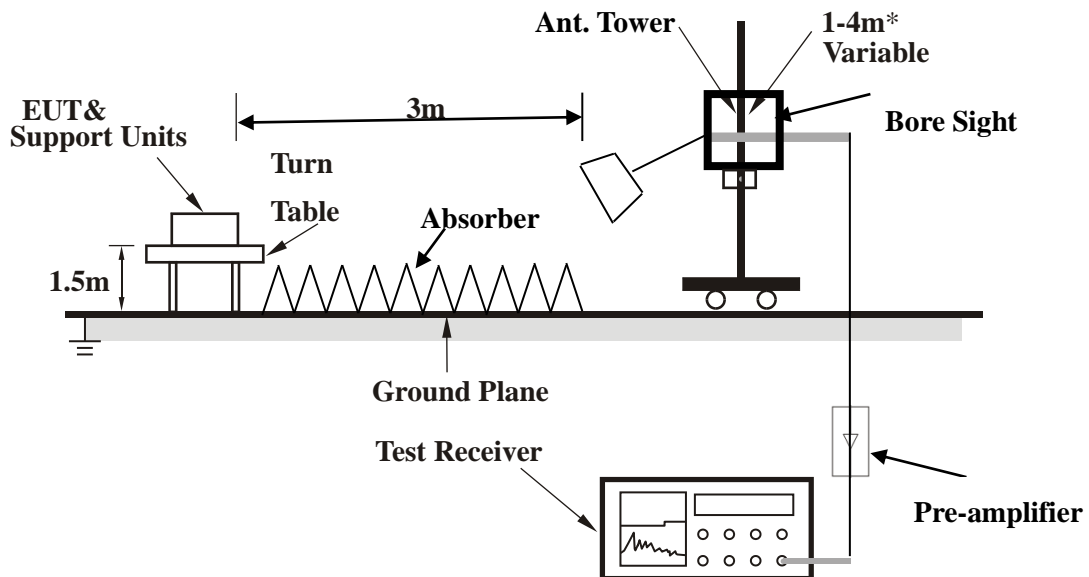

**Note:** Above 1G is a directional antenna

Depends on the EUT height and the antenna 3dB beamwidth both, refer to section 7.3 of CISPR 16-2-3.

For the actual test configuration, please refer to the attached file (Test Setup Photo).



### 3.1.7 EUT OPERATING CONDITION

- a. Set the EUT under full load condition and placed them on a testing table.
- b. Set the transmitter part of EUT under transmission condition continuously at specific channel frequency.
- c. The necessary accessories enable the EUT in full functions.



### 3.1.8 TEST RESULTS

#### BELOW 1GHz WORST-CASE DATA:

30 MHz – 1GHz data:

#### 802.11n (40MHz)

CHANNEL	TX Channel 38	DETECTOR FUNCTION	Quasi-Peak (QP)
FREQUENCY RANGE	30MHz ~ 1GHz		

ANTENNA POLARITY & TEST DISTANCE: HORIZONTAL AT 3 M										
FREQ. (MHz)	EMISSION LEVEL (dBuV/m)	READ LEVEL (dBuV)	LIMIT (dBuV/m)	MARGIN (dB)	ANTENNA FACTOR (dB /m)	CABLE LOSS (dB)	PREAMP FACTOR (dB)	ANTENNA HEIGHT (cm)	TABLE ANGLE (Degree)	REMARK
48.75	27	56.13	40	-13	7.2	1.01	37.34	100	360	Peak
96.35	31.06	57.69	43.5	-12.44	9.26	1.3	37.19	100	360	Peak
187.54	26.94	51.33	43.5	-16.56	10.49	1.73	36.61	100	360	Peak
289.41	20.67	41.36	46	-25.33	13.87	2.17	36.73	100	360	Peak
398.51	26.18	43.25	46	-19.82	17.15	2.61	36.83	100	360	Peak
487.65	24.86	40.56	46	-21.14	18.34	2.94	36.98	100	360	Peak

#### REMARKS:

1. Emission level (dBuV/m) = Read level (dBuV) + Correction Factor (dB/m).
2. Correction Factor (dB/m) = Antenna Factor (dB/m) + Cable Factor (dB).
3. The other emission levels were very low against the limit.
4. Margin value = Emission level – Limit value.

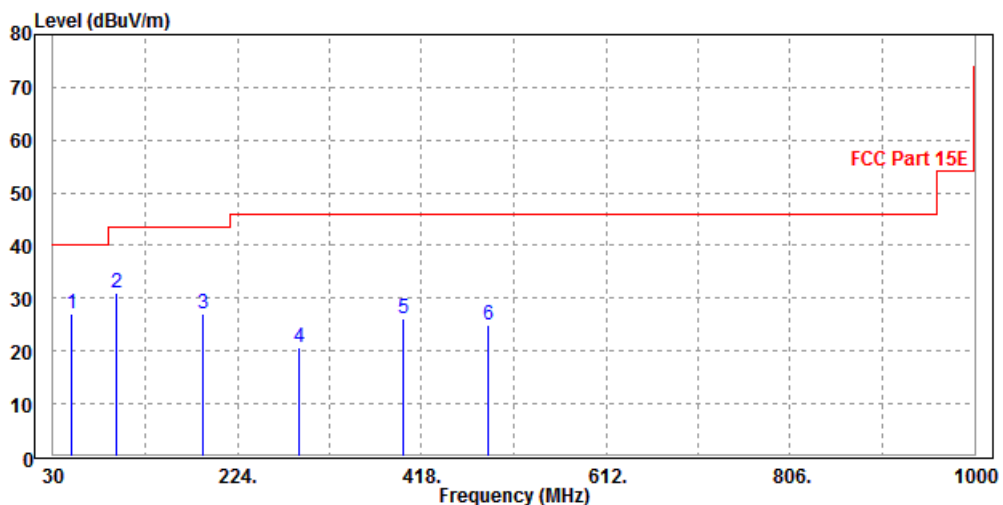



<b>CHANNEL</b>	Channel 38	<b>DETECTOR FUNCTION</b>	Quasi-Peak (QP)
<b>FREQUENCY RANGE</b>	30MHz ~ 1GHz		

ANTENNA POLARITY & TEST DISTANCE: VERTICAL AT 3 M										
FREQ. (MHz)	EMISSION LEVEL (dBuV/m)	READ LEVEL (dBuV)	LIMIT (dBuV/m)	MARGIN (dB)	ANTENNA FACTOR (dB /m)	CABLE LOSS (dB)	PREAMP FACTOR (dB)	ANTENNA HEIGHT (cm)	TABLE ANGLE (Degree)	REMARK
35.64	29.99	52.75	40	-10.01	13.96	0.87	37.59	100	0	Peak
89.66	27.95	55.33	43.5	-15.55	8.59	1.28	37.25	100	0	Peak
199.56	34.38	58.35	43.5	-9.12	10.79	1.79	36.55	100	0	Peak
286.75	29.69	50.32	46	-16.31	13.93	2.16	36.72	100	0	Peak
375.46	33.48	51.23	46	-12.52	16.54	2.52	36.81	100	0	Peak
475.63	26.42	42.12	46	-19.58	18.36	2.9	36.96	100	0	Peak

**REMARKS:**

1. Emission level (dBuV/m) = Read level (dBuV) + Correction Factor (dB/m).
2. Correction Factor (dB/m) = Antenna Factor (dB/m) + Cable Factor (dB).
3. The other emission levels were very low against the limit.
4. Margin value = Emission level – Limit value.

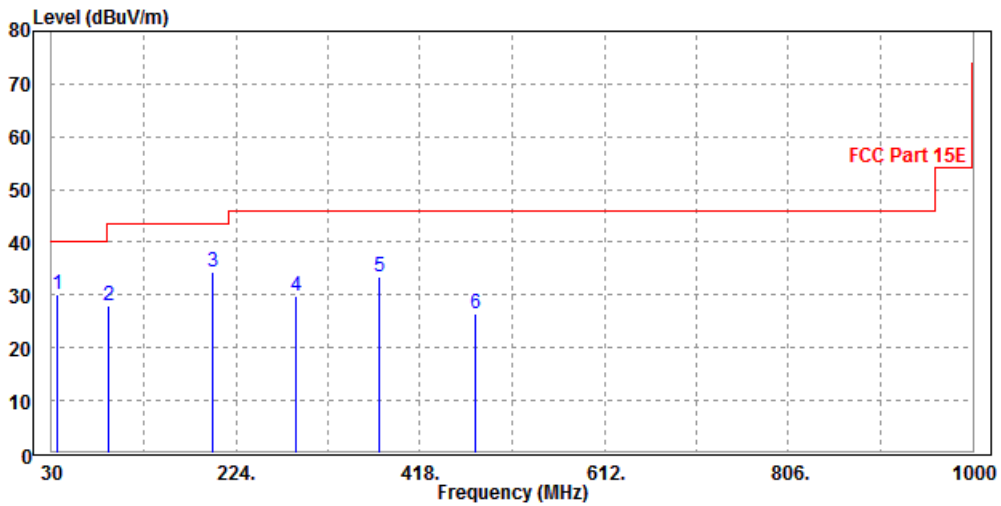





ABOVE 1GHZ WORST-CASE DATA:

Note: For higher frequency, the emission is too low to be detected.

Band 1

802.11a

CHANNEL	TX Channel 36	DETECTOR FUNCTION	Peak (PK)
FREQUENCY RANGE	1GHz ~ 40GHz		Average (AV)

ANTENNA POLARITY & TEST DISTANCE: HORIZONTAL AT 3 M

FREQ. (MHz)	EMISSION LEVEL (dBuV/m)	READ LEVEL (dBuV)	LIMIT (dBuV/m)	MARGIN (dB)	ANTENNA FACTOR (dB /m)	CABLE LOSS (dB)	PREAMP FACTOR (dB)	ANTENNA HEIGHT (cm)	TABLE ANGLE (Degree)	REMARK
5150	59.57	62.55	74	-14.43	35.95	7.42	46.35	100	152	Peak
5150	46.43	49.41	54	-7.57	35.95	7.42	46.35	100	152	Average
5180	99.69	102.63			35.98	7.43	46.35	100	152	Peak
5180	91.27	94.21			35.98	7.43	46.35	100	152	Average
5350	58.55	61.23	74	-15.45	36.15	7.47	46.3	100	152	Peak
5350	44.86	47.54	54	-9.14	36.15	7.47	46.3	100	152	Average

ANTENNA POLARITY & TEST DISTANCE: VERTICAL AT 3 M

FREQ. (MHz)	EMISSION LEVEL (dBuV/m)	READ LEVEL (dBuV)	LIMIT (dBuV/m)	MARGIN (dB)	ANTENNA FACTOR (dB /m)	CABLE LOSS (dB)	PREAMP FACTOR (dB)	ANTENNA HEIGHT (cm)	TABLE ANGLE (Degree)	REMARK
5150	61.23	63.87	74	-12.77	36.29	7.42	46.35	100	312	Peak
5150	47.58	50.22	54	-6.42	36.29	7.42	46.35	100	312	Average
5180	107.34	109.95			36.31	7.43	46.35	100	312	Peak
5180	98.94	101.55			36.31	7.43	46.35	100	312	Average
5350	58.48	60.9	74	-15.52	36.41	7.47	46.3	100	312	Peak
5350	45.34	47.76	54	-8.66	36.41	7.47	46.3	100	312	Average

REMARKS:

- Emission Level = Read Level+ Antenna Factor + Cable Loss- Preamp Factor  
Margin value = Emission level – Limit value.
- 5180MHz: Fundamental frequency.



<b>CHANNEL</b>	TX Channel 40	<b>DETECTOR FUNCTION</b>	Peak (PK)
<b>FREQUENCY RANGE</b>	1GHz ~ 40GHz		Average (AV)

ANTENNA POLARITY & TEST DISTANCE: HORIZONTAL AT 3 M										
FREQ. (MHz)	EMISSION LEVEL (dBuV/m)	READ LEVEL (dBuV)	LIMIT (dBuV/m)	MARGIN (dB)	ANTENNA FACTOR (dB /m)	CABLE LOSS (dB)	PREAMP FACTOR (dB)	ANTENNA HEIGHT (cm)	TABLE ANGLE (Degree)	REMARK
5150	58.87	61.85	74	-15.13	35.95	7.42	46.35	100	156	Peak
5150	44.71	47.69	54	-9.29	35.95	7.42	46.35	100	156	Average
5200	100.51	103.42			36	7.43	46.34	100	156	Peak
5200	92.45	95.36			36	7.43	46.34	100	156	Average
5350	58.96	61.64	74	-15.04	36.15	7.47	46.3	100	156	Peak
5350	45.16	47.84	54	-8.84	36.15	7.47	46.3	100	156	Average
ANTENNA POLARITY & TEST DISTANCE: VERTICAL AT 3 M										
FREQ. (MHz)	EMISSION LEVEL (dBuV/m)	READ LEVEL (dBuV)	LIMIT (dBuV/m)	MARGIN (dB)	ANTENNA FACTOR (dB /m)	CABLE LOSS (dB)	PREAMP FACTOR (dB)	ANTENNA HEIGHT (cm)	TABLE ANGLE (Degree)	REMARK
5150	58.7	61.34	74	-15.3	36.29	7.42	46.35	100	310	Peak
5150	45.83	48.47	54	-8.17	36.29	7.42	46.35	100	310	Average
5200	107.64	110.23			36.32	7.43	46.34	100	310	Peak
5200	98.93	101.52			36.32	7.43	46.34	100	310	Average
5350	58.6	61.02	74	-15.4	36.41	7.47	46.3	100	310	Peak
5350	44.83	47.25	54	-9.17	36.41	7.47	46.3	100	310	Average

**REMARKS:**

- Emission Level = Read Level+ Antenna Factor + Cable Loss- Preamp Factor  
Margin value = Emission level – Limit value.
- 5200MHz: Fundamental frequency.



<b>CHANNEL</b>	TX Channel 48	<b>DETECTOR FUNCTION</b>	Peak (PK)
<b>FREQUENCY RANGE</b>	1GHz ~ 40GHz		Average (AV)

**ANTENNA POLARITY & TEST DISTANCE: HORIZONTAL AT 3 M**

FREQ. (MHz)	EMISSION LEVEL (dBuV/m)	READ LEVEL (dBuV)	LIMIT (dBuV/m)	MARGIN (dB)	ANTENNA FACTOR (dB /m)	CABLE LOSS (dB)	PREAMP FACTOR (dB)	ANTENNA HEIGHT (cm)	TABLE ANGLE (Degree)	REMARK
5150	59.78	61.45	74	-14.22	37.26	7.42	46.35	100	324	Peak
5150	46.24	47.91	54	-7.76	37.26	7.42	46.35	100	324	Average
5240	107.16	108.75			37.3	7.44	46.33	100	324	Peak
5240	98.62	100.21			37.3	7.44	46.33	100	324	Average
5350	60.35	61.84	74	-13.65	37.34	7.47	46.3	100	324	Peak
5350	46.27	47.76	54	-7.73	37.34	7.47	46.3	100	324	Average

**ANTENNA POLARITY & TEST DISTANCE: VERTICAL AT 3 M**

FREQ. (MHz)	EMISSION LEVEL (dBuV/m)	READ LEVEL (dBuV)	LIMIT (dBuV/m)	MARGIN (dB)	ANTENNA FACTOR (dB /m)	CABLE LOSS (dB)	PREAMP FACTOR (dB)	ANTENNA HEIGHT (cm)	TABLE ANGLE (Degree)	REMARK
5150	59.04	61.68	74	-14.96	36.29	7.42	46.35	100	315	Peak
5150	44.93	47.57	54	-9.07	36.29	7.42	46.35	100	315	Average
5240	100.42	102.97			36.34	7.44	46.33	100	315	Peak
5240	90.7	93.25			36.34	7.44	46.33	100	315	Average
5350	59.23	61.65	74	-14.77	36.41	7.47	46.3	100	315	Peak
5350	45.36	47.78	54	-8.64	36.41	7.47	46.3	100	315	Average

**REMARKS:**

- Emission Level = Read Level+ Antenna Factor + Cable Loss- Preamp Factor  
Margin value = Emission level – Limit value.
- 5240MHz: Fundamental frequency.



**802.11n (20MHz)**

<b>CHANNEL</b>	TX Channel 36	<b>DETECTOR FUNCTION</b>	Peak (PK)
<b>FREQUENCY RANGE</b>	1GHz ~ 40GHz		Average (AV)

**ANTENNA POLARITY & TEST DISTANCE: HORIZONTAL AT 3 M**

FREQ. (MHz)	EMISSION LEVEL (dBuV/m)	READ LEVEL (dBuV)	LIMIT (dBuV/m)	MARGIN (dB)	ANTENNA FACTOR (dB /m)	CABLE LOSS (dB)	PREAMP FACTOR (dB)	ANTENNA HEIGHT (cm)	TABLE ANGLE (Degree)	REMARK
5150	59.36	62.34	74	-14.64	35.95	7.42	46.35	100	155	Peak
5150	46.33	49.31	54	-7.67	35.95	7.42	46.35	100	155	Average
5180	98.3	101.24			35.98	7.43	46.35	100	155	Peak
5180	90.32	93.26			35.98	7.43	46.35	100	155	Average
5350	58.74	61.42	74	-15.26	36.15	7.47	46.3	100	155	Peak
5350	44.68	47.36	54	-9.32	36.15	7.47	46.3	100	155	Average

**ANTENNA POLARITY & TEST DISTANCE: VERTICAL AT 3 M**

FREQ. (MHz)	EMISSION LEVEL (dBuV/m)	READ LEVEL (dBuV)	LIMIT (dBuV/m)	MARGIN (dB)	ANTENNA FACTOR (dB /m)	CABLE LOSS (dB)	PREAMP FACTOR (dB)	ANTENNA HEIGHT (cm)	TABLE ANGLE (Degree)	REMARK
5150	60.82	63.46	74	-13.18	36.29	7.42	46.35	100	313	Peak
5150	46.88	49.52	54	-7.12	36.29	7.42	46.35	100	313	Average
5180	103.2	105.81			36.31	7.43	46.35	100	313	Peak
5180	95.03	97.64			36.31	7.43	46.35	100	313	Average
5350	59.33	61.75	74	-14.67	36.41	7.47	46.3	100	313	Peak
5350	45.25	47.67	54	-8.75	36.41	7.47	46.3	100	313	Average

**REMARKS:**

- Emission Level = Read Level+ Antenna Factor + Cable Loss- Preamp Factor  
Margin value = Emission level – Limit value.
- 5180MHz: Fundamental frequency.



<b>CHANNEL</b>	TX Channel 40	<b>DETECTOR FUNCTION</b>	Peak (PK)
<b>FREQUENCY RANGE</b>	1GHz ~ 40GHz		Average (AV)

**ANTENNA POLARITY & TEST DISTANCE: HORIZONTAL AT 3 M**

FREQ. (MHz)	EMISSION LEVEL (dBuV/m)	READ LEVEL (dBuV)	LIMIT (dBuV/m)	MARGIN (dB)	ANTENNA FACTOR (dB /m)	CABLE LOSS (dB)	PREAMP FACTOR (dB)	ANTENNA HEIGHT (cm)	TABLE ANGLE (Degree)	REMARK
5150	58.36	61.34	74	-15.64	35.95	7.42	46.35	100	145	Peak
5150	44.67	47.65	54	-9.33	35.95	7.42	46.35	100	145	Average
5200	98.05	100.96			36	7.43	46.34	100	145	Peak
5200	89.51	92.42			36	7.43	46.34	100	145	Average
5350	59	61.68	74	-15	36.15	7.47	46.3	100	145	Peak
5350	44.78	47.46	54	-9.22	36.15	7.47	46.3	100	145	Average

**ANTENNA POLARITY & TEST DISTANCE: VERTICAL AT 3 M**

FREQ. (MHz)	EMISSION LEVEL (dBuV/m)	READ LEVEL (dBuV)	LIMIT (dBuV/m)	MARGIN (dB)	ANTENNA FACTOR (dB /m)	CABLE LOSS (dB)	PREAMP FACTOR (dB)	ANTENNA HEIGHT (cm)	TABLE ANGLE (Degree)	REMARK
5150	58.99	61.63	74	-15.01	36.29	7.42	46.35	100	312	Peak
5150	44.85	47.49	54	-9.15	36.29	7.42	46.35	100	312	Average
5200	103.37	105.96			36.32	7.43	46.34	100	312	Peak
5200	94.19	96.78			36.32	7.43	46.34	100	312	Average
5350	59.31	61.73	74	-14.69	36.41	7.47	46.3	100	312	Peak
5350	45.26	47.68	54	-8.74	36.41	7.47	46.3	100	312	Average

**REMARKS:**

- Emission Level = Read Level+ Antenna Factor + Cable Loss- Preamp Factor  
Margin value = Emission level – Limit value.
- 5200MHz: Fundamental frequency.



<b>CHANNEL</b>	TX Channel 48	<b>DETECTOR FUNCTION</b>	Peak (PK)
<b>FREQUENCY RANGE</b>	1GHz ~ 40GHz		Average (AV)

**ANTENNA POLARITY & TEST DISTANCE: HORIZONTAL AT 3 M**

FREQ. (MHz)	EMISSION LEVEL (dBuV/m)	READ LEVEL (dBuV)	LIMIT (dBuV/m)	MARGIN (dB)	ANTENNA FACTOR (dB /m)	CABLE LOSS (dB)	PREAMP FACTOR (dB)	ANTENNA HEIGHT (cm)	TABLE ANGLE (Degree)	REMARK
5150	58.34	61.32	74	-15.66	35.95	7.42	46.35	100	151	Peak
5150	45.03	48.01	54	-8.97	35.95	7.42	46.35	100	151	Average
5240	98.4	101.25			36.04	7.44	46.33	100	151	Peak
5240	89.49	92.34			36.04	7.44	46.33	100	151	Average
5350	58.99	61.67	74	-15.01	36.15	7.47	46.3	100	151	Peak
5350	45.1	47.78	54	-8.9	36.15	7.47	46.3	100	151	Average

**ANTENNA POLARITY & TEST DISTANCE: VERTICAL AT 3 M**

FREQ. (MHz)	EMISSION LEVEL (dBuV/m)	READ LEVEL (dBuV)	LIMIT (dBuV/m)	MARGIN (dB)	ANTENNA FACTOR (dB /m)	CABLE LOSS (dB)	PREAMP FACTOR (dB)	ANTENNA HEIGHT (cm)	TABLE ANGLE (Degree)	REMARK
5150	58.93	61.57	74	-15.07	36.29	7.42	46.35	100	321	Peak
5150	45.3	47.94	54	-8.7	36.29	7.42	46.35	100	321	Average
5240	103.68	106.23			36.34	7.44	46.33	100	321	Peak
5240	93.89	96.44			36.34	7.44	46.33	100	321	Average
5350	59.37	61.79	74	-14.63	36.41	7.47	46.3	100	321	Peak
5350	45.7	48.12	54	-8.3	36.41	7.47	46.3	100	321	Average

**REMARKS:**

- Emission Level = Read Level+ Antenna Factor + Cable Loss- Preamp Factor  
Margin value = Emission level – Limit value.
- 5240MHz: Fundamental frequency.



802.11n (40MHz)

<b>CHANNEL</b>	TX Channel 38	<b>DETECTOR FUNCTION</b>	Peak (PK)
<b>FREQUENCY RANGE</b>	1GHz ~ 40GHz		Average (AV)

**ANTENNA POLARITY & TEST DISTANCE: HORIZONTAL AT 3 M**

FREQ. (MHz)	EMISSION LEVEL (dBuV/m)	READ LEVEL (dBuV)	LIMIT (dBuV/m)	MARGIN (dB)	ANTENNA FACTOR (dB /m)	CABLE LOSS (dB)	PREAMP FACTOR (dB)	ANTENNA HEIGHT (cm)	TABLE ANGLE (Degree)	REMARK
5150	63.44	66.42	74	-10.56	35.95	7.42	46.35	100	158	Peak
5150	48.81	51.79	54	-5.19	35.95	7.42	46.35	100	158	Average
5190	98.62	101.54			35.99	7.43	46.34	100	158	Peak
5190	90.33	93.25			35.99	7.43	46.34	100	158	Average
5350	59.73	62.41	74	-14.27	36.15	7.47	46.3	100	158	Peak
5350	45.55	48.23	54	-8.45	36.15	7.47	46.3	100	158	Average

**ANTENNA POLARITY & TEST DISTANCE: VERTICAL AT 3 M**

FREQ. (MHz)	EMISSION LEVEL (dBuV/m)	READ LEVEL (dBuV)	LIMIT (dBuV/m)	MARGIN (dB)	ANTENNA FACTOR (dB /m)	CABLE LOSS (dB)	PREAMP FACTOR (dB)	ANTENNA HEIGHT (cm)	TABLE ANGLE (Degree)	REMARK
5150	66.21	68.85	74	-7.79	36.29	7.42	46.35	100	315	Peak
5150	50.05	52.69	54	-3.95	36.29	7.42	46.35	100	315	Average
5190	101.55	104.15			36.31	7.43	46.34	100	315	Peak
5190	93.82	96.42			36.31	7.43	46.34	100	315	Average
5350	59.35	61.77	74	-14.65	36.41	7.47	46.3	100	315	Peak
5350	45.89	48.31	54	-8.11	36.41	7.47	46.3	100	315	Average

**REMARKS:**

- Emission Level = Read Level+ Antenna Factor + Cable Loss- Preamp Factor  
Margin value = Emission level – Limit value.
- 5190MHz: Fundamental frequency.



<b>CHANNEL</b>	TX Channel 46	<b>DETECTOR FUNCTION</b>	Peak (PK)
<b>FREQUENCY RANGE</b>	1GHz ~ 40GHz		Average (AV)

**ANTENNA POLARITY & TEST DISTANCE: HORIZONTAL AT 3 M**

FREQ. (MHz)	EMISSION LEVEL (dBuV/m)	READ LEVEL (dBuV)	LIMIT (dBuV/m)	MARGIN (dB)	ANTENNA FACTOR (dB /m)	CABLE LOSS (dB)	PREAMP FACTOR (dB)	ANTENNA HEIGHT (cm)	TABLE ANGLE (Degree)	REMARK
5150	58.88	61.86	74	-15.12	35.95	7.42	46.35	100	155	Peak
5150	45.17	48.15	54	-8.83	35.95	7.42	46.35	100	155	Average
5230	97.62	100.48			36.03	7.44	46.33	100	155	Peak
5230	89.5	92.36			36.03	7.44	46.33	100	155	Average
5350	58.89	61.57	74	-15.11	36.15	7.47	46.3	100	155	Peak
5350	45.01	47.69	54	-8.99	36.15	7.47	46.3	100	155	Average

**ANTENNA POLARITY & TEST DISTANCE: VERTICAL AT 3 M**

FREQ. (MHz)	EMISSION LEVEL (dBuV/m)	READ LEVEL (dBuV)	LIMIT (dBuV/m)	MARGIN (dB)	ANTENNA FACTOR (dB /m)	CABLE LOSS (dB)	PREAMP FACTOR (dB)	ANTENNA HEIGHT (cm)	TABLE ANGLE (Degree)	REMARK
5150	59.24	61.88	74	-14.76	36.29	7.42	46.35	100	311	Peak
5150	45.41	48.05	54	-8.59	36.29	7.42	46.35	100	311	Average
5230	102.01	104.56			36.34	7.44	46.33	100	311	Peak
5230	93.8	96.35			36.34	7.44	46.33	100	311	Average
5350	59.47	61.89	74	-14.53	36.41	7.47	46.3	100	311	Peak
5350	45.33	47.75	54	-8.67	36.41	7.47	46.3	100	311	Average

**REMARKS:**

- Emission Level = Read Level+ Antenna Factor + Cable Loss- Preamp Factor  
Margin value = Emission level – Limit value.
- 5230MHz: Fundamental frequency.





802.11ac (80MHz)

<b>CHANNEL</b>	TX Channel 42	<b>DETECTOR FUNCTION</b>	Peak (PK)
<b>FREQUENCY RANGE</b>	1GHz ~ 40GHz		Average (AV)

**ANTENNA POLARITY & TEST DISTANCE: HORIZONTAL AT 3 M**

FREQ. (MHz)	EMISSION LEVEL (dBuV/m)	READ LEVEL (dBuV)	LIMIT (dBuV/m)	MARGIN (dB)	ANTENNA FACTOR (dB /m)	CABLE LOSS (dB)	PREAMP FACTOR (dB)	ANTENNA HEIGHT (cm)	TABLE ANGLE (Degree)	REMARK
5150	62.45	65.43	74	-11.55	35.95	7.42	46.35	100	159	Peak
5150	48	50.98	54	-6	35.95	7.42	46.35	100	159	Average
5210	92.75	95.64			36.01	7.44	46.34	100	159	Peak
5210	85.56	88.45			36.01	7.44	46.34	100	159	Average
5350	58.9	61.58	74	-15.1	36.15	7.47	46.3	100	159	Peak
5350	44.97	47.65	54	-9.03	36.15	7.47	46.3	100	159	Average

**ANTENNA POLARITY & TEST DISTANCE: VERTICAL AT 3 M**

FREQ. (MHz)	EMISSION LEVEL (dBuV/m)	READ LEVEL (dBuV)	LIMIT (dBuV/m)	MARGIN (dB)	ANTENNA FACTOR (dB /m)	CABLE LOSS (dB)	PREAMP FACTOR (dB)	ANTENNA HEIGHT (cm)	TABLE ANGLE (Degree)	REMARK
5150	64.65	67.29	74	-9.35	36.29	7.42	46.35	100	315	Peak
5150	49.05	51.69	54	-4.95	36.29	7.42	46.35	100	315	Average
5210	96.09	98.66			36.33	7.44	46.34	100	315	Peak
5210	88.84	91.41			36.33	7.44	46.34	100	315	Average
5350	58.93	61.35	74	-15.07	36.41	7.47	46.3	100	315	Peak
5350	45.33	47.75	54	-8.67	36.41	7.47	46.3	100	315	Average

**REMARKS:**

- Emission Level = Read Level+ Antenna Factor + Cable Loss- Preamp Factor  
Margin value = Emission level – Limit value.
- 5210MHz: Fundamental frequency.



Band 2  
802.11a

<b>CHANNEL</b>	TX Channel 52	<b>DETECTOR FUNCTION</b>	Peak (PK)
<b>FREQUENCY RANGE</b>	1GHz ~ 40GHz		Average (AV)

**ANTENNA POLARITY & TEST DISTANCE: HORIZONTAL AT 3 M**

FREQ. (MHz)	EMISSION LEVEL (dBuV/m)	READ LEVEL (dBuV)	LIMIT (dBuV/m)	MARGIN (dB)	ANTENNA FACTOR (dB /m)	CABLE LOSS (dB)	PREAMP FACTOR (dB)	ANTENNA HEIGHT (cm)	TABLE ANGLE (Degree)	REMARK
5150	58.59	61.57	74	-15.41	35.95	7.42	46.35	100	235	Peak
5150	44.38	47.36	54	-9.62	35.95	7.42	46.35	100	235	Average
5260	101.8	104.61			36.06	7.45	46.32	100	235	Peak
5260	92.97	95.78			36.06	7.45	46.32	100	235	Average
5350	59.2	61.88	74	-14.8	36.15	7.47	46.3	100	235	Peak
5350	44.77	47.45	54	-9.23	36.15	7.47	46.3	100	235	Average

**ANTENNA POLARITY & TEST DISTANCE: VERTICAL AT 3 M**

FREQ. (MHz)	EMISSION LEVEL (dBuV/m)	READ LEVEL (dBuV)	LIMIT (dBuV/m)	MARGIN (dB)	ANTENNA FACTOR (dB /m)	CABLE LOSS (dB)	PREAMP FACTOR (dB)	ANTENNA HEIGHT (cm)	TABLE ANGLE (Degree)	REMARK
5150	58.9	61.54	74	-15.1	36.29	7.42	46.35	100	32	Peak
5150	44.99	47.63	54	-9.01	36.29	7.42	46.35	100	32	Average
5260	107.06	109.57			36.36	7.45	46.32	100	32	Peak
5260	97.69	100.2			36.36	7.45	46.32	100	32	Average
5350	59.1	61.52	74	-14.9	36.41	7.47	46.3	100	32	Peak
5350	45.06	47.48	54	-8.94	36.41	7.47	46.3	100	32	Average

**REMARKS:**

- Emission Level = Read Level+ Antenna Factor + Cable Loss- Preamp Factor  
Margin value = Emission level – Limit value.
- 5260MHz: Fundamental frequency.



<b>CHANNEL</b>	TX Channel 60	<b>DETECTOR FUNCTION</b>	Peak (PK)
<b>FREQUENCY RANGE</b>	1GHz ~ 40GHz		Average (AV)

**ANTENNA POLARITY & TEST DISTANCE: HORIZONTAL AT 3 M**

FREQ. (MHz)	EMISSION LEVEL (dBuV/m)	READ LEVEL (dBuV)	LIMIT (dBuV/m)	MARGIN (dB)	ANTENNA FACTOR (dB /m)	CABLE LOSS (dB)	PREAMP FACTOR (dB)	ANTENNA HEIGHT (cm)	TABLE ANGLE (Degree)	REMARK
5150	58.67	61.65	74	-15.33	35.95	7.42	46.35	100	325	Peak
5150	45.14	48.12	54	-8.86	35.95	7.42	46.35	100	325	Average
5300	102.48	105.23			36.1	7.46	46.31	100	325	Peak
5300	93.77	96.52			36.1	7.46	46.31	100	325	Average
5350	59.1	61.78	74	-14.9	36.15	7.47	46.3	100	325	Peak
5350	44.88	47.56	54	-9.12	36.15	7.47	46.3	100	325	Average

**ANTENNA POLARITY & TEST DISTANCE: VERTICAL AT 3 M**

FREQ. (MHz)	EMISSION LEVEL (dBuV/m)	READ LEVEL (dBuV)	LIMIT (dBuV/m)	MARGIN (dB)	ANTENNA FACTOR (dB /m)	CABLE LOSS (dB)	PREAMP FACTOR (dB)	ANTENNA HEIGHT (cm)	TABLE ANGLE (Degree)	REMARK
5150	59.21	61.85	74	-14.79	36.29	7.42	46.35	100	36	Peak
5150	44.84	47.48	54	-9.16	36.29	7.42	46.35	100	36	Average
5300	106.28	108.75			36.38	7.46	46.31	100	36	Peak
5300	96.19	98.66			36.38	7.46	46.31	100	36	Average
5350	59.47	61.89	74	-14.53	36.41	7.47	46.3	100	36	Peak
5350	45.63	48.05	54	-8.37	36.41	7.47	46.3	100	36	Average

**REMARKS:**

- Emission Level = Read Level+ Antenna Factor + Cable Loss- Preamp Factor  
Margin value = Emission level – Limit value.
- 5300MHz: Fundamental frequency.



<b>CHANNEL</b>	TX Channel 64	<b>DETECTOR FUNCTION</b>	Peak (PK)
<b>FREQUENCY RANGE</b>	1GHz ~ 40GHz		Average (AV)

**ANTENNA POLARITY & TEST DISTANCE: HORIZONTAL AT 3 M**

FREQ. (MHz)	EMISSION LEVEL (dBuV/m)	READ LEVEL (dBuV)	LIMIT (dBuV/m)	MARGIN (dB)	ANTENNA FACTOR (dB /m)	CABLE LOSS (dB)	PREAMP FACTOR (dB)	ANTENNA HEIGHT (cm)	TABLE ANGLE (Degree)	REMARK
5150	58.9	61.88	74	-15.1	35.95	7.42	46.35	100	312	Peak
5150	44.58	47.56	54	-9.42	35.95	7.42	46.35	100	312	Average
5320	101.49	104.21			36.12	7.46	46.3	100	312	Peak
5320	92.14	94.86			36.12	7.46	46.3	100	312	Average
5350	60.85	63.53	74	-13.15	36.15	7.47	46.3	100	312	Peak
5350	47.43	50.11	54	-6.57	36.15	7.47	46.3	100	312	Average

**ANTENNA POLARITY & TEST DISTANCE: VERTICAL AT 3 M**

FREQ. (MHz)	EMISSION LEVEL (dBuV/m)	READ LEVEL (dBuV)	LIMIT (dBuV/m)	MARGIN (dB)	ANTENNA FACTOR (dB /m)	CABLE LOSS (dB)	PREAMP FACTOR (dB)	ANTENNA HEIGHT (cm)	TABLE ANGLE (Degree)	REMARK
5150	58.95	61.59	74	-15.05	36.29	7.42	46.35	100	97	Peak
5150	45.32	47.96	54	-8.68	36.29	7.42	46.35	100	97	Average
5320	107.18	109.63			36.39	7.46	46.3	100	97	Peak
5320	97.76	100.21			36.39	7.46	46.3	100	97	Average
5350	62.9	65.32	74	-11.1	36.41	7.47	46.3	100	97	Peak
5350	48.64	51.06	54	-5.36	36.41	7.47	46.3	100	97	Average

**REMARKS:**

- Emission Level = Read Level+ Antenna Factor + Cable Loss- Preamp Factor  
Margin value = Emission level – Limit value.
- 5320MHz: Fundamental frequency.



802.11n (20MHz)

<b>CHANNEL</b>	TX Channel 52	<b>DETECTOR FUNCTION</b>	Peak (PK)
<b>FREQUENCY RANGE</b>	1GHz ~ 40GHz		Average (AV)

**ANTENNA POLARITY & TEST DISTANCE: HORIZONTAL AT 3 M**

FREQ. (MHz)	EMISSION LEVEL (dBuV/m)	READ LEVEL (dBuV)	LIMIT (dBuV/m)	MARGIN (dB)	ANTENNA FACTOR (dB /m)	CABLE LOSS (dB)	PREAMP FACTOR (dB)	ANTENNA HEIGHT (cm)	TABLE ANGLE (Degree)	REMARK
5150	58.86	61.84	74	-15.14	35.95	7.42	46.35	100	256	Peak
5150	44.71	47.69	54	-9.29	35.95	7.42	46.35	100	256	Average
5260	97.5	100.31			36.06	7.45	46.32	100	256	Peak
5260	89.73	92.54			36.06	7.45	46.32	100	256	Average
5350	58.67	61.35	74	-15.33	36.15	7.47	46.3	100	256	Peak
5350	44.55	47.23	54	-9.45	36.15	7.47	46.3	100	256	Average

**ANTENNA POLARITY & TEST DISTANCE: VERTICAL AT 3 M**

FREQ. (MHz)	EMISSION LEVEL (dBuV/m)	READ LEVEL (dBuV)	LIMIT (dBuV/m)	MARGIN (dB)	ANTENNA FACTOR (dB /m)	CABLE LOSS (dB)	PREAMP FACTOR (dB)	ANTENNA HEIGHT (cm)	TABLE ANGLE (Degree)	REMARK
5150	59.14	61.78	74	-14.86	36.29	7.42	46.35	100	336	Peak
5150	45.24	47.88	54	-8.76	36.29	7.42	46.35	100	336	Average
5260	102.69	105.2			36.36	7.45	46.32	100	336	Peak
5260	103.74	106.25			36.36	7.45	46.32	100	336	Average
5350	59.12	61.54	74	-14.88	36.41	7.47	46.3	100	336	Peak
5350	45.33	47.75	54	-8.67	36.41	7.47	46.3	100	336	Average

**REMARKS:**

- Emission Level = Read Level+ Antenna Factor + Cable Loss- Preamp Factor  
Margin value = Emission level – Limit value.
- 5260MHz: Fundamental frequency.



<b>CHANNEL</b>	TX Channel 60	<b>DETECTOR FUNCTION</b>	Peak (PK)
<b>FREQUENCY RANGE</b>	1GHz ~ 40GHz		Average (AV)

<b>ANTENNA POLARITY &amp; TEST DISTANCE: HORIZONTAL AT 3 M</b>										
<b>FREQ. (MHz)</b>	<b>EMISSION LEVEL (dBuV/m)</b>	<b>READ LEVEL (dBuV)</b>	<b>LIMIT (dBuV/m)</b>	<b>MARGIN (dB)</b>	<b>ANTENNA FACTOR (dB /m)</b>	<b>CABLE LOSS (dB)</b>	<b>PREAMP FACTOR (dB)</b>	<b>ANTENNA HEIGHT (cm)</b>	<b>TABLE ANGLE (Degree)</b>	<b>REMARK</b>
5150	59	61.98	74	-15	35.95	7.42	46.35	100	315	Peak
5150	44.78	47.76	54	-9.22	35.95	7.42	46.35	100	315	Average
5300	98.49	101.24			36.1	7.46	46.31	100	315	Peak
5300	89.61	92.36			36.1	7.46	46.31	100	315	Average
5350	58.71	61.39	74	-15.29	36.15	7.47	46.3	100	315	Peak
5350	45.33	48.01	54	-8.67	36.15	7.47	46.3	100	315	Average

<b>ANTENNA POLARITY &amp; TEST DISTANCE: VERTICAL AT 3 M</b>										
<b>FREQ. (MHz)</b>	<b>EMISSION LEVEL (dBuV/m)</b>	<b>READ LEVEL (dBuV)</b>	<b>LIMIT (dBuV/m)</b>	<b>MARGIN (dB)</b>	<b>ANTENNA FACTOR (dB /m)</b>	<b>CABLE LOSS (dB)</b>	<b>PREAMP FACTOR (dB)</b>	<b>ANTENNA HEIGHT (cm)</b>	<b>TABLE ANGLE (Degree)</b>	<b>REMARK</b>
5150	59.68	62.32	74	-14.32	36.29	7.42	46.35	100	96	Peak
5150	45.21	47.85	54	-8.79	36.29	7.42	46.35	100	96	Average
5300	102.04	104.51			36.38	7.46	46.31	100	96	Peak
5300	92.86	95.33			36.38	7.46	46.31	100	96	Average
5350	59.12	61.54	74	-14.88	36.41	7.47	46.3	100	96	Peak
5350	45.44	47.86	54	-8.56	36.41	7.47	46.3	100	96	Average

**REMARKS:**

1. Emission Level = Read Level+ Antenna Factor + Cable Loss- Preamp Factor  
Margin value = Emission level – Limit value.
2. 5300MHz: Fundamental frequency.



<b>CHANNEL</b>	TX Channel 64	<b>DETECTOR FUNCTION</b>	Peak (PK)
<b>FREQUENCY RANGE</b>	1GHz ~ 40GHz		Average (AV)

**ANTENNA POLARITY & TEST DISTANCE: HORIZONTAL AT 3 M**

FREQ. (MHz)	EMISSION LEVEL (dBuV/m)	READ LEVEL (dBuV)	LIMIT (dBuV/m)	MARGIN (dB)	ANTENNA FACTOR (dB /m)	CABLE LOSS (dB)	PREAMP FACTOR (dB)	ANTENNA HEIGHT (cm)	TABLE ANGLE (Degree)	REMARK
5150	58.9	61.88	74	-15.1	35.95	7.42	46.35	100	236	Peak
5150	44.69	47.67	54	-9.31	35.95	7.42	46.35	100	236	Average
5320	98.4	101.12			36.12	7.46	46.3	100	236	Peak
5320	90.43	93.15			36.12	7.46	46.3	100	236	Average
5350	60.68	63.36	74	-13.32	36.15	7.47	46.3	100	236	Peak
5350	47.5	50.18	54	-6.5	36.15	7.47	46.3	100	236	Average

**ANTENNA POLARITY & TEST DISTANCE: VERTICAL AT 3 M**

FREQ. (MHz)	EMISSION LEVEL (dBuV/m)	READ LEVEL (dBuV)	LIMIT (dBuV/m)	MARGIN (dB)	ANTENNA FACTOR (dB /m)	CABLE LOSS (dB)	PREAMP FACTOR (dB)	ANTENNA HEIGHT (cm)	TABLE ANGLE (Degree)	REMARK
5150	59	61.64	74	-15	36.29	7.42	46.35	100	41	Peak
5150	44.81	47.45	54	-9.19	36.29	7.42	46.35	100	41	Average
5320	103.01	105.46			36.39	7.46	46.3	100	41	Peak
5320	93.87	96.32			36.39	7.46	46.3	100	41	Average
5350	62.89	65.31	74	-11.11	36.41	7.47	46.3	100	41	Peak
5350	48.64	51.06	54	-5.36	36.41	7.47	46.3	100	41	Average

**REMARKS:**

- Emission Level = Read Level+ Antenna Factor + Cable Loss- Preamp Factor  
Margin value = Emission level – Limit value.
- 5320MHz: Fundamental frequency.



802.11n (40MHz)

<b>CHANNEL</b>	TX Channel 54	<b>DETECTOR FUNCTION</b>	Peak (PK)
<b>FREQUENCY RANGE</b>	1GHz ~ 40GHz		Average (AV)

**ANTENNA POLARITY & TEST DISTANCE: HORIZONTAL AT 3 M**

FREQ. (MHz)	EMISSION LEVEL (dBuV/m)	READ LEVEL (dBuV)	LIMIT (dBuV/m)	MARGIN (dB)	ANTENNA FACTOR (dB /m)	CABLE LOSS (dB)	PREAMP FACTOR (dB)	ANTENNA HEIGHT (cm)	TABLE ANGLE (Degree)	REMARK
5150	58.89	61.87	74	-15.11	35.95	7.42	46.35	100	245	Peak
5150	45.25	48.23	54	-8.75	35.95	7.42	46.35	100	245	Average
5270	96.82	99.62			36.07	7.45	46.32	100	245	Peak
5270	87.71	90.51			36.07	7.45	46.32	100	245	Average
5350	59.09	61.77	74	-14.91	36.15	7.47	46.3	100	245	Peak
5350	45.18	47.86	54	-8.82	36.15	7.47	46.3	100	245	Average

**ANTENNA POLARITY & TEST DISTANCE: VERTICAL AT 3 M**

FREQ. (MHz)	EMISSION LEVEL (dBuV/m)	READ LEVEL (dBuV)	LIMIT (dBuV/m)	MARGIN (dB)	ANTENNA FACTOR (dB /m)	CABLE LOSS (dB)	PREAMP FACTOR (dB)	ANTENNA HEIGHT (cm)	TABLE ANGLE (Degree)	REMARK
5150	58.95	61.59	74	-15.05	36.29	7.42	46.35	100	96	Peak
5150	44.88	47.52	54	-9.12	36.29	7.42	46.35	100	96	Average
5270	99.84	102.35			36.36	7.45	46.32	100	96	Peak
5270	90.73	93.24			36.36	7.45	46.32	100	96	Average
5350	59.69	62.11	74	-14.31	36.41	7.47	46.3	100	96	Peak
5350	45.72	48.14	54	-8.28	36.41	7.47	46.3	100	96	Average

**REMARKS:**

- Emission Level = Read Level+ Antenna Factor + Cable Loss- Preamp Factor  
Margin value = Emission level – Limit value.
- 5270MHz: Fundamental frequency.





<b>CHANNEL</b>	TX Channel 62	<b>DETECTOR FUNCTION</b>	Peak (PK)
<b>FREQUENCY RANGE</b>	1GHz ~ 40GHz		Average (AV)

**ANTENNA POLARITY & TEST DISTANCE: HORIZONTAL AT 3 M**

FREQ. (MHz)	EMISSION LEVEL (dBuV/m)	READ LEVEL (dBuV)	LIMIT (dBuV/m)	MARGIN (dB)	ANTENNA FACTOR (dB /m)	CABLE LOSS (dB)	PREAMP FACTOR (dB)	ANTENNA HEIGHT (cm)	TABLE ANGLE (Degree)	REMARK
5150	58.36	61.34	74	-15.64	35.95	7.42	46.35	100	321	Peak
5150	44.53	47.51	54	-9.47	35.95	7.42	46.35	100	321	Average
5310	95.71	98.45			36.11	7.46	46.31	100	321	Peak
5310	87.5	90.24			36.11	7.46	46.31	100	321	Average
5350	61.55	64.23	74	-12.45	36.15	7.47	46.3	100	321	Peak
5350	47.58	50.26	54	-6.42	36.15	7.47	46.3	100	321	Average

**ANTENNA POLARITY & TEST DISTANCE: VERTICAL AT 3 M**

FREQ. (MHz)	EMISSION LEVEL (dBuV/m)	READ LEVEL (dBuV)	LIMIT (dBuV/m)	MARGIN (dB)	ANTENNA FACTOR (dB /m)	CABLE LOSS (dB)	PREAMP FACTOR (dB)	ANTENNA HEIGHT (cm)	TABLE ANGLE (Degree)	REMARK
5150	59.05	61.69	74	-14.95	36.29	7.42	46.35	100	25	Peak
5150	45.37	48.01	54	-8.63	36.29	7.42	46.35	100	25	Average
5310	100.1	102.56			36.39	7.46	46.31	100	25	Peak
5310	91.18	93.64			36.39	7.46	46.31	100	25	Average
5350	63.6	66.02	74	-10.4	36.41	7.47	46.3	100	25	Peak
5350	49.25	51.67	54	-4.75	36.41	7.47	46.3	100	25	Average

**REMARKS:**

- Emission Level = Read Level+ Antenna Factor + Cable Loss- Preamp Factor  
Margin value = Emission level – Limit value.
- 5310MHz: Fundamental frequency.



802.11ac (80MHz)

<b>CHANNEL</b>	TX Channel 58	<b>DETECTOR FUNCTION</b>	Peak (PK)
<b>FREQUENCY RANGE</b>	1GHz ~ 40GHz		Average (AV)

**ANTENNA POLARITY & TEST DISTANCE: HORIZONTAL AT 3 M**

FREQ. (MHz)	EMISSION LEVEL (dBuV/m)	READ LEVEL (dBuV)	LIMIT (dBuV/m)	MARGIN (dB)	ANTENNA FACTOR (dB /m)	CABLE LOSS (dB)	PREAMP FACTOR (dB)	ANTENNA HEIGHT (cm)	TABLE ANGLE (Degree)	REMARK
5150	59.17	62.15	74	-14.83	35.95	7.42	46.35	100	211	Peak
5150	44.02	47	54	-9.98	35.95	7.42	46.35	100	211	Average
5290	91.61	94.38			36.09	7.45	46.31	100	211	Peak
5290	83.65	86.42			36.09	7.45	46.31	100	211	Average
5350	61.44	64.12	74	-12.56	36.15	7.47	46.3	100	211	Peak
5350	47.8	50.48	54	-6.2	36.15	7.47	46.3	100	211	Average

**ANTENNA POLARITY & TEST DISTANCE: VERTICAL AT 3 M**

FREQ. (MHz)	EMISSION LEVEL (dBuV/m)	READ LEVEL (dBuV)	LIMIT (dBuV/m)	MARGIN (dB)	ANTENNA FACTOR (dB /m)	CABLE LOSS (dB)	PREAMP FACTOR (dB)	ANTENNA HEIGHT (cm)	TABLE ANGLE (Degree)	REMARK
5150	59.71	62.35	74	-14.29	36.29	7.42	46.35	100	45	Peak
5150	45.92	48.56	54	-8.08	36.29	7.42	46.35	100	45	Average
5290	95.75	98.24			36.37	7.45	46.31	100	45	Peak
5290	87.83	90.32			36.37	7.45	46.31	100	45	Average
5350	64.19	66.61	74	-9.81	36.41	7.47	46.3	100	45	Peak
5350	49.7	52.12	54	-4.3	36.41	7.47	46.3	100	45	Average

**REMARKS:**

- Emission Level = Read Level+ Antenna Factor + Cable Loss- Preamp Factor  
Margin value = Emission level – Limit value.
- 5290MHz: Fundamental frequency.



Band 3

802.11a

CHANNEL	TX Channel 100	DETECTOR FUNCTION	Peak (PK)
FREQUENCY RANGE	1GHz ~ 40GHz		Average (AV)

ANTENNA POLARITY & TEST DISTANCE: HORIZONTAL AT 3 M

FREQ. (MHz)	EMISSION LEVEL (dBuV/m)	READ LEVEL (dBuV)	LIMIT (dBuV/m)	MARGIN (dB)	ANTENNA FACTOR (dB /m)	CABLE LOSS (dB)	PREAMP FACTOR (dB)	ANTENNA HEIGHT (cm)	TABLE ANGLE (Degree)	REMARK
5460	60.73	63.24	74	-13.27	36.26	7.49	46.26	100	235	Peak
5460	47.62	50.13	54	-6.38	36.26	7.49	46.26	100	235	Average
#5470	60.75	63.25	68.3	-7.55	36.27	7.49	46.26	100	235	Peak
5500	102.06	104.51			36.3	7.5	46.25	100	235	Peak
5500	93.19	95.64			36.3	7.5	46.25	100	235	Average

ANTENNA POLARITY & TEST DISTANCE: VERTICAL AT 3 M

FREQ. (MHz)	EMISSION LEVEL (dBuV/m)	READ LEVEL (dBuV)	LIMIT (dBuV/m)	MARGIN (dB)	ANTENNA FACTOR (dB /m)	CABLE LOSS (dB)	PREAMP FACTOR (dB)	ANTENNA HEIGHT (cm)	TABLE ANGLE (Degree)	REMARK
5460	62.43	64.72	74	-11.57	36.48	7.49	46.26	100	123	Peak
5460	48.77	51.06	54	-5.23	36.48	7.49	46.26	100	123	Average
#5470	63.06	65.35	68.3	-5.24	36.48	7.49	46.26	100	123	Peak
5500	106.71	108.96			36.5	7.5	46.25	100	123	Peak
5500	97.62	99.87			36.5	7.5	46.25	100	123	Average

REMARKS:

1. Emission Level = Read Level+ Antenna Factor + Cable Loss- Preamp Factor  
Margin value = Emission level – Limit value.
2. 5500MHz: Fundamental frequency.
3. #: Out of restricted band.



<b>CHANNEL</b>	TX Channel 116	<b>DETECTOR FUNCTION</b>	Peak (PK)
<b>FREQUENCY RANGE</b>	1GHz ~ 40GHz		Average (AV)

**ANTENNA POLARITY & TEST DISTANCE: HORIZONTAL AT 3 M**

FREQ. (MHz)	EMISSION LEVEL (dBuV/m)	READ LEVEL (dBuV)	LIMIT (dBuV/m)	MARGIN (dB)	ANTENNA FACTOR (dB /m)	CABLE LOSS (dB)	PREAMP FACTOR (dB)	ANTENNA HEIGHT (cm)	TABLE ANGLE (Degree)	REMARK
5460	62.43	64.72	74	-11.57	36.48	7.49	46.26	100	123	Peak
5460	48.77	51.06	54	-5.23	36.48	7.49	46.26	100	123	Average
#5470	63.06	65.35	68.3	-5.24	36.48	7.49	46.26	100	123	Peak
5580	106.71	108.96			36.5	7.5	46.25	100	123	Peak
5580	97.62	99.87			36.5	7.5	46.25	100	123	Average

**ANTENNA POLARITY & TEST DISTANCE: VERTICAL AT 3 M**

FREQ. (MHz)	EMISSION LEVEL (dBuV/m)	READ LEVEL (dBuV)	LIMIT (dBuV/m)	MARGIN (dB)	ANTENNA FACTOR (dB /m)	CABLE LOSS (dB)	PREAMP FACTOR (dB)	ANTENNA HEIGHT (cm)	TABLE ANGLE (Degree)	REMARK
5460	59.48	61.77	74	-14.52	36.48	7.49	46.26	100	99	Peak
5460	45.7	47.99	54	-8.3	36.48	7.49	46.26	100	99	Average
#5470	60.31	62.6	68.3	-7.99	36.48	7.49	46.26	100	99	Peak
5580	106.54	108.64			36.55	7.58	46.23	100	99	Peak
5580	97.06	99.16			36.55	7.58	46.23	100	99	Average

**REMARKS:**

- Emission Level = Read Level+ Antenna Factor + Cable Loss- Preamp Factor  
Margin value = Emission level – Limit value.
- 5580MHz: Fundamental frequency.
- #: Out of restricted band.



<b>CHANNEL</b>	TX Channel 140	<b>DETECTOR FUNCTION</b>	Peak (PK)
<b>FREQUENCY RANGE</b>	1GHz ~ 40GHz		Average (AV)

ANTENNA POLARITY & TEST DISTANCE: HORIZONTAL AT 3 M										
FREQ. (MHz)	EMISSION LEVEL (dBuV/m)	READ LEVEL (dBuV)	LIMIT (dBuV/m)	MARGIN (dB)	ANTENNA FACTOR (dB /m)	CABLE LOSS (dB)	PREAMP FACTOR (dB)	ANTENNA HEIGHT (cm)	TABLE ANGLE (Degree)	REMARK
5700	102.1	104.21			36.38	7.7	46.19	100	241	Peak
5700	93.52	95.63			36.38	7.7	46.19	100	241	Average
#5725	62.06	64.13	68.3	-6.24	36.39	7.73	46.19	100	241	Peak
ANTENNA POLARITY & TEST DISTANCE: VERTICAL AT 3 M										
FREQ. (MHz)	EMISSION LEVEL (dBuV/m)	READ LEVEL (dBuV)	LIMIT (dBuV/m)	MARGIN (dB)	ANTENNA FACTOR (dB /m)	CABLE LOSS (dB)	PREAMP FACTOR (dB)	ANTENNA HEIGHT (cm)	TABLE ANGLE (Degree)	REMARK
5700	106.88	108.75			36.62	7.7	46.19	100	96	Peak
5700	96.36	98.23			36.62	7.7	46.19	100	96	Average
#5725	63.49	65.32	68.3	-4.81	36.63	7.73	46.19	100	96	Peak

**REMARKS:**

- Emission Level = Read Level+ Antenna Factor + Cable Loss- Preamp Factor  
Margin value = Emission level – Limit value.
- 5700MHz: Fundamental frequency.
- #: Out of restricted band.



<b>CHANNEL</b>	TX Channel 144	<b>DETECTOR FUNCTION</b>	Peak (PK)
<b>FREQUENCY RANGE</b>	1GHz ~ 40GHz		Average (AV)

ANTENNA POLARITY & TEST DISTANCE: HORIZONTAL AT 3 M										
FREQ. (MHz)	EMISSION LEVEL (dBuV/m)	READ LEVEL (dBuV)	LIMIT (dBuV/m)	MARGIN (dB)	ANTENNA FACTOR (dB /m)	CABLE LOSS (dB)	PREAMP FACTOR (dB)	ANTENNA HEIGHT (cm)	TABLE ANGLE (Degree)	REMARK
#5470	58.39	60.89	68.3	-9.91	36.27	7.49	46.26	100	0	Peak
5720	100.37	102.45			36.39	7.72	46.19	100	0	Peak
5720	90.28	92.36			36.39	7.72	46.19	100	0	Average
#5850	59.72	61.57	68.3	-8.58	36.44	7.86	46.15	100	0	Peak
ANTENNA POLARITY & TEST DISTANCE: VERTICAL AT 3 M										
FREQ. (MHz)	EMISSION LEVEL (dBuV/m)	READ LEVEL (dBuV)	LIMIT (dBuV/m)	MARGIN (dB)	ANTENNA FACTOR (dB /m)	CABLE LOSS (dB)	PREAMP FACTOR (dB)	ANTENNA HEIGHT (cm)	TABLE ANGLE (Degree)	REMARK
#5470	58.77	61.06	68.3	-9.53	36.48	7.49	46.26	100	255	Peak
5720	101.73	103.57			36.63	7.72	46.19	100	255	Peak
5720	91.59	93.43			36.63	7.72	46.19	100	255	Average
#5850	59.76	61.34	68.3	-8.54	36.71	7.86	46.15	100	255	Peak

**REMARKS:**

- Emission Level = Read Level+ Antenna Factor + Cable Loss- Preamp Factor  
Margin value = Emission level – Limit value.
- 5700MHz: Fundamental frequency.
- #: Out of restricted band.



802.11n (20MHz)

<b>CHANNEL</b>	TX Channel 100	<b>DETECTOR FUNCTION</b>	Peak (PK)
<b>FREQUENCY RANGE</b>	1GHz ~ 40GHz		Average (AV)

ANTENNA POLARITY & TEST DISTANCE: HORIZONTAL AT 3 M

FREQ. (MHz)	EMISSION LEVEL (dBuV/m)	READ LEVEL (dBuV)	LIMIT (dBuV/m)	MARGIN (dB)	ANTENNA FACTOR (dB /m)	CABLE LOSS (dB)	PREAMP FACTOR (dB)	ANTENNA HEIGHT (cm)	TABLE ANGLE (Degree)	REMARK
5460	61.67	64.18	74	-12.33	36.26	7.49	46.26	100	124	Peak
5460	47.81	50.32	54	-6.19	36.26	7.49	46.26	100	124	Average
#5470	63.25	65.75	68.3	-5.05	36.27	7.49	46.26	100	124	Peak
5500	97.91	100.36			36.3	7.5	46.25	100	124	Peak
5500	89.16	91.61			36.3	7.5	46.25	100	124	Average

ANTENNA POLARITY & TEST DISTANCE: VERTICAL AT 3 M

FREQ. (MHz)	EMISSION LEVEL (dBuV/m)	READ LEVEL (dBuV)	LIMIT (dBuV/m)	MARGIN (dB)	ANTENNA FACTOR (dB /m)	CABLE LOSS (dB)	PREAMP FACTOR (dB)	ANTENNA HEIGHT (cm)	TABLE ANGLE (Degree)	REMARK
5460	61.94	64.23	74	-12.06	36.48	7.49	46.26	100	36	Peak
5460	48.47	50.76	54	-5.53	36.48	7.49	46.26	100	36	Average
#5470	64.28	66.57	68.3	-4.02	36.48	7.49	46.26	100	36	Peak
5500	102.04	104.29			36.5	7.5	46.25	100	36	Peak
5500	93.43	95.68			36.5	7.5	46.25	100	36	Average

REMARKS:

- Emission Level = Read Level+ Antenna Factor + Cable Loss- Preamp Factor  
Margin value = Emission level – Limit value.
- 5500MHz: Fundamental frequency.
- #: Out of restricted band.



<b>CHANNEL</b>	TX Channel 116	<b>DETECTOR FUNCTION</b>	Peak (PK)
<b>FREQUENCY RANGE</b>	1GHz ~ 40GHz		Average (AV)

**ANTENNA POLARITY & TEST DISTANCE: HORIZONTAL AT 3 M**

FREQ. (MHz)	EMISSION LEVEL (dBuV/m)	READ LEVEL (dBuV)	LIMIT (dBuV/m)	MARGIN (dB)	ANTENNA FACTOR (dB /m)	CABLE LOSS (dB)	PREAMP FACTOR (dB)	ANTENNA HEIGHT (cm)	TABLE ANGLE (Degree)	REMARK
5460	58.86	61.37	74	-15.14	36.26	7.49	46.26	100	126	Peak
5460	44.84	47.35	54	-9.16	36.26	7.49	46.26	100	126	Average
#5470	60.01	62.51	68.3	-8.29	36.27	7.49	46.26	100	126	Peak
5580	98.72	101.04			36.33	7.58	46.23	100	126	Peak
5580	88.96	91.28			36.33	7.58	46.23	100	126	Average

**ANTENNA POLARITY & TEST DISTANCE: VERTICAL AT 3 M**

FREQ. (MHz)	EMISSION LEVEL (dBuV/m)	READ LEVEL (dBuV)	LIMIT (dBuV/m)	MARGIN (dB)	ANTENNA FACTOR (dB /m)	CABLE LOSS (dB)	PREAMP FACTOR (dB)	ANTENNA HEIGHT (cm)	TABLE ANGLE (Degree)	REMARK
5460	58.95	61.24	74	-15.05	36.48	7.49	46.26	100	28	Peak
5460	45.4	47.69	54	-8.6	36.48	7.49	46.26	100	28	Average
#5470	60.1	62.39	68.3	-8.2	36.48	7.49	46.26	100	28	Peak
5580	103.06	105.16			36.55	7.58	46.23	100	28	Peak
5580	94.47	96.57			36.55	7.58	46.23	100	28	Average

**REMARKS:**

- Emission Level = Read Level+ Antenna Factor + Cable Loss- Preamp Factor  
Margin value = Emission level – Limit value.
- 5580MHz: Fundamental frequency.
- #: Out of restricted band.





<b>CHANNEL</b>	TX Channel 140	<b>DETECTOR FUNCTION</b>	Peak (PK)
<b>FREQUENCY RANGE</b>	1GHz ~ 40GHz		Average (AV)

ANTENNA POLARITY & TEST DISTANCE: HORIZONTAL AT 3 M										
FREQ. (MHz)	EMISSION LEVEL (dBuV/m)	READ LEVEL (dBuV)	LIMIT (dBuV/m)	MARGIN (dB)	ANTENNA FACTOR (dB /m)	CABLE LOSS (dB)	PREAMP FACTOR (dB)	ANTENNA HEIGHT (cm)	TABLE ANGLE (Degree)	REMARK
5700	98.3	100.41			36.38	7.7	46.19	100	142	Peak
5700	89.12	91.23			36.38	7.7	46.19	100	142	Average
#5725	62.48	64.55	68.3	-5.82	36.39	7.73	46.19	100	142	Peak
ANTENNA POLARITY & TEST DISTANCE: VERTICAL AT 3 M										
FREQ. (MHz)	EMISSION LEVEL (dBuV/m)	READ LEVEL (dBuV)	LIMIT (dBuV/m)	MARGIN (dB)	ANTENNA FACTOR (dB /m)	CABLE LOSS (dB)	PREAMP FACTOR (dB)	ANTENNA HEIGHT (cm)	TABLE ANGLE (Degree)	REMARK
5700	103.34	105.21			36.62	7.7	46.19	100	31	Peak
5700	92.49	94.36			36.62	7.7	46.19	100	31	Average
#5725	64.05	65.88	68.3	-4.25	36.63	7.73	46.19	100	31	Peak

**REMARKS:**

1. Emission Level = Read Level+ Antenna Factor + Cable Loss- Preamp Factor  
Margin value = Emission level – Limit value.
2. 5700MHz: Fundamental frequency.
3. #: Out of restricted band.



<b>CHANNEL</b>	TX Channel 144	<b>DETECTOR FUNCTION</b>	Peak (PK)
<b>FREQUENCY RANGE</b>	1GHz ~ 40GHz		Average (AV)

**ANTENNA POLARITY & TEST DISTANCE: HORIZONTAL AT 3 M**

FREQ. (MHz)	EMISSION LEVEL (dBuV/m)	READ LEVEL (dBuV)	LIMIT (dBuV/m)	MARGIN (dB)	ANTENNA FACTOR (dB /m)	CABLE LOSS (dB)	PREAMP FACTOR (dB)	ANTENNA HEIGHT (cm)	TABLE ANGLE (Degree)	REMARK
#5470	59.02	61.52	68.3	-9.28	36.27	7.49	46.26	100	122	Peak
5720	101.5	103.58			36.39	7.72	46.19	100	122	Peak
5720	90.61	92.69			36.39	7.72	46.19	100	122	Average
#5850	59.6	61.45	68.3	-8.7	36.44	7.86	46.15	100	115	Peak

**ANTENNA POLARITY & TEST DISTANCE: VERTICAL AT 3 M**

FREQ. (MHz)	EMISSION LEVEL (dBuV/m)	READ LEVEL (dBuV)	LIMIT (dBuV/m)	MARGIN (dB)	ANTENNA FACTOR (dB /m)	CABLE LOSS (dB)	PREAMP FACTOR (dB)	ANTENNA HEIGHT (cm)	TABLE ANGLE (Degree)	REMARK
#5470	58.77	61.06	68.3	-9.53	36.48	7.49	46.26	100	315	Peak
5720	101.8	103.64			36.63	7.72	46.19	100	315	Peak
5720	91.68	93.52			36.63	7.72	46.19	100	315	Average
#5850	60.72	62.3	68.3	-7.58	36.71	7.86	46.15	100	315	Peak

**REMARKS:**

- Emission Level = Read Level+ Antenna Factor + Cable Loss- Preamp Factor  
Margin value = Emission level – Limit value.
- 5720MHz: Fundamental frequency.
- #: Out of restricted band



**802.11n (40MHz)**

<b>CHANNEL</b>	TX Channel 102	<b>DETECTOR FUNCTION</b>	Peak (PK)
<b>FREQUENCY RANGE</b>	1GHz ~ 40GHz		Average (AV)

<b>ANTENNA POLARITY &amp; TEST DISTANCE: HORIZONTAL AT 3 M</b>										
FREQ. (MHz)	EMISSION LEVEL (dBuV/m)	READ LEVEL (dBuV)	LIMIT (dBuV/m)	MARGIN (dB)	ANTENNA FACTOR (dB /m)	CABLE LOSS (dB)	PREAMP FACTOR (dB)	ANTENNA HEIGHT (cm)	TABLE ANGLE (Degree)	REMARK
5460	61.38	63.89	74	-12.62	36.26	7.49	46.26	100	135	Peak
5460	47.25	49.76	54	-6.75	36.26	7.49	46.26	100	135	Average
#5470	62.84	65.34	68.3	-5.46	36.27	7.49	46.26	100	135	Peak
5510	97.2	99.64			36.3	7.51	46.25	100	135	Peak
5510	87.69	90.13			36.3	7.51	46.25	100	135	Average
<b>ANTENNA POLARITY &amp; TEST DISTANCE: VERTICAL AT 3 M</b>										
FREQ. (MHz)	EMISSION LEVEL (dBuV/m)	READ LEVEL (dBuV)	LIMIT (dBuV/m)	MARGIN (dB)	ANTENNA FACTOR (dB /m)	CABLE LOSS (dB)	PREAMP FACTOR (dB)	ANTENNA HEIGHT (cm)	TABLE ANGLE (Degree)	REMARK
5460	61.83	64.12	74	-12.17	36.48	7.49	46.26	100	21	Peak
5460	48.1	50.39	54	-5.9	36.48	7.49	46.26	100	21	Average
#5470	63.75	66.04	68.3	-4.55	36.48	7.49	46.26	100	21	Peak
5510	98.15	100.38			36.51	7.51	46.25	100	21	Peak
5510	89.16	91.39			36.51	7.51	46.25	100	21	Average

**REMARKS:**

1. Emission Level = Read Level+ Antenna Factor + Cable Loss- Preamp Factor  
Margin value = Emission level – Limit value.
2. 5510MHz: Fundamental frequency.
3. #: Out of restricted band.



<b>CHANNEL</b>	TX Channel 110	<b>DETECTOR FUNCTION</b>	Peak (PK)
<b>FREQUENCY RANGE</b>	1GHz ~ 40GHz		Average (AV)

**ANTENNA POLARITY & TEST DISTANCE: HORIZONTAL AT 3 M**

FREQ. (MHz)	EMISSION LEVEL (dBuV/m)	READ LEVEL (dBuV)	LIMIT (dBuV/m)	MARGIN (dB)	ANTENNA FACTOR (dB /m)	CABLE LOSS (dB)	PREAMP FACTOR (dB)	ANTENNA HEIGHT (cm)	TABLE ANGLE (Degree)	REMARK
5460	59.37	61.88	74	-14.63	36.26	7.49	46.26	100	142	Peak
5460	45.4	47.91	54	-8.6	36.26	7.49	46.26	100	142	Average
#5470	59.86	62.36	68.3	-8.44	36.27	7.49	46.26	100	142	Peak
5550	95.88	98.25			36.32	7.55	46.24	100	142	Peak
5550	87.28	89.65			36.32	7.55	46.24	100	142	Average

**ANTENNA POLARITY & TEST DISTANCE: VERTICAL AT 3 M**

FREQ. (MHz)	EMISSION LEVEL (dBuV/m)	READ LEVEL (dBuV)	LIMIT (dBuV/m)	MARGIN (dB)	ANTENNA FACTOR (dB /m)	CABLE LOSS (dB)	PREAMP FACTOR (dB)	ANTENNA HEIGHT (cm)	TABLE ANGLE (Degree)	REMARK
5460	59.56	61.85	74	-14.44	36.48	7.49	46.26	100	12	Peak
5460	46.03	48.32	54	-7.97	36.48	7.49	46.26	100	12	Average
#5470	60.23	62.52	68.3	-8.07	36.48	7.49	46.26	100	12	Peak
5550	100.46	102.62			36.53	7.55	46.24	100	12	Peak
5550	90.29	92.45			36.53	7.55	46.24	100	12	Average

**REMARKS:**

- Emission Level = Read Level+ Antenna Factor + Cable Loss- Preamp Factor  
Margin value = Emission level – Limit value.
- 5550MHz: Fundamental frequency.
- #: Out of restricted band.



<b>CHANNEL</b>	TX Channel 134	<b>DETECTOR FUNCTION</b>	Peak (PK)
<b>FREQUENCY RANGE</b>	1GHz ~ 40GHz		Average (AV)

ANTENNA POLARITY & TEST DISTANCE: HORIZONTAL AT 3 M										
FREQ. (MHz)	EMISSION LEVEL (dBuV/m)	READ LEVEL (dBuV)	LIMIT (dBuV/m)	MARGIN (dB)	ANTENNA FACTOR (dB /m)	CABLE LOSS (dB)	PREAMP FACTOR (dB)	ANTENNA HEIGHT (cm)	TABLE ANGLE (Degree)	REMARK
5670	96.47	98.63			36.37	7.67	46.2	100	128	Peak
5670	86.59	88.75			36.37	7.67	46.2	100	128	Average
#5725	62.19	64.26	68.3	-6.11	36.39	7.73	46.19	100	128	Peak
ANTENNA POLARITY & TEST DISTANCE: VERTICAL AT 3 M										
FREQ. (MHz)	EMISSION LEVEL (dBuV/m)	READ LEVEL (dBuV)	LIMIT (dBuV/m)	MARGIN (dB)	ANTENNA FACTOR (dB /m)	CABLE LOSS (dB)	PREAMP FACTOR (dB)	ANTENNA HEIGHT (cm)	TABLE ANGLE (Degree)	REMARK
5670	99.61	101.54			36.6	7.67	46.2	100	25	Peak
5670	89.7	91.63			36.6	7.67	46.2	100	25	Average
#5725	64.32	66.15	68.3	-3.98	36.63	7.73	46.19	100	25	Peak

**REMARKS:**

- Emission Level = Read Level+ Antenna Factor + Cable Loss- Preamp Factor  
Margin value = Emission level – Limit value.
- 5670MHz: Fundamental frequency.
- #: Out of restricted band.



<b>CHANNEL</b>	TX Channel 142	<b>DETECTOR FUNCTION</b>	Peak (PK)
<b>FREQUENCY RANGE</b>	1GHz ~ 40GHz		Average (AV)

ANTENNA POLARITY & TEST DISTANCE: HORIZONTAL AT 3 M										
FREQ. (MHz)	EMISSION LEVEL (dBuV/m)	READ LEVEL (dBuV)	LIMIT (dBuV/m)	MARGIN (dB)	ANTENNA FACTOR (dB /m)	CABLE LOSS (dB)	PREAMP FACTOR (dB)	ANTENNA HEIGHT (cm)	TABLE ANGLE (Degree)	REMARK
#5470	58.74	61.24	68.3	-9.56	36.27	7.49	46.26	100	116	Peak
5710	101.16	103.26			36.38	7.71	46.19	100	116	Peak
5710	90.78	92.88			36.38	7.71	46.19	100	116	Average
#5850	60.1	61.95	68.3	-8.2	36.44	7.86	46.15	100	116	Peak
ANTENNA POLARITY & TEST DISTANCE: VERTICAL AT 3 M										
FREQ. (MHz)	EMISSION LEVEL (dBuV/m)	READ LEVEL (dBuV)	LIMIT (dBuV/m)	MARGIN (dB)	ANTENNA FACTOR (dB /m)	CABLE LOSS (dB)	PREAMP FACTOR (dB)	ANTENNA HEIGHT (cm)	TABLE ANGLE (Degree)	REMARK
#5470	58.28	60.57	68.3	-10.02	36.48	7.49	46.26	100	312	Peak
5710	100.73	102.58			36.63	7.71	46.19	100	312	Peak
5710	90.5	92.35			36.63	7.71	46.19	100	312	Average
#5850	60.56	62.14	68.3	-7.74	36.71	7.86	46.15	100	312	Peak

**REMARKS:**

- Emission Level = Read Level+ Antenna Factor + Cable Loss- Preamp Factor  
Margin value = Emission level – Limit value.
- 5710MHz: Fundamental frequency.
- #: Out of restricted band



802.11ac (80MHz)

<b>CHANNEL</b>	TX Channel 106	<b>DETECTOR FUNCTION</b>	Peak (PK)
<b>FREQUENCY RANGE</b>	1GHz ~ 40GHz		Average (AV)

**ANTENNA POLARITY & TEST DISTANCE: HORIZONTAL AT 3 M**

FREQ. (MHz)	EMISSION LEVEL (dBuV/m)	READ LEVEL (dBuV)	LIMIT (dBuV/m)	MARGIN (dB)	ANTENNA FACTOR (dB /m)	CABLE LOSS (dB)	PREAMP FACTOR (dB)	ANTENNA HEIGHT (cm)	TABLE ANGLE (Degree)	REMARK
5460	61.81	64.32	74	-12.19	36.26	7.49	46.26	100	132	Peak
5460	47.3	49.81	54	-6.7	36.26	7.49	46.26	100	132	Average
#5470	63.37	65.87	68.3	-4.93	36.27	7.49	46.26	100	132	Peak
5530	95.02	97.42			36.31	7.53	46.24	100	132	Peak
5530	86.29	88.69			36.31	7.53	46.24	100	132	Average

**ANTENNA POLARITY & TEST DISTANCE: VERTICAL AT 3 M**

FREQ. (MHz)	EMISSION LEVEL (dBuV/m)	READ LEVEL (dBuV)	LIMIT (dBuV/m)	MARGIN (dB)	ANTENNA FACTOR (dB /m)	CABLE LOSS (dB)	PREAMP FACTOR (dB)	ANTENNA HEIGHT (cm)	TABLE ANGLE (Degree)	REMARK
5460	62.29	64.58	74	-11.71	36.48	7.49	46.26	100	16	Peak
5460	48.1	50.39	54	-5.9	36.48	7.49	46.26	100	16	Average
#5470	63.66	65.95	68.3	-4.64	36.48	7.49	46.26	100	16	Peak
5530	97.42	99.61			36.52	7.53	46.24	100	16	Peak
5530	87.96	90.15			36.52	7.53	46.24	100	16	Average

**REMARKS:**

- Emission Level = Read Level+ Antenna Factor + Cable Loss- Preamp Factor  
Margin value = Emission level – Limit value.
- 5530MHz: Fundamental frequency.
- #: Out of restricted band.



<b>CHANNEL</b>	TX Channel 122	<b>DETECTOR FUNCTION</b>	Peak (PK)
<b>FREQUENCY RANGE</b>	1GHz ~ 40GHz		Average (AV)

ANTENNA POLARITY & TEST DISTANCE: HORIZONTAL AT 3 M										
FREQ. (MHz)	EMISSION LEVEL (dBuV/m)	READ LEVEL (dBuV)	LIMIT (dBuV/m)	MARGIN (dB)	ANTENNA FACTOR (dB /m)	CABLE LOSS (dB)	PREAMP FACTOR (dB)	ANTENNA HEIGHT (cm)	TABLE ANGLE (Degree)	REMARK
5610	94.28	96.55			36.34	7.61	46.22	100	325	Peak
5610	85.06	87.33			36.34	7.61	46.22	100	325	Average
#5725	62.82	64.89	68.3	-5.48	36.39	7.73	46.19	100	325	Peak
ANTENNA POLARITY & TEST DISTANCE: VERTICAL AT 3 M										
FREQ. (MHz)	EMISSION LEVEL (dBuV/m)	READ LEVEL (dBuV)	LIMIT (dBuV/m)	MARGIN (dB)	ANTENNA FACTOR (dB /m)	CABLE LOSS (dB)	PREAMP FACTOR (dB)	ANTENNA HEIGHT (cm)	TABLE ANGLE (Degree)	REMARK
5610	96.31	98.35			36.57	7.61	46.22	100	186	Peak
5610	88.25	90.29			36.57	7.61	46.22	100	186	Average
#5725	63.66	65.49	68.3	-4.64	36.63	7.73	46.19	100	186	Peak

REMARKS:

- Emission Level = Read Level+ Antenna Factor + Cable Loss- Preamp Factor  
Margin value = Emission level – Limit value.
- 5610MHz: Fundamental frequency.
- #: Out of restricted band.





**Band 4:**

**802.11a**

<b>CHANNEL</b>	TX Channel 149	<b>DETECTOR FUNCTION</b>	Peak (PK)
<b>FREQUENCY RANGE</b>	1GHz ~ 40GHz		Average (AV)

<b>ANTENNA POLARITY &amp; TEST DISTANCE: HORIZONTAL AT 3 M</b>										
<b>FREQ. (MHz)</b>	<b>EMISSION LEVEL (dBuV/m)</b>	<b>READ LEVEL (dBuV)</b>	<b>LIMIT (dBuV/m)</b>	<b>MARGIN (dB)</b>	<b>ANTENNA FACTOR (dB /m)</b>	<b>CABLE LOSS (dB)</b>	<b>PREAMP FACTOR (dB)</b>	<b>ANTENNA HEIGHT (cm)</b>	<b>TABLE ANGLE (Degree)</b>	<b>REMARK</b>
5745	108.43	103.21			35.19	16.31	46.28	100	311	Peak
5745	99.58	94.36			35.19	16.31	46.28	100	311	Average
<b>ANTENNA POLARITY &amp; TEST DISTANCE: VERTICAL AT 3 M</b>										
<b>FREQ. (MHz)</b>	<b>EMISSION LEVEL (dBuV/m)</b>	<b>READ LEVEL (dBuV)</b>	<b>LIMIT (dBuV/m)</b>	<b>MARGIN (dB)</b>	<b>ANTENNA FACTOR (dB /m)</b>	<b>CABLE LOSS (dB)</b>	<b>PREAMP FACTOR (dB)</b>	<b>ANTENNA HEIGHT (cm)</b>	<b>TABLE ANGLE (Degree)</b>	<b>REMARK</b>
5745	113.85	108.63			35.19	16.31	46.28	100	211	Peak
5745	103.47	98.25			35.19	16.31	46.28	100	211	Average

**REMARKS:**

- Emission Level = Read Level+ Antenna Factor + Cable Loss- Preamp Factor  
Margin value = Emission level – Limit value.
- 5745MHz: Fundamental frequency.



**Oobe Data**

**802.11a**

ANTENNA POLARITY & TEST DISTANCE: HORIZONTAL AT 3 M										
FREQ. (MHz)	EMISSION LEVEL (dBuV/m)	READ LEVEL (dBuV)	LIMIT (dBuV/m)	MARGIN (dB)	ANTENNA FACTOR (dB /m)	CABLE LOSS (dB)	PREAMP FACTOR (dB)	ANTENNA HEIGHT (cm)	TABLE ANGLE (Degree)	REMARK
5591.325	54.88	50.84	68.3	-13.42	35.01	15.31	46.28	100	311	Peak
5965.15	57.58	50.66	68.3	-10.72	35.46	17.74	46.28	100	311	Peak
ANTENNA POLARITY & TEST DISTANCE: VERTICAL AT 3 M										
FREQ. (MHz)	EMISSION LEVEL (dBuV/m)	READ LEVEL (dBuV)	LIMIT (dBuV/m)	MARGIN (dB)	ANTENNA FACTOR (dB /m)	CABLE LOSS (dB)	PREAMP FACTOR (dB)	ANTENNA HEIGHT (cm)	TABLE ANGLE (Degree)	REMARK
5576.6	54.97	51.05	68.3	-13.33	34.99	15.21	46.28	102	211	Peak
5953.275	57.6	50.77	68.3	-10.7	35.44	17.67	46.28	102	211	Peak

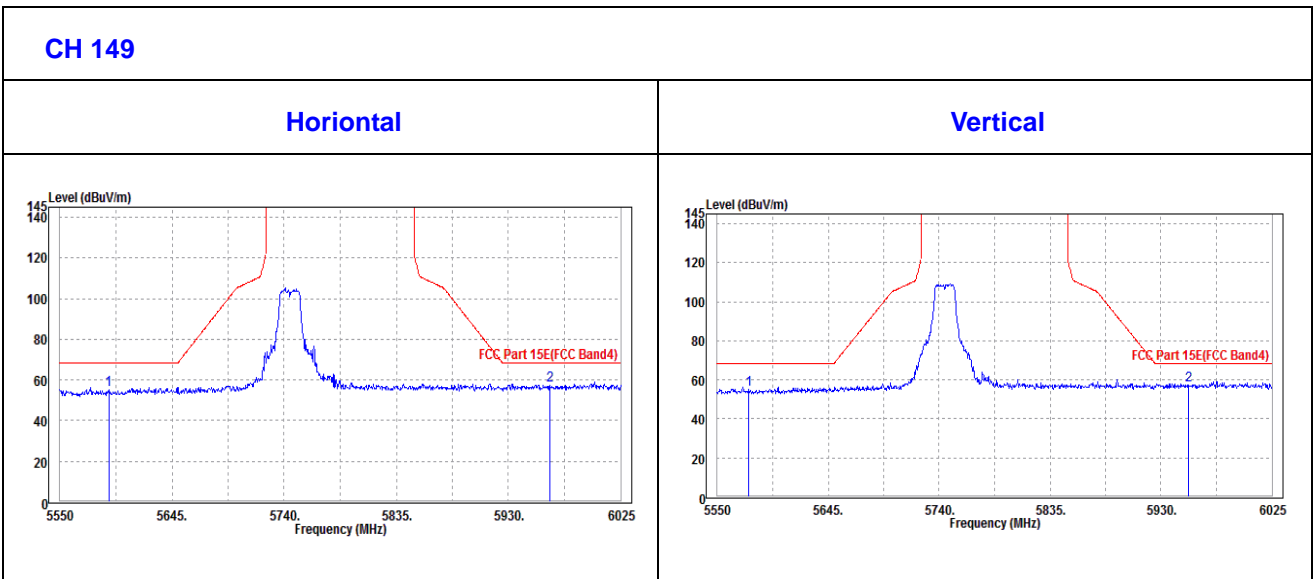



<b>CHANNEL</b>	TX Channel 157	<b>DETECTOR FUNCTION</b>	Peak (PK)
<b>FREQUENCY RANGE</b>	1GHz ~ 40GHz		Average (AV)

**ANTENNA POLARITY & TEST DISTANCE: HORIZONTAL AT 3 M**

FREQ. (MHz)	EMISSION LEVEL (dBuV/m)	READ LEVEL (dBuV)	LIMIT (dBuV/m)	MARGIN (dB)	ANTENNA FACTOR (dB /m)	CABLE LOSS (dB)	PREAMP FACTOR (dB)	ANTENNA HEIGHT (cm)	TABLE ANGLE (Degree)	REMARK
5785	107.68	102.15			35.24	16.57	46.28	100	78	Peak
5785	98.94	93.41			35.24	16.57	46.28	100	78	Average

**ANTENNA POLARITY & TEST DISTANCE: VERTICAL AT 3 M**

FREQ. (MHz)	EMISSION LEVEL (dBuV/m)	READ LEVEL (dBuV)	LIMIT (dBuV/m)	MARGIN (dB)	ANTENNA FACTOR (dB /m)	CABLE LOSS (dB)	PREAMP FACTOR (dB)	ANTENNA HEIGHT (cm)	TABLE ANGLE (Degree)	REMARK
5785	112.88	107.35			35.24	16.57	46.28	100	122	Peak
5785	103.76	98.23			35.24	16.57	46.28	100	122	Average

**REMARKS:**

- Emission Level = Read Level+ Antenna Factor + Cable Loss- Preamp Factor  
Margin value = Emission level – Limit value.
- 5785MHz: Fundamental frequency.



**Oobe Data**

**802.11a**

ANTENNA POLARITY & TEST DISTANCE: HORIZONTAL AT 3 M										
FREQ. (MHz)	EMISSION LEVEL (dBuV/m)	READ LEVEL (dBuV)	LIMIT (dBuV/m)	MARGIN (dB)	ANTENNA FACTOR (dB /m)	CABLE LOSS (dB)	PREAMP FACTOR (dB)	ANTENNA HEIGHT (cm)	TABLE ANGLE (Degree)	REMARK
5606.05	56.75	52.6	68.3	-11.55	35.03	15.4	46.28	400	315	Peak
5939.975	59.61	52.88	68.3	-8.69	35.43	17.58	46.28	400	315	Peak
ANTENNA POLARITY & TEST DISTANCE: VERTICAL AT 3 M										
FREQ. (MHz)	EMISSION LEVEL (dBuV/m)	READ LEVEL (dBuV)	LIMIT (dBuV/m)	MARGIN (dB)	ANTENNA FACTOR (dB /m)	CABLE LOSS (dB)	PREAMP FACTOR (dB)	ANTENNA HEIGHT (cm)	TABLE ANGLE (Degree)	REMARK
5573.75	56.36	52.46	68.3	-11.94	34.99	15.19	46.28	400	315	Peak
5956.6	59.25	52.39	68.3	-9.05	35.45	17.69	46.28	400	315	Peak

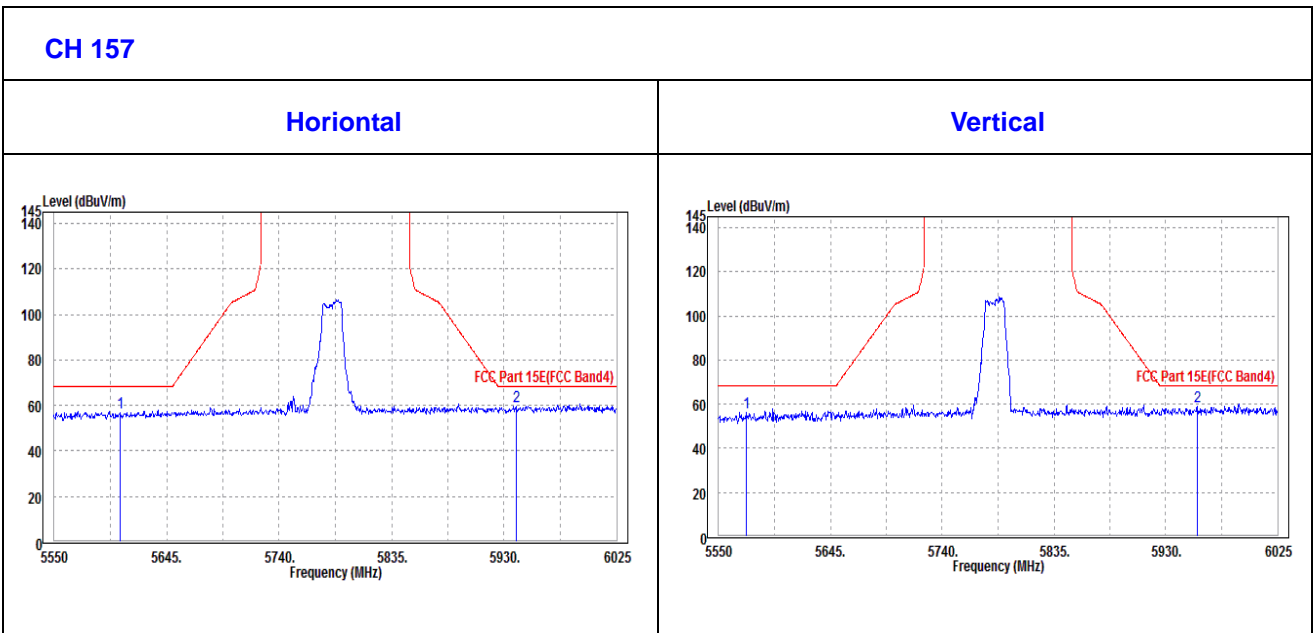



<b>CHANNEL</b>	TX Channel 161	<b>DETECTOR FUNCTION</b>	Peak (PK)
<b>FREQUENCY RANGE</b>	1GHz ~ 40GHz		Average (AV)

**ANTENNA POLARITY & TEST DISTANCE: HORIZONTAL AT 3 M**

FREQ. (MHz)	EMISSION LEVEL (dBuV/m)	READ LEVEL (dBuV)	LIMIT (dBuV/m)	MARGIN (dB)	ANTENNA FACTOR (dB /m)	CABLE LOSS (dB)	PREAMP FACTOR (dB)	ANTENNA HEIGHT (cm)	TABLE ANGLE (Degree)	REMARK
5805	102.75	103.52			37.58	7.81	46.16	100	135	Peak
5805	92.68	93.45			37.58	7.81	46.16	100	135	Average

**ANTENNA POLARITY & TEST DISTANCE: VERTICAL AT 3 M**

FREQ. (MHz)	EMISSION LEVEL (dBuV/m)	READ LEVEL (dBuV)	LIMIT (dBuV/m)	MARGIN (dB)	ANTENNA FACTOR (dB /m)	CABLE LOSS (dB)	PREAMP FACTOR (dB)	ANTENNA HEIGHT (cm)	TABLE ANGLE (Degree)	REMARK
5805	104.51	105.28			37.58	7.81	46.16	100	25	Peak
5805	94.9	95.67			37.58	7.81	46.16	100	25	Average

**REMARKS:**

- Emission Level = Read Level+ Antenna Factor + Cable Loss- Preamp Factor  
Margin value = Emission level – Limit value.
- 5805MHz: Fundamental frequency.



**Oobe Data**

802.11a

ANTENNA POLARITY & TEST DISTANCE: HORIZONTAL AT 3 M										
FREQ. (MHz)	EMISSION LEVEL (dBuV/m)	READ LEVEL (dBuV)	LIMIT (dBuV/m)	MARGIN (dB)	ANTENNA FACTOR (dB /m)	CABLE LOSS (dB)	PREAMP FACTOR (dB)	ANTENNA HEIGHT (cm)	TABLE ANGLE (Degree)	REMARK
5599.875	48.55	46.55	68.3	-19.75	36.34	7.6	41.94	100	130	Peak
5961.35	48.76	46.49	68.3	-19.54	36.48	7.97	42.18	100	130	Peak
ANTENNA POLARITY & TEST DISTANCE: VERTICAL AT 3 M										
FREQ. (MHz)	EMISSION LEVEL (dBuV/m)	READ LEVEL (dBuV)	LIMIT (dBuV/m)	MARGIN (dB)	ANTENNA FACTOR (dB /m)	CABLE LOSS (dB)	PREAMP FACTOR (dB)	ANTENNA HEIGHT (cm)	TABLE ANGLE (Degree)	REMARK
5590.85	53.05	50.85	68.3	-15.25	36.55	7.59	41.94	100	130	Peak
5974.65	54.29	51.71	68.3	-14.01	36.78	7.98	42.18	100	130	Peak

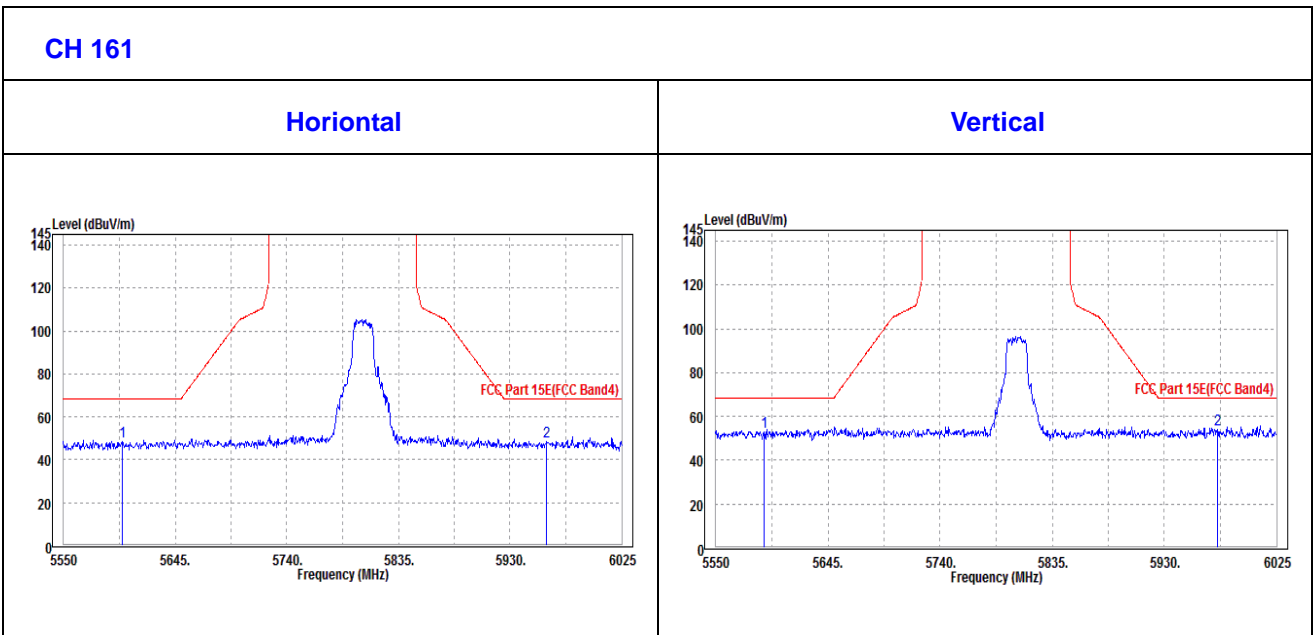



**802.11n (20MHz)**

<b>CHANNEL</b>	TX Channel 149	<b>DETECTOR FUNCTION</b>	Peak (PK)
<b>FREQUENCY RANGE</b>	1GHz ~ 40GHz		Average (AV)

<b>ANTENNA POLARITY &amp; TEST DISTANCE: HORIZONTAL AT 3 M</b>										
<b>FREQ. (MHz)</b>	<b>EMISSION LEVEL (dBuV/m)</b>	<b>READ LEVEL (dBuV)</b>	<b>LIMIT (dBuV/m)</b>	<b>MARGIN (dB)</b>	<b>ANTENNA FACTOR (dB /m)</b>	<b>CABLE LOSS (dB)</b>	<b>PREAMP FACTOR (dB)</b>	<b>ANTENNA HEIGHT (cm)</b>	<b>TABLE ANGLE (Degree)</b>	<b>REMARK</b>
5745	106.61	101.39			35.19	16.31	46.28	100	164	Peak
5745	97.75	92.53			35.19	16.31	46.28	100	164	Average
<b>ANTENNA POLARITY &amp; TEST DISTANCE: VERTICAL AT 3 M</b>										
<b>FREQ. (MHz)</b>	<b>EMISSION LEVEL (dBuV/m)</b>	<b>READ LEVEL (dBuV)</b>	<b>LIMIT (dBuV/m)</b>	<b>MARGIN (dB)</b>	<b>ANTENNA FACTOR (dB /m)</b>	<b>CABLE LOSS (dB)</b>	<b>PREAMP FACTOR (dB)</b>	<b>ANTENNA HEIGHT (cm)</b>	<b>TABLE ANGLE (Degree)</b>	<b>REMARK</b>
5745	110.43	105.21			35.19	16.31	46.28	100	80	Peak
5745	100.89	95.67			35.19	16.31	46.28	100	80	Average

**REMARKS:**

- Emission Level = Read Level+ Antenna Factor + Cable Loss- Preamp Factor  
Margin value = Emission level – Limit value.
- 5745MHz: Fundamental frequency.



**OBE DATA**

**802.11n (20MHZ)**

ANTENNA POLARITY & TEST DISTANCE: HORIZONTAL AT 3 M										
FREQ. (MHz)	EMISSION LEVEL (dBuV/m)	READ LEVEL (dBuV)	LIMIT (dBuV/m)	MARGIN (dB)	ANTENNA FACTOR (dB /m)	CABLE LOSS (dB)	PREAMP FACTOR (dB)	ANTENNA HEIGHT (cm)	TABLE ANGLE (Degree)	REMARK
5580.4	55.28	51.33	68.3	-13.02	35	15.23	46.28	100	164	Peak
5975.6	58.46	51.46	68.3	-9.84	35.47	17.81	46.28	100	164	Peak
ANTENNA POLARITY & TEST DISTANCE: VERTICAL AT 3 M										
FREQ. (MHz)	EMISSION LEVEL (dBuV/m)	READ LEVEL (dBuV)	LIMIT (dBuV/m)	MARGIN (dB)	ANTENNA FACTOR (dB /m)	CABLE LOSS (dB)	PREAMP FACTOR (dB)	ANTENNA HEIGHT (cm)	TABLE ANGLE (Degree)	REMARK
5568.525	55.27	51.41	68.3	-13.03	34.98	15.16	46.28	102	80	Peak
5965.15	58.51	51.59	68.3	-9.79	35.46	17.74	46.28	102	80	Peak

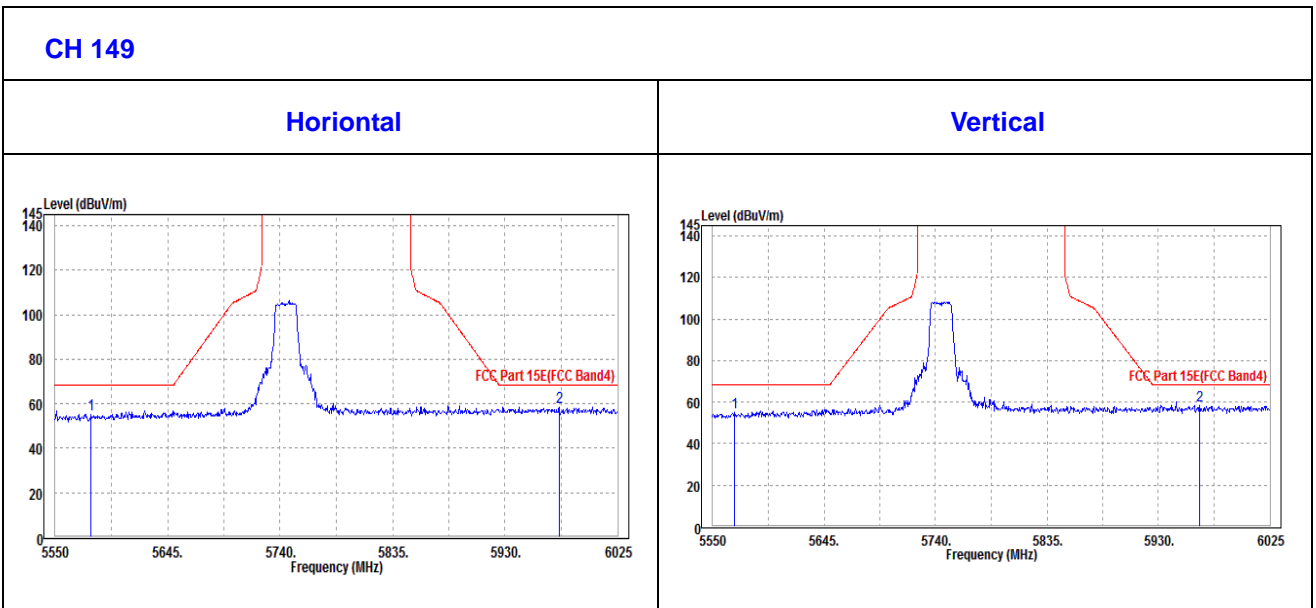





<b>CHANNEL</b>	TX Channel 157	<b>DETECTOR FUNCTION</b>	Peak (PK)
<b>FREQUENCY RANGE</b>	1GHz ~ 40GHz		Average (AV)

**ANTENNA POLARITY & TEST DISTANCE: HORIZONTAL AT 3 M**

FREQ. (MHz)	EMISSION LEVEL (dBuV/m)	READ LEVEL (dBuV)	LIMIT (dBuV/m)	MARGIN (dB)	ANTENNA FACTOR (dB /m)	CABLE LOSS (dB)	PREAMP FACTOR (dB)	ANTENNA HEIGHT (cm)	TABLE ANGLE (Degree)	REMARK
5785	107.94	102.41			35.24	16.57	46.28	100	44	Peak
5785	98.78	93.25			35.24	16.57	46.28	100	44	Average

**ANTENNA POLARITY & TEST DISTANCE: VERTICAL AT 3 M**

FREQ. (MHz)	EMISSION LEVEL (dBuV/m)	READ LEVEL (dBuV)	LIMIT (dBuV/m)	MARGIN (dB)	ANTENNA FACTOR (dB /m)	CABLE LOSS (dB)	PREAMP FACTOR (dB)	ANTENNA HEIGHT (cm)	TABLE ANGLE (Degree)	REMARK
5785	110.69	105.16			35.24	16.57	46.28	100	165	Peak
5785	101.89	96.36			35.24	16.57	46.28	100	165	Average

**REMARKS:**

- Emission Level = Read Level+ Antenna Factor + Cable Loss- Preamp Factor  
Margin value = Emission level – Limit value.
- 5785MHz: Fundamental frequency.



**OBE DATA**

**802.11n (20MHZ)**

ANTENNA POLARITY & TEST DISTANCE: HORIZONTAL AT 3 M										
FREQ. (MHz)	EMISSION LEVEL (dBuV/m)	READ LEVEL (dBuV)	LIMIT (dBuV /m)	MARGIN (dB)	ANTENNA FACTOR (dB /m)	CABLE LOSS (dB)	PREAMP FACTOR (dB)	ANTENNA HEIGHT (cm)	TABLE ANGLE (Degree)	REMARK
5578.975	54.32	50.39	68.3	-13.98	34.99	15.22	46.28	400	315	Peak
5959.925	58.27	51.39	68.3	-10.03	35.45	17.71	46.28	400	315	Peak
ANTENNA POLARITY & TEST DISTANCE: VERTICAL AT 3 M										
FREQ. (MHz)	EMISSION LEVEL (dBuV/m)	READ LEVEL (dBuV)	LIMIT (dBuV /m)	MARGIN (dB)	ANTENNA FACTOR (dB /m)	CABLE LOSS (dB)	PREAMP FACTOR (dB)	ANTENNA HEIGHT (cm)	TABLE ANGLE (Degree)	REMARK
5603.675	55.99	51.86	68.3	-12.31	35.02	15.39	46.28	400	315	Peak
6006.475	59.46	52.3	68.3	-8.84	35.5	17.94	46.28	400	315	Peak

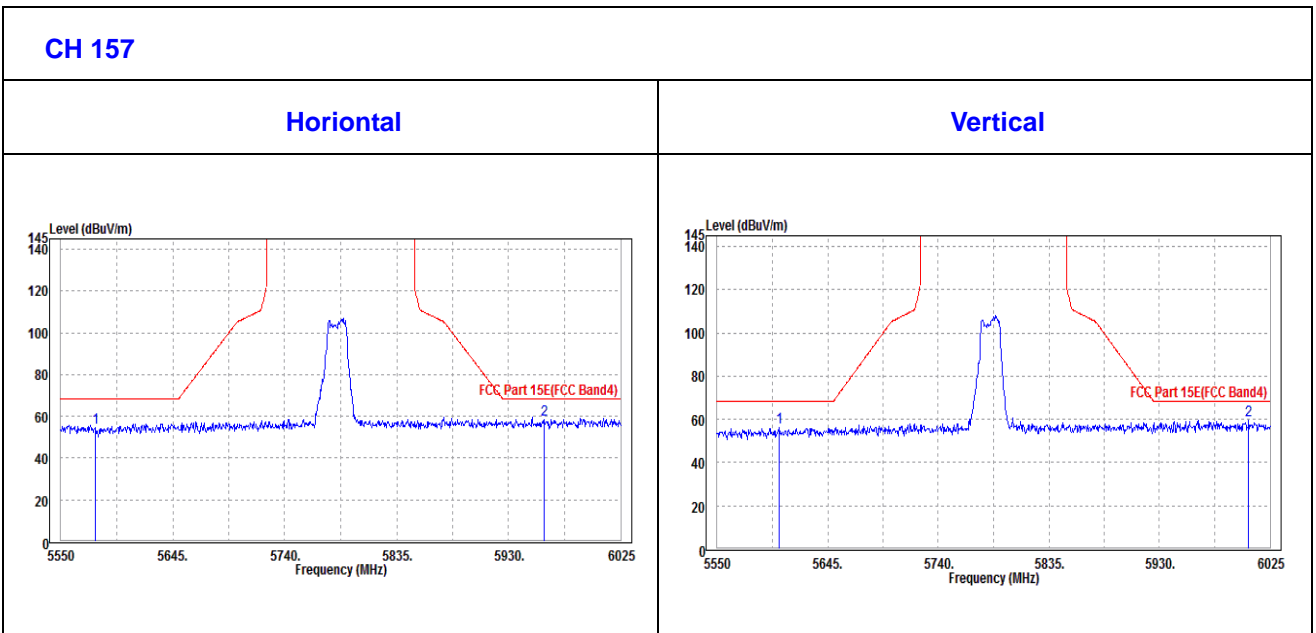



<b>CHANNEL</b>	TX Channel 161	<b>DETECTOR FUNCTION</b>	Peak (PK)
<b>FREQUENCY RANGE</b>	1GHz ~ 40GHz		Average (AV)

**ANTENNA POLARITY & TEST DISTANCE: HORIZONTAL AT 3 M**

FREQ. (MHz)	EMISSION LEVEL (dBuV/m)	READ LEVEL (dBuV)	LIMIT (dBuV/m)	MARGIN (dB)	ANTENNA FACTOR (dB /m)	CABLE LOSS (dB)	PREAMP FACTOR (dB)	ANTENNA HEIGHT (cm)	TABLE ANGLE (Degree)	REMARK
5805	100.54	101.31			37.58	7.81	46.16	100	126	Peak
5805	91.51	92.28			37.58	7.81	46.16	100	126	Average

**ANTENNA POLARITY & TEST DISTANCE: VERTICAL AT 3 M**

FREQ. (MHz)	EMISSION LEVEL (dBuV/m)	READ LEVEL (dBuV)	LIMIT (dBuV/m)	MARGIN (dB)	ANTENNA FACTOR (dB /m)	CABLE LOSS (dB)	PREAMP FACTOR (dB)	ANTENNA HEIGHT (cm)	TABLE ANGLE (Degree)	REMARK
5805	101.61	102.38			37.58	7.81	46.16	100	236	Peak
5805	91.71	92.48			37.58	7.81	46.16	100	236	Average

**REMARKS:**

- Emission Level = Read Level+ Antenna Factor + Cable Loss- Preamp Factor  
Margin value = Emission level – Limit value.
- 5805MHz: Fundamental frequency.



**OUBE DATA**

**802.11n (20MHZ)**

ANTENNA POLARITY & TEST DISTANCE: HORIZONTAL AT 3 M										
FREQ. (MHz)	EMISSION LEVEL (dBuV/m)	READ LEVEL (dBuV)	LIMIT (dBuV/m)	MARGIN (dB)	ANTENNA FACTOR (dB /m)	CABLE LOSS (dB)	PREAMP FACTOR (dB)	ANTENNA HEIGHT (cm)	TABLE ANGLE (Degree)	REMARK
5595.6	48.09	46.09	68.3	-20.21	36.34	7.6	41.94	100	130	Peak
5988.9	47.78	45.47	68.3	-20.52	36.5	8	42.19	100	130	Peak
ANTENNA POLARITY & TEST DISTANCE: VERTICAL AT 3 M										
FREQ. (MHz)	EMISSION LEVEL (dBuV/m)	READ LEVEL (dBuV)	LIMIT (dBuV/m)	MARGIN (dB)	ANTENNA FACTOR (dB /m)	CABLE LOSS (dB)	PREAMP FACTOR (dB)	ANTENNA HEIGHT (cm)	TABLE ANGLE (Degree)	REMARK
5565.2	53.52	51.33	68.3	-14.78	36.54	7.57	41.92	100	130	Peak
5997.45	53.65	51.04	68.3	-14.65	36.8	8.01	42.2	100	130	Peak

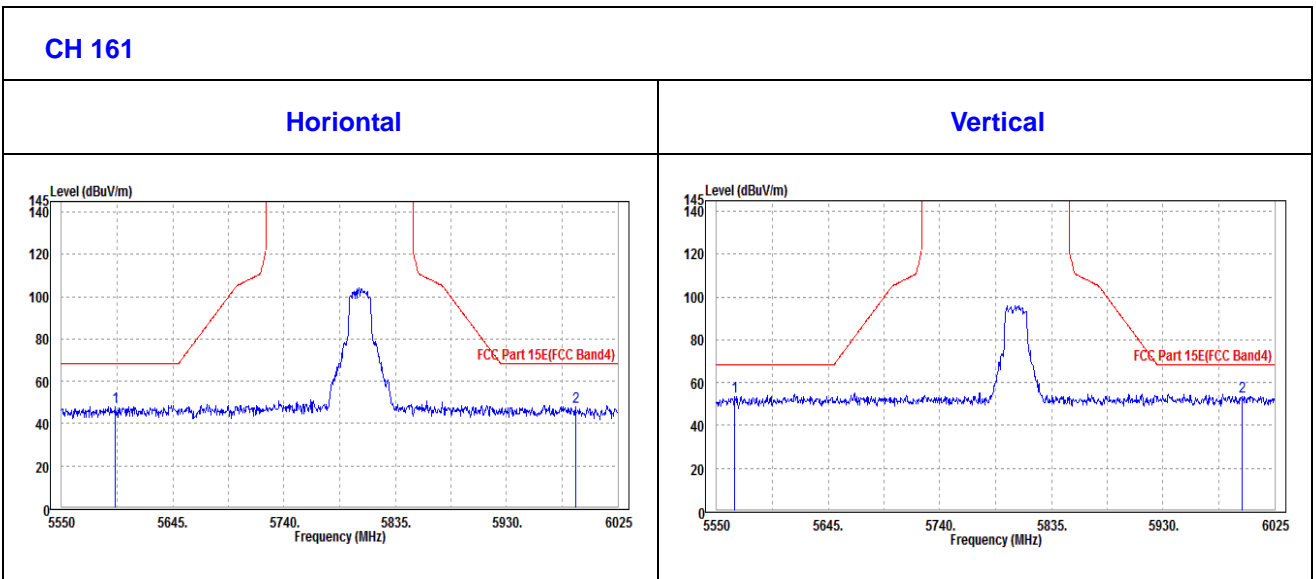



**802.11n (40MHz)**

<b>CHANNEL</b>	TX Channel 151	<b>DETECTOR FUNCTION</b>	Peak (PK)
<b>FREQUENCY RANGE</b>	1GHz ~ 40GHz		Average (AV)

**ANTENNA POLARITY & TEST DISTANCE: HORIZONTAL AT 3 M**

FREQ. (MHz)	EMISSION LEVEL (dBuV/m)	READ LEVEL (dBuV)	LIMIT (dBuV/m)	MARGIN (dB)	ANTENNA FACTOR (dB /m)	CABLE LOSS (dB)	PREAMP FACTOR (dB)	ANTENNA HEIGHT (cm)	TABLE ANGLE (Degree)	REMARK
5755	106.53	101.23			35.21	16.37	46.28	100	142	Peak
5755	97.86	92.56			35.21	16.37	46.28	100	142	Average

**ANTENNA POLARITY & TEST DISTANCE: VERTICAL AT 3 M**

FREQ. (MHz)	EMISSION LEVEL (dBuV/m)	READ LEVEL (dBuV)	LIMIT (dBuV/m)	MARGIN (dB)	ANTENNA FACTOR (dB /m)	CABLE LOSS (dB)	PREAMP FACTOR (dB)	ANTENNA HEIGHT (cm)	TABLE ANGLE (Degree)	REMARK
5755	110.16	104.86			35.21	16.37	46.28	100	81	Peak
5755	100.19	94.89			35.21	16.37	46.28	100	81	Average

**REMARKS:**

- Emission Level = Read Level+ Antenna Factor + Cable Loss- Preamp Factor  
Margin value = Emission level – Limit value.
- 5755MHz: Fundamental frequency.



**Oobe Data**

**802.11n (40MHz)**

ANTENNA POLARITY & TEST DISTANCE: HORIZONTAL AT 3 M										
FREQ. (MHz)	EMISSION LEVEL (dBuV/m)	READ LEVEL (dBuV)	LIMIT (dBuV/m)	MARGIN (dB)	ANTENNA FACTOR (dB /m)	CABLE LOSS (dB)	PREAMP FACTOR (dB)	ANTENNA HEIGHT (cm)	TABLE ANGLE (Degree)	REMARK
5564.725	54.48	50.65	68.3	-13.82	34.98	15.13	46.28	100	142	Peak
5983.2	58.02	50.96	68.3	-10.28	35.48	17.86	46.28	100	142	Peak
ANTENNA POLARITY & TEST DISTANCE: VERTICAL AT 3 M										
FREQ. (MHz)	EMISSION LEVEL (dBuV/m)	READ LEVEL (dBuV)	LIMIT (dBuV/m)	MARGIN (dB)	ANTENNA FACTOR (dB /m)	CABLE LOSS (dB)	PREAMP FACTOR (dB)	ANTENNA HEIGHT (cm)	TABLE ANGLE (Degree)	REMARK
5574.7	54.11	50.2	68.3	-14.19	34.99	15.2	46.28	103	81	Peak
5967.525	57.06	50.12	68.3	-11.24	35.46	17.76	46.28	103	81	Peak

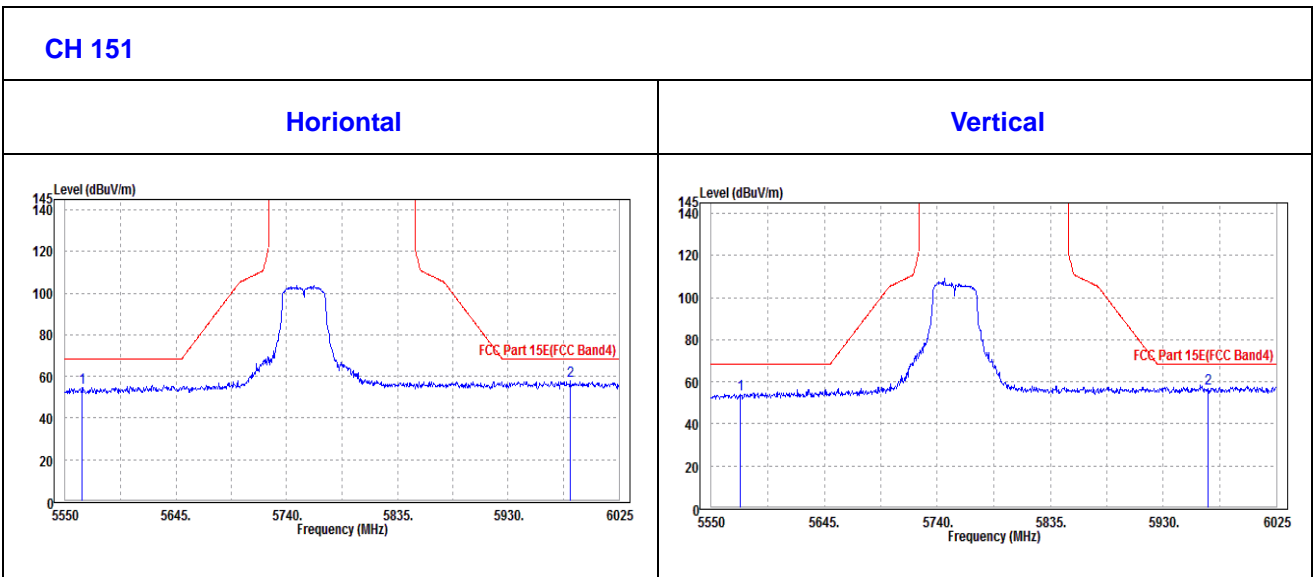



<b>CHANNEL</b>	TX Channel 159	<b>DETECTOR FUNCTION</b>	Peak (PK)
<b>FREQUENCY RANGE</b>	1GHz ~ 40GHz		Average (AV)

ANTENNA POLARITY & TEST DISTANCE: HORIZONTAL AT 3 M										
FREQ. (MHz)	EMISSION LEVEL (dBuV/m)	READ LEVEL (dBuV)	LIMIT (dBuV/m)	MARGIN (dB)	ANTENNA FACTOR (dB /m)	CABLE LOSS (dB)	PREAMP FACTOR (dB)	ANTENNA HEIGHT (cm)	TABLE ANGLE (Degree)	REMARK
5795	106.67	101.07			35.25	16.63	46.28	100	155	Peak
5795	96.85	91.25			35.25	16.63	46.28	100	155	Average
ANTENNA POLARITY & TEST DISTANCE: VERTICAL AT 3 M										
FREQ. (MHz)	EMISSION LEVEL (dBuV/m)	READ LEVEL (dBuV)	LIMIT (dBuV/m)	MARGIN (dB)	ANTENNA FACTOR (dB /m)	CABLE LOSS (dB)	PREAMP FACTOR (dB)	ANTENNA HEIGHT (cm)	TABLE ANGLE (Degree)	REMARK
5795	110.87	105.27			35.25	16.63	46.28	100	81	Peak
5795	101.29	95.69			35.25	16.63	46.28	100	81	Average

**REMARKS:**

1. Emission Level = Read Level+ Antenna Factor + Cable Loss- Preamp Factor  
Margin value = Emission level – Limit value.
2. 5795MHz: Fundamental frequency.



**OOBE DATA**

**802.11n (40MHZ)**

ANTENNA POLARITY & TEST DISTANCE: HORIZONTAL AT 3 M										
FREQ. (MHz)	EMISSION LEVEL (dBuV/m)	READ LEVEL (dBuV)	LIMIT (dBuV/m)	MARGIN (dB)	ANTENNA FACTOR (dB /m)	CABLE LOSS (dB)	PREAMP FACTOR (dB)	ANTENNA HEIGHT (cm)	TABLE ANGLE (Degree)	REMARK
5582.3	54.3	50.33	68.3	-14	35	15.25	46.28	112	155	Peak
5977.975	58.47	51.45	68.3	-9.83	35.47	17.83	46.28	112	155	Peak
ANTENNA POLARITY & TEST DISTANCE: VERTICAL AT 3 M										
FREQ. (MHz)	EMISSION LEVEL (dBuV/m)	READ LEVEL (dBuV)	LIMIT (dBuV/m)	MARGIN (dB)	ANTENNA FACTOR (dB /m)	CABLE LOSS (dB)	PREAMP FACTOR (dB)	ANTENNA HEIGHT (cm)	TABLE ANGLE (Degree)	REMARK
5574.225	54.19	50.29	68.3	-14.11	34.99	15.19	46.28	102	81	Peak
5982.25	57.19	50.14	68.3	-11.11	35.48	17.85	46.28	102	81	Peak

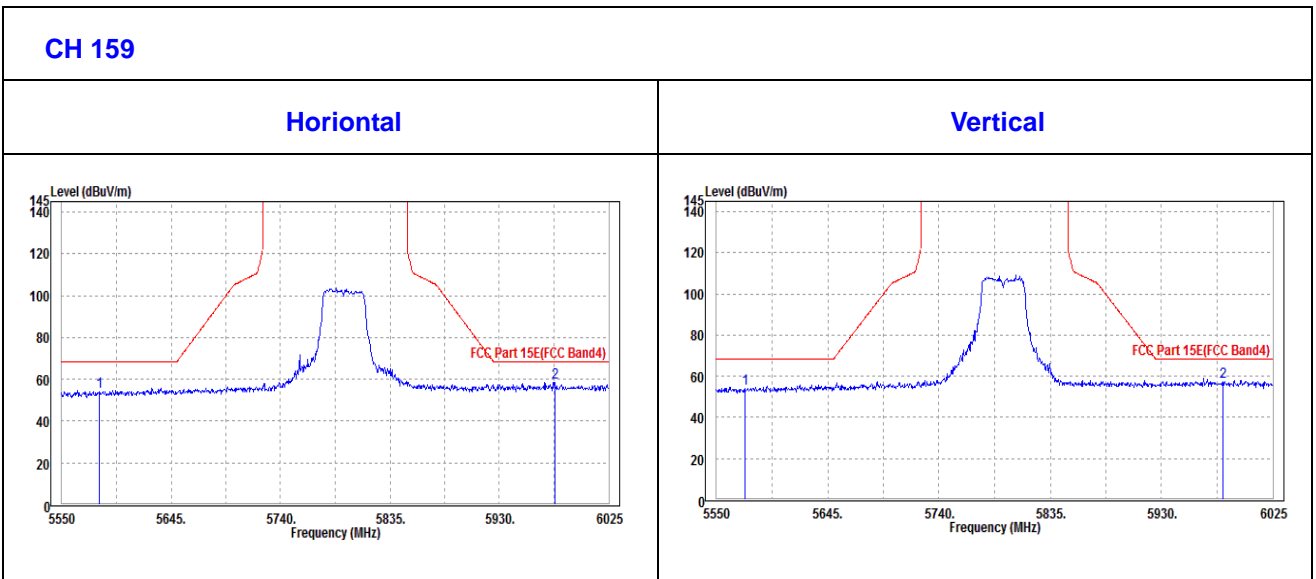





**802.11ac (80MHz)**

<b>CHANNEL</b>	TX Channel 155	<b>DETECTOR FUNCTION</b>	Peak (PK)
<b>FREQUENCY RANGE</b>	1GHz ~ 40GHz		Average (AV)

**ANTENNA POLARITY & TEST DISTANCE: HORIZONTAL AT 3 M**

FREQ. (MHz)	EMISSION LEVEL (dBuV/m)	READ LEVEL (dBuV)	LIMIT (dBuV/m)	MARGIN (dB)	ANTENNA FACTOR (dB /m)	CABLE LOSS (dB)	PREAMP FACTOR (dB)	ANTENNA HEIGHT (cm)	TABLE ANGLE (Degree)	REMARK
5775	100.22	101.04			37.57	7.78	46.17	100	152	Peak
5775	91.33	92.15			37.57	7.78	46.17	100	152	Average

**ANTENNA POLARITY & TEST DISTANCE: VERTICAL AT 3 M**

FREQ. (MHz)	EMISSION LEVEL (dBuV/m)	READ LEVEL (dBuV)	LIMIT (dBuV/m)	MARGIN (dB)	ANTENNA FACTOR (dB /m)	CABLE LOSS (dB)	PREAMP FACTOR (dB)	ANTENNA HEIGHT (cm)	TABLE ANGLE (Degree)	REMARK
5775	98.59	100.31			36.67	7.78	46.17	100	231	Peak
5775	88.39	90.11			36.67	7.78	46.17	100	231	Average

**REMARKS:**

- Emission Level = Read Level+ Antenna Factor + Cable Loss- Preamp Factor  
Margin value = Emission level – Limit value.
- 5775MHz: Fundamental frequency.



**Oobe Data**

**802.11ac (80MHz)**

ANTENNA POLARITY & TEST DISTANCE: HORIZONTAL AT 3 M										
FREQ. (MHz)	EMISSION LEVEL (dBuV/m)	READ LEVEL (dBuV)	LIMIT (dBuV/m)	MARGIN (dB)	ANTENNA FACTOR (dB /m)	CABLE LOSS (dB)	PREAMP FACTOR (dB)	ANTENNA HEIGHT (cm)	TABLE ANGLE (Degree)	REMARK
5561.875	48.83	46.87	68.3	-19.47	36.32	7.56	41.92	100	130	Peak
5985.1	49.25	46.96	68.3	-19.05	36.49	7.99	42.19	100	130	Peak
ANTENNA POLARITY & TEST DISTANCE: VERTICAL AT 3 M										
FREQ. (MHz)	EMISSION LEVEL (dBuV/m)	READ LEVEL (dBuV)	LIMIT (dBuV/m)	MARGIN (dB)	ANTENNA FACTOR (dB /m)	CABLE LOSS (dB)	PREAMP FACTOR (dB)	ANTENNA HEIGHT (cm)	TABLE ANGLE (Degree)	REMARK
5583.725	53.17	50.96	68.3	-15.13	36.55	7.59	41.93	100	130	Peak
5980.825	53.4	50.81	68.3	-14.9	36.79	7.99	42.19	100	130	Peak

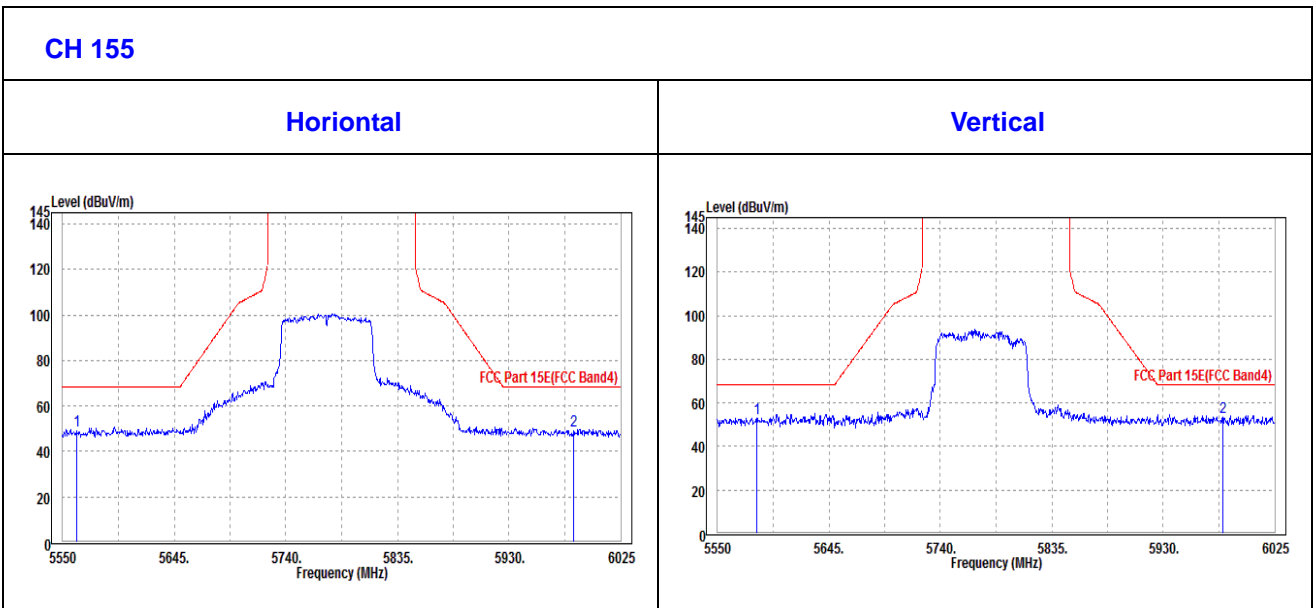



### 3.2 CONDUCTED EMISSION MEASUREMENT

#### 3.2.1 LIMITS OF CONDUCTED EMISSION MEASUREMENT

FREQUENCY OF EMISSION (MHz)	CONDUCTED LIMIT (dBµV)	
	Quasi-peak	Average
0.15 ~ 0.5	66 to 56	56 to 46
0.5 ~ 5	56	46
5 ~ 30	60	50

- NOTE:**
1. The lower limit shall apply at the transition frequencies.
  2. The limit decreases in line with the logarithm of the frequency in the range of 0.15 to 0.50MHz.
  3. All emanations from a class A/B digital device or system, including any network of conductors and apparatus connected thereto, shall not exceed the level of field strengths specified above.

#### 3.2.2 TEST INSTRUMENTS

Equipment	Manufacturer	Model No.	Serial No.	Last Cal.	Next Cal.
EMI Test Receiver	Rohde&Schwarz	ESR3	101900	Feb. 26,19	Feb. 25,20
EMC32 test software	Rohde&Schwarz	EMC32	NA	NA	NA
LISN network	Rohde&Schwarz	ENV216	101922	Feb. 26,19	Feb. 25,20

**NOTE:**

1. The test was performed in CE shielded room.
2. The calibration interval of the above test instruments is 12 months. And the calibrations are traceable to CEPREI/CHINA, GRGT/CHINA and NIM/CHINA.

#### 3.2.3 TEST PROCEDURES

- a. The EUT was placed 0.4 meters from the conducting wall of the shielded room with EUT being connected to the power mains through a line impedance stabilization network (LISN). Other support units were connected to the power mains through another LISN. The two LISNs provide 50 ohm/ 50uH of coupling impedance for the measuring instrument.
- b. Both lines of the power mains connected to the EUT were checked for maximum conducted interference.
- c. The frequency range from 150kHz to 30MHz was searched. Emission levels under (Limit - 20dB) was not recorded.

**NOTE:** All modes of operation were investigated and the worst-case emissions are reported.



### 3.2.4 DEVIATION FROM TEST STANDARD

No deviation.

### 3.2.5 TEST SETUP

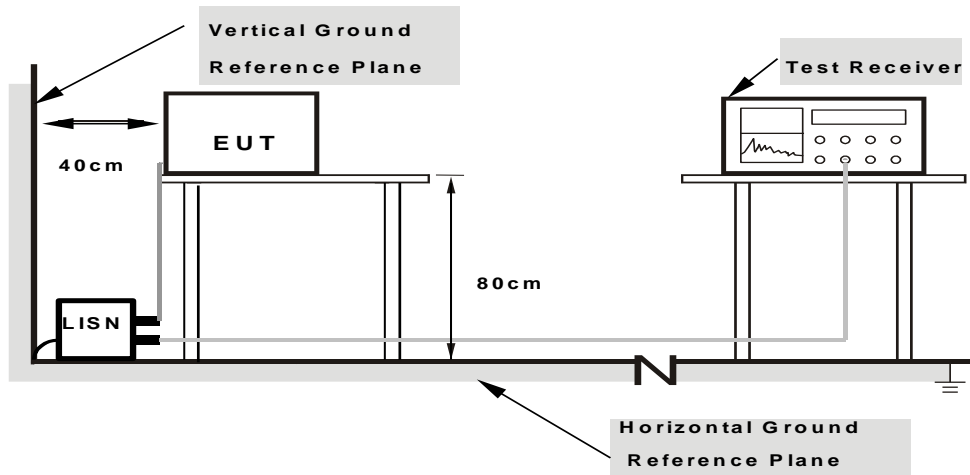

**Note: 1.Support units were connected to second LISN.**

**2.Both of LISNs (AMN) are 80 cm from EUT and at least 80  
from other units and other metal planes**

For the actual test configuration, please refer to the attached file (Test Setup Photo).

### 3.2.6 EUT OPERATING CONDITIONS

Same as 3.1.6.



### 3.2.7 TEST RESULTS

#### CONDUCTED WORST-CASE DATA :

<b>Frequency Range</b>	150KHz ~ 30MHz	<b>Detector Function &amp; Resolution Bandwidth</b>	Quasi-Peak (QP) / Average (AV), 9 kHz
<b>Input Power</b>	120Vac, 60Hz	<b>Environmental Conditions</b>	25deg. C, 52RH
<b>Tested By</b>	Jimmy Liu		

Frequency (MHz)	QuasiPeak (dBuV)	CAverage (dBuV)	Limit (dBuV)	Margin (dB)	Line	Filter	Corr. (dB)
0.512000	---	16.87	46.00	-29.13	L1	ON	10.0
0.512000	25.56	---	56.00	-30.44	L1	ON	10.0
0.528000	---	20.20	46.00	-25.80	L1	ON	10.0
0.528000	28.11	---	56.00	-27.89	L1	ON	10.0
0.984000	---	12.98	46.00	-33.02	L1	ON	10.1
0.984000	19.22	---	56.00	-36.78	L1	ON	10.1
1.668000	---	9.87	46.00	-36.13	L1	ON	10.1
1.668000	17.98	---	56.00	-38.02	L1	ON	10.1
2.300000	---	11.10	46.00	-34.90	L1	ON	10.1
2.300000	18.93	---	56.00	-37.07	L1	ON	10.1
4.176000	---	9.95	46.00	-36.05	L1	ON	10.2
4.176000	16.47	---	56.00	-39.53	L1	ON	10.2

- REMARKS:**
1. Q.P. and AV. are abbreviations of quasi-peak and average individually.
  2. "-": The Quasi-peak reading value also meets average limit and measurement with the average detector is unnecessary.
  3. The emission levels of other frequencies were very low against the limit.
  4. Margin value = Emission level - Limit value
  5. Correction factor = Insertion loss + Cable loss
  6. Emission Level = Correction Factor + Reading Value.

Full Spectrum

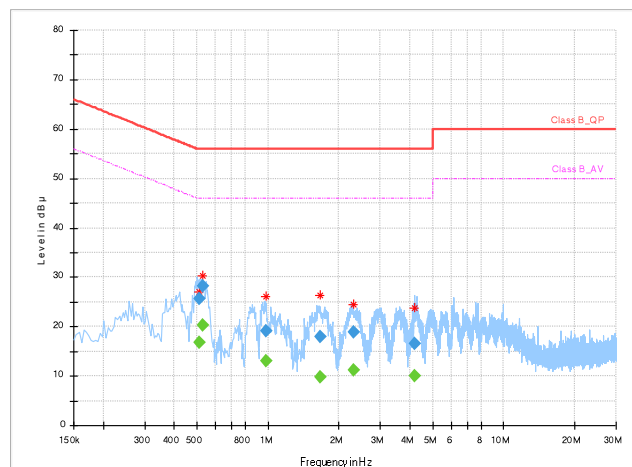



<b>Frequency Range</b>	150KHz ~ 30MHz	<b>Detector Function &amp; Resolution Bandwidth</b>	Quasi-Peak (QP) / Average (AV), 9 kHz
<b>Input Power</b>	120Vac, 60Hz	<b>Environmental Conditions</b>	25deg. C, 52RH
<b>Tested By</b>	Jimmy Liu		

Frequency (MHz)	QuasiPeak (dBUV)	CAverage (dBUV)	Limit (dBUV)	Margin (dB)	Line	Filter	Corr. (dB)
0.424000	---	16.72	47.37	-30.65	N	ON	9.9
0.424000	26.11	---	57.37	-31.26	N	ON	9.9
0.536000	---	19.08	46.00	-26.92	N	ON	9.9
0.536000	29.55	---	56.00	-26.45	N	ON	9.9
0.988000	---	18.45	46.00	-27.55	N	ON	10.0
0.988000	26.10	---	56.00	-29.90	N	ON	10.0
1.360000	---	10.25	46.00	-35.75	N	ON	10.0
1.360000	20.25	---	56.00	-35.75	N	ON	10.0
3.372000	---	8.14	46.00	-37.86	N	ON	10.1
3.372000	16.69	---	56.00	-39.31	N	ON	10.1
4.876000	---	11.74	46.00	-34.26	N	ON	10.1
4.876000	19.38	---	56.00	-36.62	N	ON	10.1

- REMARKS:**
1. Q.P. and AV. are abbreviations of quasi-peak and average individually.
  2. "-": The Quasi-peak reading value also meets average limit and measurement with the average detector is unnecessary.
  3. The emission levels of other frequencies were very low against the limit.
  4. Margin value = Emission level - Limit value
  5. Correction factor = Insertion loss + Cable loss
  6. Emission Level = Correction Factor + Reading Value.

Full Spectrum

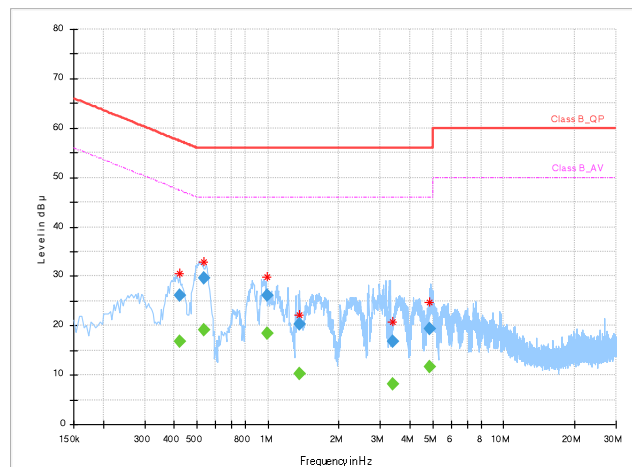



### 3.3 MAXIMUM CONDUCTED OUTPUT POWER MEASUREMENT

#### 3.3.1 LIMITS OF MAXIMUM CONDUCTED OUTPUT POWER MEASUREMENT

Operation Band	EUT Category		LIMIT
U-NII-1		Outdoor Access Point	1 Watt (30 dBm) (Max. e.i.r.p ≤ 125mW(21 dBm) at any elevation angle above 30 degrees as measured from the horizon)
		Fixed point-to-point Access Point	1 Watt (30 dBm)
		Indoor Access Point	1 Watt (30 dBm)
	√	Client devices	250mW (24 dBm)
U-NII-2A	√		250mW (24 dBm) or 11 dBm+10 log B*
U-NII-2C	√		250mW (24 dBm) or 11 dBm+10 log B*
U-NII-3	√		1 Watt (30 dBm)

**NOTE:** Where B is the 26dB emission bandwidth in MHz.



### 3.3.2 TEST SETUP

#### FOR POWER OUTPUT MEASUREMENT

#### 802.11a, 802.11n (20MHz), 802.11n (40MHz) TEST CONFIGURATION

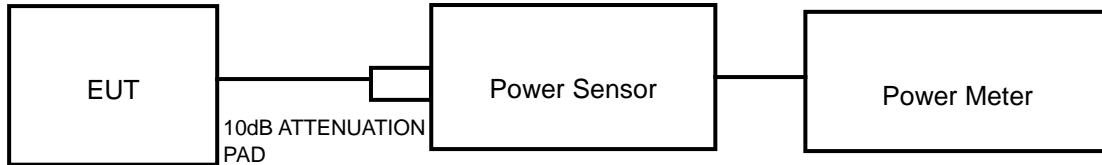

#### 11ac TEST CONFIGURATION

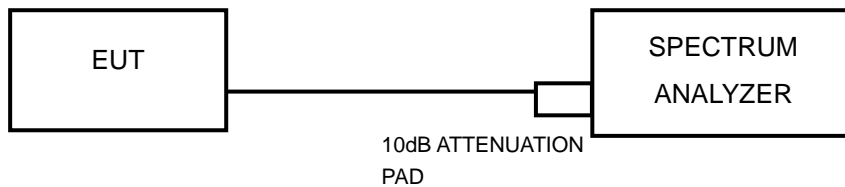

#### FOR 26dB BANDWIDTH

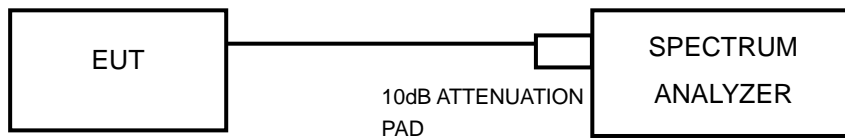

### 3.3.3 TEST INSTRUMENTS

Equipment	Manufacturer	Model No.	Serial No.	Last Cal.	Next Cal.
Power Meter	ANRITSU	ML2495A	1506002	Feb. 26,19	Feb. 25,20
EXA Signal Analyzer	KEYSIGHT	N9010A-526	MY54510322	Feb. 26,19	Feb. 25,20
EXA Signal Analyzer	KEYSIGHT	N9010A-544	MY54510355	Feb. 26,19	Feb. 25,20
Power Sensor	ANRITSU	MA2411B	1339352	Feb. 26,19	Feb. 25,20

**NOTE:**

1. The calibration interval of the above test instruments is 12 months and the calibrations are traceable to CEPREI/CHINA, GRGT/CHINA and NIM/CHINA.
2. The test was performed in RF Oven room.





### 3.3.4 TEST PROCEDURE

#### FOR POWER MEASUREMENT

##### For 802.11a, 802.11n (20MHz), 802.11n (40MHz)

Method PM is used to perform output power measurement, trigger and gating function of wide band power meter is enabled to measure max output power of TX on burst. Duty factor is not added to measured value.

##### For 802.11ac (80MHz)

1. Measure the duty cycle,  $x$ , of the transmitter output signal as described in II.B.
2. Set span to encompass the EBW (or, alternatively, the entire 99% occupied bandwidth) of the signal.
3. Set RBW = 1 MHz.
4. Set VBW  $\geq$  3 MHz.
5. Number of points in sweep  $\geq 2 \times \text{span} / \text{RBW}$ . (This ensures that bin-to-bin spacing is  $\leq \text{RBW}/2$ , so that narrowband signals are not lost between frequency bins.)
6. Sweep time = auto.
7. Detector = power averaging (rms), if available. Otherwise, use sample detector mode.
8. Do not use sweep triggering. Allow the sweep to “free run.”
9. Trace average at least 100 traces in power averaging (rms) mode; however, the number of traces to be averaged shall be increased above 100 as needed to ensure that the average accurately represents the true average over the on and off periods of the transmitter.
10. Add  $10 \log (1/x)$ , where  $x$  is the duty cycle, to the measured power to compute the average power during the actual transmission times (because the measurement represents an average over both the on and off times of the transmission). For example, add  $10 \log (1/0.25) = 6 \text{ dB}$  if the duty cycle is 25%.



#### **FOR 99 PERCENT OCCUPIED BANDWIDTH**

The following procedure shall be used for measuring (99 %) power bandwidth:

1. Set center frequency to the nominal EUT channel center frequency.
2. Set span = 1.5 times to 5.0 times the OBW.
3. Set RBW = 1 % to 5 % of the OBW
4. Set VBW  $\geq 3 \cdot$  RBW
5. Video averaging is not permitted. Where practical, a sample detection and single sweep mode shall be used. Otherwise, peak detection and max hold mode (until the trace stabilizes) shall be used.
6. Use the 99 % power bandwidth function of the instrument (if available).
7. If the instrument does not have a 99 % power bandwidth function, the trace data points are recovered and directly summed in power units. The recovered amplitude data points, beginning at the lowest frequency, are placed in a running sum until 0.5 % of the total is reached; that frequency is recorded as the lower frequency. The process is repeated until 99.5 % of the total is reached; that frequency is recorded as the upper frequency. The 99% occupied bandwidth is the difference between these two frequencies.

#### **FOR 26dB BANDWIDTH**

- 1) Set RBW = approximately 1% of the emission bandwidth.
- 2) Set the VBW > RBW.
- 3) Detector = Peak.
- 4) Trace mode = max hold.
- 5) Measure the maximum width of the emission that is 26 dB down from the peak of the emission. Compare this with the RBW setting of the analyzer. Readjust RBW and repeat measurement as needed until the RBW/EBW ratio is approximately 1%.

#### **FOR 6dB BANDWIDTH**

1. Set RBW = 100 kHz.
2. Set the video bandwidth (VBW)  $\geq 3$  RBW.
3. Detector = Peak.
4. Trace mode = max hold.
5. Sweep = auto couple.
6. Allow the trace to stabilize.
7. Measure the maximum width of the emission that is constrained by the frequencies associated with the two outermost amplitude points (upper and lower frequencies) that are attenuated by 6 dB relative to the maximum level measured in the fundamental emission.



### 3.3.5 DEVIATION FROM TEST STANDARD

No deviation.

### 3.3.6 EUT OPERATING CONDITIONS

The software provided by client to enable the EUT under transmission condition continuously at specific channel frequencies individually.



### 3.3.7 TEST RESULTS

#### OUTPUT POWER:

##### 802.11a

CHANNEL	CHANNEL FREQUENCY (MHz)	AVERAGE POWER (dBm)	Duty Factor	FINAL AVERAGE POWER (dBm)	FINAL AVERAGE POWER (mW)	POWER LIMIT (dBm)	PASS/FAIL
36	5180	15.48	/	15.48	35.32	24	PASS
40	5200	15.42	/	15.42	34.83	24	PASS
48	5240	15.35	/	15.35	34.28	24	PASS
52	5260	15.36	/	15.36	34.36	24	PASS
60	5300	15.45	/	15.45	35.08	24	PASS
64	5320	15.26	/	15.26	33.57	24	PASS
100	5500	14.67	/	14.67	29.31	24	PASS
116	5580	14.89	/	14.89	30.83	24	PASS
140	5700	14.62	/	14.62	28.97	24	PASS
144	5720	14.27	/	14.27	26.73	24	PASS
144	5720	14.27	/	14.27	26.73	30	PASS
149	5745	14.32	/	14.32	27.04	30	PASS
157	5785	14.35	/	14.35	27.23	30	PASS
161	5805	14.13	/	14.13	25.88	30	PASS



802.11n (20MHz)

CHANNEL	CHANNEL FREQUENCY (MHz)	AVERAGE POWER (dBm)	Duty Factor	FINAL AVERAGE POWER (dBm)	FINAL AVERAGE POWER (mW)	POWER LIMIT (dBm)	PASS/FAIL
36	5180	13.28	/	13.28	21.28	24	PASS
40	5200	13.32	/	13.32	21.48	24	PASS
48	5240	13.12	/	13.12	20.51	24	PASS
52	5260	13.22	/	13.22	20.99	24	PASS
60	5300	13.35	/	13.35	21.63	24	PASS
64	5320	13.65	/	13.65	23.17	24	PASS
100	5500	13.17	/	13.17	20.75	24	PASS
116	5580	13.39	/	13.39	21.83	24	PASS
140	5700	13.04	/	13.04	20.14	24	PASS
144	5720	12.63	/	12.63	18.32	24	PASS
144	5720	12.63	/	12.63	18.32	30	PASS
149	5745	12.39	/	12.39	17.34	30	PASS
157	5785	12.53	/	12.53	17.91	30	PASS
161	5805	12.42	/	12.42	17.46	30	PASS



802.11n (40MHz)

CHANNEL	CHANNEL FREQUENCY (MHz)	AVERAGE POWER (dBm)	Duty Factor	FINAL AVERAGE POWER (dBm)	FINAL AVERAGE POWER (mW)	POWER LIMIT (dBm)	PASS/FAIL
38	5190	14.51	0.22	14.73	29.72	24	PASS
46	5230	14.47	0.22	14.69	29.44	24	PASS
54	5270	14.54	0.22	14.76	29.92	24	PASS
62	5310	14.57	0.22	14.79	30.13	24	PASS
102	5510	14.32	0.22	14.54	28.44	24	PASS
110	5550	14.38	0.22	14.60	28.84	24	PASS
134	5670	14.41	0.22	14.63	29.04	24	PASS
142	5710	14.01	0.22	14.19	26.24	24	PASS
142	5710	14.01	0.22	14.19	26.24	30	PASS
151	5755	13.46	0.22	13.68	23.33	30	PASS
159	5798	13.54	0.22	13.76	23.77	30	PASS

802.11ac (80MHz)

CHANNEL	CHANNEL FREQUENCY (MHz)	AVERAGE POWER (dBm)	Duty Factor	FINAL AVERAGE POWER (dBm)	FINAL AVERAGE POWER (mW)	POWER LIMIT (dBm)	PASS/FAIL
42	5210	12.49	0.51	13.00	19.95	24	PASS
58	5290	12.66	0.51	13.17	20.75	24	PASS
106	5530	12.35	0.51	12.86	19.32	24	PASS
138	5690	11.75	0.51	12.26	16.83	24	PASS
138	5690	11.75	0.51	12.26	16.83	30	PASS
155	5775	11.49	0.51	12.00	15.85	30	PASS



**99% OCCUPIED BANDWIDTH & 26dB BANDWIDTH/6dB BANDWIDTH DATA FROM:**

**802.11a**

CHANNEL	CHANNEL FREQUENCY (MHz)	99% OCCUPIED BANDWIDTH	26dB BANDWIDTH (MHz)	PASS/FAIL
36	5180	16.74	23.36	PASS
40	5200	16.68	23.27	PASS
48	5240	16.68	23.02	PASS
52	5260	16.68	22.90	PASS
60	5300	16.74	22.53	PASS
64	5320	16.68	23.38	PASS
100	5500	16.62	23.10	PASS
116	5580	16.74	22.04	PASS
140	5700	16.68	22.95	PASS
144	5720	16.68	24.05	PASS
CHANNEL	CHANNEL FREQUENCY	99% OCCUPIED BANDWIDTH	6dB BANDWIDTH	PASS/FAIL
144	5720	16.68	15.91	PASS
149	5745	16.68	15.67	PASS
157	5785	16.68	15.41	PASS
161	5805	16.62	15.48	PASS



802.11n (20MHz)

CHANNEL	CHANNEL FREQUENCY (MHz)	99% OCCUPIED BANDWIDTH	26dB BANDWIDTH (MHz)	PASS/FAIL
36	5180	17.82	24.24	PASS
40	5200	17.76	24.25	PASS
48	5240	17.82	24.91	PASS
52	5260	17.82	23.92	PASS
60	5300	17.82	24.33	PASS
64	5320	17.76	23.73	PASS
100	5500	17.82	23.89	PASS
116	5580	17.82	23.75	PASS
140	5700	17.82	23.90	PASS
144	5720	17.76	25.70	PASS
CHANNEL	CHANNEL FREQUENCY	99% OCCUPIED BANDWIDTH	6dB BANDWIDTH	PASS/FAIL
144	5720	17.76	16.18	PASS
149	5745	17.88	15.88	PASS
157	5785	17.82	15.73	PASS
161	5805	17.82	15.29	PASS





802.11n (40MHz)

CHANNEL	CHANNEL FREQUENCY (MHz)	99% OCCUPIED BANDWIDTH	26dB BANDWIDTH (MHz)	PASS/FAIL
38	5190	36.42	42.12	PASS
46	5230	36.36	42.02	PASS
54	5270	36.36	42.33	PASS
62	5310	36.36	42.17	PASS
102	5510	36.42	42.18	PASS
110	5550	36.60	41.96	PASS
134	5670	36.48	42.38	PASS
142	5710	36.48	41.56	PASS
CHANNEL	CHANNEL FREQUENCY	99% OCCUPIED BANDWIDTH	6dB BANDWIDTH	PASS/FAIL
142	5710	36.48	35.13	PASS
151	5755	36.42	35.70	PASS
159	5795	36.54	35.69	PASS

802.11ac (80MHz)

CHANNEL	CHANNEL FREQUENCY (MHz)	99% OCCUPIED BANDWIDTH	26dB BANDWIDTH (MHz)	PASS/FAIL
42	5210	75.72	92.74	PASS
58	5290	75.60	97.48	PASS
106	5530	75.72	93.54	PASS
138	5690	75.48	97.62	PASS
CHANNEL	CHANNEL FREQUENCY	99% OCCUPIED BANDWIDTH	6dB BANDWIDTH	PASS/FAIL
138	5690	75.48	75.37	PASS
155	5775	75.60	75.64	PASS



For U-NII-1:

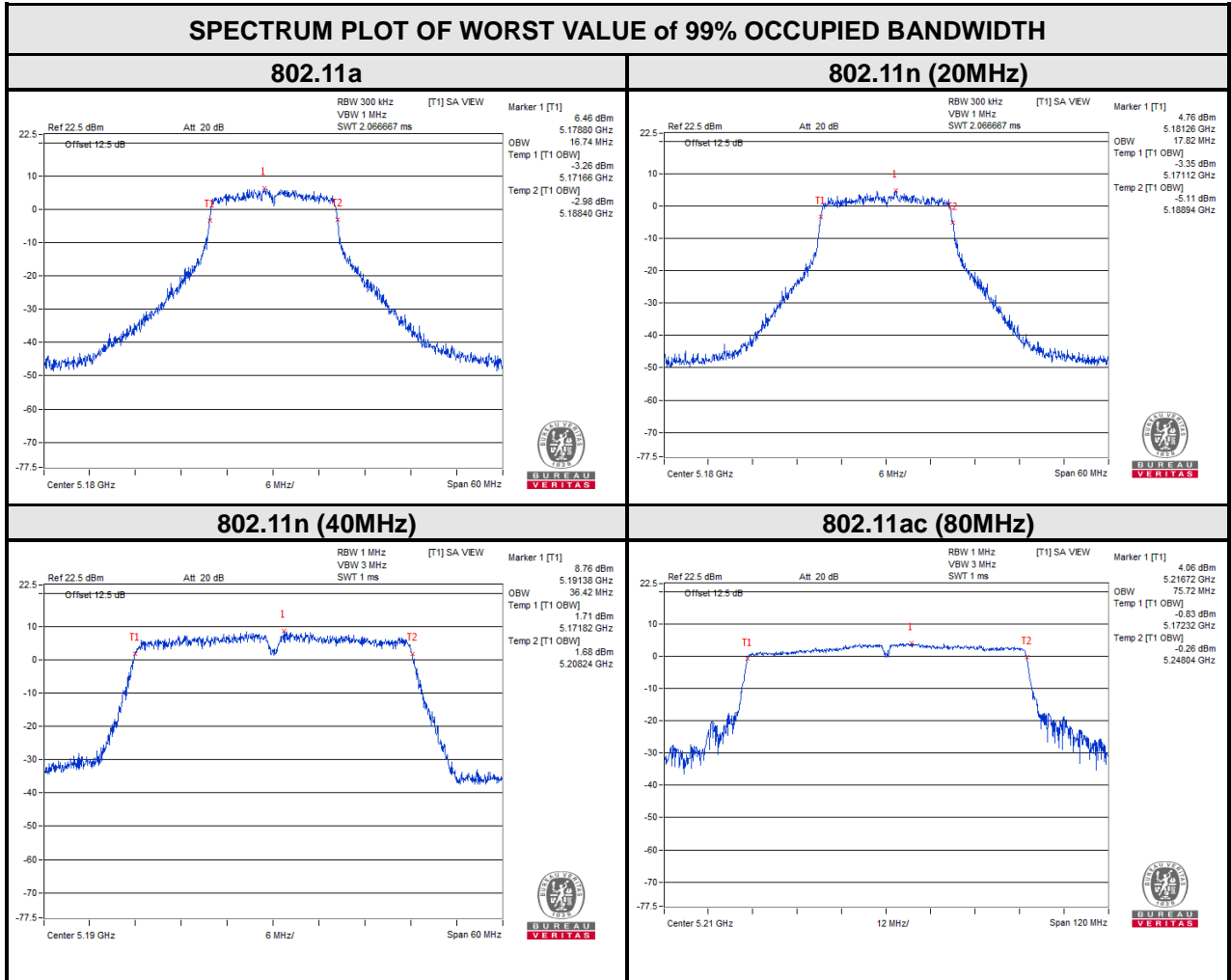



BUREAU VERITAS

Test Report No.: RF190823W003-3

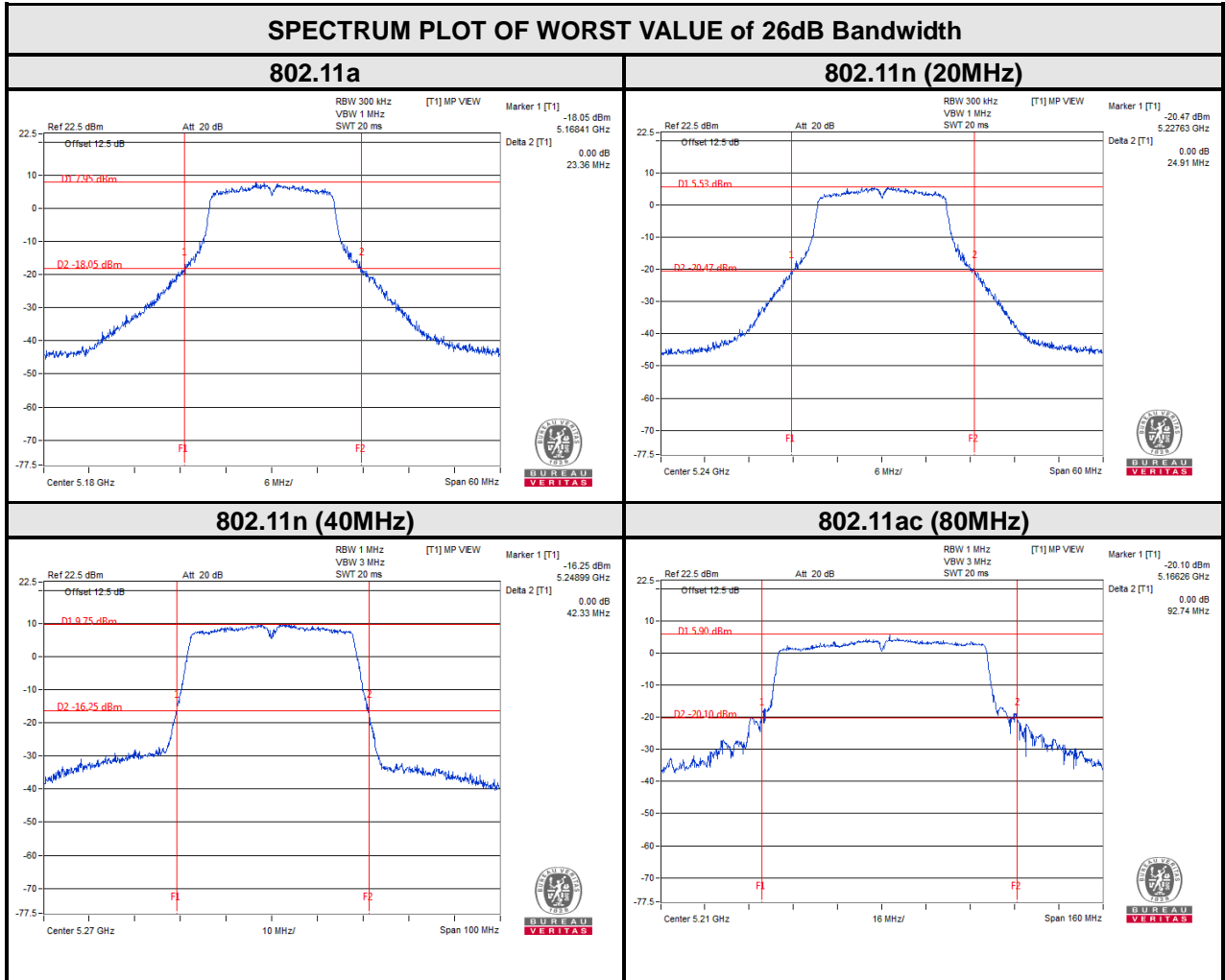



For U-NII-2A:

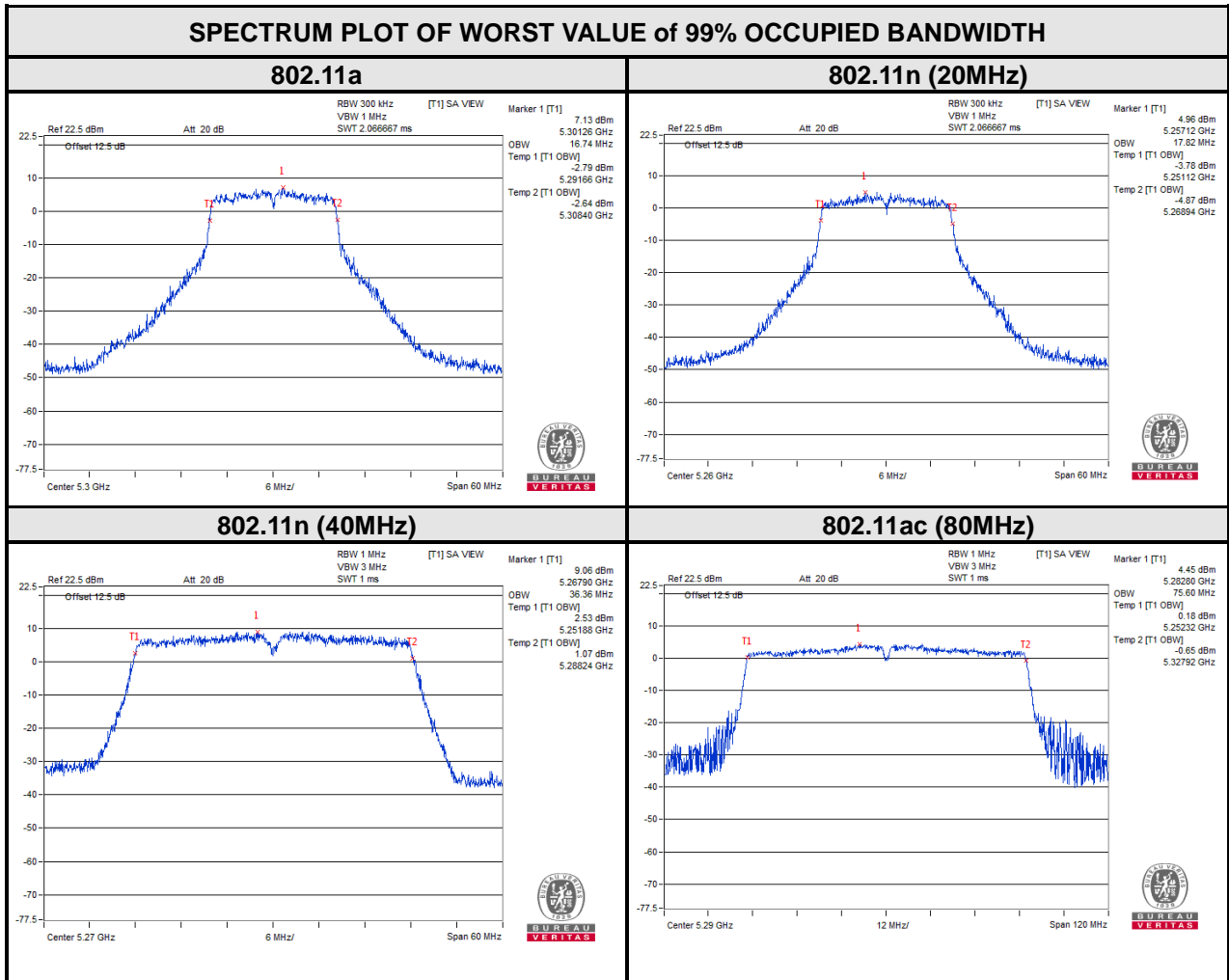

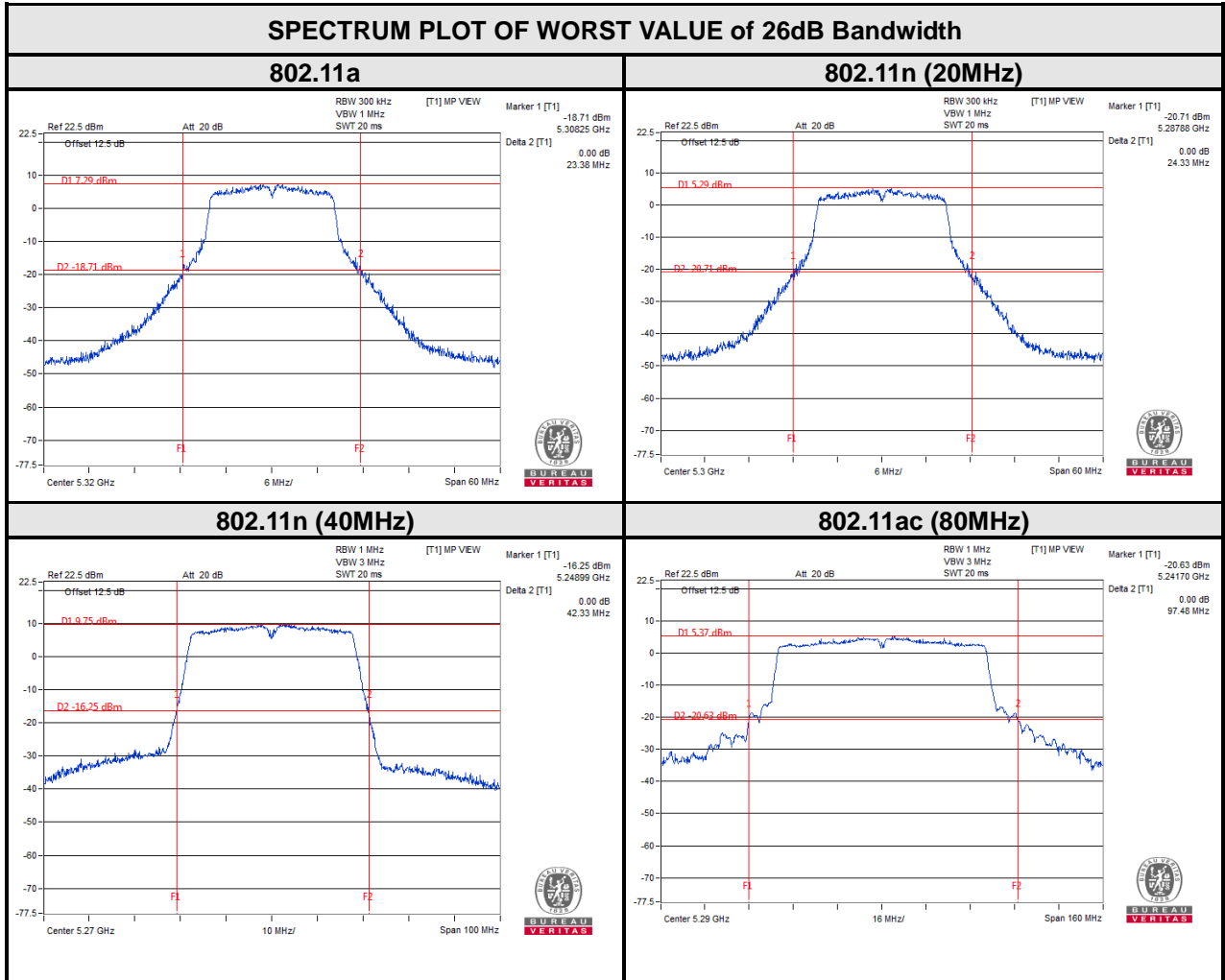



BUREAU VERITAS

Test Report No.: RF190823W003-3

For U-NII-2C:

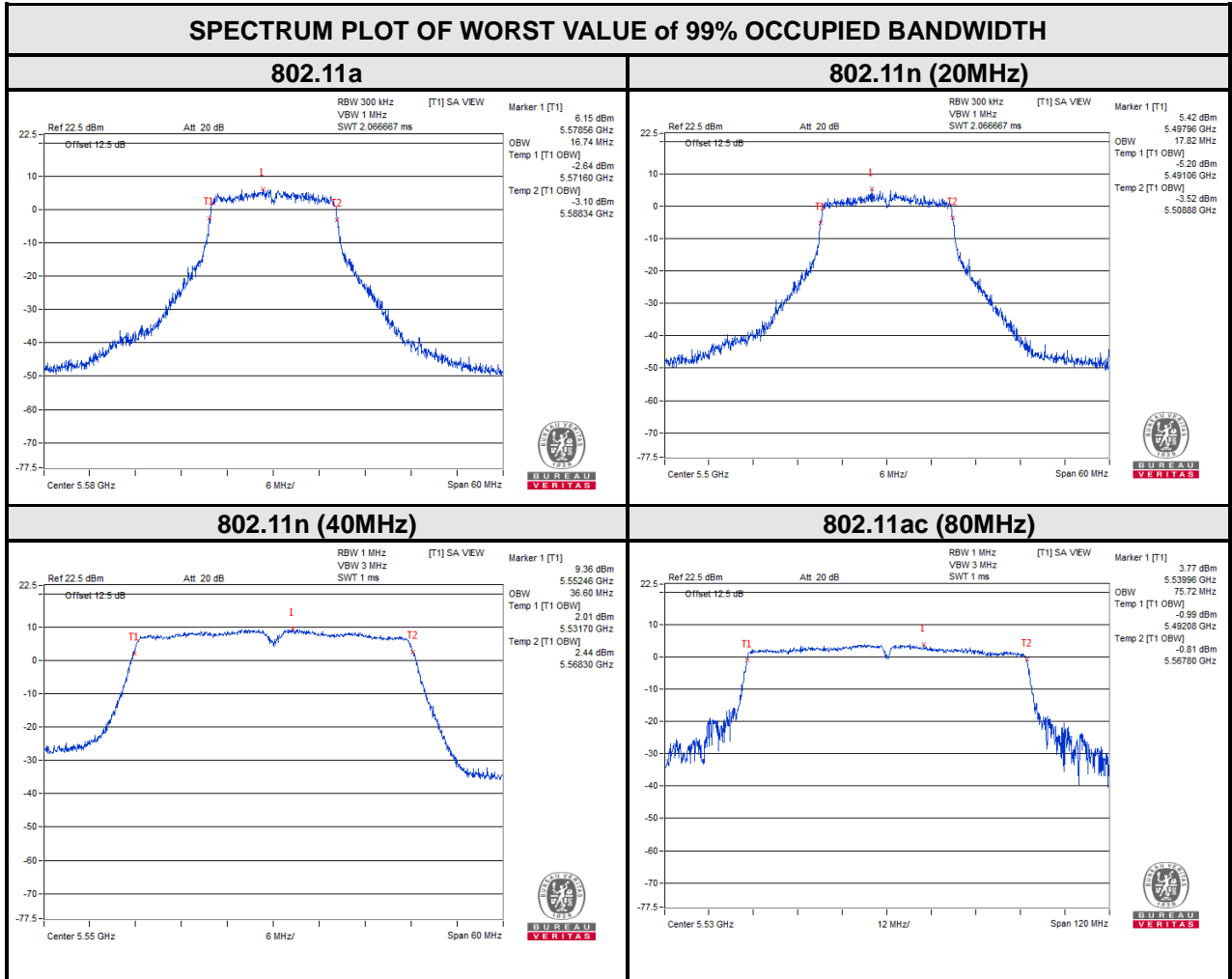

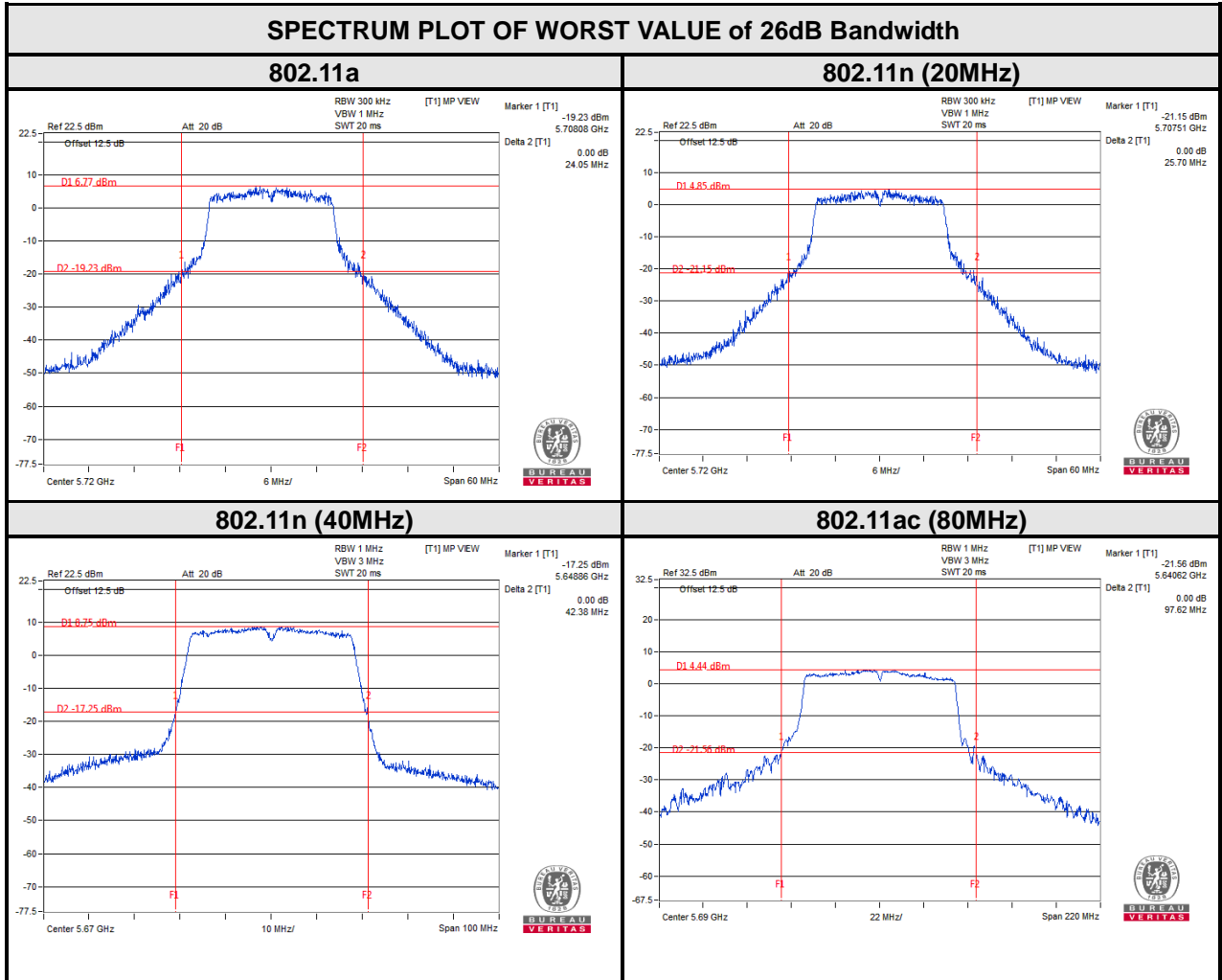



**BUREAU  
VERITAS**

Test Report No.: RF190823W003-3

For U-NII-3:

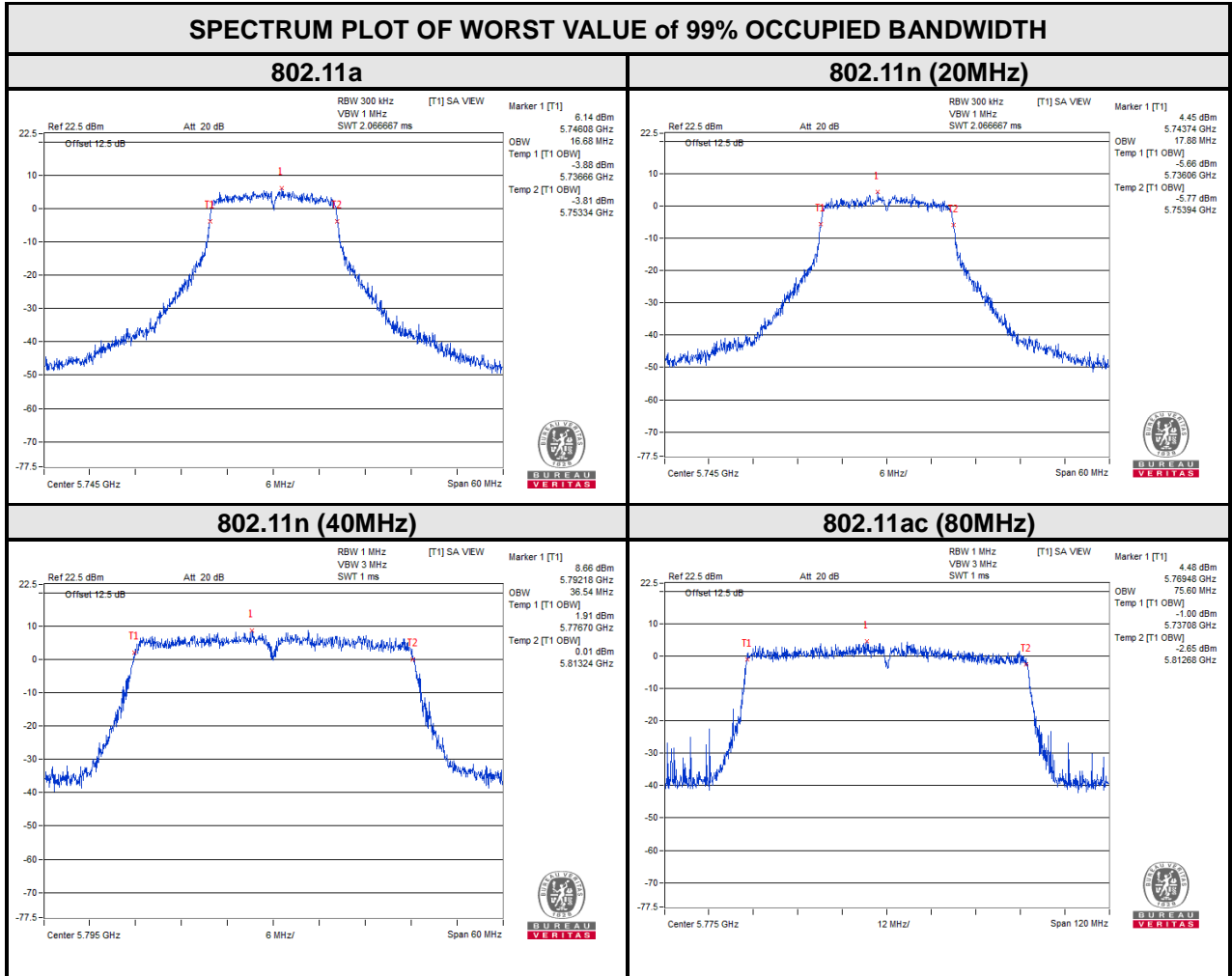





BUREAU VERITAS

Test Report No.: RF190823W003-3

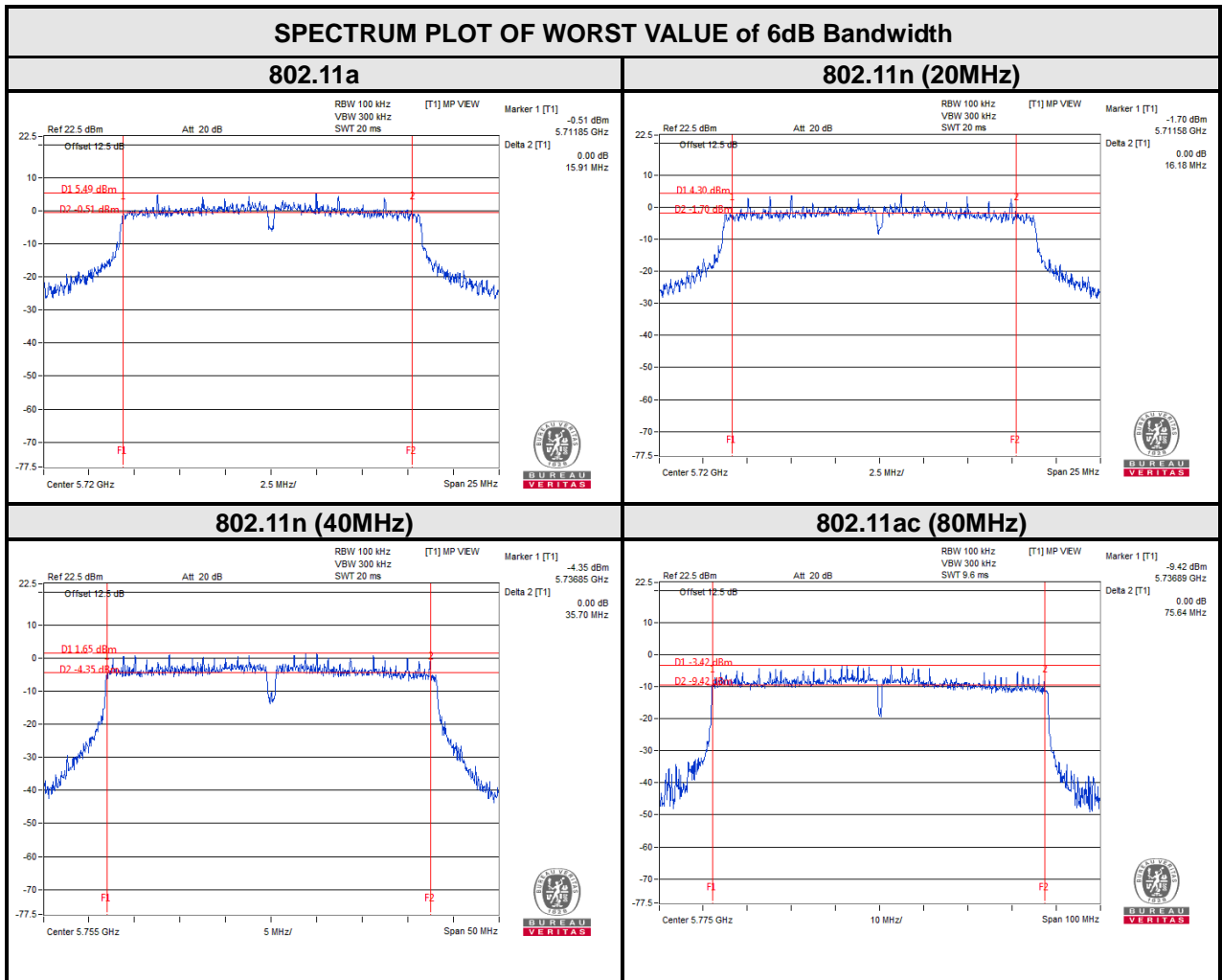



### 3.4 MAXIMUM POWER SPECTRAL DENSITY MEASUREMENT

#### 3.4.1 LIMITS OF MAXIMUM POWER SPECTRAL DENSITY MEASUREMENT

Operation Band	EUT Category		LIMIT
U-NII-1		Outdoor Access Point	17dBm/ MHz
		Fixed point-to-point Access Point	
		Indoor Access Point	
	√	Client devices	11dBm/ MHz
U-NII-2A		√	11dBm/ MHz
U-NII-2C		√	11dBm/ MHz
U-NII-3		√	30dBm/ 500kHz

#### 3.4.2 TEST SETUP

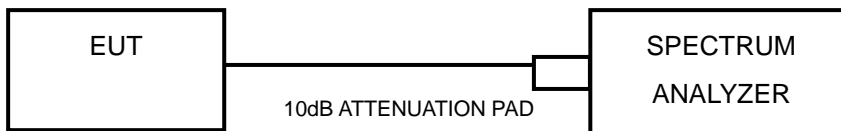

#### 3.4.3 TEST INSTRUMENTS

Refer to section 3.3.3 to get information of above instrument.



#### 3.4.4 TEST PROCEDURES

Using method SA-2

- 1) Set span to encompass the entire emission bandwidth (EBW) of the signal.
- 2) Set RBW = 1 MHz, Set VBW  $\geq$  3 MHz, Detector = RMS
- 3) Set Channel power measure = 1MHz
- 4) Sweep time = auto, trigger set to "free run".
- 5) Trace average at least 100 traces in power averaging mode.
- 6) Add  $10 \log(1/x)$ , where x is the duty cycle, to the measured power in order to compute the average power during the actual transmission times (because the measurement represents an average over both the on and off times of the transmission).
- 7) Record the max value

#### 3.4.5 DEVIATION FROM TEST STANDARD

No deviation.

#### 3.4.6 EUT OPERATING CONDITIONS

Same as 3.1.6.



### 3.4.7 TEST RESULTS

For U-NII-1 & U-NII-2A& U-NII-2C:

#### 802.11a

CHANNEL	FREQUENCY (MHz)	PSD w/o Duty Factor (dBm/MHz)	Duty Factor	PSD with Duty Factor (dBm/MHz)	MAXIMUM LIMIT (dBm/MHz)	PASS/FAIL
36	5180	9.81	/	9.81	11	PASS
40	5200	9.54	/	9.54	11	PASS
48	5240	10.12	/	10.12	11	PASS
52	5260	9.63	/	9.63	11	PASS
60	5300	9.88	/	9.88	11	PASS
64	5320	9.37	/	9.37	11	PASS
100	5500	9.95	/	9.95	11	PASS
116	5580	8.76	/	8.76	11	PASS
140	5700	8.85	/	8.85	11	PASS
144	5720	9.59	/	9.59	11	PASS

#### 802.11n (20MHz)

CHANNEL	FREQUENCY (MHz)	PSD w/o Duty Factor (dBm/MHz)	Duty Factor	PSD with Duty Factor (dBm/MHz)	MAXIMUM LIMIT (dBm/MHz)	PASS/FAIL
36	5180	7.23	/	7.23	11	PASS
40	5200	6.96	/	6.96	11	PASS
48	5240	7.04	/	7.04	11	PASS
52	5260	7.48	/	7.48	11	PASS
60	5300	7.24	/	7.24	11	PASS
64	5320	8.04	/	8.04	11	PASS
100	5500	6.92	/	6.92	11	PASS
116	5580	6.96	/	6.96	11	PASS
140	5700	7.02	/	7.02	11	PASS
144	5720	7.62	/	7.62	11	PASS



**802.11n (40MHz)**

CHANNEL	FREQUENCY (MHz)	PSD w/o Duty Factor (dBm/MHz)	Duty Factor	PSD with Duty Factor (dBm/MHz)	MAXIMUM LIMIT (dBm/MHz)	PASS/FAIL
38	5190	5.60	0.22	5.82	11	PASS
46	5230	6.27	0.22	6.49	11	PASS
54	5270	5.72	0.22	5.94	11	PASS
62	5310	5.79	0.22	6.01	11	PASS
102	5510	5.77	0.22	5.99	11	PASS
110	5550	6.09	0.22	6.31	11	PASS
134	5670	4.91	0.22	5.13	11	PASS
142	5710	6.65	0.22	6.87	11	PASS

**802.11ac (80MHz)**

CHANNEL	FREQUENCY (MHz)	PSD w/o Duty Factor (dBm/MHz)	Duty Factor	PSD with Duty Factor (dBm/MHz)	MAXIMUM LIMIT (dBm/MHz)	PASS/FAIL
42	5210	1.69	0.51	2.20	11	PASS
58	5290	1.24	0.51	1.75	11	PASS
106	5530	1.27	0.51	1.78	11	PASS
138	5690	1.66	0.51	2.17	11	PASS



For U-NII-3:

Note: dBm/500kHz= dBm/MHz+10\*log(0.5/1)= dBm/MHz-3.01

802.11a

CHANNEL	FREQUENCY (MHz)	PSD w/o Duty Factor (dBm/MHz)	PSD w/o Duty Factor (dBm/500kHz)	Duty Factor	PSD with Duty Factor (dBm/500kHz)	LIMIT (dBm/500kHz)	PASS /FAIL
144	5720	6.12	3.11	/	3.11	30	PASS
149	5745	5.78	2.77	/	2.77	30	PASS
157	5785	5.44	2.43	/	2.43	30	PASS
161	5805	5.09	2.08	/	2.08	30	PASS

802.11n (20MHz)

CHANNEL	FREQUENCY (MHz)	PSD w/o Duty Factor (dBm/MHz)	PSD w/o Duty Factor (dBm/500kHz)	Duty Factor	PSD with Duty Factor (dBm/500kHz)	LIMIT (dBm/500kHz)	PASS /FAIL
144	5720	4.55	1.54	/	1.54	30	PASS
149	5745	3.67	0.66	/	0.66	30	PASS
157	5785	3.38	0.37	/	0.37	30	PASS
161	5805	3.16	0.15	/	0.15	30	PASS

802.11n (40MHz)

CHANNEL	FREQUENCY (MHz)	PSD w/o Duty Factor (dBm/MHz)	PSD w/o Duty Factor (dBm/500kHz)	Duty Factor	PSD with Duty Factor (dBm/500kHz)	LIMIT (dBm/500kHz)	PASS /FAIL
142	5710	2.50	-0.51	0.22	-0.29	30	PASS
151	5755	1.88	-1.13	0.22	-0.91	30	PASS
159	5795	1.47	-1.54	0.22	-1.32	30	PASS



802.11ac (80MHz)

CHANNEL	FREQUENCY (MHz)	PSD w/o Duty Factor (dBm/MHz)	PSD w/o Duty Factor (dBm/500kHz)	Duty Factor	PSD with Duty Factor (dBm/500kHz)	LIMIT (dBm/500kHz)	PASS /FAIL
138	5690	-2.56	-5.57	0.51	-5.05	30	PASS
155	5775	-3.23	-6.24	0.51	-5.72	30	PASS



BUREAU VERITAS

Test Report No.: RF190823W003-3

For 5180~5240MHz

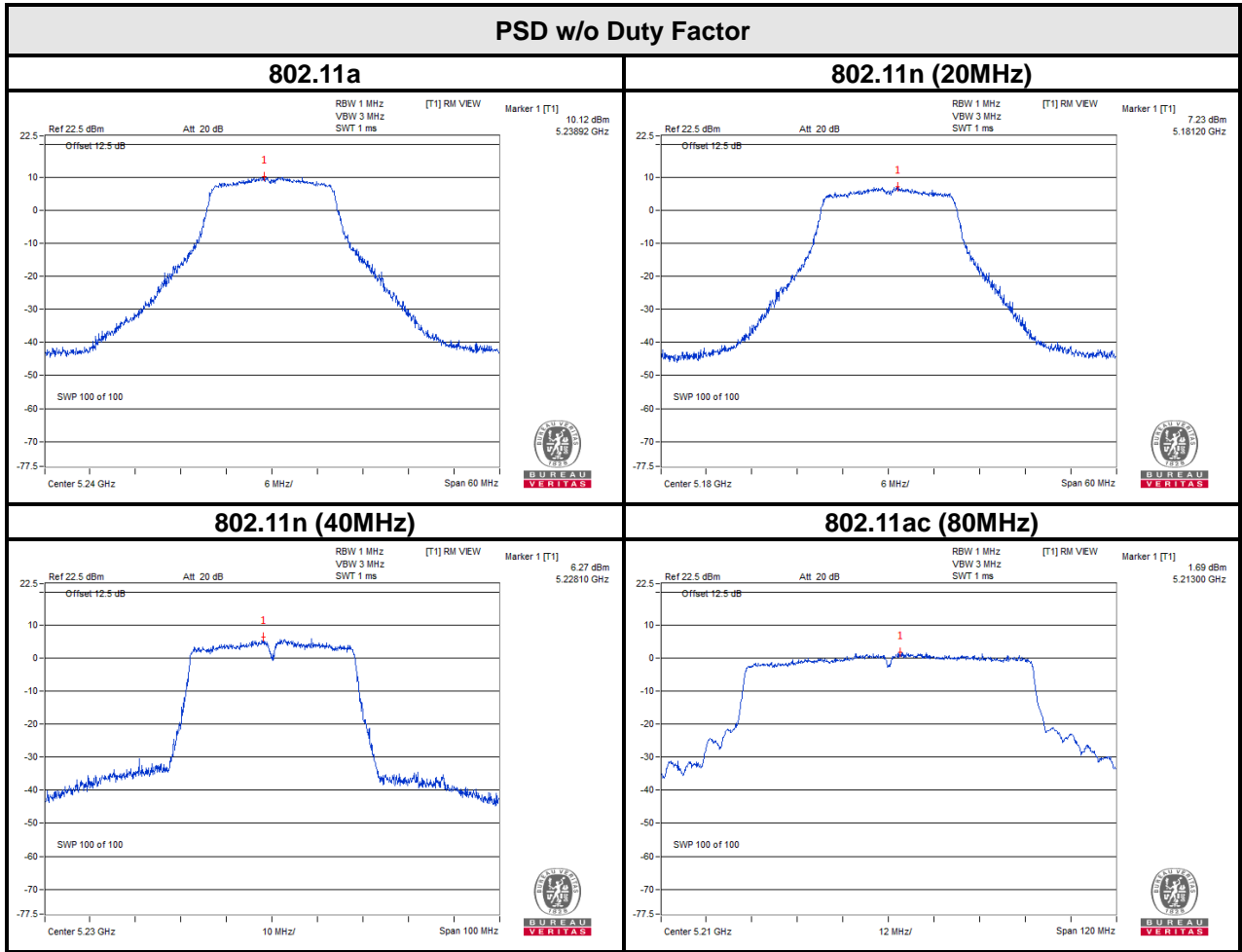





For 5260~5320MHz

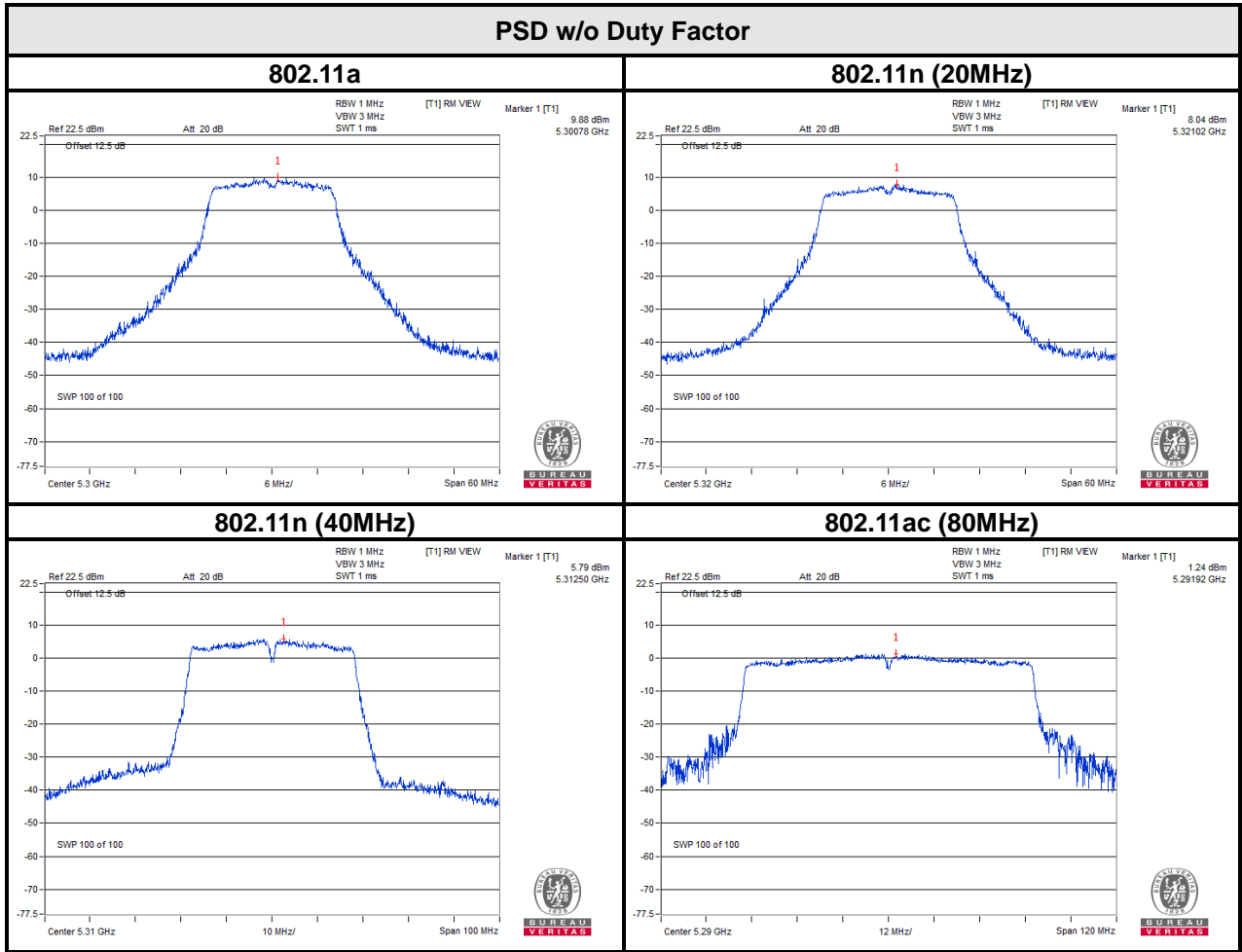



BUREAU VERITAS

Test Report No.: RF190823W003-3

For 5500~5700MHz

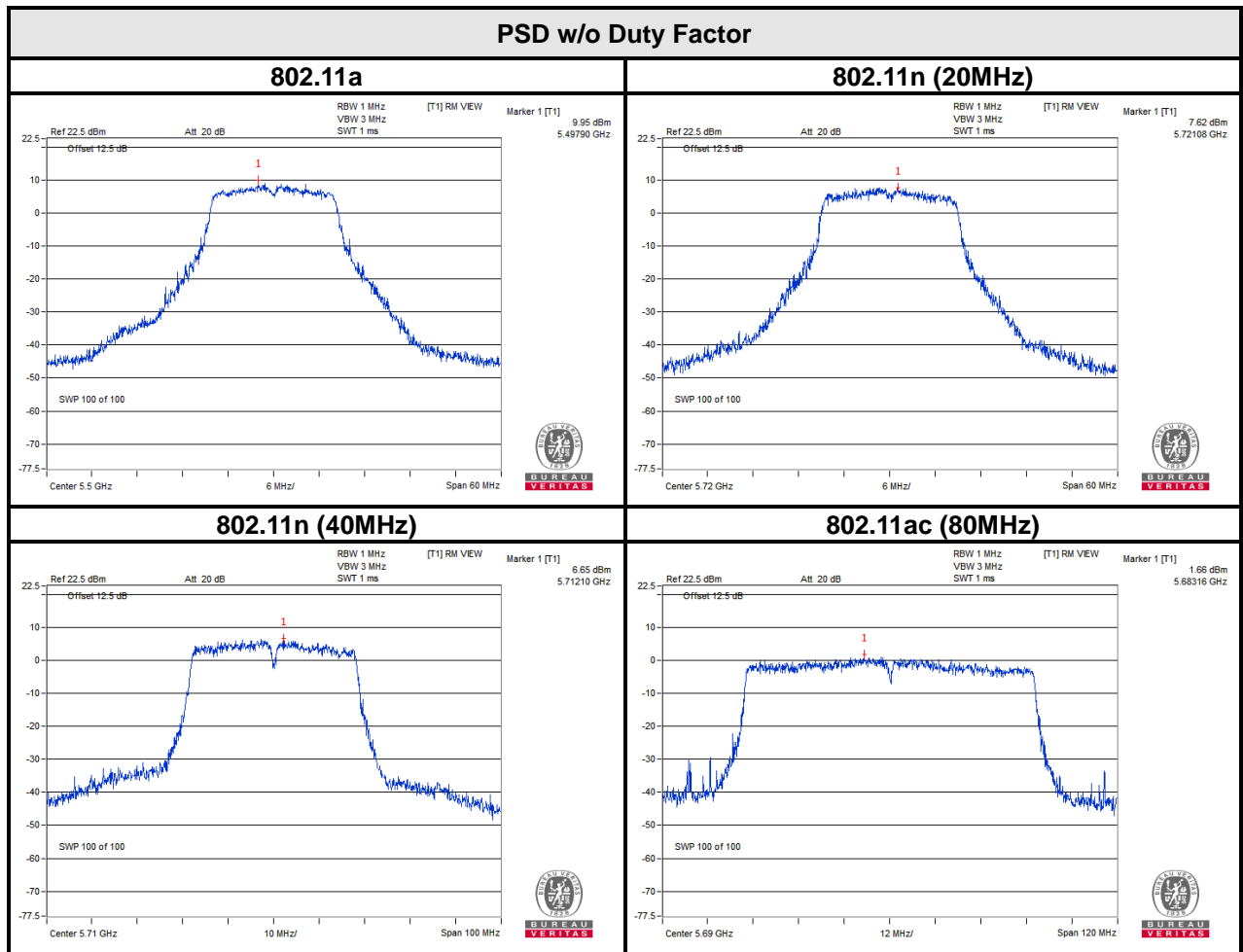



BUREAU VERITAS

Test Report No.: RF190823W003-3

For 5745~5805MHz

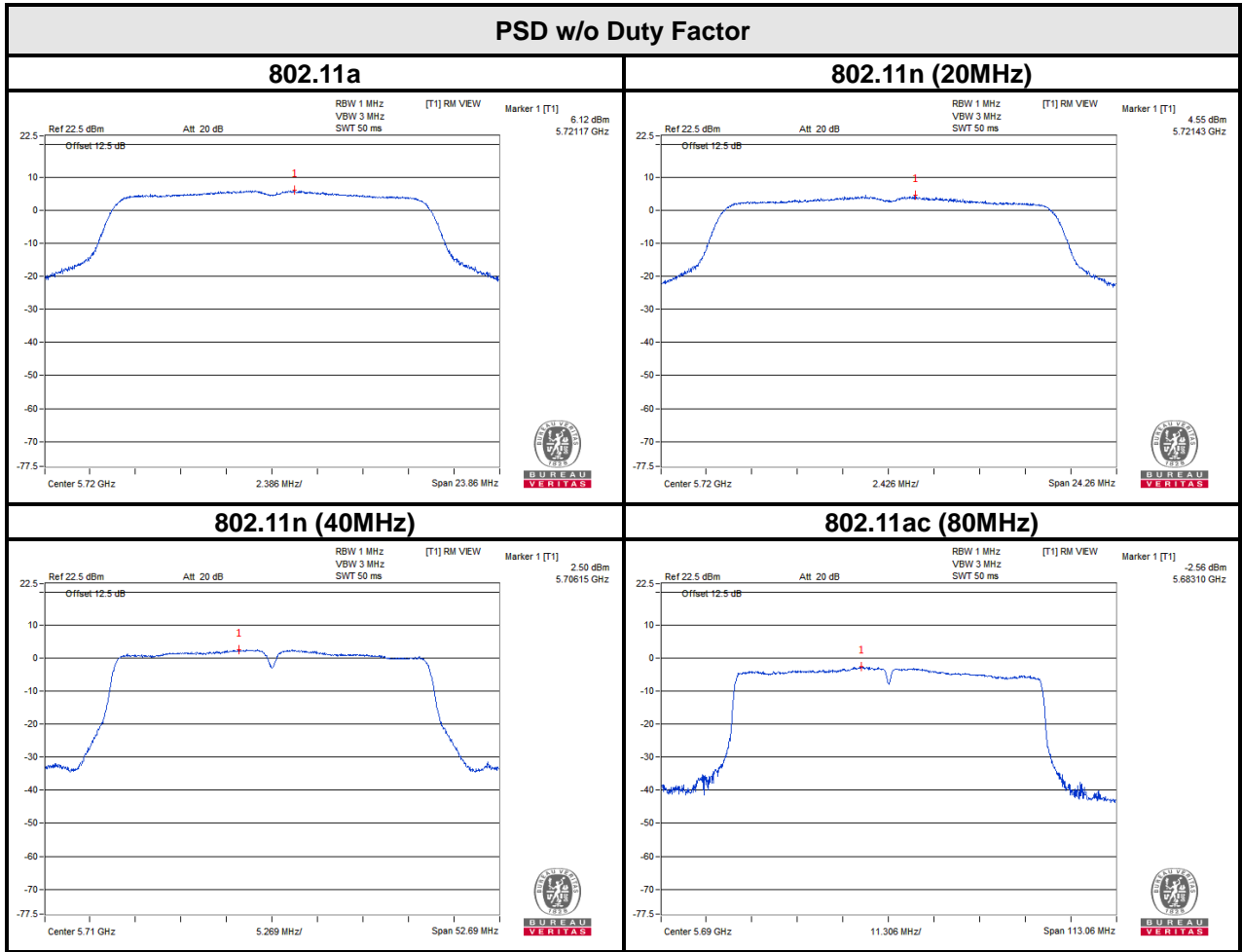



Test Report No.: RF190823W003-3

## 4 PHOTOGRAPHS OF THE TEST CONFIGURATION

Please refer to the attached file (Test Setup Photo).



## 5 APPENDIX A – MODIFICATIONS RECORDERS FOR ENGINEERING CHANGES TO THE EUT BY THE LAB

No modifications were made to the EUT by the lab during the test.

---END---