



RF TEST REPORT

Applicant Xiaomi Communications Co., Ltd.
FCC ID 2AFZZC3KH
Product Mobile Phone
Brand Redmi
Model M1908C3KH
Report No. R1907A0380-R1
Issue Date August 20, 2019

TA Technology (Shanghai) Co., Ltd. tested the above equipment in accordance with the requirements in **FCC CFR47 Part 2 (2018)/ FCC CFR 47 Part 22H (2018)**. The test results show that the equipment tested is capable of demonstrating compliance with the requirements as documented in this report.

Performed by: Peng Tao

Approved by: Kai Xu

TA Technology (Shanghai) Co., Ltd.

No.145, Jintang Rd, Tangzhen Industry Park, Pudong Shanghai, China

TEL: +86-021-50791141/2/3

FAX: +86-021-50791141/2/3-8000



TABLE OF CONTENT

1. Test Laboratory	4
1.1. Notes of the Test Report	4
1.2. Test facility	4
1.3. Testing Location	5
2. General Description of Equipment under Test.....	6
3. Applied Standards.....	8
4. Test Configuration.....	9
5. Test Case Results.....	11
5.1. RF Power Output.....	11
5.2. Effective Radiated Power	15
5.3. Occupied Bandwidth	20
5.4. Band Edge Compliance.....	32
5.5. Peak-to-Average Power Ratio (PAPR)	43
5.6. Frequency Stability	46
5.7. Spurious Emissions at Antenna Terminals	51
5.8. Radiates Spurious Emission	60
6. Main Test Instruments	66

Summary of measurement results

No.	Test Case	Clause in FCC rules	Verdict
1	RF power output	2.1046	PASS
2	Effective Radiated Power	22.913(a)(5)	PASS
3	Occupied Bandwidth	2.1049	PASS
4	Band Edge Compliance	2.1051 / 22.917(a)	PASS
5	Peak-to-Average Power Ratio	22.913(d)/ KDB 971168 D01(5.7)	PASS
6	Frequency Stability	2.1055 / 22.355	PASS
7	Spurious Emissions at Antenna Terminals	2.1051 / 22.917(a)	PASS
8	Radiates Spurious Emission	2.1053 / 22.917 (a)	PASS
Note: PASS: The EUT complies with the essential requirements in the standard. FAIL: The EUT does not comply with the essential requirements in the standard.			
Date of Testing: July 22, 2019~ August 12, 2019			



1. Test Laboratory

1.1. Notes of the Test Report

This report shall not be reproduced in full or partial, without the written approval of **TA technology (shanghai) co., Ltd.** The results documented in this report apply only to the tested sample, under the conditions and modes of operation as described herein .Measurement Uncertainties were not taken into account and are published for informational purposes only. This report is written to support regulatory compliance of the applicable standards stated above.

1.2. Test facility

FCC (Designation number: CN1179, Test Firm Registration Number: 446626)

TA Technology (Shanghai) Co., Ltd. has been listed on the US Federal Communications Commission list of test facilities recognized to perform electromagnetic emissions measurements.

IC (recognition number is 8510A)

TA Technology (Shanghai) Co., Ltd. has been listed by industry Canada to perform electromagnetic emission measurement.

VCCI (recognition number is C-4595, T-2154, R-4113, G-10766)

TA Technology (Shanghai) Co., Ltd. has been listed by industry Japan to perform electromagnetic emission measurement.

A2LA (Certificate Number: 3857.01)

TA Technology (Shanghai) Co., Ltd. has been listed by American Association for Laboratory Accreditation to perform electromagnetic emission measurement.



1.3. Testing Location

Company: TA Technology (Shanghai) Co., Ltd.
Address: No.145, Jintang Rd, Tangzhen Industry Park, Pudong
City: Shanghai
Post code: 201201
Country: P. R. China
Contact: Xu Kai
Telephone: +86-021-50791141/2/3
Fax: +86-021-50791141/2/3-8000
Website: <http://www.ta-shanghai.com>
E-mail: xukai@ta-shanghai.com



2. General Description of Equipment under Test

Client Information

Applicant	Xiaomi Communications Co., Ltd.
Applicant address	The Rainbow City of China Resources,NO.68,Qinghe Middle Street,Haidian District,Beijing,China
Manufacturer	Xiaomi Communications Co., Ltd.
Manufacturer address	The Rainbow City of China Resources,NO.68,Qinghe Middle Street,Haidian District,Beijing,China

General Information

EUT Description			
Model	M1908C3KH		
IMEI	IMEI 1:867195040017253 IMEI 2: 867195040017261		
Hardware Version	P2		
Software Version	MIUI 10		
Power Supply	Battery/AC adapter		
Antenna Type	PIFA Antenna		
Antenna Gain	-4.38dBi		
Test Mode(s)	GSM 850; WCDMA Band V;LTE Band 5;		
Test Modulation	(GSM)GMSK,8PSK; (WCDMA) BPSK, QPSK,16QAM; (LTE)QPSK 16QAM;		
GPRS Multislot Class	33		
EGPRS Multislot Class	33		
HSDPA UE Category	24		
HSUPA UE Category	6		
DC-HSDPA Category	24		
LTE Category	4		
Maximum E.R.P.	GSM 850:	25.27dBm	
	WCDMA Band V:	14.72dBm	
	LTE Band 5:	15.38dBm	
Rated Power Supply Voltage	3.85V		
Extreme Voltage	Minimum: 3.4V Maximum: 4.4V		
Extreme Temperature	Lowest: 0°C Highest: +40°C		
Operating Frequency Range(s)	Band	Tx (MHz)	Rx (MHz)
	GSM850	824 ~ 849	869 ~ 894
	WCDMA Band V	824 ~ 849	869 ~ 894
	LTE Band 5	824 ~ 849	869 ~ 894
EUT Accessory			



Adapter	Manufacturer: Jiangsu Chenyang Electron Co., Ltd. Model: MDY-09-EQ
Battery	Manufacturer: Sunwoda Electronic Co.,LTD Model: BN51
USB Cable 1	Manufacturer: LUXSHARE Precision Industry Co., Ltd. Model: L23312 100cm Cable, Shielded
USB Cable 2	Manufacturer: SU ZHOU KELI SCIENCE&TECHNOLOGY DEVELOPMENT CO.,LTD Model: K23312 100cm Cable, Shielded
<p>Note: 1. The information of the EUT is declared by the manufacturer. 2. There is more than one SIM and USB cable, each one should be applied throughout the compliance test respectively, and however, only the worst case (SIM 1/ USB cable 1) will be recorded in this report.</p>	



3. Applied Standards

According to the specifications of the manufacturer, it must comply with the requirements of the following standards:

FCC CFR47 Part 2 (2018)

FCC CFR 47 Part 22H (2018)

ANSI C63.26 (2015)

KDB 971168 D01 Power Meas License Digital Systems v03r01

4. Test Configuration

There is more than one SIM card slot, each one should be applied throughout the compliance test respectively, and however, only the worst case (SIM 1) will be recorded in this report.

Radiated measurements are performed by rotating the EUT in three different orthogonal test planes. EUT stand-up position (Z axis), lie-down position (X, Y axis). Receiver antenna polarization (horizontal and vertical), the worst emission was found in position (X axis, horizontal polarization) and the worst case was recorded.

All mode and data rates and positions were investigated. Subsequently, only the worst case emissions are reported.

The following testing in GSM/WCDMA/LTE is set based on the maximum RF Output Power.

Test modes are chosen to be reported as the worst case configuration below:

Test items	Modes/Modulation	
	GSM 850	WCDMA Band V
RF power output	GSM GPRS EGPRS	RMC HSDPA/HSUPA DC-HSDPA
Effective Radiated Power	GSM GPRS(1Tx slot) EGPRS(1Tx slot)	RMC
Occupied Bandwidth	GSM GPRS(1Tx slot) EGPRS(1Tx slot)	RMC
Band Edge Compliance	GSM GPRS(1Tx slot) EGPRS(1Tx slot)	RMC
Peak-to-Average Power Ratio	GSM GPRS(1Tx slot) EGPRS(1Tx slot)	RMC
Frequency Stability	GSM GPRS(1Tx slot) EGPRS(1Tx slot)	RMC
Spurious Emissions at Antenna Terminals	GSM	RMC
Radiates Spurious Emission	GSM	RMC

Test modes are chosen as the worst case configuration below for LTE Band 5.

Test items	Bandwidth (MHz)				Modulation		RB			Test Channel		
	1.4	3	5	10	QPSK	16QAM	1	50%	100%	L	M	H
RF power output	O	O	O	O	O	O	O	O	O	O	O	O
Effective Isotropic Radiated power	O	O	O	O	O	O	O	O	O	O	O	O
Occupied Bandwidth	O	O	O	O	O	O	-	-	O	-	O	-
Band Edge Compliance	O	O	O	O	O	O	O	-	O	O	-	O
Peak-to-Average Power Ratio	O	O	O	O	O	O	-	-	O	O	O	O
Frequency Stability	O	O	O	O	O	O	O	O	O	O	O	O
Spurious Emissions at Antenna Terminals	O	O	O	O	O	-	O	-	-	O	O	O
Radiates Spurious Emission	O	-	O	O	O	-	O	-	-	O	O	O
Note	1. The mark "O" means that this configuration is chosen for testing. 2. The mark "-" means that this configuration is not testing.											

5. Test Case Results

5.1. RF Power Output

Ambient condition

Temperature	Relative humidity	Pressure
23°C ~25°C	45%~50%	101.5kPa

Methods of Measurement

During the process of the testing, The EUT is controlled by the Base Station Simulator to ensure max power transmission and proper modulation.

Test Setup

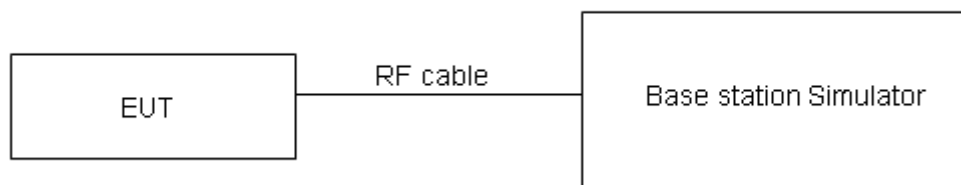

The loss between RF output port of the EUT and the input port of the tester has been taken into consideration.

Limits

No specific RF power output requirements in part 2.1046.

Measurement Uncertainty

The assessed measurement uncertainty to ensure 95% confidence level for the normal distribution is with the coverage factor $k = 2$, $U = 0.4$ dB.

Test Results

GSM 850		Conducted Power(dBm)		
		Channel 128	Channel 190	Channel 251
		824.2 (MHz)	836.6 (MHz)	848.8 (MHz)
GSM	Results	32.51	32.64	32.74
GPRS (GMSK)	1TXslot	32.44	32.68	32.68
	2TXslots	29.74	29.83	29.88
	3TXslots	28.02	28.12	28.18
	4TXslots	26.62	27.01	26.98
EGPRS (8PSK)	1TXslot	26.04	26.07	26.13
	2TXslots	23.29	23.28	23.35
	3TXslots	21.65	21.58	21.71
	4TXslots	20.33	20.37	20.38

WCDMA Band V		Conducted Power(dBm)		
		Channel 4132	Channel 4183	Channel 4233
		826.4(MHz)	836.6(MHz)	846.6(MHz)
RMC		22.82	22.79	22.84
HSDPA	Sub - Test 1	22.24	22.21	22.26
	Sub - Test 2	22.23	22.20	22.25
	Sub - Test 3	21.72	21.69	21.74
	Sub - Test 4	21.71	21.68	21.73
HSUPA	Sub - Test 1	22.20	22.17	22.22
	Sub - Test 2	21.19	21.16	21.21
	Sub - Test 3	21.67	21.65	21.70
	Sub - Test 4	21.16	21.14	21.19
	Sub - Test 5	22.15	22.13	22.18
DC-HSDPA	Sub - Test 1	22.16	22.15	22.18
	Sub - Test 2	22.15	22.14	22.17
	Sub - Test 3	21.73	21.63	21.68
	Sub - Test 4	21.72	21.62	21.67



LTE FDD Band 5				Conducted Power(dBm)		
Bandwidth	Modulation	RB size	RB offset	Channel/Frequency (MHz)		
				20407/824.7	20525/836.5	20643/848.3
1.4MHz	QPSK	1	0	22.56	22.81	22.53
		1	2	22.72	22.72	23.06
		1	5	22.57	22.52	22.76
		3	0	22.97	22.75	23.10
		3	2	23.00	22.77	22.94
		3	3	22.87	22.85	23.00
		6	0	21.89	21.71	21.99
	16QAM	1	0	22.36	22.09	21.93
		1	2	22.22	22.21	22.00
		1	5	22.14	22.21	21.64
		3	0	22.07	21.83	22.06
		3	2	22.05	21.92	22.06
		3	3	22.12	21.98	21.82
		6	0	21.13	20.83	21.04
Bandwidth	Modulation	RB size	RB offset	Channel/Frequency (MHz)		
				20415/825.5	20525/836.5	20635/847.5
3MHz	QPSK	1	0	22.57	22.84	22.58
		1	7	22.71	22.86	23.11
		1	14	22.74	22.61	22.62
		8	0	21.99	21.91	22.09
		8	4	21.94	21.78	21.97
		8	7	21.94	21.89	22.08
		15	0	21.93	21.78	21.99
	16QAM	1	0	22.27	22.01	21.90
		1	7	22.33	22.13	21.92
		1	14	22.11	22.19	21.81
		8	0	21.04	20.84	21.11
		8	4	21.06	20.88	21.09
		8	7	21.12	20.97	20.91
		15	0	21.09	20.78	21.03
Bandwidth	Modulation	RB size	RB offset	Channel/Frequency (MHz)		
				20425/826.5	20525/836.5	20625/846.5
5MHz	QPSK	1	0	22.63	22.80	22.61
		1	13	22.70	22.90	23.19
		1	24	22.56	22.65	22.71
		12	0	21.87	21.80	22.09
		12	6	21.90	21.72	21.92
		12	13	21.93	21.85	22.04
		25	0	22.00	21.82	21.95



Bandwidth	Modulation	RB size	RB offset	Channel/Frequency (MHz)		
				20450/829	20525/836.5	20600/844
	16QAM	1	0	22.27	22.15	21.85
		1	13	22.15	22.07	21.99
		1	24	22.21	22.18	21.77
		12	0	21.03	20.85	21.05
		12	6	20.97	20.81	21.01
		12	13	21.12	20.99	20.93
		25	0	21.05	20.84	20.91
10MHz	QPSK	1	0	22.67	22.94	22.69
		1	25	22.89	22.91	23.22
		1	49	22.76	22.67	22.78
		25	0	22.01	21.91	22.10
		25	13	22.03	21.92	22.09
		25	25	22.04	21.94	22.08
		50	0	22.03	21.90	22.05
	16QAM	1	0	22.39	22.18	22.03
		1	25	22.33	22.22	22.04
		1	49	22.27	22.24	21.84
		25	0	21.11	20.92	21.20
		25	13	21.10	20.95	21.14
		25	25	21.14	21.05	21.01
		50	0	21.20	20.91	21.06

5.2. Effective Radiated Power

Ambient condition

Temperature	Relative humidity	Pressure
23°C ~25°C	45%~50%	101.5kPa

Methods of Measurement

The testing follows FCC KDB 971168 v03r01 Section 5.8 and ANSI C63.26 (2015).

- a) Connect the equipment as illustrated. Mount the equipment with the manufacturer specified antenna in a vertical orientation on a manufacturer specified mounting surface located on a non-conducting rotating platform of a RF anechoic chamber (preferred) or a standard radiation site.
- b) Key the transmitter, then rotate the EUT 360° azimuthally and record spectrum analyzer power level (LVL) measurements at angular increments that are sufficiently small to permit resolution of all peaks. If a standard radiation test site is used, raise and lower the test antenna to obtain a maximum reading at each angular increment. (Note: several batteries may be needed to offset the effect of battery voltage droop, which should not exceed 5% of the manufactured specified battery voltage during transmission).
- c) Replace the transmitter under test with a vertically polarized half-wave dipole (or an antenna whose gain is known relative to an ideal half-wave dipole). The center of the antenna should be at the same location as the center of the antenna under test.
- d) Connect the antenna to a signal generator with a known output power and record the path loss (in dB) as LOSS. If a standard radiation test site is used, raise and lower the test antenna to obtain a maximum reading. $LOSS = \text{Generator Output Power (dBm)} - \text{Analyzer reading (dBm)}$
- e) Determine the effective radiated output power at each angular position from the readings in steps b) and d) using the following equation: $ERP \text{ (dBm)} = \text{LVL (dBm)} + \text{LOSS (dB)}$
- f) The maximum ERP is the maximum value determined in the preceding step.
- g) When calculating ERP, in addition to knowing the antenna radiation and matching characteristics, it is necessary to know the loss values of all elements (e.g. transmission line attenuation, mismatches, filters, combiners) interposed between the point where transmitter output power is measured, and the point where power is applied to the antenna. ERP can then be calculated as follows:
 $EIRP \text{ (dBm)} = \text{Output Power (dBm)} - \text{Losses (dB)} + \text{Antenna Gain (dBi)}$
where: dBd refers to gain relative to an ideal dipole.
 $EIRP \text{ (dBm)} = ERP \text{ (dBm)} + 2.15 \text{ (dB.)}$

The RB allocation refers to section 5.1, using the maximum output power configuration.

Test setup

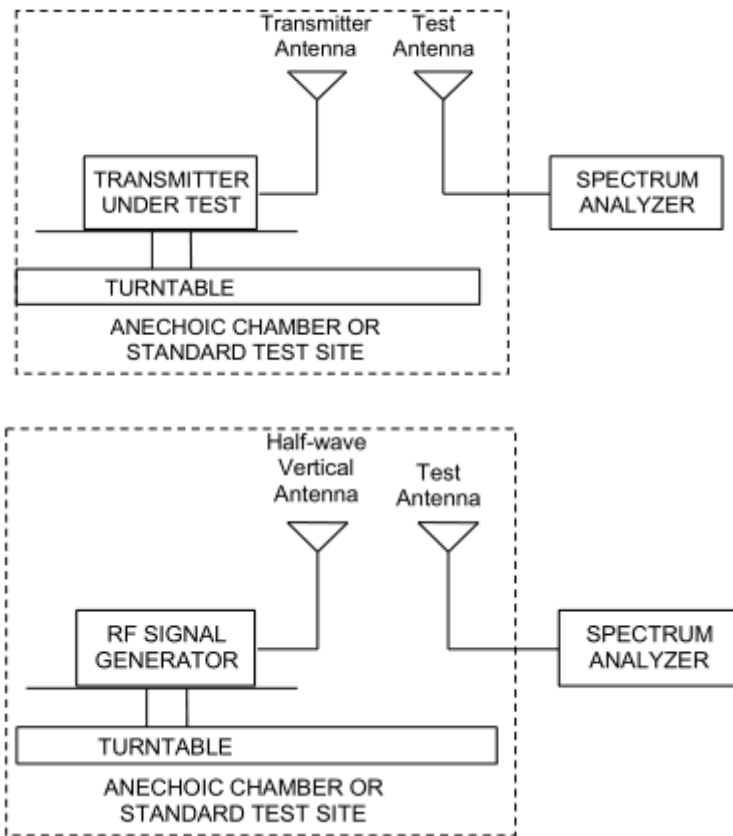

Limits

Rule Part 22.913(a)(5) specifies that "Mobile/portable stations are limited to 7 watts ERP".

Limit	$\leq 7 \text{ W}$ (38.45 dBm)
-------	--------------------------------

Measurement Uncertainty

The assessed measurement uncertainty to ensure 95% confidence level for the normal distribution is with the coverage factor $k = 2$, $U = 1.19 \text{ dB}$

Test Results: The measurement is performed for both of horizontal and vertical antenna Polarization, and only the data of worst mode is recorded in this report.

Mode	Channel	Frequency (MHz)	Polarization	ERP (dBm)	Limit (dBm)	Conclusion
GSM 850	Low	824.2	Horizontal	25.27	38.45	Pass
	Mid	836.6	Horizontal	24.27	38.45	Pass
	High	848.8	Horizontal	23.37	38.45	Pass
GPRS 850	Low	824.2	Horizontal	24.42	38.45	Pass
	Mid	836.6	Horizontal	23.68	38.45	Pass
	High	848.8	Horizontal	23.17	38.45	Pass
EGPRS 850	Low	824.2	Horizontal	21.26	38.45	Pass
	Mid	836.6	Horizontal	20.58	38.45	Pass
	High	848.8	Horizontal	20.14	38.45	Pass
WCDMA Band V	Low	826.4	Horizontal	14.72	38.45	Pass
	Mid	836.6	Horizontal	13.94	38.45	Pass
	High	846.6	Horizontal	13.43	38.45	Pass

LTE Band 5						
bandwidth	Channel	Frequency (MHz)	Polarization	ERP (dBm)	Limit (dBm)	Conclusion
1.4 MHz (QPSK)	Low	824.7	Horizontal	15.27	38.45	Pass
	Mid	836.5	Horizontal	14.22	38.45	Pass
	High	848.3	Horizontal	13.49	38.45	Pass
3 MHz (QPSK)	Low	825.5	Horizontal	15.38	38.45	Pass
	Mid	836.5	Horizontal	14.51	38.45	Pass
	High	847.5	Horizontal	13.70	38.45	Pass
5 MHz (QPSK)	Low	826.5	Horizontal	15.11	38.45	Pass
	Mid	836.5	Horizontal	14.52	38.45	Pass
	High	846.5	Horizontal	13.71	38.45	Pass
10 MHz (QPSK)	Low	829	Horizontal	15.30	38.45	Pass
	Mid	836.5	Horizontal	14.40	38.45	Pass
	High	844	Horizontal	13.77	38.45	Pass
1.4 MHz (16QAM)	Low	824.7	Horizontal	14.73	38.45	Pass
	Mid	836.5	Horizontal	13.70	38.45	Pass
	High	848.3	Horizontal	12.95	38.45	Pass
3 MHz (16QAM)	Low	825.5	Horizontal	14.86	38.45	Pass
	Mid	836.5	Horizontal	13.92	38.45	Pass
	High	847.5	Horizontal	13.19	38.45	Pass
5 MHz (16QAM)	Low	826.5	Horizontal	14.57	38.45	Pass
	Mid	836.5	Horizontal	13.99	38.45	Pass
	High	846.5	Horizontal	13.15	38.45	Pass
10 MHz (16QAM)	Low	829	Horizontal	14.76	38.45	Pass
	Mid	836.5	Horizontal	13.85	38.45	Pass
	High	844	Horizontal	13.20	38.45	Pass
1.4 MHz (64QAM)	Low	824.7	Horizontal	14.30	38.45	Pass
	Mid	836.5	Horizontal	13.16	38.45	Pass
	High	848.3	Horizontal	12.44	38.45	Pass
3 MHz (64QAM)	Low	825.5	Horizontal	14.30	38.45	Pass
	Mid	836.5	Horizontal	13.38	38.45	Pass
	High	847.5	Horizontal	12.66	38.45	Pass
5 MHz (64QAM)	Low	826.5	Horizontal	14.03	38.45	Pass
	Mid	836.5	Horizontal	13.47	38.45	Pass
	High	846.5	Horizontal	12.58	38.45	Pass
10 MHz (64QAM)	Low	829	Horizontal	14.22	38.45	Pass
	Mid	836.5	Horizontal	13.33	38.45	Pass



LTE Band 5						
bandwidth	Channel	Frequency (MHz)	Polarization	ERP (dBm)	Limit (dBm)	Conclusion
	High	844	Horizontal	12.61	38.45	Pass

5.3. Occupied Bandwidth

Ambient condition

Temperature	Relative humidity	Pressure
23°C ~25°C	45%~50%	101.5kPa

Method of Measurement

The EUT was connected to Spectrum Analyzer and Base Station Simulator via power Splitter. The occupied bandwidth is measured using spectrum analyzer.

RBW is set to 3kHz, VBW is set to 10kHz for GSM 850,

RBW is set to 51kHz, VBW is set to 160kHz for WCDMA Band V,

RBW is set to 51 kHz, VBW is set to 160 kHz for LTE Band 5 (1.4MHz),

RBW is set to 100 kHz, VBW is set to 300 kHz for LTE Band 5 (3MHz/5MHz),

RBW is set to 300 kHz, VBW is set to 1 MHz for LTE Band 5 (10MHz),

99% power and -26dBc occupied bandwidths are recorded. Spectrum analyzer plots are included on the following pages.

Test Setup

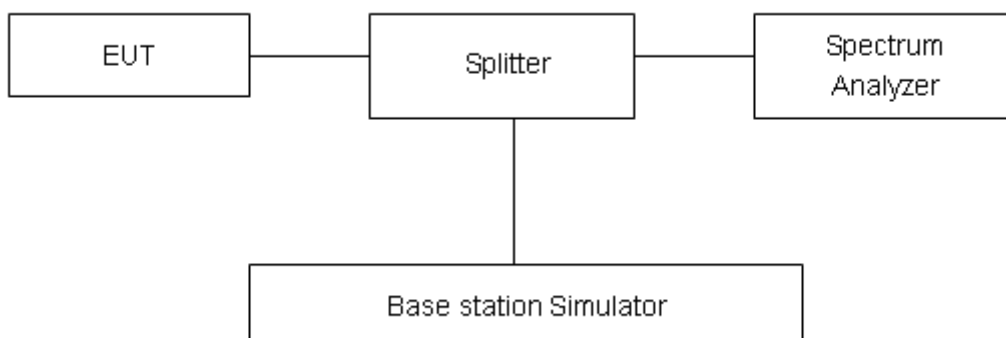

Limits

No specific occupied bandwidth requirements in part 2.1049.

Measurement Uncertainty

The assessed measurement uncertainty to ensure 95% confidence level for the normal distribution is with the coverage factor $k = 2$, $U = 624\text{Hz}$.

Test Result

Mode	Channel	Frequency (MHz)	99% Power Bandwidth (MHz)	-26dBc Bandwidth(MHz)
GSM 850 (GSM)	128	824.2	0.24305	0.3098
	190	836.6	0.24604	0.3100
	251	848.8	0.24463	0.3114
GPRS 850 (GMSK)	128	824.2	0.24737	0.3156
	190	836.6	0.24545	0.3131
	251	848.8	0.24559	0.3062
EGPRS 850 (8-PSK)	128	824.2	0.24308	0.3070
	190	836.6	0.24289	0.3080
	251	848.8	0.24591	0.3146
WCDMA Band V (RMC)	4132	826.4	4.1176	4.643
	4183	836.6	4.1337	4.658
	4233	846.6	4.1179	4.657



LTE Band 5						
RB	Modulation	Bandwidth (MHz)	Channel	Frequency (MHz)	99% Power Bandwidth(MHz)	-26dBc Bandwidth(MHz)
100%	QPSK	1.4	20407	824.7	1.1240	1.343
			20525	836.5	1.1262	1.349
			20643	848.3	1.1214	1.333
		3	20415	825.5	2.7431	3.083
			20525	836.5	2.7454	3.027
			20635	847.5	2.7478	3.049
		5	20425	826.5	4.5113	5.030
			20525	836.5	4.5134	5.017
			20625	846.5	4.5194	5.037
		10	20450	829	9.0358	10.080
			20525	836.5	9.0279	10.040
			20600	844	9.0098	10.040
	16QAM	1.4	20407	824.7	1.1186	1.330
			20525	836.5	1.1065	1.326
			20643	848.3	1.1153	1.325
		3	20415	825.5	2.7369	3.038
			20525	836.5	2.7373	3.034
			20635	847.5	2.7396	3.021
		5	20425	826.5	4.5285	5.025
			20525	836.5	4.5362	5.031
			20625	846.5	4.5025	4.976
		10	20450	829	9.0260	10.000
			20525	836.5	9.0594	10.020
			20600	844	9.0016	10.060
	64QAM	1.4	20407	824.7	1.1255	1.339
			20525	836.5	1.1221	1.308
			20643	848.3	1.1207	1.347
		3	20415	825.5	2.7580	3.073
			20525	836.5	2.7377	3.060
			20635	847.5	2.7397	3.067
5		20425	826.5	4.5255	5.040	



			20525	836.5	4.5008	4.896
			20625	846.5	4.5360	5.011
		10	20450	829	9.0311	10.030
			20525	836.5	9.0270	10.010
			20600	844	9.0219	9.982

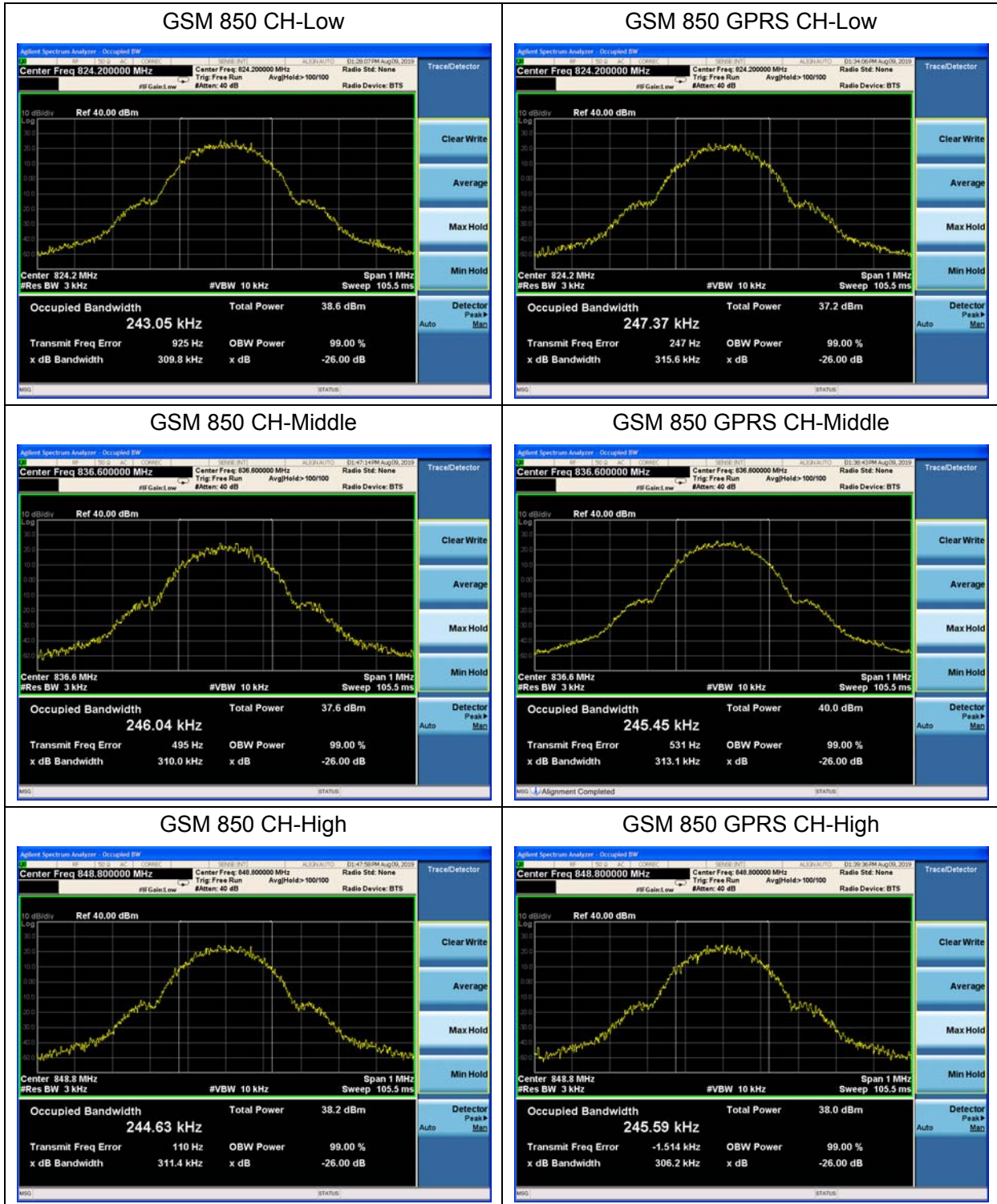

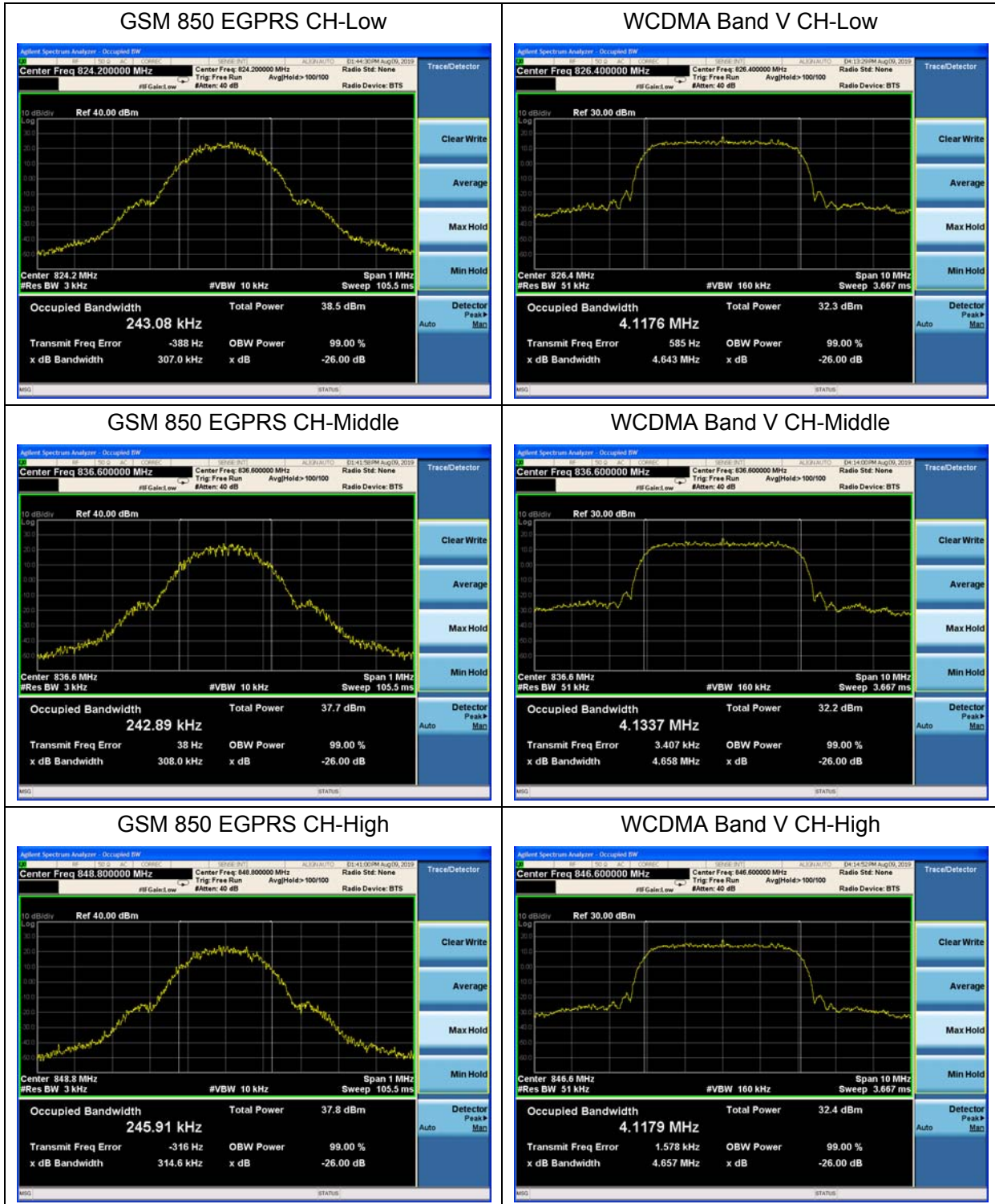

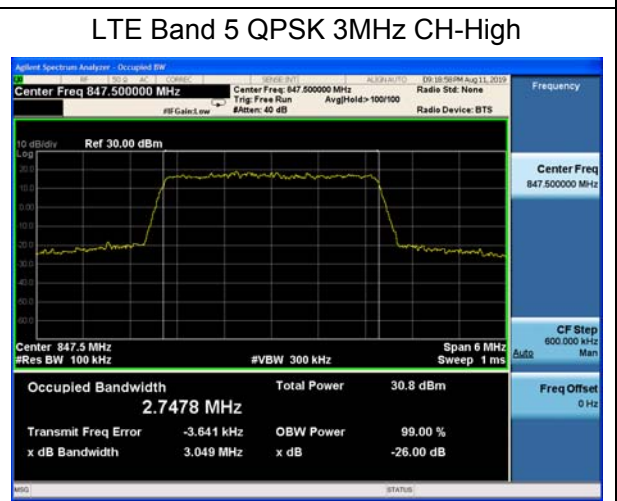
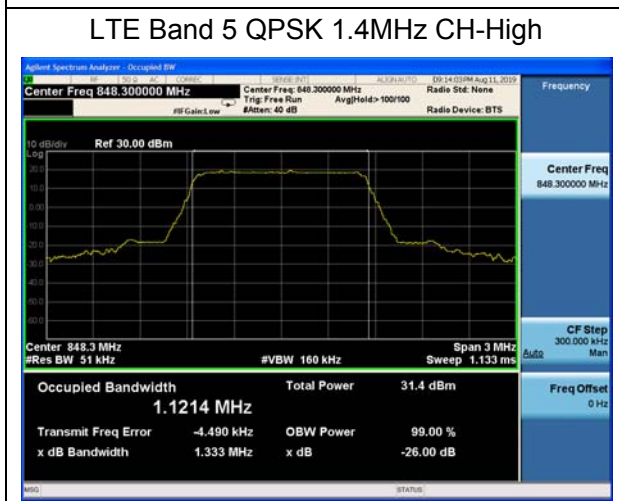
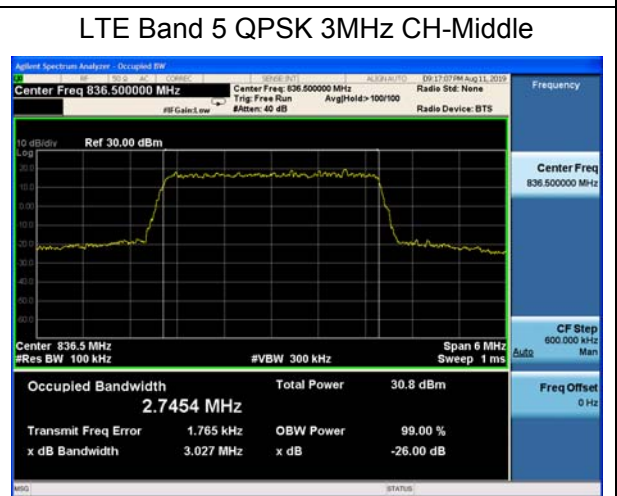
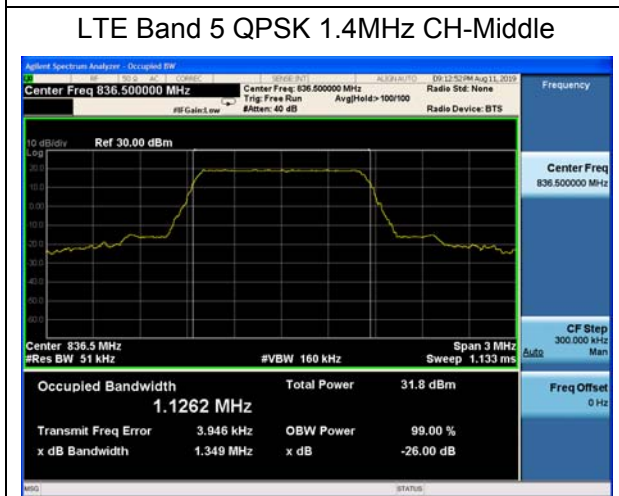
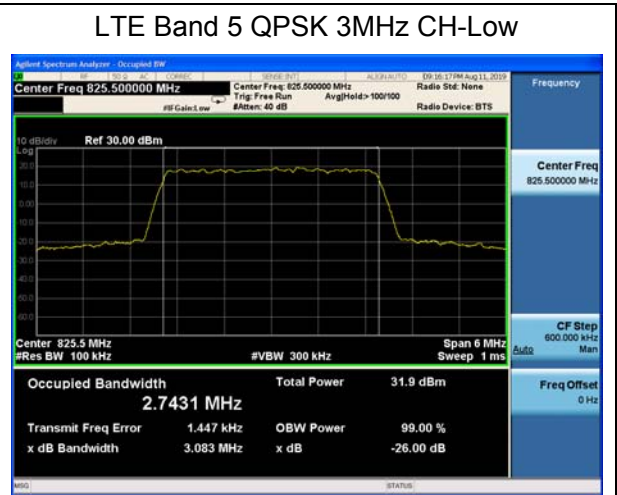
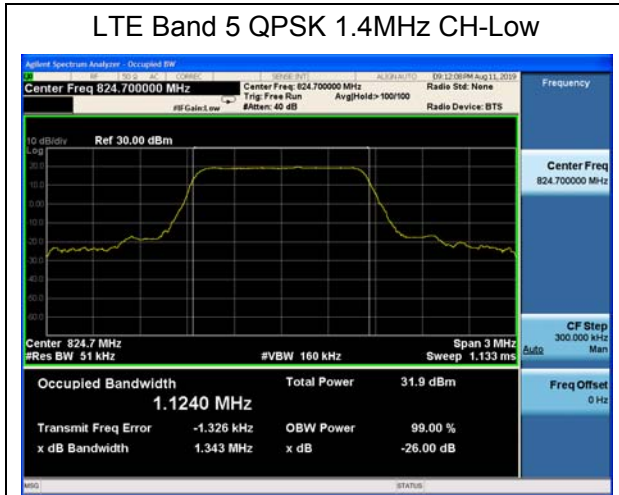

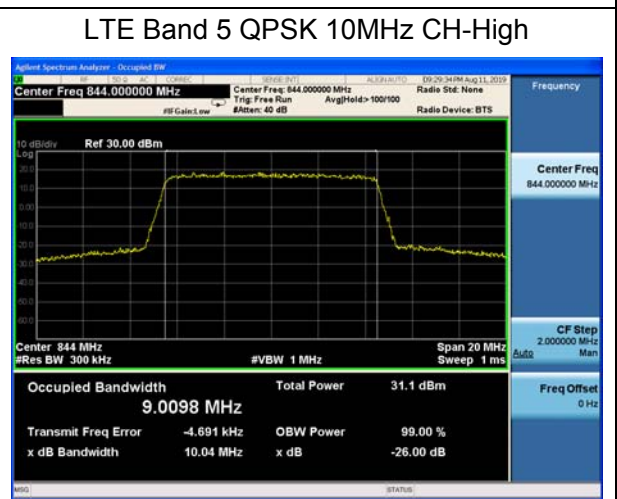
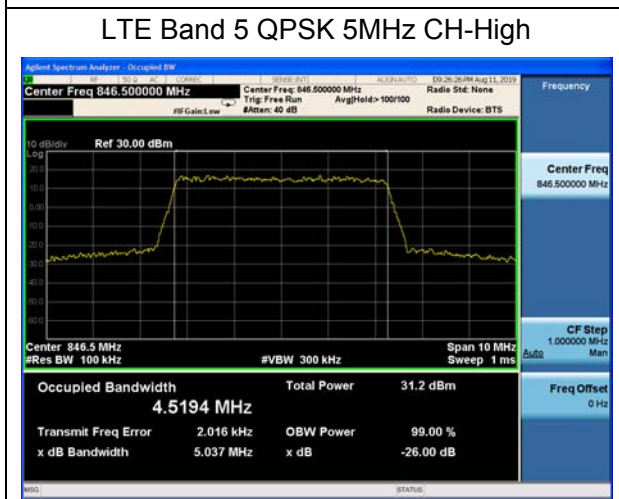
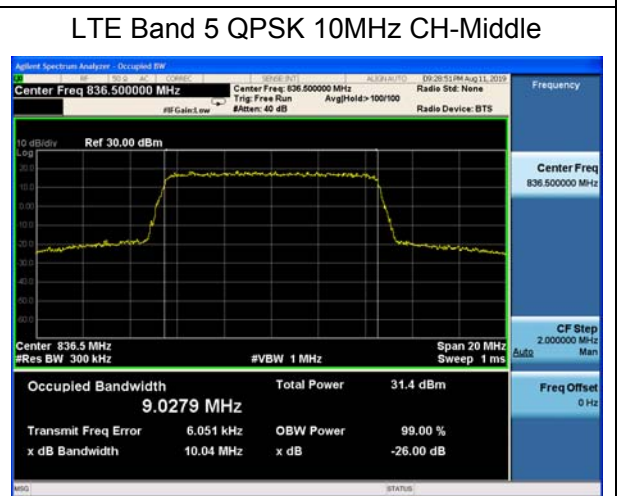
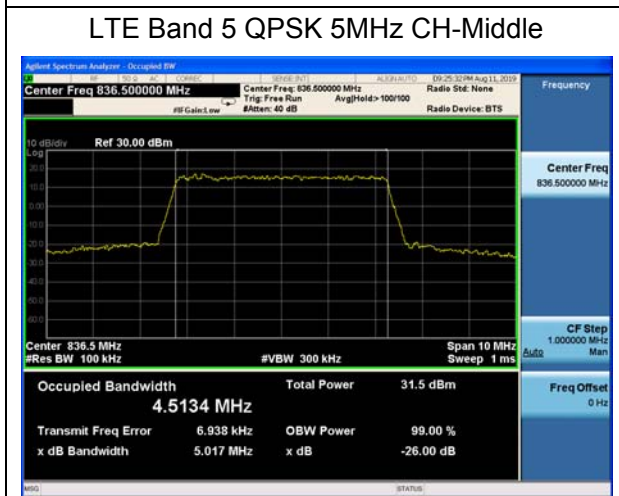
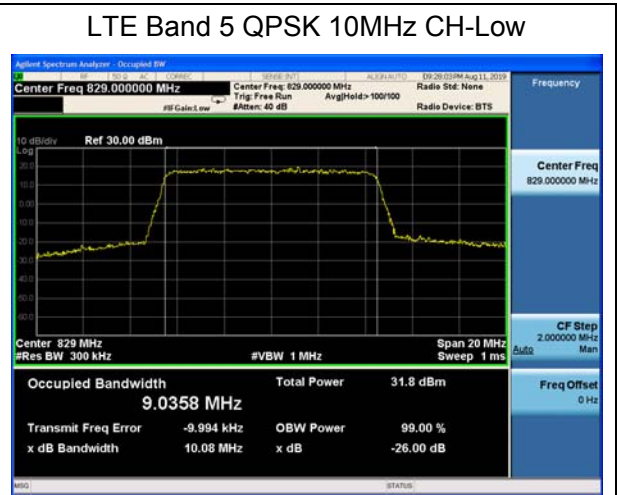
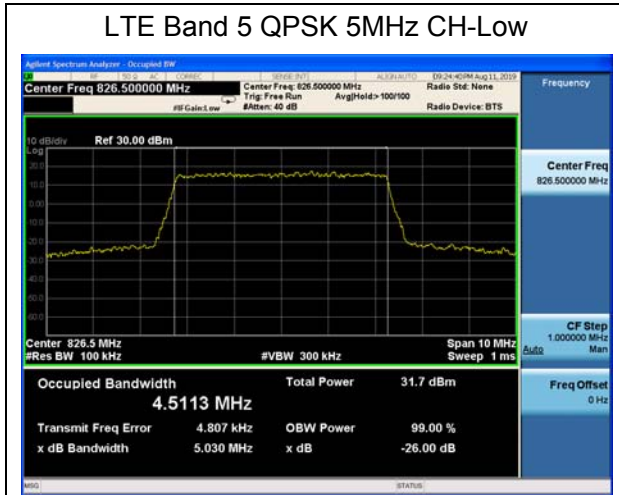

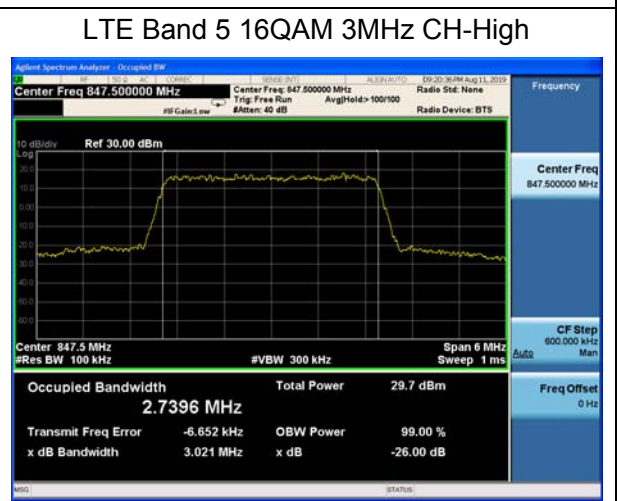
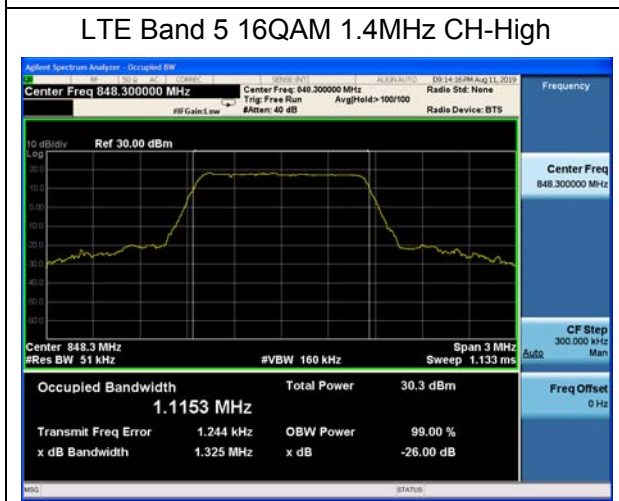
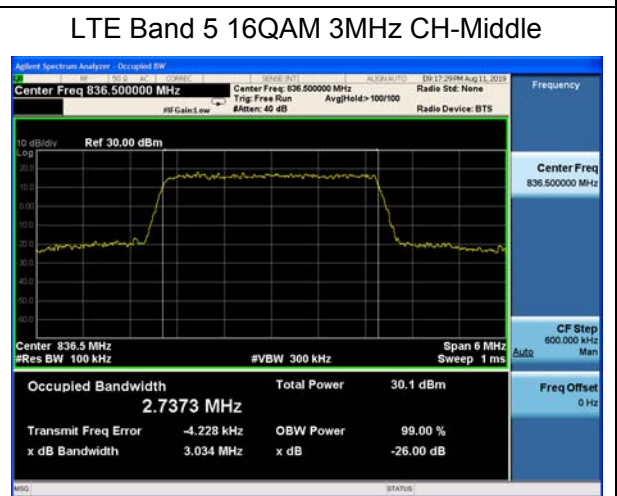
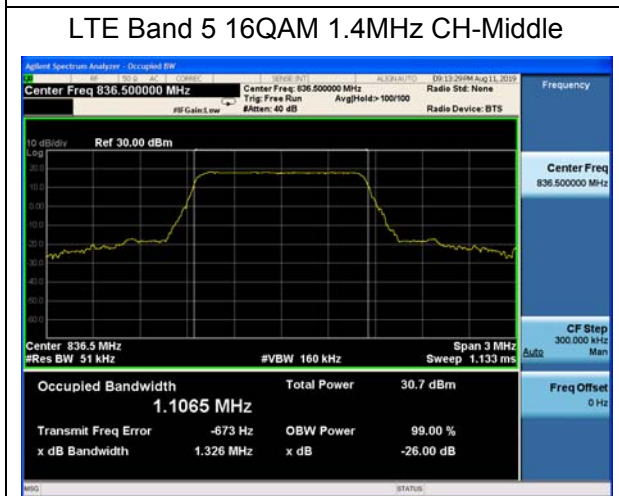
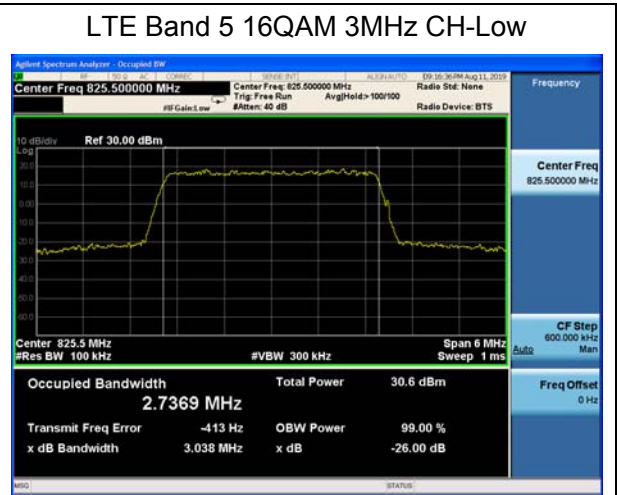
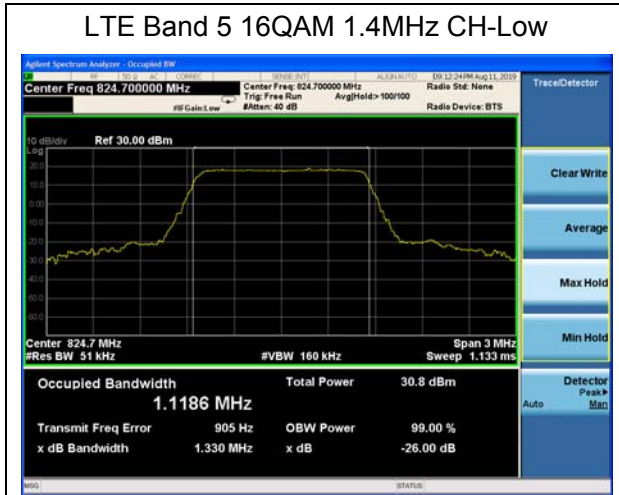



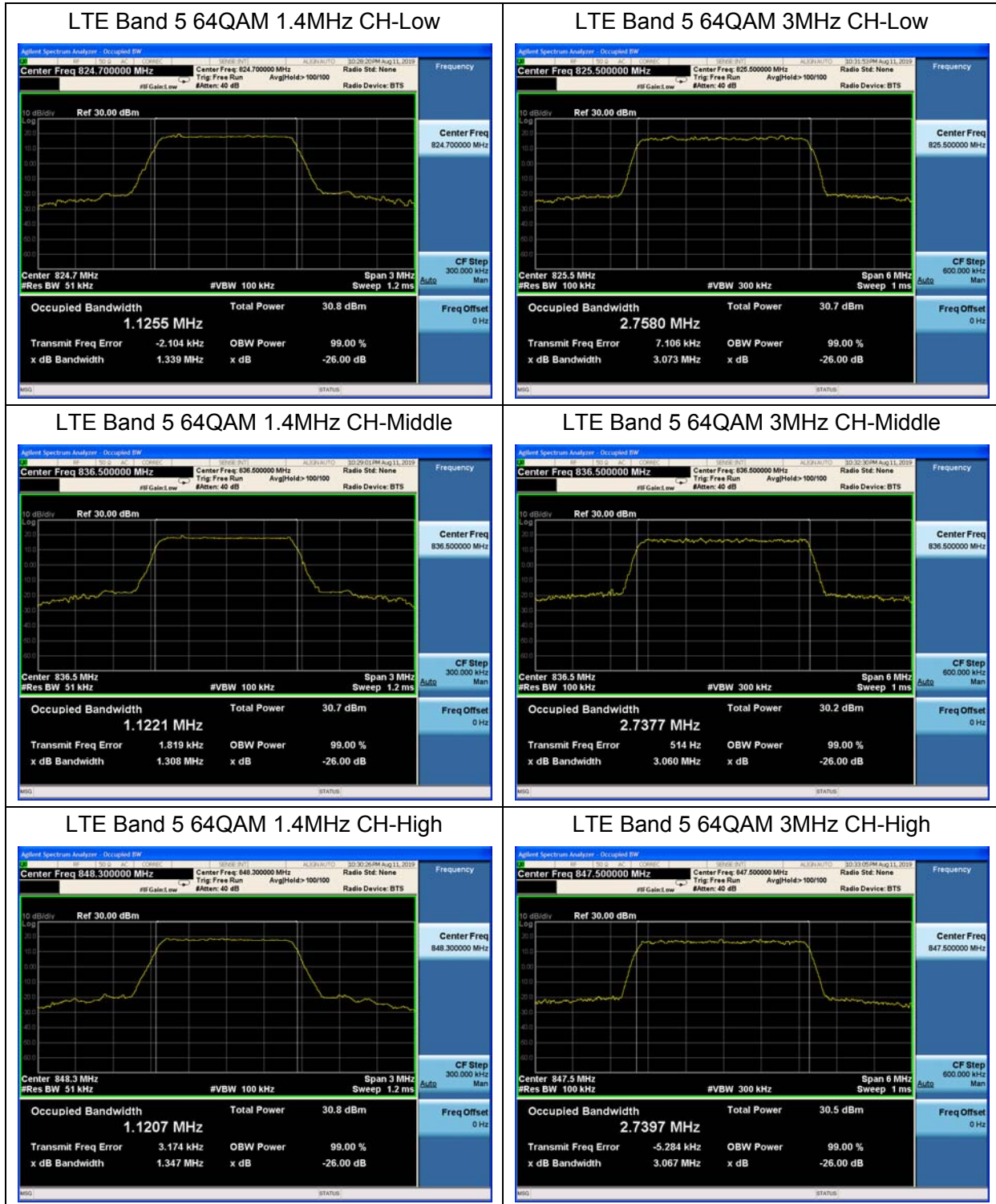

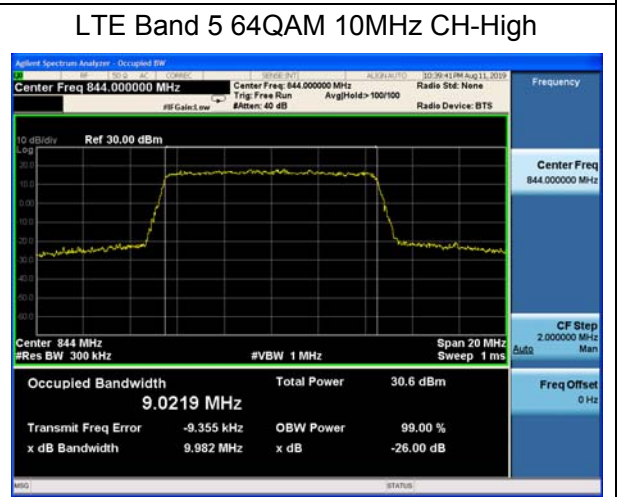
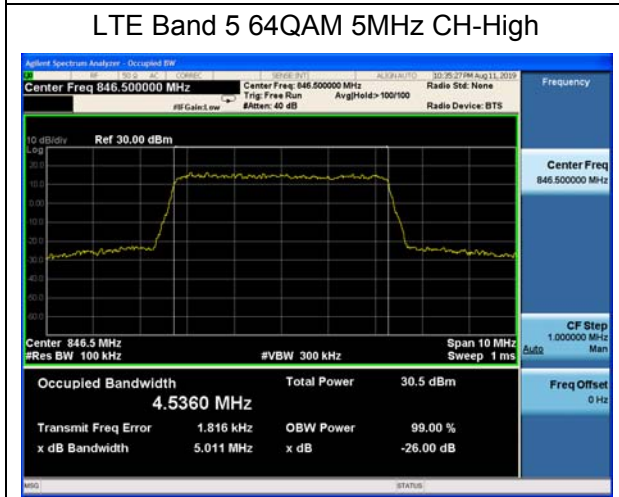
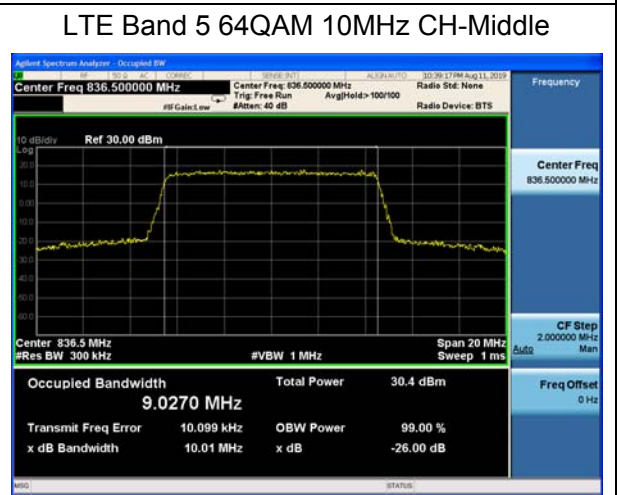
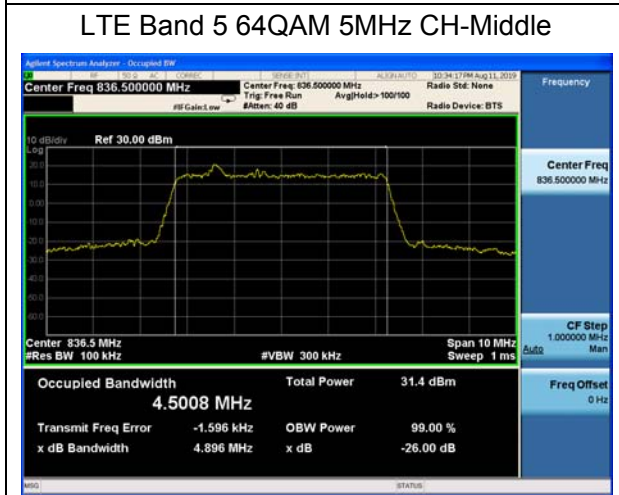
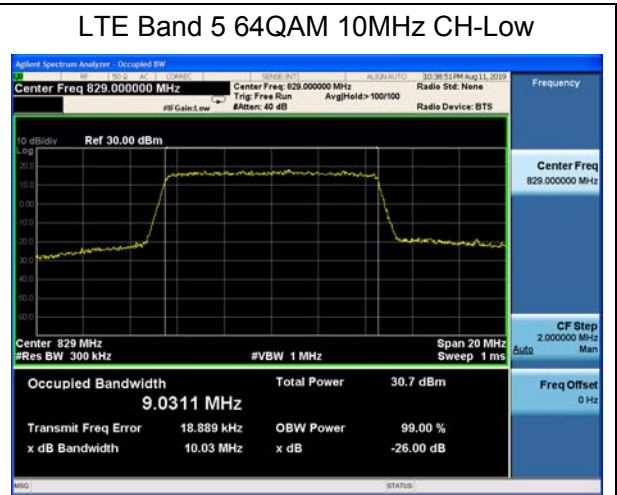
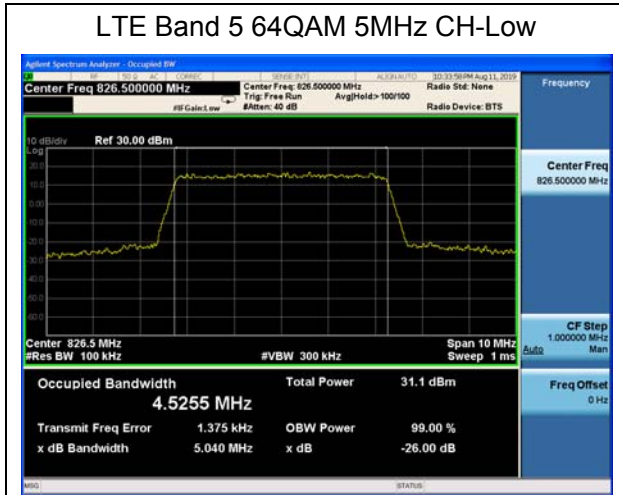

5.4. Band Edge Compliance

Ambient condition

Temperature	Relative humidity	Pressure
23°C ~25°C	45%~50%	101.5kPa

Method of Measurement

The EUT was connected to Spectrum Analyzer and Base Station Simulator via power Splitter. The band edge of the lowest and highest channels were measured. The average detector is used. RBW is set to 3kHz,VBW is set to 10kHz for GSM 850, RBW is set to 51kHz,VBW is set to 160kHz for WCDMA Band V, RBW is set to 15 kHz, VBW is set to 51 kHz for LTE Band 5 (1.4MHz), RBW is set to 30 kHz, VBW is set to 100 kHz for LTE Band 5 (3MHz), RBW is set to 51 kHz, VBW is set to 160 kHz for LTE Band 5 (5MHz), RBW is set to 100 kHz, VBW is set to 300 kHz for LTE Band 5 (10MHz), Spectrum analyzer plots are included on the following pages.

Test Setup

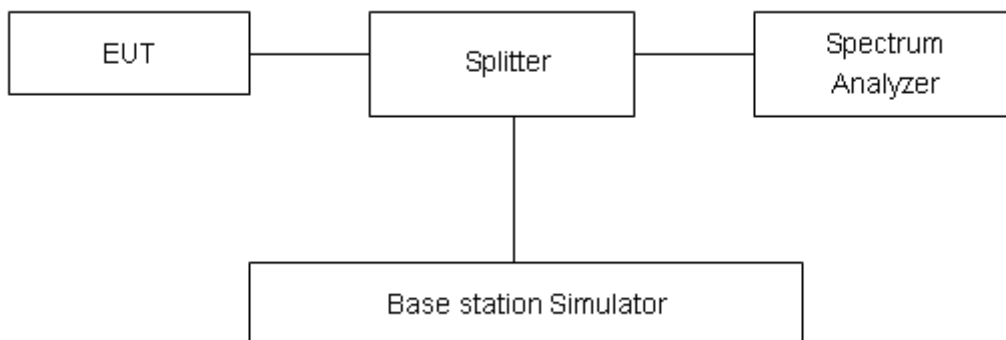

Limits

Rule Part 22.917(a) specifies that “The power of any emission outside of the authorized operating frequency ranges must be attenuated below the transmitting power (P) by a factor of at least 43 + 10 log(P) dB.”

Limit	-13 dBm
-------	---------

Measurement Uncertainty

The assessed measurement uncertainty to ensure 95% confidence level for the normal distribution is with the coverage factor $k = 1.96$, $U=0.684$ dB.



Test Result:

GSM 850 CH-Low



GSM 850 CH-High



GSM 850 GPRS CH-Low



GSM 850 GPRS CH-High



GSM 850 EGPRS CH-Low



GSM 850 EGPRS CH-High





WCDMA Band V CH-Low



WCDMA Band V CH-High



LTE Band 5 QPSK 1.4MHz CH-Low 1RB

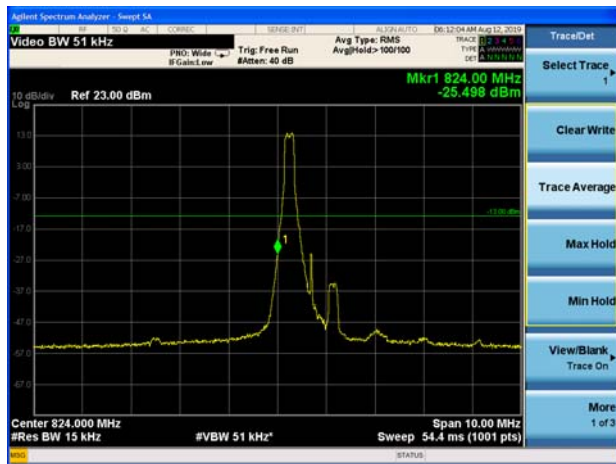

LTE Band 5 QPSK 1.4MHz CH-High 1RB

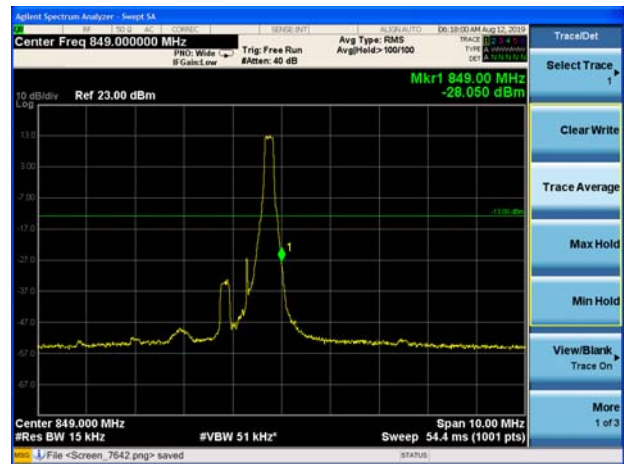

LTE Band 5 QPSK 1.4MHz CH-Low 100%RB

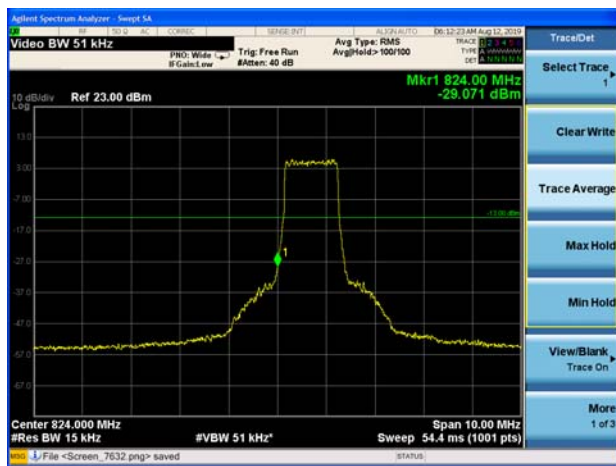

LTE Band 5 QPSK 1.4MHz CH-High 100%RB

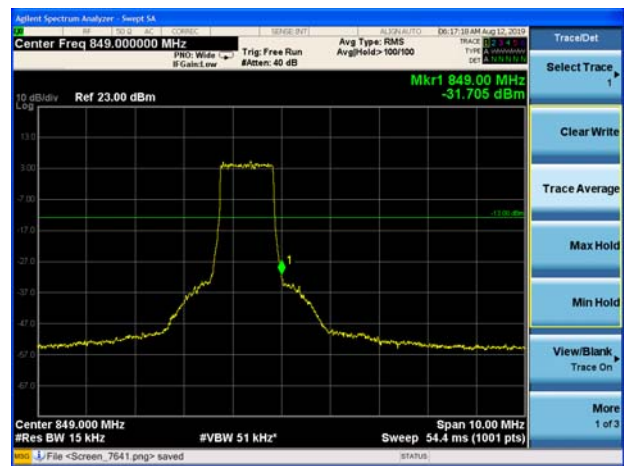

LTE Band 5 QPSK 3MHz CH-Low 1RB

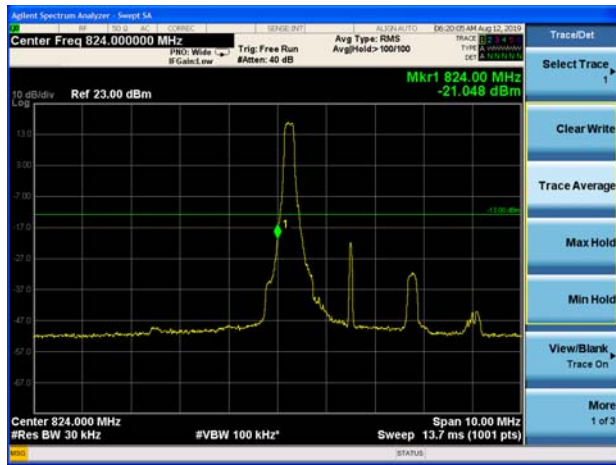

LTE Band 5 QPSK 3MHz CH-High 1RB

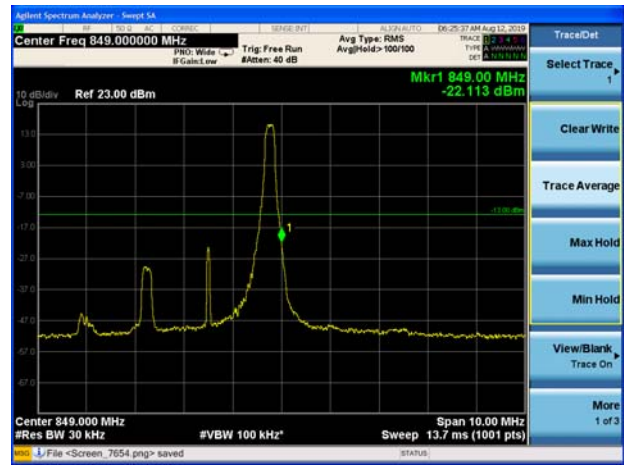

LTE Band 5 QPSK 3MHz CH-Low 100%RB



LTE Band 5 QPSK 3MHz CH-High 100%RB



LTE Band 5 QPSK 5MHz CH-Low 1RB

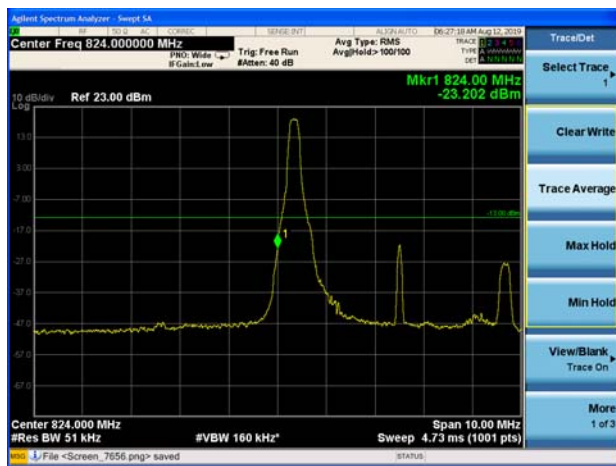

LTE Band 5 QPSK 5MHz CH-High 1RB

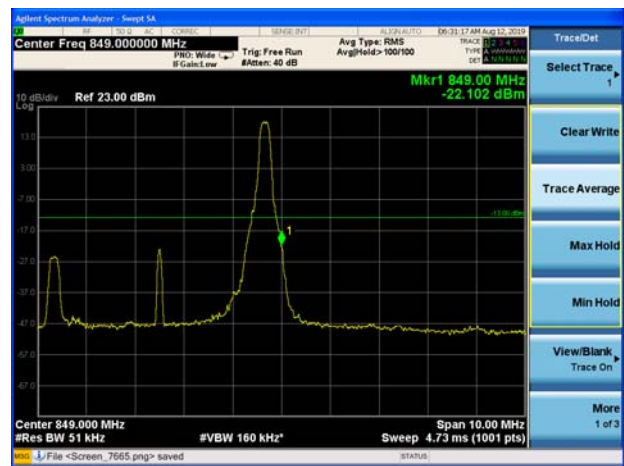



LTE Band 5 QPSK 5MHz CH-Low 100%RB



LTE Band 5 QPSK 5MHz CH-High 100%RB



LTE Band 5 QPSK 10MHz CH-Low 1RB

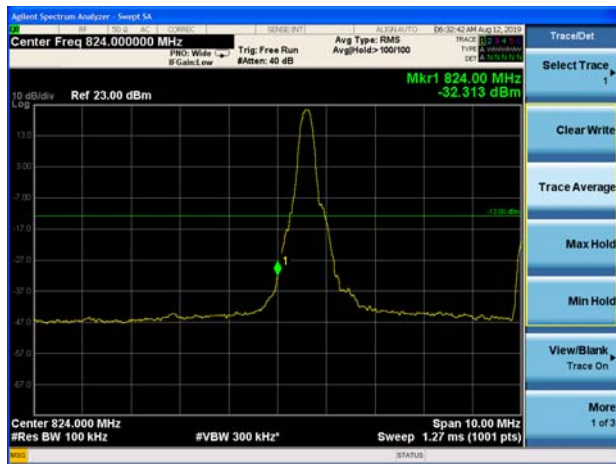

LTE Band 5 QPSK 10MHz CH-High 1RB

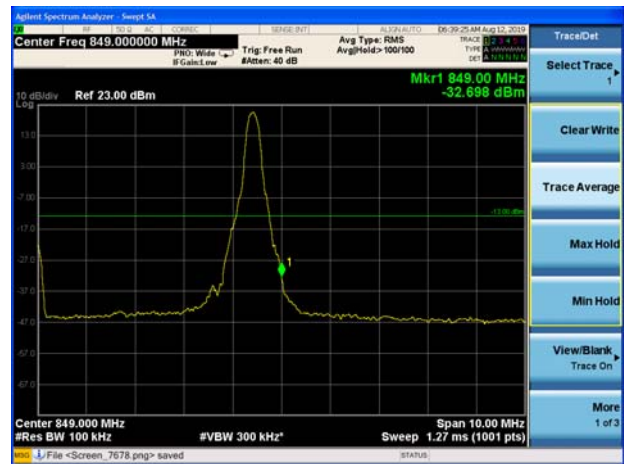

LTE Band 5 QPSK 10MHz CH-Low 100%RB



LTE Band 5 QPSK 10MHz CH-High 100%RB

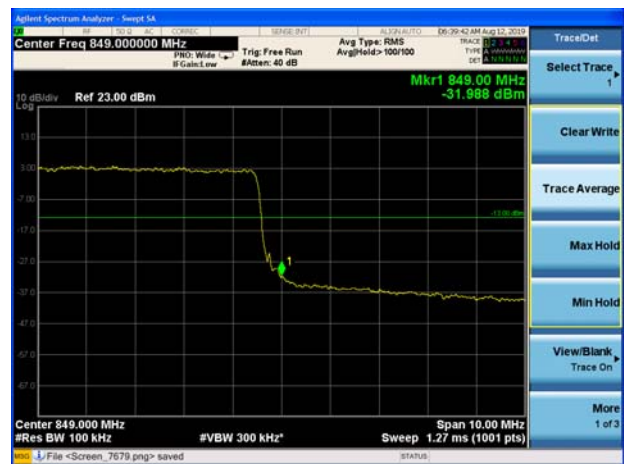



LTE Band 5 16QAM 1.4MHz CH-Low 1RB

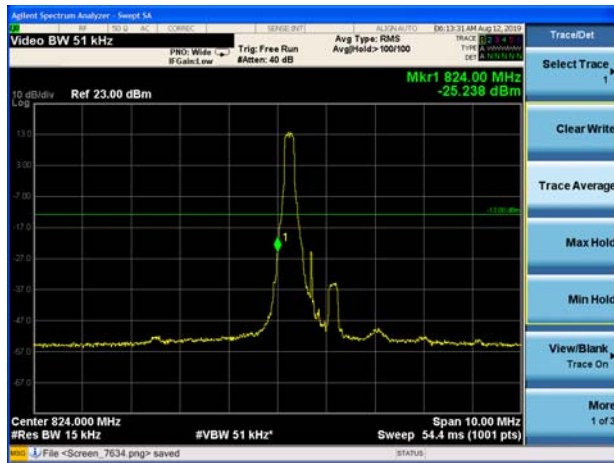

LTE Band 5 16QAM 1.4MHz CH-High 1RB

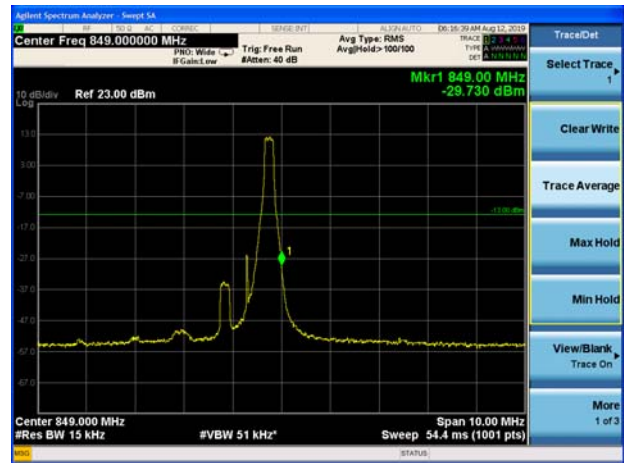

LTE Band 5 16QAM 1.4MHz CH-Low 100%RB

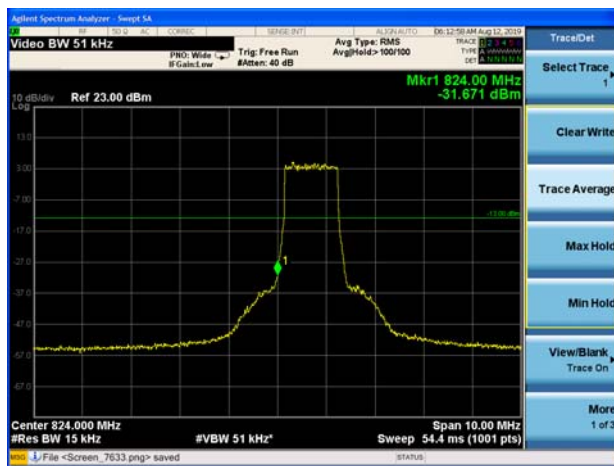

LTE Band 5 16QAM 1.4MHz CH-High 100%RB

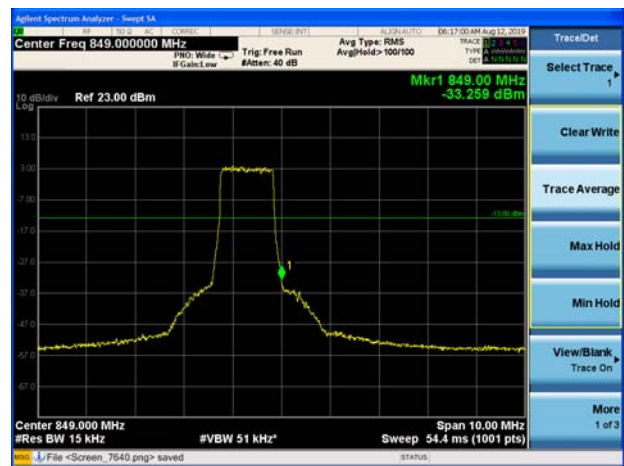

LTE Band 5 16QAM 3MHz CH-Low 1RB

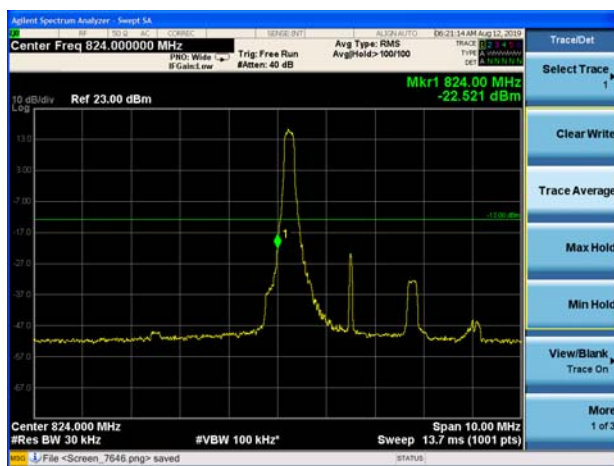

LTE Band 5 16QAM 3MHz CH-High 1RB

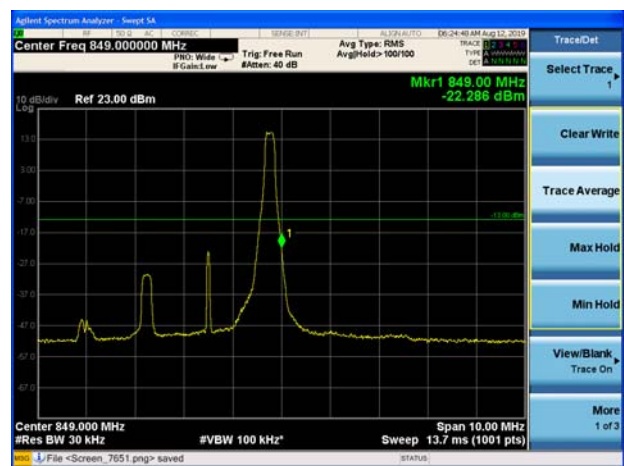



LTE Band 5 16QAM 3MHz CH-Low 100%RB

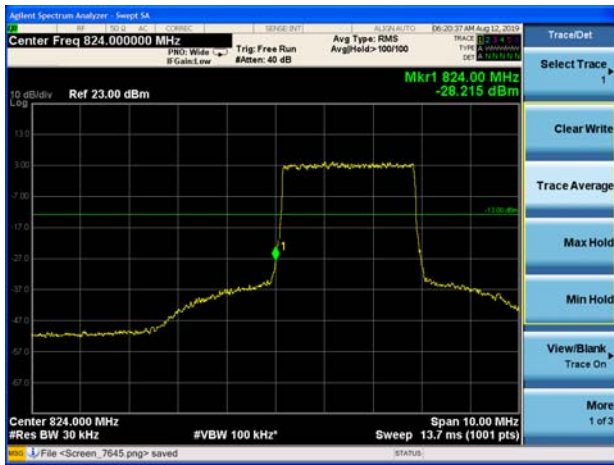

LTE Band 5 16QAM 3MHz CH-High 100%RB



LTE Band 5 16QAM 5MHz CH-Low 1RB

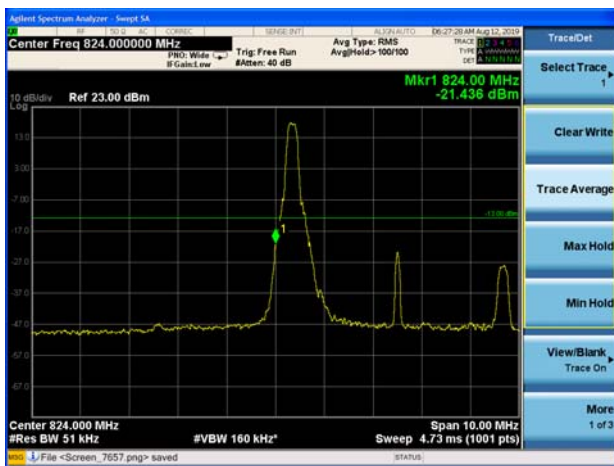

LTE Band 5 16QAM 5MHz CH-High 1RB

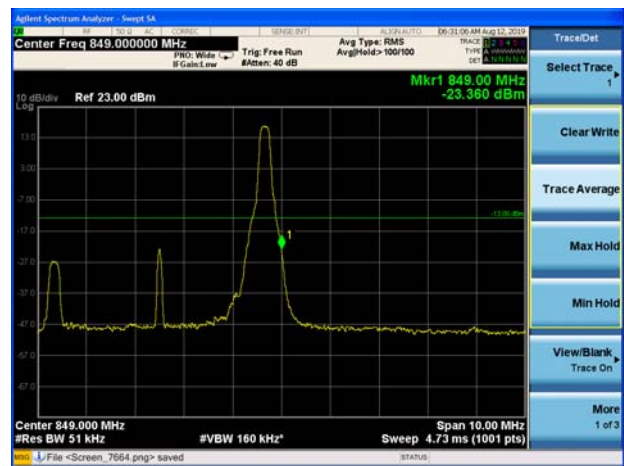

LTE Band 5 16QAM 5MHz CH-Low 100%RB

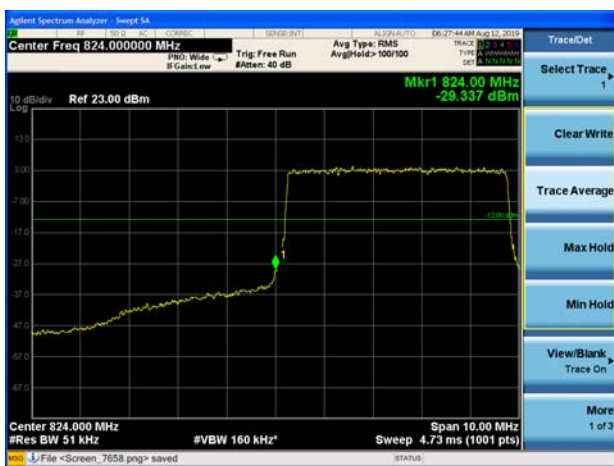

LTE Band 5 16QAM 5MHz CH-High 100%RB





LTE Band 5 16QAM 10MHz CH-Low 1RB

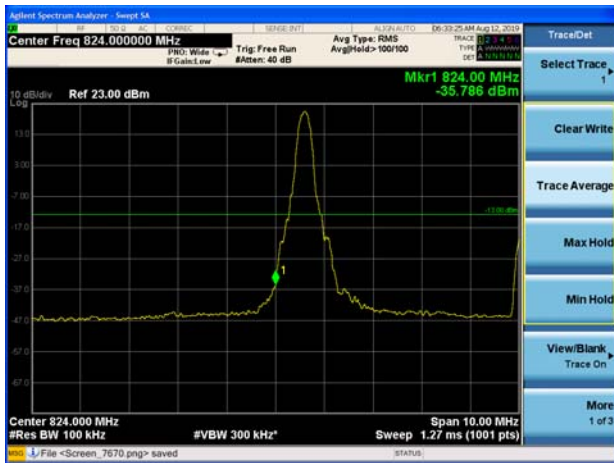

LTE Band 5 16QAM 10MHz CH-High 1RB

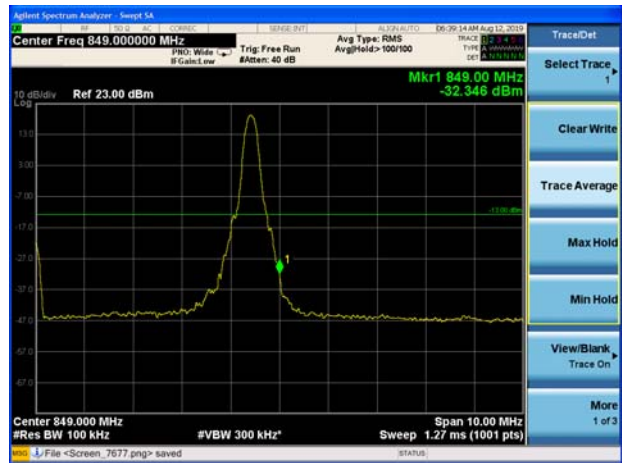

LTE Band 5 16QAM 10MHz CH-Low 100%RB

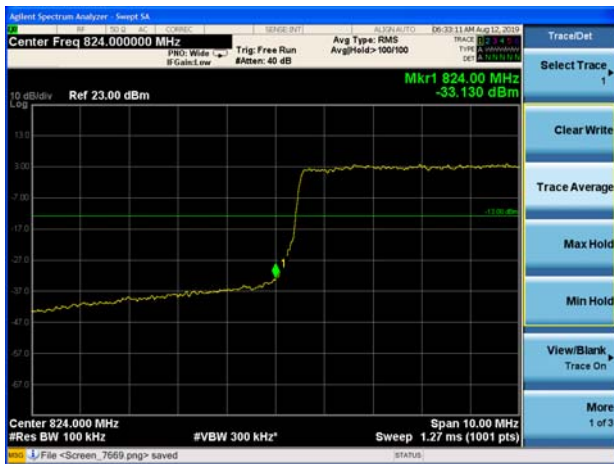

LTE Band 5 16QAM 10MHz CH-High 100%RB

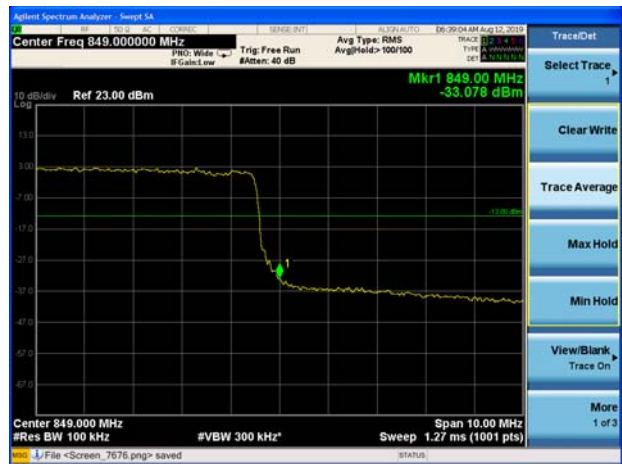

LTE Band 5 QPSK 1.4MHz CH-Low 1RB

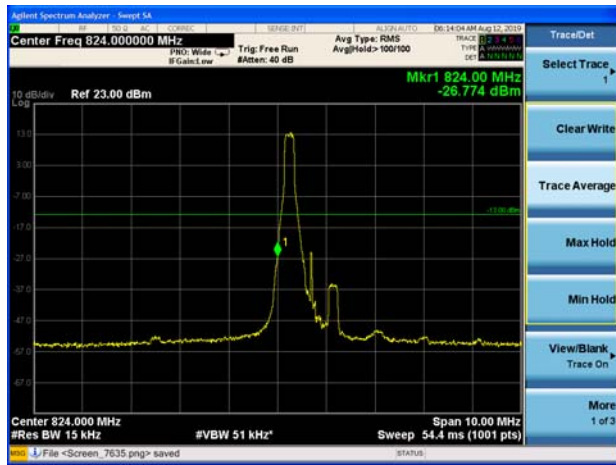

LTE Band 5 QPSK 1.4MHz CH-High 1RB

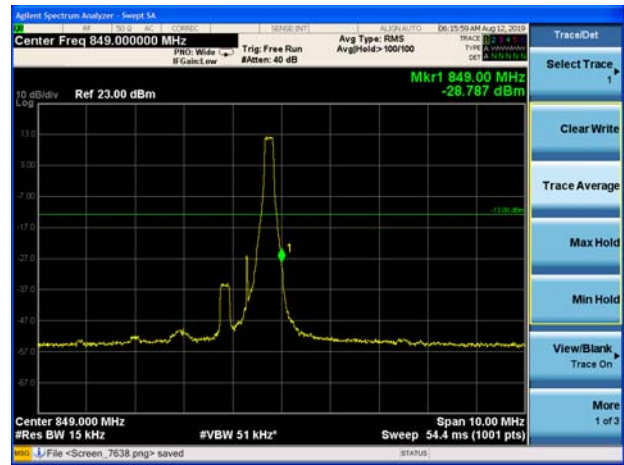

LTE Band 5 QPSK 1.4MHz CH-Low 100%RB

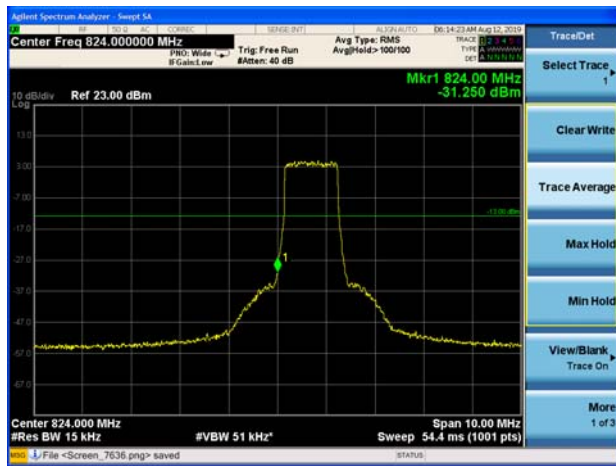

LTE Band 5 QPSK 1.4MHz CH-High 100%RB

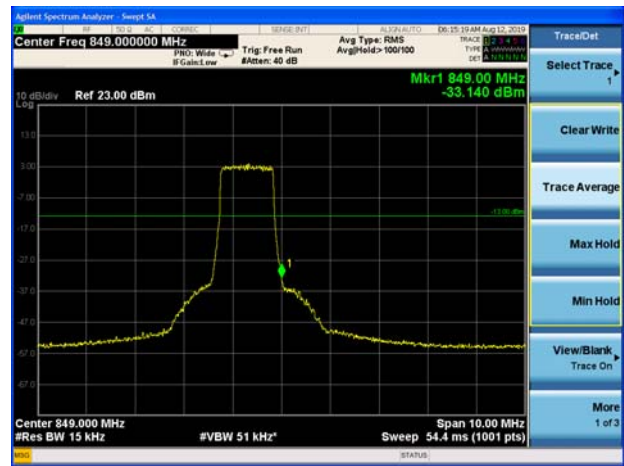

LTE Band 5 64QAM 3MHz CH-Low 1RB

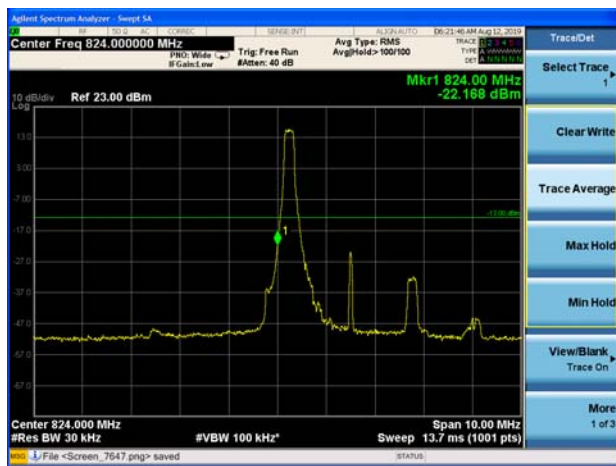

LTE Band 5 64QAM 3MHz CH-High 1RB

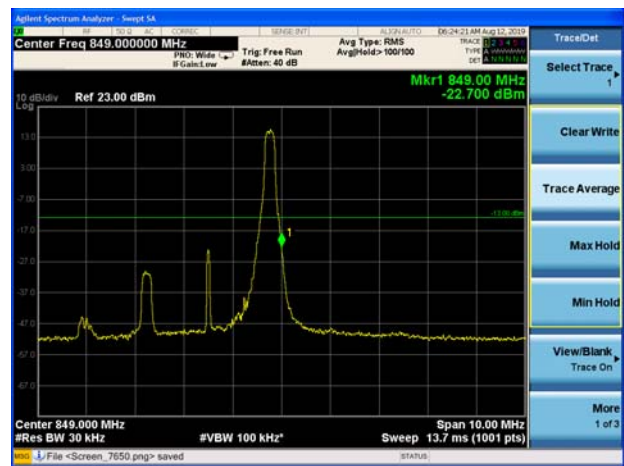



LTE Band 5 64QAM 3MHz CH-Low 100%RB



LTE Band 5 64QAM 3MHz CH-High 100%RB



LTE Band 5 64QAM 5MHz CH-Low 1RB

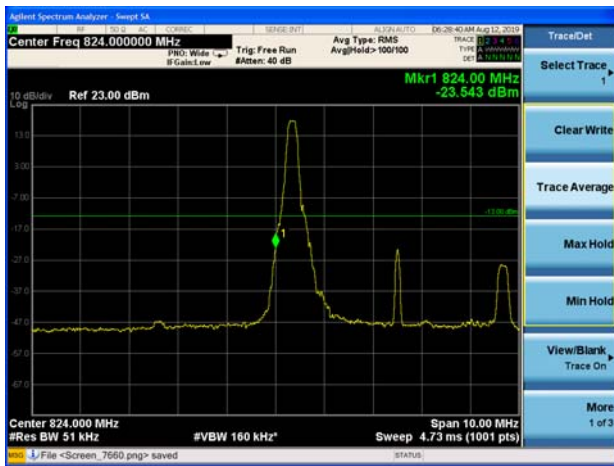

LTE Band 5 64QAM 5MHz CH-High 1RB

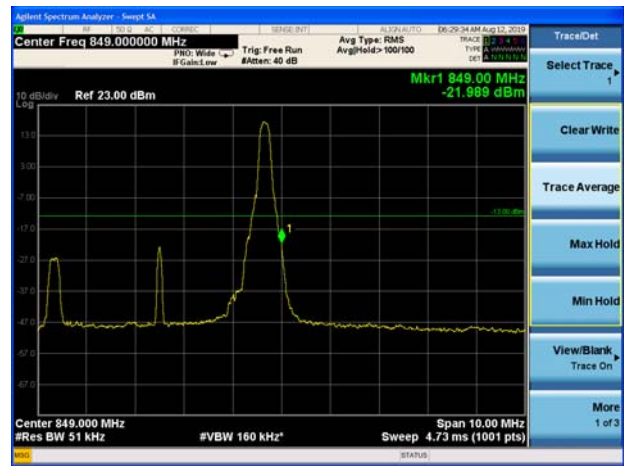



LTE Band 5 64QAM 5MHz CH-Low 100%RB



LTE Band 5 64QAM 5MHz CH-High 100%RB



LTE Band 5 64QAM 10MHz CH-Low 1RB

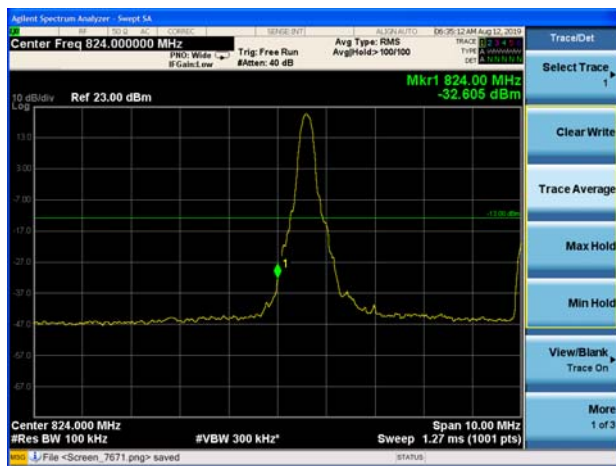

LTE Band 5 64QAM 10MHz CH-High 1RB

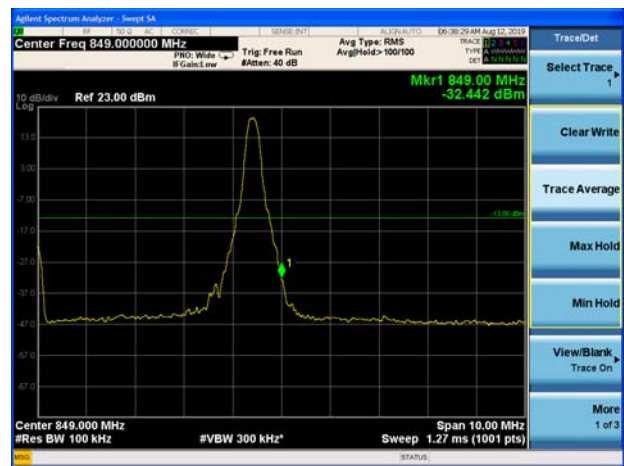

LTE Band 5 64QAM 10MHz CH-Low 100%RB

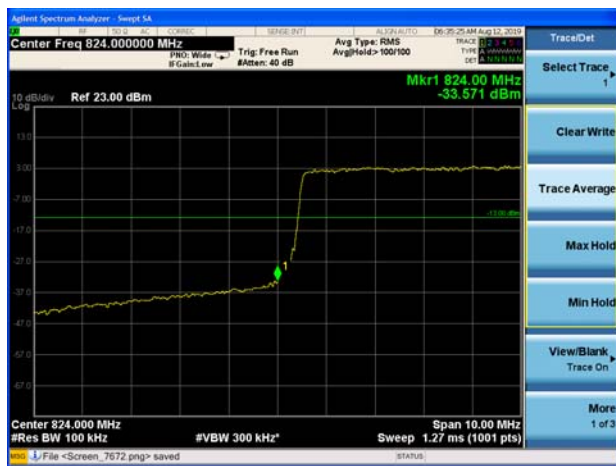

LTE Band 5 64QAM 10MHz CH-High 100%RB

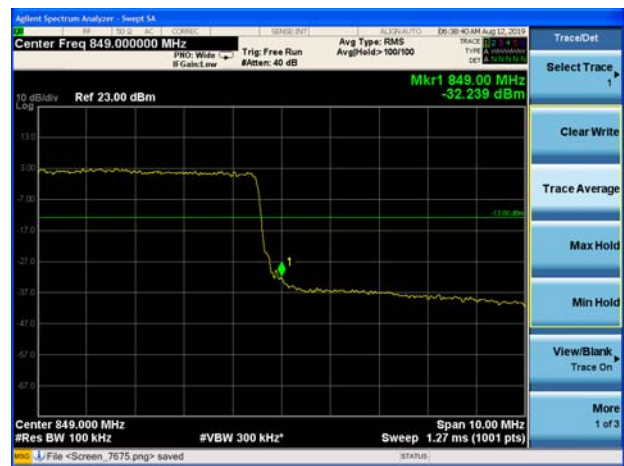

5.5. Peak-to-Average Power Ratio (PAPR)

Ambient condition

Temperature	Relative humidity	Pressure
23°C ~25°C	45%~50%	101.5kPa

Methods of Measurement

Measure the total peak power and record as P_{Pk} . And measure the total average power and record as P_{Avg} . Both the peak and average power levels must be expressed in the same logarithmic units (e.g., dBm). Determine the PAPR from:

$$PAPR (dB) = P_{Pk} (dBm) - P_{Avg} (dBm).$$

Test Setup

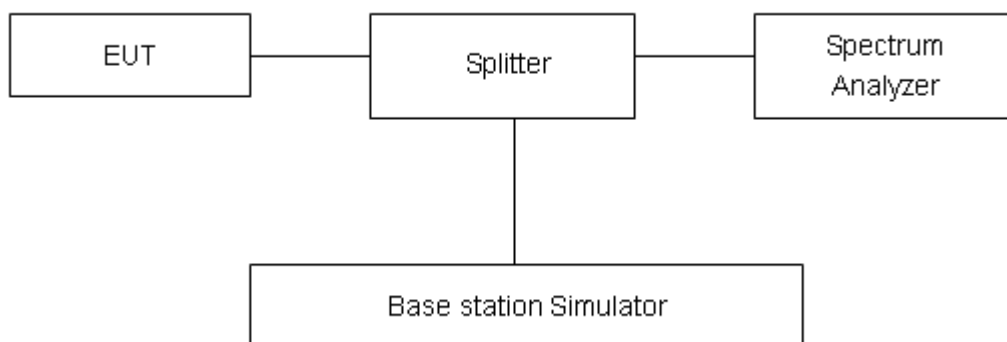

Limits

According to the Sec. 22.913(d), The peak-to-average ratio (PAR) of the transmission must not exceed 13 dB.

Measurement Uncertainty

The assessed measurement uncertainty to ensure 95% confidence level for the normal distribution is with the coverage factor $k = 2$, $U = 0.4$ dB.



Test Results

Mode	Channel	Frequency (MHz)	Peak (dBm)	Avg (dBm)	PAPR (dB)	Limit (dB)	Conclusion
GSM 850 (GSM)	128	824.2	33.85	32.51	1.34	≤13	PASS
	190	836.6	33.96	32.64	1.32	≤13	PASS
	251	848.8	34.01	32.74	1.27	≤13	PASS
GPRS 850 (GMSK)	128	824.2	33.68	32.44	1.24	≤13	PASS
	190	836.6	33.99	32.68	1.31	≤13	PASS
	251	848.8	33.94	32.68	1.26	≤13	PASS
EGPRS 850 (8-PSK)	128	824.2	29.25	26.04	3.21	≤13	PASS
	190	836.6	29.28	26.07	3.21	≤13	PASS
	251	848.8	29.32	26.13	3.19	≤13	PASS
WCDMA Band V (RMC)	4132	826.4	26.56	23.36	3.20	≤13	PASS
	4183	836.6	26.49	23.33	3.16	≤13	PASS
	4233	846.6	26.48	23.40	3.08	≤13	PASS

LTE Band 5								
Modulation	Bandwidth (MHz)	Channel	Frequency (MHz)	Peak (dBm)	Avg (dBm)	PAPR (dB)	Limit (dB)	Conclusion
QPSK	1.4	20407	824.7	28.19	22.91	5.28	≤13	PASS
		20525	836.5	28.09	22.72	5.37	≤13	PASS
		20643	848.3	27.64	22.35	5.29	≤13	PASS
	3	20415	825.5	28.33	23.00	5.33	≤13	PASS
		20525	836.5	28.11	22.70	5.41	≤13	PASS
		20635	847.5	27.80	22.43	5.37	≤13	PASS
	5	20425	826.5	28.21	22.88	5.33	≤13	PASS
		20525	836.5	28.13	22.70	5.43	≤13	PASS
		20625	846.5	27.79	22.47	5.32	≤13	PASS
	10	20450	829	28.23	22.93	5.30	≤13	PASS
		20525	836.5	45.10	22.75	22.35	≤13	PASS
		20600	844	27.67	22.41	5.26	≤13	PASS
16QAM	1.4	20407	824.7	27.97	21.98	5.99	≤13	PASS
		20525	836.5	28.14	21.92	6.22	≤13	PASS
		20643	848.3	27.70	21.54	6.16	≤13	PASS
	3	20415	825.5	28.06	21.87	6.19	≤13	PASS
		20525	836.5	27.97	21.67	6.30	≤13	PASS
		20635	847.5	27.66	21.46	6.20	≤13	PASS



	5	20425	826.5	27.99	21.86	6.13	≤13	PASS
		20525	836.5	27.93	21.70	6.23	≤13	PASS
		20625	846.5	27.57	21.44	6.13	≤13	PASS
	10	20450	829	28.01	22.04	5.97	≤13	PASS
		20525	836.5	27.94	21.76	6.18	≤13	PASS
		20600	844	27.46	21.36	6.10	≤13	PASS
64QAM	1.4	20407	824.7	27.76	21.63	6.13	≤13	PASS
		20525	836.5	28.11	21.89	6.22	≤13	PASS
		20643	848.3	27.83	21.68	6.15	≤13	PASS
	3	20415	825.5	28.05	22.72	5.33	≤13	PASS
		20525	836.5	28.08	22.67	5.41	≤13	PASS
		20635	847.5	27.98	22.61	5.37	≤13	PASS
	5	20425	826.5	27.80	21.67	6.13	≤13	PASS
		20525	836.5	28.07	21.86	6.21	≤13	PASS
		20625	846.5	27.87	21.74	6.13	≤13	PASS
	10	20450	829	27.83	21.72	6.11	≤13	PASS
		20525	836.5	27.98	21.79	6.19	≤13	PASS
		20600	844	27.72	21.61	6.11	≤13	PASS

5.6. Frequency Stability

Ambient condition

Temperature	Relative humidity	Pressure
23°C ~25°C	45%~50%	101.5kPa

Method of Measurement

Frequency Stability (Temperature Variation)

The temperature inside the climate chamber is varied from -30°C to +55°C in 10°C step size,

(1) With all power removed, the temperature was decreased to 0°C and permitted to stabilize for three hours.

(2) Measure the carrier frequency with the test equipment in a “call mode”. These measurements should be made within 1 minute of powering up the mobile station, to prevent significant self warming.

(3) Repeat the above measurements at 10°C increments from -30°C to +55°C. Allow at least 1.5 hours at each temperature, un-powered, before making measurements.

Frequency Stability (Voltage Variation)

The frequency stability shall be measured with variation of primary supply voltage as follows:

(1) Vary primary supply voltage from 85 to 115 percent of the nominal value for other than hand carried battery equipment.

(2) For hand carried, battery powered equipment, reduce primary supply voltage to the battery-operating end point which shall be specified by the manufacturer.

This transceiver is specified to operate with an input voltage of between 3.4 V and 4.4 V, with a nominal voltage of 3.85V.

Test setup

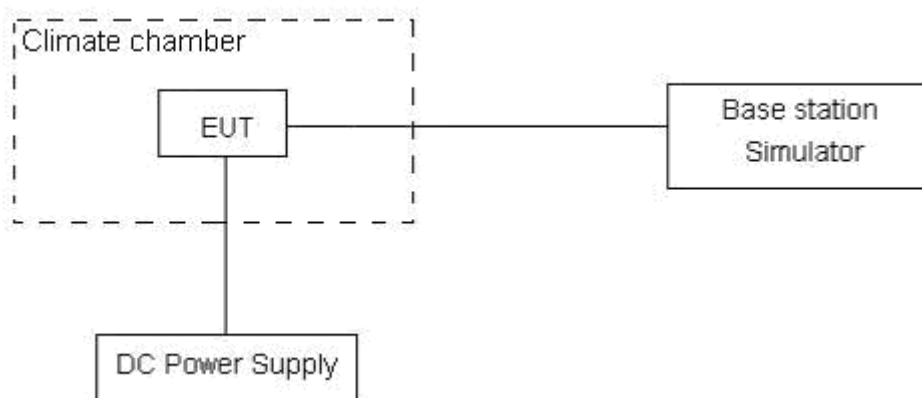

**Limits**

According to the Sec. 22.355, the frequency stability of the carrier shall be accurate to within 2.5 ppm of the received frequency for mobile stations.

Limits	≤ 2.5 ppm
--------	----------------

Measurement Uncertainty

The assessed measurement uncertainty to ensure 99.75% confidence level for the normal distribution is with the coverage factor $k = 3$, $U = 0.01$ ppm.

Test Result

GSM850						
Condition		Freq.Error (Hz)	Freq.Error (Hz)	Frequency Stability (ppm)	Frequency Stability (ppm)	Verdict
Temperature	Voltage	GMSK	8PSK	GMSK	8PSK	
Normal (25°C)	Normal	7.69	7.28	0.00409	0.00387	PASS
Extreme (55°C)		8.53	6.91	0.00454	0.00368	PASS
Extreme (50°C)		7.36	15.20	0.00391	0.00809	PASS
Extreme (40°C)		16.58	11.92	0.00882	0.00634	PASS
Extreme (30°C)		4.08	8.96	0.00217	0.00477	PASS
Extreme (20°C)		12.75	16.98	0.00678	0.00903	PASS
Extreme (10°C)		9.38	1.19	0.00499	0.00063	PASS
Extreme (0°C)		10.24	12.78	0.00545	0.00680	PASS
Extreme (-10°C)		13.93	12.37	0.00741	0.00658	PASS
Extreme (-20°C)		5.15	3.64	0.00274	0.00194	PASS
Extreme (-30°C)		12.72	2.82	0.00676	0.00150	PASS
25°C		LV	8.66	13.88	0.00461	0.00738
	HV	7.87	2.32	0.00419	0.00123	PASS

WCDMA Band 5						
Condition		Freq.Error (Hz)	Freq.Error (Hz)	Frequency Stability (ppm)	Frequency Stability (ppm)	Verdict
Temperature	Voltage	QPSK	BPSK	QPSK	BPSK	
Normal (25°C)	Normal	9.47	12.52	0.00504	0.00666	PASS
Extreme (55°C)		2.86	1.84	0.00152	0.00098	PASS
Extreme (50°C)		15.11	3.02	0.00804	0.00161	PASS
Extreme (40°C)		5.98	13.60	0.00318	0.00724	PASS
Extreme (30°C)		17.32	17.22	0.00921	0.00916	PASS
Extreme (20°C)		14.28	11.72	0.00760	0.00624	PASS
Extreme (10°C)		6.85	11.29	0.00364	0.00600	PASS
Extreme (0°C)		7.43	15.50	0.00395	0.00824	PASS
Extreme (-10°C)		9.33	7.77	0.00496	0.00413	PASS
Extreme (-20°C)		17.56	12.68	0.00934	0.00674	PASS
Extreme (-30°C)		15.76	5.50	0.00838	0.00293	PASS
25°C		LV	13.76	4.27	0.00732	0.00227
	HV	9.16	4.21	0.00487	0.00224	PASS



LTE Band 5								
Condition		Freq.Error (Hz)	Freq.Error (Hz)	Freq.Error (Hz)	Frequency Stability (ppm)	Frequency Stability (ppm)	Frequency Stability (ppm)	Verdict
BANDWIDTH	1.4MHz							
Temperature	Voltage	64QAM	16QAM	QPSK	64QAM	16QAM	QPSK	
Normal (25°C)	Normal	8.63	9.63	15.13	0.00459	0.00512	0.00805	PASS
Extreme (55°C)		13.14	5.14	9.52	0.00699	0.00273	0.00507	PASS
Extreme (50°C)		9.34	14.34	12.63	0.00497	0.00763	0.00672	PASS
Extreme (40°C)		12.86	5.86	16.18	0.00684	0.00311	0.00861	PASS
Extreme (30°C)		5.32	8.32	5.72	0.00283	0.00443	0.00304	PASS
Extreme (20°C)		9.89	16.89	9.74	0.00526	0.00899	0.00518	PASS
Extreme (10°C)		4.04	17.04	14.46	0.00215	0.00906	0.00769	PASS
Extreme (0°C)		6.56	15.56	5.45	0.00349	0.00828	0.00290	PASS
Extreme (-10°C)		12.54	1.54	11.34	0.00667	0.00082	0.00603	PASS
Extreme (-20°C)		16.48	14.48	4.97	0.00877	0.00770	0.00264	PASS
Extreme (-30°C)		13.54	4.54	1.66	0.00720	0.00242	0.00088	PASS
25°C	LV	10.99	17.99	2.82	0.00585	0.00957	0.00150	PASS
	HV	13.34	16.34	5.46	0.00710	0.00869	0.00290	PASS
Condition		Freq.Error (Hz)	Freq.Error (Hz)	Freq.Error (Hz)	Frequency Stability (ppm)	Frequency Stability (ppm)	Frequency Stability (ppm)	Verdict
BANDWIDTH	3MHz							
Temperature	Voltage	64QAM	16QAM	QPSK	64QAM	16QAM	QPSK	
Normal (25°C)	Normal	13.04	3.04	14.29	0.00694	0.00162	0.00760	PASS
Extreme (55°C)		7.93	17.93	2.04	0.00422	0.00954	0.00108	PASS
Extreme (50°C)		6.36	9.36	5.86	0.00338	0.00498	0.00312	PASS
Extreme (40°C)		4.74	7.74	16.64	0.00252	0.00411	0.00885	PASS
Extreme (30°C)		1.65	2.65	5.61	0.00088	0.00141	0.00299	PASS
Extreme (20°C)		15.71	3.71	8.02	0.00836	0.00197	0.00426	PASS
Extreme (10°C)		9.30	7.30	4.59	0.00495	0.00388	0.00244	PASS
Extreme (0°C)		13.28	11.28	4.80	0.00707	0.00600	0.00255	PASS
Extreme (-10°C)		1.84	1.84	3.32	0.00098	0.00098	0.00177	PASS
Extreme (-20°C)		8.43	14.43	17.33	0.00448	0.00767	0.00922	PASS
Extreme (-30°C)		12.55	14.55	10.73	0.00667	0.00774	0.00571	PASS
25°C	LV	2.72	14.72	7.90	0.00145	0.00783	0.00420	PASS
	HV	6.17	13.17	17.44	0.00328	0.00700	0.00928	PASS
Condition		Freq.Error (Hz)	Freq.Error (Hz)	Freq.Error (Hz)	Frequency Stability (ppm)	Frequency Stability (ppm)	Frequency Stability (ppm)	Verdict
BANDWIDTH	5MHz							
Temperature	Voltage	64QAM	16QAM	QPSK	64QAM	16QAM	QPSK	
Normal (25°C)	Normal	10.43	11.43	5.61	0.00555	0.00608	0.00299	PASS
Extreme (55°C)		11.30	11.30	10.94	0.00601	0.00601	0.00582	PASS



Extreme (50°C)		17.07	10.07	9.60	0.00908	0.00536	0.00511	PASS
Extreme (40°C)		6.94	3.94	7.64	0.00369	0.00210	0.00406	PASS
Extreme (30°C)		12.21	5.21	14.89	0.00650	0.00277	0.00792	PASS
Extreme (20°C)		15.42	15.42	1.26	0.00820	0.00820	0.00067	PASS
Extreme (10°C)		1.69	5.69	16.42	0.00090	0.00303	0.00873	PASS
Extreme (0°C)		12.27	5.27	8.20	0.00653	0.00280	0.00436	PASS
Extreme (-10°C)		9.53	1.53	15.04	0.00507	0.00081	0.00800	PASS
Extreme (-20°C)		16.62	11.62	13.63	0.00884	0.00618	0.00725	PASS
Extreme (-30°C)		15.82	14.82	11.26	0.00841	0.00788	0.00599	PASS
25°C	LV	13.63	8.63	6.14	0.00725	0.00459	0.00327	PASS
	HV	13.66	12.66	5.51	0.00727	0.00673	0.00293	PASS
Condition		Freq.Error (Hz)	Freq.Error (Hz)	Freq.Error (Hz)	Frequency Stability (ppm)	Frequency Stability (ppm)	Frequency Stability (ppm)	Verdict
BANDWIDTH	10MHz							
Temperature	Voltage	64QAM	16QAM	QPSK	64QAM	16QAM	QPSK	
Normal (25°C)	Normal	15.50	7.50	7.20	0.00825	0.00399	0.00383	PASS
Extreme (55°C)		1.81	6.81	15.46	0.00096	0.00362	0.00822	PASS
Extreme (50°C)		6.97	2.97	14.80	0.00371	0.00158	0.00787	PASS
Extreme (40°C)		8.36	2.36	13.46	0.00445	0.00125	0.00716	PASS
Extreme (30°C)		2.73	13.73	11.73	0.00145	0.00730	0.00624	PASS
Extreme (20°C)		1.20	6.20	15.07	0.00064	0.00330	0.00802	PASS
Extreme (10°C)		7.08	17.08	14.79	0.00377	0.00909	0.00787	PASS
Extreme (0°C)		8.88	11.88	3.43	0.00473	0.00632	0.00182	PASS
Extreme (-10°C)		17.00	17.00	12.91	0.00904	0.00904	0.00687	PASS
Extreme (-20°C)		4.89	17.89	13.50	0.00260	0.00951	0.00718	PASS
Extreme (-30°C)		7.01	3.01	15.39	0.00373	0.00160	0.00818	PASS
25°C		LV	1.54	10.54	7.46	0.00082	0.00561	0.00397
	HV	8.01	16.01	5.34	0.00426	0.00852	0.00284	PASS

5.7. Spurious Emissions at Antenna Terminals

Ambient condition

Temperature	Relative humidity	Pressure
23°C ~25°C	45%~50%	101.5kPa

Method of Measurement

The EUT was connected to Spectrum Analyzer and Base Station Simulator via power Splitter. The measurement is carried out using a spectrum analyzer. The spectrum analyzer scans from 9kHz to the 10th harmonic of the carrier.

The peak detector is used. RBW are set to 100 kHz and VBW are set to 300 kHz for below 1G, RBW are set to 1MHz and VBW are set to 3MHz for above 1G, Sweep is set to ATUO.

The modulation mode and RB allocation refer to section 5.1, using the maximum output power configuration.

Test setup

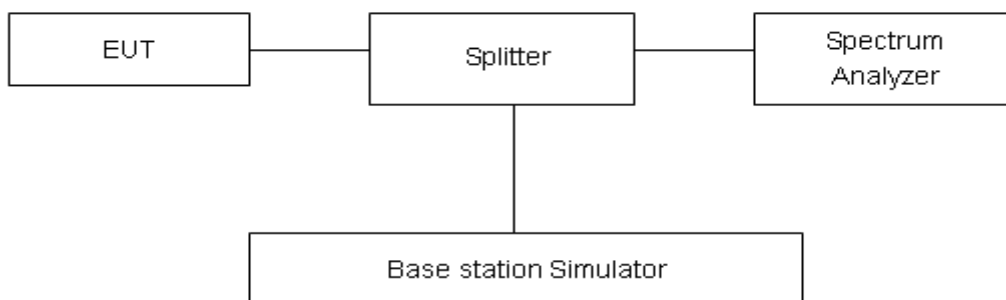

Limits

Rule Part 22.917(a) specifies that “The power of any emission outside of the authorized operating frequency ranges must be attenuated below the transmitting power (P) by a factor of at least 43 + 10 log (P) dB.”

Limit	-13 dBm
-------	---------

Measurement Uncertainty

The assessed measurement uncertainty to ensure 99.75% confidence level for the normal distribution is with the coverage factor $k = 1.96$.

Frequency	Uncertainty
9kHz-1GHz	0.684 dB
1GHz-18GHz	1.407 dB



Test Result

Sweep the whole frequency band through the range from 9kHz to the 10th harmonic of the carrier, the emissions more than 20 dB below the limit are not reported.

The signal beyond the limit is carrier.

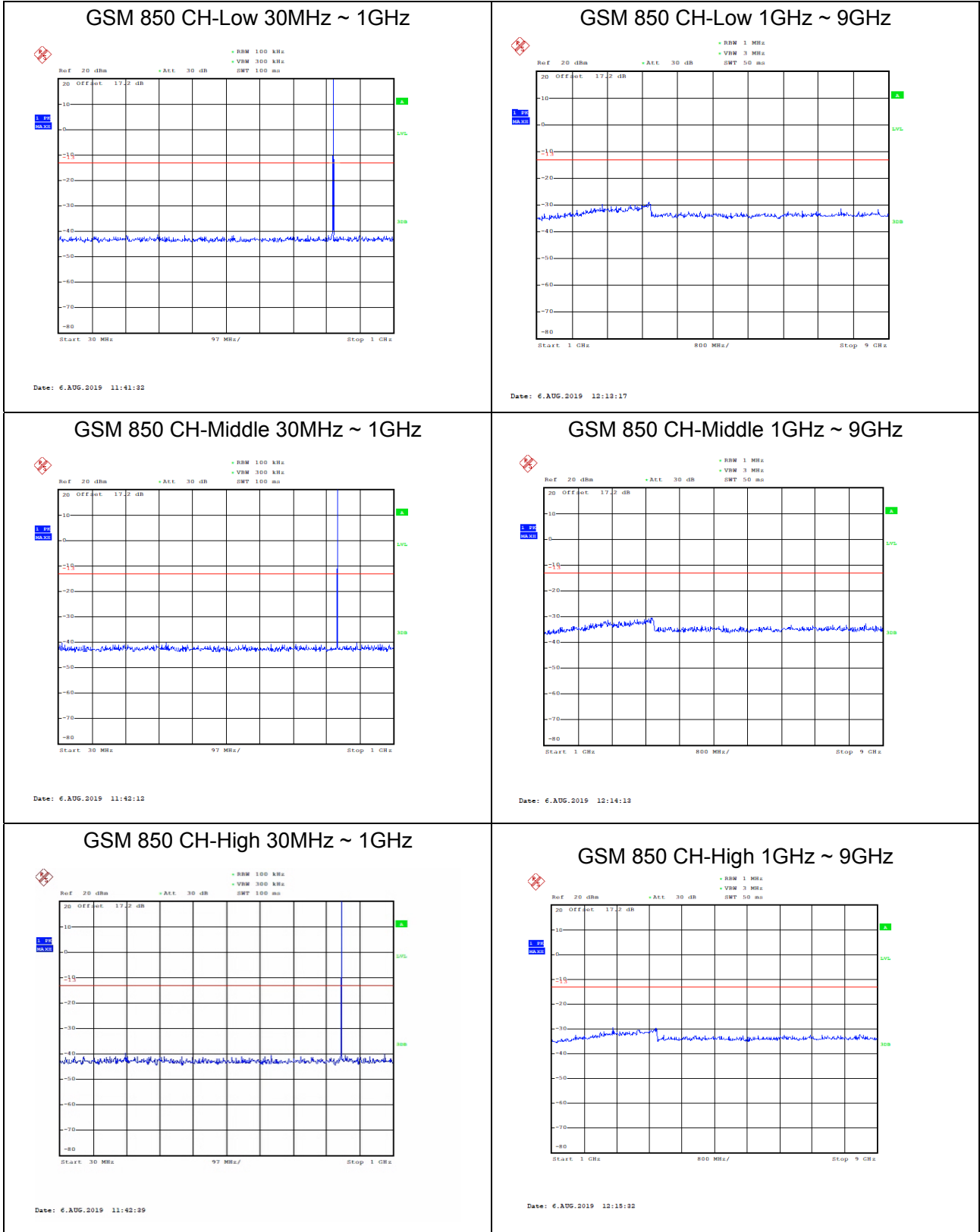



GPRS 850 CH-Low 30MHz ~ 1GHz

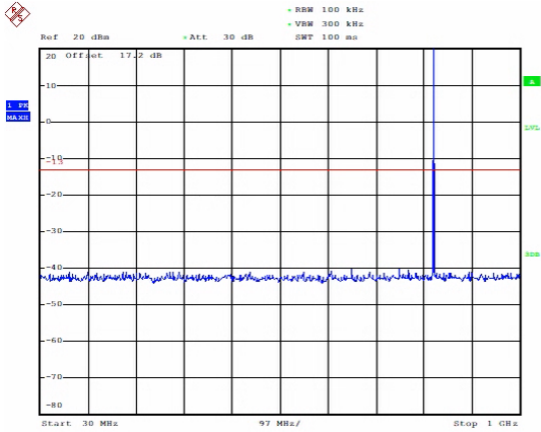

Date: 6.AUG.2019 11:49:41

GPRS 850 CH-Low 1GHz ~ 9GHz

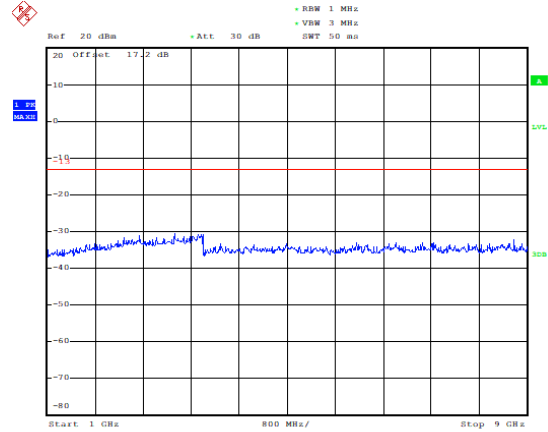

Date: 6.AUG.2019 12:28:51

GPRS 850 CH-Middle 30MHz ~ 1GHz

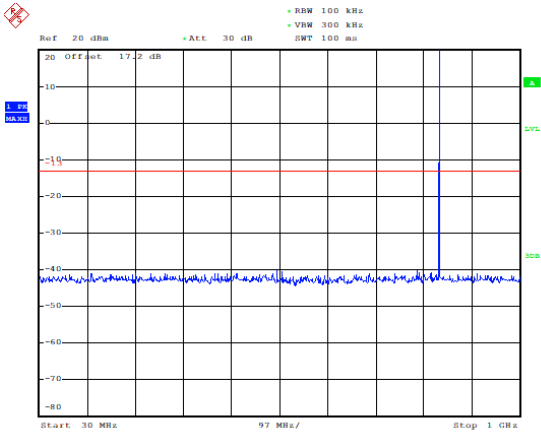

Date: 6.AUG.2019 11:50:11

GPRS 850 CH-Middle 1GHz ~ 9GHz

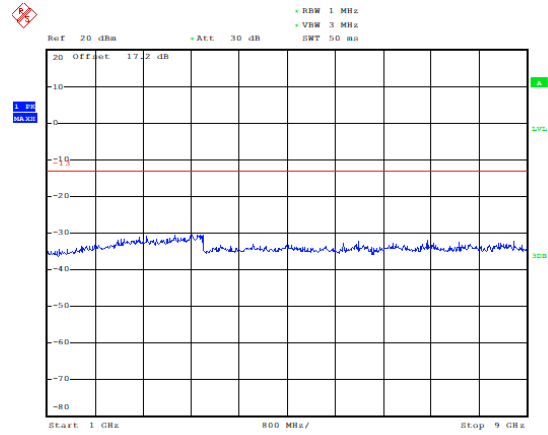

Date: 6.AUG.2019 12:24:12

GPRS 850 CH-High 30MHz ~ 1GHz

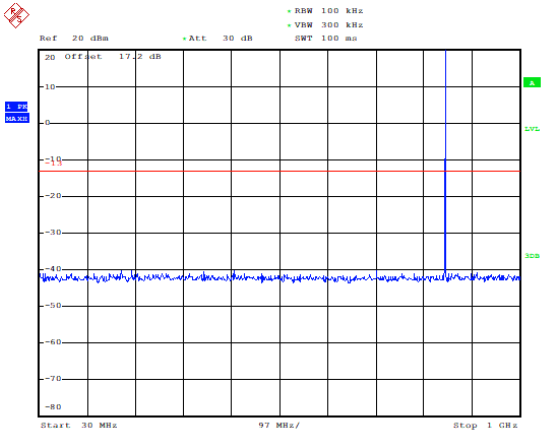

Date: 6.AUG.2019 11:50:54

GPRS 850 CH-High 1GHz ~ 9GHz

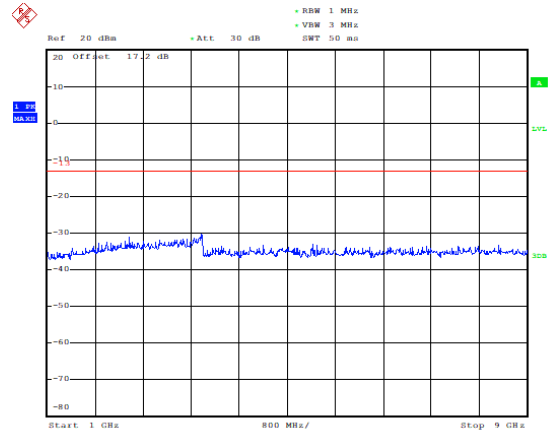

Date: 6.AUG.2019 12:25:21



EGPRS 850 CH-Low 30MHz ~ 1GHz

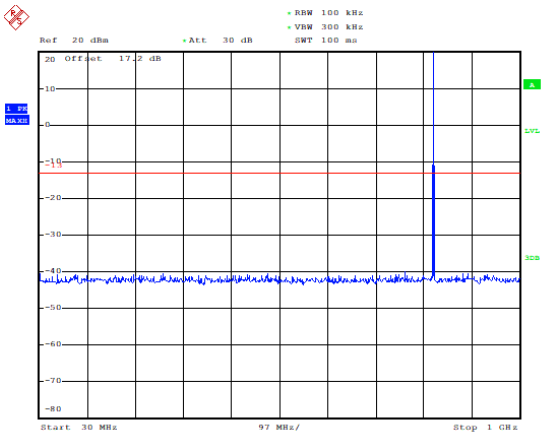

Date: 6.AUG.2019 11:59:11

EGPRS 850 CH-Low 1GHz ~ 9GHz

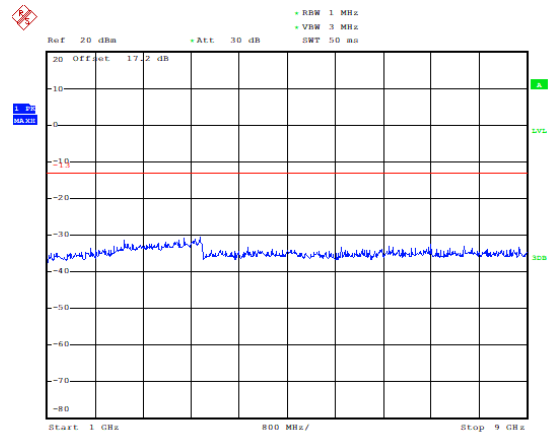

Date: 6.AUG.2019 12:28:05

EGPRS 850 CH-Middle 30MHz ~ 1GHz

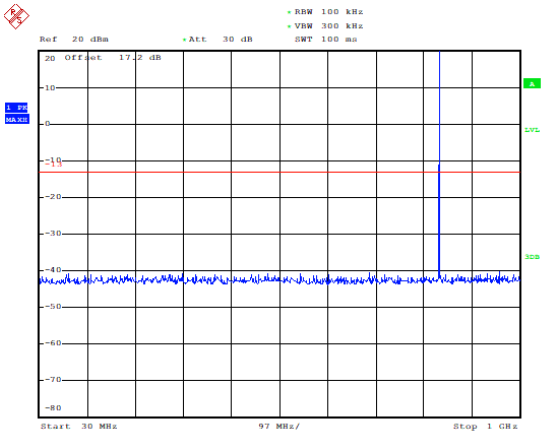

Date: 6.AUG.2019 11:59:55

EGPRS 850 CH-Middle 1GHz ~ 9GHz

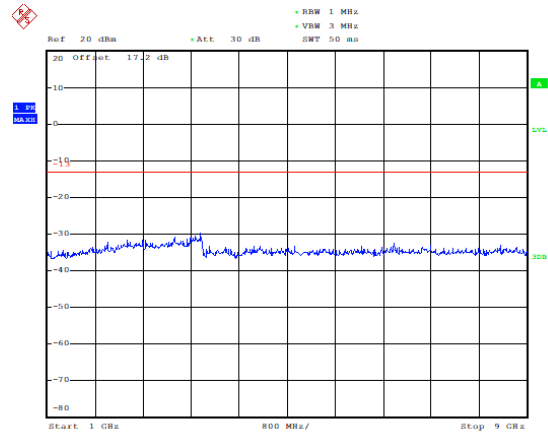

Date: 6.AUG.2019 12:32:21

EGPRS 850 CH-High 30MHz ~ 1GHz

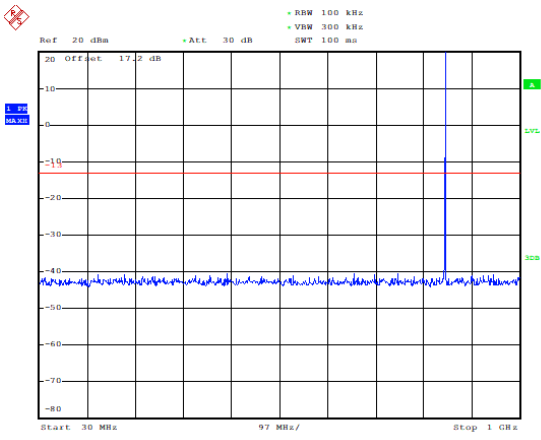

Date: 6.AUG.2019 12:01:23

EGPRS 850 CH-High 1GHz ~ 9GHz

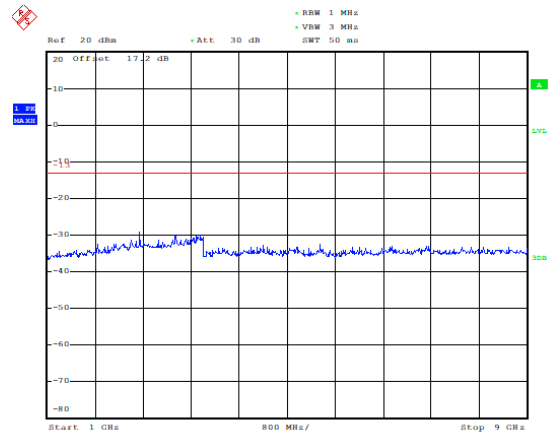

Date: 6.AUG.2019 12:34:15



WCDMA Band V CH-Low 30MHz ~ 1GHz

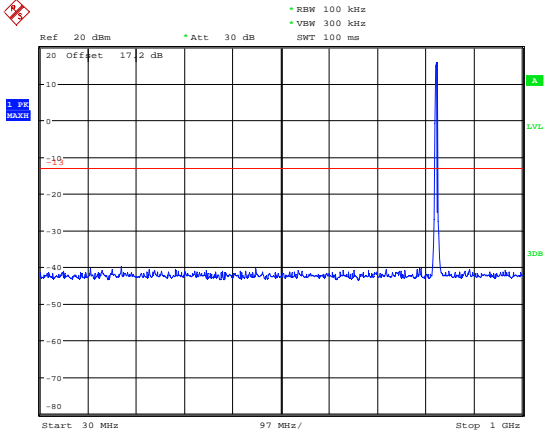

Date: 6.AUG.2019 16:17:51

WCDMA Band V CH-Low 1GHz ~ 9GHz

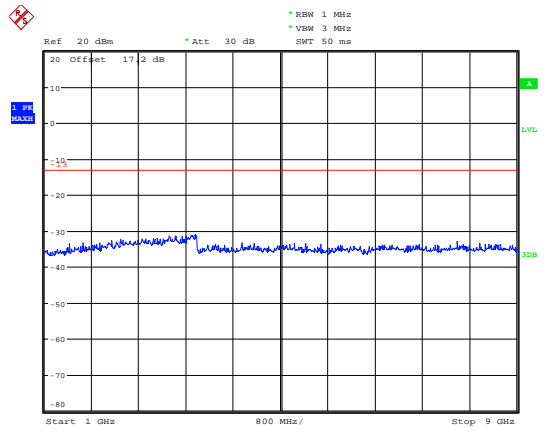

Date: 6.AUG.2019 16:37:12

WCDMA Band V CH-Middle 30MHz ~ 1GHz

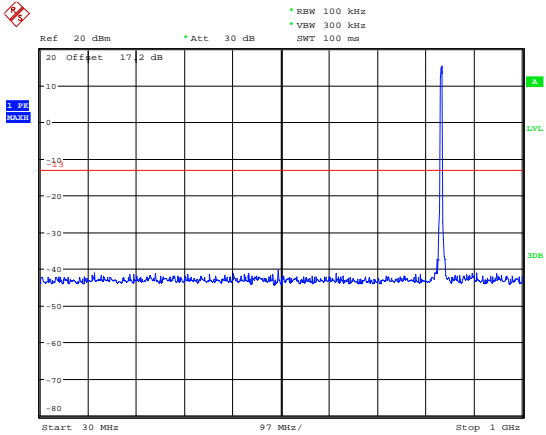

Date: 6.AUG.2019 16:18:27

WCDMA Band V CH-Middle 1GHz ~ 9GHz

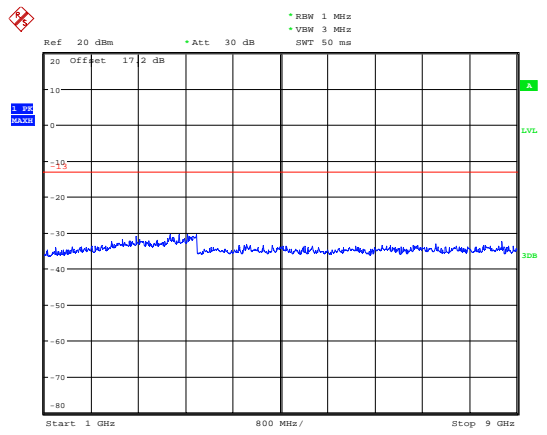

Date: 6.AUG.2019 16:40:43

WCDMA Band V CH-High 30MHz ~ 1GHz

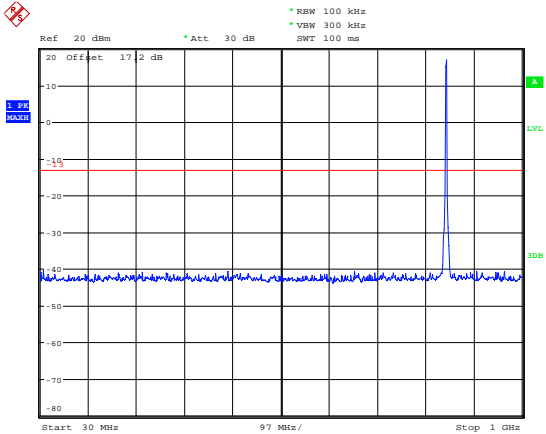

Date: 6.AUG.2019 16:19:26

WCDMA Band V CH-High 1GHz ~ 9GHz

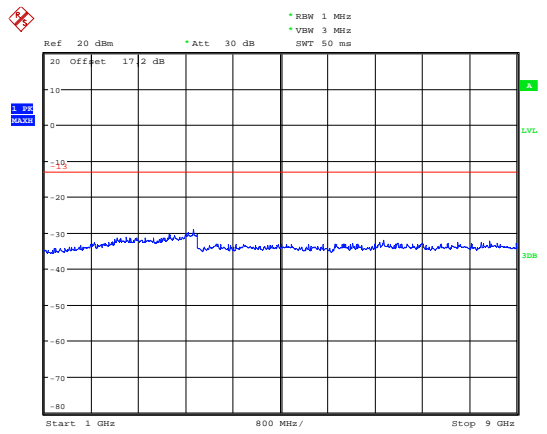

Date: 6.AUG.2019 16:47:40



LTE Band 5 1.4MHz CH-Low 30MHz~1GHz

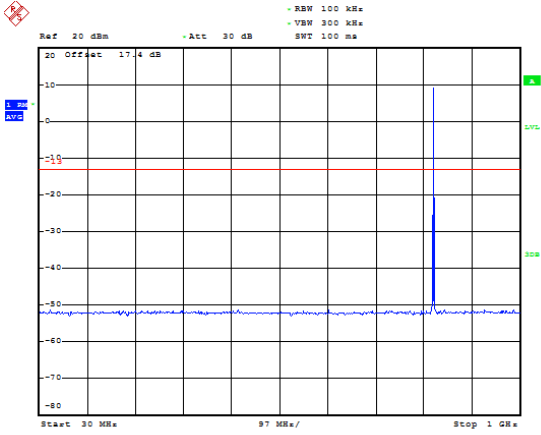

Date: 7.AUG.2019 21:50:59

LTE Band 5 1.4MHz CH-Low 1GHz~9GHz

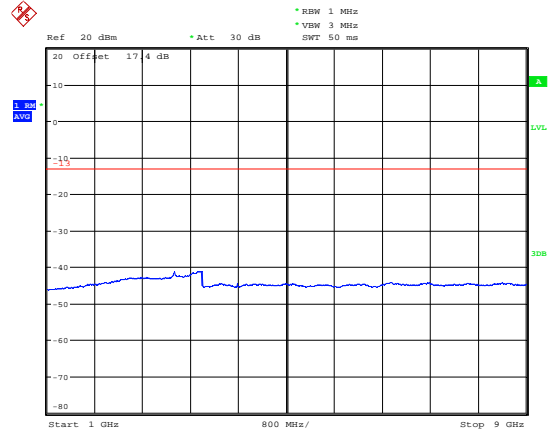

Date: 7.AUG.2019 21:45:35

LTE Band 5 1.4MHz CH-Middle 30MHz~1GHz

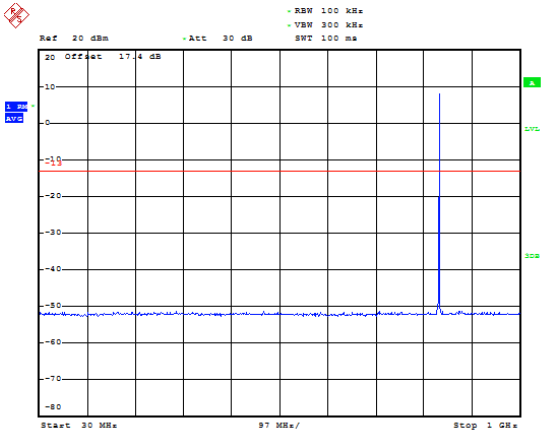

Date: 7.AUG.2019 21:51:29

LTE Band 5 1.4MHz CH-Middle 1GHz~9GHz

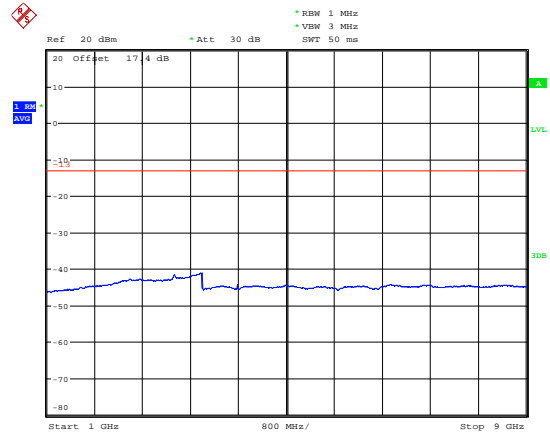

Date: 7.AUG.2019 21:45:51

LTE Band 5 1.4MHz CH-High 30MHz~1GHz

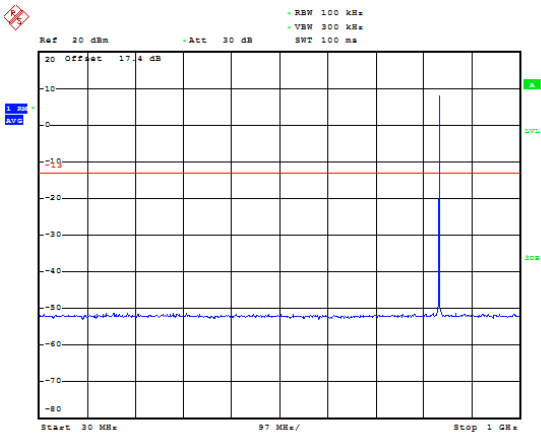

Date: 7.AUG.2019 21:53:15

LTE Band 5 1.4MHz CH-High 1GHz~9GHz

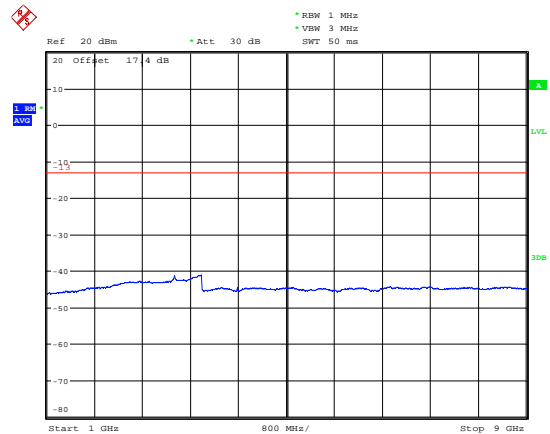

Date: 7.AUG.2019 21:46:12



LTE Band 5 3MHz CH-Low 30MHz~1GHz

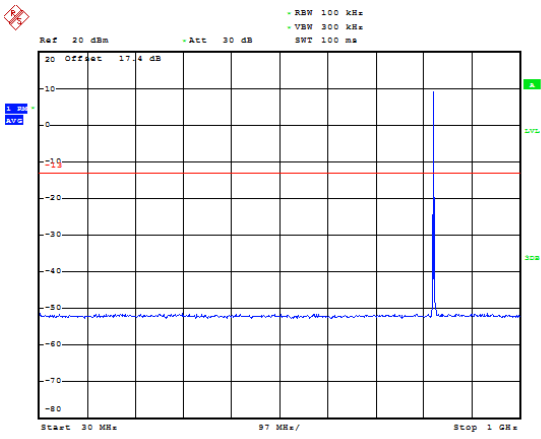

Date: 7.AUG.2019 21:53:57

LTE Band 5 3MHz CH-Low 1GHz~9GHz

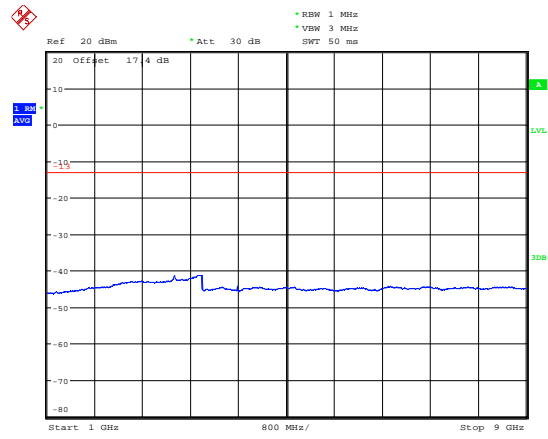

Date: 7.AUG.2019 21:46:38

LTE Band 5 3MHz CH-Middle 30MHz~1GHz

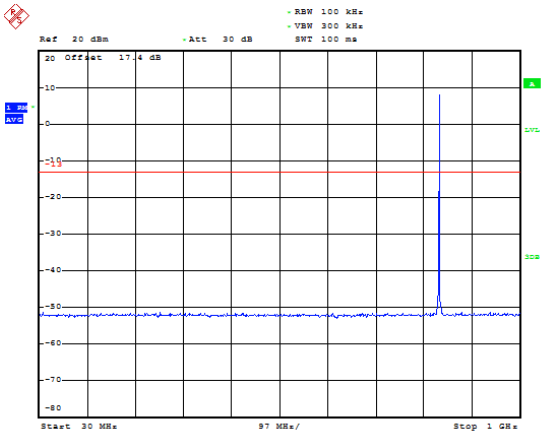

Date: 7.AUG.2019 21:54:52

LTE Band 5 3MHz CH-Middle 1GHz~9GHz

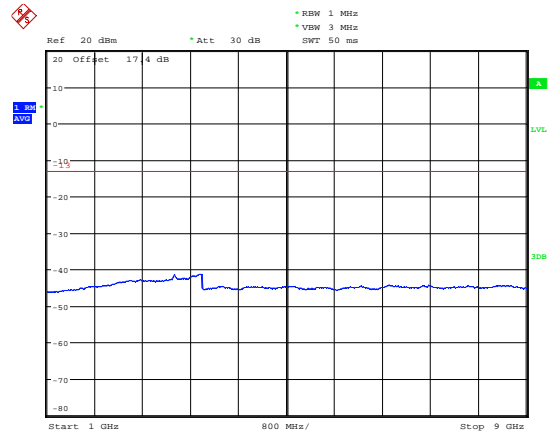

Date: 7.AUG.2019 21:46:57

LTE Band 5 3MHz CH-High 30MHz~1GHz

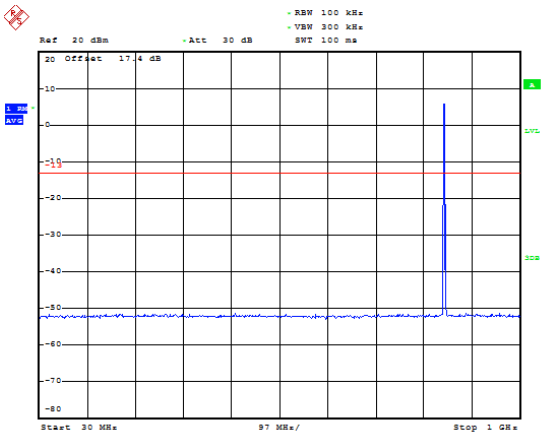

Date: 7.AUG.2019 21:55:09

LTE Band 5 3MHz CH-High 1GHz~9GHz

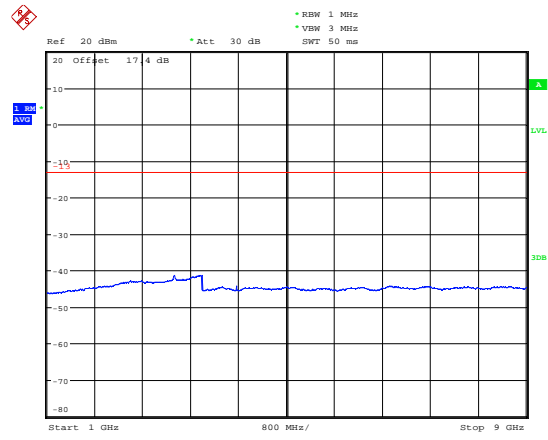

Date: 7.AUG.2019 21:47:25



LTE Band 5 5MHz CH-Low 30MHz~1GHz

LTE Band 5 5MHz CH-Low 1GHz~9GHz

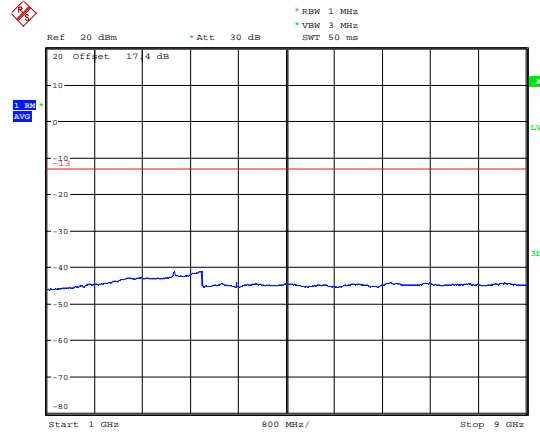
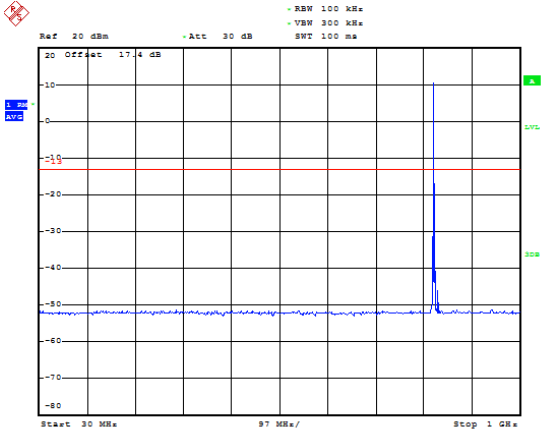

Date: 7.AUG.2019 21:55:50

Date: 7.AUG.2019 21:48:01

LTE Band 5 5MHz CH-Middle 30MHz~1GHz

LTE Band 5 5MHz CH-Middle 1GHz~9GHz

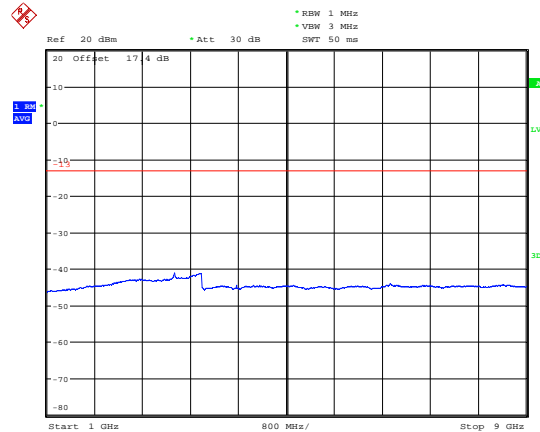
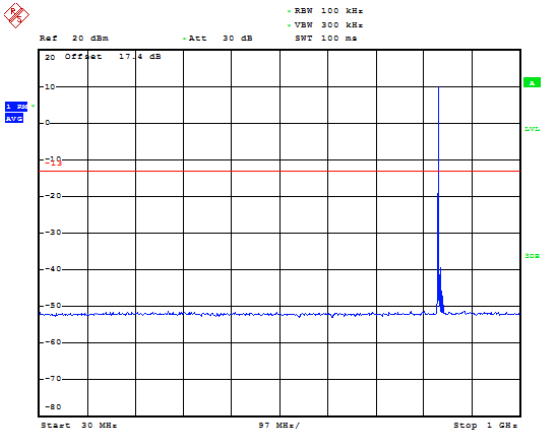

Date: 7.AUG.2019 21:56:10

Date: 7.AUG.2019 21:48:20

LTE Band 5 5MHz CH-High 30MHz~1GHz

LTE Band 5 5MHz CH-High 1GHz~9GHz

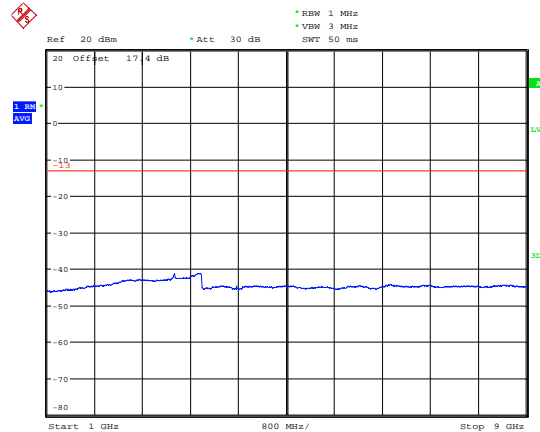
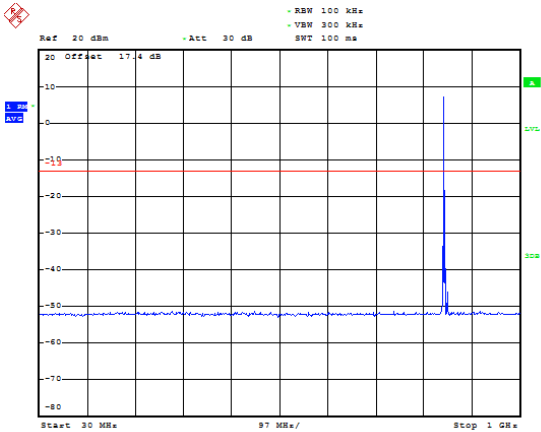

Date: 7.AUG.2019 21:56:24

Date: 7.AUG.2019 21:48:36



LTE Band 5 10MHz CH-Low 30MHz~1GHz

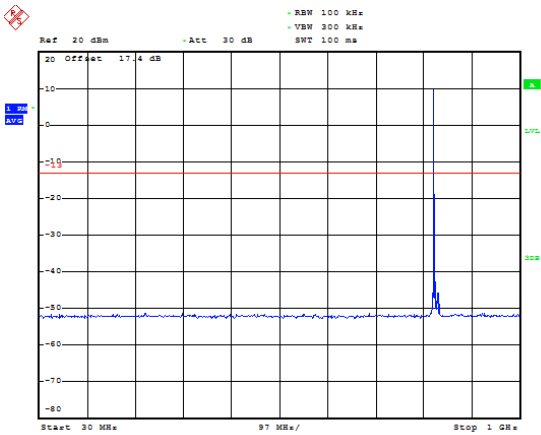

Date: 7.AUG.2019 21:57:06

LTE Band 5 10MHz CH-Low 1GHz~9GHz

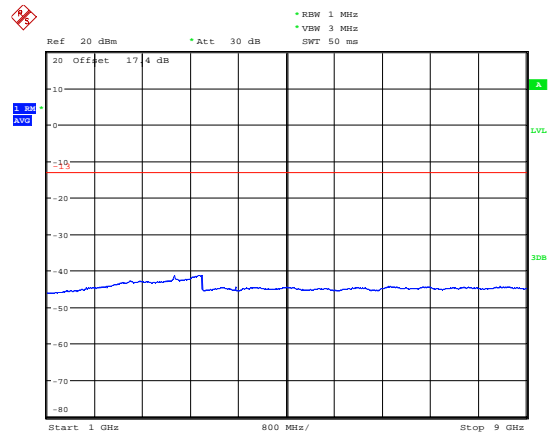

Date: 7.AUG.2019 21:48:53

LTE Band 5 10MHz CH-Middle 30MHz~1GHz

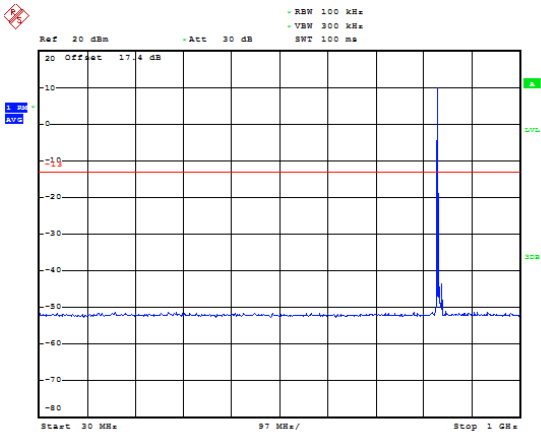

Date: 7.AUG.2019 21:57:29

LTE Band 5 10MHz CH-Middle 1GHz~9GHz

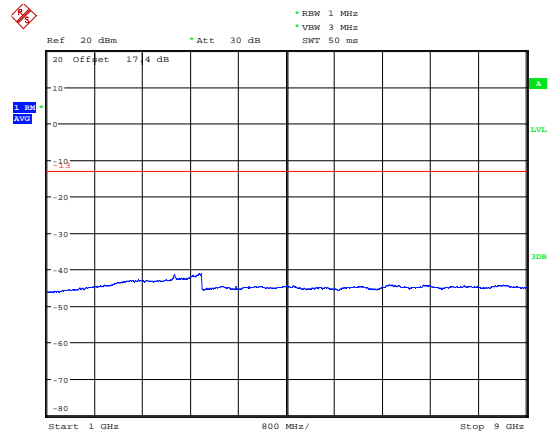

Date: 7.AUG.2019 21:49:15

LTE Band 5 10MHz CH-High 30MHz~1GHz

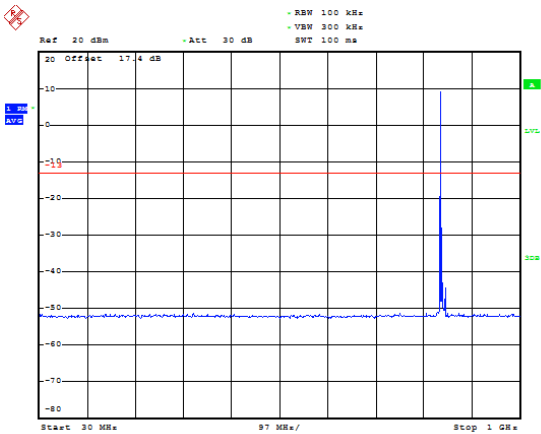

Date: 7.AUG.2019 21:57:56

LTE Band 5 10MHz CH-High 1GHz~9GHz

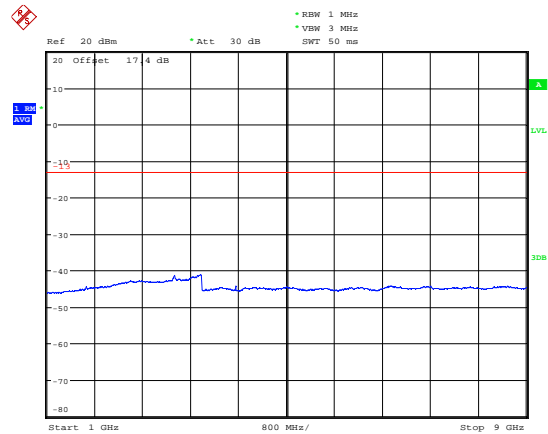

Date: 7.AUG.2019 21:49:35

5.8. Radiates Spurious Emission

Ambient condition

Temperature	Relative humidity	Pressure
23°C ~25°C	45%~50%	101.5kPa

Method of Measurement

1. The testing follows FCC KDB 971168 v03r01 Section 5.8 and ANSI C63.26 (2015).
2. Below 1GHz: The EUT is placed on a turntable 0.8 meters above the ground in the chamber, 3 meter away from the antenna. The maximal emission value is acquired by adjusting the antenna height, polarisation and turntable azimuth. Normally, the height range of antenna is 1 m to 4 m, the azimuth range of turntable is 0° to 360°, and the receive antenna has two polarizations Vertical (V) and Horizontal (H). Above 1GHz: (Note: the FCC's permission to use 1.5m as an alternative per TCBC Conf call of Dec. 2, 2014.) The EUT is placed on a turntable 1.5 meters above the ground in the chamber, 3 meter away from the antenna. The maximal emission value is acquired by adjusting the antenna height, polarisation and turntable azimuth. Normally, the height range of antenna is 1 m to 4 m, the azimuth range of turntable is 0° to 360°, and the receive antenna has two polarizations Vertical (V) and Horizontal (H).
3. A loop antenna, A log-periodic antenna or horn antenna shall be substituted in place of the EUT. The log-periodic antenna will be driven by a signal generator and the level will be adjusted till the same power value on the spectrum analyzer or receiver. The level of the spurious emissions can be calculated through the level of the signal generator, cable loss, the gain of the substitution antenna and the reading of the spectrum analyzer or receiver.
4. The EUT is then put into continuously transmitting mode at its maximum power level during the test. Set Test Receiver or Spectrum RBW=200Hz,VBW=600Hz for 9kHz150kHz , RBW=10kHz, VBW=30kHz 150kHz-30MHz , RBW=100kHz,VBW=300kHz for 30MHz to 1GHz and RBW=1MHz, VBW=3MHz for above 1GHz, And the maximum value of the receiver should be recorded as (Pr).
5. The EUT shall be replaced by a substitution antenna. In the chamber, an substitution antenna for the frequency band of interest is placed at the reference point of the chamber. An RF Signal source for the frequency band of interest is connected to the substitution antenna with a cable that has been constructed to not interfere with the radiation pattern of the antenna. A power (PMea) is applied to the input of the substitution antenna, and adjust the level of the signal generator output until the value of the receiver reach the previously recorded (Pr). The power of signal source (PMea) is recorded. The test should be performed by rotating the test item and adjusting the receiving antenna polarization.
6. A amplifier should be connected to the Signal Source output port. And the cable should be connect between the Amplifier and the Substitution Antenna. The cable loss (Pcl) ,the Substitution Antenna Gain (Ga) and the Amplifier Gain (PAg) should be recorded after test.
7. The measurement results are obtained as described below:
Power(EIRP)=PMea- PAg - Pcl + Ga
The measurement results are amend as described below:
Power(EIRP)=PMea- Pcl + Ga
8. This value is EIRP since the measurement is calibrated using an antenna of known gain (2.15 dBi)

and known input power. ERP can be calculated from EIRP by subtracting the gain of the dipole, $ERP = EIRP - 2.15\text{dBi}$.

The modulation mode and RB allocation refer to section 5.1, using the maximum output power configuration.

Test setup

9KHz ~ 30MHz

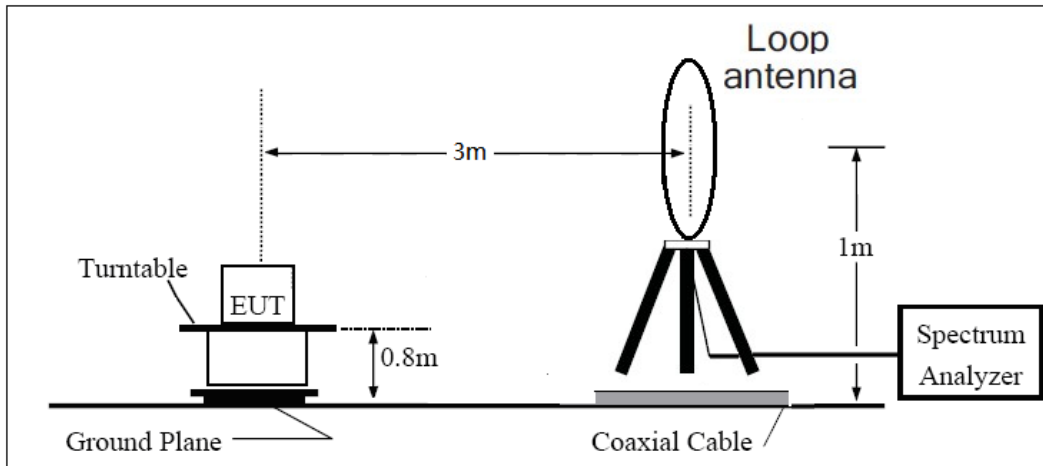

30MHz ~ 1GHz

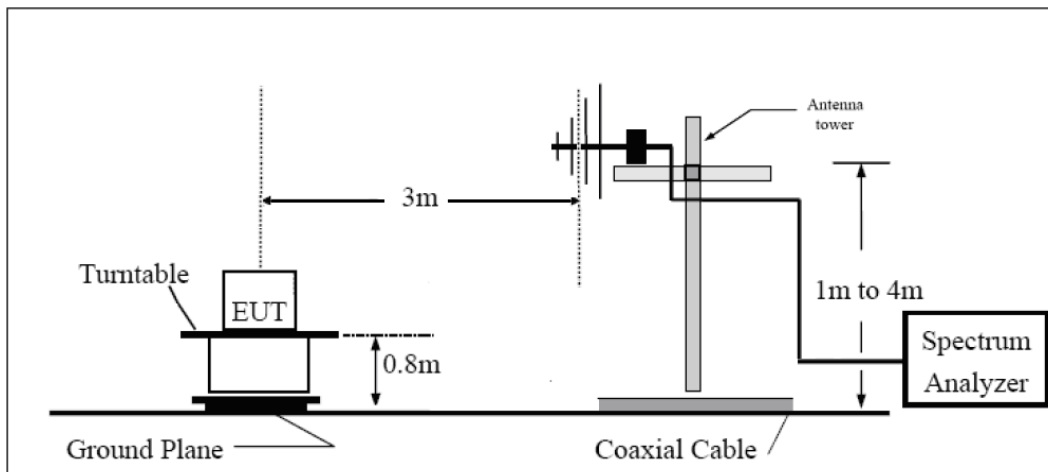

Above 1GHz

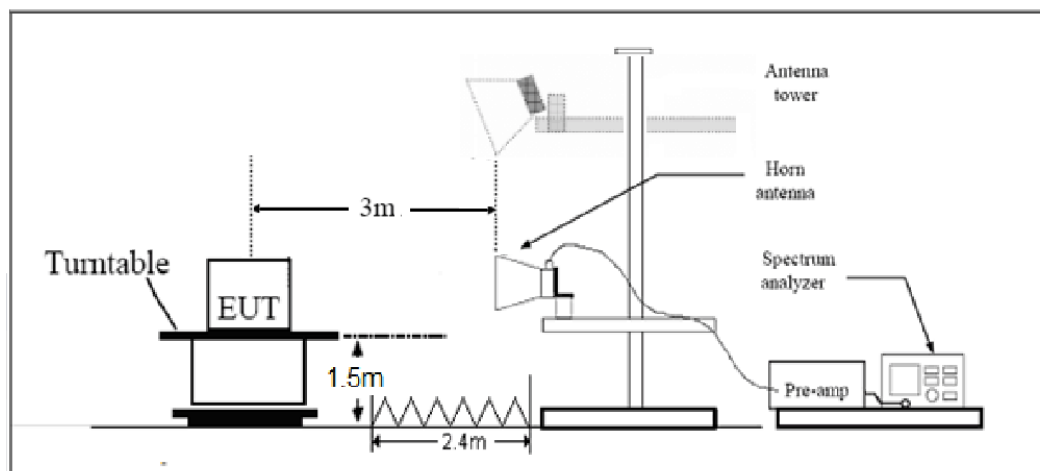



Note: Area side:2.4mX3.6m

Limits

Rule Part 22.917(a) specifies that “The power of any emission outside of the authorized operating frequency ranges must be attenuated below the transmitting power (P) by a factor of at least $43 + 10 \log (P)$ dB.”

Limit	-13 dBm
-------	---------

Measurement Uncertainty

The assessed measurement uncertainty to ensure 95% confidence level for the normal distribution is with the coverage factor $k = 1.96$, $U = 3.55$ dB.

**Test Result**

Sweep the whole frequency band through the range from 9kHz to the 10th harmonic of the carrier, the emissions below the noise floor will not be recorded in the report.

GSM 850 CH-Middle

Harmonic	Frequency (MHz)	SG (dBm)	Cable Loss (dB)	Gain (dBi)	Antenna Polarization	ERP Level (dBm)	Limit (dBm)	Margin (dB)	Azimuth (deg)
2	1673.25	-54.13	2.00	10.75	Horizontal	-47.53	-13.00	34.53	135
3	2509.80	-43.39	2.51	11.05	Horizontal	-37.00	-13.00	24.00	225
4	3346.40	-64.00	4.20	11.15	Horizontal	-59.20	-13.00	46.20	90
5	4183.00	-61.30	5.20	11.15	Horizontal	-57.50	-13.00	44.50	270
6	5019.60	-59.70	5.50	11.95	Horizontal	-55.40	-13.00	42.40	135
7	5856.20	-61.20	5.70	13.55	Horizontal	-55.50	-13.00	42.50	225
8	6692.80	-58.90	6.30	13.75	Horizontal	-53.60	-13.00	40.60	315
9	7529.40	-56.50	6.80	13.85	Horizontal	-51.60	-13.00	38.60	0
10	8366.00	-55.40	6.90	14.25	Horizontal	-50.20	-13.00	37.20	45

Note: 1.The other Spurious RF Radiated emissions level is no more than noise floor.

2.The worst emission was found in the antenna is Horizontal position.

WCDMA Band V CH-Middle

Harmonic	Frequency (MHz)	SG (dBm)	Cable Loss (dB)	Gain (dBi)	Antenna Polarization	ERP Level (dBm)	Limit (dBm)	Margin (dB)	Azimuth (deg)
2	1673.20	-69.82	2.00	10.75	Horizontal	-63.22	-13.00	50.22	45
3	2509.80	-60.01	2.51	11.05	Horizontal	-53.62	-13.00	40.62	90
4	3346.40	-62.93	4.20	11.15	Horizontal	-58.13	-13.00	45.13	90
5	4183.00	-57.69	5.20	11.15	Horizontal	-53.89	-13.00	40.89	315
6	5019.60	-59.70	5.50	11.95	Horizontal	-55.40	-13.00	42.40	270
7	5856.20	-61.81	5.70	13.55	Horizontal	-56.11	-13.00	43.11	0
8	6692.80	-57.43	6.30	13.75	Horizontal	-52.13	-13.00	39.13	45
9	7529.40	-55.60	6.80	13.85	Horizontal	-50.70	-13.00	37.70	0
10	8366.00	-	-	-	-	-	-	-	-

Note: 1.The other Spurious RF Radiated emissions level is no more than noise floor.

2.The worst emission was found in the antenna is Horizontal position.



LTE Band 5 1.4MHz CH-Middle

Harmonic	Frequency (MHz)	SG (dBm)	Cable Loss (dB)	Gain (dBi)	Antenna Polarization	ERP Level (dBm)	Limit (dBm)	Margin (dB)	Azimuth (deg)
2	1673.00	-57.72	2.00	10.75	Horizontal	-51.12	-13.00	38.12	315
3	2509.50	-46.53	2.51	11.05	Horizontal	-40.14	-13.00	27.14	45
4	3346.00	-58.10	4.20	11.15	Horizontal	-53.30	-13.00	40.30	135
5	4182.50	-47.00	5.20	11.15	Horizontal	-43.20	-13.00	30.20	90
6	5019.00	-57.77	5.50	11.95	Horizontal	-53.47	-13.00	40.47	315
7	5855.50	-60.16	5.70	13.55	Horizontal	-54.46	-13.00	41.46	270
8	6692.00	-57.96	6.30	13.75	Horizontal	-52.66	-13.00	39.66	180
9	7528.50	-56.05	6.80	13.85	Horizontal	-51.15	-13.00	38.15	135
10	8365.00	-55.07	6.90	14.25	Horizontal	-49.87	-13.00	36.87	90

Note: 1.The other Spurious RF Radiated emissions level is no more than noise floor.

2.The worst emission was found in the antenna is Horizontal position.

LTE Band 5 5MHz CH-Middle

Harmonic	Frequency (MHz)	SG (dBm)	Cable Loss (dB)	Gain (dBi)	Antenna Polarization	ERP Level (dBm)	Limit (dBm)	Margin (dB)	Azimuth (deg)
2	1673.00	-58.41	2.00	10.75	Horizontal	-51.81	-13.00	38.81	135
3	2509.50	-46.72	2.51	11.05	Horizontal	-40.33	-13.00	27.33	45
4	3466.20	-59.33	4.20	11.15	Horizontal	-54.53	-13.00	41.53	270
5	4215.90	-47.15	5.20	11.15	Horizontal	-43.35	-13.00	30.35	225
6	5165.60	-58.60	5.50	11.95	Horizontal	-54.30	-13.00	41.30	315
7	5815.30	-60.00	5.70	13.55	Horizontal	-54.30	-13.00	41.30	135
8	6765.00	-57.50	6.30	13.75	Horizontal	-52.20	-13.00	39.20	45
9	7614.70	-55.20	6.80	13.85	Horizontal	-50.30	-13.00	37.30	180
10	8464.40	-56.30	6.90	14.25	Horizontal	-51.10	-13.00	38.10	90

Note: 1.The other Spurious RF Radiated emissions level is no more than noise floor.

2.The worst emission was found in the antenna is Horizontal position.



LTE Band 5 10MHz CH-Middle

Harmonic	Frequency (MHz)	SG (dBm)	Cable Loss (dB)	Gain (dBi)	Antenna Polarization	ERP Level (dBm)	Limit (dBm)	Margin (dB)	Azimuth (deg)
2	1673.00	-58.85	2.00	10.75	Horizontal	-52.25	-13.00	39.25	270
3	2509.50	-46.31	2.51	11.05	Horizontal	-39.92	-13.00	26.92	45
4	3346.00	-59.25	4.20	11.15	Horizontal	-54.45	-13.00	41.45	45
5	4182.50	-47.30	5.20	11.15	Horizontal	-43.50	-13.00	30.50	225
6	5019.00	-58.10	5.50	11.95	Horizontal	-53.80	-13.00	40.80	180
7	5855.50	-60.70	5.70	13.55	Horizontal	-55.00	-13.00	42.00	90
8	6692.00	-58.00	6.30	13.75	Horizontal	-52.70	-13.00	39.70	0
9	7528.50	-54.80	6.80	13.85	Horizontal	-49.90	-13.00	36.90	135
10	8365.00	-55.40	6.90	14.25	Horizontal	-50.20	-13.00	37.20	45

Note: 1.The other Spurious RF Radiated emissions level is no more than noise floor.

2.The worst emission was found in the antenna is Horizontal position.

6. Main Test Instruments

Name	Manufacturer	Type	Serial Number	Calibration Date	Expiration Date
Base Station Simulator	R&S	CMW500	113824	2019-05-19	2020-05-18
Power Splitter	Hua Xiang	SHX-GF2-2-13	10120101	/	/
Spectrum Analyzer	Key sight	N9010A	MY50210259	2019-05-19	2020-05-18
Universal Radio Communication Tester	Key sight	E5515C	MY48367192	2019-05-19	2020-05-18
Signal Analyzer	R&S	FSV30	100815	2018-12-16	2019-12-15
Loop Antenna	SCHWARZBECK	FMZB1519	1519-047	2017-09-26	2019-09-25
Trilog Antenna	SCHWARZBECK	VUBL 9163	9163-201	2017-11-18	2019-11-17
Horn Antenna	R&S	HF907	100126	2018-07-07	2020-07-06
Horn Antenna	ETS-Lindgren	3160-09	00102643	2018-06-20	2020-06-19
Signal generator	R&S	SMB 100A	102594	2019-05-19	2020-05-18
Climatic Chamber	ESPEC	SU-242	93000506	2017-12-17	2020-12-16
Preamplifier	R&S	SCU18	102327	2019-05-19	2020-05-18
MOB COMMS DC SUPPLY	Keysight	66319D	MY43004105	2019-05-20	2020-05-21
RF Cable	Agilent	SMA 15cm	0001	2019-06-14	2019-09-13
Software	R&S	EMC32	9.26.0	/	/

*****END OF REPORT *****